



GOETZE®



Piston rings
Kolbenringe
Segments de piston
Segmentos de pistón
Pierścienie tłokowe
Поршневые кольца
حلقات الكباس

CATGT1401



2015-2016

ENGINE EXPERTISE BY  **FEDERAL-MOGUL**
MOTORPARTS



 GLYCO

 GOETZE

Niral

 Payen

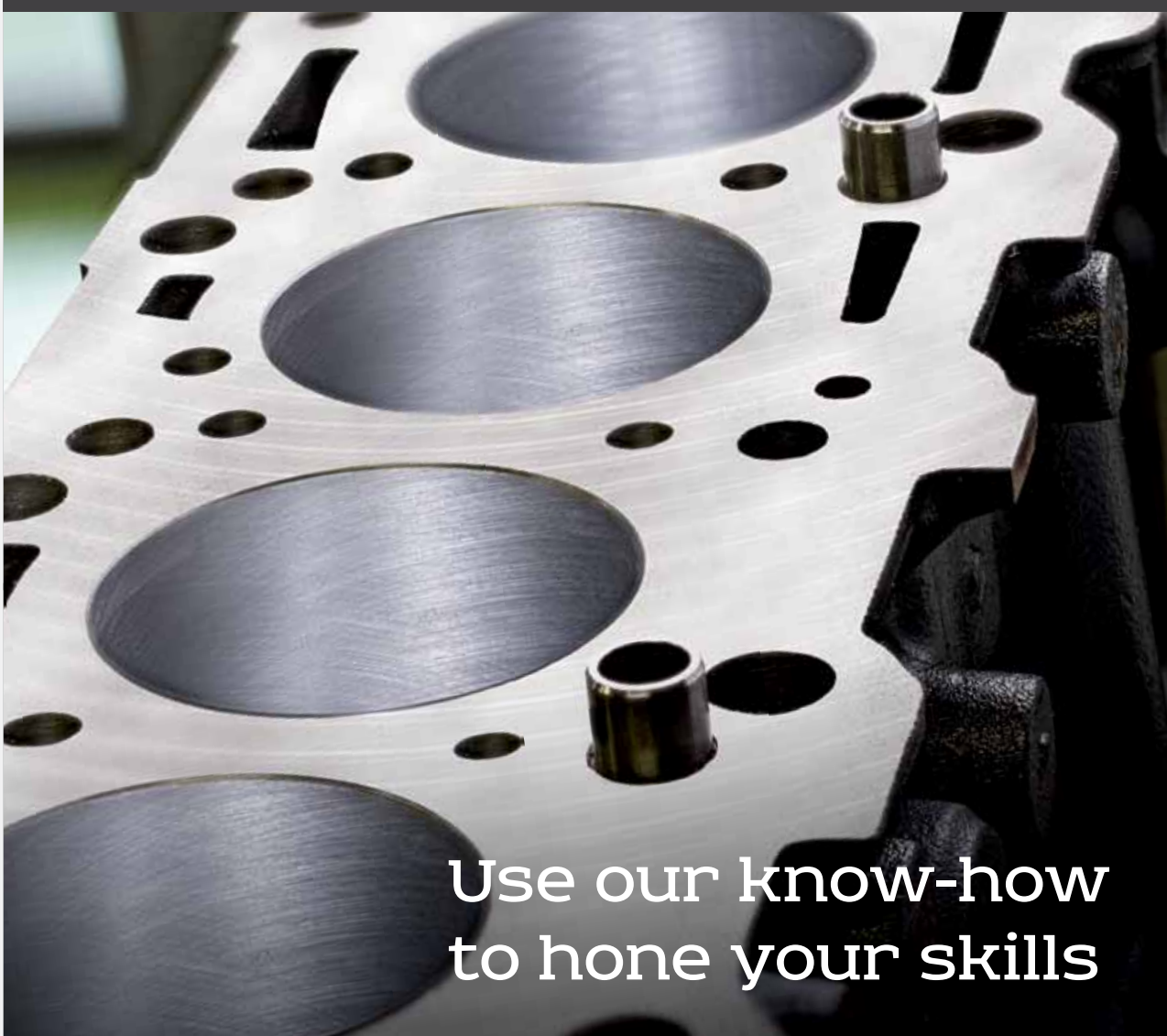

Use our know-how to hone your skills

With each diagnosis, each revision, your engine expertise becomes richer. Your skills get broader and deeper. And it's just the same at Federal-Mogul. That's why people rely on you. For example, your eye for detail and your feel for precise cylinder liner honing guarantee optimum engine performance. Your expertise helps us understand which parts you need, and how we can give you even more support to make it easier for you to achieve perfection with each engine job.

Because our engine expertise... is based on yours.



ENGINE EXPERTISE
BY  **FEDERAL-MOGUL**
MOTORPARTS



 **GLYCO**

 **GOETZE**

Nirral

 **Payen**

CONTENTS

EN

Contents	I
Manufacturers list	III
How to use this catalogue	IV
Piston rings function & requirements	VI
Piston rings fitting instructions	VII
Terms of business	XXXII
New parts list	XXXIV
Applications by manufacturer	1
Numerical parts list	1266
Cylinder bore → Goetze part number	1284
Interchange AE → Goetze	1310
Nüral pistons fitted with Goetze ring sets	1314

DE

Inhalt	I
Herstellerliste	III
Hinweise zur Benutzung des Katalogs	VIII
Funktion und Eigenschaften von Kolbenringen	X
Montageanleitungen für Kolbenringe	XI
Verkaufsbedingungen	XXXII
Neuaufnahmen	XXXIV
Anwendungen, geordnet nach Hersteller	1
Numerische Teilleiste	1266
Zylinderbohrung → Goetze Artikel-Nr.	1284
Vergleichsliste AE → Goetze	1310
Nüral Kolben ausgestattet mit Goetze Kolbenringsätzen	1314

FR

Sommaire	I
Index par constructeur	III
Comment utiliser ce catalogue	XII
Fonctions et besoins des segments de piston	XIV
Instructions pour le montage des segments de piston	XV
Conditions générales de vente	XXXII
Liste des nouvelles références	XXXIV
Applications par constructeur	1
Liste des références classées par ordre alphanumérique	1266
Alésage de cylindre → référence Goetze	1284
Références croisées AE → Goetze	1310
Pistons Nüral équipés de jeux de segments Goetze	1314

ES

Índice	I
Aplicaciones por fabricante	III
Cómo usar este catálogo	XVI
Función y requisitos de los segmentos de pistón	XVIII
Instrucciones de montaje de los segmentos de pistón	XIX
Términos y condiciones de venta	XXXII
Lista de referencias nuevas	XXXIV
Aplicaciones por fabricante	1
Lista de referencias numéricas	1266
Diámetro del cilindro → Referencia Goetze	1284
Intercambio entre AE y Goetze	1310
Pistones Nüral equipados con conjuntos de segmentos Goetze	1314

PL

Zawartość	I
Zastosowania w kolejności producentów	III
Jak korzystać z tego katalogu	XX
Pierścienie tłokowe - funkcja i wymagania	XXII
Pierścienie tłokowe - instrukcje montażowe	XXIII
Warunki i wymagania sprzedaży	XXXIII
Lista nowych części	XXXIV
Zastosowania w kolejności producentów	1
Numeryczna lista części	1266
Średnica cylindra → numer części Goetze	1284
Lista zamienników z numerów AE na Goetze	1310
Tłoki Nüral z zamontowanymi zestawami pierścieni Goetze	1314

RU

Содержание	I
Модели автомобилей, сортировка по производителю	III
Как пользоваться каталогом	XXIV
Функции поршневых колец и требования к ним	XXVI
Указания по установке поршневых колец	XXVII
Условия сотрудничества	XXXIII
Список новой продукции	XXXIV
Модели автомобилей, сортировка по производителю	1
Список номеров деталей	1266
Диаметр цилиндра → номер детали по каталогу Goetze	1284
Взаимозаменяемость AE → Goetze	1310
Поршни Nüral, оснащаемые кольцами Goetze	1314

AR

المحتويات	I
التطبيقات حسب جهة التصنيع	III
كيفية استخدام هذا الكatalog	XXVIII
وظيفة ومتطلبات حلقات الكباس	XXX
إرشادات تركيب حلقات الكباس	XXXI
بنود وشروط المبيعات	XXXIII
قائمة القطع الجديدة	XXXIV
التطبيقات حسب جهة التصنيع	1
قائمة القطع المرقمة	1266
قطر الأسطوانة - رقم قطعة Goetze	1284
تدويل AE -> Goetze	1310
يتم تركيب كباسات Nural باستخدام مجموعات حلقات Goetze	1314

Keep it real. Keep out counterfeit.



The authenticity of all our engine and sealing products is protected by the MAPP Code (Manufacturers Against Product Piracy) and the PrioSpot® Authentication device, featured on a special Anti-Counterfeit label on the packaging. In this way you can be sure of our trusted Federal-Mogul quality!

How to check the authenticity of your products

1 - Check if the packaging is closed and the label is intact

2 - Verify the unique alphanumeric code and data matrix code

- Type in the alphanumeric code at www.fmecat.eu
- or
- Read the Data Matrix Code with a 2-D scanner
- or
- Read the Data Matrix Code on your smartphone with a barcode reader app



3 - Verify the unique security code on the PrioSpot® Label

- Different code on each packaging





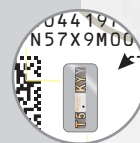

- Code contains the last 4 digits of the alphanumeric code
- The code and the Federal-Mogul logo shimmer in rainbow colours only in direct light
- Only in direct light a digit, repeating the last digit of the security code, is visible. This digit will move up and down when you change the angle of the PrioSpot®



MANUFACTURERS LIST

ALFA ROMEO	1	MAN	506
ARO	30	MARELLI	534
AUDI	33	MAZ	535
AUSTIN MORRIS	92	MAZDA	536
BARKAS	100	MERCEDES-BENZ	543
BARRERAS	101	MERCEDES-BENZ COMMERCIAL	616
BEDFORD	102	MG	645
BELARUS	107	MINI	648
BMW	108	MITSUBISHI	649
BMW MOTORCYCLE	142	MOSKVICH	658
CHRYSLER	145	MWM	659
CITROËN	149	NEW HOLLAND	664
CLAYTON DEWANDRE	190	NISSAN	671
COMPRESSOR	191	NUFFIELD TRACTOR	693
CUMMINS	198	OPEL	694
DACIA	199	PEGASO	747
DAEWOO	204	PERKINS	750
DAF	205	PEUGEOT	763
DAIHATSU	213	PORSCHE	810
DAVID BROWN	216	PROTON	830
DEUTZ / KHD	217	RABA UNGARN	831
FAP-FAMOS	236	RELIANT	832
FIAT	237	RENAULT	833
FORD COMMERCIAL	296	RENAULT TRUCK	926
FORD EUROPE	299	ROVER	938
FORD TRACTOR	377	SAAB	947
GARDNER	381	SAME	953
HINO	382	SCANIA	954
HONDA	383	SEAT	965
HYUNDAI	388	SKODA	997
IFA	394	SMART	1017
IHC	395	SSANGYONG	1020
ISEKI	398	STEYR	1023
ISUZU	401	SUBARU	1026
IVECO	406	SUZUKI	1029
JAGUAR	438	TALBOT	1035
JEEP	443	TOYOTA	1041
JELCZ	446	TRIUMPH CAR	1065
JOHN DEERE	447	TRIUMPH MOTORCYCLE	1066
KIA	448	UAZ	1067
KOMATSU	451	URSUS	1068
KUBOTA	452	UTB	1069
LADA	453	VAUXHALL	1070
LANCIA	458	VM	1110
LAND ROVER	478	VOLGA	1113
LDV	487	VOLKSWAGEN	1114
LEXUS	490	VOLVO	1220
LEYLAND	491	VOLVO COMMERCIAL	1238
LISTER	496	VOLVO-PENTA	1257
LOMBARDINI	499	YANMAR	1258
LOTUS	502	ZASTAVA	1261
LTI	503	ZAZ	1264
MAHINDRA	504	ZETOR	1265
MALKOTSIS	505		

EN - HOW TO USE

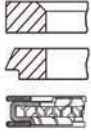
FEDERAL MOGUL		OPEL		
				
1	2	3	4	5
Corsa A Box 1.2 02/86→04/89 12 ST Corsa A Hatchback 1.2 S 09/82→02/90 4cyl. Corsa A TR 1.2 S 09/82→03/93 1196cc 40-43kW (55-58PS) Kadett D 1.2 08/82→08/84		11	TD4722	
4	5	6	7	8
08-306200-00 STD →eng.12ST19136602	77.80	1.750 2.000 4.000		001 IF CR P 026 P 712 CR
				9
				IKA STD ST

- 1** Model information
- 2** Engine information
- 3** Panel No
- 4** Ring set reference and size

- 5** Bore size (nominal)
- 6** Ring widths
- 7** Ring design and profile
- 8** Ring feature and coating
- 9** Material code

PART NUMBERING STRUCTURE **4**

PISTON RINGS

- 08 - 114900 - 00 Catalogue reference
- 08 - 114900 - 00 Reference
- 08 - 114900 - 00 Size (see rings oversize table)
- 08 - 114900 - 00 Version

MATERIAL CODES **9**

Material Code	Description
F12/F14	Carbide Cast Iron
GOE 12	None heat-treated grey Cast Iron
GOE13	Unalloyed, none heat-treated flake Graphite Cast Iron
IKA	Grey Cast Iron
KV1	Ductile Cast Iron
ST	Steel
STD	Cast Iron
KV4	Spheroidal graphite Cast Iron

RINGS OVERSIZE TABLE **4**

Size	Metric	Imperial
00	STD	
03	0.125MM	
04	0.20MM	
05	0.25MM	.010
06	0.40MM	
07	0.50MM	.020
08	0.60MM	
09	0.75MM	.030
10	0.80MM	
11	1.00MM	.040
14	1.50MM	.060
17	2.286MM	.090
20	0.70MM	
21	0.65MM	
22	0.30MM	

PISTON RING CROSS SECTIONS 7

	Cross Section	Description
001		Plain compression ring
005		Tapered Ring
006		Slightly Tapered Ring
007		Wedge type compression ring
008		Keystone type compression ring
009		Taper-faced keystone ring
023		Single hook scraper
026		Tapered single hook scraper
030		Slotted Oil Scraper ring
031		Bevel-edged oil control ring
032		Double bevel-edged oil control ring
036		Slotted Oil Scraper ring
230		Slotted Oil Scraper ring with coil spring
231/241		Bevel-edged oil control ring with coil spring
232		Double bevel-edged oil control ring with coil spring
236		Slotted Oil Scraper with coil spring
712		Steel rail oil control ring with VF spring

RING FEATURE 8

	Cross Section	Description
IF		Inside bevel – top side
IFU		Inside bevel – bottom side
IW		Inside step – top side
IWU		Inside step – bottom side
LKZ		Tapered Ring

COATINGS AND TREATMENT CODES 8

Type and Code	Description	Type and Code	Description
CR	Chromed	P	Phosphated
MO	Molybdenum inlaid	NT	Nitrided
MOL	Molybdenum coated	PS	Plasma spray coated
CK	Chromium-Ceramic coated	GDC	Goetze Diamond Coated
PVD	Chromium Nitride	DLC	Diamond Like Carbon

PISTON RINGS FUNCTION & REQUIREMENTS

The primary function of the piston rings is to provide a seal: to ensure that the heat and pressure generated during the combustion process remain in the combustion chamber and that oil does not pass into the combustion chamber. In addition, the ring must also transfer the heat away from the piston and regulate the lubrication process.

DESIGN OF GOETZE NORMFORM REPLACEMENT PISTON RINGS

GOETZE piston rings are installed as Original Equipment for internal combustion engines and compressors on production lines throughout the world. Continuous collaboration with the design and test departments of virtually every engine and vehicle manufacturer, and development work and tests performed in our own test laboratories, provide a comprehensive knowledge that can be utilized for almost all engines. This know-how and decades of experience with replacement piston rings are the basis of the individual design of every replacement ring set.

The design is fundamentally based on the piston ring materials and running face coatings that have proven themselves in Original Equipment applications.

GENERALLY THE RING PACK CONSISTS OF THREE RINGS:

1. Top Compression ring – often manufactured from steel, ductile iron and cast iron, these rings seal the air / fuel mixture in the combustion chamber.
2. Second Compression ring – generally manufactured from ductile iron and cast iron, these are dual function rings in that they combine the role of a compression ring with that of the oil control ring.
3. Oil Control ring – can be manufactured from ductile iron and cast iron, however, steel is used on multi-piece rings, these regulate the amount of oil required to lubricate the top and second rings.

TRENDS IN PISTON RING TECHNOLOGY

4. Reduction in ring width – due to smaller engines with lighter pistons and shorter compression heights.
5. Reduction in ring weight – for enhanced high RPM and stability.
6. Reduction in ring tension – due to the requirement to reduce frictional losses.
7. Ring metallurgy – the trend is toward high strength alloys such as ductile iron and steel in order to withstand higher temperatures due to leaner fuel mixtures and higher ring placement on the piston for reduced emissions.

RUNNING FACE COATINGS

CHROME PLATING, CR

The electrodeposited hard chrome coating combines excellent wear resistance with high resistance to scuffing. This accounts for the superiority of chromed rings to uncoated rings and surface treated rings.

MOLYBDENUM COATING, MOL, MO

To avoid scuffing the periphery of the ring is coated with Molybdenum, a process that has yielded excellent results. Molybdenum has a very high melting point (2620°C) and good thermal conductivity, factors which account for the high resistance to scuffing and scoring.

PLASMA SPRAY COATING, PS

Plasma spray coatings, which possess high wear, scuff and breakout resistance and high inherent strength, while causing only limited cylinder wear, are today used very successfully in production.

PHOSPHATING, P

The process is employed to speed up and improve bedding-in of the rings. The surface of the ring is transformed by chemical treatment to phosphate crystals.

NITRIDING, NT

Surface treatment by Nitriding to reduce wear of steel compression rings and steel rails in oil control rings.

CHROMIUM-CERAMIC COATING, CK

The CK coating withstands higher thermal and mechanical loading than existing chromium, molybdenum and plasma coatings, though these tried and tested coatings lose none of their significance.

GOETZE DIAMOND-REINFORCED RING COATING, GDC

Ultra-fine diamonds with material specific, hybrid properties and nanometer dimensions, are embedded into the hard chromium running surface. The GDC ring running surface has lower ring wear rates and a considerably higher scuff resistance when compared to other coatings.

PISTON RING FITTING INSTRUCTIONS - EN

PISTON RING FITTING INSTRUCTIONS

Prior to fitting Goetze replacement piston rings, the piston ring grooves must be cleaned taking special care not to damage the groove root radius or side walls. The maximum axial clearance for gasoline engines is 0.13mm and for diesel pistons is 0.20mm. Pistons with defective ring grooves or excessive axial wear should always be replaced by Nüral replacement pistons.

COMPRESSION RINGS

Piston rings should be installed using piston ring pliers taking care not to stretch open the ring more than necessary. Excessive stretching can damage the ring, cause deformation and possibly lead to breakage during operation.

During assembly special attention must be made to the TOP marking which should always face towards the piston crown. All Goetze compression rings will have the manufacturers mark "GOE" and we recommend that all rings, including those without TOP marking are fitted with marked side facing the piston crown.

GOETZE VF 3-PIECE OIL RINGS

Only the Goetze VF 3-piece oil control rings are not marked as all three elements can be installed without orientation.

Fit the expander to the groove first taking care that the joint is not positioned over slots or holes in the base of the ring groove.

While holding the ends of the expander together, the top steel rail should be wound into the groove starting at about 45°- 90° to the left of the expander joint working in the direction of the joint.

The bottom rail should be fitted at 45°- 90° to the right of the joint working in the direction of the joint.

To ensure the rings bed-in properly after engine re-conditioning, we recommend running the engine for about 500 to 1000 km and then changing the oil.





CHECKING FITMENT OF RINGS

After the rings have been installed on the piston check that they are free to rotate within the ring grooves. The rings should then be positioned with the ring gaps at intervals of 120°.

NB. Chromium plated rings should not be fitted to cylinders with Chromium plated bores.

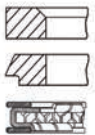

DE - HINWEISE ZUR BENUTZUNG

FEDERAL MOGUL		OPEL		
				
1			2	3
Corsa A Box 1.2 Corsa A Hatchback 1.2 S Corsa A TR 1.2 S Kadett D 1.2		02/86→04/89 09/82→02/90 09/82→03/93 08/82→08/84	12 ST	4cyl. 1196cc 40-43kW (55-58PS)
				11 TD4722
4	5	6	7	8
08-306200-00 STD →eng.12ST19136602	77.80	1.750 2.000 4.000		001 IF CR P 026 P 712 CR
				IKA STD ST

- 1** Modellangaben
- 2** Motorangaben
- 3** Tafel Nr.
- 4** Kolbenringsatz-Nummer und -Größe
- 5** Bohrungsgröße (Nennwert)
- 6** Kolbenringbreiten
- 7** Kolbenringkonstruktion und -profil
- 8** Kolbenringausführung und -beschichtung
- 9** Materialcode

KOLBENRINGSATZ-NUMMER UND -GRÖSSE **4**

KOLBENRINGE

- 08 - 114900 - 00 Katalognummer
- 08 - 114900 - 00 Bezeichnung
- 08 - 114900 - 00 Größe (siehe Übergrößentabelle)
- 08 - 114900 - 00 Version

KOLBENRING-ÜBERGRÖSSENTABELLE **4**













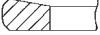
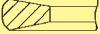

Größe	Metrisch	Imperial
00	STD	
03	0.125MM	
04	0.20MM	
05	0.25MM	.010
06	0.40MM	
07	0.50MM	.020
08	0.60MM	
09	0.75MM	.030
10	0.80MM	
11	1.00MM	.040
14	1.50MM	.060
17	2.286MM	.090
20	0.70MM	
21	0.65MM	
22	0.30MM	

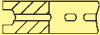
MATERIALCODE **9**

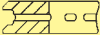



Materialcode	Beschreibung
F12/F14	Karbidischer Hartguss
GOE 12	Nicht wärmebehandelter Grauguss
GOE13	Unlegierter, nicht wärmebehandelter Lamellengraphit
IKA	Grauguss
KV1	Duktiler Guss
ST	Stahl
STD	Gusseisen
KV4	Kugelgraphitguss

HINWEISE ZUR BENUTZUNG - DE

KOLBENRING-QUERSCHNITTE 7

	Querschnitt	Beschreibung
001		Rechteckring
005		Minutenring (mit konischer Lauffläche)
006		Minutenring (mit leicht konischer Lauffläche)
007		Einseitiger Trapezring
008		Doppeltrapezring
009		Trapezring mit konischer Lauffläche
023		Einfacher Nasenring
026		Nasenminutenring (mit konischer Lauffläche)
030		Ölschlitzring
031		Dachfasenring
032		Gleichfasenring
036		Ölschlitzring
230		Ölschlitzring mit Schlauchfeder
231/241		Dachfasenring mit Schlauchfeder
232		Gleichfasenring mit Schlauchfeder
236		Ölschlitzring mit Schlauchfeder
712		Stahllamellen-Ölabstreiferling mit VF-Feder

RINGAUSFÜHRUNG 8

	Querschnitt	Beschreibung
IF		IF Innenfase – oben
IFU		IFU Innenfase – unten
IW		IW Innenwinkel – oben
IWU		IWU Innenwinkel – unten
LKZ		Minutenring (mit konischer Lauffläche)

BESCHICHTUNGS- UND BEHANDLUNGS-CODES 8

Typ und Code	Beschreibung	Typ und Code	Beschreibung
CR	Verchromt	P	Phosphatiert
MO	mit Molybdän	NT	Nitriert
MOL	Molybdänbeschichtet	PS	Plasma-spritzbeschichtet
CK	Chrom-Keramik-beschichtet	GDC	Goetze-Diamant-beschichtet
PVD	Chromnitrid	DLC	Diamantähnlicher Kohlenstoff

FUNKTION UND ERFORDERNISSE VON KOLBENRINGEN

Die primäre Funktion von Kolbenringen ist die Abdichtung: Sie sorgen dafür, dass die im Verbrennungsprozess erzeugte Wärme und der Druck in Verbrennungsraum verbleiben und kein Öl in den Verbrennungsraum eintritt. Der Kolbenring hat außerdem die Aufgabe, die Wärme vom Kolben abzuleiten und den Schmiervorgang zu regeln.

KONSTRUKTION DER GOETZE NORMFORM AUSTAUSCHKOLBENRINGE

Die GOETZE Kolbenringe werden weltweit als OE für Verbrennungsmotoren und Kompressoren in Fertigungsstraßen installiert.

Durch kontinuierliche Zusammenarbeit mit den Konstruktions- und Testabteilungen nahezu aller Motor- und Fahrzeughersteller sowie Entwicklungsarbeiten und Tests in unseren eigenen Prüflaboren verfügen wir über umfangreiches Wissen, das für fast alle Motoren genutzt werden kann. Dieses Know-how und jahrzehntelange Erfahrung mit Austauschkolbenringen bilden die Basis der individuellen Konstruktion jedes Austauschringsatzes.

Die Konstruktion basiert grundsätzlich auf Kolbenringmaterialien und Laufflächenbeschichtungen, die sich in OE-Anwendungen bewährt haben.

EINE RINGPACKUNG BESTEHT GRUNDSÄTZLICH AUS DREI RINGEN:

1. Oberer Verdichtungsring – diese Ringe, die häufig aus Stahl, duktilem Eisen und Gusseisen gefertigt sind, dichten die Luft-/Kraftstoffmischung im Verbrennungsraum ab.
2. Zweiter Verdichtungsring – diese Ringe sind generell aus duktilem Eisen und Gusseisen gefertigt und haben eine Doppelfunktion: Sie kombinieren die Aufgabe eines Verdichtungsringes mit dem eines Ölabbstreifings.
3. Ölabbstreifring – kann aus duktilem Eisen und Gusseisen gefertigt sein, bei mehrteiligen Ringen wird jedoch Stahl verwendet. Diese regulieren die zur Schmierung des oberen und zweiten Rings nötige Ölmenge.

TRENDS IN DER KOLBENRINGTECHNOLOGIE

4. Reduzierte Ringbreite – aufgrund kleinerer Motoren mit leichteren Kolben und kürzeren Verdichtungshöhen.
5. Reduziertes Ringgewicht – für bessere Leistung bei hoher Drehzahl und mehr Stabilität
6. Reduzierte Ringspannung – aufgrund der erforderlichen Reduzierung von Reibungsverlusten.
7. Ringmetallurgie – der Trend geht hin zu hochfesten Legierungen wie z.B. duktilem Eisen und Stahl, um höheren Temperaturen standzuhalten, die dank magerer Kraftstoffmischungen und höherer Positionierung auf dem Kolben zur Abgasreduzierung vorhanden sind.

LAUFFLÄCHEN-BESCHICHTUNGEN

VERCHROMEN, CR

Die galvanische Hartchrombeschichtung kombiniert ausgezeichnete Verschleißfestigkeit mit hoher Reibfestigkeit. Das macht verchromte Ringe den unbeschichteten Ringen und oberflächenbehandelten Ringen überlegen.

MOLYBDÄNBESCHICHTUNG, MOL, MO

Um Abrieb zu verhindern, ist die Peripherie des Ringes mit Molybdän beschichtet: Ein Verfahren, mit dem ausgezeichnete Ergebnisse erzielt werden. Molybdän hat einen sehr hohen Schmelzpunkt (2620°C) und gute Wärmeleitfähigkeit, beides Faktoren die zur hohen Reib- und Kerbfestigkeit beitragen.

PLASMA-SPRITZBESCHICHTUNG, PS

Plasma-Spritzbeschichtungen weisen hohe Verschleiß-, Reib- und Ausbruchfestigkeit sowie hohe Eigenfestigkeit auf, verursachen nur eingeschränkten Zylinderverschleiß und werden heute mit großem Erfolg in der Produktion eingesetzt.

PHOSPHATIEREN, P

Mit diesem Verfahren wird der Einlauf der Ringe beschleunigt und verbessert. Die Ringoberfläche wird dabei durch chemische Behandlung in Phosphatkristalle umgewandelt.

NITRIEREN, NT

Eine Oberflächenbehandlung durch Nitrieren reduziert den Verschleiß von Stahlverdichtungsringen und Stahlrails in Ölabbstreifungen.

CHROM-KERAMIK-BESCHICHTUNG, CK

Die CK-Beschichtung weist höheren Widerstand gegen thermische und mechanische Belastungen auf als bestehende Chrom-, Molybdän- und Plasmabeschichtungen. Diese bewährten Beschichtungen haben jedoch nichts von ihrer Bedeutung eingebüßt.

GOETZE DIAMANT-RINGVERSTÄRKUNGSBESCHICHTUNG, GDC

Dabei werden ultrafeine Diamanten im Nanometerbereich mit materialspezifischen, hybridischen Eigenschaften in die hartverchromte Lauffläche eingebettet. Eine GDC-beschichtete Ringlauffläche weist im Vergleich mit Laufflächen mit anderen Beschichtungen niedrigere Ringverschleißraten und eine bedeutend höhere Reibfestigkeit auf.

MONTAGEANLEITUNGEN FÜR KOLBENRINGE - DE

MONTAGEANLEITUNGEN FÜR KOLBENRINGE

Vor der Montage von Goetze Austauschkolbenringen müssen die Kolbenringnuten gereinigt werden. Dabei muss besonders darauf geachtet werden, dass der Nutgrundradius oder die Seitenwände nicht beschädigt werden. Das maximale Axialspiel für Benzinmotoren beträgt 0,13mm und für Dieselkolben 0,20mm. Kolben mit defekten Ringnuten oder übermäßigem Axialspiel sollten grundsätzlich durch Nüral Austauschkolben ersetzt werden.

VERDICHTUNGSRINGE

Kolbenringe sollten nur mit Kolbenringzangen montiert werden, und es muss darauf geachtet werden, dass der Ring nicht unnötig gedehnt wird. Übermäßiges Dehnen kann den Ring schädigen, Verformung verursachen und möglicherweise zum Bruch während des Betriebs führen.

Beim Zusammenbau muss speziell darauf geachtet werden, dass die Markierung OBEN (TOP) immer in Richtung Kolbenboden zeigt. Alle Goetze Verdichtungsringe tragen die Herstellerkennzeichnung "GOE", und wir empfehlen, dass alle Ringe (auch solche ohne die Markierung TOP) mit der markierten Seite in Richtung Kolbenboden zeigend montiert werden.

GOETZE VF 3-TEILIGE ÖLABSTREIFRINGE

Nur die Goetze VF 3-teiligen Ölabstreifringe sind unmarkiert, da alle drei Bestandteile ohne Ausrichtung montiert werden können. Zuerst den Expander in die Nut einpassen, dabei darauf achten, dass der Stoß nicht über Schlitz oder Löchern in der Basis der Ringnut positioniert wird.

Während die Enden des Expanders zusammengehalten werden, sollte die oberste Lamelle in die Nut gedreht werden. Dabei bei etwa 45° - 90° links vom Expanderstoß beginnen und in Richtung Stoß arbeiten.

Die untere Lamelle sollte bei 45° - 90° rechts vom Stoß montiert werden. Dabei in Richtung Stoß arbeiten.

Um für einen korrekten Einlauf der Ringe nach Aufarbeitung des Motors zu sorgen, empfehlen wir, den Motor etwa 500 bis 1000 km zu fahren und danach das Öl zu wechseln.

SITZ DER RINGE PRÜFEN

Nach Montage der Ringe am Kolben prüfen, dass sie sich unbehindert in den Ringnuten drehen können. Die Ringe dann mit den Ringspalten in Abständen von 120° positionieren

Verchromte Ringe dürfen nicht in Zylinder mit verchromten Bohrungen montiert werden.



FR - COMMENT UTILISER CE CATALOGUE

FEDERAL MOGUL		OPEL	
1	2	3	4
Corsa A Box 1.2 Corsa A Hatchback 1.2 S Corsa A TR 1.2 S Kadett D 1.2	02/86→04/89 09/82→02/90 09/82→03/93 08/82→08/84	12 ST	4cyl. 1196cc 40-43kW (55-58PS) TD4722
4	5	6	7
08-306200-00 STD →eng.12ST19136602	77.80	1.750 2.000 4.000	
8	9		
001 IF CR P 026 P 712 CR	IKA STD ST		

- 1** Identification du modèle
- 2** Identification du moteur
- 3** N° de panel/série
- 4** Référence et cote du jeu de segments
- 5** Diamètre d'alésage (nominal)
- 6** Largeur de segments
- 7** Modèle et coupe transversale des segments
- 8** Caractéristique et revêtement de segment
- 9** Code matériau

STRUCTURE DE RÉFÉRENCIEMENT **4**

SEGMENTS DE PISTON

- 08 - 114900 - 00 Référence au catalogue
- 08 - 114900 - 00 Code numérique
- 08 - 114900 - 00 Dim. (se reporter au tableau des cotes de réparation de segments)
- 08 - 114900 - 00 Version

CODES MATÉRIAUX **9**











Code matériau	Description
F12/F14	Fonte carbidique
GOE 12	Fonte grise sans traitement thermique
GOE13	Fonte à graphite lamellée, non traitée
IKA	Fonte grise
KV1	Fonte ductile
ST	Acier
STD	Fonte
KV4	Fonte à graphite sphéroïdal

TABLEAU DES COTES RÉPARATION DE SEGMENTS **4**

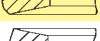
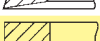

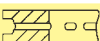
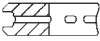
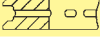
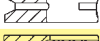

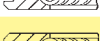
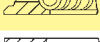
Cote	métrique	en pouces
00	STD	
03	0.125MM	
04	0.20MM	
05	0.25MM	.010
06	0.40MM	
07	0.50MM	.020
08	0.60MM	
09	0.75MM	.030
10	0.80MM	
11	1.00MM	.040
14	1.50MM	.060
17	2.286MM	.090
20	0.70MM	
21	0.65MM	
22	0.30MM	

COMMENT UTILISER CE CATALOGUE - FR

COUPES TRANSVERSALES DES SEGMENTS DE PISTON 7

Coupe transversale	Description
001 	Segment de compression à section rectangulaire
005 	Segment conique
006 	Segment faiblement conique
007 	Segment de compression semi-trapézoïdal
008 	Segment de compression trapézoïdal
009 	Segment trapézoïdal avec face portante conique
023 	Racleur à bec d'aigle
026 	Racleur conique à bec d'aigle
030 	Segment racleur d'huile à fentes
031 	Segment racleur à lèvres chanfreinées parallèles
032 	Segment racleur à fentes et lèvres chanfreinées symétriques
036 	Segment racleur d'huile à fentes
230 	Segment racleur à fentes avec ressort hélicoïdal
231/241 	Segment racleur à lèvres chanfreinées parallèles avec ressort hélicoïdal
232 	Segment racleur à fentes et lèvres chanfreinées symétriques avec ressort hélicoïdal
236 	Segment racleur à fentes avec ressort hélicoïdal
712 	Segment racleur à lamelles d'acier avec ressort VF

CARACTÉRISTIQUE DE SEGMENT 8

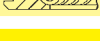
Coupe transversale	Description
IF 	IF Chanfrein intérieur – en haut
IFU 	IFU Chanfrein intérieur – en bas
IW 	IW Epaulement intérieur – en haut
IWU 	IWU Epaulement intérieur – en bas
LKZ 	Segment conique

REVÊTEMENTS ET TRAITEMENTS SUPERFICIELS 8

Type et symbole	Description	Type et symbole	Description
CR	Chromé	P	Phosphaté
MO	Enrichi en molybdène	NT	Nitridé
MOL	Recouvert de molybdène	PS	recouvert par plasma
CK	Revêtement chrome-céramique	GDC	Revêtement renforcé au diamant Goetze
PVD	Nitruure de chrome	DLC	Carbone diamant amorphe

SEGMENTS DE PISTON : FONCTION ET BESOINS

La fonction principale des segments de piston est d'assurer l'étanchéité : les segments veillent à ce que la chaleur et la pression produites lors du processus de combustion demeurent dans la chambre de combustion et à ce que l'huile ne pénètre pas dans cette dernière. De plus, le segment doit également assurer le transfert de la chaleur emmagasinée par le piston et réguler le processus de lubrification.

CONCEPTION DES SEGMENTS DE PISTON DE RECHANGE GOETZE NORMFORM

Les segments de piston GOETZE sont montés d'origine sur des moteurs à combustion interne et des compresseurs produits dans le monde entier. La collaboration permanente avec les services d'études et d'essais de la quasi-totalité des constructeurs automobiles et des motoristes, ainsi que les travaux de mise au point et les tests réalisés au sein de nos propres laboratoires d'essai, nous permettent d'acquérir des connaissances approfondies qui peuvent être exploitées sur presque tous les moteurs. La conception propre de chaque jeu de segments de rechange repose sur ce savoir-faire ainsi que sur des décennies d'expérience dans les segments de piston de deuxième monte. Leur conception est essentiellement basée sur des matériaux de segments de piston et des revêtements de surfaces de glissement qui ont fait leurs preuves en première monte.

EN RÈGLE GÉNÉRALE, LE PISTON EST MUNI DE TROIS SEGMENTS :

1. Le segment de feu : le plus souvent réalisé en acier, en fonte ou en fonte ductile, ces segments assurent l'étanchéité du mélange air-carburant dans la chambre de combustion.
2. Le second segment (ou segment d'étanchéité) : généralement réalisés en fonte ou en fonte ductile, ces segments à double fonction jouent le rôle à la fois de segment de compression et de segment racler d'huile.
3. Le segment racler : notamment en fonte ou en fonte ductile, ou encore en acier pour les segments en plusieurs parties, ce segment régule la quantité d'huile nécessaire pour lubrifier le segment de feu et le segment d'étanchéité.

LES TENDANCES DANS LE DOMAINE DES TECHNOLOGIES DE SEGMENTS DE PISTON

4. Réduction de la largeur des segments : du fait de moteurs plus petits avec des pistons plus légers et des hauteurs de compression inférieures.
5. Réduction du poids des segments : pour une puissance à haut régime et une stabilité accrues.
6. Réduction de la tension des segments : du fait de la nécessité de diminuer les pertes par frottement.
7. Composition métallurgique des segments : la tendance est aux alliages à haute résistance, tels que la fonte ductile et l'acier, afin de supporter des températures plus élevées engendrées par des mélanges de carburant plus pauvres et un positionnement plus haut des segments sur le piston visant à réduire les émissions polluantes.

REVÊTEMENTS DES SURFACES DE GLISSEMENT

CHROMAGE (CR)

Ce revêtement en chrome dur déposé par électrolyse allie une excellente tenue à l'usure à une résistance élevée au frottement. Cela explique la supériorité des segments chromés par rapport aux segments non revêtus et aux segments traités en surface.

REVÊTEMENT DE MOLYBDÈNE (MOL, MO)

Un procédé qui donne d'excellents résultats consiste à revêtir le pourtour du segment avec du molybdène afin d'éviter l'usure par frottement. Le molybdène présente un point de fusion très élevé (2620°C) et une bonne conductivité thermique, des facteurs qui contribuent à l'accroissement de la résistance au frottement et au rayage.

REVÊTEMENT PAR PROJECTION PLASMA (PS)

Aujourd'hui utilisés avec grand succès en production, les revêtements par projection plasma possèdent une résistance élevée à l'usure, au frottement et à la rupture ainsi qu'une grande robustesse intrinsèque. Ils occasionnent seulement une usure limitée du cylindre.

PHOSPHATATION (P)

Ce procédé est employé pour accélérer et améliorer le rodage des segments. La surface du segment est convertie par traitement chimique en cristaux de phosphate.

NITRURATION (NT)

Un traitement de surface par nitruration permet de réduire l'usure des segments de compression en acier et des rails d'acier des segments racleurs d'huile.

REVÊTEMENT CHROME-CÉRAMIQUE (CK)

Le revêtement CK supporte des charges thermiques et mécaniques plus importantes que les revêtements au chrome, molybdène ou plasma actuels, ce qui toutefois n'enlève rien à l'importance de ces revêtements éprouvés.

REVÊTEMENT DE SEGMENT RENFORCÉ AU DIAMANT DE GOETZE (GDC)

Des diamants ultrafins de quelques nanomètres et aux propriétés hybrides spécifiques, sont incrustés dans la surface de glissement en chrome dur. La surface de glissement des segments à revêtement GDC (pour «Goetze Diamond Coating») présente un taux d'usure de segment réduit ainsi qu'une résistance au frottement nettement plus élevée par rapport aux autres revêtements.

INSTRUCTIONS POUR LE MONTAGE DES SEGMENTS - FR

INSTRUCTIONS POUR LE MONTAGE DES SEGMENTS

Avant de procéder à la pose des segments de piston de rechange Goetze, les gorges des segments doivent être nettoyées en prenant bien soin de ne pas endommager le rayon de fond des gorges ou les parois latérales. Le jeu axial ne doit pas dépasser 0,13 mm pour les moteurs essence et 0,20 mm pour les moteurs Diesel (à titre indicatif).

Les pistons présentant des gorges de segments en mauvais état ou une usure axiale excessive doivent toujours être remplacés par des pistons de rechange Nüral.

SEGMENTS DE COMPRESSION

Il est recommandé d'installer les segments de piston à l'aide d'une pince à segment en faisant attention à ne pas trop écarter le segment. Un écartement excessif peut endommager le segment, provoquer des déformations et pourrait entraîner une rupture lors du fonctionnement.

Pendant le montage, veiller tout particulièrement à ce que l'inscription « TOP » (« haut ») soit toujours dirigée vers la tête du piston. Tous les segments de compression Goetze disposent de la marque de fabrique « GOE ». Aussi, nous recommandons d'installer tous les segments, y compris ceux sans marquage « TOP », avec le côté marqué orienté vers la tête du piston.

SEGMENTS RACLEURS À 3 PIÈCES GOETZE DE TYPE VF

Seuls les segments racleurs d'huile à trois pièces Goetze VF ne disposent d'aucun marquage car les trois éléments peuvent être installés sans avoir à respecter un sens de montage particulier.

Placer le ressort d'expansion du segment racleur dans la gorge en veillant au préalable à ce que la jointure ne soit pas positionnée sur des fentes ou des trous dans le fond de la gorge de segment.

Tout en maintenant les extrémités du ressort d'expansion ensemble, le rail d'acier supérieur doit être enroulé dans la gorge en commençant à environ 45°-90° à gauche de la jointure du ressort d'expansion et en l'orientant vers cette dernière.

Le rail inférieur doit être installé à 45°-90° à droite de la jointure et orienté vers celle-ci.

Pour assurer un rodage correct des segments après la remise en état du moteur, nous conseillons de faire tourner le moteur sur environ 500-1 000 km, puis de changer l'huile.

VÉRIFICATION DE L'INSTALLATION DES SEGMENTS

Une fois les segments en place sur le piston, vérifier qu'ils tournent librement dans leurs gorges. Les segments doivent alors être positionnés en orientant les fentes des segments à 120° les unes des autres.

NB : Il est déconseillé de monter des segments chromés dans des cylindres avec alésage chromé.



ES - CÓMO UTILIZAR ESTE CATÁLOGO

FEDERAL MOGUL		OPEL			
1	2	3	4	5	
Corsa A Box 1.2 Corsa A Hatchback 1.2 S Corsa A TR 1.2 S Kadett D 1.2	02/86→04/89 09/82→02/90 09/82→03/93 08/82→08/84	12 ST	4cyl. 1196cc 40-43kW (55-58PS)	11 TD4722	
4	5	6	7	8	9
08-306200-00 STD →eng.12ST19136602	77.80	1.750 2.000 4.000		001 IF CR P 026 P 712 CR	IKA STD ST

- 1** Información del modelo
- 2** Información del motor
- 3** Número de panel
- 4** Referencia y medida del juego de segmentos
- 5** Diámetro de Pistón
- 6** Anchuras de los segmentos
- 7** Diseño y perfil del segmento
- 8** Característica y revestimiento del segmento
- 9** Código del material

ESTRUCTURA DE LAS REFERENCIAS **4**

SEGMENTOS DE PISTÓN

- 08 - 114900 - 00 Referencia en el catálogo
- 08 - 114900 - 00 Referencia
- 08 - 114900 - 00 Medida (Consulte la tabla de segmentos para las sobre medidas)
- 08 - 114900 - 00 Versión

TABLA DE SEGMENTOS SOBREMEDIDAS **4**

Tamaño	Medida en sistema métrico	Medida en pulgadas
00	STD	
03	0.125MM	
04	0.20MM	
05	0.25MM	.010
06	0.40MM	
07	0.50MM	.020
08	0.60MM	
09	0.75MM	.030
10	0.80MM	
11	1.00MM	.040
14	1.50MM	.060
17	2.286MM	.090
20	0.70MM	
21	0.65MM	
22	0.30MM	

CÓDIGOS DE MATERIAL **9**

Código de material	Descripción
F12/F14	Hierro fundido al carbono
GOE 12	Fundición gris sin ningún tratamiento térmico
GOE13	Hierro fundido al grafito laminado sin tratar
IKA	Fundición gris
KV1	Fundición dúctil
ST	Acero
STD	Fundición
KV4	Fundición de grafito esferoidal

CÓMO UTILIZAR ESTE CATÁLOGO - ES

SECCIONES TRANSVERSALES DE LOS SEGMENTOS DE PISTÓN 7

	Sección transversal	Descripción
001		Segmento de compresión normal
005		Segmento cónico
006		Segmento ligeramente cónico
007		Segmento de compresión semi-trapezoidal
008		Segmento de compresión trapezoidal
009		Segmento de clave trapezoidal con superficie cónica
023		Segmento rascador
026		Segmento rascador cónico
030		Segmento ranurado de engrase
031		Segmento de engrase con chaflanes opuestos
032		Segmento de engrase con chaflanes iguales
036		Segmento ranurado de engrase
230		Segmento ranurado de engrase con muelle en espiral
231/241		Segmento de engrase con chaflanes opuestos y muelle en espiral
232		Segmento de engrase con chaflanes iguales y muelle en espiral
236		Segmento ranurado de engrase con muelle en espiral
712		Segmento de engrase con lámina de acero y muelle VF

FUNCIÓN DEL SEGMENTO 8

	Sección transversal	Descripción
IF		Chaflán interior en la parte superior
IFU		Chaflán interior en la parte inferior
IW		Escalón interior en la parte superior
IWU		Escalón interior en la parte inferior
LKZ		Segmento cónico

REVESTIMIENTOS Y CÓDIGOS DE TRATAMIENTO 8

Tipo y código	Descripción	Tipo y código	Descripción
CR	Cromado	P	Phosphated
MO	Incrustación de molibdeno	NT	Nitrided
MOL	Revestimiento de molibdeno	PS	Plasma spray coated
CK	Revestimiento de cromo y cerámica	GDC	Goetze Diamond Coated
PVD	Nitruro de cromo	DLC	Carbon adiamantado

FUNCIÓN Y REQUISITOS DE LOS SEGMENTOS DE PISTÓN

La función principal de los segmentos de pistón es crear estanqueidad: garantizar que el calor y la presión generados durante el proceso de combustión permanecen en la cámara de combustión y que no entra aceite en ella. Asimismo, los segmentos permiten transmitir el calor que se acumula en el pistón y regular la lubricación.

DISEÑO DE LOS SEGMENTOS DE PISTÓN DE RECAMBIO GOETZE NORMFOR

Los segmentos de pistón GOETZE se incorporan como equipo original en los motores de combustión interna y los compresores de las cadenas de producción de todo el mundo. Nuestra continua colaboración con los departamentos de diseño y de tests de prácticamente todos los fabricantes de vehículos y motores, así como el trabajo de desarrollo y de pruebas que llevamos a cabo en nuestros propios laboratorios, nos proporcionan un detallado conocimiento que podemos aplicar en casi todos los motores. Dicho conocimiento y las décadas de experiencia que llevamos comercializando segmentos de pistón de recambio son la base del diseño individual de cada juego de segmentos de recambio, basado fundamentalmente en los materiales de fabricación y en los revestimientos de la cara que roza con el cilindro que ya se han probado en las aplicaciones de equipo original.

POR LO GENERAL, EL PAQUETE DE SEGMENTOS SE COMPONE DE TRES ELEMENTOS:

1. Segmento de compresión: suele estar hecho de acero, fundición dúctil y fundición. Permite crear estanqueidad entre la mezcla de aire y combustible en la cámara de combustión.
2. Rascador de aceite: suele estar hecho de fundición dúctil y fundición. Tiene una doble función: combina las características del segmento de compresión con las del segmento de engrase.
3. Segmento de engrase: puede estar hecho de fundición dúctil y fundición, aunque si está compuesto por varias piezas se utiliza el acero. Permite regular la cantidad de aceite necesaria para lubricar los dos primeros segmentos.

TENDENCIAS EN LA TECNOLOGÍA DE LOS SEGMENTOS DE PISTÓN

4. Reducción de la anchura del segmento, debido a que los motores son cada vez más pequeños y cuentan con relaciones de compresión más ajustadas y pistones más ligeros.
5. Reducción de la altura del segmento, para mayor estabilidad y rpm.
6. Reducción de la tensión del segmento, por la necesidad de reducir las pérdidas de fricción.
7. Metales del segmento: la tendencia actual es elegir aleaciones de gran resistencia, como la fundición dúctil y el acero, para poder soportar temperaturas más altas generadas por las mezclas de combustible más pobres y por la colocación del segmento más cerca de la corona para reducir las emisiones.

REVESTIMIENTOS DE LA CARA QUE ROZA CON EL CILINDRO

CROMADO, CR

El revestimiento duro de cromo depositado electrónicamente combina una excelente resistencia al desgaste con una alta resistencia al desgaste por fricción. Esto explica la superioridad de los segmentos cromados frente a los segmentos sin revestimiento y con tratamiento de la superficie.

REVESTIMIENTO DE MOLIBDENO, MOL, MO

Para evitar el desgaste por fricción de la periferia del segmento, se reviste de molibdeno. Este proceso ha producido excelentes resultados dado que el molibdeno tiene un punto de fusión muy alto (2.620 °C) y una buena conductividad térmica, factores que explican la alta resistencia al desgaste por fricción y por ralladuras.

REVESTIMIENTO DE PULVERIZACIÓN DE PLASMA, PS

Actualmente, para fabricar segmentos se suelen utilizar los revestimientos de pulverización de plasma, que poseen una alta resistencia a la rotura, la fricción y el desgaste, además de una alta resistencia inherente, mientras que sólo causa un desgaste limitado del cilindro.

FOSFATACIÓN, P

Este proceso se utiliza para acelerar y mejorar la adaptación de los segmentos. La superficie del segmento se transforma en cristales de fosfato mediante un tratamiento químico.

NITRURACIÓN, NT

El tratamiento superficial de nitruración permite reducir el desgaste de los segmentos de compresión y las láminas de acero de los de engrase.

REVESTIMIENTO CROMO-CERÁMICO, CK

El revestimiento CK soporta una carga mecánica y térmica superior a los revestimientos de plasma, molibdeno y cromo existentes, aunque estos últimos, que se han probado y testeado, no dejan de tener su importancia.

Revestimiento reforzado Diamond de Goetze, GDC

En la superficie de roce de cromo duro se incrustan unos diamantes ultrafinos con materiales específicos, propiedades híbridas y dimensiones nanométricas. Si lo comparamos con otros revestimientos, la superficie de roce del segmento GDC presenta índices de desgaste menores y una resistencia considerablemente mayor a las ralladuras.

INSTRUCCIONES DE MONTAJE DE LOS SEGMENTOS DE PISTÓN - ES

INSTRUCCIONES DE MONTAJE DE LOS SEGMENTOS DE PISTÓN

Antes de montar los segmentos de pistón Goetze de recambio, es necesario limpiar las ranuras de los segmentos con cuidado para no dañar las paredes laterales ni los radios de la raíz de la ranura. La holgura axial máxima es, en motores de gasolina, de 0,13 mm, y en motores diésel, de 0,20 mm.

Si los pistones presentan un deterioro en la ranura de los segmentos o un desgaste axial excesivo, cámbielos por pistones Nüral.

SEGMENTOS DE COMPRESIÓN

Los segmentos de pistón se deben colocar con unas pinzas especiales sin abrir el segmento más de lo necesario.

Si se estira demasiado, puede quedar dañado, deformado o incluso llegar a romperse cuando el motor está en funcionamiento.

Durante el montaje, ponga especial atención a la marca TOP, que debe estar mirando a la corona del pistón.

Todos los segmentos de compresión Goetze llevan la marca de fabricante «GOE», y recomendamos colocar todos los segmentos, incluidos los que no presentan la marca TOP, con el lado marcado en dirección a la corona del pistón.

SEGMENTOS DE ENGRASE GOETZE VF DE TRES PIEZAS

Los únicos segmentos que no están marcados son los de engrase Goetze VF de tres piezas, ya que es indiferente la orientación en la que se coloquen.

Coloque el expansor en la ranura teniendo en cuenta que la junta no queda sobre las acanaladuras u orificios del fondo de la ranura.

Mientras se sujetan los dos extremos del expansor, la lámina de acero superior debe quedar alrededor de la ranura a partir de entre 45° y 90° a la izquierda de la junta del expansor siguiendo esta dirección.

La lámina inferior se debe colocar entre 45° y 90° a la derecha de la junta siguiendo esta dirección.

Para asegurarse de que los segmentos se adapten de forma adecuada después de reacondicionar el motor, recomendamos que recorra una distancia de entre 500 y 1.000 kilómetros y, a continuación, cambie el aceite.

COMPROBACIÓN DEL MONTAJE DE LOS SEGMENTOS

Una vez montados los segmentos en el pistón, compruebe que giran en las ranuras sin dificultad. Los segmentos se deben colocar con las puntas abiertas a intervalos de 120°.

Nota: no se deben colocar segmentos cromados en cilindros cromados.



PL - JAK KORZYSTAĆ Z TEGO KATALOGU

FEDERAL MOGUL		OPEL		
1	2	3		
Corsa A Box 1.2 02/86→04/89 12 ST Corsa A Hatchback 1.2 S 09/82→02/90 4cyl. Corsa A TR 1.2 S 09/82→03/93 1196cc 40-43kW (55-58PS) Kadett D 1.2 08/82→08/84		11	TD4722	
4	5	6	7	8
08-306200-00 STD →eng.12ST19136602	77.80	1.750 2.000 4.000		001 IF CR P 026 P 712 CR
				9
				IKA STD ST

- 1** Informacja o modelu
- 2** Informacja o silniku
- 3** Numer panelu
- 4** Numer referencyjny zestawu pierścieni i rozmiar

- 5** Nominalna średnica cylindra
- 6** Grubość pierścienia
- 7** Typ i profil pierścienia
- 8** Właściwości i pokrycie pierścienia
- 9** Kod materiału

STRUKTURA NUMERU REFERENCYJNEGO **4**

PIERŚCIEŃ TŁOKOWE

- 08 - 114900 - 00 Pełen numer referencyjny
- 08 - 114900 - 00 Numer produktu
- 08 - 114900 - 00 Rozmiar (patrz tabela nadwymiarów)
- 08 - 114900 - 00 Wersja

KODY MATERIAŁOWE **9**

Kody materiałowe	Opis
F12/F14	Żeliwo karbidowe z wtrąceniami węglowymi
GOE 12	Żeliwo szare nie obrabiane termicznie
GOE13	Niestopowe, nieobrabiane termicznie żeliwo z grafitem płatkowym
IKA	Żeliwo szare
KV1	Żeliwo ciągliwe
ST	Stal
STD	Żeliwo
KV4	Żeliwo sferoidalne

TABELA NADWYMIARÓW PIERŚCIEŃ **4**

Rozmiar	Metryczny	Calowy
00	STD	
03	0.125MM	
04	0.20MM	
05	0.25MM	.010
06	0.40MM	
07	0.50MM	.020
08	0.60MM	
09	0.75MM	.030
10	0.80MM	
11	1.00MM	.040
14	1.50MM	.060
17	2.286MM	.090
20	0.70MM	
21	0.65MM	
22	0.30MM	

JAK KORZYSTAĆ Z TEGO KATALOGU - PL

PRZEKROJE PIERŚCIENI TŁOKOWYCH 7

Przekrój poprzeczny	Opis
001	Zwykły pierścień kompresyjny
005	Pierścień stożkowy
006	Pierścień lekko-stożkowy
007	Klinowy pierścień kompresyjny
008	Pierścień kompresyjny trapezowy
009	Pierścień trapezowy o czole stożkowym
023	Pierścień zgarniający o przekroju hakowym - pojedynczym
026	Stożkowy pierścień zgarniający o przekroju hakowym-pojedynczym
030	Szczelinowy olejowy pierścień zgarniający
031	Fazowany pierścień olejowy
032	Podwójnie fazowany pierścień olejowy
036	Szczelinowy olejowy pierścień zgarniający
230	Szczelinowy olejowy pierścień zgarniający ze sprężyną spiralną
231/241	Fazowany pierścień olejowy ze sprężyną spiralną
232	Podwójnie fazowany pierścień olejowy ze sprężyną spiralną
236	Szczelinowy olejowy pierścień zgarniający za sprężyną spiralną
712	Olejowy pierścień z szyną stalową i sprężyną typu VF

WŁAŚCIWOŚCI PIERŚCIENIA 8

Przekrój poprzeczny	Opis
IF	IF Faza wewnętrzna – strona górna
IFU	IFU Faza wewnętrzna – strona spodnia
IW	IW Stopień wewnętrzny – strona górna
IWU	IWU Stopień wewnętrzny – strona spodnia
LKZ	Pierścień stożkowy

KODY POKRYĆ I OBRÓBKI CIEPLNEJ 8

Typ i kod	Opis	Typ i kod	Opis
CR	Chromowany	P	Fosforowany
MO	Zawierający cząstki molibdenu	NT	Azotowany
MOL	Pokryty warstwą molibdenu	PS	Z powłoką napylaną plazmowo
CK	Z powłoką chromowo-ceramiczną	GDC	Powłoka diamentowa Goetze
PVD	Azotek Chromu	DLC	Diamentopodobne Pokrycie Węglowe

PIERŚCIENIE TŁOKOWE – FUNKCJE I WYMAGANIA

Podstawową funkcją pierścieni tłokowych jest zapewnienie szczelności – zapewnienie by energia cieplna i ciśnienie wytwarzane w trakcie procesu spalania paliwa pozostały w komorze spalania oraz by nie dostał się tam olej silnikowy. Ponadto pierścienie tłokowe uczestniczą w przepływie ciepła z tłoka do bloku cylindrów oraz mają istotny wpływ na proces smarowania.

KONSTRUKCJA GOETZE NORMFORM – ZAMIENNYCH PIERŚCIENI TŁOKOWYCH

Pierścienie tłokowe GOETZE są montowane na liniach produkcyjnych na całym świecie, jako wyposażenie oryginalne – OE w silnikach spalinowych o wewnętrznym spalaniu oraz w sprężarkach. Dzięki ciągłej współpracy z departamentami projektowymi i testowymi praktycznie wszystkich producentów silników i samochodów oraz dzięki własnym testom w naszych laboratoriach i pracami nad rozwojem technologii, dysponujemy spójną i szeroką wiedzą, która może być przydatna w przypadku niemalże każdego silnika. Ta wiedza know-how i dziesiątki lat doświadczeń z pierścieniami tłokowymi są bazą przy indywidualnym projekcie każdego zestawu pierścieni tłokowych. Projekty zasadniczo korzystają z rodzajów materiałów pierścieni i pokryć powierzchni roboczych, które sprawdzily się w zastosowaniach na montaż fabryczny – OE.

OPAKOWANIE PIERŚCIENI TŁOKOWYCH ZAWIERA NAJCZĘŚCIEJ TRZY TYPY PIERŚCIENI:

1. Górny pierścień kompresyjny – często wykonany ze stali, żeliwa ciągliwego i żeliwa szarego. Ten rodzaj pierścieni odpowiada za uszczelnienie komory spalania w trakcie kompresji i spalania mieszanki paliwowo-powietrznej
2. Drugi pierścień kompresyjny – zasadniczo produkowany z żeliwa ciągliwego i żeliwa szarego. Ten rodzaj pierścieni łączy funkcję pierścieni kompresyjnych i pierścieni olejowych.
3. Pierścień olejowy - może być wytwarzany z żeliwa ciągliwego oraz żeliwa szarego, a także ze stali w przypadku pierścieni wieloelementowych. Funkcją tego pierścienia jest regulowanie ilości oleju niezbędnego do smarowania górnego i drugiego pierścienia kompresyjnego.

TRENDY W TECHNOLOGII PIERŚCIENI TŁOKOWYCH

4. Zmniejszanie grubości pierścieni – w związku z popularizacją mniejszych silników, wyposażanych w lepsze tłoki i krótsze wysokości kompresyjne
5. Zmniejszanie wagi pierścieni – w celu osiągnięcia wyższych prędkości obrotowych i stabilności biegu
6. Zmniejszanie naprężeń roboczych – w celu redukcji strat wynikających z tarcia pierścieni o powierzchnię cylindra
7. Materiały na pierścienie - tendencja rozwojowa jest skierowana w kierunku materiałów o większej wytrzymałości, takich jak żeliwo ciągliwe czy stal w celu zdolności pracy w wyższych temperaturach, które z kolei są wynikiem pracy silników na coraz uboższych mieszankach oraz umieszczania pierścieni w coraz wyższych rejonach tłoka, by zmniejszać emisję szkodliwych czynników.

POKRYCIA POWIERZCHNI ROBOCZYCH

POKRYCIE CHROMOWE, CR

Twarda galwaniczna powłoka chromowa łączy wysoką twardość z dużą odpornością na ścieranie. Te właściwości powodują, że pierścienie chromowane mają przewagę nad pierścieniami nie pokrywanymi lub pierścieniami z ulepszonymi powierzchniami roboczymi.

POKRYCIE MOLIBDENOWE, MOL, MO

Dla uniknięcia ścierania się powierzchni skrajnych stosuje się pokrycie molibdenem.

To rozwiązanie daje doskonałe rezultaty. Molibden ma bardzo wysoką temperaturę topnienia – 2620°C i dobrą przewodność cieplną, czyli cechy bardzo korzystne jeśli chodzi o odporność na ścieranie i rysowanie.

POKRYCIE ROZPYLONĄ PLAZMĄ – PS

Pokrycie rozpyloną plazmą charakteryzuje się dużą odpornością na zużycie, ścieranie i pęknięcia oraz dużą wytrzymałością. Nie powoduje przy tym znacznego zużycia powierzchni cylindra. Dzięki tym właściwościom ten rodzaj pokrycia jest obecnie z powodzeniem stosowany w produkcji.

FOSFORANOWANIE, P

Ten proces jest stosowany w celu przyspieszenia i poprawienia procesu docierania się pierścieni tłokowych. Powierzchnia pierścienia jest zmieniona przez reakcję chemiczną w kryształ fosforanowe.

AZOTOWANIE, NT

Jest to obróbka powierzchni stalowych w celu zmniejszenia zużycia w stalowych pierścieniach kompresyjnych oraz stalowych elementach pierścieni olejowych.

POKRYCIE CHROMOWO-CERAMICZNE, CK

Pokrycie CK wytrzymuje wyższe mechaniczne i termiczne obciążenia niż istniejące pokrycia chromowe, molibdenowe i plazmowe. Niemniej jednak, te wypróbowane i przetestowane pokrycia nie straciły nic ze swych zalet.

POKRYCIE DIAMENTOWE GOETZE, GDC

Bardzo drobne diamenty, o rozmiarach nanometrycznych, charakteryzujące się hybrydowymi właściwościami są niejako wbudowane w twardą chromową powierzchnię roboczą. Powierzchnia pierścieni pokrytych metodą GDC jest bardziej odporna na zużycie i zdecydowanie bardziej odporna na ścieranie w porównaniu do innych rodzajów pokryć.

PIERŚCIENIE TŁOKOWE – ZALECENIA MONTAŻOWE - PL

PIERŚCIENIE TŁOKOWE – ZALECENIA MONTAŻOWE

Przed przystąpieniem do montażu pierścieni tłokowych należy oczyścić rowki pierścieniowe w tłoku. Proces czyszczenia należy przeprowadzić z odpowiednią uwagą, by nie uszkodzić powierzchni bocznych ani denka rowka. Maksymalny dopuszczalny luz osiowy dla silników benzynowych wynosi 0,13 mm, a w przypadku silników dieslowskich – 0,20 mm.

Tłoki z wadliwymi/uszkodzonymi rowkami pierścieniowymi lub z nadmiernym luzem osiowym powinny być zawsze wymieniane na zamienne tłoki Nüral.

PIERŚCIENIE KOMPRESYJNE

Pierścienie tłokowe powinny być montowane przy użyciu specjalnych szczypiec by uniknąć większego niż konieczne rozchylenia pierścienia. Zbytne rozchylenie pierścienia może doprowadzić do jego uszkodzenia. Może spowodować odkształcenia, co może zakończyć się pęknięciem pierścienia w trakcie tej operacji.

W trakcie montażu należy zwrócić szczególną uwagę na oznaczenie góry (TOP), które powinno być zawsze skierowane w kierunku korony tłoka.

Wszystkie pierścienie kompresyjne Goetze będą miały znak producenta „GOE”. Zalecamy, by wszystkie pierścienie, włączając również te bez oznaczenia TOP były montowane powierzchnią oznakowaną w kierunku korony tłoka.

OLEJOWE PIERŚCIENIE 3-CZĘŚCIOWE TYPU GOETZE VF

Jedynie olejowe pierścienie 3-częściowe typu Goetze VF nie są znakowane, gdyż wszystkie 3 elementy mogą być montowane bez względu na orientację.

Należy najpierw zamontować element rozprężny w rowku na pierścień, zwracając uwagę, by połączenie nie było zlokalizowane nad szczelinami lub otworami w bazie rowka pierścieniowego.

Trzymając końce elementu rozprężnego razem, należy rozpocząć wkładanie górnego elementu stalowego w rowek pierścieniowy, zaczynając o około 45°-90° na lewo od połączenia elementu rozprężnego, kierując się w kierunku połączenia.

Dolny element stalowy powinien być montowany 45° - 90° na prawo od połączenia elementu rozprężnego, kierując się w kierunku połączenia. Aby zapewnić dobre docieranie się pierścieni po naprawie silnika, zalecamy wymienić olej po przejechaniu około 500-1000 km.

SPRAWDZANIE POPRAWNOŚCI MONTAŻU PIERŚCIENI TŁOKOWYCH

Po zamontowaniu pierścieni na tłoku należy upewnić się, że mogą się one swobodnie obracać w rowkach. Następnie pierścienie należy umieścić tak, by szczeliny pierścieni były rozmieszczone co 120°.

UWAGA. Pierścienie o pokryciach chromowych nie powinny być montowane do cylindrów, które mają również chromowane pokrycia powierzchni.



RU - КАК ПОЛЬЗОВАТЬСЯ КАТАЛОГОМ

FEDERAL MOGUL					OPEL	
1	2	3				
Corsa A Box 1.2 02/86→04/89 12 ST Corsa A Hatchback 1.2 S 09/82→02/90 Corsa A TR 1.2 S 09/82→03/93 Kadett D 1.2 08/82→08/84		4cyl. 1196cc 40-43kW (55-58PS)	11		TD4722	
4	5	6	7	8	9	
08-306200-00 STD →eng.12ST19136602	77.80	1.750 2.000 4.000		001 IF CR P 026 P 712 CR	IKA STD ST	

- 1** Сведения о модели
- 2** Сведения о двигателе
- 3** № на панели
- 4** Код и размеры комплекта колец
- 5** Внутренний диаметр цилиндра (номинальный)
- 6** Ширина колец
- 7** Дизайн и профиль колец
- 8** Особенности и покрытие колец
- 9** Код материала

СТРУКТУРА НОМЕРА ДЕТАЛИ **4**

ПОРШНЕВЫЕ КОЛЬЦА

- 08 - 114900 - 00 Коды в каталоге
- 08 - 114900 - 00 Код
- 08 - 114900 - 00 Размер (см. таблицу ремонтных размеров колец)
- 08 - 114900 - 00 Версия

КОДЫ МАТЕРИАЛОВ **9**











Код материала	Описание
F12/F14	Карбидный чугун
GOE 12	Серый чугун без термообработки
GOE13	Нелегированный чугун, без термообработки, с пластинчатым графитом
IKA	Серый чугун
KV1	Пластичный чугун
ST	Сталь
STD	Чугун
KV4	Чугун с шаровидным графитом

АБЛИЦА РЕМОНТНЫХ РАЗМЕРОВ КОЛЕЦ **4**





Размер	Метрические е.и.	Британские е.и.
00	STD	
03	0.125MM	
04	0.20MM	
05	0.25MM	.010
06	0.40MM	
07	0.50MM	.020
08	0.60MM	
09	0.75MM	.030
10	0.80MM	
11	1.00MM	.040
14	1.50MM	.060
17	2.286MM	.090
20	0.70MM	
21	0.65MM	
22	0.30MM	

КАК ПОЛЬЗОВАТЬСЯ КАТАЛОГОМ - RU

СЕЧЕНИЯ ПОРШНЕВЫХ КОЛЕЦ 7

	Сечения	Описание
001		Цилиндрическое компрессионное кольцо
005		Конусообразное кольцо
006		Кольцо с небольшим конусом
007		Клиновидное компрессионное кольцо
008		Трапециевидное компрессионное кольцо
009		Трапециевидное кольцо с наружным конусом
023		Поршневое кольцо с одинарной проточкой
026		Поршневое кольцо с одинарной проточкой и наружным конусом
030		Маслосъемное поршневое кольцо с дренажными прорезями
031		Маслосъемное кольцо со скосами
032		Двойное маслосъемное кольцо со скосами
036		Маслосъемное поршневое кольцо с дренажными прорезями
230		Маслосъемное поршневое кольцо с дренажными прорезями и спиральной пружиной
231/241		Маслосъемное кольцо со скосами и спиральной пружиной
232		Двойное маслосъемное кольцо со скосами и спиральной пружиной
236		Маслосъемное поршневое кольцо с дренажными прорезями и спиральной пружиной
712		Маслосъемное кольцо со стальной крестовиной и VF пружиной

ОСОБЕННОСТИ КОЛЕЦ 8

	Сечения	Описание
IF		Внутренний скос – верхняя сторона
IFU		Внутренний скос – нижняя сторона
IW		Внутренняя ступенька – верхняя сторона
IWU		Внутренняя ступенька – нижняя сторона
LKZ		Конусообразное кольцо

КОДЫ ПОКРЫТИЙ И ВИДОВ ОБРАБОТКИ 8

Типа и кода	Описание	Типа и кода	Описание
CR	Хромированное	P	Фосфатированное
MO	Молибденовая обработка	NT	Азотированное
MOL	Молибденовое покрытие	PS	Плазменное напыление
СК	Хромокерамическое покрытие	GDC	Алмазное покрытие Goetze
PVD	С покрытием из нитрида хрома	DLC	С алмазоподобным покрытием

ПОРШНЕВЫЕ КОЛЬЦА - ФУНКЦИИ И ТРЕБОВАНИЯ

Основное назначение поршневых колец - уплотнение: обеспечить, чтобы высокая температура и давление, возникающие в процессе сгорания топлива, оставались в камере сгорания, а масло не попадало туда. Кроме того, кольцо должно отводить тепло от поршня и регулировать процесс смазки.

КОНСТРУКЦИЯ ПОРШНЕВЫХ КОЛЕЦ GOETZE NORMFORM

Поршневые кольца GOETZE устанавливаются в качестве оригинального оборудования на двигатели внутреннего сгорания и компрессоры на производственных линиях по всему миру.

Постоянное сотрудничество с конструкторскими отделами и испытателями практически всех производителей двигателей и автомобилей, а также разработки и испытания, проводимые в наших лабораториях, дают обширные знания, которые можно применить практически на любом двигателе. Эти ноу-хау и накопленный десятилетиями опыт в сфере сменных поршневых колец являются основой для индивидуального проектирования каждого комплекта сменных колец. Конструкция в основном базируется на материалах для поршневых колец и покрытиях рабочих поверхностей, зарекомендовавших себя в составе оригинального оборудования.

ОБЫЧНО КОМПЛЕКТ СОСТОИТ ИЗ ТРЕХ КОЛЕЦ:

1. Верхнее компрессионное кольцо – часто изготавливается из стали, чугуна с шаровидным графитом и литейного чугуна, эти кольца удерживают топливовоздушную смесь в камере сгорания.
2. Второе компрессионное кольцо – обычно изготавливается из чугуна с шаровидным графитом и литейного чугуна, эти кольца выполняют двойную функцию: они играют роль как компрессионного, так и маслосъемного кольца.
3. Маслосъемное кольцо – может изготавливаться из чугуна с шаровидным графитом и литейного чугуна, однако для многоэлементных колец используется сталь. Эти кольца регулируют количество масла, необходимого для смазки верхнего и второго колец.

ТЕНДЕНЦИИ В ТЕХНОЛОГИЯХ СОЗДАНИЯ ПОРШНЕВЫХ КОЛЕЦ

4. Уменьшение ширины кольца – из-за уменьшения размеров двигателей, облегчения поршней и снижения расстояния от днища поршня до оси поршневого пальца.
5. Снижение веса колец – для повышения оборотов и устойчивости двигателя.
6. Снижение напряжения в кольцах – из-за необходимости уменьшить потери на трение.
7. Металлургические аспекты производства колец – существует тенденция к использованию высокопрочных сплавов, таких как чугун с шаровидным графитом и сталь. Это позволяет противостоять высоким температурам, возникающим при сгорании обедненного топлива, и из-за более высокого расположения колец на поршне для снижения выбросов в атмосферу.

ПОКРЫТИЯ РАБОЧИХ ПОВЕРХНОСТЕЙ

ХРОМИРОВАНИЕ, CR

Электроосажденное твердое хромовое покрытие сочетает в себе прекрасную износостойчивость с высокой устойчивостью к задирам. Этим объясняется превосходство хромированных колец по сравнению с кольцами без покрытия и кольцами с обработанной поверхностью.

МОЛИБДЕНОВОЕ ПОКРЫТИЕ, MOL, MO

Чтобы не допустить задириков, края кольца покрывают молибденом. Такое решение продемонстрировало превосходные результаты. Молибден отличается очень высокой температурой плавления (2620°C) и хорошей теплопроводностью – эти показатели определяют его высокую устойчивость к задирам и износу.

ПЛАЗМЕННОЕ НАПЫЛЕНИЕ, PS

Сегодня все большее распространение получает плазменное напыление, обладающее высокой устойчивостью к износу, задирам и разломам, а также высокой прочностью, и при этом вызывающее лишь незначительный износ цилиндра.

ФОСФАТИРОВАНИЕ, P

Этот процесс используется для ускорения и улучшения приработки колец. На поверхности кольца с помощью химической обработки создаются кристаллы фосфатов.

АЗОТИРОВАНИЕ, NT

Азотирование поверхности позволяет уменьшить износ стальных компрессионных колец и стальных кромок маслосъемных колец.

ХРОМОКЕРАМИЧЕСКОЕ ПОКРЫТИЕ, SK

Покрытие SK выдерживает более высокие тепловые и механические нагрузки по сравнению с существующими хромовыми, молибденовыми и плазменными покрытиями, хотя эти проверенные и испытанные покрытия не теряют своей актуальности.

АЛМАЗНОЕ ПОКРЫТИЕ ДЛЯ КОЛЕЦ GOETZE, GDC

Алмазные нанокристаллы, обладающие специфическими комбинированными свойствами размерами, внедряются в твердую рабочую поверхность из хрома. По сравнению с другими покрытиями рабочая поверхность кольца GDC отличается пониженным износом и значительно более высокой устойчивостью к задирам.

УКАЗАНИЯ ПО УСТАНОВКЕ ПОРШНЕВЫХ КОЛЕЦ - RU

УКАЗАНИЯ ПО УСТАНОВКЕ ПОРШНЕВЫХ КОЛЕЦ

Перед установкой ремонтных поршневых колец Goetze следует очистить канавки на поршне, соблюдая особую осторожность, чтобы не повредить радиус или стенки канавок. Максимальный осевой зазор для бензиновых двигателей составляет 0,13 мм, а для поршней дизельных двигателей – 0,20 мм

Поршни с дефектами канавок или сильным осевым износом следует заменить ремонтными поршнями Nüral.

КОМПРЕССИОННЫЕ КОЛЬЦА

Поршневые кольца следует устанавливать с помощью специальных щипцов, стараясь не разводить концы колец больше необходимого.

Чрезмерное растяжение может повредить кольцо, вызвать его деформацию и стать причиной поломки во время работы. Во время сборки обращайте особое внимание на маркировку TOP (Верх) – эта сторона должна быть обращена к головке поршня.

Все компрессионные кольца Goetze помечены знаком производителя "GOE"; рекомендуется все кольца, в том числе не имеющие маркировки „TOP“, устанавливать маркированной стороной к головке поршня.

ТРЕХЭЛЕМЕНТНЫЕ МАСЛОСЪЕМНЫЕ КОЛЬЦА GOETZE VF

Маркировка отсутствует только на трехэлементных маслосъемных кольцах Goetze VF, поскольку все три элемента можно устанавливать без учета ориентации.

Вставьте экспандер в канавку так, чтобы замок не был расположен рядом с прорезями или отверстиями в основании канавки кольца.

Сжав концы экспандера, вставьте верхнюю направляющую в канавку, начиная под углом примерно 45°-90° слева от замка экспандера и продолжая установку по направлению к замку.

Нижнюю направляющую следует вставить под углом 45°-90° справа от замка и продолжать установку в направлении замка. Чтобы обеспечить правильную приработку колец после ремонта двигателя, рекомендуется сменить масло после пробега в 500 – 1000 км.

ПРОВЕРКА ПОСАДКИ КОЛЕЦ

После установки колец на поршень убедитесь, что кольца свободно вращаются в канавках. Замки колец следует расположить с интервалами в 120°

ВВ. Хромированные кольца нельзя устанавливать в цилиндры с хромированными зеркалами.



AR - كيفية استخدام هذا الكتالوج

FEDERAL MOGUL		OPEL			
1	2	3	4	5	
Corsa A Box 1.2 Corsa A Hatchback 1.2 S Corsa A TR 1.2 S Kadett D 1.2	02/86→04/89 09/82→02/90 09/82→03/93 08/82→08/84	12 ST	4cyl. 1196cc 40-43kW (55-58PS)	11 TD4722	
4	5	6	7	8	9
08-306200-00 STD →eng.12ST19136602	77.80	1.750 2.000 4.000		001 IF CR P 026 P 712 CR	IKA STD ST

- 5 حجم القطر (اسمي)
6 عرض الحلقة
7 التصميم والشكل الجانبي للحلقة
8 طلاء ومزايا الحلقة
9 كود المادة

- 1 معلومات الطراز
2 معلومات المحرك
3 رقم اللوحة
4 حجم ومرجع مجموعة الحلقة

4 جدول الأحجام الزائدة للحلقات

إمبريالي	متري	الحجم
	STD	00
	0.125 مم	03
	0.20 مم	04
010.	0.25 مم	05
	0.40 مم	06
020.	0.50 مم	07
	0.60 مم	08
030.	0.75 مم	09
	0.80 مم	10
040.	1.00 مم	11
060.	1.50 مم	14
090.	2.286 مم	17
	0.70 مم	20
	0.65 مم	21
	0.30 مم	22

4 نظام ترقيم القطع

حلقات الكباس

مرجع الكتالوج	00 - 114900 - 08
المرجع	00 - 114900 - 08
الحجم (راجع جدول الأحجام الزائدة للحلقات)	00 - 114900 - 08
إصدار	00 - 114900 - 08

9 أكواد المواد

الوصف	كود المادة
حديد زهري كربيدي	F12/F14
حديد زهري رمادي غير معالج بالحرارة	GOE 12
حديد زهري جرافيتي من رقائق غير مسبوكة وغير معالجة بالحرارة	GOE13
حديد زهر رمادي	IKA
حديد زهر لدن	KV1
صلب	ST
حديد زهري	STD
حديد زهري جرافيتي كروي الشكل	KV4

7 الأقسام المستعرضة لحلقات الكباس

المقطع العرضي	الوصف	الرقم
	حلقة ضغط بسيطة	001
	حلقة مستدقة	005
	الحلقة المستدقة بشكل طفيف	006
	حلقة ضغط من نوع الإسفين	007
	حلقة ضغط من النوع المرتكز	008
	حلقة مرتكز ذات وجه مستدق	009
	كاشطة منفردة الخطاف	023
	كاشطة منفردة الخطاف مستدقة	026
	حلقة كاشطة الزيت المثقوبة	030
	حلقة تحكم زيت مشطوفة الحافة	031
	حلقة تحكم زيت مشطوفة الحافة مزدوجة	032
	حلقة كاشطة الزيت المثقوبة	036
	حلقة كاشطة الزيت المثقوبة مع ياي ملفوف	230
	حلقة تحكم زيت مشطوفة الحافة مع ياي ملفوف	231/241
	حلقة تحكم زيت مشطوفة الحافة مزدوجة مع ياي ملفوف	232
	كاشطة الزيت المثقوبة مع ياي ملفوف	236
	حلقة تحكم زيت صلبة مع ياي VF	712

8 مميزات الحلقة

المقطع العرضي	الوصف	الرمز
	الشفة الداخلية - الجانب العلوي	IF
	الشفة الداخلية - الجانب السفلي	IFU
	الدرج الداخلي - الجانب العلوي	IW
	الدرج الداخلي - الجانب السفلي	IWU
	حلقة مستدقة	LKZ

8 أكواد المعالجة والأغطية

الوصف	الكود والنوع	الوصف	الكود والنوع
مصنوع من الفوسفات	P	مطلي بالكروم	CR
مصنوع من النتريد	NT	مرصع بالموليبدينوم	MO
مغطى برشاش البلازما	PS	مكسو بالموليبدينوم	MOL
ذو غطاء ماس Goetze	GDC	مكسو بالسيراميك - الكروميوم	CK
الماس مثل الكربون	DLC	كروم نيتريد	PVD

أغطية الوجه أثناء التشغيل

CR غطاء الكروم

يجمع غطاء الكروم الصلب المرسب بالكهرباء بين المقاومة الممتازة ضد التآكل والمقاومة العالية للخدش. وهذا هو سر تفوق الحلقات المطلية بالكروم على الحلقات غير المطلية والأسطح المعالجة بالحلقات.

MOL و MO أغطية الموليبيديوم

لتفادي خدش الحد الخارجي يتم كسو الحلقة بالموليبيديوم، وقد أسفرت هذه العملية عن نتائج رائعة. ويحظى الموليبيديوم بنقطة زوبان عالية جدًا (2620 درجة مئوية) وقدرة توصيل جيدة للحرارة، مما يؤدي إلى وجود مقاومة عالية للخدش والتحرز.

PS غطاء رشاش البلازما

يتم استخدام عملية التغطية برشاش البلازما التي تشتمل على مقاومة عالية ضد التآكل والخدش والانفجار وكذلك قوة متلازمة عالية وهي تتسبب في تآكل محدود للأسطوانة لذا يتم استخدامها حاليًا بنجاح في عمليات الإنتاج.

P الطلاء بالفوسفات

يتم إجراء هذه العملية من أجل تسريع وتحسين انطباق الحلقات. ويتحول سطح الحلقة بفعل المعالجة الكيميائية إلى بلورات الفوسفات.

NT الطلاء بالنيتريد

تتم معالجة السطح بالنيتريد لتقليل تآكل حلقات ضغط الصلب وشرايط الصلب في حلقات التحكم في الزيت.

CK أغطية السيراميك - الكروميوم

تتحمل أغطية CK أحمال ميكانيكية وحرارية عالية أكثر من أغطية البلازما والموليبيديوم والكروم الحالي، وبرغم ذلك تم تجربتها واختبارها وتبين عدم فقدها لأي من مزاياها.

GDC غطاء الحلقة المقواة بالماس GOETZE

يتم دمج ماس فائق النقاء مع مواد خاصة وخصائص متنوعة وأبعاد نانومتر في سطح تشغيل الكروميوم الصلب. ويمتاز سطح تشغيل حلقة GDC بأقل معدلات تآكل للحلقة وأكبر مقاومة للخدش مقارنة بالأغطية الأخرى.

متطلبات ووظيفة حلقات الكباس

الوظيفة الأساسية لحلقات الكباس هي توفير سدادة: لضمان بقاء الحرارة والضغط المتولدين أثناء عملية الاحتراق داخل غرفة الاحتراق وعدم مرور الزيت داخل غرفة الاحتراق. وبالإضافة إلى ذلك، ينبغي أيضًا أن تقوم الحلقة بإبعاد الحرارة عن الكباس وتنظم عملية التشحيم والتزييت.

تصميم أشكال معيار قطع غيار حلقات الكباس التي تصنعها GOETZE

يتم تركيب حلقات كباس GOETZE باعتبارها معدات أصلية لمحركات الاحتراق الداخلي والضاغطات في خطوط الإنتاج في جميع أنحاء العالم. من خلال التعاون الدائم بين إدارات التصميم والاختبار تقدم كل جهة تصنيع محرك أو مركبة وكذلك أعمال التطوير والاختبارات التي تُجرى في مختبراتنا البحثية معلومات شاملة يمكن استخدامها في جميع المحركات تقريبًا. وتعد معارفنا وخبرتنا التي اكتسبناها على مر عقود من الزمان قضيناها في مجال قطع غيار حلقات الكباس هي أساس التصميم الفردي لكل مجموعة من قطع غيار الحلقات.

ويرتكز التصميم في الأساس على المواد التي تصنع منها حلقات الكباس ودهانات للوجه التي أثبتت نفسها مجال استخدام المعدات الأصلية.

تتكون مجموعة الحلقة بشكل عام من ثلاث حلقات:

حلقة الضغط العلوية - تصنع في الغالب من الصلب والحديد الدن وحديد الزهر، تعمل هذه الحلقات على سد مزيج الوقود/الهواء في غرفة الاحتراق.

حلقة الضغط الثانية - تصنع عادة من الحديد الدن وحديد الزهر، هذه الحلقات ذات وظيفة مزدوجة حيث تجمع بين وظيفة حلقة الضغط وحلقة التحكم في الزيت.

حلقة التحكم في الزيت - يمكن أن تصنع من الحديد الدن وحديد الزهر، ومع ذلك يتم استخدام الصلب مع الحلقات ذات القطع المتعددة، تقوم هذه الحلقة بتنظيم كمية الزيت المطلوبة لتزييت الحلقتين العلوية والثانية.

الاتجاهات الحديثة في تكنولوجيا حلقات الكباس

تقليل اتساع الحلقة - بسبب المحركات الصغيرة ذات الكباسات الخفيفة وارتفاعات الضغط القصيرة.

تقليل عرض الحلقة - لمزيد من الثبات ولزيادة RPM (عدد دورات المحرك في الدقيقة).

تقليل ضغط الحلقة - بسبب مطالب تقليل فاقد القدرة الاحتكاكية. الخصائص المعدنية للحلقة - الاتجاه نحو السبائك عالية القوة مثل حديد الدن والصلب من أجل تحمل درجات الحرارة العالية الناتجة عن مزيج الوقود الضعيف ووضع الحلقة العليا في الكباس لتقليل الانبعثات.

AR - كيفية استخدام هذا الكتالوج

إرشادات تركيب حلقات الكباس

قبل تركيب حلقات كباس Goetze البديلة، ينبغي تنظيف تجاويف حلقات الكباس بعناية خاصة حرصًا على عدم إتلاف نصف قطر جذر التجاويف أو الحوائط الجانبية. الحد الأقصى لخلوص محور محركات البنزين 0,13 مم وبالنسبة لكباسات الديزل 0,20 مم ينبغي دائمًا استبدال الكباسات التي بها فتحات حلقة معيبة أو تآكل شديد في المحور بقطع غيار كباسات Nural.

الحلقات الضاغطة

ينبغي تركيب حلقات الكباس باستخدام زردية حلقات الكباس والحرص على عدم فتح الحلقة أكثر من اللازم. يمكن أن ينتج عن الفتح بدرجة أكثر من اللازم تلف الحلقة وحدوث تشوه واحتمال انكسار الحلقة أثناء التشغيل. ينبغي الانتباه بشدة أثناء التجميع للعلامات العليا بحيث تتجه دائمًا ناحية تاج الكباس. تحمل جميع حلقات الضغط من Goetze علامة جهة التصنيع "GOE"، وننصح بتركيب جميع الحلقات بما في ذلك الحلقات التي لا تحمل علامات علوية مع توجيه الجانب الذي يحمل العلامة في مواجهة تاج الكباس.

حلقات زيت GOETZE مكونة من ثلاث قطع من نوع VF

حلقات التحكم في الزيت Goetze المكونة من ثلاث قطع من نوع VF هي الوحيدة التي لا تحمل علامة في حين يمكن تركيب العناصر الثلاثة بدون توجيه.

قم بتركيب الموسع بالفتحات أولاً مع الحرص على عدم وضع الوصلة فوق الثقوب أو الفتحات الموجودة في أسفل فتحة الحلقة. أثناء حمل طرفي الموسع معاً، ينبغي لف الشريط الصلب العلوي تجاه بداية الفتحة بزواوية يبلغ قطرها 45-90 درجة تقريباً تجاه يسار وصلة الموسع التي تعمل في اتجاه الوصلة.

ينبغي تركيب الشريط السفلي بزواوية قطرها 45-90 درجة يمين الوصلة التي تعمل في اتجاه الوصلة. لضمان استقرار الحلقات بشكل صحيح بعد إصلاح المحرك، ننصح بتشغيل المحرك لمسافة 300 - 600 ميل تقريباً ثم تغيير الزيت.

فحص عملية تركيب الحلقات

بعد تركيب الحلقات في الكباس، تأكد من حرية دورانهم داخل فتحات الحلقة. ينبغي توجيه الحلقات آنذاك مع فجوات الحلقة مع الحفاظ على فواصل مقدارها 120 درجة

ملاحظة ينبغي تركيب الحلقات المطلية بالكروم بالأسطوانة باستخدام قطر الأسطوانة المطلي بالكروم.



TERMS OF BUSINESS

EN - IMPORTANT

Reproduction of this catalogue or parts thereof is only allowed with our explicit permission in writing. Pictorial representations and design are copyrighted. Claims for damages, of any form whatsoever, resulting from details made in this catalogue or from incorrect use, application, storage or handling, are explicitly excluded. Contractual rights and any resulting or related claims based thereon, irrespective of form, initially come into being on the basis of a separate written agreement, in particular on the basis of our general terms of sale and delivery.

All former statements lose their validity with the publication of this catalogue.

The catalogue is not an operating manual for the use and installation of piston rings. It does not contain any advice in a legal sense. The catalogue neither replaces the constantly applicable technical regulations – particularly for tolerances – nor the installation and maintenance stipulations of the individual engine manufacturer.

Also, it is not possible to forego the expertise of those carrying out the installation and application. The individual references made in this catalogue for the installation and the application of piston rings are instructions solely for the technically qualified specialist and are to be checked and verified by them for their suitability in each case. Federal-Mogul accepts no responsibility for application decisions.

The contents of the catalogue are not intended to create or substitute any contractual agreement which has to be reserved exclusively to a separate agreement between 2 identified parties, whereby seller can be only one of our Federal-Mogul entities as mentioned on the inside back cover.

The right is retained to correct errors and alterations, particularly with regard to amendments in the engine manufacturers' details and stipulations.

DE - ZUR BEACHTUNG

Die Reproduktion dieses Katalogs ist nur mit unserer ausdrücklichen Genehmigung gestattet. Bildliche Darstellungen und der Entwurf sind urheberrechtlich geschützt. Schadenersatzansprüche in jedweder Form unter Berufung auf die Angaben in diesem Katalog oder infolge unsachgemäßen Gebrauchs, unsachgemäßer Anwendung, Lagerung oder Handhabung sind ausdrücklich ausgeschlossen. Vertragliche Rechte und etwaige hieraus folgende oder abgeleitete Ansprüche jedweder Art werden erst durch getrennte schriftliche Vereinbarung, im Besonderen auf der Grundlage unserer allgemeinen Verkaufs- und Lieferbedingungen, begründet. Mit Erscheinen dieses Katalogs verlieren alle früheren Angaben ihre Gültigkeit.

Der Katalog stellt keine Anleitung für den Gebrauch und den Einbau von Kolbenringsätzen dar. Es werden keine Ratschläge im rechtlichen Sinne abgegeben. Der Katalog ersetzt weder die jeweils geltenden technischen Maßgaben – insbesondere für Toleranzen – noch die Einbau- und Wartungsvorschriften des jeweiligen Motorenherstellers. Auch ist die Sachkenntnis derer, die den Einbau und die Anwendung vornehmen, eine wesentliche Größe. Die Aussagen in diesem Katalog zum Einbau und Einsatz von Kolbenringsätzen richten sich ausschließlich an den technisch versierten Fachmann und sind von Fall zu Fall auf Eignung und Gültigkeit zu überprüfen. Federal-Mogul übernimmt keine Verantwortung für Anwendungsentscheidungen.

Der Inhalt des Katalogs begründet oder ersetzt keine vertragliche Vereinbarung, welche ausschließlich einer getrennten Vereinbarung zwischen zwei bestimmten Parteien vorbehalten sein muss, in der die Verkäuferpartei eine unserer innen im Rückdeckel genannten Federal-Mogul Gesellschaften ist. Das Recht auf Berichtigung von Irrtümern und Abänderungen, insbesondere hinsichtlich geänderter Angaben und Bestimmungen der Motorenhersteller, bleibt vorbehalten.

FR - IMPORTANT

La reproduction de ce catalogue, même partielle, n'est autorisée qu'avec notre accord préalable et par écrit. Les illustrations graphiques et la présentation font l'objet d'un copyright. Nous excluons toutes réclamations ayant pour objet ce catalogue ou pouvant résulter de son incompréhension, portant sur de mauvaises utilisations, manipulations, manutentions ou mauvais stockage. Des droits contractuels et des droits dérivés, de quelque nature qu'ils soient, ne peuvent résulter que d'un accord écrit, sur la base de nos conditions générales de ventes et de livraisons. Ce catalogue annule et remplace toute édition antérieure.

Le catalogue n'est pas une notice d'utilisation et de montage des segments de piston. Il ne contient pas de directives en tant que telles. Le catalogue ne remplace ni les prescriptions techniques, toujours prioritaires, particulièrement pour les tolérances, ni les prescriptions de montage et d'entretien des fabricants des moteurs figurant dans ce catalogue. Il ne peut en aucun cas remplacer les connaissances professionnelles nécessaires pour le montage et l'utilisation des produits. Les remarques données pour le montage et l'utilisation des segments de piston sont exclusivement destinées au professionnel averti et de formation technique, à qui il appartient de vérifier la conformité des indications pour chaque cas. La responsabilité quant aux décisions d'utilisation ne peut être prise en charge par Federal-Mogul.

Le contenu de ce catalogue ne peut constituer ou remplacer un contrat qui doit faire l'objet d'un document séparé établi entre 2 parties, dont l'une doit être une entité légale de Federal-Mogul (dont la liste figure sur la couverture arrière). Nous nous réservons le droit d'apporter toutes corrections d'erreurs et modifications, suite notamment à de nouvelles données fournies par les constructeurs.

ES - IMPORTANTE

Queda totalmente prohibida la reproducción, total o parcial, del contenido de este catálogo, salvo previa autorización nuestra, realizada por escrito. Están, asimismo, reservados todos los derechos sobre el diseño y presentación del catálogo. No se aceptará ningún tipo de reclamación que esté basada en la interpretación de los datos contenidos en este catálogo, así como en el incorrecto uso, manipulación o almacenaje de nuestras piezas. Únicamente se aceptarán reclamaciones que estén basadas en derechos contractuales o en los motivos arriba indicados, siempre que exista un acuerdo especial y por escrito basado en nuestras condiciones generales de venta y suministro.

Con la edición de este catálogo queda anulada toda la información contenida en catálogos anteriores. El catálogo no es un manual para el uso e instalación de los segmentos de pistón, y no representa una asesoría técnica en el sentido legal. Los datos del catálogo no sustituyen, en ningún caso, a las especificaciones técnicas, tanto en lo que se refiere a tolerancias como a las instrucciones de instalación y mantenimiento, indicadas por los fabricantes de los motores, especificaciones que serán siempre prioritarias. Se entiende que el uso y montaje de estas piezas está encomendado a personal debidamente cualificado. Las indicaciones sobre uso y montaje de los segmentos de pistón, contenidas en este catálogo, están exclusivamente dirigidas a profesionales con la debida capacitación y formación técnica, que deben decidir en cada caso sobre la exactitud de las mismas. La responsabilidad de estas decisiones no puede ser, en ningún caso atribuidas a Federal-Mogul.

La información facilitada en el catálogo no representa o sustituye ningún tipo de acuerdo, quedando a tal efecto, el acuerdo por separado entre dos partes donde sólo entidades de Federal-Mogul, pueden ser identificadas como la parte vendedora como se menciona en la contraportada.

Los datos e instrucciones contenidos en este catálogo podrán ser corregidos o modificados sin previo aviso.

TERMS OF BUSINESS

PL - WAŻNE

Reprodukcja tego katalogu lub jego części jest możliwa tylko za wyraźną zgodą na piśmie. Ilustracje i grafika są chronione prawem autorskim. Roszczenia dotyczące szkód, niezależnie od formy, wynikających z przedstawionych w tym katalogu treści lub z nieprawidłowego użycia, zastosowania, przechowywania lub obsługi są w sposób wyraźny wyłączone. Prawa umowne i inne wynikające lub związane z roszczeniami na nimi opartymi, niezależnie od formy, są tworzone na podstawie oddzielnej umowy pisemnej, w szczególności na podstawie naszych ogólnych warunków sprzedaży i dostawy.

Wszystkie wcześniejsze oświadczenia tracą ważność wraz z opublikowaniem tego katalogu.

Katalog nie jest instrukcją obsługi i instalacji pierścieni tłokowych. Nie zawiera porad w sensie prawnym. Katalog nie zastępuje obowiązujących uregulowań technicznych – zwłaszcza w zakresie tolerancji – ani opisów montażu i konserwacji poszczególnych producentów silników.

Nie jest również możliwe pominięcie doświadczenia osób dokonujących doboru i przeprowadzających montaż części. Poszczególne informacje zawarte w tym katalogu, a dotyczące doboru, montażu i stosowania pierścieni tłokowych, są instrukcjami wyłącznie dla wykwalifikowanego technicznie specjalisty, który w każdym przypadku musi je sprawdzić i zweryfikować ich przydatność. Federal-Mogul nie przyjmuje odpowiedzialności za decyzje dotyczące zastosowania.

Zawartość tego katalogu nie stanowi ani nie zastępuje umowy, która może być zawarta jedynie jako oddzielny dokument podpisany przez dwie strony, przy czym sprzedawcą może być tylko jedna z jednostek koncernu Federal-Mogul, zgodnie z opisem na wewnętrznej stronie tylnej okładki.

Zachowane zostaje prawo korygowania błędów i wprowadzania zmian, zwłaszcza odnośnie zmian dotyczących parametrów i warunków pracy określonych przez producentów silników.

Pomimo tego, że dokonujemy wszelkich starań przy korzystaniu z najbardziej aktualnych informacji dotyczących tak szerokich zakresów modeli pojazdów i silników występujących na rynku, nie możemy zagwarantować, że nasz program dostaw pokryje potrzeby wszystkich występujących wersji silników. Ponadto, nie ma żadnego zabezpieczenia przed nieujawnionymi zmianami wprowadzanymi w trakcie produkcji przez producentów silników lub przed zmianami, które dotarły do nas już po przekazaniu danych do druku. Dlatego nie możemy zaakceptować żadnej odpowiedzialności dotyczącej nieścisłości informacji zawartych w tym katalogu. Jest niezbędnym, by przed montażem jakiegokolwiek z naszych produktów dokładnie sprawdzić czy oferowana część jest odpowiednia dla konkretnego zastosowania. By ułatwić Państwu korzystanie z katalogu, dostarczamy specyfikacje materiałów użytych do wytworzenia naszych produktów oraz ich wymiary. W przypadku jakichkolwiek wątpliwości prosimy o kontakt z producentem silnika. Dla Państwa własnej korzyści prosimy pamiętać, że montaż niewłaściwych części może spowodować uszkodzenie silnika, za który to Państwo, jako wykonujący remont, jesteście odpowiedzialni przed swoimi klientami.

RU - ВАЖНО

Воспроизводство данного каталога или ее частей позволено только с нашим явным разрешением в письменной форме. Иллюстрации и дизайн защищены авторским правом.

Требования о возмещении ущерба, любой формы, исходя из содержания каталога или от неправильного использования, хранения или обращения, явно исключены. Договорные права и любые связанные требования базировались вслед за тем, независимо от формы, отдельного первоначально письменного соглашения, в особенности на основе наших общих условий продаж и поставок.

Все прежние утверждения теряют свою юридическую силу с публикацией данного каталога. Каталог не операционное руководство для использования и установки поршневых колец. Оно не содержит совета в юридическом смысле. Каталог не заменяет постоянно применимые технические инструкции – особенно при допусках – соглашения установки и обслуживания живания отдельного автопроизводителя. Кроме того, не возможно предсказать профессионализм тех, кто выполняет установку и ремонт.

Отдельные ссылки, сделанные в этом каталоге для установки и замены поршневых колец являются инструкциями исключительно для технически компетентного специалиста и должны быть проверены ими для их пригодности в каждом случае. Federal-Mogul не несет ответственность за ремонтные работы. Содержание каталога не предназначено, чтобы создавать или заменять любые договорные соглашения, которое должны быть сохранены исключительно к отдельному соглашению между 2мя сторонами, посредством чего продавец может быть только одним из юридических лиц Federal-Mogul как упомянуто на странице обратной стороны.

Сохраняется право, исправлять ошибки и изменения, особенно относительно к поправкам по деталям изготовителей двигателя и их условиям. Мы делаем все возможное, чтобы использовать новейшую информацию, однако, учитывая огромный ассортимент моделей автомобилей и двигателей на рынке, мы не можем гарантировать, что наша программа поставки продукции покрывает абсолютно все модификации двигателей. Кроме того, производители двигателей на этапе производства могут вносить в конструкцию изменения, о которых нам неизвестно или становится известно после опубликования информации в прессе. Поэтому мы не несем ответственность за точность информации в данном каталоге. Настоятельно рекомендуется перед установкой любой нашей продукции проверить пригодность детали из каталога для конкретного назначения. Чтобы помочь в этом, мы приводим спецификации материалов, использованных для производства, и размеры изделий. При возникновении сомнений обратитесь к изготовителю двигателя. Помните, что установка неподходящих запасных частей может привести к повреждению двигателя, за которое вы как ремонтное предприятие будете нести ответственность перед вашими клиентами.

AR - هام



لا يُسمح بنسخ هذا الدليل أو أي جزء منه إلا بتصريح كتابي صريح. جميع التمثيلات التصويرية والتصميمات محفوظة بموجب حقوق النشر، ولا تتحمل الشركة صراحة أي مطالبات بخسائر، أيًا كانت صورتها، تنشأ عن التفاصيل الواردة في هذا الدليل أو نتيجة لسوء الاستخدام أو التطبيق أو التخزين أو النقل. أي حقوق تعاقدية أو أي مطالبات لها علاقة بتلك الحقوق أو تنشأ تأسيسًا عليها، بغض النظر عن صورتها، تنشأ تأسيسًا على اتفاق كتابي منفصل، وبخاصة تأسيسًا على شروط البيع والتسليم الخاصة بنا. تفقد كل البيانات السابقة صلاحيتها بمجرد نشر هذا الدليل.





هذا الدليل ليس دليلًا للتشغيل لتوضيح استخدام وتركيب المكابس أو البطانة أو التجميع. كما لا يحتوي على أي نصيحة بالمعنى القانوني، ولا يحل هذا الدليل محل القواعد الفنية المطبقة باستمرار خاصة فيما يتعلق بالحمل، كما لا يحل محل شروط التركيب والصيانة الخاصة بمصنعي المحركات الفردية. كذلك لا يمكن الاستغناء عن خبرة الفنيين الذين يقومون بالتركيب أو التطبيق. وجميع الإشارات الواردة في هذا الدليل والتي تتعلق بتركيب وتطبيق المكابس والبطانة وعمليات التجميع هي إرشادات للمتخصصين الفنيين المؤهلين فحسب ويتم مراجعتها والتأكد من ملاءمتها في كل حالة على حدة. ولا تتحمل شركة Federal-Mogul أي مسؤولية تتعلق بقرارات التطبيق.

ليس المقصود بمحتوى هذا الدليل أن يخلق أو يستبدل أي اتفاقات تعاقدية يتم الاحتفاظ بها حصريًا في اتفاقية منفصلة بين طرفين محددتين، والتي يمكن أن يكون بموجبها أحد الكيانات التابعة لشركة Federal-Mogul هو الطرف البائع كما هو موضح في الوجه الداخلي للغلاف الخارجي. وتحتفظ الشركة بحقها في تصحيح أي أخطاء وإجراء أي تعديلات وبخاصة فيما يتعلق بتعديل تفاصيل مصنع المحرك والأحكام المنصوص عليها.

NEW PARTS LIST



Numerische Teilenummernliste • Liste des références produits
Lista de nuevas referencias



								9	
08-103007-00	0.50mm	AUDI	AFB, AKE, AKN, AYM, BAU, BCZ, BDG, BDH, BFC	62	11				
		SKODA	AYM, BDG	1008	12				
		VOLKSWAGEN	AFB, AKN, BAU, BDG, BDH	1173	20				
08-104107-00	0.50mm	NISSAN	D4F 712	680	2				
			D7F 764	680	3				
		RENAULT	D7F 700, D7F 701, D7F 702, D7F 703, D7F 704, D7F 706, D7F 710, D7F 720, D7F 722, D7F 726, D7F 730, D7F 744, D7F 746, D7F 764, D7F 766 Euro 4	871	4				
08-107100-10	STD	ALFA ROMEO	116 (33), AR 01623, AR 01655, AR 06212, AR 10520, AR 11671	22	24				
08-114400-45	STD	BMW	M47 N20404 Euro 4	127	13				
08-119005-00	0.25mm	MERCEDES-BENZ	M 112.920, M 112.921, M 112.922, M 112.923, M 112.925, M 112.940, M 112.941, M 112.942, M 112.943, M 112.944, M 112.945, M 112.946, M 112.947, M 112.949, M 113.940, M 113.941, M 113.942, M 113.943, M 113.944	603	36				
08-119007-00	0.50mm	MERCEDES-BENZ	M 112.920, M 112.921, M 112.922, M 112.923, M 112.925, M 112.940, M 112.941, M 112.942, M 112.943, M 112.944, M 112.945, M 112.946, M 112.947, M 112.949, M 113.940, M 113.941, M 113.942, M 113.943, M 113.944	603	36				
08-123400-30	STD	RENAULT	K9K 608, K9K 612, K9K 636 Euro 5, K9K 716, K9K 732 Euro 4, K9K 764 Euro 4, K9K 770, K9K 772, K9K 780 Euro 4, K9K 782, K9K 800, K9K 804 Euro 4, K9K 806 Euro 4 (FAP), K9K 808, K9K 812, K9K 820, K9K 830, K9K 832 Euro 4, K9K 834, K9K 836, K9K 837 Euro 5, K9K 840, K9K 846 Euro 5, K9K 884 Euro 5, K9K F 830, K9K G 832, K9K H 834, K9K J 836, K9K N 837, K9K P 732	882	14				
08-123407-30	0.50mm	RENAULT	K9K 608, K9K 612, K9K 636 Euro 5, K9K 716, K9K 732 Euro 4, K9K 764 Euro 4, K9K 770, K9K 772, K9K 780 Euro 4, K9K 782, K9K 800, K9K 804 Euro 4, K9K 806 Euro 4 (FAP), K9K 808, K9K 812, K9K 820, K9K 830, K9K 832 Euro 4, K9K 834, K9K 836, K9K 837 Euro 5, K9K 840, K9K 846 Euro 5, K9K 884 Euro 5, K9K F 830, K9K G 832, K9K H 834, K9K J 836, K9K N 837, K9K P 732	882	14				
08-135500-10	STD	RENAULT TRUCKS	dCi 11-270 Euro 3, dCi 11C Euro 3, dCi 11E Euro 3, dCi 11G Euro 3, MIDR 06.23.56 A/3 Euro 2, MIDR 06.23.56 A/41 Euro 2, MIDR 06.23.56 B/41 Euro 2	935	15				
08-136400-10	STD	MERCEDES-BENZ	OM 646.811, OM 646.812, OM 646.820, OM 646.821, OM 646.966, OM 646.984, OM 646.990	593	27				
08-138006-00	0.40mm	FIAT	F1AE 0481 C Euro 3, F1AE0481D Euro 4, F1AE0481N, F1AE0481T	291	62				
		IVECO	F1AE 0481 A Euro 3, F1AE 0481 B Euro 3, F1AE 0481 C Euro 3, F1AE 0481 FA Euro 4, F1AE0481F Euro 4, F1AE 0481 GA Euro 4, F1AE0481G Euro 4, F1AE 0481 HA Euro 4, F1AE0481H Euro 4, F1AE 0481 M (HPI), F1AE0481R Euro 4	415	3				
08-139407-00	0.50mm	CITROEN	TU5J4 (NFX), TU5JP4 (N6A), TU5JP4 (NFU/N6A)	174	20				
		PEUGEOT	TU5J4 (NFX), TU5JP4 (NFU/N6A)	791	21				
08-142107-00	0.50mm	DEUTZ / KHD	BF 3L 2011, BF 3M 2011, BF 4L 2011, BF 4M 2011	222	6				
08-144207-00	0.50mm	OPEL	Z 14 XE	723	14				
		VAUXHALL	Z 14 XE	1090	15				
08-145007-00	0.50mm	CUMMINS	6 BT5.9, 6 BTA	198	2				
		DAF	6 BT5.9, 6 BTA, BE 99 C Euro 3, BE 110 C Euro 3, CE 136 C Euro 3, CE 162 C Euro 3, CE 184 C Euro 3	208	7				
		IVECO	F4AE 0481 A Euro 3 (Tector E17), F4AE 0481 C Euro 3 (Tector E15), F4AE 0481 D Euro 3 (Tector E13), F4AE 0681 A Euro 3 (Tector E28), F4AE 0681 B Euro 3 (Tector E24), F4AE0681C Euro 3 (Tector E24), F4AE 0681 D Euro 3 (Tector E21), F4AE 0681 E Euro 3 (Tector E18)	422	18				
08-288000-10	STD	MITSUBISHI	4 D 55, 4 D 56 (8V)	654	9				
08-288007-10	0.50mm	MITSUBISHI	4 D 55, 4 D 56 (8V)	654	9				
08-288307-00	0.50mm	MITSUBISHI	4D34-1ATA Euro 2, 4D34-T, 4D34-TL	656	14				
08-422207-00	0.50mm	BMW	M54 226S1, M54 B22	123	5				
08-423407-00	0.50mm	FORD EUROPE	A0DA, A0DB, A0WA, CJB4 (Duratec HE), CJB8 (Duratec HE), GZ, N4JB (Duratec ST)	363	41				
		MAZDA	L3C1, LF17, LF18, LFF7	542	12				
		VOLVO	B 4204 S3	1233	18				
08-424007-00	0.50mm	CITROEN	DV6ATED4 (9HX) Euro 4, DV6TED4 (9HY), DV6TED4 (9HZ) Euro 4, DV6UTED4 (9HU)	169	12				
		FIAT	9HU	268	18				
		FORD EUROPE	G8DA (Duratorq), G8DB (Duratorq), HHDA Euro 4, HHDB Euro 4, HHJA (Duratorq), HHJB (Duratorq), HHJC (Duratorq TDCI), HHJD (Duratorq TDCI), HHJE (Duratorq TDCI), UBJA (Duratorq TDCI)	336	7				
		MAZDA	Y601	539	3				
		MINI	9HZ (DV6TED4)	648	2				
		PEUGEOT	DV6ATED4 (9HV), DV6ATED4 (9HX) Euro 4, DV6TED4 (9HY) Euro 4, DV6TED4 (9HZ) Euro 4, DV6UTED4 (9HU)	785	10				
08-425608-00	0.60mm	SUZUKI	9HX Euro 4	1032	8				
		FIAT	199 A3.000	262	7				
		LANCIA	199 A3.000	465	4				
		OPEL	Z 13 DTH, Z 13 DTJ	717	3				
		SUZUKI	Z13DTJ Euro 4	1031	5				
VAUXHALL	Z 13 DTH, Z 13 DTJ	1086	4						
08-425707-00	0.50mm	BMW	N45 B16, N45 B16A, N46 B20, N46 B20A, N46 B20B, N46 B20BD, N46 B20C, N46 B20CC, N46 B20CD, N46 NB20B	133	26				
08-426107-00	0.50mm	FORD EUROPE	ASDA, ASDB, SPJA (Duratec)	338	9				
		MAZDA	FXJA	540	4				
08-426300-00	STD	CITROEN	TU1JP (HFX)	166	4				
		PEUGEOT	TU1JP (HFX), TU1JP (HFZ)	783	6				
		ZASTAVA	TU1JP	1262	3				
08-426500-00	STD	TOYOTA	1SZ-FE	1051	1				
08-426507-00	0.50mm	TOYOTA	1SZ-FE	1051	1				
08-426600-00	STD	TOYOTA	1CD-FTV	1059	19				

								9	
08-426607-00	0.50mm	TOYOTA		1CD-FTV			1059		19
08-426700-00	STD	LOTUS		1ZZ-FE			502		1
		TOYOTA		1ZZ-FE, 3ZZ-FE			1056		14
08-426707-00	0.50mm	LOTUS		1ZZ-FE			502		1
		TOYOTA		1ZZ-FE, 3ZZ-FE			1056		14
08-426800-00	STD	DAEWOO		F8CV			204		1
08-426807-00	0.50mm	DAEWOO		F8CV			204		1
08-427100-00	STD	SMART		M 160.910, M160.921, M 160.922, M 160.923			1018		3
08-427105-00	0.25mm	SMART		M 160.910, M160.921, M 160.922, M 160.923			1018		3
08-427107-00	0.50mm	SMART		M 160.910, M160.921, M 160.922, M 160.923			1018		3
08-427300-00	STD	BMW		N52 B30, N52 B30A, N52 B30AF, N52 B30B, N52 B30BF, N52 NB30A, N53 B30, N53 B30A			136		30
08-427400-00	STD	MERCEDES-BENZ		OM 642.820, OM 642.822, OM 642.830, OM 642.832, OM 642.834, OM 642.836, OM 642.850, OM 642.852, OM 642.853, OM 642.854 (OM 642 LS DE 30 LA), OM 642.856, OM 642.858, OM 642.862, OM 642.868, OM 642.870, OM 642.872, OM 642.884, OM 642.886, OM 642.896, OM 642.898, OM 642.910, OM 642.920, OM 642.921, OM 642.930, OM 642.932, OM 642.940, OM 642.950, OM 642.960, OM 642.961, OM 642.970, OM 642.990, OM 642.992, OM 642.993			576		10
08-427407-00	0.50mm	MERCEDES-BENZ		OM 642.820, OM 642.822, OM 642.830, OM 642.832, OM 642.834, OM 642.836, OM 642.850, OM 642.852, OM 642.853, OM 642.854 (OM 642 LS DE 30 LA), OM 642.856, OM 642.858, OM 642.862, OM 642.868, OM 642.870, OM 642.872, OM 642.884, OM 642.886, OM 642.896, OM 642.898, OM 642.910, OM 642.920, OM 642.921, OM 642.930, OM 642.932, OM 642.940, OM 642.950, OM 642.960, OM 642.961, OM 642.970, OM 642.990, OM 642.992, OM 642.993			576		10
08-427500-00	STD	MERCEDES-BENZ		OM 639.939 Euro 4, OM 640.940, OM 640.941, OM 640.942			575		9
		MINIBUS		OM 639.939 Euro 4			653		7
		SMART		OM 639.939 Euro 4			1019		4
08-427507-00	0.50mm	MERCEDES-BENZ		OM 639.939 Euro 4, OM 640.940, OM 640.941, OM 640.942			575		9
		MINIBUS		OM 639.939 Euro 4			653		7
		SMART		OM 639.939 Euro 4			1019		4
08-427700-00	STD	CITROEN		P22DTE (4HU) Euro 4, P22DTE (4HV) Euro 4			184		38
		FIAT		4HV Euro 4			288		55
		FORD EUROPE		P8FA, P8FB, PGFA, PGFB, QJBA (Duratorq), QJBB (Duratorq), QJBC (Duratorq), QJBD (Duratorq), QVFA, QWFA			362		38
		JAGUAR		LJ466, QJBA (Duratorq TDCI)			441		5
		PEUGEOT		4HU Euro 4, 4HV Euro 4			802		41
08-427707-00	0.50mm	CITROEN		P22DTE (4HU) Euro 4, P22DTE (4HV) Euro 4			184		38
		FIAT		4HV Euro 4			288		55
		FORD EUROPE		P8FA, P8FB, PGFA, PGFB, QJBA (Duratorq), QJBB (Duratorq), QJBC (Duratorq), QJBD (Duratorq), QVFA, QWFA			362		38
		JAGUAR		LJ466, QJBA (Duratorq TDCI)			441		5
		PEUGEOT		4HU Euro 4, 4HV Euro 4			802		41
08-427800-00	STD	OPEL		Z 16 XEP			728		23
		VAUXHALL		Z 16 XEP			1094		24
08-427807-00	0.50mm	OPEL		Z 16 XEP			728		23
		VAUXHALL		Z 16 XEP			1094		24
08-427900-00	STD	IVECO		F4AE3481A Euro 4/5 (Tector E18), F4AE3481B Euro 4/5 (Tector E18), F4AE3481C Euro 4/5 (Tector E14), F4AE3481D Euro 4/5 (Tector E16), F4AE3681A Euro 4/5 (Tector E30), F4AE3681B Euro 4/5 (Tector E22), F4AE3681C Euro 4/5 (Tector E22), F4AE3681D Euro 4/5 (Tector E25), F4AE3681E Euro 4/5 (Tector E28)			423		19
08-428000-00	STD	IVECO		F3B3681A Euro 4/5 (Cursor 13 E 56), F3B3681B Euro 4/5 (Cursor 13 E 50), F3B3681C Euro 4/5 (Cursor 13 E 45), F3B3681D Euro 4/5 (Cursor 13 E 41), F3B3681E Euro 4/5 (Cursor 13 E 48), F3B3681G Euro 4/5 (Cursor 13 E 44), F3BE3681A Euro 4/5, F3BE3681B Euro 4/5 (Cursor 13 E 50), F3BE3681C Euro 4/5 (Cursor 13 E 45), F3BE3681D Euro 4/5, F3BE3681E Euro 4/5, F3BE3681F Euro 4/5, F3BE3681G Euro 4/5			434		46
08-428100-00	STD	FORD EUROPE		HWDA, HWDB, HXDA, HXDB (Duratec Ti-VCT), HXJA (Duratec Ti-VCT), RHBA, SIDA (Duratec Ti-VCT)			343		15
08-428200-00	STD	PORSCHE		M 46.20, M 46.40, M 48.02, M 48.20, M 48.40			822		18
08-428300-00	STD	TOYOTA		4A-FE			1058		17
08-428307-00	0.50mm	TOYOTA		4A-FE			1058		17
08-428400-00	STD	TOYOTA		4E-FE			1053		9
08-428407-00	0.50mm	TOYOTA		4E-FE			1053		9
08-428500-00	STD	PORSCHE		M 96.03, M 96.05			823		20
08-428600-00	STD	MAN		D 2066 LF17 Euro 5, D 2066 LF18 Euro 5, D 2066 LF19 Euro 5, D 2066 LF20 Euro 5, D 2066 LF21 Euro 5, D 2066 LF22 Euro 5, D 2066 LF23 Euro 5, D 2066 LF24 Euro 5, D 2066 LF25 Euro 5, D 2066 LF26 Euro 5, D 2066 LF27 Euro 5, D 2066 LF40 Euro 5, D 2066 LF41 Euro 5, D 2066 LF42 Euro 5, D 2066 LF43 Euro 5, D 2066 LF44 Euro 5, D 2066 LF45 Euro 5, D 2066 LF46 Euro 5, D 2066 LF47 Euro 5, D 2066 LF51 Euro 5, D 2066 LF52 Euro 5, D 2066 LF53 Euro 5, D 2066 LOH28 Euro 5, D 2066 LUH 32 Euro 5, D 2066 LUH 33 Euro 5, D 2066 LUH 34 Euro 5			524		13
08-428700-00	STD	MERCEDES-BENZ		OM 646.980, OM 646.981, OM 646.985, OM 646.986 Euro 4, OM 646.989			595		29
08-428707-00	0.50mm	MERCEDES-BENZ		OM 646.980, OM 646.981, OM 646.985, OM 646.986 Euro 4, OM 646.989			595		29
08-428800-00	STD	IVECO		F2CE0681A (Cursor 9), F2CE0682A (Cursor 9), F2CE0683A (Cursor 9), F2CE0684A (Cursor 9)			430		34
08-429100-00	STD	MAN		E 0824 E 301, E 0826 E 301, E 0834 E 302, E 0834 E 312, E 0836 E 302, E 0836 E 312			522		8

NEW PARTS LIST



Nummerische Teilenummernliste • Liste des références produits
Lista de nuevas referencias





					9
08-429200-00	STD	LDV	R 425, VM39C, VM40C	489	5
		VM	R 425 DOHC	1111	3
08-429300-00	STD	ALFA ROMEO	198 A2.000, 955 A3.000 Euro 5	14	9
		CHRYSLER	198 A2.000 (Multijet)	146	4
		FIAT	198 A2.000, 955 A3.000 Euro 5	270	23
		LANCIA	198 A2.000, 844 A3.000 (Multijet)	467	12
08-429400-00	STD	FORD EUROPE	CG8A (Duratec HE), CG8B (Duratec HE), CH8A, CH8B, CSDA (Duratec HE), CSDB (Duratec HE), Q7DA (Duratec HE), QQDA (Duratec HE), QQDB (Duratec HE)	356	30
08-429407-00	0.50mm	FORD EUROPE	CG8A (Duratec HE), CG8B (Duratec HE), CH8A, CH8B, CSDA (Duratec HE), CSDB (Duratec HE), Q7DA (Duratec HE), QQDA (Duratec HE), QQDB (Duratec HE)	356	30
08-429500-00	STD	OPEL	Z 10 XEP, Z 12 XEP, Z 14 XEP	720	10
		SUZUKI	Z 10 XEP, Z 12 XEP	1032	6
		VAUXHALL	Z 10 XEP, Z 12 XEP, Z 14 XEP	1088	11
08-429507-00	0.50mm	OPEL	Z 10 XEP, Z 12 XEP, Z 14 XEP	720	10
		SUZUKI	Z 10 XEP, Z 12 XEP	1032	6
		VAUXHALL	Z 10 XEP, Z 12 XEP, Z 14 XEP	1088	11
08-429600-00		RENAULT TRUCKS	MIDR 06.24.65 A/42 Euro 2, MIDR 06.24.65 B/42 Euro 2, MIDR 06.24.65 C/42 Euro 2	935	17
08-429800-00	STD	BMW	N42 B18	132	25
08-429900-00	STD	AUDI	BLF, BLP, CAXA, CAXC, CMSA, CNVA	60	7
		SEAT	CAXA, CAXC	983	13
		SKODA	BLF, CAXA, CAXC	1008	10
		VOLKSWAGEN	BLF, BLP, CAXA, CMSB	1170	17
08-429907-00	0.50mm	AUDI	BLF, BLP, CAXA, CAXC, CMSA, CNVA	60	7
		SEAT	CAXA, CAXC	983	13
		SKODA	BLF, CAXA, CAXC	1008	10
		VOLKSWAGEN	BLF, BLP, CAXA, CMSB	1170	17
08-430000-00	STD	DEUTZ / KHD	TCD 2013 L4 4V Euro 4, TCD 2013 L6 4V Euro 4	229	27
		RENAULT TRUCKS	DXi 5, DXi 7	932	10
		VOLVO COMMERCIAL	D7E240 Euro 4, D7E280 Euro 4, D7E290 Euro 4, D7E320 Euro 4	1248	16
08-431000-00	STD	MAN	D 2676 LF01 Euro 4, D 2676 LF05 Euro 4, D 2676 LF13 Euro 5, D 2676 LF14 Euro 5, D 2676 LF15 Euro 5, D 2676 LF16 Euro 5, D 2676 LOH01 Euro 4, D 2676 LOH02 Euro 4, D 2676 LOH03 Euro 4, D 2676 LOH04 Euro 4, D 2676 LOH10 Euro 3	528	21
		IVECO	F2BE3681A Euro 4/5 (Cursor 8 E 36), F2BE3681B Euro 4/5 (Cursor 8 E 33), F2BE3681C Euro 4/5 (Cursor 8 E 31)	429	33
08-431200-00	STD	PORSCHE	M 48.50S	820	12
08-431300-00	STD	VOLVO COMMERCIAL	TD 102 F, TD 102 FAO, TD 102 FBQ, TD 102 FCQ, TD 102 FD Euro 1, TD 102 FDO, TD 102 FEQ, TD 102 F6Q, TD 102 FS, TD 102 FT	1252	23
08-431400-00	STD	PORSCHE	M 96.01, M 96.02, M 96.04	822	19
08-431600-00	STD	MAN	E 0836 LE 202	522	9
08-431700-00	STD	HYUNDAI	D4CB Euro 4	392	8
		KIA	D4CB Euro 4	450	8
08-431707-00	0.50mm	HYUNDAI	D4CB Euro 4	392	8
		KIA	D4CB Euro 4	450	8
08-431800-00	STD	KIA	J2	450	9
08-431807-00	0.50mm	KIA	J2	450	9
08-431900-00	STD	HYUNDAI	D3EA, D4EA	391	7
		KIA	D4EA Euro 3	449	5
08-431907-00	0.50mm	HYUNDAI	D3EA, D4EA	391	7
		KIA	D4EA Euro 3	449	5
08-432200-00	STD	BMW	N47 D2 A, N47 D20B, N47 D20C, N47 SD20D	134	27
08-432307-00	0.50mm	AUDI	CAGA, CAGB, CAGC, CAHA, CAHB, CBAA, CBAB, CBBC, CFFA, CFFB, CFFC, CFFD, CFGB, CFGC, CFGD, CFHB, CFHD, CGLA, CGLB, CGLC, CGLD, CGLE, CJCA, CJCB, CJCC, CLJA, CLLB, CMEA, CMGA, CMGB	79	26
		SEAT	CAGA, CAGC, CAHA, CBDB, CEGA, CFFA, CFFB, CFFE, CFGB, CFGC, CFHC, CFHD, CFJA, CGLB, CJCA, CJCC, CLCB	992	27
		SKODA	CBBC, CBDB, CEGA, CFFB, CFGB, CFHA, CFHC, CFHE, CFJA, CLCA, CLCB, CLJA	1014	22
		VOLKSWAGEN	CBAA, CBAB, CBAC, CBBA, CBBC, CBDA, CBDB, CBDC, CEGA, CFFA, CFFB, CFFD, CFFE, CFGB, CFGC, CFHB, CFHC, CFHE, CFHF, CFJA, CFJB, CLCA, CLCB, CLJA, CLLA	1203	41
		CITROEN	DT17ED4, DT17TED4 (UHZ)	176	25
08-432400-00	STD	JAGUAR	AJD	440	1
		LAND ROVER	276DT Euro 4 (TDV6 2.7)	481	4
		PEUGEOT	DT17TED4	792	26
		BMW	N62 B44	140	37
08-432700-00	STD	IVECO	F4CE/GE9848 Euro 4, F4GE0404A (N45 MNA-MSA), F4GE0454A (N45 MNS-MSS), F4GE0484C (N45 MNT-MST), F4GE0484G (N45 MST), F4GE0604A (N67 MNA-MSA), F4GE0684C (N67 MNT-MST)	426	25
		MAN	E 2842 LE 322	533	27

								9	
08-432900-00	STD	AUDI	CAYB, CAYC	66	15				
		SEAT	CAYA, CAYB, CAYC, CFWA, CLNA	987	17				
		SKODA	CAYA, CAYB, CAYC, CFWA, CLNA	1011	17				
		VOLKSWAGEN	CAYA, CAYB, CAYC, CAYD, CAYE, CFWA, CLNA	1182	25				
08-432907-00	0.50mm	AUDI	CAYB, CAYC	66	15				
		SEAT	CAYA, CAYB, CAYC, CFWA, CLNA	987	17				
		SKODA	CAYA, CAYB, CAYC, CFWA, CLNA	1011	17				
		VOLKSWAGEN	CAYA, CAYB, CAYC, CAYD, CAYE, CFWA, CLNA	1182	25				
08-433000-00	STD	AUDI	BKC, BKE, BLS, BRB, BXE	65	14				
		SEAT	BJB, BKC, BLS, BLT, BMT, BPX, BTB, BUK, BVK, BXE, BXF, BXJ	986	16				
		SKODA	BJB, BKC, BLS, BLT, BSW, BXE	1010	15				
			BPZ, BSV	1011	16				
		VOLKSWAGEN	BEQ, BGG, BGL, BGM, BJC, BPZ, BTB, BXT, CDXA, CDXB	1179	23				
			BEU, BEW, BJB, BKC, BLS, BLT, BMT, BRM, BRR, BRS, BRU, BSU, BSW, BVK, BXE, BXF, BXJ	1180	24				
08-433007-00	0.50mm	AUDI	BKC, BKE, BLS, BRB, BXE	65	14				
		SEAT	BJB, BKC, BLS, BLT, BMT, BPX, BTB, BUK, BVK, BXE, BXF, BXJ	986	16				
		SKODA	BJB, BKC, BLS, BLT, BSW, BXE	1010	15				
			BPZ, BSV	1011	16				
		VOLKSWAGEN	BEQ, BGG, BGL, BGM, BJC, BPZ, BTB, BXT, CDXA, CDXB	1179	23				
			BEU, BEW, BJB, BKC, BLS, BLT, BMT, BRM, BRR, BRS, BRU, BSU, BSW, BVK, BXE, BXF, BXJ	1180	24				
08-433100-00	STD	AUDI	BMC, BTR, BVN, CAMA, CAMB, CANA, CANB, CANC, CAPA, CASA, CCLA, CCMA, CCWA, CCWB, CDYA, CDYC, CGKA, CGKB	87	34				
			CAND, CASB, CATA, CDYB	89	35				
		VOLKSWAGEN	CARB, CASA, CASC, CASD, CEXA, CJMA	1211	46				
			CASB, CATA	1212	47				
08-433105-00	0.25mm	AUDI	BMC, BTR, BVN, CAMA, CAMB, CANA, CANB, CANC, CAPA, CASA, CCLA, CCMA, CCWA, CCWB, CDYA, CDYC, CGKA, CGKB	87	34				
			CAND, CASB, CATA, CDYB	89	35				
		VOLKSWAGEN	CARB, CASA, CASC, CASD, CEXA, CJMA	1211	46				
			CASB, CATA	1212	47				
08-433107-00	0.50mm	AUDI	BMC, BTR, BVN, CAMA, CAMB, CANA, CANB, CANC, CAPA, CASA, CCLA, CCMA, CCWA, CCWB, CDYA, CDYC, CGKA, CGKB	87	34				
			CAND, CASB, CATA, CDYB	89	35				
		VOLKSWAGEN	CARB, CASA, CASC, CASD, CEXA, CJMA	1211	46				
			CASB, CATA	1212	47				
08-433200-00	STD	ALFA ROMEO	199 A6.000, 955 A1.000	12	4				
		FIAT	169 A3.000, 192 B2.000, 199 A6.000, 843 A1.000 Euro 4 (Fire)	266	13				
		LANCIA	192 B2.000, 843 A1.000	466	9				
		OPEL	A 14 FP Euro 5	718	7				
		VAUXHALL	843 A1.000	1086	7				
08-433206-00	0.40mm	ALFA ROMEO	199 A6.000, 955 A1.000	12	4				
		FIAT	169 A3.000, 192 B2.000, 199 A6.000, 843 A1.000 Euro 4 (Fire)	266	13				
		LANCIA	192 B2.000, 843 A1.000	466	9				
		OPEL	A 14 FP Euro 5	718	7				
		VAUXHALL	843 A1.000	1086	7				
08-433300-00	STD	DAF	XE 280 C1 Euro 3, XE 315 C1 Euro 3, XE 355 C1 Euro 3, XE 390 C1 Euro 3	212	17				
08-433400-00	STD	JEEP	OM 651.925	444	1				
		MERCEDES-BENZ	OM 651.911, OM 651.912, OM 651.913, OM 651.916, OM 651.921, OM 651.924, OM 651.925, OM 651.930, OM 651.940, OM 651.955, OM 651.956, OM 651.957, OM 651.960, OM 651.961, OM 651.980	579	11				
08-433405-00	0.25mm	JEEP	OM 651.925	444	1				
		MERCEDES-BENZ	OM 651.911, OM 651.912, OM 651.913, OM 651.916, OM 651.921, OM 651.924, OM 651.925, OM 651.930, OM 651.940, OM 651.955, OM 651.956, OM 651.957, OM 651.960, OM 651.961, OM 651.980	579	11				
08-433407-00	0.50mm	JEEP	OM 651.925	444	1				
		MERCEDES-BENZ	OM 651.911, OM 651.912, OM 651.913, OM 651.916, OM 651.921, OM 651.924, OM 651.925, OM 651.930, OM 651.940, OM 651.955, OM 651.956, OM 651.957, OM 651.960, OM 651.961, OM 651.980	579	11				
08-433500-00	STD	MINI	W10B16A	648	3				
08-433505-00	0.25mm	MINI	W10B16A	648	3				
08-433507-00	0.50mm	MINI	W10B16A	648	3				

NEW PARTS LIST





Nummerische Teilenummernliste • Liste des références produits
Lista de nuevas referencias





					9	
08-433600-00	STD	CITROEN	DV6BTE4 (9HT) Euro 4, DV6BTE4 (9HW) Euro 4, DV6BTE4 (9HT) Euro 4, DV6C (9HL), DV6C (9HR), DV6DBM (9HE) Euro 4, DV6DTE (9HF) Euro 4, DV6DTE (9HP) Euro 4, DV6DTE (9HJ) Euro 4, DV6ETED (9HN) Euro 4, DV6ETED (9HW) Euro 4, DV6ETED (9HK) Euro 4	170	13	
			FORD EUROPE	NGDA (Duratorq TDCI), T1BA (Duratorq TDCI), T1BB (Duratorq TDCI), T1BC (Duratorq TDCI), T1DA (Duratorq TDCI), T1DB (Duratorq TDCI), T3DA (Duratorq TDCI), T3DB (Duratorq TDCI), T3JA (Duratorq TDCI), T3JB, TZJA (Duratorq TDCI), TZJB (Duratorq TDCI)	337	8
				PEUGEOT	DV6BTE4 (9HT) Euro 4, DV6BTE4 (9HW) Euro 4, DV6C (9HL), DV6C (9HR), DV6CTED (9HD), DV6DTE (9HF) Euro 4, DV6DTE (9HP) Euro 4, DV6DTE (9HJ) Euro 4, DV6ETED (9HK) Euro 4	785
		TOYOTA	3WZ-TV	1055	12	
		VOLVO	D 4162 T	1227	3	
		08-433607-00	0.50mm	CITROEN	DV6BTE4 (9HT) Euro 4, DV6BTE4 (9HW) Euro 4, DV6BTE4 (9HT) Euro 4, DV6C (9HL), DV6C (9HR), DV6DBM (9HE) Euro 4, DV6DTE (9HF) Euro 4, DV6DTE (9HP) Euro 4, DV6DTE (9HJ) Euro 4, DV6ETED (9HN) Euro 4, DV6ETED (9HW) Euro 4, DV6ETED (9HK) Euro 4	170
FORD EUROPE	NGDA (Duratorq TDCI), T1BA (Duratorq TDCI), T1BB (Duratorq TDCI), T1BC (Duratorq TDCI), T1DA (Duratorq TDCI), T1DB (Duratorq TDCI), T3DA (Duratorq TDCI), T3DB (Duratorq TDCI), T3JA (Duratorq TDCI), T3JB, TZJA (Duratorq TDCI), TZJB (Duratorq TDCI)				337	8
	PEUGEOT				DV6BTE4 (9HT) Euro 4, DV6BTE4 (9HW) Euro 4, DV6C (9HL), DV6C (9HR), DV6CTED (9HD), DV6DTE (9HF) Euro 4, DV6DTE (9HP) Euro 4, DV6DTE (9HJ) Euro 4, DV6ETED (9HK) Euro 4	785
TOYOTA	3WZ-TV			1055	12	
VOLVO	D 4162 T			1227	3	
08-433700-00	STD			HONDA	D15Z1 (VTEC), D16A, D16Y5, D16Y7, D16Y8	385
08-433707-00	0.50mm	HONDA	D15Z1 (VTEC), D16A, D16Y5, D16Y7, D16Y8	385	3	
08-433800-00	STD	MAN	E 2866 DF01, E 2866 DUH01, E 2866 DUH03 Euro 3, E 2866 DUH 04 Euro 3, E 2866 LUH02 Euro 3, E 2876 LUH 02, E 2876 LUH 03, E 2876 LUH 04	533	28	
08-433900-00	STD	AUDI	CTHG	61	9	
		SEAT	CAVA, CAVE, CAVF, CNWB, CTHA, CTHE	982	12	
		SKODA	CAVE, CTHE	1008	11	
		VOLKSWAGEN	BLG, BMY, BWK, CAVA, CAVB, CAVC, CAVD, CAVE, CNWA, CNWB, CTHA, CTHE	1171	18	
08-433907-00	0.50mm	AUDI	CTHG	61	9	
		SEAT	CAVA, CAVE, CAVF, CNWB, CTHA, CTHE	982	12	
		SKODA	CAVE, CTHE	1008	11	
		VOLKSWAGEN	BLG, BMY, BWK, CAVA, CAVB, CAVC, CAVD, CAVE, CNWA, CNWB, CTHA, CTHE	1171	18	
08-434100-00	STD	IVECO	F3AE9687 AE001 Euro 5 (Cursor 10)	433	44	
08-434300-00	STD	AUDI	ASB, BKN, BMK, BNG, BPP, BSG, BUG, BUN	87	33	
			CAND, CASB, CATA, CDYB	89	35	
		VOLKSWAGEN	BKS, BMK, BUN	1211	45	
			CASB, CATA	1212	47	
08-434307-00	0.50mm	AUDI	ASB, BKN, BMK, BNG, BPP, BSG, BUG, BUN	87	33	
			CAND, CASB, CATA, CDYB	89	35	
		VOLKSWAGEN	BKS, BMK, BUN	1211	45	
			CASB, CATA	1212	47	
08-434400-00	STD	RENAULT TRUCKS	DXi 13 Euro 4	935	18	
		VOLVO COMMERCIAL	D13A360 Euro 5, D13A400 Euro 5, D13A440 Euro 5, D13A480 Euro 5, D13A520 Euro 5, D13C380 Euro 5, D13C420 Euro 5, D13C460 Euro 5, D13C500 Euro 5, D13C540 Euro 5	1256	31	
08-434600-00	STD	BMW	N20 B20A, N20 B20B, N26 B20A	132	24	
08-434800-00	STD	COMPRESSOR	MAN (D2066 (TGA 390,400,430))	196	23	
08-435000-00	STD	RENAULT TRUCKS	DCI 6 W Euro 3	931	8	
08-435100-10	STD	AUDI	ALT, ASN, AWA, AXW, AXJ, BBJ, BLR, BLX, BLY, BMB, BPJ, BPY, BVY, BVZ, BWA, BYK	85	31	
		SEAT	BLR, BLY, BVY, BVZ, BWA	994	29	
		SKODA	BLR, BLX, BLY, BVX, BVY, BVZ, BWA	1016	24	
		VOLKSWAGEN	ALT, AXW, AXJ, BLR, BLX, BLY, BPR, BPS, BPY, BVX, BVY, BVZ, BWA	1209	44	
08-435200-00	STD	NISSAN	M9T 670 Euro 5, M9T 672 Euro 5, M9T 676 Euro 4, M9T 678, M9T 680, M9T 686 Euro 5, M9T 690 Euro 5, M9T 692 Euro 4, M9T 694 Euro 4, M9T 696 Euro 4, M9T 698 Euro 5	688	22	
			OPEL	M9T 670 Euro 5, M9T 672 Euro 5, M9T 676 Euro 4, M9T 678, M9T 680, M9T 686 Euro 5, M9T 690 Euro 5, M9T 692 Euro 4, M9T 694 Euro 4, M9T 696 Euro 4, M9T 698 Euro 5	738	44
		RENAULT	M9T 670 Euro 5, M9T 672 Euro 5, M9T 676 Euro 4, M9T 678, M9T 680, M9T 686 Euro 5, M9T 690 Euro 5, M9T 692 Euro 4, M9T 694 Euro 4, M9T 696 Euro 4, M9T 698 Euro 5	908	31	
			VAUXHALL	M9T 670 Euro 5, M9T 672 Euro 5, M9T 676 Euro 4, M9T 678, M9T 680, M9T 686 Euro 5, M9T 690 Euro 5, M9T 692 Euro 4, M9T 694 Euro 4, M9T 696 Euro 4, M9T 698 Euro 5	1103	45

				9	
08-435207-00	0.50mm	NISSAN	M9T 670 Euro 5, M9T 672 Euro 5, M9T 676 Euro 4, M9T 678, M9T 680, M9T 686 Euro 5, M9T 690 Euro 5, M9T 692 Euro 4, M9T 694 Euro 4, M9T 696 Euro 4, M9T 698 Euro 5	688	22
		OPEL	M9T 670 Euro 5, M9T 672 Euro 5, M9T 676 Euro 4, M9T 678, M9T 680, M9T 686 Euro 5, M9T 690 Euro 5, M9T 692 Euro 4, M9T 694 Euro 4, M9T 696 Euro 4, M9T 698 Euro 5	738	44
		RENAULT	M9T 670 Euro 5, M9T 672 Euro 5, M9T 676 Euro 4, M9T 678, M9T 680, M9T 686 Euro 5, M9T 690 Euro 5, M9T 692 Euro 4, M9T 694 Euro 4, M9T 696 Euro 4, M9T 698 Euro 5	908	31
		VAUXHALL	M9T 670 Euro 5, M9T 672 Euro 5, M9T 676 Euro 4, M9T 678, M9T 680, M9T 686 Euro 5, M9T 690 Euro 5, M9T 692 Euro 4, M9T 694 Euro 4, M9T 696 Euro 4, M9T 698 Euro 5	1103	45
08-435300-00	STD	OPEL	Z 16 XER	728	24
		VAUXHALL	Z 16 XER	1094	25
08-435307-00	0.50mm	OPEL	Z 16 XER	728	24
		VAUXHALL	Z 16 XER	1094	25
08-435400-00	STD	HYUNDAI	G4EK	390	4
08-435407-00	0.50mm	HYUNDAI	G4EK	390	4
08-435500-00	STD	OPEL	A 16 LET Euro 5	726	20
		SAAB	A 16 LET Euro 5	949	1
		VAUXHALL	A 16 LET Euro 5	1093	21
08-435507-00	0.50mm	OPEL	A 16 LET Euro 5	726	20
		SAAB	A 16 LET Euro 5	949	1
		VAUXHALL	A 16 LET Euro 5	1093	21
		ALFA ROMEO	199 A3.000, 199 B1.000 Euro 5, 199 B4.000 Euro 5	11	1
		CHRYSLER	199 B1.000 Euro 5	146	1
08-435700-00	STD	FIAT	199 A9.000 Euro 5, 199 B1.000 Euro 5, 199 B2.000 Euro 5, 199 B4.000 Euro 5	262	8
		LANCIA	199 B1.000 Euro 5	465	5
		OPEL	A 13 DTC Euro 5 (CDTI), A 13 DTR Euro 5, A 13 FD Euro 5 (CDTI)	717	1
		PEUGEOT	199 A9.000 Euro 5	782	1
		VAUXHALL	A 13 DTC Euro 5 (CDTI), A 13 DTR Euro 5, A 13 FD Euro 5 (CDTI)	1085	2
		ALFA ROMEO	199 A3.000, 199 B1.000 Euro 5, 199 B4.000 Euro 5	11	1
		CHRYSLER	199 B1.000 Euro 5	146	1
08-435706-00	0.40mm	FIAT	199 A9.000 Euro 5, 199 B1.000 Euro 5, 199 B2.000 Euro 5, 199 B4.000 Euro 5	262	8
		LANCIA	199 B1.000 Euro 5	465	5
		OPEL	A 13 DTC Euro 5 (CDTI), A 13 DTR Euro 5, A 13 FD Euro 5 (CDTI)	717	1
		PEUGEOT	199 A9.000 Euro 5	782	1
		VAUXHALL	A 13 DTC Euro 5 (CDTI), A 13 DTR Euro 5, A 13 FD Euro 5 (CDTI)	1085	2
		NISSAN	QG18DE	685	16
		08-435807-00	0.50mm	NISSAN	QG18DE
08-435900-00	STD	NISSAN	QR20DE	690	26
08-435907-00	0.50mm	NISSAN	QR20DE	690	26
08-436000-00	STD	NISSAN	QR25DE	690	27
08-436007-00	0.50mm	NISSAN	QR25DE	690	27
08-436100-00	STD	NISSAN	YD25DDTi	691	29
08-436107-00	0.50mm	NISSAN	YD25DDTi	691	29
08-436200-00	STD	NISSAN	ZD30	692	35
08-436300-00	STD	LEXUS	2AD-FHV Euro 4	490	1
		TOYOTA	2AD-FHV Euro 4	1060	22
08-436400-00	STD	LEXUS	2AZ-FXE	490	2
		TOYOTA	2AZ-FXE	1062	25
08-436500-00	STD	ALFA ROMEO	844 A2.000, 939 B3.000, 939 B4.000, 939 B5.000, 940 A4.000, 940 A5.000 Euro 5, 940 A7.000 Euro 5, 940 A8.000 Euro 5	20	20
		CHRYSLER	198 A5.000 (Multijet)	147	5
		FIAT	198 A5.000, 250 A1.000 Euro 5, 263 A1.000 Euro 5, 844 A2.000, 939 B5.000, 940 A5.000 Euro 5, D20AA Euro 5	281	46
		LANCIA	198 A5.000, 198 A8.000 (Multijet), 844 A2.000	472	26
		OPEL	A 20 DTC Euro 5, A 20 DTE Euro 5, A 20 DT Euro 5, A 20 DTH Euro 5, A 20 DTJ Euro 5, A 20 DTL Euro 5, A 20 DTR Euro 5, A 20 FD Euro 5, Y 20 DTJ, Z 20 DTJ	733	35
		SAAB	A 20 DTH Euro 5, A 20 DTR Euro 5	950	6
		SUZUKI	D20AA Euro 5	1033	11
		VAUXHALL	A 20 DTC Euro 5, A 20 DTE Euro 5, A 20 DT Euro 5, A 20 DTH Euro 5, A 20 DTJ Euro 5, A 20 DTL Euro 5, A 20 DTR Euro 5, A 20 FD Euro 5, Y 20 DTJ, Z 20 DTJ	1098	36

NEW PARTS LIST





Nummerische Teilenummernliste • Liste des références produits
Lista de nuevas referencias

						9				
08-436506-00	0.40mm	ALFA ROMEO	844 A2.000, 939 B3.000, 939 B4.000, 939 B5.000, 940 A4.000, 940 A5.000 Euro 5, 940 A7.000 Euro 5, 940 A8.000 Euro 5			20	20			
			CHRYSLER	198 A5.000 (Multijet)			147	5		
			FIAT	198 A5.000, 250 A1.000 Euro 5, 263 A1.000 Euro 5, 844 A2.000, 939 B5.000, 940 A5.000 Euro 5, D20AA Euro 5			281	46		
			LANCIA	198 A5.000, 198 A8.000 (Multijet), 844 A2.000			472	26		
			OPEL	A 20 DTC Euro 5, A 20 DTE Euro 5, A 20 DT Euro 5, A 20 DTH Euro 5, A 20 DTJ Euro 5, A 20 DTL Euro 5, A 20 DTR Euro 5, A 20 FD Euro 5, Y 20 DTJ, Z 20 DTJ			733	35		
			SAAB	A 20 DTH Euro 5, A 20 DTR Euro 5			950	6		
			SUZUKI	D20AA Euro 5			1033	11		
			VAUXHALL	A 20 DTC Euro 5, A 20 DTE Euro 5, A 20 DT Euro 5, A 20 DTH Euro 5, A 20 DTJ Euro 5, A 20 DTL Euro 5, A 20 DTR Euro 5, A 20 FD Euro 5, Y 20 DTJ, Z 20 DTJ			1098	36		
			08-436700-00	STD	CITROEN	DW12C (4HL), DW12MTED4 (4HN)			183	35
					FORD EUROPE	KNBA (Duratorq TDCI), KNBB (Duratorq TDCI), KNWA (Duratorq TDCI), KNWB (Duratorq TDCI)			359	35
		JAGUAR	224DT			440	4			
		MITSUBISHI	4HK, 4HN, HTH			654	8			
		PEUGEOT	DW12C (4HL) Euro 5, DW12MTED4 (4HK), DW12MTED4 (4HN)			801	38			
08-436800-00	STD	ALFA ROMEO	199 A1.000, 350 A1.000 Euro4/5, 955 A9.000			12	3			
		FIAT	178 F3.011, 199 A1.000, 199 A7.000, 350 A1.000			266	14			
		LANCIA	350 A1.000			467	11			
08-436806-00	0.40mm	ALFA ROMEO	199 A1.000, 350 A1.000 Euro4/5, 955 A9.000			12	3			
		FIAT	178 F3.011, 199 A1.000, 199 A7.000, 350 A1.000			266	14			
		LANCIA	350 A1.000			467	11			
08-436900-00	STD	SEAT	BCA			982	10			
			BKY, BXW, CGGB			982	11			
		SKODA	BCA			1007	8			
			BKY, BUD, BXW, CDDA, CGGA, CGGB, CLPA			1007	9			
		VOLKSWAGEN	BCA			1169	15			
			BKR, BKY, BUD, CDDA, CGGA, CGGB, CLPA			1169	16			
08-437000-00	STD	FORD EUROPE	BHPA (Endura DI), FFBA, FFWA, HCPA (Duratorq), HCPB (Duratorq), KHBA (Duratorq TDCI), P7PA (Duratorq TDCI), P7PB (Duratorq TDCI), P9PA (Duratorq TDCI), P9PB (Duratorq TDCI), P9PC (Duratorq TDCI), P9PD (Duratorq TDCI), QYBA (Duratorq TDCI), QYWA, R2PA (Duratorq TDCI), R3PA (Duratorq TDCI), RWPA (Duratorq), RWPC (Duratorq TDCI), RWPD (Duratorq TDCI), RWPE (Duratorq TDCI), RWPF (Duratorq TDCI)			352	27			
08-437007-00	0.50mm	FORD EUROPE	BHPA (Endura DI), FFBA, FFWA, HCPA (Duratorq), HCPB (Duratorq), KHBA (Duratorq TDCI), P7PA (Duratorq TDCI), P7PB (Duratorq TDCI), P9PA (Duratorq TDCI), P9PB (Duratorq TDCI), P9PC (Duratorq TDCI), P9PD (Duratorq TDCI), QYBA (Duratorq TDCI), QYWA, R2PA (Duratorq TDCI), R3PA (Duratorq TDCI), RWPA (Duratorq), RWPC (Duratorq TDCI), RWPD (Duratorq TDCI), RWPE (Duratorq TDCI), RWPF (Duratorq TDCI)			352	27			
08-437100-00	STD	MERCEDES-BENZ	M 266.920, M 266.940, M 266.960			575	8			
08-437300-00	STD	AUDI	CGTA, CRDB			91	38			
08-437400-00	STD	OPEL	A 14 NET Euro 5			719	8			
		VAUXHALL	A 14 NET Euro 5			1087	9			
08-437600-00	STD	SCANIA	DT 12.03 Euro 4, DT 12.11 Euro 4, DT 12.12 Euro 4, DT 12.17 Euro 4			964	16			
08-438300-00	STD	ALFA ROMEO	198 A1.000, 198 A4.000, 198 A7.000, 199 A8.000, 940 A2.000 Euro 5, 940 A6.000 Euro 5, 955 A7.000, 955 A8.000 Euro 5			11	2			
		CHRYSLER	198 A4.000 (Turbo CNG EcoFlex), 198 A7.000			146	3			
		FIAT	198 A1.000, 198 A4.000, 198 A7.000, 199 A8.000, 312 A1.000, 312 A3.000, 955 A8.000 Euro 5			267	15			
		LANCIA	198 A1.000, 198 A4.000 (Jet 120 pk), 198 A7.000			466	10			
		OPEL	A 14 FC Euro 5			718	6			
		VAUXHALL	198 A4.000 (Turbo CNG), A 14 FC Euro 5			1086	6			
08-438306-00	0.40mm	ALFA ROMEO	198 A1.000, 198 A4.000, 198 A7.000, 199 A8.000, 940 A2.000 Euro 5, 940 A6.000 Euro 5, 955 A7.000, 955 A8.000 Euro 5			11	2			
		CHRYSLER	198 A4.000 (Turbo CNG EcoFlex), 198 A7.000			146	3			
		FIAT	198 A1.000, 198 A4.000, 198 A7.000, 199 A8.000, 312 A1.000, 312 A3.000, 955 A8.000 Euro 5			267	15			
		LANCIA	198 A1.000, 198 A4.000 (Jet 120 pk), 198 A7.000			466	10			
		OPEL	A 14 FC Euro 5			718	6			
		VAUXHALL	198 A4.000 (Turbo CNG), A 14 FC Euro 5			1086	6			
08-438600-00	STD	DAEWOO	A15DMS, A15MF, A15SMS, F15S			204	2			
08-438605-00	0.25mm	DAEWOO	A15DMS, A15MF, A15SMS, F15S			204	2			
08-438607-00	0.50mm	DAEWOO	A15DMS, A15MF, A15SMS, F15S			204	2			
08-438800-00	STD	RENAULT TRUCKS	Dxi 11			935	16			
		VOLVO COMMERCIAL	D11C330 Euro 5, D11C370 Euro 5, D11C410 Euro 5			1253	27			
08-438900-00	STD	VOLVO COMMERCIAL	D9B260 Euro 4/5, D9B300 Euro 4, D9B310 Euro 4/5, D9B340 Euro 4, D9B360 Euro 4/5, D9B380 Euro 4			1249	19			
08-439000-00	STD	HONDA	N22A1, N22A2			387	8			
08-439100-00	STD	CITROEN	DT20C (X8C) Euro 5, DT20C Euro 5			181	33			
		JAGUAR	306DT Euro 5, AJV6D			440	3			
		LAND ROVER	30DDTX, 306DT Euro 5 (TDV6 3.0)			481	5			
		PEUGEOT	DT20C Euro 5			798	34			
08-439200-00	STD	PORSCHE	M 97.77, M 97.77R			828	34			

								9	
08-439300-00	STD	LOTUS	1ZR-FAE, 2ZR-FE	502	3				
		TOYOTA	1ZR-FAE, 1ZR-FE, 2ZR-FAE, 2ZR-FE	1057	15				
08-439400-00	STD	NISSAN	QG16DE	684	9				
08-439500-00	STD	LOTUS	2ZZ-GE	502	4				
		TOYOTA	2ZZ-GE	1058	18				
08-439600-00	STD	CITROEN	1KR-FE, CFA (384F)	165	2				
		DAIHATSU	1KR-FE Euro 4	214	2				
		PEUGEOT	1KR (384 F)	782	4				
		SUBARU	1KR-FE Euro 4	1027	2				
		TOYOTA	1KR-FE Euro 4	1051	3				
08-439700-00	STD	DAIHATSU	3S-FE	215	6				
		TOYOTA	3S-FE	1061	23				
08-439800-00	STD	TOYOTA	2SZ-FE	1051	5				
08-439900-00	STD	TOYOTA	1AZ FE	1060	21				
08-440000-00	STD	TOYOTA	1NZ-FE, 2NZ-FE	1054	10				
08-440100-00	STD	NISSAN	HR16DE	652	3				
		NISSAN	HR 16 DE	684	11				
08-440200-00	STD	SUBARU	M13A	1028	6				
		SUZUKI	M13A	1033	10				
08-440300-00	STD	NISSAN	YD22DDT, YD22DDTi, YD22ETi	689	23				
08-440300-10	STD	NISSAN	YD22DDT, YD22DDTi, YD22ETi	689	23				
08-440400-00	STD	DEUTZ / KHD	F 4L 413 FR, F 5L 413 FR, F 6L 413 FR, F 6L 413 FR, F 6L 413 FW, F 6L 413 FW, F 8L 413 F, F 8L 413 FW, F 10L 413 F, F 10L 413 FW, F 12L 413 F, F 12L 413 FW	234	37				
		IVECO	F6L 413 F, F8L 413 F, F10L 413 F	432	42				
08-440407-00	0.50mm	DEUTZ / KHD	F 4L 413 FR, F 5L 413 FR, F 6L 413 FR, F 6L 413 FR, F 6L 413 FW, F 8L 413 F, F 8L 413 FW, F 10L 413 F, F 10L 413 FW, F 12L 413 F, F 12L 413 FW	234	37				
		IVECO	F6L 413 F, F8L 413 F, F10L 413 F	432	42				
08-440411-00	1.00mm	DEUTZ / KHD	F 4L 413 FR, F 5L 413 FR, F 6L 413 FR, F 6L 413 FR, F 6L 413 FW, F 8L 413 F, F 8L 413 FW, F 10L 413 F, F 10L 413 FW, F 12L 413 F, F 12L 413 FW	234	37				
		IVECO	F6L 413 F, F8L 413 F, F10L 413 F	432	42				
08-440600-00	STD	MERCEDES-BENZ COMMERCIAL	OM 471.900 (OM 471 LA), OM 471.909 Euro 5 (OM 471 LA)	644	29				
08-440700-00	STD	BMW	N52 B25, N52 B25A, N52 B25C	124	7				
08-440900-00	STD	MERCEDES-BENZ	M 272.911, M 272.920, M 272.921, M 272.922, M 272.940, M 272.941, M 272.942, M 272.943, M 272.944, M 272.945, M 272.946, M 272.947, M 272.948, M 272.949, M 272.952	590	25				
08-441000-00	STD	PORSCHE	M 97.21, M 97.22	823	21				
08-449000-00	STD	FORD EUROPE	A9A (Duratec), A9B (Duratec)	332	4				
08-449007-00	0.50mm	FORD EUROPE	A9A (Duratec), A9B (Duratec)	332	4				
08-450000-00	STD	DACIA	D4F732	201	1				
		RENAULT	D4F 702, D4F 706, D4F 708, D4F 712, D4F 714, D4F 716, D4F 722, D4F 728, D4F 730, D4F 732, D4F 740, D4F 742, D4F 764, D4F 772	870	3				
08-450007-00	0.50mm	DACIA	D4F732	201	1				
		RENAULT	D4F 702, D4F 706, D4F 708, D4F 712, D4F 714, D4F 716, D4F 722, D4F 728, D4F 730, D4F 732, D4F 740, D4F 742, D4F 764, D4F 772	870	3				
08-451000-00	STD	IVECO	8469 SG.10	431	36				
08-524300-10	STD	AUSTIN MORRIS	A + series (99H), A+ Series (99H), A/A+ Series (99H)	95	2				
		ROVER	A+ Series (99H)	941	1				
08-524307-10	.020	AUSTIN MORRIS	A + series (99H), A+ Series (99H), A/A+ Series (99H)	95	2				
		ROVER	A+ Series (99H)	941	1				
08-524311-10	.040	AUSTIN MORRIS	A + series (99H), A+ Series (99H), A/A+ Series (99H)	95	2				
		ROVER	A+ Series (99H)	941	1				
08-524314-10	.060	AUSTIN MORRIS	A + series (99H), A+ Series (99H), A/A+ Series (99H)	95	2				
		ROVER	A+ Series (99H)	941	1				
08-530400-00	STD	ALFA ROMEO	AR 00530	12	5				
08-741205-00	0.25mm	COMPRESSOR	Westinghouse (MB OM457/904/906, DAF 825/1160)	195	18				
		MERCEDES-BENZ COMMERCIAL	OM457/904/906 Compressor (MB OM457/904/906, DAF 825/1160)	625	1				
08-848300-50	STD	HYUNDAI	G4ED Euro 4, G4ED-G	391	5				
		KIA	G4ED Euro 4	449	3				
08-848307-50	0.50mm	HYUNDAI	G4ED Euro 4, G4ED-G	391	5				
		KIA	G4ED Euro 4	449	3				
08-849000-00	STD	HYUNDAI	D4FA	390	1				
		KIA	D4FA Euro 3	449	1				
08-849007-00	0.50mm	HYUNDAI	D4FA	390	1				
		KIA	D4FA Euro 3	449	1				

NEW PARTS LIST

Nummerische Teilenummernliste • Liste des références produits
Lista de nuevas referencias

					
08-849200-50	STD	HYUNDAI	G4EE Euro 4	390	3
		KIA	G4EE Euro 4	449	2
08-849207-50	0.50mm	HYUNDAI	G4EE Euro 4	390	3
		KIA	G4EE Euro 4	449	2
08-873400-00	STD	mitsubishi	4 D 56 HP	655	11
08-873407-00	0.50mm	mitsubishi	4 D 56 HP	655	11
08-898400-00	STD	MINI	1ND, 1ND-TV	648	1
		SUBARU	1ND-TV	1027	3
		TOYOTA	1ND-TV	1052	6
08-898407-00	0.50mm	MINI	1ND, 1ND-TV	648	1
		SUBARU	1ND-TV	1027	3
		TOYOTA	1ND-TV	1052	6

Modelverzeichnis • Index de modele • Índice de Modelo
Indeks modelu • Модель автомобиля • دليل الموديل

MODEL INDEX



CCM

x



9

	6 2.5 i.e.	AR 01913	Petrol	2492	V6	30
04/79→12/86	6 2.5 i.e.	AR 01928	Petrol	2492	V6	30
07/81→05/86	6 2.5 TD	VM HR 588 HT	Diesel	2494	5	32
10/84→12/89	33 1.3	AR 30168	Petrol	1351	4	11
05/83→12/89	33 1.3	AR 30502	Petrol	1351	4	11
06/83→12/89	33 1.3	AR 30586	Petrol	1351	4	11
10/84→12/89	33 1.3	AR 30587	Petrol	1351	4	11
05/83→12/89	33 1.3 i.e.	AR 30168	Petrol	1351	4	11
	33 1.4 4x4	AR 30732	Petrol	1351	B4	11
07/90→12/92	33 1.4 4x4	AR 30755	Petrol	1351	4	11
06/91→09/94	33 1.4 i.e.	AR 30753	Petrol	1351	4	11
06/91→09/94	33 1.4 i.e.	AR 30755	Petrol	1351	4	11
06/83→12/85	33 1.5	AR 30143	Petrol	1490	4	27
05/83→12/93	33 1.5	AR 30182	Petrol	1490	4	27
06/83→12/85	33 1.5	AR 30504	Petrol	1490	4	27
06/83→12/86	33 1.5	AR 30520	Petrol	1490	4	27
09/86→12/89	33 1.5 4x4	AR 30146	Petrol	1490	4	27
11/83→12/84	33 1.5 4x4	AR 30504	Petrol	1490	4	27
01/84→12/89	33 1.5 4x4	AR 30514	Petrol	1490	4	27
01/85→09/86	33 1.5 4x4	AR 30520	Petrol	1490	4	27
06/84→12/89	33 1.5 QV	AR 30146	Petrol	1490	4	27
06/84→12/89	33 1.5 QV	AR 30508	Petrol	1490	4	27
01/86→12/89	33 1.7	AR 30550	Petrol	1717	4	29
01/90→03/92	33 1.7 16V	AR 30746	Petrol	1717	4	29
01/90→09/94	33 1.7 16V	AR 30747	Petrol	1717	4	29
01/90→09/94	33 1.7 16V 4x4	AR 30746	Petrol	1717	4	29
01/90→09/94	33 1.7 16V 4x4	AR 30747	Petrol	1717	4	29
09/88→12/89	33 1.7 i.e.	AR 30558	Petrol	1717	4	29
01/90→09/94	33 1.7 i.e.	AR 30736	Petrol	1717	4	29
01/90→09/94	33 1.7 i.e.	AR 30737	Petrol	1717	4	29
04/92→09/94	33 1.7 i.e.	AR 30737 A	Petrol	1717	4	29
01/90→03/92	33 1.7 i.e. 4x4	AR 30736	Petrol	1717	4	29
01/90→03/92	33 1.7 i.e. 4x4	AR 30737	Petrol	1717	4	29
03/88→12/89	33 1.7 QV	AR 30550	Petrol	1717	4	29
01/86→06/90	33 1.8 TD	VM 82 A	Diesel	1779	3	33
07/90→09/94	33 1.8 TD	VM 96 A	Diesel	1779	3	33
01/84→12/88	33 Sportwagon 1.4	AR 30587	Petrol	1351	4	11
06/91→09/94	33 Sportwagon 1.4 i.e.	AR 30753	Petrol	1351	4	11
06/91→09/94	33 Sportwagon 1.4 i.e.	AR 30755	Petrol	1351	4	11
06/91→09/94	33 Sportwagon 1.4 i.e. 4x4	AR 30587	Petrol	1351	4	11
06/91→09/94	33 Sportwagon 1.4 i.e. 4x4	AR 30755	Petrol	1351	4	11
12/86→12/89	33 Sportwagon 1.5	AR 30146	Petrol	1490	4	27
12/86→12/89	33 Sportwagon 1.5	AR 30508	Petrol	1490	4	27
09/84→12/87	33 Sportwagon 1.5	AR 30514	Petrol	1490	4	27
09/84→12/86	33 Sportwagon 1.5	AR 30520	Petrol	1490	4	27
12/86→03/89	33 Sportwagon 1.5 4x4	AR 30146	Petrol	1490	4	27
09/84→12/87	33 Sportwagon 1.5 4x4	AR 30182	Petrol	1490	4	27
12/86→03/89	33 Sportwagon 1.5 4x4	AR 30508	Petrol	1490	4	27
09/84→12/86	33 Sportwagon 1.5 4x4	AR 30520	Petrol	1490	4	27
03/88→12/89	33 Sportwagon 1.7	AR 30550	Petrol	1717	4	29
01/90→03/92	33 Sportwagon 1.7 16V	AR 30746	Petrol	1717	4	29
01/90→09/94	33 Sportwagon 1.7 16V	AR 30747	Petrol	1717	4	29
01/90→09/94	33 Sportwagon 1.7 16V 4x4	AR 30747	Petrol	1717	4	29
09/88→12/89	33 Sportwagon 1.7 i.e.	AR 30558	Petrol	1717	4	29
01/90→03/92	33 Sportwagon 1.7 i.e.	AR 30736	Petrol	1717	4	29
01/90→09/94	33 Sportwagon 1.7 i.e.	AR 30737	Petrol	1717	4	29
09/88→12/89	33 Sportwagon 1.7 i.e. 4x4	AR 30558	Petrol	1717	4	29
01/90→03/92	33 Sportwagon 1.7 i.e. 4x4	AR 30736	Petrol	1717	4	29
09/88→03/92	33 Sportwagon 1.7 i.e. 4x4	AR 30737	Petrol	1717	4	29
01/86→12/89	33 Sportwagon 1.8 TD	VM 96 A	Diesel	1779	3	33

MODEL INDEX

Modelverzeichnis • Index de modele • Índice de Modelo
Indeks modelu • Модель автомобиля • دليل الموديل



CCM

x



9

05/85→09/89	75 1.6	AR 06100	Petrol	1567	4	6
05/85→02/92	75 1.6	AR 61101	Petrol	1567	4	7
09/88→02/92	75 1.8	AR 06168	Petrol	1779	4	10
09/85→06/89	75 1.8	AR 06202	Petrol	1779	4	10
09/88→02/92	75 1.8	AR 61102	Petrol	1779	4	10
08/89→02/92	75 1.8	AR 61201	Petrol	1779	4	10
08/89→02/92	75 1.8	AR 67101	Petrol	1773	4	25
05/85→10/88	75 2.0	AR 06212	Petrol	1962	4	24
05/85→02/92	75 2.0 T.S	AR 06224	Petrol	1962	4	25
01/87→02/92	75 2.0 T.S.	AR 06166	Petrol	1962	4	25
01/87→02/92	75 2.0 T.S.	AR 06224	Petrol	1962	4	25
05/85→09/92	75 2.0 TD	VM 80 A	Diesel	1995	4	32
01/89→02/92	75 2.4 TD	VM 81 A	Diesel	2393	4	33
05/85→08/86	75 2.5 V6	AR 01646	Petrol	2492	V6	30
05/85→08/86	75 2.5 V6	AR 01911	Petrol	2492	V6	30
09/86→04/89	75 2.5 V6 CAT	AR 01648	Petrol	2492	V6	30
01/87→12/90	75 3.0 V6	AR 06120	Petrol	2959	V6	37
01/87→02/92	75 3.0 V6	AR 06124	Petrol	2959	V6	37
02/90→02/92	75 3.0 V6	AR 61503	Petrol	2959	V6	37
10/84→07/87	90 1.8	AR 06202	Petrol	1779	4	10
10/84→07/87	90 2.0 i.e.	AR 06212	Petrol	1962	4	24
10/84→07/87	90 2.4 TD	VM 81 A	Diesel	2393	4	33
10/84→07/87	90 2.5 i.e. V6	AR 01646	Petrol	2492	V6	30
10/84→07/87	90 2.5 i.e. V6	AR 01911	Petrol	2492	V6	30
07/94→12/96	145 1.4 i.e.	AR 33501	Petrol	1351	4	11
12/96→01/01	145 1.4 i.e. 16V T.S.	AR 33503	Petrol	1371	4	18
12/96→01/01	145 1.4 i.e. 16V T.S.	AR 38501	Petrol	1371	4	18
10/94→12/96	145 1.6 i.e.	AR 33201	Petrol	1596	4	25
12/96→01/01	145 1.6 i.e. 16V T.S.	AR 38201 Euro 2	Petrol	1598	4	15
12/96→01/01	145 1.6 i.e. 16V T.S.	AR 67601 Euro 2	Petrol	1598	4	15
10/94→12/96	145 1.7 i.e. 16V	AR 33401	Petrol	1717	4	29
03/98→01/01	145 1.8 i.e. 16V	AR 32201	Petrol	1747	4	16
12/96→12/98	145 1.8 i.e. 16V T.S.	AR 38401	Petrol	1747	4	16
12/96→12/98	145 1.8 i.e. 16V T.S.	AR 67106	Petrol	1747	4	16
02/99→01/01	145 1.9 JTD	AR 32302 Euro 2	Diesel	1910	4	17
10/94→02/99	145 1.9 TD	AR 33601	Diesel	1929	4	19
10/94→02/99	145 1.9 TD	AR 67501	Diesel	1929	4	19
03/98→01/01	145 2.0 16V Quadrifoglio	AR 32301	Petrol	1970	4	22
10/95→01/01	145 2.0 16V T.S.	AR 67204	Petrol	1970	4	22
12/94→12/96	146 1.4 i.e.	AR 33501	Petrol	1351	4	11
11/96→01/01	146 1.4 i.e. 16V T.S.	AR 33503	Petrol	1371	4	18
11/96→01/01	146 1.4 i.e. 16V T.S.	AR 38501	Petrol	1371	4	18
12/94→12/96	146 1.6 i.e.	AR 33201	Petrol	1596	4	25
11/96→01/01	146 1.6 i.e. 16V T.S.	AR 38201 Euro 2	Petrol	1598	4	15
11/96→01/01	146 1.6 i.e. 16V T.S.	AR 67601 Euro 2	Petrol	1598	4	15
12/94→12/96	146 1.7 i.e. 16V	AR 33401	Petrol	1717	4	29
03/98→01/01	146 1.8 i.e. 16V T.S.	AR 32201	Petrol	1747	4	16
11/96→01/01	146 1.8 i.e. 16V T.S.	AR 38401	Petrol	1747	4	16
11/96→01/01	146 1.8 i.e. 16V T.S.	AR 67106	Petrol	1747	4	16
02/99→01/01	146 1.9 JTD	AR 32302 Euro 2	Diesel	1910	4	17
12/94→02/99	146 1.9 TD	AR 33601	Diesel	1929	4	19
12/94→02/99	146 1.9 TD	AR 67501	Diesel	1929	4	19
03/98→01/01	146 2.0 16V Quadrifoglio	AR 32301	Petrol	1970	4	22
10/95→01/01	146 2.0 16V T.S.	AR 67204	Petrol	1970	4	22
01/01→03/10	147 1.6 16V T.SPARK	AR 32104 Euro 3	Petrol	1598	4	16
01/01→03/10	147 1.6 16V T.SPARK ECO	AR 37203 Euro 3	Petrol	1598	4	16
04/01→03/10	147 1.9 JTD	937 A2.000 Euro 3	Diesel	1910	4	13
11/00→09/04	147 1.9 JTD	AR 37101 Euro 3	Diesel	1910	4	13
11/02→03/10	147 1.9 JTD 16V	192 A5.000	Diesel	1910	4	12
10/04→03/10	147 1.9 JTD 16V	192 B1.000	Diesel	1910	4	12



CCM

x



09/03→09/04	147 1.9 JTD 16V	937 A4.000 Euro 3	Diesel	1910	4	12
07/05→03/10	147 1.9 JTDM 16V	937 A5.000	Diesel	1910	4	12
06/08→03/10	147 1.9 JTDM 16V	937 A6.000	Diesel	1910	4	12
07/02→05/05	147 2.0	937 A1.000	Petrol	1970	4	21
01/01→03/10	147 2.0 16V T.SPARK	AR 32310	Petrol	1970	4	23
05/96→12/97	155 1.6 16V T.S.	AR 67601 Euro 2	Petrol	1598	4	15
05/96→12/97	155 1.7 T.S. 16V	AR 67106	Petrol	1747	4	16
02/92→06/93	155 1.8 T.S.	AR 67101	Petrol	1773	4	25
01/92→12/96	155 1.8 T.S. Sport	AR 67101	Petrol	1773	4	25
01/92→12/96	155 1.8 T.S. Sport	AR 67102	Petrol	1773	4	25
04/93→12/97	155 1.9 TD	AR 67501	Diesel	1929	4	19
01/92→12/97	155 2.0 16V Turbo Q4	AR 67203	Petrol	1995	4	28
02/92→04/93	155 2.0 T.S.	AR 67201	Petrol	1995	4	25
02/92→02/95	155 2.0 T.S.	AR 67202	Petrol	1970	4	22
03/95→12/97	155 2.0 T.S. 16V	AR 67204	Petrol	1970	4	22
04/93→12/97	155 2.5 TD	VM 07 B	Diesel	2500	4	33
04/93→12/97	155 2.5 TD	VM 31 B	Diesel	2500	4	33
02/92→09/96	155 2.5 V6	AR 67301	Petrol	2492	V6	30
10/92→12/97	155 2.5 V6	AR 67302	Petrol	2492	V6	30
10/92→12/97	155 2.5 V6	AR 67303	Petrol	2492	V6	30
09/97→09/05	156 1.6 16V T.SPARK	AR 32102 Euro 2	Petrol	1598	4	15
09/97→09/05	156 1.6 16V T.SPARK	AR 32103 Euro 3	Petrol	1598	4	16
09/97→09/05	156 1.6 16V T.SPARK	AR 32104 Euro 3	Petrol	1598	4	16
09/97→09/05	156 1.6 16V T.SPARK	AR 67601 Euro 2	Petrol	1598	4	15
09/97→10/00	156 1.8 16V T.SPARK	AR 32201	Petrol	1747	4	16
10/00→09/05	156 1.8 16V T.SPARK	AR 32205	Petrol	1747	4	16
11/02→11/04	156 1.9 JTD	192 B1.000	Diesel	1910	4	12
05/01→09/05	156 1.9 JTD	937 A2.000 Euro 3	Diesel	1910	4	13
11/03→09/05	156 1.9 JTD	937 A4.000 Euro 3	Diesel	1910	4	12
07/04→09/05	156 1.9 JTD	937 A5.000	Diesel	1910	4	12
09/97→10/00	156 1.9 JTD	AR 32302 Euro 2	Diesel	1910	4	17
10/00→05/01	156 1.9 JTD	AR 37101 Euro 3	Diesel	1910	4	13
11/02→09/05	156 1.9 JTD 16V	192 A5.000	Diesel	1910	4	12
09/97→10/00	156 2.0 16V T.SPARK	AR 32301	Petrol	1970	4	22
10/00→03/02	156 2.0 16V T.SPARK	AR 32310	Petrol	1970	4	23
03/02→09/05	156 2.0 JTS	937 A1.000	Petrol	1970	4	21
10/00→09/05	156 2.4 JTD	839 A6.000 Euro 3	Diesel	2387	5	13
03/02→09/05	156 2.4 JTD	841 C.000 Euro 3	Diesel	2387	5	13
10/03→09/05	156 2.4 JTD	841 G.000 Euro 3	Diesel	2387	5	12
06/03→09/05	156 2.4 JTD	841 M.000	Diesel	2387	5	12
06/03→09/05	156 2.4 JTD	841 N.000	Diesel	2387	5	12
09/97→10/00	156 2.4 JTD	AR 32501 Euro 2	Diesel	2387	5	17
	156 2.4 JTD	AR 36202 Euro 3	Diesel	2387	5	13
09/97→12/01	156 2.5 V6 24V	AR 32401	Petrol	2492	V6	31
10/00→09/05	156 2.5 V6 24V	AR 32405	Petrol	2492	V6	31
05/00→05/06	156 Sportwagon 1.6 16V T.SPARK.	AR 32102 Euro 2	Petrol	1598	4	15
05/00→05/06	156 Sportwagon 1.6 16V T.SPARK.	AR 32103 Euro 3	Petrol	1598	4	16
05/00→05/06	156 Sportwagon 1.6 16V T.SPARK.	AR 32104 Euro 3	Petrol	1598	4	16
05/00→05/06	156 Sportwagon 1.6 16V T.SPARK.	AR 67601 Euro 2	Petrol	1598	4	15
05/00→10/00	156 Sportwagon 1.8 16V T.SPARK	AR 32201	Petrol	1747	4	16
10/00→05/06	156 Sportwagon 1.8 16V T.SPARK	AR 32205	Petrol	1747	4	16
11/02→11/04	156 Sportwagon 1.9 JTD	192 B1.000	Diesel	1910	4	12
05/01→05/06	156 Sportwagon 1.9 JTD	937 A2.000 Euro 3	Diesel	1910	4	13
11/03→05/06	156 Sportwagon 1.9 JTD	937 A4.000 Euro 3	Diesel	1910	4	12
03/05→05/06	156 Sportwagon 1.9 JTD	937 A5.000	Diesel	1910	4	12
05/00→10/00	156 Sportwagon 1.9 JTD	AR 32302 Euro 2	Diesel	1910	4	17
10/00→05/01	156 Sportwagon 1.9 JTD	AR 37101 Euro 3	Diesel	1910	4	13
11/02→05/06	156 Sportwagon 1.9 JTD 16V	192 A5.000	Diesel	1910	4	12
07/04→05/06	156 Sportwagon 1.9 JTD 16V Q4	937 A5.000	Diesel	1910	4	12
03/02→05/06	156 Sportwagon 2.0	932 A2.000	Petrol	1970	4	21

MODEL INDEX

Modelverzeichnis • Index de modele • Índice de Modelo
 Indeks modelu • Модель автомобиля • دليل الموديل

CCM
x

9

05/00→10/00	156 Sportwagon 2.0 16V T.SPARK	AR 32301	Petrol	1970	4	22
10/00→03/02	156 Sportwagon 2.0 16V T.SPARK	AR 32310	Petrol	1970	4	23
03/02→05/06	156 Sportwagon 2.0 JTS	937 A1.000	Petrol	1970	4	21
10/00→05/06	156 Sportwagon 2.4 JTD	839 A6.000 Euro 3	Diesel	2387	5	13
03/02→05/06	156 Sportwagon 2.4 JTD	841 C.000 Euro 3	Diesel	2387	5	13
10/03→05/06	156 Sportwagon 2.4 JTD	841 G.000 Euro 3	Diesel	2387	5	12
06/03→05/06	156 Sportwagon 2.4 JTD	841 M.000	Diesel	2387	5	12
06/03→05/06	156 Sportwagon 2.4 JTD	841 N.000	Diesel	2387	5	12
05/00→10/00	156 Sportwagon 2.4 JTD	AR 32501 Euro 2	Diesel	2387	5	17
	156 Sportwagon 2.4 JTD	AR 36202 Euro 3	Diesel	2387	5	13
05/00→10/00	156 Sportwagon 2.5 V6 24V	AR 32401	Petrol	2492	V6	31
10/00→05/06	156 Sportwagon 2.5 V6 24V	AR 32405	Petrol	2492	V6	31
03/07→11/11	159 1.8 MPI	939 A4.000	Petrol	1796	4	14
09/05→11/11	159 1.9 JTDM 16V	939 A2.000	Diesel	1910	4	12
05/09→11/11	159 2.0 JTDM	844 A2.000	Diesel	1956	4	20
05/09→11/11	159 2.0 JTDM	939 B3.000	Diesel	1956	4	20
06/10→11/11	159 2.0 JTDM	939 B4.000	Diesel	1956	4	20
05/09→11/11	159 2.0 JTDM	939 B5.000	Diesel	1956	4	20
09/05→11/11	159 2.4 JTDM	939 A3.000 Euro 4	Diesel	2387	5	12
03/07→11/11	159 Sportwagon 1.8 MPI	939 A4.000	Petrol	1796	4	14
03/06→11/11	159 Sportwagon 1.9 JTDM 16V	939 A2.000	Diesel	1910	4	12
05/09→11/11	159 Sportwagon 2.0 JTDM	844 A2.000	Diesel	1956	4	20
05/09→11/11	159 Sportwagon 2.0 JTDM	939 B3.000	Diesel	1956	4	20
06/10→11/11	159 Sportwagon 2.0 JTDM	939 B4.000	Diesel	1956	4	20
05/09→11/11	159 Sportwagon 2.0 JTDM	939 B5.000	Diesel	1956	4	20
03/06→11/11	159 Sportwagon 2.4 JTDM	939 A3.000 Euro 4	Diesel	2387	5	12
06/87→09/92	164 2.0 T.S.	AR 06416	Petrol	1962	4	25
06/87→12/90	164 2.0 T.S.	AR 06420	Petrol	1962	4	25
09/92→09/98	164 2.0 T.S.	AR 64103	Petrol	1995	4	25
10/87→09/98	164 2.0 Turbo	AR 06476	Petrol	1995	4	26
09/92→09/98	164 2.5 TD	VM 08 B	Diesel	2500	4	33
09/92→09/98	164 2.5 TD	VM 32 B	Diesel	2500	4	33
06/87→09/92	164 2.5 TD	VM 84 A	Diesel	2500	4	33
11/87→09/91	164 3.0	AR 06410	Petrol	2959	V6	37
09/90→09/92	164 3.0 i.e. QV	AR 64301	Petrol	2959	V6	37
06/87→09/92	164 3.0 V6	AR 06410	Petrol	2959	V6	37
06/87→09/92	164 3.0 V6	AR 06412	Petrol	2959	V6	37
09/98→10/00	166 2.0 T.Spark	AR 34103	Petrol	1970	4	22
10/00→06/07	166 2.0 T.Spark	AR 36301	Petrol	1970	4	23
10/00→06/07	166 2.4 JTD	839 A6.000 Euro 3	Diesel	2387	5	13
04/02→06/07	166 2.4 JTD	841 C.000 Euro 3	Diesel	2387	5	13
10/03→06/07	166 2.4 JTD	841 G.000 Euro 3	Diesel	2387	5	12
10/03→06/07	166 2.4 JTD	841 H.000	Diesel	2387	5	12
10/03→06/07	166 2.4 JTD	841 M.000	Diesel	2387	5	12
10/03→06/07	166 2.4 JTD	841 N.000	Diesel	2387	5	12
09/98→10/00	166 2.4 JTD	AR 34202 Euro 2	Diesel	2387	5	17
09/98→10/00	166 2.5 V6 24V	AR 34201	Petrol	2492	V6	31
10/00→06/07	166 2.5 V6 24V	AR 36201	Petrol	2492	V6	31
09/98→10/00	166 3.0 V6 24V	AR 34301	Petrol	2959	V6	38
10/00→06/07	166 3.0 V6 24V	AR 36101	Petrol	2959	V6	38
03/68→10/72	1750	AR 00548	Petrol	1779	4	10
10/71→12/83	1750 2000	AR 10520	Petrol	1962	4	24
01/73→12/81	2000 GT	116 (33)	Petrol	1962	4	24
01/73→12/81	2000 Spider	116 (33)	Petrol	1962	4	24
01/73→12/81	2000 Veloce	116 (33)	Petrol	1962	4	24
06/72→09/84	Alfasud 1.2	AR 30102	Petrol	1186	4	11
03/80→09/84	Alfasud 1.2	AR 30102 S	Petrol	1186	4	11
11/73→09/84	Alfasud 1.2 ti	AR 30104	Petrol	1186	4	11
01/78→02/80	Alfasud 1.3	AR 30180	Petrol	1287	4	11
09/77→09/84	Alfasud 1.3 SC/ti Super	AR 30164	Petrol	1351	4	11



CCM

x



9

01/79→09/84	Alfasud 1.3 Super	AR 30160	Petrol	1287	4	11
03/80→12/84	Alfasud 1.3 ti	AR 30168	Petrol	1351	4	11
09/77→09/84	Alfasud 1.3 ti	AR 30184	Petrol	1490	4	27
01/79→09/84	Alfasud 1.5 ti	AR 30124	Petrol	1490	4	27
03/80→12/84	Alfasud 1.5 ti	AR 30128	Petrol	1490	4	27
01/83→12/84	Alfasud 1.5 ti Sprint	AR 30146	Petrol	1490	4	27
01/78→12/81	Alfasud Giardinetta 1.2	AR 30102	Petrol	1186	4	11
03/80→12/81	Alfasud Giardinetta 1.3	AR 30160	Petrol	1287	4	11
01/78→07/79	Alfasud Giardinetta 1.3	AR 30180	Petrol	1287	4	11
09/76→12/81	Alfasud Sprint 1.3	AR 30184	Petrol	1490	4	27
05/78→02/80	Alfasud Sprint 1.4	AR 30164	Petrol	1351	4	11
07/79→12/89	Alfasud Sprint 1.4	AR 30168	Petrol	1351	4	11
05/78→12/81	Alfasud Sprint 1.5	AR 30124	Petrol	1490	4	27
07/79→01/87	Alfasud Sprint 1.5	AR 30128	Petrol	1490	4	27
01/83→12/87	Alfasud Sprint 1.5	AR 30146	Petrol	1490	4	27
01/80→12/87	Alfasud Sprint 1.5 Veloce	AR 30146	Petrol	1490	4	27
03/87→12/89	Alfasud Sprint 1.7	AR 30550	Petrol	1717	4	29
10/87→12/89	Alfasud Sprint 1.7 i.e.	AR 30558	Petrol	1717	4	29
01/75→12/84	Alfetta 1.6	AR 01600	Petrol	1567	4	6
10/79→12/84	Alfetta 1.8	AR 01608	Petrol	1779	4	10
07/74→12/77	Alfetta 1.8	AR 01608 X	Petrol	1779	4	10
10/79→12/84	Alfetta 1.8	AR 01678	Petrol	1779	4	10
03/77→02/80	Alfetta 2.0	AR 01623	Petrol	1962	4	24
07/78→12/84	Alfetta 2.0	AR 01655	Petrol	1962	4	24
07/78→12/84	Alfetta 2.0	AR 10520	Petrol	1962	4	24
10/79→03/83	Alfetta 2.0 TD	VM 4HT/2	Diesel	1995	4	32
04/83→12/84	Alfetta 2.4 TD	VM 4HT 2.4	Diesel	2393	4	33
01/76→09/82	Alfetta GT 1.6	AR 01600	Petrol	1567	4	6
01/74→12/76	Alfetta GT 1.8	AR 01608	Petrol	1779	4	10
01/74→12/76	Alfetta GT 1.8	AR 01608 X	Petrol	1779	4	10
07/78→01/86	Alfetta GT 2.0	AR 01623	Petrol	1962	4	24
06/77→12/84	Alfetta GT 2.0	AR 01655	Petrol	1962	4	24
04/85→12/89	AR 6 Box 1.9 D	160 D100	Diesel	1929	4	19
04/85→02/86	AR 6 Box 2.4 D	8144.61.200	Diesel	2445	4	35
09/86→12/89	AR 6 Box 2.4 TD	8144.21.220 (Sofim)	Diesel	2445	4	34
03/86→12/89	AR 6 Box 2.5 D	8144.67.220	Diesel	2500	4	36
04/85→12/89	AR 6 Bus 1.9 D	160 D100	Diesel	1929	4	19
04/78→08/86	AR 8 Box 2.4 D	8140.61.200	Diesel	2445	4	35
04/85→12/89	AR 8 Box 2.4 TD	8140.21.200 D.I.	Diesel	2445	4	34
09/86→12/89	AR 8 Box 2.5 D	8144.67.220	Diesel	2500	4	36
01/78→12/79	AR 8 Furgone	8144.61	Diesel	2445	4	35
04/78→08/86	AR 8 Platform/Chassis 2.4 D	8140.61.200	Diesel	2445	4	35
09/86→12/89	AR 8 Platform/Chassis 2.4 D	8144.67.220	Diesel	2500	4	36
04/85→12/88	AR 8 Platform/Chassis 2.4 TD	8140.21.200 D.I.	Diesel	2445	4	34
03/83→12/86	Arna 1.2	AR 30102	Petrol	1186	4	11
01/85→12/86	Arna 1.2	AR 30500	Petrol	1186	4	11
01/85→12/86	Arna 1.2	AR 31000	Petrol	1186	4	11
03/83→12/86	Arna 1.3 TI	AR 30168	Petrol	1351	4	11
03/83→12/86	Arna 1.3 TI	AR 31010	Petrol	1351	4	11
01/85→12/86	Arna 1.5	AR 30182	Petrol	1490	4	27
03/08→	Brera 2.0 JTDM	844 A2.000	Diesel	1956	4	20
05/09→	Brera 2.0 JTDM	939 B3.000	Diesel	1956	4	20
05/09→	Brera 2.0 JTDM	939 B5.000	Diesel	1956	4	20
01/06→	Brera 2.4 JTDM 20V	939 A3.000 Euro 4	Diesel	2387	5	12
06/76→12/78	Giulia 1.8 D	4.108 (Perkins)	Diesel	1760	4	8
01/74→12/78	Giulia 1300 Super	AR 00530	Petrol	1290	4	5
06/64→12/78	Giulia 1600 Super	AR 00526	Petrol	1567	4	6
01/74→12/78	Giulia GT 1300 Super	AR 00530	Petrol	1290	4	5
01/74→12/78	Giulia GT 1600 Super	AR 00526	Petrol	1567	4	6
12/11→	Giulietta 1.4 BiFuel	198 A4.000	Petrol	1368	4	2

MODEL INDEX

 Modelverzeichnis • Index de modele • Índice de Modelo
 Indeks modelu • Модель автомобиля • دليل الموديل

CCM
x

9

04/10→	Giulietta 1.4 TB	198 A4.000	Petrol	1368	4	2
04/10→	Giulietta 1.4 TB	940 A2.000 Euro 5	Petrol	1368	4	2
04/10→	Giulietta 1.4 TB	940 A6.000 Euro 5	Petrol	1368	4	2
04/10→	Giulietta 1.4 TB	955 A8.000 Euro 5	Petrol	1368	4	2
10/77→04/85	Giulietta 1.6	AR 01600	Petrol	1567	4	6
04/79→04/85	Giulietta 1.8	AR 01678	Petrol	1779	4	10
06/80→04/85	Giulietta 2.0	AR 01655	Petrol	1962	4	24
06/80→04/85	Giulietta 2.0	AR 11671	Petrol	1962	4	24
04/10→	Giulietta 2.0 JTDM	940 A4.000	Diesel	1956	4	20
04/10→	Giulietta 2.0 JTDM	940 A5.000 Euro 5	Diesel	1956	4	20
04/10→	Giulietta 2.0 JTDM	940 A7.000 Euro 5	Diesel	1956	4	20
04/10→	Giulietta 2.0 JTDM	940 A8.000 Euro 5	Diesel	1956	4	20
11/03→09/10	GT 1.8 TS	AR 32205	Petrol	1747	4	16
11/03→09/10	GT 1.9 JTD	937 A5.000	Diesel	1910	4	12
05/08→09/10	GT 1.9 JTD	937 A6.000	Diesel	1910	4	12
11/03→09/10	GT 2.0 JTS	932 A2.000	Petrol	1970	4	21
11/03→09/10	GT 2.0 JTS	937 A1.000	Petrol	1970	4	21
01/66→12/77	GT 1300 Junior	AR 00530	Petrol	1290	4	5
01/66→12/77	GT 1600	AR 00536	Petrol	1567	4	6
01/67→12/72	GT V 1750	AR 00548	Petrol	1779	4	10
05/98→10/05	GTV 1.8 16V	AR 32201	Petrol	1747	4	16
07/78→01/86	GTV 2.0	AR 01655	Petrol	1962	4	24
07/78→01/86	GTV 2.0	AR 06212	Petrol	1962	4	24
04/03→10/05	GTV 2.0 JTS	937 A1.000	Petrol	1970	4	21
06/95→10/05	GTV 2.0 T.SPARK 16V	AR 16201	Petrol	1970	4	22
05/98→08/00	GTV 2.0 T.SPARK 16V	AR 32301	Petrol	1970	4	22
06/95→10/05	GTV 2.0 T.SPARK 16V	AR 32310	Petrol	1970	4	23
10/96→10/00	GTV 3.0 V6 24V	AR 16102	Petrol	2959	V6	38
10/00→10/05	GTV 3.0 V6 24V	AR 16105	Petrol	2959	V6	38
11/80→02/87	GTV 6 2.5	AR 01646	Petrol	2492	V6	30
09/08→	Mito 1.3 JTDM	199 A3.000	Diesel	1248	4	1
10/09→	Mito 1.3 JTDM	199 B1.000 Euro 5	Diesel	1248	4	1
01/11→	Mito 1.3 JTDM	199 B4.000 Euro 5	Diesel	1248	4	1
09/08→	Mito 1.4	198 A4.000	Petrol	1368	4	2
03/11→	Mito 1.4	199 A1.000	Petrol	1368	4	3
09/08→	Mito 1.4	199 A6.000	Petrol	1368	4	4
03/11→	Mito 1.4	350 A1.000 Euro4/5	Petrol	1368	4	3
09/08→	Mito 1.4	955 A1.000	Petrol	1368	4	4
05/11→	Mito 1.4	955 A9.000	Petrol	1368	4	3
07/11→	Mito 1.4 Bifuel	198 A4.000	Petrol	1368	4	2
09/08→	Mito 1.4 TB	198 A7.000	Petrol	1368	4	2
09/08→	Mito 1.4 TB	199 A8.000	Petrol	1368	4	2
10/09→	Mito 1.4 TB	940 A2.000 Euro 5	Petrol	1368	4	2
10/09→	Mito 1.4 TB	955 A7.000	Petrol	1368	4	2
10/09→	Mito 1.4 TB	955 A8.000 Euro 5	Petrol	1368	4	2
09/08→	Mito 1.4 Turbo	198 A1.000	Petrol	1368	4	2
09/08→	Mito 1.6 JTDM	198 A2.000	Diesel	1598	4	9
09/08→	Mito 1.6 JTDM	955 A3.000 Euro 5	Diesel	1598	4	9
05/98→04/05	Spider 1.8 16V	AR 32201	Petrol	1747	4	16
04/09→	Spider 2.0 JTDM	844 A2.000	Diesel	1956	4	20
05/09→	Spider 2.0 JTDM	939 B3.000	Diesel	1956	4	20
05/09→	Spider 2.0 JTDM	939 B5.000	Diesel	1956	4	20
04/03→04/05	Spider 2.0 JTS	937 A1.000	Petrol	1970	4	21
06/95→04/05	Spider 2.0 T.SPARK 16V	AR 16201	Petrol	1970	4	22
05/98→08/00	Spider 2.0 T.SPARK 16V	AR 32301	Petrol	1970	4	22
06/95→04/05	Spider 2.0 T.SPARK 16V	AR 32310	Petrol	1970	4	23
04/07→	Spider 2.4 JTDM	939 A3.000 Euro 4	Diesel	2387	5	12
09/94→08/00	Spider 3.0 V6	AR 16105	Petrol	2959	V6	38
01/99→10/03	Spider 3.0 V6 24V	AR 16102	Petrol	2959	V6	38
01/68→12/77	Spider 1300	AR 00530	Petrol	1290	4	5

Modelverzeichnis • Index de modele • Índice de Modelo
 Indeks modelu • Модель автомобиля • دليل الموديل

MODEL INDEX



CCM

x



9

03/66→12/90	Spider 1600	AR 00526	Petrol	1567	4	6
03/66→12/79	Spider 1600	AR 00536	Petrol	1567	4	6
03/66→12/68	Spider 1600	AR 01600	Petrol	1567	4	6
01/67→12/71	Spider 1750	AR 00548	Petrol	1779	4	10
01/90→12/93	Spider 2000	AR 01588	Petrol	1962	4	25

ENGINE INDEX

Motorverzeichnis • Index de moteur • Índice de Motor
 Indeks silnika • Модель двигателя • دليل المحرك

CCM
x

9

4.108 (Perkins)	Diesel	1760	4	79.38	8
116 (33)	Petrol	1962	4	84.00	24
160 D100	Diesel	1929	4	82.60	19
192 A5.000	Diesel	1910	4	82.00	12
192 B1.000	Diesel	1910	4	82.00	12
198 A1.000	Petrol	1368	4	72.00	2
198 A2.000	Diesel	1598	4	79.50	9
198 A4.000	Petrol	1368	4	72.00	2
198 A7.000	Petrol	1368	4	72.00	2
199 A1.000	Petrol	1368	4	72.00	3
199 A3.000	Diesel	1248	4	69.60	1
199 A6.000	Petrol	1368	4	72.00	4
199 A8.000	Petrol	1368	4	72.00	2
199 B1.000 Euro 5	Diesel	1248	4	69.60	1
199 B4.000 Euro 5	Diesel	1248	4	69.60	1
350 A1.000 Euro4/5	Petrol	1368	4	72.00	3
839 A6.000 Euro 3	Diesel	2387	5	82.00	13
841 C.000 Euro 3	Diesel	2387	5	82.00	13
841 G.000 Euro 3	Diesel	2387	5	82.00	12
841 H.000	Diesel	2387	5	82.00	12
841 M.000	Diesel	2387	5	82.00	12
841 N.000	Diesel	2387	5	82.00	12
844 A2.000	Diesel	1956	4	83.00	20
932 A2.000	Petrol	1970	4	83.00	21
937 A1.000	Petrol	1970	4	83.00	21
937 A2.000 Euro 3	Diesel	1910	4	82.00	13
937 A4.000 Euro 3	Diesel	1910	4	82.00	12
937 A5.000	Diesel	1910	4	82.00	12
937 A6.000	Diesel	1910	4	82.00	12
939 A2.000	Diesel	1910	4	82.00	12
939 A3.000 Euro 4	Diesel	2387	5	82.00	12
939 A4.000	Petrol	1796	4	82.00	14
939 B3.000	Diesel	1956	4	83.00	20
939 B4.000	Diesel	1956	4	83.00	20
939 B5.000	Diesel	1956	4	83.00	20
940 A2.000 Euro 5	Petrol	1368	4	72.00	2
940 A4.000	Diesel	1956	4	83.00	20
940 A5.000 Euro 5	Diesel	1956	4	83.00	20
940 A6.000 Euro 5	Petrol	1368	4	72.00	2
940 A7.000 Euro 5	Diesel	1956	4	83.00	20
940 A8.000 Euro 5	Diesel	1956	4	83.00	20
955 A1.000	Petrol	1368	4	72.00	4
955 A3.000 Euro 5	Diesel	1598	4	79.50	9
955 A7.000	Petrol	1368	4	72.00	2
955 A8.000 Euro 5	Petrol	1368	4	72.00	2
955 A9.000	Petrol	1368	4	72.00	3
8140.21.200 D.I.	Diesel	2445	4	93.00	34
8140.61.200	Diesel	2445	4	93.00	35
8144.21.220 (Sofim)	Diesel	2445	4	93.00	34
8144.61	Diesel	2445	4	93.00	35
8144.61.200	Diesel	2445	4	93.00	35
8144.67.220	Diesel	2500	4	93.00	36
AR 00526	Petrol	1567	4	78.00	6
AR 00530	Petrol	1290	4	74.00	5
AR 00536	Petrol	1567	4	78.00	6
AR 00548	Petrol	1779	4	80.00	10
AR 01588	Petrol	1962	4	84.00	25
AR 01600	Petrol	1567	4	78.00	6
AR 01608	Petrol	1779	4	80.00	10
AR 01608 X	Petrol	1779	4	80.00	10

Motorverzeichnis • Index de moteur • Índice de Motor
Indeks silnika • Модель двигателя • دليل المحرك

ENGINE INDEX



CCM

x



9

AR 01623	Petrol	1962	4	84.00	24
AR 01646	Petrol	2492	V6	88.00	30
AR 01648	Petrol	2492	V6	88.00	30
AR 01655	Petrol	1962	4	84.00	24
AR 01678	Petrol	1779	4	80.00	10
AR 01911	Petrol	2492	V6	88.00	30
AR 01913	Petrol	2492	V6	88.00	30
AR 01928	Petrol	2492	V6	88.00	30
AR 06100	Petrol	1567	4	78.00	6
AR 06120	Petrol	2959	V6	93.00	37
AR 06124	Petrol	2959	V6	93.00	37
AR 06166	Petrol	1962	4	84.00	25
AR 06168	Petrol	1779	4	80.00	10
AR 06202	Petrol	1779	4	80.00	10
AR 06212	Petrol	1962	4	84.00	24
AR 06224	Petrol	1962	4	84.00	25
AR 06410	Petrol	2959	V6	93.00	37
AR 06412	Petrol	2959	V6	93.00	37
AR 06416	Petrol	1962	4	84.00	25
AR 06420	Petrol	1962	4	84.00	25
AR 06476	Petrol	1995	4	84.00	26
AR 10520	Petrol	1962	4	84.00	24
AR 11671	Petrol	1962	4	84.00	24
AR 16102	Petrol	2959	V6	93.00	38
AR 16105	Petrol	2959	V6	93.00	38
AR 16201	Petrol	1970	4	83.00	22
AR 30102	Petrol	1186	4	80.00	11
AR 30102 S	Petrol	1186	4	80.00	11
AR 30104	Petrol	1186	4	80.00	11
AR 30124	Petrol	1490	4	84.00	27
AR 30128	Petrol	1490	4	84.00	27
AR 30143	Petrol	1490	4	84.00	27
AR 30146	Petrol	1490	4	84.00	27
AR 30160	Petrol	1287	4	80.00	11
AR 30164	Petrol	1351	4	80.00	11
AR 30168	Petrol	1351	4	80.00	11
AR 30180	Petrol	1287	4	80.00	11
AR 30182	Petrol	1490	4	84.00	27
AR 30184	Petrol	1490	4	84.00	27
AR 30500	Petrol	1186	4	80.00	11
AR 30502	Petrol	1351	4	80.00	11
AR 30504	Petrol	1490	4	84.00	27
AR 30508	Petrol	1490	4	84.00	27
AR 30514	Petrol	1490	4	84.00	27
AR 30520	Petrol	1490	4	84.00	27
AR 30550	Petrol	1717	4	87.00	29
AR 30558	Petrol	1717	4	87.00	29
AR 30586	Petrol	1351	4	80.00	11
AR 30587	Petrol	1351	4	80.00	11
AR 30732	Petrol	1351	B4	80.00	11
AR 30736	Petrol	1717	4	87.00	29
AR 30737	Petrol	1717	4	87.00	29
AR 30737 A	Petrol	1717	4	87.00	29
AR 30746	Petrol	1717	4	87.00	29
AR 30747	Petrol	1717	4	87.00	29
AR 30753	Petrol	1351	4	80.00	11
AR 30755	Petrol	1351	4	80.00	11
AR 31000	Petrol	1186	4	80.00	11
AR 31010	Petrol	1351	4	80.00	11
AR 32102 Euro 2	Petrol	1598	4	82.00	15

ENGINE INDEX





Motorverzeichnis • Index de moteur • Índice de Motor
 Indeks silnika • Модель двигателя • دليل المحرك

CCM





9

AR 32103 Euro 3	Petrol	1598	4	82.00	16
AR 32104 Euro 3	Petrol	1598	4	82.00	16
AR 32201	Petrol	1747	4	82.00	16
AR 32205	Petrol	1747	4	82.00	16
AR 32301	Petrol	1970	4	83.00	22
AR 32302 Euro 2	Diesel	1910	4	82.00	17
AR 32310	Petrol	1970	4	83.00	23
AR 32401	Petrol	2492	V6	88.00	31
AR 32405	Petrol	2492	V6	88.00	31
AR 32501 Euro 2	Diesel	2387	5	82.00	17
AR 33201	Petrol	1596	4	84.00	25
AR 33401	Petrol	1717	4	87.00	29
AR 33501	Petrol	1351	4	80.00	11
AR 33503	Petrol	1371	4	82.00	18
AR 33601	Diesel	1929	4	82.60	19
AR 34103	Petrol	1970	4	83.00	22
AR 34201	Petrol	2492	V6	88.00	31
AR 34202 Euro 2	Diesel	2387	5	82.00	17
AR 34301	Petrol	2959	V6	93.00	38
AR 36101	Petrol	2959	V6	93.00	38
AR 36201	Petrol	2492	V6	88.00	31
AR 36202 Euro 3	Diesel	2387	5	82.00	13
AR 36301	Petrol	1970	4	83.00	23
AR 37101 Euro 3	Diesel	1910	4	82.00	13
AR 37203 Euro 3	Petrol	1598	4	82.00	16
AR 38201 Euro 2	Petrol	1598	4	82.00	15
AR 38401	Petrol	1747	4	82.00	16
AR 38501	Petrol	1371	4	82.00	18
AR 61101	Petrol	1567	4	78.00	7
AR 61102	Petrol	1779	4	80.00	10
AR 61201	Petrol	1779	4	80.00	10
AR 61503	Petrol	2959	V6	93.00	37
AR 64103	Petrol	1995	4	84.00	25
AR 64301	Petrol	2959	V6	93.00	37
AR 67101	Petrol	1773	4	84.00	25
AR 67102	Petrol	1773	4	84.00	25
AR 67106	Petrol	1747	4	82.00	16
AR 67201	Petrol	1995	4	84.00	25
AR 67202	Petrol	1970	4	83.00	22
AR 67203	Petrol	1995	4	84.00	28
AR 67204	Petrol	1970	4	83.00	22
AR 67301	Petrol	2492	V6	88.00	30
AR 67302	Petrol	2492	V6	88.00	30
AR 67303	Petrol	2492	V6	88.00	30
AR 67501	Diesel	1929	4	82.60	19
AR 67601 Euro 2	Petrol	1598	4	82.00	15
VM 4HT 2.4	Diesel	2393	4	92.00	33
VM 4HT/2	Diesel	1995	4	88.00	32
VM 07 B	Diesel	2500	4	92.00	33
VM 08 B	Diesel	2500	4	92.00	33
VM 31 B	Diesel	2500	4	92.00	33
VM 32 B	Diesel	2500	4	92.00	33
VM 80 A	Diesel	1995	4	88.00	32
VM 81 A	Diesel	2393	4	92.00	33
VM 82 A	Diesel	1779	3	92.00	33
VM 84 A	Diesel	2500	4	92.00	33
VM 96 A	Diesel	1779	3	92.00	33
VM HR 588 HT	Diesel	2494	5	88.00	32



Mito 1.3 JTDM		09/08→	199 A3.000	4cyl. 1248cc 66kW (89PS) Diesel Turbo Intercooled	1
Mito 1.3 JTDM		10/09→	199 B1.000 Euro 5	4cyl. 1248cc 70kW (95PS) Diesel Turbo Intercooled	TD23450
Mito 1.3 JTDM		01/11→	199 B4.000 Euro 5	4cyl. 1248cc 62kW (84PS) Diesel Turbo Intercooled	TD24590
08-435700-00 08-435706-00	STD 0.40mm	69.60	1.500 1.500 2.000	 001 GDC P  005 P  231 LKZ CR P  	KV4 F12/F14 GOE13

Mito 1.4 Turbo		09/08→	198 A1.000	4cyl. 1368cc 110kW (150PS) Turbo Intercooled	2
Giulietta 1.4 BiFuel Giulietta 1.4 TB Mito 1.4 Mito 1.4 Bifuel		12/11→ 04/10→ 09/08→ 07/11→	198 A4.000	4cyl. 1368cc 88kW (120PS) Turbo Intercooled	TD23452
Mito 1.4 TB		09/08→	198 A7.000	4cyl. 1368cc 103kW (140PS) Turbo Intercooled	TD23921
Mito 1.4 TB		09/08→	199 A8.000	4cyl. 1368cc 114kW (155PS) Turbo Intercooled	TD24646
Giulietta 1.4 TB Mito 1.4 TB		04/10→ 10/09→	940 A2.000 Euro 5	4cyl. 1368cc 125kW (170PS) Turbo Intercooled	TD21700
Giulietta 1.4 TB		04/10→	940 A6.000 Euro 5	4cyl. 1368cc 85kW (116PS) Turbo Intercooled	TD23920
Mito 1.4 TB		10/09→	955 A7.000	4cyl. 1368cc 99kW (135PS) Turbo Intercooled	TD24794
Giulietta 1.4 TB Mito 1.4 TB		04/10→ 10/09→	955 A8.000 Euro 5	4cyl. 1368cc 120kW (163PS) Turbo Intercooled	TD24940

08-438300-00 08-438306-00	STD 0.40mm	72.00	1.200 1.200 2.000	 021 GDC P  026 P  231 LKZ CR P  	KV1 GOE13 GOE13
--	---------------	--------------	-------------------------	--	-----------------------



Mito 1.4	03/11→	199 A1.000	4cyl. 1368cc	57kW (78PS)	3
					TD21699

Mito 1.4	03/11→	350 A1.000 Euro4/5	4cyl. 1368cc	57kW (77PS)	
					TD26416

Mito 1.4	05/11→	955 A9.000	4cyl. 1368cc	51kW (69PS)	
					TD26417

08-436800-00 08-436806-00	STD 0.40mm	72.00	1.000		001 IF NT	ST
			1.200		026 P	GOE13
			2.000		231 LKZ CR P	KV1

Mito 1.4	09/08→	199 A6.000	4cyl. 1368cc	70kW (95PS)	4
					TD23447

Mito 1.4	09/08→	955 A1.000	4cyl. 1368cc	58kW (79PS)	
					TD23448

08-433200-00 08-433206-00	STD 0.40mm	72.00	1.000		001 IF NT	ST
			1.200		005 IF P	GOE13
			2.000		231 P	GOE13

Giulia 1300 Super, Giulia GT 1300 Super	01/74→12/78	AR 00530	4cyl. 1290cc	64-65kW (87-89PS)	5
GT 1300 Junior	01/66→12/77				
Spider 1300	01/68→12/77				
					TD23

08-530400-00	STD	74.00	1.500		001 IF	
			1.750		026	
			4.000		032	



Giulia 1600 Super Giulia GT 1600 Super Spider 1600	06/64→12/78 01/74→12/78 03/66→12/90	AR 00526	4cyl. 1567cc	75-80kW (102-109PS)	6
					TD22

GT 1600 Spider 1600	01/66→12/77 03/66→12/79	AR 00536	4cyl. 1567cc	80kW (109PS)	
					TD24

Alfetta 1.6 Alfetta GT 1.6 Giulietta 1.6 Spider 1600	01/75→12/84 01/76→09/82 10/77→04/85 03/66→12/68	AR 01600	4cyl. 1567cc	79-80kW (108-109PS)	
					TD32

75 1.6	05/85→09/89	AR 06100	4cyl. 1567cc	81kW (110PS)	
					TD47

08-527200-00	STD	78.00	1.500		001 IF CR P	IKA
[R46410]			1.750		026 P	GOE12
			4.000		032 P	GOE12







75 1.6	05/85→02/92	AR 61101	4cyl. 1567cc	81kW (110PS)	7
					TD102

08-527300-00	STD	78.00	1.500		001 CR P	IKA
[R46420]			1.750		026 P	GOE12
			3.500		232 P	GOE12

Giulia 1.8 D	06/76→12/78	4.108 (Perkins)	4cyl. 1760cc	38kW (52PS)	8
					TD141

08-313400-00	STD	79.38	1.990		001 IF CR P	STD
[R34610]			1.600		001 IF P	STD
			1.600		023 P	STD
			4.747		231 P	STD
			4.747		031 P	STD
08-315200-00	STD	79.38	1.990		001 IF CR P	KV1
[R34590]			1.600		005 IF P	STD
			1.600		005 IF P	STD
			3.160		026 P	STD
			4.747		231 P	STD



Mito 1.6 JTDM		09/08 →	198 A2.000		4cyl. 1598cc 88kW (120PS) Diesel Turbo Intercooled		9
							TD21698
Mito 1.6 JTDM		09/08 →	955 A3.000 Euro 5		4cyl. 1598cc 88kW (120PS) Diesel Turbo Intercooled		10
							TD24591
08-429300-00	STD	79.50	2.000		001 GDC P		KV4
			1.750		026 P		F12/F14
			2.000		231 LKZ CR P		GOE13
							
1750		03/68 → 10/72	AR 00548		4cyl. 1779cc 83-97kW (113-132PS)		10
GT V 1750		01/67 → 12/72					TD18
Spider 1750		01/67 → 12/71					
Alfetta 1.8		10/79 → 12/84	AR 01608		4cyl. 1779cc 89kW (121PS)		TD5340
Alfetta GT 1.8		01/74 → 12/76					
Alfetta 1.8		07/74 → 12/77	AR 01608 X		4cyl. 1779cc 85kW (116PS)		TD33
Alfetta GT 1.8		01/74 → 12/76					
Alfetta 1.8		10/79 → 12/84	AR 01678		4cyl. 1779cc 90kW (122PS)		TD38
Giulietta 1.8		04/79 → 04/85					
75 1.8		09/88 → 02/92	AR 06168		4cyl. 1779cc 88kW (120PS)		TD54
75 1.8		09/85 → 06/89	AR 06202		4cyl. 1779cc 85kW (116PS)		TD55
90 1.8		10/84 → 07/87					
75 1.8		09/88 → 02/92	AR 61102		4cyl. 1779cc 88kW (120PS)		TD10149
75 1.8		08/89 → 02/92	AR 61201		4cyl. 1779cc 90kW (122PS)		TD103
08-528500-00	STD	80.00	1.500		001 IF CR P		KV1
[R47830]			1.750		026 P		GOE12
			3.500		232 P		GOE12



Alfasud 1.2 Alfasud Giardinetta 1.2 Arna 1.2	06/72→09/84 01/78→12/81 03/83→12/86	AR 30102	4cyl. 1186cc	50kW (68PS)	11 TD5335
Alfasud 1.2	03/80→09/84	AR 30102 S	4cyl. 1186cc	50kW (68PS)	TD5336
Alfasud 1.2 ti	11/73→09/84	AR 30104	4cyl. 1186cc	50kW (68PS)	TD77
Alfasud 1.3 Super Alfasud Giardinetta 1.3	01/79→09/84 03/80→12/81	AR 30160	4cyl. 1287cc	50kW (68PS)	TD81
Alfasud 1.3 SC/ti Super Alfasud Sprint 1.4	09/77→09/84 05/78→02/80	AR 30164	4cyl. 1351cc	55kW (75PS)	TD82
33 1.3 33 1.3 i.e. Alfasud 1.3 ti Alfasud Sprint 1.4 Arna 1.3 TI	10/84→12/89 05/83→12/89 03/80→12/84 07/79→12/89 03/83→12/86	AR 30168	4cyl. 1351cc	63kW (86PS)	TD83
Alfasud 1.3 Alfasud Giardinetta 1.3	01/78→02/80 01/78→07/79	AR 30180	4cyl. 1287cc	48-50kW (65-68PS)	TD84
Arna 1.2	01/85→12/86	AR 30500	4cyl. 1186cc	50kW (68PS)	TD87
33 1.3	05/83→12/89	AR 30502	4cyl. 1351cc	55kW (75PS)	TD88
33 1.3	06/83→12/89	AR 30586	4cyl. 1351cc	63kW (86PS)	TD96
33 1.3 33 Sportwagon 1.4 33 Sportwagon 1.4 i.e. 4x4	10/84→12/89 01/84→12/88 06/91→09/94	AR 30587	4cyl. 1351cc	63kW (86PS)	TD97
33 1.4 4x4		AR 30732	B4cyl. 1351cc	66kW (89PS)	TD107
33 1.4 i.e., 33 Sportwagon 1.4 i.e.	06/91→09/94	AR 30753	4cyl. 1351cc	66kW (89PS)	TD119
33 1.4 4x4 33 1.4 i.e., 33 Sportwagon 1.4 i.e., 33 Sportwagon 1.4 i.e. 4x4	07/90→12/92 06/91→09/94	AR 30755	4cyl. 1351cc	66kW (89PS)	TD120





Arna 1.2	01/85→12/86	AR 31000	4cyl. 1186cc	50kW (68PS)	TD99
Arna 1.3 TI	03/83→12/86	AR 31010	4cyl. 1351cc	63kW (86PS)	TD100
145 1.4 i.e. 146 1.4 i.e.	07/94→12/96 12/94→12/96	AR 33501	4cyl. 1351cc	66kW (89PS)	TD123
08-107800-10	STD	80.00	1.500	001 IW CR P	KV1
[R46460]			1.750	026 P	STD
			4.000	712 CR	ST
147 1.9 JTD 16V 156 1.9 JTD 16V 156 Sportwagon 1.9 JTD 16V	11/02→03/10 11/02→09/05 11/02→05/06	192 A5.000	4cyl. 1910cc	103kW (140PS) Diesel Turbo Intercooled	12 TD17981
147 1.9 JTD 16V 156 1.9 JTD, 156 Sportwagon 1.9 JTD	10/04→03/10 11/02→11/04	192 B1.000	4cyl. 1910cc	100kW (136PS) Diesel Turbo Intercooled	TD19061
156 2.4 JTD 156 Sportwagon 2.4 JTD 166 2.4 JTD	10/03→09/05 10/03→05/06 10/03→06/07	841 G.000 Euro 3	5cyl. 2387cc	129kW (175PS) Diesel Turbo Intercooled	TD18292
166 2.4 JTD	10/03→06/07	841 H.000	5cyl. 2387cc	129kW (175PS) Diesel Turbo Intercooled	TD18293
156 2.4 JTD 156 Sportwagon 2.4 JTD 166 2.4 JTD	06/03→09/05 06/03→05/06 10/03→06/07	841 M.000	5cyl. 2387cc	120-147kW (163-200PS) Diesel Turbo Intercooled	TD20934
156 2.4 JTD 156 Sportwagon 2.4 JTD 166 2.4 JTD	06/03→09/05 06/03→05/06 10/03→06/07	841 N.000	5cyl. 2387cc	120-147kW (163-200PS) Diesel Turbo Intercooled	TD22510
147 1.9 JTD 16V 156 1.9 JTD 156 Sportwagon 1.9 JTD	09/03→09/04 11/03→09/05 11/03→05/06	937 A4.000 Euro 3	4cyl. 1910cc	103kW (140PS) Diesel Turbo Intercooled	TD18844
147 1.9 JTDM 16V 156 1.9 JTD 156 Sportwagon 1.9 JTD 156 Sportwagon 1.9 JTD 16V Q4 GT 1.9 JTD	07/05→03/10 07/04→09/05 03/05→05/06 07/04→05/06 11/03→09/10	937 A5.000	4cyl. 1910cc	110kW (150PS) Diesel Turbo Intercooled	TD18078
147 1.9 JTDM 16V GT 1.9 JTD	06/08→03/10 05/08→09/10	937 A6.000	4cyl. 1910cc	125kW (170PS) Diesel Turbo Intercooled	TD24643





159 1.9 JTDM 16V	09/05→11/11	939 A2.000	4cyl.	1910cc	110kW (150PS)	
159 Sportwagon 1.9 JTDM 16V	03/06→11/11					
		Diesel	Turbo Intercooled			TD18473

159 2.4 JTDM	09/05→11/11	939 A3.000 Euro 4	5cyl.	2387cc	147kW (200PS)	
159 Sportwagon 2.4 JTDM	03/06→11/11					
Brera 2.4 JTDM 20V	01/06→					
Spider 2.4 JTDM	04/07→	Diesel	Turbo Intercooled			TD18474

08-146100-00	STD	82.00	2.000		001 CK P	KV1
08-146106-00	0.40mm				023 IWU P	F12/F14
08-146108-00	0.60mm		2.000		231 CK P	GOE12
[R67925]			2.000			

156 2.4 JTD	10/00→09/05	839 A6.000 Euro 3	5cyl.	2387cc	103kW (140PS)	13
156 Sportwagon 2.4 JTD	10/00→05/06					
166 2.4 JTD	10/00→06/07	Diesel	Turbo Intercooled			TD18819

156 2.4 JTD	03/02→09/05	841 C.000 Euro 3	5cyl.	2387cc	100-110kW (136-150PS)	
156 Sportwagon 2.4 JTD	03/02→05/06					
166 2.4 JTD	04/02→06/07	Diesel	Turbo Intercooled			TD16383

147 1.9 JTD	04/01→03/10	937 A2.000 Euro 3	4cyl.	1910cc	85kW (116PS)	
156 1.9 JTD	05/01→09/05					
156 Sportwagon 1.9 JTD	05/01→05/06	Diesel	Turbo Intercooled			TD16382

156 2.4 JTD, 156 Sportwagon 2.4 JTD		AR 36202 Euro 3	5cyl.	2387cc	100-110kW (136-150PS)	
		Diesel	Turbo Intercooled			TD15636

147 1.9 JTD	11/00→09/04	AR 37101 Euro 3	4cyl.	1910cc	73-103kW (100-140PS)	
156 1.9 JTD, 156 Sportwagon 1.9 JTD	10/00→05/01					
		Diesel	Turbo Intercooled			TD15510

08-107900-00	STD	82.00	2.500		001 CR P	KV1
08-107908-00	0.60mm				026 P	F12/F14
[R49850]			2.000		231 CR P	GOE13

08-124000-00	STD	82.00	2.000		001 CK P	KV1
08-124006-00	0.40mm				026 P	F12/F14
08-124008-00	0.60mm		2.000		231 CR P	GOE12
[R60580]			2.000			

159 1.8 MPI, 159 Sportwagon 1.8 MPI	03/07→11/11	939 A4.000	4cyl.	1796cc	96-103kW (131-140PS)	14
						TD20270

08-145400-00	STD	82.00	1.200		021 NT	ST
08-145406-00	0.40mm				005 IF P	KV1
[R67927]			2.000		231	GOE12



156 1.6 16V T.SPARK	09/97→09/05	AR 32102 Euro 2	15
156 Sportwagon 1.6 16V T.SPARK.	05/00→05/06	4cyl. 1598cc 88kW (120PS)	
TD14369			

145 1.6 i.e. 16V T.S.	12/96→01/01	AR 38201 Euro 2	
146 1.6 i.e. 16V T.S.	11/96→01/01	4cyl. 1598cc 88kW (120PS)	
TD9754			

145 1.6 i.e. 16V T.S.	12/96→01/01	AR 67601 Euro 2	
146 1.6 i.e. 16V T.S.	11/96→01/01	4cyl.	
155 1.6 16V T.S.	05/96→12/97	1598cc 88kW (120PS)	
156 1.6 16V T.SPARK	09/97→09/05		
156 Sportwagon 1.6 16V T.SPARK.	05/00→05/06		TD19

08-118000-00	STD	82.00	1.190		001 NT	KV1
08-118006-00	0.40mm				005 IWU P	IKA
08-118008-00	0.60mm				231 P	STD
[R60000]			2.000			

156 1.6 16V T.SPARK	09/97→09/05	AR 32103 Euro 3	16
156 Sportwagon 1.6 16V T.SPARK.	05/00→05/06	4cyl. 1598cc 88kW (120PS)	
TD15389			

147 1.6 16V T.SPARK	01/01→03/10	AR 32104 Euro 3	
156 1.6 16V T.SPARK	09/97→09/05	4cyl.	
156 Sportwagon 1.6 16V T.SPARK.	05/00→05/06	1598cc 88kW (120PS)	
TD15388			

145 1.8 i.e. 16V, 146 1.8 i.e. 16V T.S.	03/98→01/01	AR 32201	
156 1.8 16V T.SPARK	09/97→10/00	4cyl.	
156 Sportwagon 1.8 16V T.SPARK	05/00→10/00	1747cc 106kW (144PS)	
GTV 1.8 16V	05/98→10/05		
Spider 1.8 16V	05/98→04/05		TD9462

156 1.8 16V T.SPARK	10/00→09/05	AR 32205	
156 Sportwagon 1.8 16V T.SPARK	10/00→05/06	4cyl.	
GT 1.8 TS	11/03→09/10	1747cc 103kW (140PS)	
TD15390			

147 1.6 16V T.SPARK ECO	01/01→03/10	AR 37203 Euro 3	
		4cyl. 1598cc 76kW (103PS)	
TD15508			

145 1.8 i.e. 16V T.S.	12/96→12/98	AR 38401	
146 1.8 i.e. 16V T.S.	11/96→01/01	4cyl. 1747cc 103kW (140PS)	
TD9755			

145 1.8 i.e. 16V T.S.	12/96→12/98	AR 67106	
146 1.8 i.e. 16V T.S.	11/96→01/01	4cyl.	
155 1.7 T.S. 16V	05/96→12/97	1747cc 103kW (140PS)	
TD5070			

08-118000-00	STD	82.00	1.190		001 NT	KV1
08-118006-00	0.40mm				005 IWU P	IKA
08-118008-00	0.60mm				231 P	STD
[R60000]			2.000			
08-145400-00	STD	82.00	1.200		021 NT	ST
08-145406-00	0.40mm				005 IF P	KV1
					231	GOE12
[R67927]			2.000			



145 1.9 JTD, 146 1.9 JTD	02/99→01/01	AR 32302 Euro 2	4cyl.	17
156 1.9 JTD	09/97→10/00	1910cc 77kW (105PS)		
156 Sportwagon 1.9 JTD	05/00→10/00	Diesel Turbo Intercooled		

17

TD9769

156 2.4 JTD	09/97→10/00	AR 32501 Euro 2	5cyl.
156 Sportwagon 2.4 JTD	05/00→10/00	2387cc 100kW (136PS)	
		Diesel Turbo Intercooled	

TD9770

166 2.4 JTD	09/98→10/00	AR 34202 Euro 2	5cyl.
		2387cc 100kW (136PS)	
		Diesel Turbo Intercooled	

TD11604

08-108000-00	STD	82.00	3.000		008 CK P	KV1
08-108008-00	0.60mm		2.000		026 P	F12/F14
[R49870]			3.000		231 CR P	GOE13

145 1.4 i.e. 16V T.S.	12/96→01/01	AR 33503	4cyl.	18
146 1.4 i.e. 16V T.S.	11/96→01/01	1371cc 76kW (103PS)		

18

TD9752

145 1.4 i.e. 16V T.S.	12/96→01/01	AR 38501	4cyl.
146 1.4 i.e. 16V T.S.	11/96→01/01	1371cc 76kW (103PS)	

TD9753

08-787000-00	STD	82.00	1.500		001 CR P	KV1
08-787006-00	0.40mm		1.500		026 P	STD
[R48590]			3.000		712 CR	ST

AR 6 Box 1.9 D, AR 6 Bus 1.9 D	04/85→12/89	160 D100	4cyl.	19
		1929cc 66-68kW (90-92PS)		
		Diesel Turbo Intercooled		

19

TD10307

145 1.9 TD	10/94→02/99	AR 33601	4cyl.
146 1.9 TD	12/94→02/99	1929cc 66-68kW (90-92PS)	
		Diesel Turbo Intercooled	

TD5069

145 1.9 TD	10/94→02/99	AR 67501	4cyl.
146 1.9 TD	12/94→02/99	1929cc 66-68kW (90-92PS)	
155 1.9 TD	04/93→12/97	Diesel Turbo Intercooled	

TD140

08-783800-00	STD	82.60	3.000		008 MOL P	KV1
08-783808-00	0.60mm		2.000		005 IFU P	F12/F14
[R47150]			3.000		231 CR P	STD



			198 A5.000						20
				4cyl.					
				1956cc	121kW	(165PS)			
			Diesel	Turbo Intercooled					TD24647
159 2.0 JTDM, 159 Sportwagon 2.0 JTDM		05/09→11/11	844 A2.000						
Brera 2.0 JTDM		03/08→		4cyl.					
Spider 2.0 JTDM		04/09→		1956cc	120kW	(163PS)			
			Diesel	Turbo Intercooled					TD24594
159 2.0 JTDM, 159 Sportwagon 2.0 JTDM		05/09→11/11	939 B3.000						
Brera 2.0 JTDM, Spider 2.0 JTDM		05/09→		4cyl.					
				1956cc	125kW	(170PS)			
			Diesel	Turbo Intercooled					TD23107
159 2.0 JTDM, 159 Sportwagon 2.0 JTDM		06/10→11/11	939 B4.000						
				4cyl.					
				1956cc	100kW	(136PS)			
			Diesel	Turbo Intercooled					TD24644
159 2.0 JTDM, 159 Sportwagon 2.0 JTDM		05/09→11/11	939 B5.000						
Brera 2.0 JTDM, Spider 2.0 JTDM		05/09→		4cyl.					
				1956cc	125kW	(170PS)			
			Diesel	Turbo Intercooled					TD24645
Giulietta 2.0 JTDM		04/10→	940 A4.000						
				4cyl.					
				1956cc	125kW	(170PS)			
			Diesel	Turbo Intercooled					TD23924
Giulietta 2.0 JTDM		04/10→	940 A5.000 Euro 5						
				4cyl.					
				1956cc	103kW	(140PS)			
			Diesel	Turbo Intercooled					TD24578
Giulietta 2.0 JTDM		04/10→	940 A7.000 Euro 5						
				4cyl.					
				1956cc	120kW	(163PS)			
			Diesel	Turbo Intercooled					TD24793
Giulietta 2.0 JTDM		04/10→	940 A8.000 Euro 5						
				4cyl.					
				1956cc	100kW	(136PS)			
			Diesel	Turbo Intercooled					TD25424
08-436500-00	STD	83.00	1.500		001 GDC P				KV4
08-436506-00	0.40mm		1.500		050 P				F12/F14
			2.000		231 LKZ CK P				GOE13

			156 Sportwagon 2.0							
			GT 2.0 JTS	03/02→05/06	932 A2.000					21
				11/03→09/10		4cyl.				
						1970cc	121kW	(165PS)		
										TD18076
147 2.0			156 2.0 JTS	07/02→05/05	937 A1.000					
156 Sportwagon 2.0 JTS			GT 2.0 JTS	03/02→09/05		4cyl.				
GT 2.0 JTS			GTV 2.0 JTS	03/02→05/06		1970cc	119-122kW	(162-166PS)		
GT 2.0 JTS			Spider 2.0 JTS	11/03→09/10						
GTV 2.0 JTS				04/03→10/05						
Spider 2.0 JTS				04/03→04/05						TD16381
08-145200-00	STD	83.00	1.200		023 NT					ST
08-145206-00	0.40mm		1.200		023 P					GOE13
[R67923]			2.000		231 NT					GOE13



GTV 2.0 T.SPARK 16V Spider 2.0 T.SPARK 16V	06/95→10/05 06/95→04/05	AR 16201	4cyl. 1970cc	110kW (150PS)	22	TD4188
145 2.0 16V Quadrifoglio, 146 2.0 16V Quadrifoglio 156 2.0 16V T.SPARK 156 Sportwagon 2.0 16V T.SPARK GTV 2.0 T.SPARK 16V, Spider 2.0 T.SPARK 16V	03/98→01/01 09/97→10/00 05/00→10/00 05/98→08/00	AR 32301	4cyl. 1970cc	110-121kW (150-165PS)		TD9463
166 2.0 T.Spark	09/98→10/00	AR 34103	4cyl. 1970cc	110-121kW (150-165PS)		TD11599
155 2.0 T.S.	02/92→02/95	AR 67202	4cyl. 1970cc	110kW (150PS)		TD137
145 2.0 16V T.S., 146 2.0 16V T.S. 155 2.0 T.S. 16V	10/95→01/01 03/95→12/97	AR 67204	4cyl. 1970cc	110kW (150PS)		TD4190

08-110900-00	STD	83.00	1.200		001 CR	ST
08-110906-00	0.40mm		1.500		026 P	STD
[R60020]			3.000		231 CR P	STD

147 2.0 16V T.SPARK 156 2.0 16V T.SPARK, 156 Sportwagon 2.0 16V T.SPARK GTV 2.0 T.SPARK 16V Spider 2.0 T.SPARK 16V	01/01→03/10 10/00→03/02 06/95→10/05 06/95→04/05	AR 32310	4cyl. 1970cc	110kW (150PS)	23	TD15391
166 2.0 T.Spark	10/00→06/07	AR 36301	4cyl. 1970cc	110kW (150PS)		TD15392

08-124700-00	STD	83.00	1.190		023 P NT	KV1
08-124706-00	0.40mm		1.200		026 P	GOE13
08-124708-00	0.60mm		2.000		231 P	GOE13
[R66790]						
08-145300-00	STD	83.00	1.200		023 NT	ST
08-145306-00	0.40mm		1.200		026 P	GOE13
[R67924]			2.000		231 P	GOE13



2000 GT, 2000 Spider, 2000 Veloce	01/73→12/81	116 (33)	4cyl. 1962cc	94kW (128PS)	24	FM3549
Alfetta 2.0 Alfetta GT 2.0	03/77→02/80 07/78→01/86	AR 01623	4cyl. 1962cc	94kW (128PS)		TD34
Alfetta 2.0 Alfetta GT 2.0 Giulietta 2.0 GTV 2.0	07/78→12/84 06/77→12/84 06/80→04/85 07/78→01/86	AR 01655	4cyl. 1962cc	94kW (128PS)		TD37
75 2.0 90 2.0 i.e. GTV 2.0	05/85→10/88 10/84→07/87 07/78→01/86	AR 06212	4cyl. 1962cc	94kW (128PS)		TD57
1750 2000 Alfetta 2.0	10/71→12/83 07/78→12/84	AR 10520	4cyl. 1962cc	94kW (128PS)		TD10270
Giulietta 2.0	06/80→04/85	AR 11671	4cyl. 1962cc	94kW (128PS)		TD70

08-107100-00	STD	84.00	1.500		001 IW CR P	KV1
			1.750		023 P	STD
			4.500		232 P	STD
08-107100-10	STD	84.00	1.500		001 IW CR P	KV1
			1.750		023 P	STD
			4.000		232 P	STD

Spider 2000	01/90→12/93	AR 01588	4cyl. 1962cc	88kW (120PS)	25	TD30
75 2.0 T.S.	01/87→02/92	AR 06166	4cyl. 1962cc	107kW (146PS)		TD53
75 2.0 T.S. 75 2.0 T.S.	05/85→02/92 01/87→02/92	AR 06224	4cyl. 1962cc	107-109kW (146-148PS)		TD58
164 2.0 T.S.	06/87→09/92	AR 06416	4cyl. 1962cc	107kW (146PS)		TD62
164 2.0 T.S.	06/87→12/90	AR 06420	4cyl. 1962cc	107kW (146PS)		TD63





145 1.6 i.e. 146 1.6 i.e.			10/94→12/96 12/94→12/96	AR 33201	4cyl. 1596cc	76kW (103PS)	TD121
164 2.0 T.S.			09/92→09/98	AR 64103	4cyl. 1995cc	107kW (146PS)	TD129
75 1.8 155 1.8 T.S. 155 1.8 T.S. Sport			08/89→02/92 02/92→06/93 01/92→12/96	AR 67101	4cyl. 1773cc	93kW (126PS)	TD133
155 1.8 T.S. Sport			01/92→12/96	AR 67102	4cyl. 1773cc	93kW (126PS)	TD5311
155 2.0 T.S.			02/92→04/93	AR 67201	4cyl. 1995cc	107kW (146PS)	TD136
08-110200-00	STD	84.00	1.500		001 IF CR P		KV1
[R46450]			1.500		005 IF P		STD
			3.500		236 P		STD
164 2.0 Turbo			10/87→09/98	AR 06476	4cyl. 1995cc	128-129kW (174-175PS) Turbo Intercooled	26 TD65
08-215300-10 08-215306-10 08-215308-10	STD 0.40mm 0.60mm	84.00	1.500 2.000 3.947		001 IF CR P 026 P 232 P		KV1 STD STD
[R46970]							
Alfasud 1.5 ti Alfasud Sprint 1.5			01/79→09/84 05/78→12/81	AR 30124	4cyl. 1490cc	77kW (105PS)	27 TD78
Alfasud 1.5 ti Alfasud Sprint 1.5			03/80→12/84 07/79→01/87	AR 30128	4cyl. 1490cc	77kW (105PS)	TD79
33 1.5			06/83→12/85	AR 30143	4cyl. 1490cc	70-77kW (95-105PS)	TD10131
33 1.5 4x4 33 1.5 QV 33 Sportwagon 1.5 33 Sportwagon 1.5 4x4 Alfasud 1.5 ti Sprint Alfasud Sprint 1.5 Alfasud Sprint 1.5 Veloce			09/86→12/89 06/84→12/89 12/86→12/89 12/86→03/89 01/83→12/84 01/83→12/87 01/80→12/87	AR 30146	4cyl. 1490cc	77kW (105PS)	TD80





33 1.5		05/83→12/93	AR 30182				
33 Sportwagon 1.5 4x4		09/84→12/87		4cyl.			
Arna 1.5		01/85→12/86		1490cc	77kW (105PS)		TD10128
Alfasud 1.3 ti		09/77→09/84	AR 30184				
Alfasud Sprint 1.3		09/76→12/81		4cyl.			
				1490cc	77kW (105PS)		TD85
33 1.5		06/83→12/85	AR 30504				
33 1.5 4x4		11/83→12/84		4cyl.			
				1490cc	62kW (84PS)		TD89
33 1.5 QV		06/84→12/89	AR 30508				
33 Sportwagon 1.5		12/86→12/89		4cyl.			
33 Sportwagon 1.5 4x4		12/86→03/89		1490cc	77kW (105PS)		TD90
33 1.5 4x4		01/84→12/89	AR 30514				
33 Sportwagon 1.5		09/84→12/87		4cyl.			
				1490cc	77kW (105PS)		TD6373
33 1.5		06/83→12/86	AR 30520				
33 1.5 4x4		01/85→09/86		4cyl.			
33 Sportwagon 1.5, 33 Sportwagon 1.5 4x4		09/84→12/86		1490cc	77kW (105PS)		TD91
08-109000-10	STD	84.00	1.500		001 IW CR P		KV1
08-109008-10	0.60mm				026 P		STD
[R46470]					712 CR		ST
155 2.0 16V Turbo Q4		01/92→12/97	AR 67203				28
				4cyl.			
				1995cc	137-140kW (186-190PS)		TD138
				Turbo Intercooled			
08-142400-00	STD	84.00	1.500		001 IF CK		KV1
08-142406-00	0.40mm				026 P		STD
[R47970]					231 P		STD
33 1.7		01/86→12/89	AR 30550				29
33 1.7 QV, 33 Sportwagon 1.7		03/88→12/89		4cyl.			
Alfasud Sprint 1.7		03/87→12/89		1717cc	84kW (114PS)		TD4186
33 1.7 i.e., 33 Sportwagon 1.7 i.e.,		09/88→12/89	AR 30558				
33 Sportwagon 1.7 i.e. 4x4				4cyl.			
Alfasud Sprint 1.7 i.e.		10/87→12/89		1717cc	84kW (114PS)		TD93
33 1.7 i.e.		01/90→09/94	AR 30736				
33 1.7 i.e. 4x4, 33 Sportwagon 1.7 i.e.,		01/90→03/92		4cyl.			
33 Sportwagon 1.7 i.e. 4x4				1717cc	77kW (105PS)		TD109
33 1.7 i.e.		01/90→09/94	AR 30737				
33 1.7 i.e. 4x4		01/90→03/92		4cyl.			
33 Sportwagon 1.7 i.e.		01/90→09/94		1717cc	77kW (105PS)		
33 Sportwagon 1.7 i.e. 4x4		09/88→03/92					TD110





33 1.7 i.e.			04/92→09/94		AR 30737 A	4cyl. 1717cc	77kW (105PS)		TD111
33 1.7 16V			01/90→03/92		AR 30746	4cyl. 1717cc	95-98kW (130-133PS)		TD114
33 1.7 16V 4x4			01/90→09/94						
33 Sportwagon 1.7 16V			01/90→03/92						
33 1.7 16V, 33 1.7 16V 4x4, 33 Sportwagon 1.7 16V, 33 Sportwagon 1.7 16V 4x4			01/90→09/94		AR 30747	4cyl. 1717cc	95-98kW (130-133PS)		TD115
145 1.7 i.e. 16V			10/94→12/96		AR 33401	4cyl. 1717cc	95-98kW (130-133PS)		TD122
146 1.7 i.e. 16V			12/94→12/96						
08-110300-00	STD	87.00	1.500		001 IF CR P			IKA	
[R46490]			1.750		026 P			STD	
			3.000		712 CR			ST	
75 2.5 V6			05/85→08/86		AR 01646	V6cyl. 2492cc	110-116kW (150-158PS)		30 TD36
90 2.5 i.e. V6			10/84→07/87						
GTV 6 2.5			11/80→02/87						
75 2.5 V6 CAT			09/86→04/89		AR 01648	V6cyl. 2492cc	113kW (154PS)		TD10150
75 2.5 V6			05/85→08/86		AR 01911	V6cyl. 2492cc	110-115kW (150-156PS)		TD42
90 2.5 i.e. V6			10/84→07/87						
6 2.5 i.e.					AR 01913	V6cyl. 2492cc	116-118kW (158-160PS)		TD43
6 2.5 i.e.			04/79→12/86		AR 01928	V6cyl. 2492cc	110-117kW (150-159PS)		TD44
155 2.5 V6			02/92→09/96		AR 67301	V6cyl. 2492cc	121kW (165PS)		TD139
155 2.5 V6			10/92→12/97		AR 67302	V6cyl. 2492cc	121kW (165PS)		TD9468





155 2.5 V6			10/92→12/97	AR 67303	V6cyl. 2492cc	121kW (165PS)	TD9767
08-110500-00	STD	88.00	1.500		001 IF CR P		IKA
[R46510]	1.750			026 P		STD	
	4.000			712 CR		ST	
156 2.5 V6 24V			09/97→12/01	AR 32401	V6cyl. 2492cc	140kW (190PS)	31 TD9464
156 Sportwagon 2.5 V6 24V			05/00→10/00				
156 2.5 V6 24V			10/00→09/05	AR 32405	V6cyl. 2492cc	141kW (192PS)	TD15634
156 Sportwagon 2.5 V6 24V			10/00→05/06				
166 2.5 V6 24V			09/98→10/00	AR 34201	V6cyl. 2492cc	140kW (190PS)	TD11601
166 2.5 V6 24V			10/00→06/07	AR 36201	V6cyl. 2492cc	138kW (188PS)	TD15635
08-124600-00	STD	88.00	1.200		001 IW CR P		KV1
[R67000]	1.500			005 P		GOE13	
	3.500			232 P		GOE13	
Alfetta 2.0 TD			10/79→03/83	VM 4HT/2	4cyl. 1995cc	60-73kW (82-99PS)	32 TD160
				Diesel	Turbo		
75 2.0 TD			05/85→09/92	VM 80 A	4cyl. 1995cc	60-73kW (82-99PS)	TD151
				Diesel	Turbo		
6 2.5 TD			07/81→05/86	VM HR 588 HT	5cyl. 2494cc	79kW (107PS)	TD158
				Diesel	Turbo		
08-110000-00	STD	88.00	2.500		008 CR P		KV1
[R47710]	2.000			023 P		STD	
	4.000			231 CR P		STD	





155 2.5 TD		04/93→12/97	VM 07 B	4cyl. 2500cc Diesel Turbo	92kW (125PS)	33 TD149
164 2.5 TD		09/92→09/98	VM 08 B	4cyl. 2500cc Diesel Turbo	92kW (125PS)	TD9771
155 2.5 TD		04/93→12/97	VM 31 B	4cyl. 2500cc Diesel Turbo	92kW (125PS)	TD9768
164 2.5 TD		09/92→09/98	VM 32 B	4cyl. 2500cc Diesel Turbo	92kW (125PS)	TD127
Alfetta 2.4 TD		04/83→12/84	VM 4HT 2.4	4cyl. 2393cc Diesel Turbo	81kW (110PS)	TD159
75 2.4 TD 90 2.4 TD		01/89→02/92 10/84→07/87	VM 81 A	4cyl. 2393cc Diesel Turbo	81kW (110PS)	TD152
33 1.8 TD		01/86→06/90	VM 82 A	3cyl. 1779cc Diesel Turbo	53kW (72PS)	TD153
164 2.5 TD		06/87→09/92	VM 84 A	4cyl. 2500cc Diesel Turbo	85kW (116PS)	TD154
33 1.8 TD 33 Sportwagon 1.8 TD		07/90→09/94 01/86→12/89	VM 96 A	3cyl. 1779cc Diesel Turbo	53kW (72PS)	TD155
08-110100-00	STD	92.00	2.500	008 CR P		KV1
[R47730]			2.000	026 P		STD
			4.000	231 CR P		STD
AR 8 Box 2.4 TD AR 8 Platform/Chassis 2.4 TD		04/85→12/89 04/85→12/88	8140.21.200 D.I.	4cyl. 2445cc Diesel Turbo	68kW (92PS)	34 TD143
AR 6 Box 2.4 TD		09/86→12/89	8144.21.220 (Sofim)	4cyl. 2445cc Diesel Turbo	68kW (92PS)	TD145
08-245200-00	STD	93.00	3.000	008 CR P		KV1
08-245208-00	0.60mm		2.000	005 P		F12/F14
[R47080]			3.000	231 CR P		STD



AR 8 Box 2.4 D, AR 8 Platform/ Chassis 2.4 D		04/78→08/86	8140.61.200	4cyl. 2445cc	53kW (72PS)	35
			Diesel			TD144
AR 8 Furgone		01/78→12/79	8144.61	4cyl. 2445cc	53kW (72PS)	FM566
			Diesel			
AR 6 Box 2.4 D		04/85→02/86	8144.61.200	4cyl. 2445cc	53kW (72PS)	TD146
			Diesel			
08-214500-10	STD	93.00	3.000		001 CR P	KV1
08-214508-10	0.60mm		2.000		005 IF P	STD
[R47010]			4.000		231 CR P	STD
AR 6 Box 2.5 D		03/86→12/89	8144.67.220	4cyl. 2500cc	55kW (75PS)	36
AR 8 Box 2.5 D, AR 8 Platform/ Chassis 2.5 D		09/86→12/89		Diesel Turbo		TD147
08-783300-00	STD	93.00	3.000		001 CR P	KV1
08-783308-00	0.60mm		2.000		026 P	STD
[R47100]			3.000		231 CR P	STD
75 3.0 V6		01/87→12/90	AR 06120	V6cyl. 2959cc	132-141kW (180-192PS)	37
						TD48
75 3.0 V6		01/87→02/92	AR 06124	V6cyl. 2959cc	132-141kW (180-192PS)	TD49
164 3.0		11/87→09/91	AR 06410	V6cyl. 2959cc	147kW (200PS)	TD59
164 3.0 V6		06/87→09/92				
164 3.0 V6		06/87→09/92	AR 06412	V6cyl. 2959cc	147kW (200PS)	TD61
75 3.0 V6		02/90→02/92	AR 61503	V6cyl. 2959cc	132-141kW (180-192PS)	TD51
164 3.0 i.e. QV		09/90→09/92	AR 64301	V6cyl. 2959cc	147kW (200PS)	TD106
08-527500-00	STD	93.00	1.500		001 IF CR P	KV1
[R46500]			1.500		005 P	GOE12
			3.500		232 P	GOE12



GTV 3.0 V6 24V Spider 3.0 V6 24V	10/96→10/00 01/99→10/03	AR 16102	V6cyl. 2959cc	162kW (220PS)	38	TD5495
GTV 3.0 V6 24V Spider 3.0 V6	10/00→10/05 09/94→08/00	AR 16105	V6cyl. 2959cc	160kW (218PS)		TD15970
166 3.0 V6 24V	09/98→10/00	AR 34301	V6cyl. 2959cc	162kW (220PS)		TD11603
166 3.0 V6 24V	10/00→06/07	AR 36101	V6cyl. 2959cc	162kW (220PS)		TD15393

08-138800-00	STD	93.00	1.200		001 P NT	KV1
[R67340]			1.500		005 IWU P	GOE12
			3.500		232 P	GOE12

MODEL INDEX

Modelverzeichnis • Index de modele • Índice de Modelo
Indeks modelu • Модель автомобиля • دليل المحرك



CCM

x



9

06/84→10/99	10 1,4	1.4 (C2J)	Petrol	1397	4	2
01/83→12/98	240-244 2.5 D	XD3P	Diesel	2498	4	5
01/84→	Aro 10 S	1.6L D, 1.6L D/TD	Diesel	1588	4	3
01/84→	Aro 10 S	1.6L TD	Diesel	1588	4	3
01/80→12/84	Aro 24	XD4.90, XDP90	Diesel	2112	4	4
01/80→12/84	Aro 24	XDP4-90	Diesel	2112	4	4
01/80→12/83	Aro 100	1.3L, 810/25/26/29/03	Petrol	1289	4	1
01/80→12/83	Aro 101	1.3L, 810/25/26/29/03	Petrol	1289	4	1
01/80→12/83	Aro 103	1.3L, 810/25/26/29/03	Petrol	1289	4	1
01/80→12/83	Aro 104	1.3L, 810/25/26/29/03	Petrol	1289	4	1
01/84→	Duster	1.6L D, 1.6L D/TD	Diesel	1588	4	3
01/84→	Duster	1.6L TD	Diesel	1588	4	3

ENGINE INDEX

Motorverzeichnis • Index de moteur • Índice de Motor
Indeks silnika • Модель двигателя • دليل المحرك



CCM

x



9

1.3L, 810/25/26/29/03	Petrol	1289	4	73.00	1
1.4 (C2J)	Petrol	1397	4	76.00	2
1.6L D, 1.6L D/TD	Diesel	1588	4	76.50	3
1.6L TD	Diesel	1588	4	76.50	3
XD3P	Diesel	2498	4	94.00	5
XD4.90, XDP90	Diesel	2112	4	90.00	4
XDP4-90	Diesel	2112	4	90.00	4



Aro 100, Aro 101, Aro 103, Aro 104		01/80→12/83	1.3L, 810/25/26/29/03		4cyl. 1289cc	40kW (54PS)	1	FM1486

08-333400-10 [R66220]	STD	73.00	1.750		001 IF CR P	IKA
			2.000		026 P	STD
			4.000		712 CR	ST

10 1,4		06/84→10/99	1.4 (C2J)		4cyl. 1397cc	46-49kW (62-67PS)	2	TD201

08-333500-00 08-333505-00 08-333507-00 [R66190]	STD 0.25mm 0.50mm	76.00	1.750		001 IF CR P	IKA
			2.000		026 P	STD
			4.000		712 CR	ST

Aro 10 S, Duster		01/84→	1.6L D, 1.6L D/TD		4cyl. 1588cc	Diesel	3	FM9014

Aro 10 S, Duster		01/84→	1.6L TD		4cyl. 1588cc	Diesel Turbo	FM19014

08-109800-00 08-109807-00 08-109811-00 [R45270]	STD 0.50mm 1.00mm	76.50	1.750		001 IF CR P	KV1
			2.000		005 IFU CR P	IKA
			3.000		231 CR P	STD

Aro 24		01/80→12/84	XD4.90, XDP90		4cyl. 2112cc	Diesel	4	FM1425

Aro 24		01/80→12/84	XDP4-90		4cyl. 2112cc	42-48kW (57-65PS)	FM11425

08-314900-10 [R66070]	STD	90.00	2.000		001 IW CR P	KV1
			2.000		001 P	STD
			2.000		023 P	STD
			4.500		231 CR P	STD



240-244 2.5 D	01/83→12/98	XD3P	4cyl.	5
			2498cc	52-55kW (71-75PS)
		Diesel		TD202

08-318700-10	STD	94.00	2.000		001 CR P	KV1
08-318704-10	0.20mm				005 IF P	STD
08-318706-10	0.40mm				231 CR P	STD
08-318707-10	0.50mm					
08-318708-10	0.60mm					
08-318710-10	0.80mm					
08-318711-10	1.00mm					
<i>[R66140]</i>						



CCM

x



9

08/74→07/78	50 1.1	HB	Petrol	1093	4	1
08/74→07/77	50 1.1	HC	Petrol	1093	4	1
01/75→12/78	50 1.1	HD	Petrol	1093	4	1
08/77→07/78	50 1.3	HH	Petrol	1272	4	3
01/77→07/78	50 1.3	HJ	Petrol	1272	4	3
09/78→07/86	80 1.3	EP	Petrol	1297	4	2
09/78→07/81	80 1.3	FY	Petrol	1272	4	3
09/78→07/81	80 1.3	FZ	Petrol	1272	4	3
05/72→07/78	80 1.3	ZA	Petrol	1297	4	4
05/72→07/78	80 1.3	ZF	Petrol	1297	4	4
08/90→10/91	80 1.6	ABB	Petrol	1595	4	20
09/91→12/94	80 1.6	ABM	Petrol	1595	4	18
08/78→07/86	80 1.6	DT	Petrol	1595	4	18
08/78→07/86	80 1.6	DTA	Petrol	1595	4	18
08/78→07/86	80 1.6	JU	Petrol	1595	4	18
08/87→09/91	80 1.6	PP	Petrol	1595	4	18
09/86→08/91	80 1.6	RN	Petrol	1595	4	18
	80 1.6	RNA	Petrol	1595	4	20
02/86→07/86	80 1.6	SA	Petrol	1595	4	18
08/78→07/86	80 1.6	WV	Petrol	1588	4	16
09/75→07/83	80 1.6	WY	Petrol	1588	4	16
09/75→07/83	80 1.6	WZ	Petrol	1588	4	16
08/78→08/79	80 1.6	YG	Petrol	1588	4	16
08/78→07/86	80 1.6	YN	Petrol	1588	4	16
09/75→07/78	80 1.6	YN	Petrol	1588	4	16
08/78→02/83	80 1.6	YP	Petrol	1588	4	16
09/75→07/78	80 1.6	YP	Petrol	1588	4	16
08/78→07/81	80 1.6	YT	Petrol	1588	4	16
08/78→07/81	80 1.6	YY	Petrol	1588	4	16
08/80→08/86	80 1.6 D	CR	Diesel	1588	4	8
08/80→08/86	80 1.6 D	JK	Diesel	1588	4	8
09/86→08/91	80 1.6 D	JK	Diesel	1588	4	8
06/93→12/94	80 1.6 E	ADA	Petrol	1595	4	18
01/79→12/86	80 1.6 GLE	YZ	Petrol	1588	4	17
01/76→07/78	80 1.6 GTE	YS	Petrol	1588	4	17
08/81→05/86	80 1.6 TD	CY	Diesel	1588	4	10
09/86→08/91	80 1.6 TD	RA	Diesel	1588	4	10
09/86→08/91	80 1.6 TD	SB	Diesel	1588	4	10
01/83→08/86	80 1.8	DS	Petrol	1781	4	20
08/83→08/86	80 1.8	JN	Petrol	1781	4	18
01/83→08/86	80 1.8	JV	Petrol	1781	4	20
10/86→01/90	80 1.8	RU	Petrol	1781	4	18
09/86→07/88	80 1.8	SD	Petrol	1847	4	32
02/86→07/86	80 1.8	SF	Petrol	1781	4	18
08/85→08/86	80 1.8 CC quattro	JN	Petrol	1781	4	18
08/84→08/86	80 1.8 CC quattro	JV	Petrol	1781	4	20
08/84→08/86	80 1.8 CC quattro	NE	Petrol	1781	4	20
06/86→08/91	80 1.8 E	DZ	Petrol	1781	4	20
09/86→08/91	80 1.8 E quattro	DZ	Petrol	1781	4	20
10/84→08/86	80 1.8 GTE	DZ	Petrol	1781	4	20
08/85→07/86	80 1.8 GTE	PV	Petrol	1781	4	20
08/84→08/86	80 1.8 GTE quattro	DZ	Petrol	1781	4	20
03/85→08/86	80 1.8 GTE quattro	PV	Petrol	1781	4	20
09/86→08/90	80 1.8 quattro	MU	Petrol	1781	4	20
09/86→08/90	80 1.8 quattro	SD	Petrol	1847	4	32
09/86→10/91	80 1.8 S	JN	Petrol	1781	4	18
09/86→10/91	80 1.8 S	NE	Petrol	1781	4	20
09/86→10/91	80 1.8 S	PM	Petrol	1781	4	20
09/86→12/90	80 1.8 S	SF	Petrol	1781	4	18
09/86→09/91	80 1.8 S quattro	JN	Petrol	1781	4	18

MODEL INDEX

Modelverzeichnis • Index de modele • Índice de Modelo
Indeks modelu • Модель автомобиля • دليل الموديل



CCM

x



9

09/86→09/91	80 1.8 S quattro	NE	Petrol	1781	4	20
09/86→09/91	80 1.8 S quattro	PM	Petrol	1781	4	20
09/86→07/90	80 1.8 S quattro	SF	Petrol	1781	4	18
09/81→07/83	80 1.9 CD-5S	WN	Petrol	1921	5	16
08/89→08/91	80 1.9 D	1Y	Diesel	1896	4	12
09/91→12/94	80 1.9 TD	AAZ	Diesel	1896	4	12
09/91→12/94	80 1.9 TDI	1Z	Diesel	1896	4	13
08/89→08/91	80 1.9D	ADE	Diesel	1896	4	12
10/90→08/91	80 2.0	AAD	Petrol	1984	4	29
09/91→12/94	80 2.0	ABT	Petrol	1984	4	27
10/83→09/84	80 2.0	HP	Petrol	1994	5	18
10/83→09/84	80 2.0	JS	Petrol	1994	5	18
09/91→12/94	80 2.0 E	ABK	Petrol	1984	4	27
09/91→12/94	80 2.0 E	AXA	Petrol	1984	4	27
03/90→09/91	80 2.0 E 16V	6A	Petrol	1984	4	27
09/91→07/92	80 2.0 E 16V	6A	Petrol	1984	4	27
08/92→12/94	80 2.0 E 16V	ACE	Petrol	1984	4	27
03/90→08/91	80 2.0 E 16V quattro	6A	Petrol	1984	4	27
04/92→12/94	80 2.0 E 16V quattro	ACE	Petrol	1984	4	27
09/91→12/94	80 2.0 E quattro	ABK	Petrol	1984	4	27
09/91→12/94	80 2.0 E quattro	AXA	Petrol	1984	4	27
10/90→08/91	80 2.0 quattro	AAD	Petrol	1984	4	29
10/83→09/84	80 2.0 quattro	JS	Petrol	1994	5	18
10/80→07/83	80 2.2	WE	Petrol	2144	5	16
08/82→07/84	80 2.2 quattro	KK	Petrol	2144	5	16
08/82→07/84	80 2.2 quattro	KL	Petrol	2144	5	16
09/91→12/94	80 2.3 E	NG	Petrol	2309	5	30
09/91→12/94	80 2.3 E quattro	NG	Petrol	2309	5	30
10/87→07/89	80 2.3 quattro	NG	Petrol	2309	5	30
07/92→12/94	80 2.6	ABC	Petrol	2598	V6	30
06/92→12/94	80 2.6 quattro	ABC	Petrol	2598	V6	30
09/91→12/94	80 2.8	AAH	Petrol	2771	V6	27
09/91→12/94	80 2.8 quattro	AAH	Petrol	2771	V6	27
06/93→01/96	80 Avant 1.6 E	ADA	Petrol	1595	4	18
09/91→12/94	80 Avant 1.9 TD	AAZ	Diesel	1896	4	12
07/92→01/96	80 Avant 1.9 TDI	1Z	Diesel	1896	4	13
07/92→01/96	80 Avant 2.0	ABT	Petrol	1984	4	27
07/92→01/96	80 Avant 2.0 E	ABK	Petrol	1984	4	27
07/92→01/96	80 Avant 2.0 E	AXA	Petrol	1984	4	27
02/93→01/96	80 Avant 2.0 E 16V	ACE	Petrol	1984	4	27
12/92→07/95	80 Avant 2.0 E 16V quattro	ACE	Petrol	1984	4	27
11/93→01/96	80 Avant 2.0 quattro	ADW	Petrol	1985	4	27
07/92→01/96	80 Avant 2.3 E	NG	Petrol	2309	5	30
09/91→11/94	80 Avant 2.3 E quattro	NG	Petrol	2309	5	30
07/92→01/96	80 Avant 2.6	ABC	Petrol	2598	V6	30
07/92→07/95	80 Avant 2.6 quattro	ABC	Petrol	2598	V6	30
09/91→01/96	80 Avant 2.8	AAH	Petrol	2771	V6	27
08/92→07/95	80 Avant 2.8 quattro	AAH	Petrol	2771	V6	27
03/94→05/95	80 Avant RS2 quattro	ADU	Petrol	2226	5	20
02/93→07/95	80 Avant S2 quattro	ABY	Petrol	2226	5	20
02/93→12/94	80 S2 quattro	ABY	Petrol	2226	5	20
10/85→01/87	90 1.6 TD	CY	Diesel	1588	4	10
04/87→09/91	90 1.6 TD	RA	Diesel	1588	4	10
04/87→09/91	90 1.6 TD	SB	Diesel	1588	4	10
10/84→03/87	90 2.0	HP	Petrol	1994	5	18
10/84→03/87	90 2.0	JS	Petrol	1994	5	18
07/88→09/91	90 2.0	PS	Petrol	1994	5	18
03/86→03/87	90 2.0	SK	Petrol	1994	5	18
08/89→07/91	90 2.0 20 V	NM	Petrol	1994	5	20
08/88→09/91	90 2.0 20 V quattro	NM	Petrol	1994	5	20



CCM

x



9

08/89→07/90	90 2.0 quattro	6A	Petrol	1984	4	27
08/84→08/86	90 2.0 quattro	JS	Petrol	1994	5	18
10/84→03/87	90 2.2	HY	Petrol	2144	5	18
10/84→03/87	90 2.2	KV	Petrol	2226	5	18
01/85→03/87	90 2.2	KX	Petrol	2226	5	18
04/87→07/91	90 2.2 E	KV	Petrol	2226	5	18
08/85→03/87	90 2.2 E quattro	JT	Petrol	2226	5	18
04/87→09/91	90 2.2 E quattro	KV	Petrol	2226	5	18
11/84→03/87	90 2.2 E quattro	KV	Petrol	2226	5	18
04/87→07/91	90 2.3 E	NG	Petrol	2309	5	30
04/87→09/91	90 2.3 E	NG	Petrol	2309	5	30
04/90→07/91	90 2.3 E 20V	7A	Petrol	2309	5	28
08/88→07/91	90 2.3 E 20V	7A	Petrol	2309	5	28
04/90→09/91	90 2.3 E 20V quattro	7A	Petrol	2309	5	28
06/88→09/91	90 2.3 E 20V quattro	7A	Petrol	2309	5	28
04/87→07/91	90 2.3 E quattro	NG	Petrol	2309	5	30
04/87→09/91	90 2.3 E quattro	NG	Petrol	2309	5	30
01/75→07/76	100 1.6	YM	Petrol	1588	4	16
08/76→07/82	100 1.6	YV	Petrol	1588	4	16
08/82→12/87	100 1.8	DR	Petrol	1781	4	18
08/83→07/89	100 1.8	DS	Petrol	1781	4	20
08/83→07/89	100 1.8	JW	Petrol	1781	4	20
08/82→12/87	100 1.8	RS	Petrol	1781	4	20
02/86→07/88	100 1.8	SH	Petrol	1781	4	20
11/68→11/71	100 1.8	ZV	Petrol	1716	4	16
03/85→11/90	100 1.8 CAT	4B	Petrol	1781	4	20
03/85→11/90	100 1.8 CAT	PH	Petrol	1781	4	20
10/84→07/88	100 1.8 quattro	JW	Petrol	1781	4	20
08/86→07/90	100 1.8 quattro	SH	Petrol	1781	4	20
08/85→11/90	100 1.8 quattro CAT	4B	Petrol	1781	4	20
08/85→11/90	100 1.8 quattro CAT	PH	Petrol	1781	4	20
08/80→07/82	100 1.9	WH	Petrol	1921	5	16
08/82→07/84	100 1.9	WH	Petrol	1921	5	16
12/90→06/94	100 2.0	AAE	Petrol	1984	4	27
08/84→12/87	100 2.0	KP	Petrol	1994	5	18
08/86→11/87	100 2.0	SL	Petrol	1994	5	18
06/76→08/78	100 2.0	WA	Petrol	1984	4	39
01/88→11/90	100 2.0 CAT	RT	Petrol	1994	5	18
08/78→07/82	100 2.0 D	CN	Diesel	1986	5	8
08/82→07/88	100 2.0 D	CN	Diesel	1986	5	8
08/82→02/88	100 2.0 D Turbo	DE	Diesel	1986	5	10
03/88→11/90	100 2.0 D Turbo	NC	Diesel	1986	5	10
12/90→06/94	100 2.0 E	AAD	Petrol	1984	4	29
12/90→06/94	100 2.0 E	ABK	Petrol	1984	4	27
12/90→06/94	100 2.0 E	AXA	Petrol	1984	4	27
01/92→06/94	100 2.0 E 16V	ACE	Petrol	1984	4	27
07/92→06/94	100 2.0 E 16V quattro	ACE	Petrol	1984	4	27
12/90→07/92	100 2.0 E quattro	AAD	Petrol	1984	4	29
10/77→07/82	100 2.1	WB	Petrol	2144	5	16
03/77→07/82	100 2.1	WC	Petrol	2144	5	16
08/82→07/84	100 2.1	WC	Petrol	2144	5	16
10/77→07/82	100 2.1	WE	Petrol	2144	5	16
03/77→07/82	100 2.1	WG	Petrol	2144	5	16
08/82→07/84	100 2.2	KF	Petrol	2144	5	16
08/84→12/88	100 2.2	KU	Petrol	2226	5	18
10/84→09/86	100 2.2	KZ	Petrol	2226	5	18
08/82→07/84	100 2.2	WU	Petrol	2144	5	16
06/89→11/90	100 2.2 CAT	HX	Petrol	2226	5	18
06/89→11/90	100 2.2 CAT	KU	Petrol	2226	5	18
08/86→11/90	100 2.2 E Turbo quattro	MC	Petrol	2226	5	18

MODEL INDEX

Modelverzeichnis • Index de modele • Índice de Modelo
Indeks modelu • Модель автомобиля • دليل الموديل



CCM

x



9

08/84→12/88	100 2.2 quattro	KU	Petrol	2226	5	18
06/89→11/90	100 2.2 quattro CAT	HX	Petrol	2226	5	18
06/89→11/90	100 2.2 quattro CAT	KU	Petrol	2226	5	18
08/86→11/90	100 2.2 Turbo	MC	Petrol	2226	5	18
01/90→11/90	100 2.3 E	AAR	Petrol	2309	5	30
12/90→06/94	100 2.3 E	AAR	Petrol	2309	5	30
10/86→11/90	100 2.3 E	NF	Petrol	2309	5	30
12/90→06/94	100 2.3 E quattro	AAR	Petrol	2309	5	30
08/86→11/90	100 2.3 E quattro	NF	Petrol	2309	5	30
01/90→11/90	100 2.3 quattro	AAR	Petrol	2309	5	30
08/89→07/91	100 2.4 D	3D	Diesel	2370	5	12
12/90→06/94	100 2.4 D	AAS	Diesel	2370	5	12
01/90→11/90	100 2.5 TDI	1T	Diesel	2461	5	19
12/90→06/94	100 2.5 TDI	AAT	Diesel	2461	5	19
12/90→06/94	100 2.5 TDI	ABP	Diesel	2461	5	19
03/92→06/94	100 2.6	ABC	Petrol	2598	V6	30
07/93→06/94	100 2.6	ACZ	Petrol	2598	V6	30
04/92→06/94	100 2.6 quattro	ABC	Petrol	2598	V6	30
12/90→06/94	100 2.8 E	AAH	Petrol	2771	V6	27
12/90→06/94	100 2.8 E quattro	AAH	Petrol	2771	V6	27
07/77→02/83	100 Avant 1.6	YV	Petrol	1588	4	16
08/82→12/87	100 Avant 1.8	DR	Petrol	1781	4	18
08/83→07/89	100 Avant 1.8	DS	Petrol	1781	4	20
08/83→07/89	100 Avant 1.8	JW	Petrol	1781	4	20
08/82→12/87	100 Avant 1.8	RS	Petrol	1781	4	20
02/86→07/90	100 Avant 1.8	SH	Petrol	1781	4	20
03/85→11/90	100 Avant 1.8 CAT	4B	Petrol	1781	4	20
03/85→11/90	100 Avant 1.8 CAT	PH	Petrol	1781	4	20
10/84→07/88	100 Avant 1.8 quattro	JW	Petrol	1781	4	20
08/86→07/90	100 Avant 1.8 quattro	SH	Petrol	1781	4	20
08/85→10/90	100 Avant 1.8 quattro CAT	4B	Petrol	1781	4	20
08/85→10/90	100 Avant 1.8 quattro CAT	PH	Petrol	1781	4	20
02/83→07/84	100 Avant 1.9	WH	Petrol	1921	5	16
08/80→07/82	100 Avant 1.9	WH	Petrol	1921	5	16
09/86→11/87	100 Avant 2.0	SL	Petrol	1994	5	18
08/77→07/80	100 Avant 2.0	WA	Petrol	1984	4	39
03/83→11/90	100 Avant 2.0 D	CN	Diesel	1986	5	8
08/78→02/83	100 Avant 2.0 D	CN	Diesel	1986	5	8
09/91→06/94	100 Avant 2.0 E	AAD	Petrol	1984	4	29
09/91→06/94	100 Avant 2.0 E	AAE	Petrol	1984	4	27
09/91→06/94	100 Avant 2.0 E	ABK	Petrol	1984	4	27
09/91→06/94	100 Avant 2.0 E	AXA	Petrol	1984	4	27
01/85→12/87	100 Avant 2.0 E	KP	Petrol	1994	5	18
07/92→06/94	100 Avant 2.0 E 16V	ACE	Petrol	1984	4	27
07/92→06/94	100 Avant 2.0 E 16V quattro	ACE	Petrol	1984	4	27
01/88→11/90	100 Avant 2.0 E CAT	RT	Petrol	1994	5	18
12/90→07/92	100 Avant 2.0 E quattro	AAD	Petrol	1984	4	29
03/83→10/87	100 Avant 2.0 TD	DE	Diesel	1986	5	10
03/88→11/90	100 Avant 2.0 TD	NC	Diesel	1986	5	10
08/82→07/84	100 Avant 2.1	KF	Petrol	2144	5	16
07/77→02/83	100 Avant 2.1	WB	Petrol	2144	5	16
07/77→02/83	100 Avant 2.1	WC	Petrol	2144	5	16
08/82→07/84	100 Avant 2.1	WC	Petrol	2144	5	16
07/77→02/83	100 Avant 2.1	WE	Petrol	2144	5	16
07/77→02/83	100 Avant 2.1	WG	Petrol	2144	5	16
08/84→12/88	100 Avant 2.2	KU	Petrol	2226	5	18
10/84→09/86	100 Avant 2.2	KZ	Petrol	2226	5	18
06/89→11/90	100 Avant 2.2 CAT	HX	Petrol	2226	5	18
06/89→11/90	100 Avant 2.2 CAT	KU	Petrol	2226	5	18
08/84→12/88	100 Avant 2.2 quattro	KU	Petrol	2226	5	18



CCM

x



9

06/89→11/90	100 Avant 2.2 quattro CAT	HX	Petrol	2226	5	18
06/89→11/90	100 Avant 2.2 quattro CAT	KU	Petrol	2226	5	18
08/86→11/90	100 Avant 2.2 Turbo	MC	Petrol	2226	5	18
08/86→11/90	100 Avant 2.2 Turbo quattro	MC	Petrol	2226	5	18
03/90→11/90	100 Avant 2.3	AAR	Petrol	2309	5	30
08/86→11/90	100 Avant 2.3	NF	Petrol	2309	5	30
09/91→06/94	100 Avant 2.3 E	AAR	Petrol	2309	5	30
09/91→06/94	100 Avant 2.3 E quattro	AAR	Petrol	2309	5	30
08/86→11/90	100 Avant 2.3 E quattro	NF	Petrol	2309	5	30
01/90→11/90	100 Avant 2.3 quattro	AAR	Petrol	2309	5	30
08/89→11/90	100 Avant 2.4 D	3D	Diesel	2370	5	12
12/90→06/94	100 Avant 2.4 D	AAS	Diesel	2370	5	12
01/90→11/90	100 Avant 2.5 TDI	1T	Diesel	2461	5	19
12/90→06/94	100 Avant 2.5 TDI	AAT	Diesel	2461	5	19
12/90→06/94	100 Avant 2.5 TDI	ABP	Diesel	2461	5	19
03/92→06/94	100 Avant 2.6	ABC	Petrol	2598	V6	30
07/93→06/94	100 Avant 2.6	ACZ	Petrol	2598	V6	30
08/93→07/94	100 Avant 2.6 E quattro	ACZ	Petrol	2598	V6	30
07/92→06/94	100 Avant 2.6 quattro	ABC	Petrol	2598	V6	30
09/91→06/94	100 Avant 2.8 E	AAH	Petrol	2771	V6	27
09/91→06/94	100 Avant 2.8 E quattro	AAH	Petrol	2771	V6	27
09/91→06/94	100 Avant S4 Turbo quattro	AAN	Petrol	2226	5	20
08/91→06/94	100 S4 Turbo quattro	AAN	Petrol	2226	5	20
10/79→08/82	200	KJ	Petrol	2144	5	17
08/83→07/84	200 2.1 5 E	WC	Petrol	2144	5	16
10/79→09/82	200 2.1 5 E	WC	Petrol	2144	5	16
10/79→08/82	200 2.1 5 T	WJ	Petrol	2144	5	17
08/83→01/88	200 2.1 Turbo	KG	Petrol	2144	5	17
08/83→09/86	200 2.1 Turbo quattro	KG	Petrol	2144	5	17
08/84→07/85	200 2.2	KU	Petrol	2226	5	18
03/89→12/90	200 2.2 20V Turbo quattro	3B	Petrol	2226	5	20
02/88→12/90	200 2.2 Turbo	1B	Petrol	2226	5	18
02/88→12/90	200 2.2 Turbo	2B	Petrol	2226	5	18
08/85→09/91	200 2.2 Turbo	MC	Petrol	2226	5	18
02/88→11/90	200 2.2 Turbo quattro	1B	Petrol	2226	5	18
01/85→12/91	200 2.2 Turbo quattro	MC	Petrol	2226	5	18
11/86→09/91	200 2.3	NF	Petrol	2309	5	30
09/83→01/88	200 Avant 2.1 Turbo quattro	KG	Petrol	2144	5	17
07/89→12/90	200 Avant 2.2 20V Turbo quattro	3B	Petrol	2226	5	20
08/85→09/91	200 Avant 2.2 Turbo	MC	Petrol	2226	5	18
02/88→12/91	200 Avant 2.2 Turbo quattro	1B	Petrol	2226	5	18
09/83→12/90	200 Avant 2.2 Turbo quattro	MC	Petrol	2226	5	18
11/86→09/91	200 Avant 2.3	NF	Petrol	2309	5	30
08/85→03/87	4000 1.8i	MG	Petrol	1781	4	18
06/77→09/82	5000 2.2L	WD	Petrol	2144	5	16
05/10→	A1 1.4 TFSI	CAXA	Petrol	1390	4	7
05/10→	A1 1.4 TFSI	CNVA	Petrol	1390	4	7
01/11→	A1 1.4 TFSI	CTHG	Petrol	1390	4	9
03/11→	A1 1.6 TDI	CAYB	Diesel	1598	4	15
05/10→	A1 1.6 TDI	CAYC	Diesel	1598	4	15
05/12→	A1 2.0 TDI	CFHB	Diesel	1968	4	26
09/11→	A1 2.0 TDI	CFHD	Diesel	1968	4	26
11/11→	A1 Sportback 1.4 TFSI	CAXA	Petrol	1390	4	7
11/11→	A1 Sportback 1.4 TFSI	CNVA	Petrol	1390	4	7
11/11→	A1 Sportback 1.4 TFSI	CTHG	Petrol	1390	4	9
11/11→	A1 Sportback 1.6 TDI	CAYB	Diesel	1598	4	15
11/11→	A1 Sportback 1.6 TDI	CAYC	Diesel	1598	4	15
05/12→	A1 Sportback 2.0 TDI	CFHB	Diesel	1968	4	26
09/11→	A1 Sportback 2.0 TDI	CFHD	Diesel	1968	4	26
03/01→08/05	A2 1.2 TDI	ANY	Diesel	1191	3	5

MODEL INDEX

Modelverzeichnis • Index de modele • Índice de Modelo
Indeks modelu • Модель автомобиля • دليل الموديل



CCM

x



9

02/00→08/05	A2 1.4	AUA	Petrol	1390	4	6
02/00→08/05	A2 1.4	BBY	Petrol	1390	4	6
02/00→08/05	A2 1.4 TDI	AMF	Diesel	1422	3	13
11/03→08/05	A2 1.4 TDI	ATL	Diesel	1422	3	13
02/00→08/05	A2 1.4 TDI	BHC	Diesel	1422	3	13
09/07→08/12	A3 1.4 TFSI	CAXC	Petrol	1390	4	7
09/07→08/12	A3 1.4 TFSI	CMSA	Petrol	1390	4	7
09/96→05/03	A3 1.6	AEH	Petrol	1595	4	21
09/96→05/03	A3 1.6	AKL	Petrol	1595	4	21
09/96→05/03	A3 1.6	APF	Petrol	1595	4	21
08/00→05/03	A3 1.6	AVU	Petrol	1595	4	23
08/00→05/03	A3 1.6	BFQ	Petrol	1595	4	23
05/03→08/12	A3 1.6	BGU	Petrol	1595	4	23
05/03→08/12	A3 1.6	BSE	Petrol	1595	4	23
05/03→08/12	A3 1.6	BSF	Petrol	1595	4	23
05/03→08/12	A3 1.6	CCSA	Petrol	1595	4	23
08/03→09/07	A3 1.6 FSI	BLF	Petrol	1598	4	7
08/03→09/07	A3 1.6 FSI	BLP	Petrol	1598	4	7
05/09→08/12	A3 1.6 TDI	CAYB	Diesel	1598	4	15
05/09→08/12	A3 1.6 TDI	CAYC	Diesel	1598	4	15
09/96→05/03	A3 1.8	AGN	Petrol	1781	4	22
09/96→05/03	A3 1.8	APG	Petrol	1781	4	22
12/96→05/03	A3 1.8 T	AGU	Petrol	1781	4	22
12/98→05/03	A3 1.8 T	AJQ	Petrol	1781	4	22
12/98→05/03	A3 1.8 T	APP	Petrol	1781	4	22
12/96→05/03	A3 1.8 T	AQA	Petrol	1781	4	22
12/98→05/03	A3 1.8 T	ARY	Petrol	1781	4	22
12/96→05/03	A3 1.8 T	ARZ	Petrol	1781	4	22
12/96→05/03	A3 1.8 T	AUM	Petrol	1781	4	22
12/98→05/03	A3 1.8 T	AUQ	Petrol	1781	4	22
12/96→05/03	A3 1.8 T quattro	AGU	Petrol	1781	4	22
10/98→05/03	A3 1.8 T quattro	AJQ	Petrol	1781	4	22
12/96→05/03	A3 1.8 T quattro	AQA	Petrol	1781	4	22
12/96→05/03	A3 1.8 T quattro	ARX	Petrol	1781	4	22
10/98→05/03	A3 1.8 T quattro	ARY	Petrol	1781	4	22
09/96→07/01	A3 1.9 TDI	AGR	Diesel	1896	4	13
08/97→07/01	A3 1.9 TDI	AHF	Diesel	1896	4	13
09/96→07/01	A3 1.9 TDI	ALH	Diesel	1896	4	13
10/00→05/03	A3 1.9 TDI	ANU	Diesel	1896	4	13
08/97→07/01	A3 1.9 TDI	ASV	Diesel	1896	4	13
08/00→05/03	A3 1.9 TDI	ASZ	Diesel	1896	4	13
10/00→05/03	A3 1.9 TDI	ATD	Diesel	1896	4	13
10/00→05/03	A3 1.9 TDI	AXR	Diesel	1896	4	13
05/03→05/10	A3 1.9 TDI	BKC	Diesel	1896	4	14
05/03→05/10	A3 1.9 TDI	BLS	Diesel	1896	4	14
05/03→05/10	A3 1.9 TDI	BXE	Diesel	1896	4	14
08/00→05/03	A3 1.9 TDI quattro	ASZ	Diesel	1896	4	13
05/03→06/08	A3 2.0 FSI	AXW	Petrol	1984	4	31
05/03→06/08	A3 2.0 FSI	BLR	Petrol	1984	4	31
05/03→06/08	A3 2.0 FSI	BLX	Petrol	1984	4	31
05/03→06/08	A3 2.0 FSI	BLY	Petrol	1984	4	31
05/03→06/08	A3 2.0 FSI	BMB	Petrol	1984	4	31
05/03→06/08	A3 2.0 FSI	BVY	Petrol	1984	4	31
05/03→06/08	A3 2.0 FSI	BVZ	Petrol	1984	4	31
05/03→08/12	A3 2.0 TDI	AZV	Diesel	1968	4	25
06/05→06/08	A3 2.0 TDI	BMM	Diesel	1968	4	25
03/06→08/12	A3 2.0 TDI	BMN	Diesel	1968	4	25
06/06→06/08	A3 2.0 TDI	BUY	Diesel	1968	4	25
05/03→08/12	A3 2.0 TDI	CBAA	Diesel	1968	4	26
03/06→08/12	A3 2.0 TDI	CBBB	Diesel	1968	4	26



CCM

x



9

05/03→08/12	A3 2.0 TDI	CFFA	Diesel	1968	4	26
03/06→08/12	A3 2.0 TDI	CFGB	Diesel	1968	4	26
05/03→08/12	A3 2.0 TDI 16V	BKD	Diesel	1968	4	25
05/03→08/12	A3 2.0 TDI 16V	CBAB	Diesel	1968	4	26
05/03→08/12	A3 2.0 TDI 16V	CFFB	Diesel	1968	4	26
05/03→08/12	A3 2.0 TDI 16V	CLJA	Diesel	1968	4	26
08/04→08/12	A3 2.0 TDI 16V quattro	BKD	Diesel	1968	4	25
08/04→08/12	A3 2.0 TDI 16V quattro	CBAB	Diesel	1968	4	26
08/04→08/12	A3 2.0 TDI 16V quattro	CFFB	Diesel	1968	4	26
05/03→06/08	A3 2.0 TDI quattro	AZV	Diesel	1968	4	25
01/06→06/08	A3 2.0 TDI quattro	BMM	Diesel	1968	4	25
03/06→08/12	A3 2.0 TDI quattro	BMN	Diesel	1968	4	25
03/06→08/12	A3 2.0 TDI quattro	CBBB	Diesel	1968	4	26
03/06→08/12	A3 2.0 TDI quattro	CFGB	Diesel	1968	4	26
09/04→08/12	A3 2.0 TFSI	AXX	Petrol	1984	4	31
09/04→08/12	A3 2.0 TFSI	BWA	Petrol	1984	4	31
09/04→08/12	A3 2.0 TFSI quattro	AXX	Petrol	1984	4	31
09/04→08/12	A3 2.0 TFSI quattro	BWA	Petrol	1984	4	31
07/03→05/09	A3 3.2 V6 quattro	BDB	Petrol	3189	V6	36
07/03→05/09	A3 3.2 V6 quattro	BMJ	Petrol	3189	V6	36
07/03→05/09	A3 3.2 V6 quattro	BUB	Petrol	3189	V6	36
02/11→	A3 Convertible 1.4 TFSI	CAXC	Petrol	1390	4	7
09/08→	A3 Convertible 1.6	BSE	Petrol	1595	4	23
05/09→	A3 Convertible 1.6 TDI	CAYC	Diesel	1598	4	15
04/08→	A3 Convertible 1.9 TDI	BLS	Diesel	1896	4	14
04/08→	A3 Convertible 2.0 TDI	CBAA	Diesel	1968	4	26
04/08→	A3 Convertible 2.0 TDI	CBAB	Diesel	1968	4	26
04/08→	A3 Convertible 2.0 TDI	CFFA	Diesel	1968	4	26
04/08→	A3 Convertible 2.0 TDI	CFFB	Diesel	1968	4	26
03/99→04/02	A3 S3 quattro	AMK	Petrol	1781	4	24
03/99→04/02	A3 S3 quattro	APY	Petrol	1781	4	24
03/99→04/02	A3 S3 quattro	AUL	Petrol	1781	4	24
10/01→05/03	A3 S3 quattro	BAM	Petrol	1781	4	24
09/07→	A3 Sportback 1.4 TFSI	CAXC	Petrol	1390	4	7
09/07→	A3 Sportback 1.4 TFSI	CMSA	Petrol	1390	4	7
09/04→	A3 Sportback 1.6	BGU	Petrol	1595	4	23
09/04→	A3 Sportback 1.6	BSE	Petrol	1595	4	23
09/04→	A3 Sportback 1.6	BSF	Petrol	1595	4	23
09/04→	A3 Sportback 1.6	CCSA	Petrol	1595	4	23
09/04→	A3 Sportback 1.6 FSI	BLF	Petrol	1598	4	7
09/04→	A3 Sportback 1.6 FSI	BLP	Petrol	1598	4	7
05/09→	A3 Sportback 1.6 TDI	CAYB	Diesel	1598	4	15
05/09→	A3 Sportback 1.6 TDI	CAYC	Diesel	1598	4	15
09/04→05/10	A3 Sportback 1.9 TDI	BKC	Diesel	1896	4	14
09/04→05/10	A3 Sportback 1.9 TDI	BLS	Diesel	1896	4	14
09/04→05/10	A3 Sportback 1.9 TDI	BXE	Diesel	1896	4	14
09/04→	A3 Sportback 2.0 FSI	BLR	Petrol	1984	4	31
09/04→	A3 Sportback 2.0 FSI	BLX	Petrol	1984	4	31
09/04→	A3 Sportback 2.0 FSI	BLY	Petrol	1984	4	31
09/04→	A3 Sportback 2.0 FSI	BMB	Petrol	1984	4	31
09/04→	A3 Sportback 2.0 FSI	BVY	Petrol	1984	4	31
09/04→	A3 Sportback 2.0 FSI	BVZ	Petrol	1984	4	31
09/04→	A3 Sportback 2.0 TDI	AZV	Diesel	1968	4	25
06/05→06/08	A3 Sportback 2.0 TDI	BMM	Diesel	1968	4	25
03/06→	A3 Sportback 2.0 TDI	BMN	Diesel	1968	4	25
06/06→06/08	A3 Sportback 2.0 TDI	BUY	Diesel	1968	4	25
09/04→	A3 Sportback 2.0 TDI	CBAA	Diesel	1968	4	26
03/06→	A3 Sportback 2.0 TDI	CBBB	Diesel	1968	4	26
09/04→	A3 Sportback 2.0 TDI	CFFA	Diesel	1968	4	26
03/06→	A3 Sportback 2.0 TDI	CFGB	Diesel	1968	4	26

MODEL INDEX

Modelverzeichnis • Index de modele • Índice de Modelo
Indeks modelu • Модель автомобиля • دليل الموديل



CCM

x



9

09/04→	A3 Sportback 2.0 TDI 16V	BKD	Diesel	1968	4	25
09/04→	A3 Sportback 2.0 TDI 16V	CBAB	Diesel	1968	4	26
09/04→	A3 Sportback 2.0 TDI 16V	CFFB	Diesel	1968	4	26
09/04→	A3 Sportback 2.0 TDI 16V	CLJA	Diesel	1968	4	26
11/05→	A3 Sportback 2.0 TDI 16V quattro	BKD	Diesel	1968	4	25
11/05→	A3 Sportback 2.0 TDI 16V quattro	CBAB	Diesel	1968	4	26
11/05→	A3 Sportback 2.0 TDI 16V quattro	CFFB	Diesel	1968	4	26
01/06→06/08	A3 Sportback 2.0 TDI quattro	BMM	Diesel	1968	4	25
03/06→	A3 Sportback 2.0 TDI quattro	BMN	Diesel	1968	4	25
03/06→	A3 Sportback 2.0 TDI quattro	CBBB	Diesel	1968	4	26
03/06→	A3 Sportback 2.0 TDI quattro	CFGB	Diesel	1968	4	26
09/04→	A3 Sportback 2.0 TFSI	AXX	Petrol	1984	4	31
09/04→	A3 Sportback 2.0 TFSI	BPY	Petrol	1984	4	31
09/04→	A3 Sportback 2.0 TFSI	BWA	Petrol	1984	4	31
09/04→	A3 Sportback 2.0 TFSI quattro	AXX	Petrol	1984	4	31
09/04→	A3 Sportback 2.0 TFSI quattro	BWA	Petrol	1984	4	31
09/04→05/09	A3 Sportback 3.2 V6 quattro	BMJ	Petrol	3189	V6	36
09/04→05/09	A3 Sportback 3.2 V6 quattro	BUB	Petrol	3189	V6	36
11/94→10/00	A4 1.6	ADP	Petrol	1595	4	21
11/94→10/00	A4 1.6	AHL	Petrol	1595	4	21
07/00→11/00	A4 1.6	ALZ	Petrol	1595	4	23
11/00→12/04	A4 1.6	ALZ	Petrol	1595	4	23
11/04→06/08	A4 1.6	ALZ	Petrol	1595	4	23
11/94→10/00	A4 1.6	ANA	Petrol	1595	4	23
11/94→10/00	A4 1.6	ARM	Petrol	1595	4	21
01/95→11/00	A4 1.8	ADR	Petrol	1781	4	22
04/95→11/00	A4 1.8	AFY	Petrol	1781	4	22
05/00→09/00	A4 1.8	AMB	Petrol	1781	4	22
01/95→11/00	A4 1.8	APT	Petrol	1781	4	22
01/95→11/00	A4 1.8	ARG	Petrol	1781	4	22
01/95→11/00	A4 1.8	AVV	Petrol	1781	4	22
01/95→11/00	A4 1.8 quattro	ADR	Petrol	1781	4	22
07/95→11/00	A4 1.8 quattro	AFY	Petrol	1781	4	22
01/95→11/00	A4 1.8 quattro	APT	Petrol	1781	4	22
01/95→11/00	A4 1.8 quattro	ARG	Petrol	1781	4	22
01/95→11/00	A4 1.8 T	AEB	Petrol	1781	4	22
12/97→11/00	A4 1.8 T	AJL	Petrol	1781	4	22
07/01→12/04	A4 1.8 T	AMB	Petrol	1781	4	22
01/95→11/00	A4 1.8 T	ANB	Petrol	1781	4	22
01/95→11/00	A4 1.8 T	APU	Petrol	1781	4	22
01/95→11/00	A4 1.8 T	ARK	Petrol	1781	4	22
11/00→07/02	A4 1.8 T	AVJ	Petrol	1781	4	22
01/95→11/00	A4 1.8 T	AWT	Petrol	1781	4	22
11/02→12/04	A4 1.8 T	BEX	Petrol	1781	4	22
07/02→12/04	A4 1.8 T	BFB	Petrol	1781	4	22
11/04→06/08	A4 1.8 T	BFB	Petrol	1781	4	22
01/95→11/00	A4 1.8 T quattro	AEB	Petrol	1781	4	22
12/97→11/00	A4 1.8 T quattro	AJL	Petrol	1781	4	22
07/01→12/04	A4 1.8 T quattro	AMB	Petrol	1781	4	22
01/95→11/00	A4 1.8 T quattro	ANB	Petrol	1781	4	22
01/95→11/00	A4 1.8 T quattro	APU	Petrol	1781	4	22
01/95→11/00	A4 1.8 T quattro	ARK	Petrol	1781	4	22
11/00→07/02	A4 1.8 T quattro	AVJ	Petrol	1781	4	22
01/95→11/00	A4 1.8 T quattro	AWT	Petrol	1781	4	22
11/02→12/04	A4 1.8 T quattro	BEX	Petrol	1781	4	22
07/02→12/04	A4 1.8 T quattro	BFB	Petrol	1781	4	22
11/04→06/08	A4 1.8 T quattro	BFB	Petrol	1781	4	22
01/95→11/00	A4 1.9 TDI	1Z	Diesel	1896	4	13
12/95→11/00	A4 1.9 TDI	AFF	Diesel	1896	4	13
10/95→11/00	A4 1.9 TDI	AFN	Diesel	1896	4	13



CCM

x



9

01/95→11/00	A4 1.9 TDI	AHH	Diesel	1896	4	13
01/95→11/00	A4 1.9 TDI	AHU	Diesel	1896	4	13
03/00→11/00	A4 1.9 TDI	AJM	Diesel	1896	4	13
05/01→12/04	A4 1.9 TDI	AVB	Diesel	1896	4	13
11/00→12/04	A4 1.9 TDI	AVF	Diesel	1896	4	13
10/95→11/00	A4 1.9 TDI	AVG	Diesel	1896	4	13
11/00→12/04	A4 1.9 TDI	AWX	Diesel	1896	4	13
06/04→12/04	A4 1.9 TDI	BKE	Diesel	1896	4	14
11/04→06/08	A4 1.9 TDI	BKE	Diesel	1896	4	14
11/04→06/08	A4 1.9 TDI	BRB	Diesel	1896	4	14
09/96→11/00	A4 1.9 TDI quattro	AFN	Diesel	1896	4	13
03/00→11/00	A4 1.9 TDI quattro	AJM	Diesel	1896	4	13
03/00→11/00	A4 1.9 TDI quattro	ATJ	Diesel	1896	4	13
11/01→12/04	A4 1.9 TDI quattro	AVF	Diesel	1896	4	13
09/96→11/00	A4 1.9 TDI quattro	AVG	Diesel	1896	4	13
11/00→12/04	A4 2.0	ALT	Petrol	1984	4	31
11/04→06/08	A4 2.0	ALT	Petrol	1984	4	31
01/05→07/05	A4 2.0 FSi	AWA	Petrol	1984	4	31
07/02→12/04	A4 2.0 FSi	AWA	Petrol	1984	4	31
11/04→06/08	A4 2.0 TDI	BNA	Diesel	1968	4	25
11/04→06/08	A4 2.0 TDI	BPW	Diesel	1968	4	25
06/06→06/08	A4 2.0 TDI	BRD	Diesel	1968	4	25
11/04→06/08	A4 2.0 TDI	BRF	Diesel	1968	4	25
06/06→06/08	A4 2.0 TDI	BVA	Diesel	1968	4	25
11/05→11/06	A4 2.0 TDI	BVF	Diesel	1968	4	25
09/05→09/06	A4 2.0 TDI	BVG	Diesel	1968	4	25
11/07→	A4 2.0 TDI	CAGA	Diesel	1968	4	26
11/07→	A4 2.0 TDI	CAGB	Diesel	1968	4	26
06/08→	A4 2.0 TDI	CAGC	Diesel	1968	4	26
01/08→	A4 2.0 TDI	CAHA	Diesel	1968	4	26
08/08→	A4 2.0 TDI	CAHB	Diesel	1968	4	26
11/11→	A4 2.0 TDI	CGLC	Diesel	1968	4	26
08/08→	A4 2.0 TDI	CGLD	Diesel	1968	4	26
11/07→	A4 2.0 TDI	CJCA	Diesel	1968	4	26
11/07→	A4 2.0 TDI	CJCB	Diesel	1968	4	26
06/08→	A4 2.0 TDI	CJCC	Diesel	1968	4	26
11/07→	A4 2.0 TDI	CMEA	Diesel	1968	4	26
11/11→	A4 2.0 TDI	CMGB	Diesel	1968	4	26
11/04→06/08	A4 2.0 TDI 16V	BLB	Diesel	1968	4	25
11/04→06/08	A4 2.0 TDI 16V	BRE	Diesel	1968	4	25
01/06→06/08	A4 2.0 TDI quattro	BPW	Diesel	1968	4	25
06/06→06/08	A4 2.0 TDI quattro	BRD	Diesel	1968	4	25
06/06→06/08	A4 2.0 TDI quattro	BVA	Diesel	1968	4	25
11/08→	A4 2.0 TDI quattro	CAGA	Diesel	1968	4	26
01/08→	A4 2.0 TDI quattro	CAHA	Diesel	1968	4	26
11/11→	A4 2.0 TDI quattro	CGLC	Diesel	1968	4	26
11/08→	A4 2.0 TDI quattro	CJCA	Diesel	1968	4	26
10/06→06/08	A4 2.0 TFSI	BPJ	Petrol	1984	4	31
10/06→06/08	A4 2.0 TFSI	BYK	Petrol	1984	4	31
09/97→11/00	A4 2.5 TDI	AFB	Diesel	2496	V6	11
09/97→11/00	A4 2.5 TDI	AKN	Diesel	2496	V6	11
08/01→07/02	A4 2.5 TDI	AYM	Diesel	2496	V6	11
07/02→12/04	A4 2.5 TDI	BCZ	Diesel	2496	V6	11
07/02→12/04	A4 2.5 TDI	BDG	Diesel	2496	V6	11
11/04→05/06	A4 2.5 TDI	BDG	Diesel	2496	V6	11
07/02→12/04	A4 2.5 TDI	BFC	Diesel	2496	V6	11
09/97→11/00	A4 2.5 TDI quattro	AFB	Diesel	2496	V6	11
11/00→12/04	A4 2.5 TDI quattro	AKE	Diesel	2496	V6	11
09/97→11/00	A4 2.5 TDI quattro	AKN	Diesel	2496	V6	11
11/00→12/04	A4 2.5 TDI quattro	BAU	Diesel	2496	V6	11

MODEL INDEX

Modelverzeichnis • Index de modele • Índice de Modelo
Indeks modelu • Модель автомобиля • دليل الموديل



CCM

x



9

11/00→12/04	A4 2.5 TDI quattro	BDH	Diesel	2496	V6	11
01/95→11/00	A4 2.6	ABC	Petrol	2598	V6	30
01/96→07/97	A4 2.6	ACZ	Petrol	2598	V6	30
01/95→11/00	A4 2.6 quattro	ABC	Petrol	2598	V6	30
01/06→06/08	A4 2.7 TDI	BPP	Diesel	2698	V6	33
11/05→06/08	A4 2.7 TDI	BSG	Diesel	2698	V6	33
11/07→	A4 2.7 TDI	CAMA	Diesel	2698	V6	34
11/07→	A4 2.7 TDI	CAMB	Diesel	2698	V6	34
11/07→	A4 2.7 TDI	CGKA	Diesel	2698	V6	34
11/07→	A4 2.7 TDI	CGKB	Diesel	2698	V6	34
09/95→07/97	A4 2.8	AAH	Petrol	2771	V6	27
10/96→11/00	A4 2.8	ACK	Petrol	2771	V6	27
10/96→11/00	A4 2.8	ALG	Petrol	2771	V6	27
10/96→11/00	A4 2.8	AMX	Petrol	2771	V6	27
10/96→11/00	A4 2.8	APR	Petrol	2771	V6	27
10/96→11/00	A4 2.8	AQD	Petrol	2771	V6	27
01/95→07/97	A4 2.8 quattro	AAH	Petrol	2771	V6	27
10/96→08/01	A4 2.8 quattro	ACK	Petrol	2771	V6	27
10/96→08/01	A4 2.8 quattro	ALG	Petrol	2771	V6	27
10/96→08/01	A4 2.8 quattro	AMX	Petrol	2771	V6	27
10/96→08/01	A4 2.8 quattro	APR	Petrol	2771	V6	27
10/96→08/01	A4 2.8 quattro	AQD	Petrol	2771	V6	27
11/00→12/04	A4 3.0	ASN	Petrol	2976	V6	31
04/01→12/04	A4 3.0	BBJ	Petrol	2976	V6	31
11/04→05/06	A4 3.0	BBJ	Petrol	2976	V6	31
11/00→12/04	A4 3.0 quattro	ASN	Petrol	2976	V6	31
04/01→12/04	A4 3.0 quattro	BBJ	Petrol	2976	V6	31
11/04→07/06	A4 3.0 quattro	BBJ	Petrol	2976	V6	31
01/06→06/08	A4 3.0 TDI quattro	ASB	Diesel	2967	V6	33
11/04→06/08	A4 3.0 TDI quattro	BKN	Diesel	2967	V6	33
11/07→	A4 3.0 TDI quattro	CAPA	Diesel	2967	V6	34
11/07→	A4 3.0 TDI quattro	CCLA	Diesel	2967	V6	34
11/07→	A4 3.0 TDI quattro	CCWA	Diesel	2967	V6	34
06/08→	A4 3.0 TDI quattro	CCWB	Diesel	2967	V6	34
09/09→	A4 Allroad 2.0 TDI quattro	CAGA	Diesel	1968	4	26
09/09→	A4 Allroad 2.0 TDI quattro	CAGB	Diesel	1968	4	26
04/09→	A4 Allroad 2.0 TDI quattro	CAHA	Diesel	1968	4	26
04/09→	A4 Allroad 2.0 TDI quattro	CAHB	Diesel	1968	4	26
11/11→	A4 Allroad 2.0 TDI quattro	CGLC	Diesel	1968	4	26
04/09→	A4 Allroad 2.0 TDI quattro	CGLD	Diesel	1968	4	26
09/09→	A4 Allroad 2.0 TDI quattro	CJCA	Diesel	1968	4	26
09/09→	A4 Allroad 2.0 TDI quattro	CJCB	Diesel	1968	4	26
04/09→	A4 Allroad 3.0 TDI quattro	CCWA	Diesel	2967	V6	34
11/94→09/01	A4 Avant 1.6	ADP	Petrol	1595	4	21
11/94→09/01	A4 Avant 1.6	AHL	Petrol	1595	4	21
07/00→09/01	A4 Avant 1.6	ALZ	Petrol	1595	4	23
09/01→12/04	A4 Avant 1.6	ALZ	Petrol	1595	4	23
11/04→06/08	A4 Avant 1.6	ALZ	Petrol	1595	4	23
11/94→09/01	A4 Avant 1.6	ANA	Petrol	1595	4	23
11/94→09/01	A4 Avant 1.6	ARM	Petrol	1595	4	21
02/96→09/01	A4 Avant 1.8	ADR	Petrol	1781	4	22
07/95→09/01	A4 Avant 1.8	AFY	Petrol	1781	4	22
02/96→09/01	A4 Avant 1.8	APT	Petrol	1781	4	22
02/96→09/01	A4 Avant 1.8	ARG	Petrol	1781	4	22
02/96→09/01	A4 Avant 1.8	AVV	Petrol	1781	4	22
01/96→09/01	A4 Avant 1.8 quattro	ADR	Petrol	1781	4	22
07/95→09/01	A4 Avant 1.8 quattro	AFY	Petrol	1781	4	22
01/96→09/01	A4 Avant 1.8 quattro	APT	Petrol	1781	4	22
01/96→09/01	A4 Avant 1.8 quattro	ARG	Petrol	1781	4	22
03/96→09/01	A4 Avant 1.8 T	AEB	Petrol	1781	4	22



CCM

x



9

12/97→09/01	A4 Avant 1.8 T	AJL	Petrol	1781	4	22
03/96→09/01	A4 Avant 1.8 T	ANB	Petrol	1781	4	22
03/96→09/01	A4 Avant 1.8 T	APU	Petrol	1781	4	22
03/96→09/01	A4 Avant 1.8 T	ARK	Petrol	1781	4	22
09/01→07/02	A4 Avant 1.8 T	AVJ	Petrol	1781	4	22
03/96→09/01	A4 Avant 1.8 T	AWT	Petrol	1781	4	22
11/02→12/04	A4 Avant 1.8 T	BEX	Petrol	1781	4	22
07/02→12/04	A4 Avant 1.8 T	BFB	Petrol	1781	4	22
11/04→06/08	A4 Avant 1.8 T	BFB	Petrol	1781	4	22
01/96→09/01	A4 Avant 1.8 T quattro	AEB	Petrol	1781	4	22
12/97→09/01	A4 Avant 1.8 T quattro	AJL	Petrol	1781	4	22
09/01→12/04	A4 Avant 1.8 T quattro	AMB	Petrol	1781	4	22
01/96→09/01	A4 Avant 1.8 T quattro	ANB	Petrol	1781	4	22
01/96→09/01	A4 Avant 1.8 T quattro	APU	Petrol	1781	4	22
01/96→09/01	A4 Avant 1.8 T quattro	ARK	Petrol	1781	4	22
09/01→07/02	A4 Avant 1.8 T quattro	AVJ	Petrol	1781	4	22
01/96→09/01	A4 Avant 1.8 T quattro	AWT	Petrol	1781	4	22
11/02→12/04	A4 Avant 1.8 T quattro	BEX	Petrol	1781	4	22
07/02→12/04	A4 Avant 1.8 T quattro	BFB	Petrol	1781	4	22
11/04→06/08	A4 Avant 1.8 T quattro	BFB	Petrol	1781	4	22
03/98→09/01	A4 Avant 1.9 DUO	AHU	Diesel	1896	4	13
02/96→09/01	A4 Avant 1.9 TDI	1Z	Diesel	1896	4	13
03/96→09/01	A4 Avant 1.9 TDI	AFF	Diesel	1896	4	13
02/96→09/01	A4 Avant 1.9 TDI	AFN	Diesel	1896	4	13
02/96→09/01	A4 Avant 1.9 TDI	AHH	Diesel	1896	4	13
02/96→09/01	A4 Avant 1.9 TDI	AHU	Diesel	1896	4	13
03/00→09/01	A4 Avant 1.9 TDI	AJM	Diesel	1896	4	13
11/01→12/04	A4 Avant 1.9 TDI	AVB	Diesel	1896	4	13
09/01→12/04	A4 Avant 1.9 TDI	AVF	Diesel	1896	4	13
02/96→09/01	A4 Avant 1.9 TDI	AVG	Diesel	1896	4	13
09/01→12/04	A4 Avant 1.9 TDI	AWX	Diesel	1896	4	13
06/04→12/04	A4 Avant 1.9 TDI	BKE	Diesel	1896	4	14
11/04→06/08	A4 Avant 1.9 TDI	BKE	Diesel	1896	4	14
11/04→06/08	A4 Avant 1.9 TDI	BRB	Diesel	1896	4	14
09/96→09/01	A4 Avant 1.9 TDI quattro	AFN	Diesel	1896	4	13
03/00→09/01	A4 Avant 1.9 TDI quattro	AJM	Diesel	1896	4	13
03/00→09/01	A4 Avant 1.9 TDI quattro	ATJ	Diesel	1896	4	13
11/01→12/04	A4 Avant 1.9 TDI quattro	AVF	Diesel	1896	4	13
09/96→09/01	A4 Avant 1.9 TDI quattro	AVG	Diesel	1896	4	13
09/01→12/04	A4 Avant 2.0	ALT	Petrol	1984	4	31
11/04→06/08	A4 Avant 2.0	ALT	Petrol	1984	4	31
01/05→07/05	A4 Avant 2.0 FSi	AWA	Petrol	1984	4	31
07/02→12/04	A4 Avant 2.0 FSi	AWA	Petrol	1984	4	31
11/04→06/08	A4 Avant 2.0 TDI	BNA	Diesel	1968	4	25
11/04→06/08	A4 Avant 2.0 TDI	BPW	Diesel	1968	4	25
06/06→06/08	A4 Avant 2.0 TDI	BRD	Diesel	1968	4	25
11/04→06/08	A4 Avant 2.0 TDI	BRF	Diesel	1968	4	25
06/06→06/08	A4 Avant 2.0 TDI	BVA	Diesel	1968	4	25
11/05→11/06	A4 Avant 2.0 TDI	BVF	Diesel	1968	4	25
09/05→09/06	A4 Avant 2.0 TDI	BVG	Diesel	1968	4	25
04/08→	A4 Avant 2.0 TDI	CAGA	Diesel	1968	4	26
04/08→	A4 Avant 2.0 TDI	CAGB	Diesel	1968	4	26
06/08→	A4 Avant 2.0 TDI	CAGC	Diesel	1968	4	26
04/08→	A4 Avant 2.0 TDI	CAHA	Diesel	1968	4	26
08/08→	A4 Avant 2.0 TDI	CAHB	Diesel	1968	4	26
11/11→	A4 Avant 2.0 TDI	CGLC	Diesel	1968	4	26
08/08→	A4 Avant 2.0 TDI	CGLD	Diesel	1968	4	26
04/08→	A4 Avant 2.0 TDI	CJCA	Diesel	1968	4	26
04/08→	A4 Avant 2.0 TDI	CJCB	Diesel	1968	4	26
06/08→	A4 Avant 2.0 TDI	CJCC	Diesel	1968	4	26

MODEL INDEX

Modelverzeichnis • Index de modele • Índice de Modelo
Indeks modelu • Модель автомобиля • دليل المحرك



CCM

x



9

04/08→	A4 Avant 2.0 TDI	CMEA	Diesel	1968	4	26
11/04→06/08	A4 Avant 2.0 TDI 16V	BLB	Diesel	1968	4	25
11/04→06/08	A4 Avant 2.0 TDI 16V	BRE	Diesel	1968	4	25
01/06→06/08	A4 Avant 2.0 TDI quattro	BPW	Diesel	1968	4	25
06/06→06/08	A4 Avant 2.0 TDI quattro	BRD	Diesel	1968	4	25
06/06→06/08	A4 Avant 2.0 TDI quattro	BVA	Diesel	1968	4	25
04/08→	A4 Avant 2.0 TDI quattro	CAGA	Diesel	1968	4	26
08/08→	A4 Avant 2.0 TDI quattro	CAHA	Diesel	1968	4	26
11/11→	A4 Avant 2.0 TDI quattro	CGLC	Diesel	1968	4	26
04/08→	A4 Avant 2.0 TDI quattro	CJCA	Diesel	1968	4	26
10/06→06/08	A4 Avant 2.0 TFSI	BPJ	Petrol	1984	4	31
10/06→06/08	A4 Avant 2.0 TFSI	BYK	Petrol	1984	4	31
09/97→09/01	A4 Avant 2.5 TDI	AFB	Diesel	2496	V6	11
10/00→05/03	A4 Avant 2.5 TDi	AKE	Diesel	2496	V6	11
09/97→09/01	A4 Avant 2.5 TDI	AKN	Diesel	2496	V6	11
09/01→07/02	A4 Avant 2.5 TDI	AYM	Diesel	2496	V6	11
07/02→12/04	A4 Avant 2.5 TDI	BCZ	Diesel	2496	V6	11
07/02→12/04	A4 Avant 2.5 TDI	BDG	Diesel	2496	V6	11
11/04→05/06	A4 Avant 2.5 TDI	BDG	Diesel	2496	V6	11
07/02→12/04	A4 Avant 2.5 TDI	BFC	Diesel	2496	V6	11
09/97→09/01	A4 Avant 2.5 TDI quattro	AFB	Diesel	2496	V6	11
09/01→12/04	A4 Avant 2.5 TDI quattro	AKE	Diesel	2496	V6	11
09/97→09/01	A4 Avant 2.5 TDI quattro	AKN	Diesel	2496	V6	11
09/01→12/04	A4 Avant 2.5 TDI quattro	BAU	Diesel	2496	V6	11
09/01→12/04	A4 Avant 2.5 TDI quattro	BDH	Diesel	2496	V6	11
02/96→09/01	A4 Avant 2.6	ABC	Petrol	2598	V6	30
01/96→09/01	A4 Avant 2.6 quattro	ABC	Petrol	2598	V6	30
01/06→06/08	A4 Avant 2.7 TDI	BPP	Diesel	2698	V6	33
11/05→03/08	A4 Avant 2.7 TDi	BSG	Diesel	2698	V6	33
04/08→	A4 Avant 2.7 TDI	CAMA	Diesel	2698	V6	34
06/08→	A4 Avant 2.7 TDI	CAMB	Diesel	2698	V6	34
04/08→	A4 Avant 2.7 TDI	CGKA	Diesel	2698	V6	34
06/08→	A4 Avant 2.7 TDI	CGKB	Diesel	2698	V6	34
03/96→09/96	A4 Avant 2.8	AAH	Petrol	2771	V6	27
10/96→09/01	A4 Avant 2.8	ACK	Petrol	2771	V6	27
10/96→09/01	A4 Avant 2.8	ALG	Petrol	2771	V6	27
10/96→09/01	A4 Avant 2.8	AMX	Petrol	2771	V6	27
10/96→09/01	A4 Avant 2.8	APR	Petrol	2771	V6	27
10/96→09/01	A4 Avant 2.8	AQD	Petrol	2771	V6	27
03/99→09/00	A4 Avant 2.8	ATX	Petrol	2771	V6	27
01/96→09/96	A4 Avant 2.8 quattro	AAH	Petrol	2771	V6	27
10/96→09/01	A4 Avant 2.8 quattro	ACK	Petrol	2771	V6	27
10/96→09/01	A4 Avant 2.8 quattro	ALG	Petrol	2771	V6	27
10/96→09/01	A4 Avant 2.8 quattro	AMX	Petrol	2771	V6	27
10/96→09/01	A4 Avant 2.8 quattro	APR	Petrol	2771	V6	27
10/96→09/01	A4 Avant 2.8 quattro	AQD	Petrol	2771	V6	27
03/99→09/00	A4 Avant 2.8 quattro	ATX	Petrol	2771	V6	27
09/01→12/04	A4 Avant 3.0	ASN	Petrol	2976	V6	31
04/01→12/04	A4 Avant 3.0	BBJ	Petrol	2976	V6	31
11/04→05/06	A4 Avant 3.0	BBJ	Petrol	2976	V6	31
09/01→12/04	A4 Avant 3.0 quattro	ASN	Petrol	2976	V6	31
04/01→12/04	A4 Avant 3.0 quattro	BBJ	Petrol	2976	V6	31
11/04→07/06	A4 Avant 3.0 quattro	BBJ	Petrol	2976	V6	31
01/06→06/08	A4 Avant 3.0 TDI quattro	ASB	Diesel	2967	V6	33
11/04→06/08	A4 Avant 3.0 TDI quattro	BKN	Diesel	2967	V6	33
04/08→	A4 Avant 3.0 TDI quattro	CAPA	Diesel	2967	V6	34
04/08→	A4 Avant 3.0 TDI quattro	CCLA	Diesel	2967	V6	34
04/08→	A4 Avant 3.0 TDI quattro	CCWA	Diesel	2967	V6	34
06/08→	A4 Avant 3.0 TDI quattro	CCWB	Diesel	2967	V6	34
10/02→10/05	A4 Convertible 1.8	AMB	Petrol	1781	4	22



CCM

x



9

07/02→03/09	A4 Convertible 1.8 T	BFB	Petrol	1781	4	22
05/03→03/09	A4 Convertible 1.8 T quattro	BFB	Petrol	1781	4	22
09/04→12/05	A4 Convertible 2.0	ALT	Petrol	1984	4	31
01/06→03/09	A4 Convertible 2.0 TDI	BPW	Diesel	1968	4	25
08/02→12/05	A4 Convertible 2.5 TDI	BCZ	Diesel	2496	V6	11
08/02→12/05	A4 Convertible 2.5 TDI	BDG	Diesel	2496	V6	11
08/02→12/05	A4 Convertible 2.5 TDI	BFC	Diesel	2496	V6	11
06/06→03/09	A4 Convertible 2.7 TDI	BPP	Diesel	2698	V6	33
04/02→12/05	A4 Convertible 3.0	ASN	Petrol	2976	V6	31
05/03→12/05	A4 Convertible 3.0 quattro	ASN	Petrol	2976	V6	31
01/06→03/09	A4 Convertible 3.0 TDI quattro	ASB	Diesel	2967	V6	33
01/06→03/09	A4 Convertible 3.0 TDI quattro	BKN	Diesel	2967	V6	33
08/08→	A5 2.0 TDI	CAHA	Diesel	1968	4	26
08/08→	A5 2.0 TDI	CAHB	Diesel	1968	4	26
10/11→	A5 2.0 TDI	CGLC	Diesel	1968	4	26
08/08→	A5 2.0 TDI	CGLD	Diesel	1968	4	26
08/08→	A5 2.0 TDI quattro	CAHA	Diesel	1968	4	26
12/11→	A5 2.0 TDI quattro	CGLC	Diesel	1968	4	26
06/07→	A5 2.7 TDI	CAMA	Diesel	2698	V6	34
09/07→	A5 2.7 TDI	CAMB	Diesel	2698	V6	34
06/07→	A5 2.7 TDI	CGKA	Diesel	2698	V6	34
09/07→	A5 2.7 TDI	CGKB	Diesel	2698	V6	34
06/07→	A5 3.0 TDI quattro	CAPA	Diesel	2967	V6	34
06/07→	A5 3.0 TDI quattro	CCWA	Diesel	2967	V6	34
03/08→	A5 3.0 TDI quattro	CCWB	Diesel	2967	V6	34
05/09→	A5 Convertible 2.0 TDI	CAHA	Diesel	1968	4	26
05/09→	A5 Convertible 2.0 TDI	CAHB	Diesel	1968	4	26
10/11→	A5 Convertible 2.0 TDI	CGLC	Diesel	1968	4	26
05/09→	A5 Convertible 2.0 TDI	CGLD	Diesel	1968	4	26
10/11→	A5 Convertible 2.0 TDI	CJCA	Diesel	1968	4	26
01/12→	A5 Convertible 2.0 TDI quattro	CGLC	Diesel	1968	4	26
03/09→	A5 Convertible 2.7 TDI	CGKA	Diesel	2698	V6	34
05/09→	A5 Convertible 2.7 TDI	CGKB	Diesel	2698	V6	34
03/09→	A5 Convertible 3.0 TDI quattro	CCWA	Diesel	2967	V6	34
09/09→	A5 Sportback 2.0 TDI	CAGA	Diesel	1968	4	26
09/09→	A5 Sportback 2.0 TDI	CAGB	Diesel	1968	4	26
09/09→	A5 Sportback 2.0 TDI	CAHA	Diesel	1968	4	26
09/09→	A5 Sportback 2.0 TDI	CAHB	Diesel	1968	4	26
10/11→	A5 Sportback 2.0 TDI	CGLC	Diesel	1968	4	26
09/09→	A5 Sportback 2.0 TDI	CGLD	Diesel	1968	4	26
09/09→	A5 Sportback 2.0 TDI	CJCA	Diesel	1968	4	26
09/09→	A5 Sportback 2.0 TDI	CJCB	Diesel	1968	4	26
09/09→	A5 Sportback 2.0 TDI	CMEA	Diesel	1968	4	26
09/09→	A5 Sportback 2.0 TDI quattro	CAHA	Diesel	1968	4	26
12/11→	A5 Sportback 2.0 TDI quattro	CGLC	Diesel	1968	4	26
09/09→	A5 Sportback 2.7 TDI	CGKA	Diesel	2698	V6	34
09/09→	A5 Sportback 2.7 TDI	CGKB	Diesel	2698	V6	34
09/09→	A5 Sportback 3.0 TDI quattro	CCWA	Diesel	2967	V6	34
12/95→10/97	A6 1.8	ADR	Petrol	1781	4	22
05/97→01/05	A6 1.8	AFY	Petrol	1781	4	22
07/97→01/05	A6 1.8	AJP	Petrol	1781	4	22
07/97→01/05	A6 1.8	AQE	Petrol	1781	4	22
07/97→01/05	A6 1.8	ARH	Petrol	1781	4	22
12/95→10/97	A6 1.8 quattro	ADR	Petrol	1781	4	22
01/97→01/05	A6 1.8 T	AEB	Petrol	1781	4	22
12/97→01/05	A6 1.8 T	AJL	Petrol	1781	4	22
01/97→01/05	A6 1.8 T	ANB	Petrol	1781	4	22
01/97→01/05	A6 1.8 T	APU	Petrol	1781	4	22
01/97→01/05	A6 1.8 T	ARK	Petrol	1781	4	22
01/97→01/05	A6 1.8 T	AWT	Petrol	1781	4	22

MODEL INDEX

Modelverzeichnis • Index de modele • Índice de Modelo
Indeks modelu • Модель автомобиля • دليل الموديل



CCM

x



9

02/97→01/05	A6 1.8 T quattro	AEB	Petrol	1781	4	22
12/97→01/05	A6 1.8 T quattro	AJL	Petrol	1781	4	22
02/97→01/05	A6 1.8 T quattro	ANB	Petrol	1781	4	22
02/97→01/05	A6 1.8 T quattro	APU	Petrol	1781	4	22
02/97→01/05	A6 1.8 T quattro	ARK	Petrol	1781	4	22
02/97→01/05	A6 1.8 T quattro	AWT	Petrol	1781	4	22
06/94→10/97	A6 1.9 TDI	1Z	Diesel	1896	4	13
04/97→10/00	A6 1.9 TDI	AFN	Diesel	1896	4	13
06/94→10/97	A6 1.9 TDI	AHU	Diesel	1896	4	13
07/00→01/05	A6 1.9 TDI	AJM	Diesel	1896	4	13
08/01→01/05	A6 1.9 TDI	AVF	Diesel	1896	4	13
04/97→10/00	A6 1.9 TDI	AVG	Diesel	1896	4	13
08/01→01/05	A6 1.9 TDI	AWX	Diesel	1896	4	13
06/94→10/97	A6 2.0	AAE	Petrol	1984	4	27
06/94→10/97	A6 2.0	ABK	Petrol	1984	4	27
08/95→07/96	A6 2.0	ADW	Petrol	1985	4	27
08/01→01/05	A6 2.0	ALT	Petrol	1984	4	31
06/94→10/97	A6 2.0	AXA	Petrol	1984	4	27
06/94→10/97	A6 2.0 16V	ACE	Petrol	1984	4	27
06/94→10/97	A6 2.0 16V quattro	ACE	Petrol	1984	4	27
07/04→10/08	A6 2.0 TDI	BLB	Diesel	1968	4	25
07/04→03/11	A6 2.0 TDI	BNA	Diesel	1968	4	25
07/04→10/08	A6 2.0 TDI	BRE	Diesel	1968	4	25
07/04→03/11	A6 2.0 TDI	BRF	Diesel	1968	4	25
09/05→06/06	A6 2.0 TDI	BVG	Diesel	1968	4	25
07/04→03/11	A6 2.0 TDI	CAGB	Diesel	1968	4	26
11/08→03/11	A6 2.0 TDI	CAHA	Diesel	1968	4	26
04/09→03/11	A6 2.0 TDI	CAHB	Diesel	1968	4	26
03/11→	A6 2.0 TDI	CGLC	Diesel	1968	4	26
03/11→	A6 2.0 TDI	CGLD	Diesel	1968	4	26
01/12→	A6 2.0 TDI	CGLE	Diesel	1968	4	26
03/11→	A6 2.0 TDI	CMGB	Diesel	1968	4	26
06/05→03/11	A6 2.0 TFSI	BPJ	Petrol	1984	4	31
06/05→03/11	A6 2.0 TFSI	BYK	Petrol	1984	4	31
06/94→12/95	A6 2.3	AAR	Petrol	2309	5	30
06/94→12/95	A6 2.3 quattro	AAR	Petrol	2309	5	30
01/95→10/97	A6 2.5 TDI	AAT	Diesel	2461	5	19
06/94→10/97	A6 2.5 TDI	AAT	Diesel	2461	5	19
08/94→10/97	A6 2.5 TDI	AEL	Diesel	2461	5	19
07/97→01/05	A6 2.5 TDI	AFB	Diesel	2496	V6	11
02/00→01/05	A6 2.5 TDI	AKE	Diesel	2496	V6	11
07/97→01/05	A6 2.5 TDI	AKN	Diesel	2496	V6	11
08/01→01/05	A6 2.5 TDI	AYM	Diesel	2496	V6	11
02/00→01/05	A6 2.5 TDI	BAU	Diesel	2496	V6	11
07/02→01/05	A6 2.5 TDI	BCZ	Diesel	2496	V6	11
07/02→01/05	A6 2.5 TDI	BDG	Diesel	2496	V6	11
02/00→01/05	A6 2.5 TDI	BDH	Diesel	2496	V6	11
07/02→01/05	A6 2.5 TDI	BFC	Diesel	2496	V6	11
10/95→10/97	A6 2.5 TDI quattro	AEL	Diesel	2461	5	19
07/97→01/05	A6 2.5 TDI quattro	AFB	Diesel	2496	V6	11
02/00→01/05	A6 2.5 TDI quattro	AKE	Diesel	2496	V6	11
07/97→01/05	A6 2.5 TDI quattro	AKN	Diesel	2496	V6	11
02/00→01/05	A6 2.5 TDI quattro	BAU	Diesel	2496	V6	11
02/00→01/05	A6 2.5 TDI quattro	BDH	Diesel	2496	V6	11
06/94→10/97	A6 2.6	ABC	Petrol	2598	V6	30
06/94→10/97	A6 2.6	ACZ	Petrol	2598	V6	30
06/94→10/97	A6 2.6 quattro	ABC	Petrol	2598	V6	30
11/04→10/08	A6 2.7 TDI	BPP	Diesel	2698	V6	33
11/04→03/11	A6 2.7 TDI	BSG	Diesel	2698	V6	33
10/08→03/11	A6 2.7 TDI	CANA	Diesel	2698	V6	34



CCM

x



9

11/04→03/11	A6 2.7 TDI	CANB	Diesel	2698	V6	34
11/04→10/08	A6 2.7 TDI quattro	BPP	Diesel	2698	V6	33
06/05→03/11	A6 2.7 TDI quattro	BSG	Diesel	2698	V6	33
10/08→03/11	A6 2.7 TDI quattro	CANC	Diesel	2698	V6	34
06/05→03/11	A6 2.7 TDI quattro	CAND	Diesel	2698	V6	35
06/94→10/97	A6 2.8	AAH	Petrol	2771	V6	27
02/97→01/05	A6 2.8	ACK	Petrol	2771	V6	27
12/95→10/97	A6 2.8	ACK	Petrol	2771	V6	27
06/94→10/97	A6 2.8	AEJ	Petrol	2771	V6	27
08/95→07/96	A6 2.8	AEJ	Petrol	2771	V6	27
06/94→10/97	A6 2.8	AFC	Petrol	2771	V6	27
10/97→05/00	A6 2.8	AGE	Petrol	2771	V6	27
02/97→01/05	A6 2.8	ALG	Petrol	2771	V6	27
02/97→01/05	A6 2.8	AMX	Petrol	2771	V6	27
02/97→01/05	A6 2.8	APR	Petrol	2771	V6	27
02/97→01/05	A6 2.8	AQD	Petrol	2771	V6	27
07/99→01/05	A6 2.8	ATX	Petrol	2771	V6	27
07/99→01/05	A6 2.8	BBG	Petrol	2771	V6	27
06/94→10/97	A6 2.8 quattro	AAH	Petrol	2771	V6	27
02/97→01/05	A6 2.8 quattro	ACK	Petrol	2771	V6	27
12/95→10/97	A6 2.8 quattro	ACK	Petrol	2771	V6	27
06/94→10/97	A6 2.8 quattro	AEJ	Petrol	2771	V6	27
01/98→04/00	A6 2.8 quattro	AGE	Petrol	2771	V6	27
02/97→01/05	A6 2.8 quattro	ALG	Petrol	2771	V6	27
02/97→01/05	A6 2.8 quattro	AMX	Petrol	2771	V6	27
02/97→01/05	A6 2.8 quattro	APR	Petrol	2771	V6	27
02/97→01/05	A6 2.8 quattro	AQD	Petrol	2771	V6	27
07/99→05/01	A6 2.8 quattro	ATX	Petrol	2771	V6	27
08/01→01/05	A6 3.0	ASN	Petrol	2976	V6	31
08/04→05/06	A6 3.0	BBJ	Petrol	2976	V6	31
08/01→01/05	A6 3.0 quattro	ASN	Petrol	2976	V6	31
05/04→05/06	A6 3.0 quattro	BBJ	Petrol	2976	V6	31
06/01→07/04	A6 3.0 quattro	BBJ	Petrol	2976	V6	31
06/06→03/11	A6 3.0 TDI	ASB	Diesel	2967	V6	33
06/06→10/08	A6 3.0 TDI quattro	ASB	Diesel	2967	V6	33
05/04→05/06	A6 3.0 TDI quattro	BMK	Diesel	2967	V6	33
05/04→03/11	A6 3.0 TDI quattro	BNG	Diesel	2967	V6	33
10/08→03/11	A6 3.0 TDI quattro	CDYA	Diesel	2967	V6	34
05/04→03/11	A6 3.0 TDI quattro	CDYB	Diesel	2967	V6	35
10/08→03/11	A6 3.0 TDI quattro	CDYC	Diesel	2967	V6	34
03/99→01/05	A6 3.7	AQG	Petrol	3697	V8	37
03/99→01/05	A6 3.7 quattro	AQG	Petrol	3697	V8	37
11/98→01/05	A6 4.2 quattro	ARS	Petrol	4172	V8	37
11/98→01/05	A6 4.2 quattro	ASG	Petrol	4172	V8	37
11/98→01/05	A6 4.2 quattro	AWN	Petrol	4172	V8	37
05/06→10/08	A6 Allroad 2.7 TDI quattro	BPP	Diesel	2698	V6	33
05/06→08/11	A6 Allroad 2.7 TDI quattro	BSG	Diesel	2698	V6	33
10/08→08/11	A6 Allroad 2.7 TDI quattro	CANC	Diesel	2698	V6	34
05/06→08/11	A6 Allroad 2.7 TDI quattro	CAND	Diesel	2698	V6	35
05/06→10/08	A6 Allroad 3.0 TDI quattro	ASB	Diesel	2967	V6	33
05/06→08/11	A6 Allroad 3.0 TDI quattro	BNG	Diesel	2967	V6	33
10/08→08/11	A6 Allroad 3.0 TDI quattro	CDYA	Diesel	2967	V6	34
05/06→08/11	A6 Allroad 3.0 TDI quattro	CDYB	Diesel	2967	V6	35
10/08→08/11	A6 Allroad 3.0 TDI quattro	CDYC	Diesel	2967	V6	34
12/95→12/97	A6 Avant 1.8	ADR	Petrol	1781	4	22
02/98→01/05	A6 Avant 1.8	AFY	Petrol	1781	4	22
12/97→01/05	A6 Avant 1.8	AJP	Petrol	1781	4	22
12/97→01/05	A6 Avant 1.8	AQE	Petrol	1781	4	22
12/97→01/05	A6 Avant 1.8	ARH	Petrol	1781	4	22
12/95→12/97	A6 Avant 1.8 quattro	ADR	Petrol	1781	4	22

MODEL INDEX

 Modelverzeichnis • Index de modele • Índice de Modelo
 Indeks modelu • Модель автомобиля • دليل الموديل

CCM
x

9

12/97→01/05	A6 Avant 1.8 T	AEB	Petrol	1781	4	22
04/99→01/05	A6 Avant 1.8 T	AJL	Petrol	1781	4	22
12/97→01/05	A6 Avant 1.8 T	ANB	Petrol	1781	4	22
12/97→01/05	A6 Avant 1.8 T	APU	Petrol	1781	4	22
12/97→01/05	A6 Avant 1.8 T	ARK	Petrol	1781	4	22
12/97→01/05	A6 Avant 1.8 T	AWT	Petrol	1781	4	22
12/97→01/05	A6 Avant 1.8 T quattro	AEB	Petrol	1781	4	22
12/97→01/05	A6 Avant 1.8 T quattro	AJL	Petrol	1781	4	22
12/97→01/05	A6 Avant 1.8 T quattro	ANB	Petrol	1781	4	22
12/97→01/05	A6 Avant 1.8 T quattro	APU	Petrol	1781	4	22
12/97→01/05	A6 Avant 1.8 T quattro	ARK	Petrol	1781	4	22
12/97→01/05	A6 Avant 1.8 T quattro	AWT	Petrol	1781	4	22
06/94→12/97	A6 Avant 1.9 TDI	1Z	Diesel	1896	4	13
02/98→04/01	A6 Avant 1.9 TDI	AFN	Diesel	1896	4	13
06/94→12/97	A6 Avant 1.9 TDI	AHU	Diesel	1896	4	13
07/00→01/05	A6 Avant 1.9 TDI	AJM	Diesel	1896	4	13
08/01→01/05	A6 Avant 1.9 TDI	AVF	Diesel	1896	4	13
08/01→01/05	A6 Avant 1.9 TDI	AWX	Diesel	1896	4	13
06/94→12/97	A6 Avant 2.0	AAE	Petrol	1984	4	27
06/94→12/97	A6 Avant 2.0	ABK	Petrol	1984	4	27
08/01→01/05	A6 Avant 2.0	ALT	Petrol	1984	4	31
06/94→12/97	A6 Avant 2.0	AXA	Petrol	1984	4	27
06/94→12/97	A6 Avant 2.0 16V	ACE	Petrol	1984	4	27
06/94→12/97	A6 Avant 2.0 16V quattro	ACE	Petrol	1984	4	27
06/05→10/08	A6 Avant 2.0 TDI	BLB	Diesel	1968	4	25
06/05→08/11	A6 Avant 2.0 TDI	BNA	Diesel	1968	4	25
06/05→10/08	A6 Avant 2.0 TDI	BRE	Diesel	1968	4	25
06/05→08/11	A6 Avant 2.0 TDI	BRF	Diesel	1968	4	25
09/05→06/06	A6 Avant 2.0 TDI	BVG	Diesel	1968	4	25
06/05→08/11	A6 Avant 2.0 TDI	CAGB	Diesel	1968	4	26
10/08→08/11	A6 Avant 2.0 TDI	CAHA	Diesel	1968	4	26
04/09→08/11	A6 Avant 2.0 TDI	CAHB	Diesel	1968	4	26
05/11→	A6 Avant 2.0 TDI	CGLC	Diesel	1968	4	26
05/11→	A6 Avant 2.0 TDI	CGLD	Diesel	1968	4	26
01/12→	A6 Avant 2.0 TDI	CGLE	Diesel	1968	4	26
05/11→	A6 Avant 2.0 TDI	CMGB	Diesel	1968	4	26
06/05→08/11	A6 Avant 2.0 TFSI	BPJ	Petrol	1984	4	31
06/94→12/95	A6 Avant 2.3	AAR	Petrol	2309	5	30
06/94→12/95	A6 Avant 2.3 quattro	AAR	Petrol	2309	5	30
01/95→12/97	A6 Avant 2.5 TDI	AAT	Diesel	2461	5	19
06/94→12/97	A6 Avant 2.5 TDI	AAT	Diesel	2461	5	19
08/94→12/97	A6 Avant 2.5 TDI	AEL	Diesel	2461	5	19
12/97→01/05	A6 Avant 2.5 TDI	AFB	Diesel	2496	V6	11
02/00→01/05	A6 Avant 2.5 TDI	AKE	Diesel	2496	V6	11
12/97→01/05	A6 Avant 2.5 TDI	AKN	Diesel	2496	V6	11
08/01→01/05	A6 Avant 2.5 TDI	AYM	Diesel	2496	V6	11
02/00→01/05	A6 Avant 2.5 TDI	BAU	Diesel	2496	V6	11
07/02→01/05	A6 Avant 2.5 TDI	BCZ	Diesel	2496	V6	11
07/02→01/05	A6 Avant 2.5 TDI	BDG	Diesel	2496	V6	11
02/00→01/05	A6 Avant 2.5 TDI	BDH	Diesel	2496	V6	11
07/02→01/05	A6 Avant 2.5 TDI	BFC	Diesel	2496	V6	11
07/95→12/97	A6 Avant 2.5 TDI quattro	AEL	Diesel	2461	5	19
12/97→01/05	A6 Avant 2.5 TDI quattro	AFB	Diesel	2496	V6	11
02/00→01/05	A6 Avant 2.5 TDI quattro	AKE	Diesel	2496	V6	11
12/97→01/05	A6 Avant 2.5 TDI quattro	AKN	Diesel	2496	V6	11
02/00→01/05	A6 Avant 2.5 TDI quattro	BAU	Diesel	2496	V6	11
02/00→01/05	A6 Avant 2.5 TDI quattro	BDH	Diesel	2496	V6	11
06/94→12/97	A6 Avant 2.6	ABC	Petrol	2598	V6	30
06/94→02/97	A6 Avant 2.6	ACZ	Petrol	2598	V6	30
06/94→12/97	A6 Avant 2.6 quattro	ABC	Petrol	2598	V6	30



CCM

x



9

03/05→10/08	A6 Avant 2.7 TDI	BPP	Diesel	2698	V6	33
03/05→08/11	A6 Avant 2.7 TDI	BSG	Diesel	2698	V6	33
10/08→08/11	A6 Avant 2.7 TDI	CANA	Diesel	2698	V6	34
03/05→08/11	A6 Avant 2.7 TDI	CANB	Diesel	2698	V6	34
03/05→10/08	A6 Avant 2.7 TDI quattro	BPP	Diesel	2698	V6	33
06/05→08/11	A6 Avant 2.7 TDI quattro	BSG	Diesel	2698	V6	33
10/08→08/11	A6 Avant 2.7 TDI quattro	CANC	Diesel	2698	V6	34
06/05→08/11	A6 Avant 2.7 TDI quattro	CAND	Diesel	2698	V6	35
06/94→12/97	A6 Avant 2.8	AAH	Petrol	2771	V6	27
12/95→12/97	A6 Avant 2.8	ACK	Petrol	2771	V6	27
12/97→01/05	A6 Avant 2.8	ACK	Petrol	2771	V6	27
06/94→12/97	A6 Avant 2.8	AEJ	Petrol	2771	V6	27
12/97→05/00	A6 Avant 2.8	AGE	Petrol	2771	V6	27
12/97→01/05	A6 Avant 2.8	ALG	Petrol	2771	V6	27
12/97→01/05	A6 Avant 2.8	AMX	Petrol	2771	V6	27
12/97→01/05	A6 Avant 2.8	APR	Petrol	2771	V6	27
12/97→01/05	A6 Avant 2.8	AQD	Petrol	2771	V6	27
07/99→01/05	A6 Avant 2.8	ATX	Petrol	2771	V6	27
06/94→12/97	A6 Avant 2.8 quattro	AAH	Petrol	2771	V6	27
12/95→12/97	A6 Avant 2.8 quattro	ACK	Petrol	2771	V6	27
12/97→01/05	A6 Avant 2.8 quattro	ACK	Petrol	2771	V6	27
06/94→12/97	A6 Avant 2.8 quattro	AEJ	Petrol	2771	V6	27
12/97→01/05	A6 Avant 2.8 quattro	ALG	Petrol	2771	V6	27
12/97→01/05	A6 Avant 2.8 quattro	AMX	Petrol	2771	V6	27
12/97→01/05	A6 Avant 2.8 quattro	APR	Petrol	2771	V6	27
12/97→01/05	A6 Avant 2.8 quattro	AQD	Petrol	2771	V6	27
08/01→01/05	A6 Avant 3.0	ASN	Petrol	2976	V6	31
03/05→05/06	A6 Avant 3.0	BBJ	Petrol	2976	V6	31
08/01→01/05	A6 Avant 3.0 quattro	ASN	Petrol	2976	V6	31
03/05→05/06	A6 Avant 3.0 quattro	BBJ	Petrol	2976	V6	31
06/06→08/11	A6 Avant 3.0 TDi	ASB	Diesel	2967	V6	33
06/06→10/08	A6 Avant 3.0 TDi quattro	ASB	Diesel	2967	V6	33
03/05→05/06	A6 Avant 3.0 TDi quattro	BMK	Diesel	2967	V6	33
03/05→08/11	A6 Avant 3.0 TDi quattro	BNG	Diesel	2967	V6	33
10/08→08/11	A6 Avant 3.0 TDi quattro	CDYA	Diesel	2967	V6	34
03/05→08/11	A6 Avant 3.0 TDi quattro	CDYB	Diesel	2967	V6	35
10/08→08/11	A6 Avant 3.0 TDi quattro	CDYC	Diesel	2967	V6	34
03/99→01/05	A6 Avant 3.7	AQG	Petrol	3697	V8	37
03/99→01/05	A6 Avant 3.7 quattro	AQG	Petrol	3697	V8	37
11/98→01/05	A6 Avant 4.2 quattro	ARS	Petrol	4172	V8	37
11/98→01/05	A6 Avant 4.2 quattro	ASG	Petrol	4172	V8	37
11/98→01/05	A6 Avant 4.2 quattro	AWN	Petrol	4172	V8	37
01/13→	A6 Avant RS6 quattro	CRDB	Petrol	3993	V8	38
09/99→01/05	A6 Avant S6 quattro	ANK	Petrol	4172	V8	37
09/99→01/05	A6 Avant S6 quattro	AQJ	Petrol	4172	V8	37
06/94→12/97	A6 Avant S6 Turbo quattro	AAN	Petrol	2226	5	20
09/99→01/05	A6 S6 quattro	ANK	Petrol	4172	V8	37
09/99→01/05	A6 S6 quattro	AQJ	Petrol	4172	V8	37
06/94→10/97	A6 S6 Turbo quattro	AAN	Petrol	2226	5	20
01/97→04/00	A8 2.5 TDI	AFB	Diesel	2496	V6	11
09/00→09/02	A8 2.5 TDI	AKE	Diesel	2496	V6	11
01/97→04/00	A8 2.5 TDI	AKN	Diesel	2496	V6	11
07/97→04/00	A8 2.5 TDI quattro	AFB	Diesel	2496	V6	11
09/00→09/02	A8 2.5 TDI quattro	AKE	Diesel	2496	V6	11
07/97→04/00	A8 2.5 TDI quattro	AKN	Diesel	2496	V6	11
03/94→03/96	A8 2.8	AAH	Petrol	2771	V6	27
04/96→09/02	A8 2.8	ACK	Petrol	2771	V6	27
07/95→03/96	A8 2.8	AEJ	Petrol	2771	V6	27
04/96→09/02	A8 2.8	ALG	Petrol	2771	V6	27
04/96→09/02	A8 2.8	AMX	Petrol	2771	V6	27

MODEL INDEX

Modelverzeichnis • Index de modele • Índice de Modelo
Indeks modelu • Модель автомобиля • دليل الموديل



CCM

x



9

04/96→09/02	A8 2.8	APR	Petrol	2771	V6	27
04/96→09/02	A8 2.8	AQD	Petrol	2771	V6	27
03/94→03/96	A8 2.8 quattro	AAH	Petrol	2771	V6	27
04/96→09/02	A8 2.8 quattro	ACK	Petrol	2771	V6	27
07/95→03/96	A8 2.8 quattro	AEJ	Petrol	2771	V6	27
04/96→09/02	A8 2.8 quattro	AMX	Petrol	2771	V6	27
04/96→09/02	A8 2.8 quattro	APR	Petrol	2771	V6	27
04/96→09/02	A8 2.8 quattro	AQD	Petrol	2771	V6	27
07/03→05/05	A8 3.0	ASN	Petrol	2976	V6	31
07/03→05/06	A8 3.0	BBJ	Petrol	2976	V6	31
08/03→07/10	A8 3.0 TDI quattro	ASB	Diesel	2967	V6	33
11/03→07/10	A8 3.0 TDI quattro	BNG	Diesel	2967	V6	33
11/98→09/02	A8 3.7	AKC	Petrol	3697	V8	37
11/98→09/02	A8 3.7	AQG	Petrol	3697	V8	37
11/98→09/02	A8 3.7 quattro	AKC	Petrol	3697	V8	37
11/98→09/02	A8 3.7 quattro	AQG	Petrol	3697	V8	37
10/02→05/06	A8 3.7 quattro	BFL	Petrol	3697	V8	37
11/98→09/02	A8 4.2 quattro	AQF	Petrol	4172	V8	37
11/98→09/02	A8 4.2 quattro	AUW	Petrol	4172	V8	37
11/98→09/02	A8 4.2 quattro	AUX	Petrol	4172	V8	37
10/02→07/10	A8 4.2 quattro	BFM	Petrol	4172	V8	37
01/05→06/05	A8 4.2 TDI quattro	BMC	Diesel	4134	V8	34
07/05→07/10	A8 4.2 TDI quattro	BVN	Diesel	4134	V8	34
06/99→09/02	A8 S 8 quattro	AVP	Petrol	4172	V8	37
04/12→	A8 S8 quattro	CGTA	Petrol	3993	V8	38
05/00→08/05	Allroad 2.5 TDI quattro	AKE	Diesel	2496	V6	11
05/00→08/05	Allroad 2.5 TDI quattro	BAU	Diesel	2496	V6	11
05/03→08/05	Allroad 2.5 TDI quattro	BCZ	Diesel	2496	V6	11
07/02→08/05	Allroad 4.2 V8 quattro	BAS	Petrol	4172	V8	37
01/97→08/00	Cabriolet 1.8	ADR	Petrol	1781	4	22
06/95→08/00	Cabriolet 1.9 TDI	1Z	Diesel	1896	4	13
06/95→08/00	Cabriolet 1.9 TDI	AHU	Diesel	1896	4	13
06/95→07/96	Cabriolet 2.0 16V	ACE	Petrol	1984	4	27
01/93→07/98	Cabriolet 2.0 E	ABK	Petrol	1984	4	27
01/93→07/98	Cabriolet 2.0 E	AXA	Petrol	1984	4	27
05/91→07/94	Cabriolet 2.3 E	NG	Petrol	2309	5	30
06/93→08/00	Cabriolet 2.6	ABC	Petrol	2598	V6	30
05/95→08/00	Cabriolet 2.6	ACZ	Petrol	2598	V6	30
11/92→08/00	Cabriolet 2.8	AAH	Petrol	2771	V6	27
07/80→08/81	Coupe 1.6	YN	Petrol	1588	4	16
08/89→07/91	Coupe 1.8	DZ	Petrol	1781	4	20
09/82→10/88	Coupe 1.8 GT	DS	Petrol	1781	4	20
08/86→10/88	Coupe 1.8 GT	DZ	Petrol	1781	4	20
01/85→07/88	Coupe 1.8 GT	JN	Petrol	1781	4	18
09/82→10/88	Coupe 1.8 GT	JV	Petrol	1781	4	20
08/86→10/87	Coupe 1.8 GT	PV	Petrol	1781	4	20
04/86→10/88	Coupe 1.8 GT	SF	Petrol	1781	4	18
09/85→10/88	Coupe 1.8 GT quattro	DS	Petrol	1781	4	20
12/84→10/88	Coupe 1.8 GT quattro	DZ	Petrol	1781	4	20
09/85→10/88	Coupe 1.8 GT quattro	JN	Petrol	1781	4	18
09/85→10/88	Coupe 1.8 GT quattro	NE	Petrol	1781	4	20
08/80→07/83	Coupe 1.9	WN	Petrol	1921	5	16
05/89→12/96	Coupe 2.0	AAD	Petrol	1984	4	29
05/89→12/96	Coupe 2.0	ABK	Petrol	1984	4	27
05/89→12/96	Coupe 2.0	AXA	Petrol	1984	4	27
09/83→07/86	Coupe 2.0	HP	Petrol	1994	5	18
09/83→07/86	Coupe 2.0	JS	Petrol	1994	5	18
03/86→04/88	Coupe 2.0	SK	Petrol	1994	5	18
01/92→07/92	Coupe 2.0 16 V	6A	Petrol	1984	4	27
08/92→12/96	Coupe 2.0 16 V	ACE	Petrol	1984	4	27



CCM

x



9

08/89→07/91	Coupe 2.0 20 V	NM	Petrol	1994	5	20
08/89→07/91	Coupe 2.0 20 V quattro	NM	Petrol	1994	5	20
09/82→08/84	Coupe 2.1 GT	KE	Petrol	2144	5	16
09/82→08/84	Coupe 2.1 GT	KL	Petrol	2144	5	16
01/81→07/83	Coupe 2.1 GT	WE	Petrol	2144	5	16
09/84→10/88	Coupe 2.2 GT	HY	Petrol	2144	5	18
09/84→10/88	Coupe 2.2 GT	KV	Petrol	2226	5	18
07/81→10/87	Coupe 2.2 GT	KX	Petrol	2226	5	18
08/85→10/88	Coupe 2.2 quattro	JT	Petrol	2226	5	18
10/84→10/88	Coupe 2.2 quattro	KV	Petrol	2226	5	18
11/88→07/91	Coupe 2.2 quattro	KV	Petrol	2226	5	18
09/82→07/83	Coupe 2.2i	KM	Petrol	2226	5	18
01/87→10/88	Coupe 2.3	NG	Petrol	2309	5	30
03/90→12/96	Coupe 2.3	NG	Petrol	2309	5	30
10/88→07/94	Coupe 2.3	NG	Petrol	2309	5	30
08/89→07/91	Coupe 2.3 20V	7A	Petrol	2309	5	28
08/90→07/91	Coupe 2.3 20V	7A	Petrol	2309	5	28
05/90→12/96	Coupe 2.3 20V quattro	7A	Petrol	2309	5	28
11/88→07/91	Coupe 2.3 20V quattro	7A	Petrol	2309	5	28
01/87→10/88	Coupe 2.3 quattro	NG	Petrol	2309	5	30
05/90→12/96	Coupe 2.3 quattro	NG	Petrol	2309	5	30
11/88→12/92	Coupe 2.3 quattro	NG	Petrol	2309	5	30
08/92→12/96	Coupe 2.6	ABC	Petrol	2598	V6	30
08/92→12/96	Coupe 2.6 quattro	ABC	Petrol	2598	V6	30
09/91→12/96	Coupe 2.8	AAH	Petrol	2771	V6	27
08/91→12/96	Coupe 2.8 quattro	AAH	Petrol	2771	V6	27
09/90→09/92	Coupe S2 quattro	3B	Petrol	2226	5	20
10/92→12/96	Coupe S2 quattro	ABY	Petrol	2226	5	20
09/11→	Q3 2.0 TDI	CFFA	Diesel	1968	4	26
09/11→	Q3 2.0 TDI	CFFB	Diesel	1968	4	26
05/13→	Q3 2.0 TDI	CFGC	Diesel	1968	4	26
01/12→	Q3 2.0 TDI quattro	CFFB	Diesel	1968	4	26
06/11→	Q3 2.0 TDI quattro	CFGC	Diesel	1968	4	26
06/11→	Q3 2.0 TDI quattro	CFGD	Diesel	1968	4	26
06/11→	Q3 2.0 TDI quattro	CLLB	Diesel	1968	4	26
11/10→	Q5 2.0 TDI	CJCA	Diesel	1968	4	26
11/10→	Q5 2.0 TDI	CJCB	Diesel	1968	4	26
08/09→	Q5 2.0 TDI quattro	CAGA	Diesel	1968	4	26
08/09→	Q5 2.0 TDI quattro	CAGB	Diesel	1968	4	26
11/08→	Q5 2.0 TDI quattro	CAHA	Diesel	1968	4	26
11/08→	Q5 2.0 TDI quattro	CAHB	Diesel	1968	4	26
11/08→	Q5 2.0 TDI quattro	CGLA	Diesel	1968	4	26
11/08→	Q5 2.0 TDI quattro	CGLB	Diesel	1968	4	26
06/12→	Q5 2.0 TDI quattro	CGLC	Diesel	1968	4	26
11/08→	Q5 2.0 TDI quattro	CGLD	Diesel	1968	4	26
08/09→	Q5 2.0 TDI quattro	CJCA	Diesel	1968	4	26
08/09→	Q5 2.0 TDI quattro	CJCB	Diesel	1968	4	26
11/08→	Q5 2.0 TDI quattro	CMGA	Diesel	1968	4	26
06/12→	Q5 2.0 TDI quattro	CMGB	Diesel	1968	4	26
11/08→	Q5 3.0 TDI quattro	CCWA	Diesel	2967	V6	34
11/08→	Q5 3.0 TDI quattro	CCWB	Diesel	2967	V6	34
03/06→05/08	Q7 3.0 TDI	BUG	Diesel	2967	V6	33
03/06→05/10	Q7 3.0 TDI	BUN	Diesel	2967	V6	33
11/07→	Q7 3.0 TDI	CASA	Diesel	2967	V6	34
03/06→05/10	Q7 3.0 TDI	CASB	Diesel	2967	V6	35
06/09→05/12	Q7 3.0 TDI	CATA	Diesel	2967	V6	35
11/07→	Q7 3.0 TDI	CCMA	Diesel	2967	V6	34
03/07→06/09	Q7 4.2 TDI	BTR	Diesel	4134	V8	34
02/82→07/89	Quattro 2.1 quattro	WX	Petrol	2144	5	17
07/80→07/87	Quattro 2.1 Turbo	WR	Petrol	2144	5	17

MODEL INDEX

Modelverzeichnis • Index de modele • Índice de Modelo
Indeks modelu • Модель автомобиля • دليل الموديل



CCM

x



9

08/89→07/91	Quattro 2.2 20V	RR	Petrol	2226	5	18
12/84→07/87	Quattro 2.2 quattro	HY	Petrol	2144	5	18
12/84→07/87	Quattro 2.2 quattro	JT	Petrol	2226	5	18
12/84→07/87	Quattro 2.2 quattro	KV	Petrol	2226	5	18
08/87→07/89	Quattro 2.2 Turbo	1B	Petrol	2226	5	18
08/87→07/89	Quattro 2.2 Turbo	MB	Petrol	2226	5	20
10/98→06/06	TT 1.8 T	AJQ	Petrol	1781	4	22
10/98→06/06	TT 1.8 T	APP	Petrol	1781	4	22
10/98→06/06	TT 1.8 T	ARY	Petrol	1781	4	22
09/02→06/06	TT 1.8 T	AUM	Petrol	1781	4	22
10/98→06/06	TT 1.8 T	AUQ	Petrol	1781	4	22
10/98→06/06	TT 1.8 T quattro	AJQ	Petrol	1781	4	22
10/98→06/06	TT 1.8 T quattro	AMU	Petrol	1781	4	24
10/98→06/06	TT 1.8 T quattro	APX	Petrol	1781	4	24
10/98→06/06	TT 1.8 T quattro	ARY	Petrol	1781	4	22
10/98→06/06	TT 1.8 T quattro	BAM	Petrol	1781	4	24
06/08→	TT 2.0 TDI quattro	CBBB	Diesel	1968	4	26
06/08→	TT 2.0 TDI quattro	CFGB	Diesel	1968	4	26
08/06→06/10	TT 2.0 TFSI	BPY	Petrol	1984	4	31
08/06→06/10	TT 2.0 TFSI	BWA	Petrol	1984	4	31
08/06→06/10	TT 3.2 V6 quattro	BUB	Petrol	3189	V6	36
07/03→06/06	TT 3.2 VR6 quattro	BHE	Petrol	3189	V6	36
07/03→06/06	TT 3.2 VR6 quattro	BPF	Petrol	3189	V6	36
10/99→06/06	TT Roadster 1.8 T	AJQ	Petrol	1781	4	22
10/99→06/06	TT Roadster 1.8 T	APP	Petrol	1781	4	22
01/01→06/06	TT Roadster 1.8 T	AUM	Petrol	1781	4	22
10/99→06/06	TT Roadster 1.8 T	AUQ	Petrol	1781	4	22
02/00→06/06	TT Roadster 1.8 T quattro	AJQ	Petrol	1781	4	22
10/99→06/06	TT Roadster 1.8 T quattro	AMU	Petrol	1781	4	24
10/99→06/06	TT Roadster 1.8 T quattro	APX	Petrol	1781	4	24
02/00→06/06	TT Roadster 1.8 T quattro	ARY	Petrol	1781	4	22
10/99→06/06	TT Roadster 1.8 T quattro	BAM	Petrol	1781	4	24
06/08→	TT Roadster 2.0 TDI quattro	CBBB	Diesel	1968	4	26
06/08→	TT Roadster 2.0 TDI quattro	CFGB	Diesel	1968	4	26
03/07→06/10	TT Roadster 2.0 TFSI	BPY	Petrol	1984	4	31
03/07→06/10	TT Roadster 2.0 TFSI	BWA	Petrol	1984	4	31
03/07→06/10	TT Roadster 3.2 V6 quattro	BUB	Petrol	3189	V6	36
07/03→06/06	TT Roadster 3.2 VR6 quattro	BHE	Petrol	3189	V6	36
07/03→06/06	TT Roadster 3.2 VR6 quattro	BPF	Petrol	3189	V6	36



CCM

x



9

1B	Petrol	2226	5	81.00	18
1T	Diesel	2461	5	81.00	19
1Y	Diesel	1896	4	79.50	12
1Z	Diesel	1896	4	79.50	13
2B	Petrol	2226	5	81.00	18
3B	Petrol	2226	5	81.00	20
3D	Diesel	2370	5	79.50	12
4B	Petrol	1781	4	81.00	20
6A	Petrol	1984	4	82.50	27
7A	Petrol	2309	5	82.50	28
AAD	Petrol	1984	4	82.50	29
AAE	Petrol	1984	4	82.50	27
AAH	Petrol	2771	V6	82.50	27
AAN	Petrol	2226	5	81.00	20
AAR	Petrol	2309	5	82.50	30
AAS	Diesel	2370	5	79.50	12
AAT	Diesel	2461	5	81.00	19
AAZ	Diesel	1896	4	79.50	12
ABB	Petrol	1595	4	81.00	20
ABC	Petrol	2598	V6	82.50	30
ABK	Petrol	1984	4	82.50	27
ABM	Petrol	1595	4	81.00	18
ABP	Diesel	2461	5	81.00	19
ABT	Petrol	1984	4	82.50	27
ABY	Petrol	2226	5	81.00	20
ACE	Petrol	1984	4	82.50	27
ACK	Petrol	2771	V6	82.50	27
ACZ	Petrol	2598	V6	82.50	30
ADA	Petrol	1595	4	81.00	18
ADE	Diesel	1896	4	79.50	12
ADP	Petrol	1595	4	81.00	21
ADR	Petrol	1781	4	81.00	22
ADU	Petrol	2226	5	81.00	20
ADW	Petrol	1985	4	82.50	27
AEB	Petrol	1781	4	81.00	22
AEH	Petrol	1595	4	81.00	21
AEJ	Petrol	2771	V6	82.50	27
AEL	Diesel	2461	5	81.00	19
AFB	Diesel	2496	V6	78.30	11
AFC	Petrol	2771	V6	82.50	27
AFF	Diesel	1896	4	79.50	13
AFN	Diesel	1896	4	79.50	13
AFY	Petrol	1781	4	81.00	22
AGE	Petrol	2771	V6	82.50	27
AGN	Petrol	1781	4	81.00	22
AGR	Diesel	1896	4	79.50	13
AGU	Petrol	1781	4	81.00	22
AHF	Diesel	1896	4	79.50	13
AHH	Diesel	1896	4	79.50	13
AHL	Petrol	1595	4	81.00	21
AHU	Diesel	1896	4	79.50	13
AJL	Petrol	1781	4	81.00	22
AJM	Diesel	1896	4	79.50	13
AJP	Petrol	1781	4	81.00	22
AJQ	Petrol	1781	4	81.00	22
AKC	Petrol	3697	V8	84.50	37
AKE	Diesel	2496	V6	78.30	11
AKL	Petrol	1595	4	81.00	21
AKN	Diesel	2496	V6	78.30	11
ALG	Petrol	2771	V6	82.50	27

ENGINE INDEX

Motorverzeichnis • Index de moteur • Índice de Motor
Indeks silnika • Модель двигателя • دليل المحرك



CCM



9

ALH	Diesel	1896	4	79.50	13
ALT	Petrol	1984	4	82.50	31
ALZ	Petrol	1595	4	81.00	23
AMB	Petrol	1781	4	81.00	22
AMF	Diesel	1422	3	79.50	13
AMK	Petrol	1781	4	81.00	24
AMU	Petrol	1781	4	81.00	24
AMX	Petrol	2771	V6	82.50	27
ANA	Petrol	1595	4	81.00	23
ANB	Petrol	1781	4	81.00	22
ANK	Petrol	4172	V8	84.50	37
ANU	Diesel	1896	4	79.50	13
ANY	Diesel	1191	3	76.50	5
APF	Petrol	1595	4	81.00	21
APG	Petrol	1781	4	81.00	22
APP	Petrol	1781	4	81.00	22
APR	Petrol	2771	V6	82.50	27
APT	Petrol	1781	4	81.00	22
APU	Petrol	1781	4	81.00	22
APX	Petrol	1781	4	81.00	24
APY	Petrol	1781	4	81.00	24
AQA	Petrol	1781	4	81.00	22
AQD	Petrol	2771	V6	82.50	27
AQE	Petrol	1781	4	81.00	22
AQF	Petrol	4172	V8	84.50	37
AQG	Petrol	3697	V8	84.50	37
AQJ	Petrol	4172	V8	84.50	37
ARG	Petrol	1781	4	81.00	22
ARH	Petrol	1781	4	81.00	22
ARK	Petrol	1781	4	81.00	22
ARM	Petrol	1595	4	81.00	21
ARS	Petrol	4172	V8	84.50	37
ARX	Petrol	1781	4	81.00	22
ARY	Petrol	1781	4	81.00	22
ARZ	Petrol	1781	4	81.00	22
ASB	Diesel	2967	V6	83.00	33
ASG	Petrol	4172	V8	84.50	37
ASN	Petrol	2976	V6	82.50	31
ASV	Diesel	1896	4	79.50	13
ASZ	Diesel	1896	4	79.50	13
ATD	Diesel	1896	4	79.50	13
ATJ	Diesel	1896	4	79.50	13
ATL	Diesel	1422	3	79.50	13
ATX	Petrol	2771	V6	82.50	27
AUA	Petrol	1390	4	76.50	6
AUL	Petrol	1781	4	81.00	24
AUM	Petrol	1781	4	81.00	22
AUQ	Petrol	1781	4	81.00	22
AUW	Petrol	4172	V8	84.50	37
AUX	Petrol	4172	V8	84.50	37
AVB	Diesel	1896	4	79.50	13
AVF	Diesel	1896	4	79.50	13
AVG	Diesel	1896	4	79.50	13
AVJ	Petrol	1781	4	81.00	22
AVP	Petrol	4172	V8	84.50	37
AVU	Petrol	1595	4	81.00	23
AVV	Petrol	1781	4	81.00	22
AWA	Petrol	1984	4	82.50	31
AWN	Petrol	4172	V8	84.50	37
AWT	Petrol	1781	4	81.00	22

Motorverzeichnis • Index de moteur • Índice de Motor
Indeks silnika • Модель двигателя • دليل المحرك

ENGINE INDEX



CCM

x



9

AWX	Diesel	1896	4	79.50	13
AXA	Petrol	1984	4	82.50	27
AXR	Diesel	1896	4	79.50	13
AXW	Petrol	1984	4	82.50	31
AXX	Petrol	1984	4	82.50	31
AYM	Diesel	2496	V6	78.30	11
AZV	Diesel	1968	4	81.00	25
BAM	Petrol	1781	4	81.00	24
BAS	Petrol	4172	V8	84.50	37
BAU	Diesel	2496	V6	78.30	11
BBG	Petrol	2771	V6	82.50	27
BBJ	Petrol	2976	V6	82.50	31
BBY	Petrol	1390	4	76.50	6
BCZ	Diesel	2496	V6	78.30	11
BDB	Petrol	3189	V6	84.00	36
BDG	Diesel	2496	V6	78.30	11
BDH	Diesel	2496	V6	78.30	11
BEX	Petrol	1781	4	81.00	22
BFB	Petrol	1781	4	81.00	22
BFC	Diesel	2496	V6	78.30	11
BFL	Petrol	3697	V8	84.50	37
BFM	Petrol	4172	V8	84.50	37
BFQ	Petrol	1595	4	81.00	23
BGU	Petrol	1595	4	81.00	23
BHC	Diesel	1422	3	79.50	13
BHE	Petrol	3189	V6	84.00	36
BKC	Diesel	1896	4	79.50	14
BKD	Diesel	1968	4	81.00	25
BKE	Diesel	1896	4	79.50	14
BKN	Diesel	2967	V6	83.00	33
BLB	Diesel	1968	4	81.00	25
BLF	Petrol	1598	4	76.50	7
BLP	Petrol	1598	4	76.50	7
BLR	Petrol	1984	4	82.50	31
BLS	Diesel	1896	4	79.50	14
BLX	Petrol	1984	4	82.50	31
BLY	Petrol	1984	4	82.50	31
BMB	Petrol	1984	4	82.50	31
BMC	Diesel	4134	V8	83.00	34
BMJ	Petrol	3189	V6	84.00	36
BMK	Diesel	2967	V6	83.00	33
BMM	Diesel	1968	4	81.00	25
BMN	Diesel	1968	4	81.00	25
BNA	Diesel	1968	4	81.00	25
BNG	Diesel	2967	V6	83.00	33
BPF	Petrol	3189	V6	84.00	36
BPJ	Petrol	1984	4	82.50	31
BPP	Diesel	2698	V6	83.00	33
BPW	Diesel	1968	4	81.00	25
BPY	Petrol	1984	4	82.50	31
BRB	Diesel	1896	4	79.50	14
BRD	Diesel	1968	4	81.00	25
BRE	Diesel	1968	4	81.00	25
BRF	Diesel	1968	4	81.00	25
BSE	Petrol	1595	4	81.00	23
BSF	Petrol	1595	4	81.00	23
BSG	Diesel	2698	V6	83.00	33
BTR	Diesel	4134	V8	83.00	34
BUB	Petrol	3189	V6	84.00	36
BUG	Diesel	2967	V6	83.00	33

ENGINE INDEX

Motorverzeichnis • Index de moteur • Índice de Motor
Indeks silnika • Модель двигателя • دليل المحرك



CCM



9

BUN	Diesel	2967	V6	83.00	33
BUY	Diesel	1968	4	81.00	25
BVA	Diesel	1968	4	81.00	25
BVF	Diesel	1968	4	81.00	25
BVG	Diesel	1968	4	81.00	25
BVN	Diesel	4134	V8	83.00	34
BVY	Petrol	1984	4	82.50	31
BVZ	Petrol	1984	4	82.50	31
BWA	Petrol	1984	4	82.50	31
BXE	Diesel	1896	4	79.50	14
BYK	Petrol	1984	4	82.50	31
CAGA	Diesel	1968	4	81.00	26
CAGB	Diesel	1968	4	81.00	26
CAGC	Diesel	1968	4	81.00	26
CAHA	Diesel	1968	4	81.00	26
CAHB	Diesel	1968	4	81.00	26
CAMA	Diesel	2698	V6	83.00	34
CAMB	Diesel	2698	V6	83.00	34
CANA	Diesel	2698	V6	83.00	34
CANB	Diesel	2698	V6	83.00	34
CANC	Diesel	2698	V6	83.00	34
CAND	Diesel	2698	V6	83.00	35
CAPA	Diesel	2967	V6	83.00	34
CASA	Diesel	2967	V6	83.00	34
CASB	Diesel	2967	V6	83.00	35
CATA	Diesel	2967	V6	83.00	35
CAXA	Petrol	1390	4	76.50	7
CAXC	Petrol	1390	4	76.50	7
CAYB	Diesel	1598	4	79.50	15
CAYC	Diesel	1598	4	79.50	15
CBAA	Diesel	1968	4	81.00	26
CBAB	Diesel	1968	4	81.00	26
CBBB	Diesel	1968	4	81.00	26
CCLA	Diesel	2967	V6	83.00	34
CCMA	Diesel	2967	V6	83.00	34
CCSA	Petrol	1595	4	81.00	23
CCWA	Diesel	2967	V6	83.00	34
CCWB	Diesel	2967	V6	83.00	34
CDYA	Diesel	2967	V6	83.00	34
CDYB	Diesel	2967	V6	83.00	35
CDYC	Diesel	2967	V6	83.00	34
CFFA	Diesel	1968	4	81.00	26
CFFB	Diesel	1968	4	81.00	26
CFGB	Diesel	1968	4	81.00	26
CFGC	Diesel	1968	4	81.00	26
CFGD	Diesel	1968	4	81.00	26
CFHB	Diesel	1968	4	81.00	26
CFHD	Diesel	1968	4	81.00	26
CGKA	Diesel	2698	V6	83.00	34
CGKB	Diesel	2698	V6	83.00	34
CGLA	Diesel	1968	4	81.00	26
CGLB	Diesel	1968	4	81.00	26
CGLC	Diesel	1968	4	81.00	26
CGLD	Diesel	1968	4	81.00	26
CGLE	Diesel	1968	4	81.00	26
CGTA	Petrol	3993	V8	84.50	38
CJCA	Diesel	1968	4	81.00	26
CJCB	Diesel	1968	4	81.00	26
CJCC	Diesel	1968	4	81.00	26
CLJA	Diesel	1968	4	81.00	26

Motorverzeichnis • Index de moteur • Índice de Motor
Indeks silnika • Модель двигателя • دليل المحرك

ENGINE INDEX



CCM

x



9

CLLB	Diesel	1968	4	81.00	26
CMEA	Diesel	1968	4	81.00	26
CMGA	Diesel	1968	4	81.00	26
CMGB	Diesel	1968	4	81.00	26
CMSA	Petrol	1390	4	76.50	7
CN	Diesel	1986	5	76.50	8
CNVA	Petrol	1390	4	76.50	7
CR	Diesel	1588	4	76.50	8
CRDB	Petrol	3993	V8	84.50	38
CTHG	Petrol	1390	4	76.50	9
CY	Diesel	1588	4	76.50	10
DE	Diesel	1986	5	76.50	10
DR	Petrol	1781	4	81.00	18
DS	Petrol	1781	4	81.00	20
DT	Petrol	1595	4	81.00	18
DTA	Petrol	1595	4	81.00	18
DZ	Petrol	1781	4	81.00	20
EP	Petrol	1297	4	75.00	2
FY	Petrol	1272	4	75.00	3
FZ	Petrol	1272	4	75.00	3
HB	Petrol	1093	4	69.50	1
HC	Petrol	1093	4	69.50	1
HD	Petrol	1093	4	69.50	1
HH	Petrol	1272	4	75.00	3
HJ	Petrol	1272	4	75.00	3
HP	Petrol	1994	5	81.00	18
HX	Petrol	2226	5	81.00	18
HY	Petrol	2144	5	81.00	18
JK	Diesel	1588	4	76.50	8
JN	Petrol	1781	4	81.00	18
JS	Petrol	1994	5	81.00	18
JT	Petrol	2226	5	81.00	18
JU	Petrol	1595	4	81.00	18
JV	Petrol	1781	4	81.00	20
JW	Petrol	1781	4	81.00	20
KE	Petrol	2144	5	79.50	16
KF	Petrol	2144	5	79.50	16
KG	Petrol	2144	5	79.50	17
KJ	Petrol	2144	5	79.50	17
KK	Petrol	2144	5	79.50	16
KL	Petrol	2144	5	79.50	16
KM	Petrol	2226	5	81.00	18
KP	Petrol	1994	5	81.00	18
KU	Petrol	2226	5	81.00	18
KV	Petrol	2226	5	81.00	18
KX	Petrol	2226	5	81.00	18
KZ	Petrol	2226	5	81.00	18
MB	Petrol	2226	5	81.00	20
MC	Petrol	2226	5	81.00	18
MG	Petrol	1781	4	81.00	18
MU	Petrol	1781	4	81.00	20
NC	Diesel	1986	5	76.50	10
NE	Petrol	1781	4	81.00	20
NF	Petrol	2309	5	82.50	30
NG	Petrol	2309	5	82.50	30
NM	Petrol	1994	5	81.00	20
PH	Petrol	1781	4	81.00	20
PM	Petrol	1781	4	81.00	20
PP	Petrol	1595	4	81.00	18
PS	Petrol	1994	5	81.00	18

ENGINE INDEX

Motorverzeichnis • Index de moteur • Índice de Motor
Indeks silnika • Модель двигателя • دليل المحرك



CCM

x



9

PV	Petrol	1781	4	81.00	20
RA	Diesel	1588	4	76.50	10
RN	Petrol	1595	4	81.00	18
RNA	Petrol	1595	4	81.00	20
RR	Petrol	2226	5	81.00	18
RS	Petrol	1781	4	81.00	20
RT	Petrol	1994	5	81.00	18
RU	Petrol	1781	4	81.00	18
SA	Petrol	1595	4	81.00	18
SB	Diesel	1588	4	76.50	10
SD	Petrol	1847	4	82.50	32
SF	Petrol	1781	4	81.00	18
SH	Petrol	1781	4	81.00	20
SK	Petrol	1994	5	81.00	18
SL	Petrol	1994	5	81.00	18
WA	Petrol	1984	4	86.50	39
WB	Petrol	2144	5	79.50	16
WC	Petrol	2144	5	79.50	16
WD	Petrol	2144	5	79.50	16
WE	Petrol	2144	5	79.50	16
WG	Petrol	2144	5	79.50	16
WH	Petrol	1921	5	79.50	16
WJ	Petrol	2144	5	79.50	17
WN	Petrol	1921	5	79.50	16
WR	Petrol	2144	5	79.50	17
WU	Petrol	2144	5	79.50	16
WV	Petrol	1588	4	79.50	16
WX	Petrol	2144	5	79.50	17
WY	Petrol	1588	4	79.50	16
WZ	Petrol	1588	4	79.50	16
YG	Petrol	1588	4	79.50	16
YH	Petrol	1588	4	79.50	16
YK	Petrol	1588	4	79.50	16
YM	Petrol	1588	4	79.50	16
YN	Petrol	1588	4	79.50	16
YP	Petrol	1588	4	79.50	16
YS	Petrol	1588	4	79.50	17
YT	Petrol	1588	4	79.50	16
YV	Petrol	1588	4	79.50	16
YY	Petrol	1588	4	79.50	16
YZ	Petrol	1588	4	79.50	17
ZA	Petrol	1297	4	75.00	4
ZF	Petrol	1297	4	75.00	4
ZV	Petrol	1716	4	79.50	16



50 1.1	08/74→07/78	HB	4cyl. 1093cc	37kW (50PS)	1	TD4207
--------	-------------	----	-----------------	-------------	---	--------

50 1.1	08/74→07/77	HC	4cyl. 1093cc	44kW (60PS)		TD263
--------	-------------	----	-----------------	-------------	--	-------

50 1.1	01/75→12/78	HD	4cyl. 1093cc	38kW (52PS)		TD264
--------	-------------	----	-----------------	-------------	--	-------

08-108500-00 →05/1975	STD	69.50	2.000		001 IF CR P	IKA
			2.500		026 P	STD
			4.000		712 CR	ST
08-108600-00 05/1975→07/1978	STD	69.50	1.750		001 IF CR P	IKA
			2.500		026 P	STD
			4.000		712 CR	ST
08-108700-00 08-108707-00 08/1978→07/1981	STD 0.50mm	69.50	1.750		001 IF CR P	IKA
			2.000		026 P	STD
			4.000		712 CR	ST

80 1.3	09/78→07/86	EP	4cyl. 1297cc	44kW (60PS)	2	TD257
--------	-------------	----	-----------------	-------------	---	-------

08-408700-00 08-408707-00	STD 0.50mm	75.00	1.500		001 IF CR P	IKA
			1.750		026 P	STD
			3.000		231 CR P	STD

80 1.3	09/78→07/81	FY	4cyl. 1272cc	40kW (54PS)	3	TD259
--------	-------------	----	-----------------	-------------	---	-------

80 1.3	09/78→07/81	FZ	4cyl. 1272cc	44kW (60PS)		TD260
--------	-------------	----	-----------------	-------------	--	-------

50 1.3	08/77→07/78	HH	4cyl. 1272cc	44kW (60PS)		TD265
--------	-------------	----	-----------------	-------------	--	-------





50 1.3	01/77→07/78	HJ	4cyl. 1272cc	43kW (58PS)	TD16547
--------	-------------	----	-----------------	-------------	---------

08-404200-00	STD	75.00	1.750		001 IF CR P	IKA
08-404211-00	1.00mm		2.000		026 P	STD
			4.000		712 CR	ST

80 1.3	05/72→07/78	ZA	4cyl. 1297cc	40kW (54PS)	4	TD4214
--------	-------------	----	-----------------	-------------	---	--------

80 1.3	05/72→07/78	ZF	4cyl. 1297cc	44kW (60PS)	TD368
--------	-------------	----	-----------------	-------------	-------

08-108800-00	STD	75.00	2.000		001 IF CR P	IKA
08-108807-00	0.50mm		2.500		026 P	STD
			4.000		712 CR	ST

A2 1.2 TDI	03/01→08/05	ANY	3cyl. 1191cc	45kW (61PS)	5	TD17157
Diesel						

08-120100-00	STD	76.50	1.750		001 CK P	KV1
08-120107-00	0.50mm		2.000		005 IFU P	IKA
[R60520]			3.000		231 CR P	STD

A2 1.4	02/00→08/05	AUA	4cyl. 1390cc	55kW (75PS)	6	TD15248
--------	-------------	-----	-----------------	-------------	---	---------

A2 1.4	02/00→08/05	BBY	4cyl. 1390cc	55kW (75PS)	TD16414
--------	-------------	-----	-----------------	-------------	---------

08-116100-00	STD	76.50	1.200		001 NT	ST
08-116107-00	0.50mm		1.500		005 P	STD
			2.500		712 CR	ST

A3 1.6 FSI	08/03→09/07	BLF	4cyl. 1598cc	85kW (116PS)	7	TD20713
A3 Sportback 1.6 FSI	09/04→					

A3 1.6 FSI	08/03→09/07	BLP	4cyl. 1598cc	85kW (116PS)	TD17401
A3 Sportback 1.6 FSI	09/04→				





A1 1.4 TFSI			05/10→	CAXA	4cyl. 1390cc	90kW (122PS) Turbo Intercooled	TD24386
A1 Sportback 1.4 TFSI			11/11→				
A3 1.4 TFSI			09/07→08/12	CAXC	4cyl. 1390cc	92kW (125PS) Turbo Intercooled	TD20715
A3 Convertible 1.4 TFSI			02/11→				
A3 Sportback 1.4 TFSI			09/07→				
A3 1.4 TFSI			09/07→08/12	CMSA	4cyl. 1390cc	92kW (125PS) Turbo Intercooled	TD23936
A3 Sportback 1.4 TFSI			09/07→				
A1 1.4 TFSI			05/10→	CNVA	4cyl. 1390cc	90kW (122PS) Turbo Intercooled	TD24951
A1 Sportback 1.4 TFSI			11/11→				
08-429900-00	STD	76.50	1.200		001 NT		ST
08-429907-00	0.50mm		1.200		005 P		GOE13
			2.000		712 NT		ST
100 2.0 D			08/78→07/88	CN	5cyl. 1986cc	51kW (69PS) Diesel	TD247
100 Avant 2.0 D			08/78→11/90				
80 1.6 D			08/80→08/86	CR	4cyl. 1588cc	40kW (54PS) Diesel	TD248
80 1.6 D			08/80→08/91	JK	4cyl. 1588cc	40kW (54PS) Diesel	TD269
08-109500-00	STD	76.50	1.750		001 IF CR P		KV1
08-109505-00	0.25mm		2.000		005 IFU P		STD
08-109507-00	0.50mm		3.000		231 CR P		STD
08-109511-00	1.00mm						
[R43850]							
08-405200-00	STD	76.50	1.750		001 IF CR P		KV1
08-405205-00	0.25mm		2.000		005 IF P		STD
08-405207-00	0.50mm		3.000		231 CR P		STD
08-405211-00	1.00mm						
08/1976→							
A1 1.4 TFSI			01/11→	CTHG	4cyl. 1390cc	136kW (185PS) Turbo Intercooled	TD25659
A1 Sportback 1.4 TFSI			11/11→				
08-433900-00	STD	76.50	1.200		001 NT		ST
08-433907-00	0.50mm		1.500		005 P		GOE13
			2.000		712 NT		ST



80 1.6 TD 90 1.6 TD	08/81→05/86 10/85→01/87				CY	4cyl. 1588cc 51kW (69PS)		10
					Diesel	Turbo Intercooled		TD4205
100 2.0 D Turbo 100 Avant 2.0 TD	08/82→02/88 03/83→10/87				DE	5cyl. 1986cc 64kW (87PS)		
					Diesel	Turbo Intercooled		TD251
100 2.0 D Turbo, 100 Avant 2.0 TD	03/88→11/90				NC	5cyl. 1986cc 74kW (100PS)		
					Diesel	Turbo Intercooled		TD299
80 1.6 TD 90 1.6 TD	09/86→08/91 04/87→09/91				RA	4cyl. 1588cc 59kW (80PS)		
					Diesel	Turbo Intercooled		TD313
80 1.6 TD 90 1.6 TD	09/86→08/91 04/87→09/91				SB	4cyl. 1588cc 59kW (80PS)		
					Diesel	Turbo Intercooled		TD4211
08-109800-00	STD	76.50	1.750		001 IF CR P			KV1
08-109807-00	0.50mm		2.000		005 IFU CR P			IKA
08-109811-00	1.00mm		3.000		231 CR P			STD
[R45270]								
A4 2.5 TDI, A4 2.5 TDI quattro A4 Avant 2.5 TDI, A4 Avant 2.5 TDI quattro	09/97→11/00 09/97→09/01				AFB	V6cyl. 2496cc 110kW (150PS)		11
A6 2.5 TDI, A6 2.5 TDI quattro A6 Avant 2.5 TDI, A6 Avant 2.5 TDI quattro	07/97→01/05 12/97→01/05				Diesel	Turbo Intercooled		
A8 2.5 TDI A8 2.5 TDI quattro	01/97→04/00 07/97→04/00							TD9517
A4 2.5 TDI quattro A4 Avant 2.5 TDi A4 Avant 2.5 TDI quattro	11/00→12/04 10/00→05/03 09/01→12/04				AKE	V6cyl. 2496cc 132kW (180PS)		
A6 2.5 TDI, A6 2.5 TDI quattro, A6 Avant 2.5 TDI, A6 Avant 2.5 TDI quattro	02/00→01/05				Diesel	Turbo Intercooled		
A8 2.5 TDI, A8 2.5 TDI quattro Allroad 2.5 TDI quattro	09/00→09/02 05/00→08/05							TD15312
A4 2.5 TDI, A4 2.5 TDI quattro A4 Avant 2.5 TDI, A4 Avant 2.5 TDI quattro	09/97→11/00 09/97→09/01				AKN	V6cyl. 2496cc 110kW (150PS)		
A6 2.5 TDI, A6 2.5 TDI quattro A6 Avant 2.5 TDI, A6 Avant 2.5 TDI quattro	07/97→01/05 12/97→01/05				Diesel	Turbo Intercooled		
A8 2.5 TDI A8 2.5 TDI quattro	01/97→04/00 07/97→04/00							TD11356
A4 2.5 TDI A4 Avant 2.5 TDI A6 2.5 TDI, A6 Avant 2.5 TDI	08/01→07/02 09/01→07/02 08/01→01/05				AYM	V6cyl. 2496cc 114kW (155PS)		
					Diesel	Turbo Intercooled		TD16384
A4 2.5 TDI quattro A4 Avant 2.5 TDI quattro A6 2.5 TDI, A6 2.5 TDI quattro, A6 Avant 2.5 TDI, A6 Avant 2.5 TDI quattro	11/00→12/04 09/01→12/04 02/00→01/05				BAU	V6cyl. 2496cc 132kW (180PS)		
Allroad 2.5 TDI quattro	05/00→08/05				Diesel	Turbo Intercooled		TD17033





A4 2.5 TDI, A4 Avant 2.5 TDI		07/02→12/04	BCZ		V6cyl.		
A4 Convertible 2.5 TDI		08/02→12/05			2496cc	120kW (163PS)	
A6 2.5 TDI, A6 Avant 2.5 TDI		07/02→01/05	Diesel		Turbo Intercooled		TD16859
Allroad 2.5 TDI quattro		05/03→08/05					
A4 2.5 TDI, A4 Avant 2.5 TDI		07/02→05/06	BDG		V6cyl.		
A4 Convertible 2.5 TDI		08/02→12/05			2496cc	120kW (163PS)	
A6 2.5 TDI, A6 Avant 2.5 TDI		07/02→01/05	Diesel		Turbo Intercooled		TD16860
A4 2.5 TDI quattro		11/00→12/04	BDH		V6cyl.		
A4 Avant 2.5 TDI quattro		09/01→12/04			2496cc	132kW (180PS)	
A6 2.5 TDI, A6 2.5 TDI quattro,		02/00→01/05	Diesel		Turbo Intercooled		TD17034
A6 Avant 2.5 TDI,							
A6 Avant 2.5 TDI quattro							
A4 2.5 TDI, A4 Avant 2.5 TDI		07/02→12/04	BFC		V6cyl.		
A4 Convertible 2.5 TDI		08/02→12/05			2496cc	120kW (163PS)	
A6 2.5 TDI, A6 Avant 2.5 TDI		07/02→01/05	Diesel		Turbo Intercooled		TD16858
08-103000-00	STD	78.30	1.750		001 CK P		KV1
08-103007-00	0.50mm		2.000		005 IFU P		IKA
[R66900]			3.000		231 CR P		STD
80 1.9 D		08/89→08/91	1Y		4cyl.		12
					1896cc	47kW (64PS)	
			Diesel				TD213
100 2.4 D		08/89→07/91	3D		5cyl.		
100 Avant 2.4 D		08/89→11/90			2370cc	60kW (81PS)	
			Diesel				TD218
100 2.4 D, 100 Avant 2.4 D		12/90→06/94	AAS		5cyl.		
					2370cc	60kW (81PS)	
			Diesel				TD227
80 1.9 TD, 80 Avant 1.9 TD		09/91→12/94	AAZ		4cyl.		
					1896cc	55kW (75PS)	
			Diesel		Turbo		TD229
80 1.9D		08/89→08/91	ADE		4cyl.		
					1896cc	55kW (75PS)	
			Diesel		Turbo		TD22656
08-990100-00	STD	79.50	1.750		001 CR P		KV1
08-990105-00	0.25mm		2.000		005 IFU P		STD
08-990107-00	0.50mm		3.000		231 CR P		STD
08-990111-00	1.00mm						
[R45120]							
80 1.9 TDI		09/91→12/94	1Z		4cyl.		13
80 Avant 1.9 TDI		07/92→01/96			1896cc	66kW (89PS)	
A4 1.9 TDI		01/95→11/00	Diesel		Turbo Intercooled		
A4 Avant 1.9 TDI		02/96→09/01					
A6 1.9 TDI		06/94→10/97					
A6 Avant 1.9 TDI		06/94→12/97					
Cabriolet 1.9 TDI		06/95→08/00					TD214





A4 1.9 TDI A4 Avant 1.9 TDI	12/95→11/00 03/96→09/01	AFF	4cyl. 1896cc 55kW (75PS)	Diesel Turbo Intercooled	TD11597
A4 1.9 TDI A4 1.9 TDI quattro A4 Avant 1.9 TDI A4 Avant 1.9 TDI quattro A6 1.9 TDI A6 Avant 1.9 TDI	10/95→11/00 09/96→11/00 02/96→09/01 09/96→09/01 04/97→10/00 02/98→04/01	AFN	4cyl. 1896cc 81kW (110PS)	Diesel Turbo Intercooled	TD4202
A3 1.9 TDI	09/96→07/01	AGR	4cyl. 1896cc 66kW (89PS)	Diesel Turbo Intercooled	TD5076
A3 1.9 TDI	08/97→07/01	AHF	4cyl. 1896cc 81kW (110PS)	Diesel Turbo Intercooled	TD9371
A4 1.9 TDI A4 Avant 1.9 TDI	01/95→11/00 02/96→09/01	AHH	4cyl. 1896cc 66kW (89PS)	Diesel Turbo Intercooled	TD16413
A4 1.9 TDI A4 Avant 1.9 DUO A4 Avant 1.9 TDI A6 1.9 TDI A6 Avant 1.9 TDI Cabriolet 1.9 TDI	01/95→11/00 03/98→09/01 02/96→09/01 06/94→10/97 06/94→12/97 06/95→08/00	AHU	4cyl. 1896cc 66kW (89PS)	Diesel Turbo Intercooled	TD10814
A4 1.9 TDI, A4 1.9 TDI quattro A4 Avant 1.9 TDI, A4 Avant 1.9 TDI quattro A6 1.9 TDI, A6 Avant 1.9 TDI	03/00→11/00 03/00→09/01 07/00→01/05	AJM	4cyl. 1896cc 85kW (116PS)	Diesel Turbo Intercooled	TD11527
A3 1.9 TDI	09/96→07/01	ALH	4cyl. 1896cc 66kW (89PS)	Diesel Turbo Intercooled	TD11595
A2 1.4 TDI	02/00→08/05	AMF	3cyl. 1422cc 55kW (75PS)	Diesel Turbo Intercooled	TD17156
A3 1.9 TDI		ANU	4cyl. 1896cc 66kW (89PS)	Diesel Turbo Intercooled	TD11596
A3 1.9 TDI	08/97→07/01	ASV	4cyl. 1896cc 81kW (110PS)	Diesel Turbo Intercooled	TD15354
A3 1.9 TDI, A3 1.9 TDI quattro	08/00→05/03	ASZ	4cyl. 1896cc 96kW (131PS)	Diesel Turbo Intercooled	TD15351
A3 1.9 TDI	10/00→05/03	ATD	4cyl. 1896cc 74kW (100PS)	Diesel Turbo Intercooled	TD16028





A4 1.9 TDI quattro A4 Avant 1.9 TDI quattro	03/00→11/00 03/00→09/01	ATJ	4cyl. 1896cc 85kW (116PS)	Diesel	Turbo Intercooled	TD15989
A2 1.4 TDI	11/03→08/05	ATL	3cyl. 1422cc 66kW (89PS)	Diesel	Turbo Intercooled	TD17071
A4 1.9 TDI A4 Avant 1.9 TDI	05/01→12/04 11/01→12/04	AVB	4cyl. 1896cc 74kW (100PS)	Diesel	Turbo Intercooled	TD16518
A4 1.9 TDI A4 1.9 TDI quattro A4 Avant 1.9 TDI A4 Avant 1.9 TDI quattro A6 1.9 TDI, A6 Avant 1.9 TDI	11/00→12/04 11/01→12/04 09/01→12/04 11/01→12/04 08/01→01/05	AVF	4cyl. 1896cc 96kW (131PS)	Diesel	Turbo Intercooled	TD15348
A4 1.9 TDI A4 1.9 TDI quattro A4 Avant 1.9 TDI A4 Avant 1.9 TDI quattro A6 1.9 TDI	10/95→11/00 09/96→11/00 02/96→09/01 09/96→09/01 04/97→10/00	AVG	4cyl. 1896cc 81kW (110PS)	Diesel	Turbo Intercooled	TD13774
A4 1.9 TDI A4 Avant 1.9 TDI A6 1.9 TDI, A6 Avant 1.9 TDI	11/00→12/04 09/01→12/04 08/01→01/05	AWX	4cyl. 1896cc 96kW (131PS)	Diesel	Turbo Intercooled	TD16133
A3 1.9 TDI	10/00→05/03	AXR	4cyl. 1896cc 74kW (100PS)	Diesel	Turbo Intercooled	TD16416
A2 1.4 TDI	02/00→08/05	BHC	3cyl. 1422cc 55kW (75PS)	Diesel	Turbo Intercooled	TD18133
08-114900-00 08-114905-00 08-114907-00 08-114911-00	STD 0.25mm 0.50mm 1.00mm	79.50	1.750 2.000 3.000	  	001 CK P 005 IFU P 231 CR P	KV1 STD STD
[R60370]						
A3 1.9 TDI A3 Sportback 1.9 TDI	05/03→05/10 09/04→05/10	BKC	4cyl. 1896cc 77kW (105PS)	Diesel	Turbo Intercooled	TD17026
A4 1.9 TDI, A4 Avant 1.9 TDI	06/04→06/08	BKE	4cyl. 1896cc 85kW (116PS)	Diesel	Turbo Intercooled	TD17596
A3 1.9 TDI A3 Convertible 1.9 TDI A3 Sportback 1.9 TDI	05/03→05/10 04/08→ 09/04→05/10	BLS	4cyl. 1896cc 77kW (105PS)	Diesel	Turbo Intercooled	TD20823
A4 1.9 TDI, A4 Avant 1.9 TDI	11/04→06/08	BRB	4cyl. 1896cc 85kW (116PS)	Diesel	Turbo Intercooled	TD20492

14





A3 1.9 TDI			05/03→05/10	BXE				
A3 Sportback 1.9 TDI			09/04→05/10		4cyl.			
					1896cc	77kW (105PS)		
				Diesel	Turbo Intercooled			TD22657
08-114900-00	STD	79.50	1.750		001 CK P			KV1
08-114905-00	0.25mm		2.000		005 IFU P			STD
08-114907-00	0.50mm		3.000		231 CR P			STD
08-114911-00	1.00mm							
<i>[R60370]</i>								
08-433000-00	STD	79.50	1.750		001 GDC P			KV4
08-433007-00	0.50mm		2.000		005 IFU P			F12/F14
01/2006→ with DPF			3.000		231 LKZ CR P			GOE13
A1 1.6 TDI			03/11→	CAYB				15
A1 Sportback 1.6 TDI			11/11→		4cyl.			
A3 1.6 TDI			05/09→08/12		1598cc	66kW (89PS)		
A3 Sportback 1.6 TDI			05/09→	Diesel	Turbo Intercooled		TD22661	
A1 1.6 TDI			05/10→	CAYC				
A1 Sportback 1.6 TDI			11/11→		4cyl.			
A3 1.6 TDI			05/09→08/12		1598cc	77kW (105PS)		
A3 Convertible 1.6 TDI,			05/09→	Diesel	Turbo Intercooled		TD22662	
A3 Sportback 1.6 TDI								
08-432900-00	STD	79.50	1.750		001 GDC P			KV4
08-432907-00	0.50mm		2.000		005 IFU P			F12/F14
			3.000		231 LKZ CR P			STD
Coupe 2.1 GT			09/82→08/84	KE				16
					5cyl.			
					2144cc	96kW (131PS)		TD281
100 2.2, 100 Avant 2.1			08/82→07/84	KF				TD282
					5cyl.			
					2144cc	96kW (131PS)		
80 2.2 quattro			08/82→07/84	KK				TD286
					5cyl.			
					2144cc	100kW (136PS)		
80 2.2 quattro			08/82→07/84	KL				TD288
Coupe 2.1 GT			09/82→08/84		5cyl.			
					2144cc	96kW (131PS)		
100 2.1			10/77→07/82	WB				TD330
100 Avant 2.1			07/77→02/83		5cyl.			
					2144cc	85kW (116PS)		





100 2.1 100 Avant 2.1 200 2.1 5 E	03/77→07/84 07/77→07/84 10/79→07/84	WC	5cyl. 2144cc	100kW (136PS)	TD331
5000 2.2L	06/77→09/82	WD	5cyl. 2144cc	79kW (107PS)	TD332
80 2.2 100 2.1 100 Avant 2.1 Coupe 2.1 GT	10/80→07/83 10/77→07/82 07/77→02/83 01/81→07/83	WE	5cyl. 2144cc	79-85kW (107-116PS)	TD333
100 2.1 100 Avant 2.1	03/77→07/82 07/77→02/83	WG	5cyl. 2144cc	100kW (136PS)	TD335
100 1.9, 100 Avant 1.9	08/80→07/84	WH	5cyl. 1921cc	74kW (100PS)	TD336
80 1.9 CD-5S Coupe 1.9	09/81→07/83 08/80→07/83	WN	5cyl. 1921cc	85kW (116PS)	TD339
100 2.2	08/82→07/84	WU	5cyl. 2144cc	79kW (107PS)	TD344
80 1.6	08/78→07/86	WV	4cyl. 1588cc	55kW (75PS)	TD345
80 1.6	09/75→07/83	WY	4cyl. 1588cc	55kW (75PS)	TD348
80 1.6	09/75→07/83	WZ	4cyl. 1588cc	55kW (75PS)	TD17147
80 1.6	08/78→08/79	YG	4cyl. 1588cc	61kW (82PS)	TD353
80 1.6	08/78→08/79	YH	4cyl. 1588cc	61kW (82PS)	TD354
80 1.6	08/78→08/79	YK	4cyl. 1588cc	61kW (82PS)	TD356
100 1.6	01/75→07/76	YM	4cyl. 1588cc	63kW (86PS)	TD357







80 1.6 Coupe 1.6		09/75→07/86 07/80→08/81	YN	4cyl. 1588cc	55kW (75PS)	TD358
80 1.6		09/75→02/83	YP	4cyl. 1588cc	63kW (86PS)	TD359
80 1.6		08/78→07/81	YT	4cyl. 1588cc	51kW (69PS)	TD361
100 1.6 100 Avant 1.6		08/76→07/82 07/77→02/83	YV	4cyl. 1588cc	63kW (86PS)	TD362
80 1.6		08/78→07/81	YY	4cyl. 1588cc	51kW (69PS)	TD363
100 1.8		11/68→11/71	ZV	4cyl. 1716cc	59kW (80PS)	TD377
08-404100-00	STD	79.50	1.750		001 IF CR P	IKA
[R40200]			2.000		026 P	STD
			4.000		712 CR	ST
200 2.1 Turbo		08/83→01/88	KG	5cyl.		17
200 2.1 Turbo quattro		08/83→09/86		2144cc	134kW (182PS)	TD283
200 Avant 2.1 Turbo quattro		09/83→01/88		Turbo Intercooled		
200		10/79→08/82	KJ	5cyl. 2144cc	125kW (170PS)	TD285
				Turbo		
200 2.1 5 T		10/79→08/82	WJ	5cyl. 2144cc	125kW (170PS)	TD337
				Turbo		
Quattro 2.1 Turbo		07/80→07/87	WR	5cyl. 2144cc	147kW (200PS)	TD341
				Turbo Intercooled		
Quattro 2.1 quattro		02/82→07/89	WX	5cyl. 2144cc	119kW (162PS)	TD347
				Turbo		
80 1.6 GTE		01/76→07/78	YS	4cyl. 1588cc	81kW (110PS)	TD360





80 1.6 GLE		01/79→12/86	YZ	4cyl. 1588cc	81kW (110PS)	TD364
08-405000-00	STD	79.50	1.750	 001 IF MO P	IKA	
			2.000	 026 P	STD	
			4.000	 712 CR	ST	
200 2.2 Turbo		02/88→12/90	1B	5cyl. 2226cc	147kW (200PS)	18
200 2.2 Turbo quattro		02/88→11/90		Turbo		TD211
200 Avant 2.2 Turbo quattro		02/88→12/91				
Quattro 2.2 Turbo		08/87→07/89				
200 2.2 Turbo		02/88→12/90	2B	5cyl. 2226cc	140kW (190PS)	TD215
80 1.6		09/91→12/94	ABM	4cyl. 1595cc	52kW (71PS)	TD234
80 1.6 E		06/93→12/94	ADA	4cyl. 1595cc	74kW (100PS)	TD240
80 Avant 1.6 E		06/93→01/96				
100 1.8, 100 Avant 1.8		08/82→12/87	DR	4cyl. 1781cc	55kW (75PS)	TD252
80 1.6		08/78→07/86	DT	4cyl. 1595cc	55kW (75PS)	TD4206
80 1.6		08/78→07/86	DTA	4cyl. 1595cc	55kW (75PS)	TD255
80 2.0		10/83→09/84	HP	5cyl. 1994cc	85kW (116PS)	TD266
90 2.0		10/84→03/87				
Coupe 2.0		09/83→07/86				
100 2.2 CAT, 100 2.2 quattro CAT, 100 Avant 2.2 CAT, 100 Avant 2.2 quattro CAT		06/89→11/90	HX	5cyl. 2226cc	100kW (136PS)	TD267
90 2.2		10/84→03/87	HY	5cyl. 2144cc	100kW (136PS)	TD268
Coupe 2.2 GT		09/84→10/88				
Quattro 2.2 quattro		12/84→07/87				
80 1.8		08/83→08/86	JN	4cyl. 1781cc	66kW (89PS)	TD4208
80 1.8 CC quattro		08/85→08/86				
80 1.8 S		09/86→10/91				
80 1.8 S quattro		09/86→09/91				
Coupe 1.8 GT		01/85→07/88				
Coupe 1.8 GT quattro		09/85→10/88				





80 2.0, 80 2.0 quattro	10/83→09/84	JS	5cyl. 1994cc	85kW (116PS)	TD274
90 2.0	10/84→03/87				
90 2.0 quattro	08/84→08/86				
Coupe 2.0	09/83→07/86				
90 2.2 E quattro	08/85→03/87	JT	5cyl. 2226cc	88kW (120PS)	TD276
Coupe 2.2 quattro	08/85→10/88				
Quattro 2.2 quattro	12/84→07/87				
80 1.6		JU	4cyl. 1595cc	55kW (75PS)	TD277
Coupe 2.2i	09/82→07/83				
		KM	5cyl. 2226cc	77kW (105PS)	TD22511
100 2.0	08/84→12/87	KP	5cyl. 1994cc	85kW (116PS)	TD289
100 Avant 2.0 E	01/85→12/87				
100 2.2	08/84→12/88	KU	5cyl. 2226cc	101-103kW (137-140PS)	TD9375
100 2.2 CAT	06/89→11/90				
100 2.2 quattro	08/84→12/88				
100 2.2 quattro CAT	06/89→11/90				
100 Avant 2.2	08/84→12/88				
100 Avant 2.2 CAT	06/89→11/90				
100 Avant 2.2 quattro	08/84→12/88				
100 Avant 2.2 quattro CAT	06/89→11/90				
200 2.2	08/84→07/85				
90 2.2	10/84→03/87	KV	5cyl. 2226cc	100kW (136PS)	TD4209
90 2.2 E	04/87→07/91				
90 2.2 E quattro	11/84→09/91				
Coupe 2.2 GT	09/84→10/88				
Coupe 2.2 quattro	10/84→07/91				
Quattro 2.2 quattro	12/84→07/87				
90 2.2	01/85→03/87	KX	5cyl. 2226cc	85kW (116PS)	TD293
Coupe 2.2 GT	07/81→10/87				
100 2.2, 100 Avant 2.2	10/84→09/86	KZ	5cyl. 2226cc	85kW (116PS)	TD294
100 2.2 E Turbo quattro, 100 2.2 Turbo, 100 Avant 2.2 Turbo, 100 Avant 2.2 Turbo quattro	08/86→11/90	MC	5cyl. 2226cc	121kW (165PS) Turbo Intercooled	TD296
200 2.2 Turbo	08/85→09/91				
200 2.2 Turbo quattro	01/85→12/91				
200 Avant 2.2 Turbo	08/85→09/91				
200 Avant 2.2 Turbo quattro	09/83→12/90				
4000 1.8i	08/85→03/87	MG	4cyl. 1781cc	79kW (107PS)	TD297
80 1.6	08/87→09/91	PP	4cyl. 1595cc	51kW (69PS)	TD307





90 2.0	07/88→09/91	PS	5cyl. 1994cc	85kW (116PS)	TD308
80 1.6	09/86→08/91	RN	4cyl. 1595cc	55kW (75PS)	TD314
Quattro 2.2 20V	08/89→07/91	RR	5cyl. 2226cc Turbo	162kW (220PS)	TD316
100 2.0 CAT, 100 Avant 2.0 E CAT	01/88→11/90	RT	5cyl. 1994cc	85kW (116PS)	TD318
80 1.8	10/86→01/90	RU	4cyl. 1781cc	55kW (75PS)	TD320
80 1.6	02/86→07/86	SA	4cyl. 1595cc	54kW (73PS)	TD321
80 1.8 80 1.8 S 80 1.8 S quattro Coupe 1.8 GT	02/86→07/86 09/86→12/90 09/86→07/90 04/86→10/88	SF	4cyl. 1781cc	64kW (87PS)	TD325
90 2.0 Coupe 2.0	03/86→03/87 03/86→04/88	SK	5cyl. 1994cc	85kW (116PS)	TD327
100 2.0 100 Avant 2.0	08/86→11/87 09/86→11/87	SL	5cyl. 1994cc	83kW (113PS)	TD328

08-109700-00	STD	81.00	1.500		001 IF CR P	IKA
08-109705-00	0.25mm		1.750		026 P	STD
08-109707-00	0.50mm		3.000		231 CR P	STD
[R48000]						

100 2.5 TDI, 100 Avant 2.5 TDI	01/90→11/90	1T	5cyl. 2461cc	88kW (120PS)	19 TD212
			Diesel	Turbo Intercooled	
100 2.5 TDI, 100 Avant 2.5 TDI A6 2.5 TDI A6 Avant 2.5 TDI	12/90→06/94 06/94→10/97 06/94→12/97	AAT	5cyl. 2461cc	85kW (116PS)	TD228
			Diesel	Turbo Intercooled	
100 2.5 TDI, 100 Avant 2.5 TDI	12/90→06/94	ABP	5cyl. 2461cc	85kW (116PS)	TD235
			Diesel	Turbo Intercooled	





A6 2.5 TDI			08/94→10/97		AEL			
A6 2.5 TDI quattro			10/95→10/97			5cyl.		
A6 Avant 2.5 TDI			08/94→12/97			2461cc	103kW (140PS)	
A6 Avant 2.5 TDI quattro			07/95→12/97		Diesel	Turbo Intercooled		TD245
08-501500-00	STD	81.00	2.500		001 P PS			KV1
08-501507-00	0.50mm		2.000		005 IFU CR P			STD
[R60330]			3.000		231 CR P			STD
200 2.2 20V Turbo quattro			03/89→12/90		3B			20
200 Avant 2.2 20V Turbo quattro			07/89→12/90			5cyl.		
Coupe S2 quattro			09/90→09/92			2226cc	162kW (220PS)	
						Turbo Intercooled		TD4192
100 1.8 CAT			03/85→11/90		4B			
100 1.8 quattro CAT			08/85→11/90			4cyl.		
100 Avant 1.8 CAT			03/85→11/90			1781cc	66kW (89PS)	
100 Avant 1.8 quattro CAT			08/85→10/90					TD219
100 S4 Turbo quattro			08/91→06/94		AAN			
100 Avant S4 Turbo quattro			09/91→06/94			5cyl.		
A6 S6 Turbo quattro			06/94→10/97			2226cc	169kW (230PS)	
A6 Avant S6 Turbo quattro			06/94→12/97			Turbo Intercooled		TD225
80 1.6			08/90→10/91		ABB			
						4cyl.		
						1595cc	75kW (102PS)	
								TD230
80 S2 quattro			02/93→12/94		ABY			
80 Avant S2 quattro			02/93→07/95			5cyl.		
Coupe S2 quattro			10/92→12/96			2226cc	169kW (230PS)	
						Turbo Intercooled		TD237
80 Avant RS2 quattro			03/94→05/95		ADU			
						5cyl.		
						2226cc	232kW (315PS)	
						Turbo Intercooled		TD242
80 1.8			01/83→08/86		DS			
100 1.8, 100 Avant 1.8			08/83→07/89			4cyl.		
Coupe 1.8 GT			09/82→10/88			1781cc	66kW (89PS)	
Coupe 1.8 GT quattro			09/85→10/88					TD253
80 1.8 E			06/86→08/91		DZ			
80 1.8 E quattro			09/86→08/91			4cyl.		
80 1.8 GTE			10/84→08/86			1781cc	82kW (111PS)	
80 1.8 GTE quattro			08/84→08/86					
Coupe 1.8			08/89→07/91					
Coupe 1.8 GT			08/86→10/88					
Coupe 1.8 GT quattro			12/84→10/88					TD256
80 1.8			01/83→08/86		JV			
80 1.8 CC quattro			08/84→08/86			4cyl.		
Coupe 1.8 GT			09/82→10/88			1781cc	66kW (89PS)	
								TD278
100 1.8			08/83→07/89		JW			
100 1.8 quattro			10/84→07/88			4cyl.		
100 Avant 1.8			08/83→07/89			1781cc	66kW (89PS)	
100 Avant 1.8 quattro			10/84→07/88					TD279
Quattro 2.2 Turbo			08/87→07/89		MB			
						5cyl.		
						2226cc	147kW (200PS)	
						Turbo Intercooled		TD295





80 1.8 quattro				MU	4cyl. 1781cc	82kW (111PS)	TD298
80 1.8 CC quattro		08/84→08/86		NE	4cyl. 1781cc	66kW (89PS)	TD4210
80 1.8 S		09/86→10/91					
80 1.8 S quattro		09/86→09/91					
Coupe 1.8 GT quattro		09/85→10/88					
90 2.0 20 V				NM	5cyl. 1994cc	118kW (160PS)	TD303
90 2.0 20 V quattro		08/88→09/91					
Coupe 2.0 20 V, Coupe 2.0 20 V quattro		08/89→07/91					
100 1.8 CAT				PH	4cyl. 1781cc	66kW (89PS)	TD305
100 1.8 quattro CAT		08/85→11/90					
100 Avant 1.8 CAT		03/85→11/90					
100 Avant 1.8 quattro CAT		08/85→10/90					
80 1.8 S				PM	4cyl. 1781cc	66kW (89PS)	TD306
80 1.8 S quattro		09/86→10/91					
80 1.8 GTE				PV	4cyl. 1781cc	82kW (111PS)	TD311
80 1.8 GTE quattro		03/85→08/86					
Coupe 1.8 GT		08/86→10/87					
80 1.6				RNA	4cyl. 1595cc	51kW (69PS)	TD315
100 1.8, 100 Avant 1.8				RS	4cyl. 1781cc	55kW (75PS)	TD317
100 1.8				SH	4cyl. 1781cc	65kW (88PS)	TD326
100 1.8 quattro		02/86→07/88					
100 Avant 1.8		08/86→07/90					
100 Avant 1.8 quattro		02/86→07/90					
08-109400-10	STD	81.00	1.500		005 P PS		KV1
08-109407-10	0.50mm		1.750		026 P		STD
[R40850]			3.000		231 CR P		STD
A4 1.6				ADP	4cyl. 1595cc	74kW (100PS)	21 TD4198
A4 Avant 1.6		11/94→10/00					
A3 1.6				AEH	4cyl. 1595cc	74kW (100PS)	TD5074
A4 1.6				AHL	4cyl. 1595cc	74kW (100PS)	TD10816
A4 Avant 1.6		09/96→05/03					
		11/94→10/00					
		11/94→09/01					





A3 1.6		09/96→05/03	AKL	4cyl. 1595cc	74kW (100PS)	TD9990
A3 1.6		09/96→05/03	APF	4cyl. 1595cc	74kW (100PS)	TD11588
A4 1.6		11/94→10/00	ARM	4cyl. 1595cc	74kW (100PS)	TD14148
A4 Avant 1.6		11/94→09/01				
08-105900-00	STD	81.00	1.200		001 NT	ST
08-105907-00	0.50mm				026 P	STD
[R60290]				2.000		712 CR
A4 1.8, A4 1.8 quattro		01/95→11/00	ADR	4cyl. 1781cc	92kW (125PS)	TD241
A4 Avant 1.8		02/96→09/01				
A4 Avant 1.8 quattro		01/96→09/01				
A6 1.8, A6 1.8 quattro		12/95→10/97				
A6 Avant 1.8, A6 Avant 1.8 quattro		12/95→12/97				
Cabriolet 1.8		01/97→08/00				
A4 1.8 T, A4 1.8 T quattro		01/95→11/00	AEB	4cyl. 1781cc	110kW (150PS)	TD4199
A4 Avant 1.8 T		03/96→09/01				
A4 Avant 1.8 T quattro		01/96→09/01				
A6 1.8 T		01/97→01/05				
A6 1.8 T quattro		02/97→01/05				
A6 Avant 1.8 T, A6 Avant 1.8 T quattro		12/97→01/05				
A4 1.8		04/95→11/00	AFY	4cyl. 1781cc	85kW (116PS)	TD13948
A4 1.8 quattro		07/95→11/00				
A4 Avant 1.8, A4 Avant 1.8 quattro		07/95→09/01				
A6 1.8		05/97→01/05				
A6 Avant 1.8		02/98→01/05				
A3 1.8		09/96→05/03	AGN	4cyl. 1781cc	92kW (125PS)	TD5073
A3 1.8 T, A3 1.8 T quattro		12/96→05/03	AGU	4cyl. 1781cc	110kW (150PS)	TD5075
A4 1.8 T, A4 1.8 T quattro		12/97→11/00	AJL	4cyl. 1781cc	132kW (180PS)	TD9470
A4 Avant 1.8 T, A4 Avant 1.8 T quattro		12/97→09/01				
A6 1.8 T, A6 1.8 T quattro		12/97→01/05				
A6 Avant 1.8 T		04/99→01/05				
A6 Avant 1.8 T quattro		12/97→01/05				
A6 1.8		07/97→01/05	AJP	4cyl. 1781cc	92kW (125PS)	TD9518
A6 Avant 1.8		12/97→01/05				
A3 1.8 T		12/98→05/03	AJQ	4cyl. 1781cc	132kW (180PS)	TD11347
A3 1.8 T quattro		10/98→05/03				
TT 1.8 T, TT 1.8 T quattro		10/98→06/06				
TT Roadster 1.8 T		10/99→06/06				
TT Roadster 1.8 T quattro		02/00→06/06				





A4 1.8	05/00→09/00	AMB				
A4 1.8 T, A4 1.8 T quattro	07/01→12/04		4cyl.			
A4 Avant 1.8 T quattro	09/01→12/04		1781cc	125kW (170PS)		
A4 Convertible 1.8	10/02→10/05		Turbo Intercooled			TD17864
A4 1.8 T, A4 1.8 T quattro	01/95→11/00	ANB				
A4 Avant 1.8 T	03/96→09/01		4cyl.			
A4 Avant 1.8 T quattro	01/96→09/01		1781cc	110kW (150PS)		
A6 1.8 T	01/97→01/05		Turbo Intercooled			
A6 1.8 T quattro	02/97→01/05					
A6 Avant 1.8 T, A6 Avant 1.8 T quattro	12/97→01/05					TD13949
A3 1.8	09/96→05/03	APG				
			4cyl.			
			1781cc	92kW (125PS)		
						TD11589
A3 1.8 T	12/98→05/03	APP				
TT 1.8 T	10/98→06/06		4cyl.			
TT Roadster 1.8 T	10/99→06/06		1781cc	132kW (180PS)		
			Turbo Intercooled			TD11591
A4 1.8, A4 1.8 quattro	01/95→11/00	APT				
A4 Avant 1.8	02/96→09/01		4cyl.			
A4 Avant 1.8 quattro	01/96→09/01		1781cc	92kW (125PS)		
						TD13775
A4 1.8 T, A4 1.8 T quattro	01/95→11/00	APU				
A4 Avant 1.8 T	03/96→09/01		4cyl.			
A4 Avant 1.8 T quattro	01/96→09/01		1781cc	110kW (150PS)		
A6 1.8 T	01/97→01/05		Turbo Intercooled			
A6 1.8 T quattro	02/97→01/05					
A6 Avant 1.8 T, A6 Avant 1.8 T quattro	12/97→01/05					TD13950
A3 1.8 T, A3 1.8 T quattro	12/96→05/03	AQA				
			4cyl.			
			1781cc	110kW (150PS)		
			Turbo Intercooled			TD11592
A6 1.8	07/97→01/05	AQE				
A6 Avant 1.8	12/97→01/05		4cyl.			
			1781cc	92kW (125PS)		
						TD14029
A4 1.8, A4 1.8 quattro	01/95→11/00	ARG				
A4 Avant 1.8	02/96→09/01		4cyl.			
A4 Avant 1.8 quattro	01/96→09/01		1781cc	92kW (125PS)		
						TD13776
A6 1.8	07/97→01/05	ARH				
A6 Avant 1.8	12/97→01/05		4cyl.			
			1781cc	92kW (125PS)		
						TD15329
A4 1.8 T, A4 1.8 T quattro	01/95→11/00	ARK				
A4 Avant 1.8 T	03/96→09/01		4cyl.			
A4 Avant 1.8 T quattro	01/96→09/01		1781cc	110kW (150PS)		
A6 1.8 T	01/97→01/05		Turbo Intercooled			
A6 1.8 T quattro	02/97→01/05					
A6 Avant 1.8 T, A6 Avant 1.8 T quattro	12/97→01/05					TD13929
A3 1.8 T quattro	12/96→05/03	ARX				
			4cyl.			
			1781cc	110kW (150PS)		
			Turbo Intercooled			TD15988





A3 1.8 T	12/98→05/03	ARY	4cyl.				
A3 1.8 T quattro	10/98→05/03		1781cc	132kW (180PS)			
TT 1.8 T, TT 1.8 T quattro	10/98→06/06		Turbo Intercooled				TD15352
TT Roadster 1.8 T quattro	02/00→06/06						
A3 1.8 T	12/96→05/03	ARZ	4cyl.				
			1781cc	110kW (150PS)			
			Turbo Intercooled				TD11593
A3 1.8 T	12/96→05/03	AUM	4cyl.				
TT 1.8 T	09/02→06/06		1781cc	110kW (150PS)			
TT Roadster 1.8 T	01/01→06/06		Turbo Intercooled				TD15629
A3 1.8 T	12/98→05/03	AUQ	4cyl.				
TT 1.8 T	10/98→06/06		1781cc	132kW (180PS)			
TT Roadster 1.8 T	10/99→06/06		Turbo Intercooled				TD15353
A4 1.8 T, A4 1.8 T quattro	11/00→07/02	AVJ	4cyl.				
A4 Avant 1.8 T, A4 Avant 1.8 T quattro	09/01→07/02		1781cc	110kW (150PS)			
			Turbo Intercooled				TD15349
A4 1.8	01/95→11/00	AVV	4cyl.				
A4 Avant 1.8	02/96→09/01		1781cc	92kW (125PS)			
							TD16412
A4 1.8 T, A4 1.8 T quattro	01/95→11/00	AWT	4cyl.				
A4 Avant 1.8 T	03/96→09/01		1781cc	110kW (150PS)			
A4 Avant 1.8 T quattro	01/96→09/01		Turbo Intercooled				
A6 1.8 T	01/97→01/05						
A6 1.8 T quattro	02/97→01/05						
A6 Avant 1.8 T, A6 Avant 1.8 T quattro	12/97→01/05						TD15335
A4 1.8 T, A4 1.8 T quattro,	11/02→12/04	BEX	4cyl.				
A4 Avant 1.8 T, A4 Avant 1.8 T quattro			1781cc	140kW (190PS)			
			Turbo Intercooled				TD16730
A4 1.8 T, A4 1.8 T quattro,	07/02→06/08	BFB	4cyl.				
A4 Avant 1.8 T, A4 Avant 1.8 T quattro			1781cc	120kW (163PS)			
A4 Convertible 1.8 T	07/02→03/09		Turbo Intercooled				
A4 Convertible 1.8 T quattro	05/03→03/09						TD16728
08-502900-00	STD	81.00	1.500		001 CK P		KV1
08-502905-00	0.25mm		1.750		026 P		GOE13
08-502907-00	0.50mm		2.000		231 CR P		KV1
[R60320]							
A4 1.6, A4 Avant 1.6	07/00→06/08	ALZ	4cyl.				
			1595cc	75kW (102PS)			
							23
							TD15748
A4 1.6	11/94→10/00	ANA	4cyl.				
A4 Avant 1.6	11/94→09/01		1595cc	74kW (100PS)			
							TD14128
A3 1.6	08/00→05/03	AVU	4cyl.				
			1595cc	75kW (102PS)			
							TD15350





A3 1.6		08/00→05/03	BFQ	4cyl. 1595cc	75kW (102PS)	TD17166
A3 1.6 A3 Sportback 1.6		05/03→08/12 09/04→	BGU	4cyl. 1595cc	75kW (102PS)	TD16871
A3 1.6 A3 Convertible 1.6 A3 Sportback 1.6		05/03→08/12 09/08→ 09/04→	BSE	4cyl. 1595cc	75kW (102PS)	TD20711
A3 1.6 A3 Sportback 1.6		05/03→08/12 09/04→	BSF	4cyl. 1595cc	75kW (102PS)	TD20712
A3 1.6 A3 Sportback 1.6		05/03→08/12 09/04→	CCSA	4cyl. 1595cc	75kW (102PS)	TD22665
08-148300-00	STD	81.00	1.000	 001 NT	ST	
			1.200	 023 P	GOE13	
			2.000	 231 CR P	KV1	
A3 S3 quattro		03/99→04/02	AMK	4cyl. 1781cc	154kW (210PS) Turbo Intercooled	24 TD12648
TT 1.8 T quattro TT Roadster 1.8 T quattro		10/98→06/06 10/99→06/06	AMU	4cyl. 1781cc	165kW (224PS) Turbo Intercooled	TD15358
TT 1.8 T quattro TT Roadster 1.8 T quattro		10/98→06/06 10/99→06/06	APX	4cyl. 1781cc	121-162kW (165-221PS) Turbo Intercooled	TD11349
A3 S3 quattro		03/99→04/02	APY	4cyl. 1781cc	154kW (210PS) Turbo Intercooled	TD11594
A3 S3 quattro		03/99→04/02	AUL	4cyl. 1781cc	154kW (210PS) Turbo Intercooled	TD15355
A3 S3 quattro TT 1.8 T quattro TT Roadster 1.8 T quattro		10/01→05/03 10/98→06/06 10/99→06/06	BAM	4cyl. 1781cc	165kW (224PS) Turbo Intercooled	TD16331
08-115900-00	STD	81.00	1.500	 005 PS	ST	
			1.750	 026 P	GOE13	
			2.000	 231 CR P	KV1	



A3 2.0 TDI A3 2.0 TDI quattro A3 Sportback 2.0 TDI	05/03→08/12 05/03→06/08 09/04→	AZV	4cyl. 1968cc 100kW (136PS)	25	TD17027
		Diesel	Turbo Intercooled		
A3 2.0 TDI 16V A3 2.0 TDI 16V quattro A3 Sportback 2.0 TDI 16V A3 Sportback 2.0 TDI 16V quattro	05/03→08/12 08/04→08/12 09/04→ 11/05→	BKD	4cyl. 1968cc 103kW (140PS)		TD17025
		Diesel	Turbo Intercooled		
A4 2.0 TDI 16V, A4 Avant 2.0 TDI 16V A6 2.0 TDI A6 Avant 2.0 TDI	11/04→06/08 07/04→10/08 06/05→10/08	BLB	4cyl. 1968cc 103kW (140PS)		TD17377
		Diesel	Turbo Intercooled		
A3 2.0 TDI A3 2.0 TDI quattro A3 Sportback 2.0 TDI A3 Sportback 2.0 TDI quattro	06/05→06/08 01/06→06/08 06/05→06/08 01/06→06/08	BMM	4cyl. 1968cc 103kW (140PS)		TD18203
		Diesel	Turbo Intercooled		
A3 2.0 TDI, A3 2.0 TDI quattro A3 Sportback 2.0 TDI, A3 Sportback 2.0 TDI quattro	03/06→08/12 03/06→	BMN	4cyl. 1968cc 125kW (170PS)		TD18991
		Diesel	Turbo Intercooled		
A4 2.0 TDI, A4 Avant 2.0 TDI A6 2.0 TDI A6 Avant 2.0 TDI	11/04→06/08 07/04→03/11 06/05→08/11	BNA	4cyl. 1968cc 100kW (136PS)		TD18009
		Diesel	Turbo Intercooled		
A4 2.0 TDI A4 2.0 TDI quattro A4 Avant 2.0 TDI A4 Avant 2.0 TDI quattro A4 Convertible 2.0 TDI	11/04→06/08 01/06→06/08 11/04→06/08 01/06→06/08 01/06→03/09	BPW	4cyl. 1968cc 103kW (140PS)		TD18010
		Diesel	Turbo Intercooled		
A4 2.0 TDI, A4 2.0 TDI quattro, A4 Avant 2.0 TDI, A4 Avant 2.0 TDI quattro	06/06→06/08	BRD	4cyl. 1968cc 125kW (170PS)		TD20402
		Diesel	Turbo Intercooled		
A4 2.0 TDI 16V, A4 Avant 2.0 TDI 16V A6 2.0 TDI A6 Avant 2.0 TDI	11/04→06/08 07/04→10/08 06/05→10/08	BRE	4cyl. 1968cc 103kW (140PS)		TD18029
		Diesel	Turbo Intercooled		
A4 2.0 TDI, A4 Avant 2.0 TDI A6 2.0 TDI A6 Avant 2.0 TDI	11/04→06/08 07/04→03/11 06/05→08/11	BRF	4cyl. 1968cc 100kW (136PS)		TD18748
		Diesel	Turbo Intercooled		
A3 2.0 TDI, A3 Sportback 2.0 TDI	06/06→06/08	BUY	4cyl. 1968cc 120kW (163PS)		TD20403
		Diesel	Turbo Intercooled		
A4 2.0 TDI, A4 2.0 TDI quattro, A4 Avant 2.0 TDI, A4 Avant 2.0 TDI quattro	06/06→06/08	BVA	4cyl. 1968cc 120kW (163PS)		TD20529
		Diesel	Turbo Intercooled		
A4 2.0 TDI, A4 Avant 2.0 TDI	11/05→11/06	BVF	4cyl. 1968cc 93kW (126PS)		TD20497
		Diesel	Turbo Intercooled		





A4 2.0 TDI, A4 Avant 2.0 TDI		09/05→09/06	BVG				
A6 2.0 TDI, A6 Avant 2.0 TDI		09/05→06/06			4cyl.		
					1968cc	89kW (121PS)	
					Diesel	Turbo Intercooled	TD20496
08-139500-00	STD	81.00	1.750		001 CK P		
08-139507-00	0.50mm		2.000		005 IFU P		F12/F14
			3.000		231 CR P		STD
A4 2.0 TDI		11/07→	CAGA				26
A4 2.0 TDI quattro		11/08→			4cyl.		
A4 Allroad 2.0 TDI quattro		09/09→			1968cc	105kW (143PS)	
A4 Avant 2.0 TDI,		04/08→		Diesel	Turbo Intercooled		
A4 Avant 2.0 TDI quattro							
A5 Sportback 2.0 TDI		09/09→					
Q5 2.0 TDI quattro		08/09→					TD20597
A4 2.0 TDI		11/07→	CAGB				
A4 Allroad 2.0 TDI quattro		09/09→			4cyl.		
A4 Avant 2.0 TDI		04/08→			1968cc	100kW (136PS)	
A5 Sportback 2.0 TDI		09/09→		Diesel	Turbo Intercooled		
A6 2.0 TDI		07/04→03/11					
A6 Avant 2.0 TDI		06/05→08/11					
Q5 2.0 TDI quattro		08/09→					TD20598
A4 2.0 TDI, A4 Avant 2.0 TDI		06/08→	CAGC				
					4cyl.		
					1968cc	88kW (120PS)	
				Diesel	Turbo Intercooled		TD21118
A4 2.0 TDI, A4 2.0 TDI quattro		01/08→	CAHA				
A4 Allroad 2.0 TDI quattro		04/09→			4cyl.		
A4 Avant 2.0 TDI		04/08→			1968cc	125kW (170PS)	
A4 Avant 2.0 TDI quattro, A5 2.0 TDI,		08/08→		Diesel	Turbo Intercooled		
A5 2.0 TDI quattro							
A5 Convertible 2.0 TDI		05/09→					
A5 Sportback 2.0 TDI,		09/09→					
A5 Sportback 2.0 TDI quattro							
A6 2.0 TDI		11/08→03/11					
A6 Avant 2.0 TDI		10/08→08/11					
Q5 2.0 TDI quattro		11/08→					TD20602
A4 2.0 TDI		08/08→	CAHB				
A4 Allroad 2.0 TDI quattro		04/09→			4cyl.		
A4 Avant 2.0 TDI, A5 2.0 TDI		08/08→			1968cc	120kW (163PS)	
A5 Convertible 2.0 TDI		05/09→		Diesel	Turbo Intercooled		
A5 Sportback 2.0 TDI		09/09→					
A6 2.0 TDI		04/09→03/11					
A6 Avant 2.0 TDI		04/09→08/11					
Q5 2.0 TDI quattro		11/08→					TD20864
A3 2.0 TDI		05/03→08/12	CBAA				
A3 Convertible 2.0 TDI		04/08→			4cyl.		
A3 Sportback 2.0 TDI		09/04→			1968cc	100kW (136PS)	
				Diesel	Turbo Intercooled		TD20825
A3 2.0 TDI 16V		05/03→08/12	CBAB				
A3 2.0 TDI 16V quattro		08/04→08/12			4cyl.		
A3 Convertible 2.0 TDI		04/08→			1968cc	103kW (140PS)	
A3 Sportback 2.0 TDI 16V		09/04→		Diesel	Turbo Intercooled		
A3 Sportback 2.0 TDI 16V quattro		11/05→					TD20828





A3 2.0 TDI, A3 2.0 TDI quattro	03/06→08/12	CBBB			
A3 Sportback 2.0 TDI,	03/06→		4cyl.		
A3 Sportback 2.0 TDI quattro			1968cc	125kW (170PS)	
TT 2.0 TDI quattro,	06/08→	Diesel	Turbo Intercooled		
TT Roadster 2.0 TDI quattro					TD20939
A3 2.0 TDI	05/03→08/12	CFFA			
A3 Convertible 2.0 TDI	04/08→		4cyl.		
A3 Sportback 2.0 TDI	09/04→		1968cc	100kW (136PS)	
Q3 2.0 TDI	09/11→	Diesel	Turbo Intercooled		TD23858
A3 2.0 TDI 16V	05/03→08/12	CFFB			
A3 2.0 TDI 16V quattro	08/04→08/12		4cyl.		
A3 Convertible 2.0 TDI	04/08→		1968cc	103kW (140PS)	
A3 Sportback 2.0 TDI 16V	09/04→	Diesel	Turbo Intercooled		
A3 Sportback 2.0 TDI 16V quattro	11/05→				
Q3 2.0 TDI	09/11→				
Q3 2.0 TDI quattro	01/12→				TD23859
A3 2.0 TDI, A3 2.0 TDI quattro	03/06→08/12	CFGB			
A3 Sportback 2.0 TDI,	03/06→		4cyl.		
A3 Sportback 2.0 TDI quattro			1968cc	125kW (170PS)	
TT 2.0 TDI quattro,	06/08→	Diesel	Turbo Intercooled		
TT Roadster 2.0 TDI quattro					TD23857
Q3 2.0 TDI	05/13→	CFGC			
Q3 2.0 TDI quattro	06/11→		4cyl.		
			1968cc	130kW (177PS)	
		Diesel	Turbo Intercooled		TD25727
Q3 2.0 TDI quattro	06/11→	CFGD			
			4cyl.		
			1968cc	120kW (163PS)	
		Diesel	Turbo Intercooled		TD25728
A1 2.0 TDI, A1 Sportback 2.0 TDI	05/12→	CFHB			
			4cyl.		
			1968cc	100kW (136PS)	
		Diesel	Turbo Intercooled		TD25662
A1 2.0 TDI, A1 Sportback 2.0 TDI	09/11→	CFHD			
			4cyl.		
			1968cc	105kW (143PS)	
		Diesel	Turbo Intercooled		TD24939
Q5 2.0 TDI quattro	11/08→	CGLA			
			4cyl.		
			1968cc	120kW (163PS)	
		Diesel	Turbo Intercooled		TD24406
Q5 2.0 TDI quattro	11/08→	CGLB			
			4cyl.		
			1968cc	125kW (170PS)	
		Diesel	Turbo Intercooled		TD24948
A4 2.0 TDI, A4 2.0 TDI quattro,	11/11→	CGLC			
A4 Allroad 2.0 TDI quattro,			4cyl.		
A4 Avant 2.0 TDI,			1968cc	130kW (177PS)	
A4 Avant 2.0 TDI quattro		Diesel	Turbo Intercooled		
A5 2.0 TDI	10/11→				
A5 2.0 TDI quattro	12/11→				
A5 Convertible 2.0 TDI	10/11→				
A5 Convertible 2.0 TDI quattro	01/12→				
A5 Sportback 2.0 TDI	10/11→				
A5 Sportback 2.0 TDI quattro	12/11→				
A6 2.0 TDI	03/11→				
A6 Avant 2.0 TDI	05/11→				
Q5 2.0 TDI quattro	06/12→				TD24870





A4 2.0 TDI	08/08→	CGLD			
A4 Allroad 2.0 TDI quattro	04/09→		4cyl.		
A4 Avant 2.0 TDI, A5 2.0 TDI	08/08→		1968cc	120kW (163PS)	
A5 Convertible 2.0 TDI	05/09→	Diesel	Turbo Intercooled		
A5 Sportback 2.0 TDI	09/09→				
A6 2.0 TDI	03/11→				
A6 Avant 2.0 TDI	05/11→				
Q5 2.0 TDI quattro	11/08→				TD24943
A6 2.0 TDI, A6 Avant 2.0 TDI	01/12→	CGLE			
			4cyl.		
			1968cc	100kW (136PS)	
		Diesel	Turbo Intercooled		TD26329
A4 2.0 TDI	11/07→	CJCA			
A4 2.0 TDI quattro	11/08→		4cyl.		
A4 Allroad 2.0 TDI quattro	09/09→		1968cc	105kW (143PS)	
A4 Avant 2.0 TDI,	04/08→	Diesel	Turbo Intercooled		
A4 Avant 2.0 TDI quattro					
A5 Convertible 2.0 TDI	10/11→				
A5 Sportback 2.0 TDI	09/09→				
Q5 2.0 TDI	11/10→				
Q5 2.0 TDI quattro	08/09→				TD24949
A4 2.0 TDI	11/07→	CJCB			
A4 Allroad 2.0 TDI quattro	09/09→		4cyl.		
A4 Avant 2.0 TDI	04/08→		1968cc	100kW (136PS)	
A5 Sportback 2.0 TDI	09/09→	Diesel	Turbo Intercooled		
Q5 2.0 TDI	11/10→				
Q5 2.0 TDI quattro	08/09→				TD24941
A4 2.0 TDI, A4 Avant 2.0 TDI	06/08→	CJCC			
			4cyl.		
			1968cc	88kW (120PS)	
		Diesel	Turbo Intercooled		TD26713
A3 2.0 TDI 16V	05/03→08/12	CLJA			
A3 Sportback 2.0 TDI 16V	09/04→		4cyl.		
			1968cc	103kW (140PS)	
		Diesel	Turbo Intercooled		TD23938
Q3 2.0 TDI quattro	06/11→	CLLB			
			4cyl.		
			1968cc	130kW (177PS)	
		Diesel	Turbo Intercooled		TD25729
A4 2.0 TDI	11/07→	CMEA			
A4 Avant 2.0 TDI	04/08→		4cyl.		
A5 Sportback 2.0 TDI	09/09→		1968cc	105kW (143PS)	
		Diesel	Turbo Intercooled		TD23939
Q5 2.0 TDI quattro	11/08→	CMGA			
			4cyl.		
			1968cc	125kW (170PS)	
		Diesel	Turbo Intercooled		TD25767
A4 2.0 TDI	11/11→	CMGB			
A6 2.0 TDI	03/11→		4cyl.		
A6 Avant 2.0 TDI	05/11→		1968cc	130kW (177PS)	
Q5 2.0 TDI quattro	06/12→	Diesel	Turbo Intercooled		TD24871

08-432300-00	STD	81.00	1.750		001 GDC P	KV4
08-432307-00	0.50mm		2.000		005 IFU P	F12/F14
			3.000		231 LKZ CR P	GOE13

08-432300-00 OE: 03L198151A

08-432300-00 OE: 03L198151A

08-432300-00 OE: 03L198151A

08-432300-00 OE: 03L198151A



80 2.0 E 16V	03/90→07/92	6A				27
80 2.0 E 16V quattro	03/90→08/91		4cyl.			
90 2.0 quattro	08/89→07/90		1984cc	101kW (137PS)		
Coupe 2.0 16 V	01/92→07/92				TD4193	
100 2.0	12/90→06/94	AAE				TD223
100 Avant 2.0 E	09/91→06/94		4cyl.			
A6 2.0	06/94→10/97		1984cc	74kW (100PS)		
A6 Avant 2.0	06/94→12/97					
80 2.8, 80 2.8 quattro	09/91→12/94	AAH				TD224
80 Avant 2.8	09/91→01/96		V6cyl.			
80 Avant 2.8 quattro	08/92→07/95		2771cc	128kW (174PS)		
100 2.8 E, 100 2.8 E quattro	12/90→06/94					
100 Avant 2.8 E, 100 Avant 2.8 E quattro	09/91→06/94					
A4 2.8	09/95→07/97					
A4 2.8 quattro	01/95→07/97					
A4 Avant 2.8	03/96→09/96					
A4 Avant 2.8 quattro	01/96→09/96					
A6 2.8, A6 2.8 quattro	06/94→10/97					
A6 Avant 2.8, A6 Avant 2.8 quattro	06/94→12/97					
A8 2.8, A8 2.8 quattro	03/94→03/96					
Cabriolet 2.8	11/92→08/00					
Coupe 2.8	09/91→12/96					
Coupe 2.8 quattro	08/91→12/96					
80 2.0 E, 80 2.0 E quattro	09/91→12/94	ABK				
80 Avant 2.0 E	07/92→01/96		4cyl.			
100 2.0 E	12/90→06/94		1984cc	85kW (116PS)		
100 Avant 2.0 E	09/91→06/94					
A6 2.0	06/94→10/97					
A6 Avant 2.0	06/94→12/97					
Cabriolet 2.0 E	01/93→07/98					
Coupe 2.0	05/89→12/96					
80 2.0	09/91→12/94	ABT				TD236
80 Avant 2.0	07/92→01/96		4cyl.	66kW (89PS)		
80 2.0 E 16V	08/92→12/94	ACE				TD238
80 2.0 E 16V quattro	04/92→12/94		4cyl.			
80 Avant 2.0 E 16V	02/93→01/96		1984cc	103kW (140PS)		
80 Avant 2.0 E 16V quattro	12/92→07/95					
100 2.0 E 16V	01/92→06/94					
100 2.0 E 16V quattro,	07/92→06/94					
100 Avant 2.0 E 16V,						
100 Avant 2.0 E 16V quattro						
A6 2.0 16V, A6 2.0 16V quattro	06/94→10/97					
A6 Avant 2.0 16V,	06/94→12/97					
A6 Avant 2.0 16V quattro						
Cabriolet 2.0 16V	06/95→07/96					
Coupe 2.0 16 V	08/92→12/96					
A4 2.8	10/96→11/00	ACK				TD4197
A4 2.8 quattro	10/96→08/01		V6cyl.			
A4 Avant 2.8, A4 Avant 2.8 quattro	10/96→09/01		2771cc	142kW (193PS)		
A6 2.8, A6 2.8 quattro, A6 Avant 2.8,	12/95→01/05					
A6 Avant 2.8 quattro						
A8 2.8, A8 2.8 quattro	04/96→09/02					
80 Avant 2.0 quattro	11/93→01/96	ADW				TD243
A6 2.0	08/95→07/96		4cyl.	1985cc	79kW (107PS)	





A6 2.8, A6 2.8 quattro	06/94→10/97	AEJ	V6cyl.	2771cc	120-128kW (163-174PS)	TD9541
A6 Avant 2.8, A6 Avant 2.8 quattro	06/94→12/97					
A8 2.8, A8 2.8 quattro	07/95→03/96					
A6 2.8	06/94→10/97	AFC	V6cyl.	2771cc	120kW (163PS)	TD246
A6 2.8	10/97→05/00	AGE	V6cyl.	2771cc	132kW (180PS)	TD15616
A6 2.8 quattro	01/98→04/00					
A6 Avant 2.8	12/97→05/00					
A4 2.8	10/96→11/00	ALG	V6cyl.	2771cc	142kW (193PS)	TD9516
A4 2.8 quattro	10/96→08/01					
A4 Avant 2.8, A4 Avant 2.8 quattro	10/96→09/01					
A6 2.8, A6 2.8 quattro	02/97→01/05					
A6 Avant 2.8, A6 Avant 2.8 quattro	12/97→01/05					
A8 2.8	04/96→09/02					
A4 2.8	10/96→11/00	AMX	V6cyl.	2771cc	142kW (193PS)	TD13930
A4 2.8 quattro	10/96→08/01					
A4 Avant 2.8, A4 Avant 2.8 quattro	10/96→09/01					
A6 2.8, A6 2.8 quattro	02/97→01/05					
A6 Avant 2.8, A6 Avant 2.8 quattro	12/97→01/05					
A8 2.8, A8 2.8 quattro	04/96→09/02					
A4 2.8	10/96→11/00	APR	V6cyl.	2771cc	142kW (193PS)	TD13931
A4 2.8 quattro	10/96→08/01					
A4 Avant 2.8, A4 Avant 2.8 quattro	10/96→09/01					
A6 2.8, A6 2.8 quattro	02/97→01/05					
A6 Avant 2.8, A6 Avant 2.8 quattro	12/97→01/05					
A8 2.8, A8 2.8 quattro	04/96→09/02					
A4 2.8	10/96→11/00	AQD	V6cyl.	2771cc	142kW (193PS)	TD13932
A4 2.8 quattro	10/96→08/01					
A4 Avant 2.8, A4 Avant 2.8 quattro	10/96→09/01					
A6 2.8, A6 2.8 quattro	02/97→01/05					
A6 Avant 2.8, A6 Avant 2.8 quattro	12/97→01/05					
A8 2.8, A8 2.8 quattro	04/96→09/02					
A4 Avant 2.8, A4 Avant 2.8 quattro	03/99→09/00	ATX	V6cyl.	2771cc	140kW (190PS)	TD15617
A6 2.8	07/99→01/05					
A6 2.8 quattro	07/99→05/01					
A6 Avant 2.8	07/99→01/05					
80 2.0 E, 80 2.0 E quattro	09/91→12/94	AXA	4cyl.	1984cc	85kW (116PS)	TD16865
80 Avant 2.0 E	07/92→01/96					
100 2.0 E	12/90→06/94					
100 Avant 2.0 E	09/91→06/94					
A6 2.0	06/94→10/97					
A6 Avant 2.0	06/94→12/97					
Cabriolet 2.0 E	01/93→07/98					
Coupe 2.0	05/89→12/96					
A6 2.8	07/99→01/05	BBG	V6cyl.	2771cc	140kW (190PS)	TD19142

08-501800-00	STD	82.50	1.200		005 PS	KV1
08-501807-00	0.50mm		1.500		005 IW P	STD
[R60310]			2.000		231 CR P	KV1



90 2.3 E 20V	08/88→07/91	7A					
90 2.3 E 20V quattro	06/88→09/91		5cyl.				28
Coupe 2.3 20V	08/89→07/91		2309cc	125kW (170PS)			
Coupe 2.3 20V quattro	11/88→12/96						TD221

08-501200-00 STD 12/1990→	82.50	1.200		005 P PS	KV1
		1.750		026 P	STD
		3.000		231 CR P	STD
08-991000-00 STD 08/1988→11/1990 [R66460]	82.50	1.500		005 P PS	KV1
		1.750		026 P	STD
		3.000		231 CR P	STD

80 2.0, 80 2.0 quattro	10/90→08/91	AAD				
100 2.0 E	12/90→06/94		4cyl.			29
100 2.0 E quattro	12/90→07/92		1984cc	85kW (116PS)		
100 Avant 2.0 E	09/91→06/94					
100 Avant 2.0 E quattro	12/90→07/92					
Coupe 2.0	05/89→12/96					TD222

08-500600-00 STD 08/1988→06/1990	82.50	1.500		005 P PS	KV1
		1.500		005 IW P	STD
		2.000		231 CR P	KV1
08-501800-00 STD 08-501807-00 0.50mm 06/1990→ [R60310]	82.50	1.200		005 PS	KV1
		1.500		005 IW P	STD
		2.000		231 CR P	KV1

100 2.3 E	01/90→06/94	AAR				
100 2.3 E quattro	12/90→06/94		5cyl.			30
100 2.3 quattro	01/90→11/90		2309cc	98kW (133PS)		
100 Avant 2.3	03/90→11/90					
100 Avant 2.3 E, 100 Avant 2.3 E quattro	09/91→06/94					
100 Avant 2.3 quattro	01/90→11/90					
A6 2.3, A6 2.3 quattro, A6 Avant 2.3, A6 Avant 2.3 quattro	06/94→12/95					TD4194

80 2.6	07/92→12/94	ABC				
80 2.6 quattro	06/92→12/94		V6cyl.			
80 Avant 2.6	07/92→01/96		2598cc	110kW (150PS)		
80 Avant 2.6 quattro	07/92→07/95					
100 2.6	03/92→06/94					
100 2.6 quattro	04/92→06/94					
100 Avant 2.6	03/92→06/94					
100 Avant 2.6 quattro	07/92→06/94					
A4 2.6, A4 2.6 quattro	01/95→11/00					
A4 Avant 2.6	02/96→09/01					
A4 Avant 2.6 quattro	01/96→09/01					
A6 2.6, A6 2.6 quattro	06/94→10/97					
A6 Avant 2.6, A6 Avant 2.6 quattro	06/94→12/97					
Cabriolet 2.6	06/93→08/00					
Coupe 2.6, Coupe 2.6 quattro	08/92→12/96					TD231





100 2.6, 100 Avant 2.6			07/93→06/94	ACZ				
100 Avant 2.6 E quattro			08/93→07/94		V6cyl.			
A4 2.6			01/96→07/97		2598cc	102kW	(139PS)	
A6 2.6			06/94→10/97					
A6 Avant 2.6			06/94→02/97					
Cabriolet 2.6			05/95→08/00					TD239
100 2.3 E			10/86→11/90	NF				
100 2.3 E quattro, 100 Avant 2.3,			08/86→11/90		5cyl.			
100 Avant 2.3 E quattro					2309cc	100kW	(136PS)	
200 2.3, 200 Avant 2.3			11/86→09/91					TD301
80 2.3 E, 80 2.3 E quattro			09/91→12/94	NG				
80 2.3 quattro			10/87→07/89		5cyl.			
80 Avant 2.3 E			07/92→01/96		2309cc	98-100kW	(133-136PS)	
80 Avant 2.3 E quattro			09/91→11/94					
90 2.3 E, 90 2.3 E quattro			04/87→09/91					
Cabriolet 2.3 E			05/91→07/94					
Coupe 2.3, Coupe 2.3 quattro			01/87→12/96					TD302
08-991400-00	STD	82.50	1.500		001 IF CR P			IKA
08-991407-00	0.50mm		1.750		026 P			STD
[R66450]			3.000		712 CR			ST
A4 2.0			11/00→06/08	ALT				31
A4 Avant 2.0			09/01→06/08		4cyl.			
A4 Convertible 2.0			09/04→12/05		1984cc	96kW	(131PS)	
A6 2.0, A6 Avant 2.0			08/01→01/05					TD15345
A4 3.0, A4 3.0 quattro			11/00→12/04	ASN				
A4 Avant 3.0, A4 Avant 3.0 quattro			09/01→12/04		V6cyl.			
A4 Convertible 3.0			04/02→12/05		2976cc	162kW	(220PS)	
A4 Convertible 3.0 quattro			05/03→12/05					
A6 3.0, A6 3.0 quattro, A6 Avant 3.0,			08/01→01/05					
A6 Avant 3.0 quattro								
A8 3.0			07/03→05/05					TD15346
A4 2.0 FSI, A4 Avant 2.0 FSI			07/02→07/05	AWA				
					4cyl.			
					1984cc	110kW	(150PS)	
								TD17035
A3 2.0 FSI			05/03→06/08	AXW				
					4cyl.			
					1984cc	110kW	(150PS)	
								TD16872
A3 2.0 TFSI, A3 2.0 TFSI quattro			09/04→08/12	AXX				
A3 Sportback 2.0 TFSI,			09/04→		4cyl.			
A3 Sportback 2.0 TFSI quattro					1984cc	147kW	(200PS)	
					Turbo Intercooled			TD17450
A4 3.0			04/01→05/06	BBJ				
A4 3.0 quattro			04/01→07/06		V6cyl.			
A4 Avant 3.0			04/01→05/06		2976cc	162kW	(220PS)	
A4 Avant 3.0 quattro			04/01→07/06					
A6 3.0			08/04→05/06					
A6 3.0 quattro			06/01→05/06					
A6 Avant 3.0, A6 Avant 3.0 quattro			03/05→05/06					
A8 3.0			07/03→05/06					TD16516
A3 2.0 FSI			05/03→06/08	BLR				
A3 Sportback 2.0 FSI			09/04→		4cyl.			
					1984cc	110kW	(150PS)	
								TD18199





A3 2.0 FSI A3 Sportback 2.0 FSI		05/03→06/08 09/04→	BLX	4cyl. 1984cc	110kW (150PS)	TD17404
A3 2.0 FSI A3 Sportback 2.0 FSI		05/03→06/08 09/04→	BLY	4cyl. 1984cc	110kW (150PS)	TD17405
A3 2.0 FSI A3 Sportback 2.0 FSI		05/03→06/08 09/04→	BMB	4cyl. 1984cc	110kW (150PS)	TD17406
A4 2.0 TFSI, A4 Avant 2.0 TFSI A6 2.0 TFSI A6 Avant 2.0 TFSI		10/06→06/08 06/05→03/11 06/05→08/11	BPJ	4cyl. 1984cc	125kW (170PS) Turbo Intercooled	TD18486
A3 Sportback 2.0 TFSI TT 2.0 TFSI TT Roadster 2.0 TFSI		09/04→ 08/06→06/10 03/07→06/10	BPY	4cyl. 1984cc	147kW (200PS) Turbo Intercooled	TD20704
A3 2.0 FSI A3 Sportback 2.0 FSI		05/03→06/08 09/04→	BVY	4cyl. 1984cc	110kW (150PS)	TD18200
A3 2.0 FSI A3 Sportback 2.0 FSI		05/03→06/08 09/04→	BVZ	4cyl. 1984cc	110kW (150PS)	TD18201
A3 2.0 TFSI, A3 2.0 TFSI quattro A3 Sportback 2.0 TFSI, A3 Sportback 2.0 TFSI quattro TT 2.0 TFSI TT Roadster 2.0 TFSI		09/04→08/12 09/04→ 08/06→06/10 03/07→06/10	BWA	4cyl. 1984cc	147kW (200PS) Turbo Intercooled	TD19199
A4 2.0 TFSI, A4 Avant 2.0 TFSI A6 2.0 TFSI		10/06→06/08 06/05→03/11	BYK	4cyl. 1984cc	125kW (170PS) Turbo Intercooled	TD20404
08-435100-10	STD	82.50	1.200		001 NT PVD	ST
			1.500		026	GOE13
			2.000		231 CR	KV1
80 1.8 80 1.8 quattro		09/86→07/88 09/86→08/90	SD	4cyl. 1847cc	83kW (113PS)	32 TD323
08-991000-00	STD	82.50	1.500		005 P PS	KV1
[R66460]			1.750		026 P	STD
			3.000		231 CR P	STD



A4 3.0 TDI quattro, A4 Avant 3.0 TDI quattro	01/06→06/08	ASB	V6cyl. 2967cc	171kW (233PS)	33
A4 Convertible 3.0 TDI quattro	01/06→03/09				
A6 3.0 TDI	06/06→03/11	Diesel	Turbo Intercooled		
A6 3.0 TDI quattro	06/06→10/08				
A6 Allroad 3.0 TDI quattro	05/06→10/08				
A6 Avant 3.0 TDi	06/06→08/11				
A6 Avant 3.0 TDI quattro	06/06→10/08				
A8 3.0 TDI quattro	08/03→07/10			TD17336	
A4 3.0 TDI quattro, A4 Avant 3.0 TDI quattro	11/04→06/08	BKN	V6cyl. 2967cc	150kW (204PS)	
A4 Convertible 3.0 TDI quattro	01/06→03/09	Diesel	Turbo Intercooled		
A6 3.0 TDI quattro	05/04→05/06	BMK	V6cyl. 2967cc	165kW (224PS)	TD17845
A6 Avant 3.0 TDI quattro	03/05→05/06	Diesel	Turbo Intercooled		
A6 3.0 TDI quattro	05/04→03/11	BNG	V6cyl. 2967cc	155kW (211PS)	TD17337
A6 Allroad 3.0 TDI quattro	05/06→08/11				
A6 Avant 3.0 TDI quattro	03/05→08/11				
A8 3.0 TDI quattro	11/03→07/10	Diesel	Turbo Intercooled		
A4 2.7 TDI, A4 Avant 2.7 TDI	01/06→06/08	BPP	V6cyl. 2698cc	132kW (180PS)	TD18926
A4 Convertible 2.7 TDI	06/06→03/09				
A6 2.7 TDI, A6 2.7 TDI quattro	11/04→10/08	Diesel	Turbo Intercooled		
A6 Allroad 2.7 TDI quattro	05/06→10/08				
A6 Avant 2.7 TDI,	03/05→10/08				
A6 Avant 2.7 TDI quattro					
A4 2.7 TDI	11/05→06/08	BSG	V6cyl. 2698cc	120kW (163PS)	TD18030
A4 Avant 2.7 TDi	11/05→03/08				
A6 2.7 TDI	11/04→03/11	Diesel	Turbo Intercooled		
A6 2.7 TDI quattro	06/05→03/11				
A6 Allroad 2.7 TDI quattro	05/06→08/11				
A6 Avant 2.7 TDI	03/05→08/11				
A6 Avant 2.7 TDI quattro	06/05→08/11				
Q7 3.0 TDI	03/06→05/08	BUG	V6cyl. 2967cc	171kW (233PS)	TD18996
		Diesel	Turbo Intercooled		
Q7 3.0 TDI	03/06→05/10	BUN	V6cyl. 2967cc	155kW (211PS)	TD19881
		Diesel	Turbo Intercooled		

08-434300-00	STD	83.00	2.000		001 CK	KV1
08-434307-00	0.50mm		2.000		001 IFU	KV1
			3.000		231 CR	GOE13

A8 4.2 TDI quattro	01/05→06/05	BMC	V8cyl. 4134cc	235kW (320PS)	34
		Diesel	Turbo Intercooled	TD18192	
Q7 4.2 TDI	03/07→06/09	BTR	V8cyl. 4134cc	240kW (326PS)	TD19883
		Diesel	Turbo Intercooled		





A8 4.2 TDI quattro	07/05→07/10	BVN	V8cyl. 4134cc 240kW (326PS)	Diesel	Bi-Turbo Intercooled	TD18992
A4 2.7 TDI	11/07→	CAMA	V6cyl. 2698cc 140kW (190PS)	Diesel	Turbo Intercooled	TD20006
A4 Avant 2.7 TDI	04/08→					
A5 2.7 TDI	06/07→					
A4 2.7 TDI	11/07→	CAMB	V6cyl. 2698cc 120kW (163PS)	Diesel	Turbo Intercooled	TD20599
A4 Avant 2.7 TDI	06/08→					
A5 2.7 TDI	09/07→					
A6 2.7 TDI	10/08→03/11	CANA	V6cyl. 2698cc 140kW (190PS)	Diesel	Turbo Intercooled	TD21172
A6 Avant 2.7 TDI	10/08→08/11					
A6 2.7 TDI	11/04→03/11	CANB	V6cyl. 2698cc 120kW (163PS)	Diesel	Turbo Intercooled	TD22658
A6 Avant 2.7 TDI	03/05→08/11					
A6 2.7 TDI quattro	10/08→03/11	CANC	V6cyl. 2698cc 140kW (190PS)	Diesel	Turbo Intercooled	TD22659
A6 Allroad 2.7 TDI quattro,	10/08→08/11					
A6 Avant 2.7 TDI quattro						
A4 3.0 TDI quattro	11/07→	CAPA	V6cyl. 2967cc 176kW (239PS)	Diesel	Turbo Intercooled	TD20007
A4 Avant 3.0 TDI quattro	04/08→					
A5 3.0 TDI quattro	06/07→					
Q7 3.0 TDI	11/07→	CASA	V6cyl. 2967cc 176kW (239PS)	Diesel	Turbo Intercooled	TD20709
A4 3.0 TDI quattro	11/07→	CCLA	V6cyl. 2967cc 176kW (239PS)	Diesel	Turbo Intercooled	TD23861
A4 Avant 3.0 TDI quattro	04/08→					
Q7 3.0 TDI	11/07→	CCMA	V6cyl. 2967cc 176kW (239PS)	Diesel	Turbo Intercooled	TD21316
A4 3.0 TDI quattro	11/07→	CCWA	V6cyl. 2967cc 176kW (239PS)	Diesel	Turbo Intercooled	TD20600
A4 Allroad 3.0 TDI quattro	04/09→					
A4 Avant 3.0 TDI quattro	04/08→					
A5 3.0 TDI quattro	06/07→					
A5 Convertible 3.0 TDI quattro	03/09→					
A5 Sportback 3.0 TDI quattro	09/09→					
Q5 3.0 TDI quattro	11/08→					
A4 3.0 TDI quattro,	06/08→	CCWB	V6cyl. 2967cc 155kW (211PS)	Diesel	Turbo Intercooled	TD21029
A4 Avant 3.0 TDI quattro						
A5 3.0 TDI quattro	03/08→					
Q5 3.0 TDI quattro	11/08→					
A6 3.0 TDI quattro	10/08→03/11	CDYA	V6cyl. 2967cc 176kW (239PS)	Diesel	Turbo Intercooled	TD21177
A6 Allroad 3.0 TDI quattro,	10/08→08/11					
A6 Avant 3.0 TDI quattro						





A6 3.0 TDI quattro		10/08→03/11	CDYC			
A6 Allroad 3.0 TDI quattro,		10/08→08/11		V6cyl.		
A6 Avant 3.0 TDI quattro				2967cc	176kW (239PS)	
			Diesel	Turbo Intercooled		TD22973
A4 2.7 TDI		11/07→	CGKA			
A4 Avant 2.7 TDI		04/08→		V6cyl.		
A5 2.7 TDI		06/07→		2698cc	140kW (190PS)	
A5 Convertible 2.7 TDI		03/09→	Diesel	Turbo Intercooled		
A5 Sportback 2.7 TDI		09/09→				TD21065
A4 2.7 TDI		11/07→	CGKB			
A4 Avant 2.7 TDI		06/08→		V6cyl.		
A5 2.7 TDI		09/07→		2698cc	120kW (163PS)	
A5 Convertible 2.7 TDI		05/09→	Diesel	Turbo Intercooled		
A5 Sportback 2.7 TDI		09/09→				TD21064
08-433100-00	STD	83.00	1.750		001 GDC	ST
08-433105-00	0.25mm		2.000		005 IF MO P	KV1
08-433107-00	0.50mm		3.000		231 CR P	GOE13
A6 2.7 TDI quattro		06/05→03/11	CAND			35
A6 Allroad 2.7 TDI quattro		05/06→08/11		V6cyl.		
A6 Avant 2.7 TDI quattro		06/05→08/11		2698cc	120kW (163PS)	
			Diesel	Turbo Intercooled		TD23099
Q7 3.0 TDI		03/06→05/10	CASB			
				V6cyl.		
				2967cc	155kW (211PS)	
			Diesel	Turbo Intercooled		TD21315
Q7 3.0 TDI		06/09→05/12	CATA			
				V6cyl.		
				2967cc	165kW (224PS)	
			Diesel	Turbo Intercooled		TD22660
A6 3.0 TDI quattro		05/04→03/11	CDYB			
A6 Allroad 3.0 TDI quattro		05/06→08/11		V6cyl.		
A6 Avant 3.0 TDI quattro		03/05→08/11		2967cc	155kW (211PS)	
			Diesel	Turbo Intercooled		TD22955
08-433100-00	STD	83.00	1.750		001 GDC	ST
08-433105-00	0.25mm		2.000		005 IF MO P	KV1
08-433107-00	0.50mm		3.000		231 CR P	GOE13
08-434300-00	STD	83.00	2.000		001 CK	KV1
08-434307-00	0.50mm		2.000		001 IFU	KV1
			3.000		231 CR	GOE13



A3 3.2 V6 quattro		07/03→05/09	BDB	V6cyl. 3189cc	184kW (250PS)	36	TD17068
TT 3.2 VR6 quattro, TT Roadster 3.2 VR6 quattro		07/03→06/06	BHE	V6cyl. 3189cc	184kW (250PS)		TD17029
A3 3.2 V6 quattro A3 Sportback 3.2 V6 quattro		07/03→05/09 09/04→05/09	BMJ	V6cyl. 3189cc	184kW (250PS)		TD17407
TT 3.2 VR6 quattro, TT Roadster 3.2 VR6 quattro		07/03→06/06	BPF	V6cyl. 3189cc	184kW (250PS)		TD20705
A3 3.2 V6 quattro A3 Sportback 3.2 V6 quattro TT 3.2 V6 quattro TT Roadster 3.2 V6 quattro		07/03→05/09 09/04→05/09 08/06→06/10 03/07→06/10	BUB	V6cyl. 3189cc	184kW (250PS)		TD19200
08-137400-00	STD	84.00	1.200	 001 NT		ST	
			1.500	 026 P		F12/F14	
			2.000	 712 CR		ST	
A8 3.7, A8 3.7 quattro		11/98→09/02	AKC	V8cyl. 3697cc	191kW (260PS)	37	TD15343
A6 S6 quattro, A6 Avant S6 quattro		09/99→01/05	ANK	V8cyl. 4172cc	250kW (340PS)		TD15338
A8 4.2 quattro		11/98→09/02	AQF	V8cyl. 4172cc	228kW (310PS)		TD11357
A6 3.7, A6 3.7 quattro, A6 Avant 3.7, A6 Avant 3.7 quattro A8 3.7, A8 3.7 quattro		03/99→01/05 11/98→09/02	AQG	V8cyl. 3697cc	191kW (260PS)		TD11358
A6 S6 quattro, A6 Avant S6 quattro		09/99→01/05	AQJ	V8cyl. 4172cc	250kW (340PS)		TD15339
A6 4.2 quattro, A6 Avant 4.2 quattro		11/98→01/05	ARS	V8cyl. 4172cc	220kW (299PS)		TD12107
A6 4.2 quattro, A6 Avant 4.2 quattro		11/98→01/05	ASG	V8cyl. 4172cc	220kW (299PS)		TD15337
A8 4.2 quattro		11/98→09/02	AUW	V8cyl. 4172cc	228kW (310PS)		TD15342





A8 4.2 quattro	11/98→09/02	AUX	V8cyl. 4172cc	228kW (310PS)	TD15341
A8 S 8 quattro	06/99→09/02	AVP	V8cyl. 4172cc	265kW (360PS)	TD15340
A6 4.2 quattro, A6 Avant 4.2 quattro	11/98→01/05	AWN	V8cyl. 4172cc	220kW (299PS)	TD15336
Allroad 4.2 V8 quattro	07/02→08/05	BAS	V8cyl. 4172cc	220kW (299PS)	TD16433
A8 3.7 quattro	10/02→05/06	BFL	V8cyl. 3697cc	206kW (280PS)	TD17031
A8 4.2 quattro	10/02→07/10	BFM	V8cyl. 4172cc	246kW (335PS)	TD17032

08-139600-00	STD	84.50	1.200		001 NT	ST
			1.500		026 P	F12/F14
			3.000		231 NT	ST

A8 S8 quattro	04/12→	CGTA	V8cyl. 3993cc	381kW (518PS)	38 TD25685
----------------------	--------	-------------	-------------------------	----------------------	-----------------------------

A6 Avant RS6 quattro	01/13→	CRDB	V8cyl. 3993cc	412kW (560PS) Direct Injection	TD27986
-----------------------------	--------	-------------	-------------------------	--	----------------

08-437300-00	STD	84.50	1.200		001 NT DLC	ST
			1.500		026 P	F12/F14
			2.000		231 NT	ST

CARBOGLIDE®

100 2.0 100 Avant 2.0	06/76→08/78 08/77→07/80	WA	4cyl. 1984cc	85kW (116PS)	39 TD329
--	----------------------------	-----------	------------------------	---------------------	---------------------------

08-399700-10 08-399707-10	STD 0.50mm	86.50	2.000		001 IF CR P	KV1
			2.500		005 IF P	STD
			5.000		231 CR P	STD

MODEL INDEX

Modelverzeichnis • Index de modele • Índice de Modelo
 Indeks modelu • Модель автомобиля • دليل الموديل

CCM
x

9

01/68→12/72	3 Litre Saloon	C Series	Petrol	2912	6	8
08/69→12/72	18/85 1.8	18HL	Petrol	1798	4	7
01/70→12/72	18/85 1.8 S	18HH	Petrol	1798	4	7
01/66→12/69	1100	A Series	Petrol	1098	4	3
01/62→12/74	1100 Countryman	A Series	Petrol	1098	4	3
01/62→12/74	1100 MkII	A Series	Petrol	1098	4	3
01/67→12/73	1275 GT	A Series	Petrol	1275	4	5
01/71→12/74	1300	A Series	Petrol	1275	4	5
01/67→12/73	1300 GT	A Series	Petrol	1275	4	5
01/68→10/71	1300 GT	12H	Diesel	1275	4	5
10/71→10/73	1300 GT	12H	Diesel	1275	4	5
01/73→12/75	1800	B Series	Petrol	1798	4	7
01/64→12/68	1800 MkII	B Series	Petrol	1798	4	7
01/68→12/75	1800 MkII	B Series	Petrol	1798	4	7
01/69→12/75	1800 MkIII	B Series	Petrol	1798	4	7
01/73→12/75	1800HL	B Series	Petrol	1798	4	7
01/71→12/72	1800S MkII	B Series	Petrol	1798	4	7
01/57→12/59	A35	A Series	Petrol	848	4	1
01/57→12/59	A35	A Series	Petrol	948	4	1
01/62→12/67	A35 6cwt. Van	A Series	Petrol	1098	4	3
01/57→12/62	A40	A Series	Petrol	848	4	1
01/57→12/62	A40	A Series	Petrol	948	4	1
01/62→12/67	A40 MkII 1100	A Series	Petrol	1098	4	3
08/75→03/82	Allegro Estate 1.3	A Series (12 L)	Petrol	1275	4	4
01/80→10/83	Allegro Hatchback 1.0	A/A+ Series (99H)	Petrol	998	4	2
05/73→10/81	Allegro Hatchback 1.1	A series (10H)	Petrol	1098	4	3
05/73→10/83	Allegro Hatchback 1.3	A Series (12 H)	Petrol	1275	4	4
01/75→10/79	Allegro Hatchback 1.3	A Series (12 L)	Petrol	1275	4	4
12/79→12/84	Allegro Saloon 1.3	A Series (12 H)	Petrol	1275	4	4
03/66→10/71	Austin-Healey Sprite MK.IV	12CC	Petrol	1275	4	5
01/57→12/61	Healey Sprite MkI	A Series	Petrol	848	4	1
01/57→12/61	Healey Sprite MkI	A Series	Petrol	948	4	1
01/61→12/66	Healey Sprite MkII	A Series	Petrol	848	4	1
01/61→12/66	Healey Sprite MkII	A Series	Petrol	948	4	1
01/61→12/66	Healey Sprite MkIII	A Series	Petrol	848	4	1
01/61→12/66	Healey Sprite MkIII	A Series	Petrol	948	4	1
10/80→04/90	HLE	A Series (12 H)	Petrol	1275	4	4
01/82→12/84	Ital 440 Van	A+ Series	Petrol	1275	4	4
03/83→09/92	Maestro 1.3	A Series (12 H)	Petrol	1275	4	4
03/83→08/85	Maestro 1.3	A+ Series (12 H999)	Petrol	1275	4	5
03/83→08/85	Maestro 1.3	A+ Series (12 HC)	Petrol	1275	4	5
01/86→09/92	Maestro 1.3	A+ Series (12 HE)	Petrol	1275	4	4
03/83→08/90	Maestro 1.3 LS	A Series (12 H)	Petrol	1275	4	4
01/84→12/92	Maestro 500 City	A+ Series	Petrol	1275	4	4
01/84→12/92	Maestro 500 L Van	A+ Series	Petrol	1275	4	4
01/64→12/91	Marina	A Series (1275cc Overbored To 1380cc)	Petrol	1380	4	6
01/71→12/78	Marina 1.8GT	B Series	Petrol	1798	4	7
01/71→12/78	Marina 1.8HL	B Series	Petrol	1798	4	7
01/71→12/78	Marina 1.8TC	B Series	Petrol	1798	4	7
01/81→12/82	Marina 440 L Van	A+ Series	Petrol	1275	4	4
01/78→12/80	Marina 575 L Van	A+ Series	Petrol	1275	4	4
01/72→12/80	Marina 1300	A Series	Petrol	1275	4	5
11/75→10/80	Marina II Pickup 1.3	12 H	Petrol	1275	4	4
10/80→04/90	Metro 1.0	A/A+ Series (99H)	Petrol	998	4	2
10/80→04/90	Metro 1.0 Surf HLE	A + series (99H)	Petrol	998	4	2
11/85→04/90	Metro 1.3	A+ Series (12 H)	Petrol	1275	4	4
10/80→12/85	Metro 1.3	A+ Series (12 H996)	Petrol	1275	4	5
10/80→04/90	Metro 1.3	A+ Series (12 HA)	Petrol	1275	4	5
10/80→12/83	Metro 1.3	A+ Series (12 HL)	Petrol	1275	4	4
10/80→04/90	Metro 1.3 L	A Series (12 H)	Petrol	1275	4	4

Modelverzeichnis • Index de modele • Índice de Modelo
Indeks modelu • Модель автомобиля • دليل الموديل

MODEL INDEX



CCM

x



9

01/64→12/99	Metro 1275	A Series (1275cc Overbored To 1380cc)	Petrol	1380	4	6
01/82→12/88	Metro Vanden Plas 1.3	A+ Series	Petrol	1275	4	5
01/83→	Metropolitan Taxi	19 J	Diesel	2495	4	9
04/74→09/80	Mini 1.3	A Series (12 H)	Petrol	1275	4	4
09/69→09/80	Mini 1.3	A Series (12 H)	Petrol	1275	4	5
01/85→	Mini 1.3	A+ Series	Petrol	1275	4	5
10/80→04/90	Mini 1.3 L, HLE, S	A Series (12 H)	Petrol	1275	4	4
01/60→12/69	Mini 5cwt Van	A Series	Petrol	848	4	1
01/60→12/69	Mini 5cwt Van	A Series	Petrol	948	4	1
01/78→12/80	Mini 95 Van	A Series	Petrol	848	4	1
01/78→12/80	Mini 95 Van	A Series	Petrol	948	4	1
01/63→12/80	Mini 850	A Series	Petrol	848	4	1
01/67→08/79	Mini 850	A Series	Petrol	848	4	1
01/63→12/80	Mini 850	A Series	Petrol	948	4	1
01/67→08/79	Mini 850	A Series	Petrol	948	4	1
10/67→09/84	Mini 1000	A/A+ Series (99H)	Petrol	998	4	2
08/82→06/93	Mini 1000 Mayfair	A+ Series (99H)	Petrol	998	4	2
09/88→06/93	Mini 1000 Mayfair	A+ Series (99H)	Petrol	998	4	2
01/76→08/81	Mini 1100 Special	A series (10H)	Petrol	1098	4	3
	Mini 1275	A Series (1275cc Overbored To 1380cc)	Petrol	1380	4	6
01/78→12/80	Mini City	A Series	Petrol	848	4	1
01/78→12/80	Mini City	A Series	Petrol	948	4	1
01/90→	Mini Cooper	A+ Series	Petrol	1275	4	5
01/64→12/71	Mini Cooper S	A Series	Petrol	1275	4	5
01/63→12/69	Minor 1000	A Series	Petrol	1098	4	3
01/57→12/62	Minor 1000 Series III	A Series	Petrol	848	4	1
01/57→12/62	Minor 1000 Series III	A Series	Petrol	948	4	1
01/63→12/69	Minor 1100	A Series	Petrol	1098	4	3
04/84→08/88	Montego 1.3	A+ Series (12 HL)	Petrol	1275	4	4
10/84→10/88	Montego Estate 1.3	A+ Series (12 HL)	Petrol	1275	4	4
01/75→12/78	Princess 1.8 HL	B Series	Petrol	1798	4	7
04/76→09/78	Princess 1800 HL	B Series (18 H)	Petrol	1798	4	7
01/60→12/62	Seven	A Series	Petrol	848	4	1
01/60→12/62	Seven	A Series	Petrol	948	4	1

ENGINE INDEX

Motorverzeichnis • Index de moteur • Índice de Motor
Indeks silnika • Модель двигателя • دليل المحرك



CCM

x



9

12 H	Petrol	1275	4	70.62	4
12CC	Petrol	1275	4	70.62	5
12H	Diesel	1275	4	70.62	5
18HH	Petrol	1798	4	80.25	7
18HL	Petrol	1798	4	80.25	7
19 J	Diesel	2495	4	90.47	9
A + series (99H)	Petrol	998	4	64.56	2
A Series	Petrol	1098	4	64.56	3
A Series	Petrol	1275	4	70.62	5
A Series	Petrol	848	4	62.92	1
A Series	Petrol	948	4	62.92	1
A series (10H)	Petrol	1098	4	64.56	3
A Series (12 H)	Petrol	1275	4	70.62	4
A Series (12 H)	Petrol	1275	4	70.62	5
A Series (12 L)	Petrol	1275	4	70.62	4
A Series (1275cc Overbored To 1380cc)	Petrol	1380	4	73.50	6
A/A+ Series (99H)	Petrol	998	4	64.56	2
A+ Series	Petrol	1275	4	70.62	4
A+ Series	Petrol	1275	4	70.62	5
A+ Series (12 H)	Petrol	1275	4	70.62	4
A+ Series (12 H996)	Petrol	1275	4	70.62	5
A+ Series (12 H999)	Petrol	1275	4	70.62	5
A+ Series (12 HA)	Petrol	1275	4	70.62	5
A+ Series (12 HC)	Petrol	1275	4	70.62	5
A+ Series (12 HE)	Petrol	1275	4	70.62	4
A+ Series (12 HL)	Petrol	1275	4	70.62	4
A+ Series (99H)	Petrol	998	4	64.56	2
B Series	Petrol	1798	4	80.25	7
B Series (18 H)	Petrol	1798	4	80.25	7
C Series	Petrol	2912	6	83.32	8



Mini 850		01/67→08/79	A Series	4cyl. 848cc	25-26kW (34-35PS)	1	TD13428
A35		01/57→12/59	A Series	4cyl.			
A40		01/57→12/62		948cc			
Healey Sprite MkI		01/57→12/61					
Healey Sprite MkII, Healey Sprite MkIII		01/61→12/66					FM2938
Mini 5cwt Van		01/60→12/69	A Series	4cyl.			
Mini 850		01/63→12/80		848cc			
Mini 95 Van, Mini City		01/78→12/80					
Seven		01/60→12/62					FM72
Minor 1000 Series III		01/57→12/62	A Series	4cyl. 948cc			FM73
08-529700-00	STD	62.92	1.780		001 P		GOE12
<i>[R8576]</i>			1.780		005 P		GOE12
			1.780		005 P		GOE12
			3.175		030 P		GOE12
Metro 1.0 Surf HLE		10/80→04/90	A + series (99H)	4cyl. 998cc	35kW (47PS)	2	TD383
Allegro Hatchback 1.0		01/80→10/83	A/A+ Series (99H)	4cyl.			
Metro 1.0		10/80→04/90		998cc			
Mini 1000		10/67→09/84			29-33kW (39-45PS)		TD4215
Mini 1000 Mayfair		09/88→06/93	A+ Series (99H)	4cyl. 998cc	31kW (42PS)		TD5471
Mini 1000 Mayfair		08/82→06/93	A+ Series (99H)	4cyl. 998cc	31kW (42PS)		TD5472
Mini 1000 Mayfair		08/82→06/93	A+ Series (99H)	4cyl. 998cc	31kW (42PS)		TD5473





Mini 1000 Mayfair		08/82→06/93	A+ Series (99H)		4cyl. 998cc	31kW (42PS)	TD5474	
08-522400-00	STD	64.56	1.588		001 P		F12/F14	
08-522407-00	.020				005 P		STD	
08-522411-00	.040		1.588		005 P		STD	
08-522414-00	.060		1.588		231 CR P		STD	
01/1980→12/1985			4.000		001 CK P		KV1	
[R33636]			1.500		005 P		GOE12	
08-524300-10	STD	64.56	1.500		231 P		GOE12	
08-524307-10	.020							
08-524311-10	.040		1.500					
08-524314-10	.060		3.000					
01/1986→06/1992								
1100 Countryman, 1100 MkII		01/62→12/74	A Series		4cyl.		3	
Minor 1000, Minor 1100		01/63→12/69			1098cc		FM2941	
1100		01/66→12/69	A Series		4cyl.			
A35 6cwt. Van, A40 MkII 1100		01/62→12/67			1098cc		FM78	
Minor 1100		01/63→12/69						
Allegro Hatchback 1.1		05/73→10/81	A series (10H)		4cyl.			
Mini 1100 Special		01/76→08/81			1098cc	33kW (45PS)	TD384	
08-522300-00	STD	64.56	1.600		001 NT		KV1	
08-522307-00	.020			1.588		005 P		STD
08-522309-00	.030		1.588		005 P		STD	
08-522311-00	.040		1.588		232 P		STD	
08-522314-00	.060		3.175					
[R32026]								
Marina II Pickup 1.3		11/75→10/80	12 H		4cyl.		4	
					1275cc	41kW (55PS)	TD22166	
Allegro Hatchback 1.3		05/73→10/83	A Series (12 H)		4cyl.			
Allegro Saloon 1.3		12/79→12/84			1275cc	40-49kW (54-67PS)		
Maestro 1.3		03/83→09/92						
Maestro 1.3 LS		03/83→08/90						
Metro 1.3 L, HLE, S		10/80→04/90						
Mini 1.3		04/74→09/80					TD381	
Allegro Estate 1.3		08/75→03/82	A Series (12 L)		4cyl.			
Allegro Hatchback 1.3		01/75→10/79			1275cc	43kW (58PS)	TD22494	
Ital 440 Van		01/82→12/84	A+ Series		4cyl.			
Maestro 500 City, Maestro 500 L Van		01/84→12/92			1275cc			
Marina 440 L Van		01/81→12/82						
Marina 575 L Van		01/78→12/80					FM3364	





Metro 1.3			11/85→04/90		A+ Series (12 H) 4cyl. 1275cc	44kW (60PS)	TD5470
Maestro 1.3			01/86→09/92		A+ Series (12 HE) 4cyl. 1275cc	50kW (68PS)	TD22435
Metro 1.3 Montego 1.3 Montego Estate 1.3			10/80→12/83 04/84→08/88 10/84→10/88		A+ Series (12 HL) 4cyl. 1275cc	46kW (63PS)	TD16446
08-106700-00 [R21576V1]	STD	70.62	1.600 1.600 1.600 3.950		001 CR P 001 IF P 023 P 231 CR P		STD STD STD STD
08-521700-00 08-521707-00 08-521711-00 08-521714-00 [R35960]	STD .020 .040 .060	70.62	1.488 1.488 4.000		001 P 026 P 231 P		IKA STD STD
Austin-Healey Sprite MK.IV			03/66→10/71		12CC 4cyl. 1275cc	48kW (65PS)	5 TD22427
1300 GT 1300 GT			01/68→10/71 10/71→10/73		12H 4cyl. 1275cc	48kW (65PS)	TD21773
1275 GT 1300 1300 GT Marina 1300 Mini Cooper S			01/67→12/73 01/71→12/74 01/67→12/73 01/72→12/80 01/64→12/71		A Series 4cyl. 1275cc Twin Carburettor		FM85
Mini 1.3			09/69→09/80		A Series (12 H) 4cyl. 1275cc	53kW (72PS) Twin Carburettor	TD22493
Metro Vanden Plas 1.3 Mini 1.3 Mini Cooper			01/82→12/88 01/85→ 01/90→		A+ Series 4cyl. 1275cc	46kW (63PS)	FM2934
Metro 1.3			10/80→12/85		A+ Series (12 H996) 4cyl. 1275cc	52kW (71PS)	TD13429
Maestro 1.3			03/83→08/85		A+ Series (12 H999) 4cyl. 1275cc	46kW (63PS)	TD5458















Metro 1.3		10/80→04/90	A+ Series (12 HA)					
			4cyl.					
			1275cc	51kW (69PS)			TD5468	
Maestro 1.3		03/83→08/85	A+ Series (12 HC)					
			4cyl.					
			1275cc	46kW (63PS)			TD5459	
08-524100-00	STD	70.62	1.500		001 NT		KV1	
08-524107-00	.020				026 P		GOE12	
08-524111-00	.040		1.500			231 P		GOE12
08-524114-00	.060		3.000					
<i>[R41570]</i>								
Marina		01/64→12/91	A Series (1275cc Overbored To 1380cc)					
Metro 1275, Mini 1275			4cyl.				6	
			1380cc				FM1180	
08-526600-00	STD	73.50	1.500		001 CR P		IKA	
<i>[R39390]</i>				1.500		026 P		IKA
				4.000		232 CR P		GOE12
18/85 1.8 S		01/70→12/72	18HH				7	
			4cyl.					
			1798cc	71kW (96PS)			TD21772	
18/85 1.8		08/69→12/72	18HL					
			4cyl.					
			1798cc	64kW (87PS)			TD21771	
1800 MkII		01/64→12/68	B Series					
			4cyl.					
			1798cc				FM2950	
1800		01/73→12/75	B Series					
1800 MkII		01/68→12/75	4cyl.					
1800 MkIII		01/69→12/75	1798cc					
1800HL		01/73→12/75						
Marina 1.8GT, Marina 1.8HL, Marina 1.8TC		01/71→12/78						
Princess 1.8 HL		01/75→12/78					FM2951	
1800S MkII		01/71→12/72	B Series					
			4cyl.					
			1798cc				FM2953	
Princess 1800 HL		04/76→09/78	B Series (18 H)					
			4cyl.					
			1798cc	60kW (81PS)			TD5478	
08-525900-00	STD	80.25	1.590		001 P		GOE12	
08-525907-00	.020					005 P		GOE12
08-525909-00	.030		1.590			231 P		GOE12
08-525911-00	.040		4.000					
08-525914-00	.060							
<i>[R25566]</i>								



3 Litre Saloon	01/68→12/72	C Series		8
			6cyl. 2912cc	
				FM1186

08-530100-00	STD	83.32	1.984		005 P	STD
08-530107-00	.020				005 P	STD
08-530109-00	.030		1.984		005 P	STD
			1.984		005 P	STD
			4.740		231	STD
			4.762		031 P	STD

Metropolitan Taxi	01/83→	19 J		9
			4cyl. 2495cc	
			Diesel Turbo Indirect Injection	
				FM3829

08-524200-00	STD	90.47	1.990		001 CR P	KV1
08-524207-00	.020				005 IFU P	IKA
08-524211-00	.040		1.950		005 IFU P	IKA
<i>[R43170]</i>			3.000		231 CR P	GOE12



B 1000 Box 1.3, B 1000 Bus 1.3

01/76→12/91

VW 1.3 (Two-stroke)



1

4cyl.

1272cc



43kW (58PS)

TD409

08-406200-00	STD	75.00	1.750		001 IF CR P	IKA
08-406207-00	0.50mm				026 P	STD
08-406211-00	1.00mm		2.000		231 CR P	STD
[R46160]			3.000			



1

BA 10M 816		10cyl.	25340cc		Diesel		FM6374
BA 12M 816		12cyl.	30408cc		Diesel		FM6375
BA 16M 816		16cyl.	40544cc		Diesel Turbo		FM6158
BA 6M 816		6cyl.	15204cc		Diesel		FM6372
BA 8M 816		8cyl.	20274cc		Diesel		FM6373
08-251300-10	STD	142.00	4.000		008 CR P		KV1
			3.000		005 IF P		STD
			6.000		231 CR P		STD

ENGINE INDEX

Motorverzeichnis • Index de moteur • Índice de Motor
Indeks silnika • Модель двигателя • دليل المحرك



CCM

x



9

1.3 N	Petrol	1297	4	75.00	2
4.108	Diesel	1760	4	79.38	4
13 NB	Petrol	1297	4	75.00	2
13 S	Petrol	1297	4	75.00	2
16 D	Diesel	1598	4	80.00	5
16 DA	Diesel	1598	4	80.00	5
16 SV	Petrol	1598	4	79.00	3
17 D	Diesel	1699	4	82.50	7
20 N	Petrol	1979	4	95.00	10
23D	Diesel	2260	4	92.00	9
220	Diesel	3614	4	103.19	11
330	Diesel	5420	6	103.19	11
500 PHASE I	Diesel	8200	6	115.88	12
C190	Diesel	1952	4	86.00	8
F10A	Petrol	970	4	65.50	1
G161S, G161Z	Petrol	1584	4	82.00	6



Rascal Box 1.0, Rascal Bus 1.0	07/86→06/90	F10A							1
Rascal Pickup 1.0, Rascal Platform/Chassis 1.0	06/86→06/90		4cyl.						
			970cc			34kW (46PS)			
									TD9933

08-960200-00	STD	65.50	1.500		001 CR P		IKA
08-960207-00	0.50mm		1.500		026 P		STD
[R41260]			2.800		236 P		STD

Astra 1300, Astra 1300 L Van	01/82→12/88	1.3 N							2
Astramax Van	01/85→12/88		4cyl.						
			1297cc						FM2691

Astra Van Estate 1.3	09/84→09/89	13 NB							
Astramax Estate 1.3	09/85→06/90		4cyl.						
			1297cc			44kW (60PS)			TD26852

Astra Van Estate 1.3	09/84→09/89	13 S							
			4cyl.						
			1297cc			42-55kW (57-75PS)			TD410

08-306300-00	STD	75.00	1.500		001 IF CR P		IKA
08-306307-00	0.50mm		1.500		005 IF P		STD
08-306311-00	1.00mm		4.000		231 CR P		STD
[R41270]							

Astra Van Estate 1.6	09/84→08/91	16 SV							3
			4cyl.						
			1598cc			60kW (81PS)			TD413

08-306900-00	STD	79.00	1.200		001 CR		ST
08-306907-00	0.50mm		1.500		026 P		STD
[R43150]			3.000		712 CR		ST



CF 220 Van, CF 250 Van	01/69→12/76	4.108			
				4cyl. 1760cc	4
				Diesel	FM1346

08-313400-00	STD	79.38	1.990		001 IF CR P	STD
<i>[R34610]</i>			1.600		001 IF P	STD
			1.600		023 P	STD
			4.747		231 P	STD
			4.747		031 P	STD
08-315200-00	STD	79.38	1.990		001 IF CR P	KV1
<i>[R34590]</i>			1.600		005 IF P	STD
			1.600		005 IF P	STD
			3.160		026 P	STD
			4.747		231 P	STD

Astra Van Estate 1.6 D	07/82→08/88	16 D			
Astramax Estate 1.6 D	09/85→08/88			4cyl. 1598cc	5
				39-40kW (53-54PS)	
				Diesel	TD412

Astra Van Estate 1.6 D	09/87→08/89	16 DA			
Astramax Estate 1.6 D	09/85→08/88			4cyl. 1598cc	6
				40-42kW (54-57PS)	
				Diesel	TD26851

08-305900-10	STD	80.00	2.000		001 CR P	KV1
08-305907-10	0.50mm				005 IF P	STD
08-305911-10	1.00mm		2.000		005 IF P	STD
<i>[R35900]</i>			3.000		231 CR P	STD

KB Series Pick up	01/84→12/88	G161S, G161Z			
				4cyl. 1584cc	6
					FM877

08-247000-00	STD	82.00	2.000		001 CR P	STD
			2.000		026 P	STD
			4.000		712 CR	ST

Astra Van Estate 1.7 D	09/88→08/91	17 D			
Astramax Estate 1.7 D	09/88→06/90			4cyl. 1699cc	7
				42kW (57PS)	
				Diesel	TD26850

08-306700-00	STD	82.50	2.000		001 CR P	KV1
08-306707-00	0.50mm				005 P	STD
08-306711-00	1.00mm		2.000		005 P	STD
<i>[R48750]</i>			3.000		231 CR P	STD



KBD26 Pick-up KBD41 Pick-up		06/81→12/87 06/82→12/87		C190		4cyl. 1952cc 34kW (46PS)		8	
				Diesel				FM883	
08-247200-00 ¹	STD	86.00	2.000		001 CR P				KV1
08-247207-00	0.50mm				005 P				STD
08-247211-00	1.00mm					005 P			STD
			2.000		005 P				STD
			5.000		231 CR P				STD
08-247200-10	STD	86.00	2.000		001				STD
[R40320]			2.000		023				STD
			2.000		023				STD
			5.000		231				STD
08-247300-00 ¹	STD	86.00	2.500		001 CR P				KV1
01/1983→			2.000		005 P				STD
[R41530]			5.000		231 CR P				STD

¹ For Cast Iron Bores only ¹ Nur für Gußeisenbohrungen ¹ Pour intérieur cylindre seulement ¹ Para diámetro internos de hierro fundido solamente

CF 2.3 D		01/78→		23D		4cyl. 2260cc 46-48kW (63-65PS)		9	
				Diesel				TD418	
08-305400-10	STD	92.00	2.000		001 CR P				KV1
08-305407-10	0.50mm				005 IF P				STD
08-305411-10	1.00mm					231 CR P			STD
			4.000		231 CR P				STD

Blitz 2.0		02/85→10/87		20 N		4cyl. 1979cc 56-58kW (76-79PS)		10	
								TD13433	
08-305000-00	STD	95.00	2.000		001 IF MO P				IKA
08-305007-00	0.50mm			2.000		026 P			STD
[R41350V1]				4.000		712 CR			ST



D, K, T, TJ, TK, TKV Series Trucks	220	4cyl.	11
		3614cc	48-52kW (65-71PS)
	Diesel		TD6483

D, K, T, TJ, TK, TKV Series Trucks	330	6cyl.	12
		5420cc	72-99kW (98-135PS)
	Diesel	Turbo	TD6485

08-126300-10	STD	103.19	2.385		001 P	F12/F14
08-126305-10	.010		2.385		001 IW P	STD
08-126307-10	.020		2.385		001 IW P	STD
08-126309-10	.030		2.385		001 IW P	STD
08-126311-10	.040		4.747		032 P	STD
08-126314-10	.060		4.747		032 P	STD
<i>[R40150]</i>						

TM Series	01/75→12/80	500 PHASE I	12
		6cyl.	
		8200cc	
		Diesel	FM142
		Direct Injection	

08-526500-00	STD	115.88	3.180		009 P	IKA
<i>[R38780]</i>			2.390		001 IW P	IKA
			4.770		231 CR P	GOE12
			3.960		030 P	GOE12

Not for chromed cylinders





Nicht für verchromte Zylinder

Non appropriés pour cylindres chromés

No se usen para cilindros cromados



1

4.8D		4cyl.	4800cc	Diesel		FM6376
08-130200-00	STD	110.00	3.000		001 CR P	STD
			3.000		001 IW P	STD
			3.000		001 IW P	STD
			6.000		231 CR P	STD
			6.000		030 P	STD

MODEL INDEX

Modelverzeichnis • Index de modele • Índice de Modelo
Indeks modelu • Модель автомобиля • دليل الموديل



CCM

x



9

11/08→09/12	1 (E81) 116 d	N47 D2 A	Diesel	1995	4	27
11/08→09/12	1 (E81) 116 d	N47 D20C	Diesel	1995	4	27
03/07→09/12	1 (E81) 116 i	N45 B16A	Petrol	1596	4	26
09/06→09/12	1 (E81) 118 d	N47 D2 A	Diesel	1995	4	27
09/06→09/12	1 (E81) 118 d	N47 D20C	Diesel	1995	4	27
09/06→09/12	1 (E81) 118 i	N46 B20B	Petrol	1995	4	26
09/06→09/12	1 (E81) 120 d	N47 D2 A	Diesel	1995	4	27
09/06→09/12	1 (E81) 120 d	N47 D20C	Diesel	1995	4	27
09/06→09/12	1 (E81) 120 i	N46 B20B	Petrol	1995	4	26
09/06→09/12	1 (E81) 120 i	N46 B20C	Petrol	1995	4	26
03/07→09/12	1 (E81) 123 d	N47 D20B	Diesel	1995	4	27
09/06→09/12	1 (E81) 130 i	N52 B30A	Petrol	2996	6	30
09/06→09/12	1 (E81) 130 i	N52 B30B	Petrol	2996	6	30
09/06→09/12	1 (E81) 130 i	N52 B30BF	Petrol	2996	6	30
12/08→09/12	1 (E87) 116 d	N47 D2 A	Diesel	1995	4	27
01/11→12/11	1 (E87) 116 d	N47 D20C	Diesel	1995	4	27
11/03→09/12	1 (E87) 116 i	N45 B16A	Petrol	1596	4	26
11/03→09/12	1 (E87) 118 d	N47 D2 A	Diesel	1995	4	27
11/03→09/12	1 (E87) 118 d	N47 D20C	Diesel	1995	4	27
07/04→09/12	1 (E87) 118 i	N46 B20B	Petrol	1995	4	26
11/03→09/12	1 (E87) 120 d	N47 D2 A	Diesel	1995	4	27
11/03→09/12	1 (E87) 120 d	N47 D20C	Diesel	1995	4	27
11/03→09/12	1 (E87) 120 i	N46 B20A	Petrol	1995	4	26
11/03→09/12	1 (E87) 120 i	N46 B20B	Petrol	1995	4	26
11/03→09/12	1 (E87) 120 i	N46 B20BD	Petrol	1995	4	26
11/03→09/12	1 (E87) 120 i	N46 B20C	Petrol	1995	4	26
11/03→09/12	1 (E87) 120 i	N46 B20CC	Petrol	1995	4	26
11/03→09/12	1 (E87) 120 i	N46 B20CD	Petrol	1995	4	26
03/07→09/12	1 (E87) 123 d	N47 D20B	Diesel	1995	4	27
03/05→09/12	1 (E87) 130 i	N52 B30A	Petrol	2996	6	30
03/05→09/12	1 (E87) 130 i	N52 B30AF	Petrol	2996	6	30
03/05→09/12	1 (E87) 130 i	N52 B30B	Petrol	2996	6	30
03/05→09/12	1 (E87) 130 i	N52 B30BF	Petrol	2996	6	30
12/10→	1 (F20) 116 d	N47 D20C	Diesel	1995	4	27
12/10→	1 (F20) 118 d	N47 D20C	Diesel	1995	4	27
12/10→	1 (F20) 120 d	N47 D20C	Diesel	1995	4	27
02/12→	1 (F20) 120 d xDrive	N47 D20C	Diesel	1995	4	27
08/11→	1 (F20) 125 i	N20 B20A	Petrol	1997	4	24
01/12→	1 (F21) 116 d	N47 D20C	Diesel	1995	4	27
12/11→	1 (F21) 118 d	N47 D20C	Diesel	1995	4	27
05/13→	1 (F21) 118 d xDrive	N47 D20C	Diesel	1995	4	27
07/12→	1 (F21) 120 d	N47 D20C	Diesel	1995	4	27
02/12→	1 (F21) 120 d xDrive	N47 D20C	Diesel	1995	4	27
12/11→	1 (F21) 125 i	N20 B20A	Petrol	1997	4	24
09/08→	1 Convertible (E88) 118 d	N47 D2 A	Diesel	1995	4	27
09/08→	1 Convertible (E88) 118 d	N47 D20C	Diesel	1995	4	27
09/08→	1 Convertible (E88) 118 i	N46 B20B	Petrol	1995	4	26
03/08→	1 Convertible (E88) 120 d	N47 D2 A	Diesel	1995	4	27
03/08→	1 Convertible (E88) 120 d	N47 D20C	Diesel	1995	4	27
03/08→	1 Convertible (E88) 120 i	N46 B20B	Petrol	1995	4	26
03/08→	1 Convertible (E88) 120 i	N46 B20C	Petrol	1995	4	26
09/08→	1 Convertible (E88) 123 d	N47 D20B	Diesel	1995	4	27
03/08→	1 Convertible (E88) 125 i	N52 B30A	Petrol	2996	6	30
09/09→	1 Coupe (E82) 118 d	N47 D20C	Diesel	1995	4	27
10/07→	1 Coupe (E82) 120 d	N47 D2 A	Diesel	1995	4	27
10/07→	1 Coupe (E82) 120 d	N47 D20C	Diesel	1995	4	27
09/09→	1 Coupe (E82) 120 i	N46 B20B	Petrol	1995	4	26



CCM

x



10/07→	1 Coupe (E82) 123 d	N47 D20B	Diesel	1995	4	27
10/07→	1 Coupe (E82) 125 i	N53 B30A	Petrol	2996	6	30
01/75→07/77	02 (E10) 1502	M10 B16	Petrol	1574	4	8
09/67→11/69	02 (E10) 1600 Ti	M10 B16	Petrol	1574	4	8
12/67→12/71	02 (E10) 1600/2	M10 B16	Petrol	1574	4	8
04/71→07/75	02 (E10) 1602	M10 B16	Petrol	1574	4	8
05/71→07/75	02 (E10) 1802	M10 B18	Petrol	1766	4	32
12/67→10/71	02 Convertible (E10) 1600-2	M10 B16	Petrol	1574	4	8
05/71→04/73	02 Touring (E6) 1600	M10 B16	Petrol	1574	4	8
05/71→07/75	02 Touring (E6) 1802	M10 B18	Petrol	1766	4	32
03/81→03/84	3 (E21) 315	M10 B16	Petrol	1574	4	8
08/75→08/80	3 (E21) 316	M10 B16	Petrol	1574	4	8
09/80→08/82	3 (E21) 316	M10 B18	Petrol	1766	4	32
08/75→08/80	3 (E21) 318	M10 B18	Petrol	1766	4	32
11/79→08/82	3 (E21) 318 i	M10 B18	Petrol	1766	4	32
09/77→08/82	3 (E21) 320/6	M20 B20	Petrol	1991	6	1
01/78→08/82	3 (E21) 323 i	M20 B23L	Petrol	2316	6	1
09/82→12/91	3 (E30) 315	M10 B16	Petrol	1574	4	8
09/82→12/87	3 (E30) 316	M10 B18	Petrol	1766	4	32
09/83→12/90	3 (E30) 316 (Ecotronic)	M10 B18	Petrol	1766	4	32
08/87→08/88	3 (E30) 316 i	M10 B18	Petrol	1766	4	32
09/87→06/91	3 (E30) 316 i	M40 B16	Petrol	1596	4	9
09/82→08/88	3 (E30) 318 i	M10 B18	Petrol	1766	4	32
09/87→06/91	3 (E30) 318 i	M40 B18	Petrol	1796	4	9
09/89→08/91	3 (E30) 318 is	M42 B18	Petrol	1796	4	11
09/82→06/91	3 (E30) 320 i	M20 B20	Petrol	1991	6	1
05/88→12/90	3 (E30) 320 is	S14 B20	Petrol	1990	4	39
09/82→08/86	3 (E30) 323 i	M20 B23L	Petrol	2316	6	1
09/85→08/91	3 (E30) 324 d	M21 D24W	Diesel	2443	6	2
09/87→08/91	3 (E30) 324 td	M21 D24WA	Diesel	2443	6	2
10/83→12/88	3 (E30) 325 e 2.7	M20 B27	Petrol	2693	6	10
09/83→06/91	3 (E30) 325 i	M20 B25	Petrol	2494	6	9
03/86→08/91	3 (E30) 325 i X	M20 B25	Petrol	2494	6	9
02/87→05/89	3 (E30) M3 2.3	S14 B23	Petrol	2303	4	39
07/86→06/91	3 (E30) M3 2.3	S14 B23	Petrol	2303	4	39
09/90→09/93	3 (E36) 316 i	M40 B16	Petrol	1596	4	9
09/90→02/98	3 (E36) 316 i	M43 B16	Petrol	1596	4	11
12/90→10/93	3 (E36) 318 i	M40 B18	Petrol	1796	4	9
10/93→02/98	3 (E36) 318 i	M43 B18	Petrol	1796	4	11
03/93→02/98	3 (E36) 318 is	M42 B18	Petrol	1796	4	11
09/95→02/98	3 (E36) 318 is	M44 B19	Petrol	1895	4	29
01/95→02/98	3 (E36) 318 tds	M41 D18	Diesel	1665	4	3
09/90→02/98	3 (E36) 320 i	M50 B (20 6 S1)	Petrol	1991	6	4
09/90→02/98	3 (E36) 320 i	M50 B20TU	Petrol	1991	6	4
03/95→02/98	3 (E36) 323 i 2.5	M52 B25 (Vanos)	Petrol	2494	6	15
09/90→09/95	3 (E36) 325 i	M50 B25	Petrol	2494	6	15
09/90→09/95	3 (E36) 325 i	M50 B25 (Vanos)	Petrol	2494	6	16
09/91→02/98	3 (E36) 325 td	M51 D25	Diesel	2497	6	3
09/91→02/98	3 (E36) 325 td	M51 D25	Diesel	2498	6	3
05/93→02/98	3 (E36) 325 tds	M51 D25	Diesel	2497	6	3
05/93→02/98	3 (E36) 325 tds	M51 D25	Diesel	2498	6	3
01/95→02/98	3 (E36) 328 i	M52 B28	Petrol	2793	6	15
04/00→02/05	3 (E46) 316 i	M43 B16	Petrol	1596	4	11
04/00→02/05	3 (E46) 316 i	M43 B16 (16 4 E3)	Petrol	1596	4	11
02/02→02/05	3 (E46) 316 i	N42 B18	Petrol	1796	4	25
06/02→02/05	3 (E46) 316 i	N45 B16	Petrol	1596	4	26
06/02→02/05	3 (E46) 316 i	N45 B16A	Petrol	1596	4	26

MODEL INDEX

Modelverzeichnis • Index de modele • Índice de Modelo
Indeks modelu • Модель автомобиля • دليل الموديل



CCM

x



9

09/01→03/03	3 (E46) 318 d	M47 204D1	Diesel	1951	4	12
09/01→03/03	3 (E46) 318 d	M47 D20	Diesel	1951	4	12
03/03→02/05	3 (E46) 318 d	M47 N204D4 Euro 4	Diesel	1995	4	13
02/98→09/01	3 (E46) 318 i	M43 B19	Petrol	1895	4	28
02/98→09/01	3 (E46) 318 i	M43 B19TU	Petrol	1895	4	28
09/01→02/05	3 (E46) 318 i	N46 B20	Petrol	1995	4	26
09/01→02/05	3 (E46) 318 i	N46 B20A	Petrol	1995	4	26
02/98→04/05	3 (E46) 320 d	M47 204D1	Diesel	1951	4	12
04/98→09/01	3 (E46) 320 d	M47 D20	Diesel	1951	4	12
09/01→02/05	3 (E46) 320 d	M47 N204D4 Euro 4	Diesel	1995	4	13
09/00→02/05	3 (E46) 320 i	M54 226S1	Petrol	2171	6	5
09/00→02/05	3 (E46) 320 i	M54 B22	Petrol	2171	6	5
03/98→09/00	3 (E46) 323 i	M52 B25 (Vanos)	Petrol	2494	6	15
09/00→02/05	3 (E46) 325 i	M54 B25	Petrol	2494	6	17
02/98→06/00	3 (E46) 328 i	M52 B28	Petrol	2793	6	15
10/99→02/05	3 (E46) 330 d	M57 D30	Diesel	2926	6	12
03/03→02/05	3 (E46) 330 d	M57 N306D2 Euro 4	Diesel	2993	6	20
06/00→02/05	3 (E46) 330 i	M54 B30	Petrol	2979	6	17
06/00→02/05	3 (E46) 330 xd	M57 D30	Diesel	2926	6	12
03/03→02/05	3 (E46) 330 xd	M57 N306D2 Euro 4	Diesel	2993	6	20
07/09→12/11	3 (E90) 316 d	N47 D20C	Diesel	1995	4	27
02/06→12/11	3 (E90) 316 i	N45 B16	Petrol	1596	4	26
02/06→12/11	3 (E90) 316 i	N45 B16A	Petrol	1596	4	26
09/05→12/11	3 (E90) 318 d	M47 N204D4 Euro 4	Diesel	1995	4	13
09/05→12/11	3 (E90) 318 d	N47 D2 A	Diesel	1995	4	27
09/05→12/11	3 (E90) 318 d	N47 D20C	Diesel	1995	4	27
09/05→03/07	3 (E90) 318 i	N46 B20	Petrol	1995	4	26
09/05→03/07	3 (E90) 318 i	N46 B20B	Petrol	1995	4	26
09/05→12/11	3 (E90) 320 d	M47 N204D4 Euro 4	Diesel	1995	4	13
09/07→12/11	3 (E90) 320 d	N47 D2 A	Diesel	1995	4	27
01/05→12/11	3 (E90) 320 d	N47 D20C	Diesel	1995	4	27
07/08→12/11	3 (E90) 320 d xDrive	N47 D20C	Diesel	1995	4	27
01/05→03/07	3 (E90) 320 i	N46 B20	Petrol	1995	4	26
01/05→03/07	3 (E90) 320 i	N46 B20A	Petrol	1995	4	26
01/05→03/07	3 (E90) 320 i	N46 B20C	Petrol	1995	4	26
09/07→12/11	3 (E90) 320 xd	N47 D20C	Diesel	1995	4	27
04/06→12/11	3 (E90) 323 i	N52 B25A	Petrol	2497	6	7
09/06→12/11	3 (E90) 325 d	M57 306D3	Diesel	2993	6	18
01/05→12/11	3 (E90) 325 i	N52 B25	Petrol	2497	6	7
01/05→12/11	3 (E90) 325 i	N52 B25A	Petrol	2497	6	7
09/07→12/11	3 (E90) 325 i	N53 B30	Petrol	2996	6	30
09/07→12/11	3 (E90) 325 i	N53 B30A	Petrol	2996	6	30
09/08→12/11	3 (E90) 325 i xDrive	N53 B30A	Petrol	2996	6	30
01/05→12/11	3 (E90) 325 xi	N52 B25A	Petrol	2497	6	7
09/07→12/11	3 (E90) 325 xi	N53 B30A	Petrol	2996	6	30
07/05→11/07	3 (E90) 328 i	N52 NB30A	Petrol	2996	6	30
09/05→12/11	3 (E90) 330 d	M57 306D3	Diesel	2993	6	18
01/09→12/11	3 (E90) 330 d	M57 N2306D3	Diesel	2993	6	18
09/05→12/11	3 (E90) 330 d	M57 TU2D30 Euro 4	Diesel	2993	6	18
01/05→12/11	3 (E90) 330 i	N52 B30	Petrol	2996	6	30
01/05→12/11	3 (E90) 330 i	N52 B30A	Petrol	2996	6	30
09/07→12/11	3 (E90) 330 i	N53 B30	Petrol	2996	6	30
09/07→12/11	3 (E90) 330 i	N53 B30A	Petrol	2996	6	30
09/08→12/11	3 (E90) 330 i xDrive	N53 B30A	Petrol	2996	6	30
09/05→12/11	3 (E90) 330 xd	M57 306D3	Diesel	2993	6	18
09/05→12/11	3 (E90) 330 xd	M57 TU2D30 Euro 4	Diesel	2993	6	18
01/05→12/11	3 (E90) 330 xi	N52 B30A	Petrol	2996	6	30



CCM

x



09/07→12/11	3 (E90) 330 xi	N53 B30A	Petrol	2996	6	30
02/12→	3 (F30) 316 d	N47 D20C	Diesel	1995	4	27
02/12→	3 (F30) 318 d	N47 D20C	Diesel	1995	4	27
11/12→	3 (F30) 318 d xDrive	N47 D20C	Diesel	1995	4	27
10/11→	3 (F30) 320 d	N47 D20C	Diesel	1995	4	27
10/11→	3 (F30) 320 d xDrive	N47 D20C	Diesel	1995	4	27
02/12→	3 (F30) 320 i	N20 B20A	Petrol	1997	4	24
11/11→	3 (F30) 320 i xDrive	N20 B20A	Petrol	1997	4	24
10/11→	3 (F30) 328 i	N20 B20A	Petrol	1997	4	24
10/11→	3 (F30) 328 i	N26 B20A	Petrol	1997	4	24
10/11→	3 (F30) 328 i xDrive	N20 B20A	Petrol	1997	4	24
10/11→	3 (F30) 328 i xDrive	N26 B20A	Petrol	1997	4	24
03/94→08/00	3 Compact (E36) 316 g	M43 B16	Petrol	1596	4	11
03/94→08/00	3 Compact (E36) 316 i	M43 B16	Petrol	1596	4	11
01/95→08/00	3 Compact (E36) 318 tds	M41 D18	Diesel	1665	4	3
11/94→08/95	3 Compact (E36) 318 ti	M42 B18	Petrol	1796	4	11
07/95→08/00	3 Compact (E36) 318 ti	M44 B19	Petrol	1895	4	29
08/97→08/00	3 Compact (E36) 323 ti	M52 B25 (Vanos)	Petrol	2494	6	15
06/01→02/05	3 Compact (E46) 316 ti	N42 B18	Petrol	1796	4	25
06/02→02/05	3 Compact (E46) 316 ti	N45 B16A	Petrol	1596	4	26
03/03→02/05	3 Compact (E46) 318 td	M47 N204D4 Euro 4	Diesel	1995	4	13
09/01→02/05	3 Compact (E46) 318 ti	N46 B20A	Petrol	1995	4	26
10/01→12/02	3 Compact (E46) 320 td	M47 204D1	Diesel	1951	4	12
09/01→02/05	3 Compact (E46) 320 td	M47 N204D4 Euro 4	Diesel	1995	4	13
06/01→02/05	3 Compact (E46) 325 ti	M54 B25	Petrol	2494	6	17
09/87→06/90	3 Convertible (E30) 316 i	M40 B16C	Petrol	1596	4	9
09/90→10/93	3 Convertible (E30) 318 i	M40 B18	Petrol	1796	4	9
04/86→10/93	3 Convertible (E30) 320 i	M20 B20	Petrol	1991	6	1
12/85→10/93	3 Convertible (E30) 325 i	M20 B25	Petrol	2494	6	9
06/88→06/91	3 Convertible (E30) M3 2.3	S14 B23	Petrol	2303	4	39
01/94→04/99	3 Convertible (E36) 318 i	M43 B18	Petrol	1796	4	11
12/93→04/99	3 Convertible (E36) 320 i	M50 B20TU	Petrol	1991	6	4
06/95→04/99	3 Convertible (E36) 323 i	M52 B25 (Vanos)	Petrol	2494	6	15
03/93→03/95	3 Convertible (E36) 325 i	M50 B25	Petrol	2494	6	15
03/95→04/99	3 Convertible (E36) 328 i	M52 B28	Petrol	2793	6	15
09/01→	3 Convertible (E46) 318 Ci	N46 B20	Petrol	1995	4	26
02/05→	3 Convertible (E46) 318 Ci	N46 B20B	Petrol	1995	4	26
02/05→	3 Convertible (E46) 320 Cd	M47 N204D4 Euro 4	Diesel	1995	4	13
09/00→	3 Convertible (E46) 320 Ci	M54 226S1	Petrol	2171	6	5
09/00→	3 Convertible (E46) 320 Ci	M54 B22	Petrol	2171	6	5
04/00→09/00	3 Convertible (E46) 323 Ci	M52 B25 (Vanos)	Petrol	2494	6	15
08/05→	3 Convertible (E46) 330 Cd	M57 N306D2 Euro 4	Diesel	2993	6	20
03/07→	3 Convertible (E93) 320 d	N47 D2 A	Diesel	1995	4	27
01/08→	3 Convertible (E93) 320 d	N47 D20C	Diesel	1995	4	27
03/07→08/07	3 Convertible (E93) 320 i	N46 B20	Petrol	1995	4	26
03/07→08/07	3 Convertible (E93) 320 i	N46 NB20B	Petrol	1995	4	26
03/07→	3 Convertible (E93) 325 d	M57 D30 (306D3)	Diesel	2993	6	18
03/07→	3 Convertible (E93) 325 d	M57 TU2D30 Euro 4	Diesel	2993	6	18
03/07→	3 Convertible (E93) 325 i	N52 B25	Petrol	2497	6	7
03/07→	3 Convertible (E93) 325 i	N52 B25A	Petrol	2497	6	7
03/07→	3 Convertible (E93) 325 i	N53 B30	Petrol	2996	6	30
03/07→	3 Convertible (E93) 325 i	N53 B30A	Petrol	2996	6	30
03/07→	3 Convertible (E93) 330 d	M57 D30 (306D3)	Diesel	2993	6	18
01/09→	3 Convertible (E93) 330 d	M57 N2306D3	Diesel	2993	6	18
03/07→	3 Convertible (E93) 330 d	M57 TU2D30 Euro 4	Diesel	2993	6	18
03/07→	3 Convertible (E93) 330 i	N53 B30	Petrol	2996	6	30
03/07→	3 Convertible (E93) 330 i	N53 B30A	Petrol	2996	6	30

MODEL INDEX

Modelverzeichnis • Index de modele • Índice de Modelo
Indeks modelu • Модель автомобиля • دليل الموديل



CCM

x



9

09/93→04/99	3 Coupe (E36) 316 i	M43 B16	Petrol	1596	4	11
03/92→10/95	3 Coupe (E36) 318 is	M42 B18	Petrol	1796	4	11
09/95→04/99	3 Coupe (E36) 318 is	M44 B19	Petrol	1895	4	29
03/92→04/99	3 Coupe (E36) 320 i	M50 B (20 6 S1)	Petrol	1991	6	4
03/92→04/99	3 Coupe (E36) 320 i	M50 B20TU	Petrol	1991	6	4
03/95→04/99	3 Coupe (E36) 323 i	M52 B25 (Vanos)	Petrol	2494	6	15
03/92→04/99	3 Coupe (E36) 325 i	M50 B25	Petrol	2494	6	15
03/92→04/99	3 Coupe (E36) 325 i	M50 B25 (Vanos)	Petrol	2494	6	16
01/95→04/99	3 Coupe (E36) 328 i	M52 B28	Petrol	2793	6	15
04/00→	3 Coupe (E46) 316 Ci	M43 B16 (16 4 E3)	Petrol	1596	4	11
06/02→	3 Coupe (E46) 316 Ci	N45 B16A	Petrol	1596	4	26
11/99→09/01	3 Coupe (E46) 318 Ci	M43 B19	Petrol	1895	4	28
09/01→	3 Coupe (E46) 318 Ci	N46 B20	Petrol	1995	4	26
03/05→	3 Coupe (E46) 318 Ci	N46 B20A	Petrol	1995	4	26
11/03→	3 Coupe (E46) 320 Cd	M47 N204D4 Euro 4	Diesel	1995	4	13
09/00→	3 Coupe (E46) 320 Ci	M54 226S1	Petrol	2171	6	5
09/00→	3 Coupe (E46) 320 Ci	M54 B22	Petrol	2171	6	5
04/99→09/00	3 Coupe (E46) 323 Ci	M52 B25 (Vanos)	Petrol	2494	6	15
04/99→06/00	3 Coupe (E46) 328 Ci	M52 B28	Petrol	2793	6	15
03/03→	3 Coupe (E46) 330 Cd	M57 N306D2 Euro 4	Diesel	2993	6	20
03/07→	3 Coupe (E92) 320 d	N47 D2 A	Diesel	1995	4	27
01/10→	3 Coupe (E92) 320 d	N47 D20C	Diesel	1995	4	27
09/08→	3 Coupe (E92) 320 d xDrive	N47 D20C	Diesel	1995	4	27
11/06→06/07	3 Coupe (E92) 320 i	N46 B20A	Petrol	1995	4	26
11/06→06/07	3 Coupe (E92) 320 i	N46 NB20B	Petrol	1995	4	26
03/07→	3 Coupe (E92) 320 xd	N47 D2 A	Diesel	1995	4	27
04/10→	3 Coupe (E92) 325 d	M57 N2306D3	Diesel	2993	6	18
03/07→	3 Coupe (E92) 325 d	M57 TU2D30 Euro 4	Diesel	2993	6	18
09/06→	3 Coupe (E92) 325 i	N52 B25	Petrol	2497	6	7
09/06→	3 Coupe (E92) 325 i	N52 B25A	Petrol	2497	6	7
09/06→	3 Coupe (E92) 325 i	N52 B25C	Petrol	2497	6	7
09/07→	3 Coupe (E92) 325 i	N53 B30	Petrol	2996	6	30
09/07→	3 Coupe (E92) 325 i	N53 B30A	Petrol	2996	6	30
09/08→	3 Coupe (E92) 325 i xDrive	N53 B30A	Petrol	2996	6	30
09/06→	3 Coupe (E92) 325 xi	N52 B25A	Petrol	2497	6	7
09/06→	3 Coupe (E92) 325 xi	N52 B25C	Petrol	2497	6	7
09/07→	3 Coupe (E92) 325 xi	N53 B30A	Petrol	2996	6	30
08/06→11/07	3 Coupe (E92) 328 i	N52 NB30A	Petrol	2996	6	30
09/06→	3 Coupe (E92) 330 d	M57 306D3	Diesel	2993	6	18
01/09→	3 Coupe (E92) 330 d	M57 N2306D3	Diesel	2993	6	18
09/06→	3 Coupe (E92) 330 d	M57 TU2D30 Euro 4	Diesel	2993	6	18
09/06→	3 Coupe (E92) 330 i	N52 B30A	Petrol	2996	6	30
09/06→	3 Coupe (E92) 330 i	N53 B30	Petrol	2996	6	30
09/06→	3 Coupe (E92) 330 i	N53 B30A	Petrol	2996	6	30
09/08→	3 Coupe (E92) 330 i xDrive	N53 B30A	Petrol	2996	6	30
09/06→	3 Coupe (E92) 330 xd	M57 306D3	Diesel	2993	6	18
01/09→	3 Coupe (E92) 330 xd	M57 N2306D3	Diesel	2993	6	18
09/06→	3 Coupe (E92) 330 xd	M57 TU2D30 Euro 4	Diesel	2993	6	18
09/06→	3 Coupe (E92) 330 xi	N52 B30A	Petrol	2996	6	30
03/13→	3 Gran Turismo (F34) 318 d	N47 D20C	Diesel	1995	4	27
03/13→	3 Gran Turismo (F34) 320 d	N47 D20C	Diesel	1995	4	27
03/13→	3 Gran Turismo (F34) 320 d xDrive	N47 D20C	Diesel	1995	4	27
03/13→	3 Gran Turismo (F34) 320 i	N20 B20A	Petrol	1997	4	24
03/13→	3 Gran Turismo (F34) 320 i	N20 B20B	Petrol	1997	4	24
03/13→	3 Gran Turismo (F34) 320 i xDrive	N20 B20A	Petrol	1997	4	24
03/13→	3 Gran Turismo (F34) 320 i xDrive	N20 B20B	Petrol	1997	4	24
03/13→	3 Gran Turismo (F34) 328 i	N20 B20A	Petrol	1997	4	24



CCM

x



03/13→	3 Gran Turismo (F34) 328 i xDrive	N20 B20A	Petrol	1997	4	24
09/91→06/94	3 Touring (E30) 316 i	M40 B16	Petrol	1596	4	9
09/87→06/94	3 Touring (E30) 318 i	M40 B18	Petrol	1796	4	9
01/88→12/91	3 Touring (E30) 320 i	M20 B20	Petrol	1991	6	1
01/88→06/93	3 Touring (E30) 324 td	M21 D24WA	Diesel	2443	6	2
07/87→03/93	3 Touring (E30) 325 i	M20 B25	Petrol	2494	6	9
06/88→10/93	3 Touring (E30) 325 i X	M20 B25	Petrol	2494	6	9
01/96→10/99	3 Touring (E36) 316 i	M43 B16	Petrol	1596	4	11
07/95→10/99	3 Touring (E36) 318 i	M43 B18	Petrol	1796	4	11
01/95→10/99	3 Touring (E36) 318 tds	M41 D18	Diesel	1665	4	3
01/95→10/99	3 Touring (E36) 320 i	M50 B20TU	Petrol	1991	6	4
09/95→10/99	3 Touring (E36) 323 i	M52 B25 (Vanos)	Petrol	2494	6	15
01/95→10/99	3 Touring (E36) 325 tds	M51 D25	Diesel	2497	6	3
01/95→10/99	3 Touring (E36) 325 tds	M51 D25	Diesel	2498	6	3
01/95→10/99	3 Touring (E36) 328 i	M52 B28	Petrol	2793	6	15
03/02→02/05	3 Touring (E46) 316 i	N42 B18	Petrol	1796	4	25
06/02→02/05	3 Touring (E46) 316 i	N45 B16	Petrol	1596	4	26
06/02→02/05	3 Touring (E46) 316 i	N45 B16A	Petrol	1596	4	26
03/02→02/05	3 Touring (E46) 318 d	M47 204D1	Diesel	1951	4	12
03/02→02/05	3 Touring (E46) 318 d	M47 D20	Diesel	1951	4	12
03/03→02/05	3 Touring (E46) 318 d	M47 N204D4 Euro 4	Diesel	1995	4	13
10/99→09/01	3 Touring (E46) 318 i	M43 B19	Petrol	1895	4	28
10/99→09/01	3 Touring (E46) 318 i	M43 B19TU	Petrol	1895	4	28
09/01→02/05	3 Touring (E46) 318 i	N46 B20	Petrol	1995	4	26
09/01→02/05	3 Touring (E46) 318 i	N46 B20A	Petrol	1995	4	26
03/00→09/01	3 Touring (E46) 320 d	M47 204D1	Diesel	1951	4	12
03/00→09/01	3 Touring (E46) 320 d	M47 D20	Diesel	1951	4	12
09/01→02/05	3 Touring (E46) 320 d	M47 N204D4 Euro 4	Diesel	1995	4	13
09/00→02/05	3 Touring (E46) 320 i	M54 226S1	Petrol	2171	6	5
09/00→02/05	3 Touring (E46) 320 i	M54 B22	Petrol	2171	6	5
09/00→02/05	3 Touring (E46) 325 i	M54 B25	Petrol	2494	6	17
10/99→06/00	3 Touring (E46) 328 i	M52 B28	Petrol	2793	6	15
10/99→02/05	3 Touring (E46) 330 d	M57 D30	Diesel	2926	6	12
03/03→02/05	3 Touring (E46) 330 d	M57 N306D2 Euro 4	Diesel	2993	6	20
06/00→02/05	3 Touring (E46) 330 i	M54 B30	Petrol	2979	6	17
06/00→02/05	3 Touring (E46) 330 xd	M57 D30	Diesel	2926	6	12
03/03→02/05	3 Touring (E46) 330 xd	M57 N306D2 Euro 4	Diesel	2993	6	20
09/09→	3 Touring (E91) 316 d	N47 D20C	Diesel	1995	4	27
09/05→	3 Touring (E91) 318 d	M47 N204D4 Euro 4	Diesel	1995	4	13
09/07→	3 Touring (E91) 318 d	N47 D2 A	Diesel	1995	4	27
07/07→	3 Touring (E91) 318 d	N47 D20C	Diesel	1995	4	27
01/06→	3 Touring (E91) 318 i	N46 B20	Petrol	1995	4	26
01/06→	3 Touring (E91) 318 i	N46 B20B	Petrol	1995	4	26
09/05→	3 Touring (E91) 320 d	M47 N204D4 Euro 4	Diesel	1995	4	13
09/05→	3 Touring (E91) 320 d	M47 N204D5	Diesel	1995	4	14
09/05→	3 Touring (E91) 320 d	N47 D2 A	Diesel	1995	4	27
09/05→	3 Touring (E91) 320 d	N47 D20C	Diesel	1995	4	27
09/08→	3 Touring (E91) 320 d xDrive	N47 D20C	Diesel	1995	4	27
09/05→	3 Touring (E91) 320 i	N46 B20	Petrol	1995	4	26
09/05→	3 Touring (E91) 320 i	N46 B20A	Petrol	1995	4	26
09/05→	3 Touring (E91) 320 i	N46 B20C	Petrol	1995	4	26
09/07→	3 Touring (E91) 320 xd	N47 D2 A	Diesel	1995	4	27
09/06→	3 Touring (E91) 325 d	M57 306D3	Diesel	2993	6	18
04/10→	3 Touring (E91) 325 d	M57 N2306D3	Diesel	2993	6	18
09/06→	3 Touring (E91) 325 d	M57 TU2D30 Euro 4	Diesel	2993	6	18
09/05→	3 Touring (E91) 325 i	N52 B25	Petrol	2497	6	7
09/05→	3 Touring (E91) 325 i	N52 B25A	Petrol	2497	6	7

MODEL INDEX

 Modelverzeichnis • Index de modele • Índice de Modelo
 Indeks modelu • Модель автомобиля • دليل الموديل

CCM
x

9

09/05→	3 Touring (E91) 325 i	N52 B25C	Petrol	2497	6	7
09/07→	3 Touring (E91) 325 i	N53 B30	Petrol	2996	6	30
09/07→	3 Touring (E91) 325 i	N53 B30A	Petrol	2996	6	30
09/08→	3 Touring (E91) 325 i xDrive	N53 B30A	Petrol	2996	6	30
09/05→	3 Touring (E91) 325 xi	N52 B25C	Petrol	2497	6	7
09/07→	3 Touring (E91) 325 xi	N53 B30A	Petrol	2996	6	30
09/05→	3 Touring (E91) 330 d	M57 306D3	Diesel	2993	6	18
01/09→	3 Touring (E91) 330 d	M57 N2306D3	Diesel	2993	6	18
01/09→	3 Touring (E91) 330 d xDrive	M57 N2306D3	Diesel	2993	6	18
09/05→	3 Touring (E91) 330 i	N52 B30	Petrol	2996	6	30
09/05→	3 Touring (E91) 330 i	N52 B30A	Petrol	2996	6	30
09/07→	3 Touring (E91) 330 i	N53 B30	Petrol	2996	6	30
09/08→	3 Touring (E91) 330 i xDrive	N53 B30A	Petrol	2996	6	30
09/05→	3 Touring (E91) 330 xd	M57 306D3	Diesel	2993	6	18
09/05→	3 Touring (E91) 330 xd	M57 TU2D30 Euro 4	Diesel	2993	6	18
09/05→	3 Touring (E91) 330 xi	N52 B30A	Petrol	2996	6	30
09/07→	3 Touring (E91) 330 xi	N53 B30A	Petrol	2996	6	30
06/12→	3 Touring (F31) 316 d	N47 D20C	Diesel	1995	4	27
06/12→	3 Touring (F31) 318 d	N47 D20C	Diesel	1995	4	27
01/13→	3 Touring (F31) 318 d xDrive	N47 D20C	Diesel	1995	4	27
06/12→	3 Touring (F31) 320 d	N47 D20C	Diesel	1995	4	27
06/12→	3 Touring (F31) 320 d xDrive	N47 D20C	Diesel	1995	4	27
06/12→	3 Touring (F31) 320 i	N20 B20B	Petrol	1997	4	24
06/12→	3 Touring (F31) 320 i xDrive	N20 B20B	Petrol	1997	4	24
06/12→	3 Touring (F31) 328 i	N20 B20A	Petrol	1997	4	24
06/12→	3 Touring (F31) 328 i xDrive	N20 B20A	Petrol	1997	4	24
07/13→	4 Coupe (F32) 420 d	N47 D20C	Diesel	1995	4	27
07/13→	4 Coupe (F32) 428 i	N20 B20A	Petrol	1997	4	24
07/13→	4 Coupe (F32) 428 i xDrive	N20 B20A	Petrol	1997	4	24
07/74→05/81	5 (E12) 518	M10 B18	Petrol	1766	4	32
09/77→05/81	5 (E12) 520/6	M20 B20	Petrol	1991	6	1
08/73→05/81	5 (E12) 525	M30 B25 (32/40)	Petrol	2494	6	31
01/75→08/77	5 (E12) 528	M30 B28 (32/40 INAT)	Petrol	2788	6	31
04/77→05/81	5 (E12) 528 i	M30 B28 (32/40 INAT)	Petrol	2788	6	31
06/80→08/81	5 (E12) M 3.4	M30 B35	Petrol	3453	6	38
06/81→08/84	5 (E28) 518	M10 B18	Petrol	1766	4	32
09/83→12/87	5 (E28) 518 i	M10 B18	Petrol	1766	4	32
06/81→12/87	5 (E28) 520 i	M20 B20	Petrol	1991	6	1
03/86→12/87	5 (E28) 524 d	M21 D24W	Diesel	2443	6	2
09/83→12/87	5 (E28) 524 td	M21 D24WA	Diesel	2443	6	2
09/81→12/87	5 (E28) 525 e	M20 B27	Petrol	2693	6	10
06/81→12/87	5 (E28) 528 i	M30 B28 (32/40 INAT)	Petrol	2788	6	31
01/85→12/87	5 (E28) 535 i, M 535 i	M30 B35	Petrol	3430	6	35
08/89→09/95	5 (E34) 518 i	M40 B18	Petrol	1796	4	9
08/89→09/95	5 (E34) 518 i	M43 B18	Petrol	1796	4	11
01/88→08/91	5 (E34) 520 i	M20 B20	Petrol	1991	6	1
09/89→09/95	5 (E34) 520 i 24V	M50 B (20 6 S1)	Petrol	1991	6	4
09/89→09/95	5 (E34) 520 i 24V	M50 B20TU	Petrol	1991	6	4
03/88→09/95	5 (E34) 524 td	M21 D24WA	Diesel	2443	6	2
01/88→08/91	5 (E34) 525 i	M20 B25	Petrol	2494	6	9
09/89→09/95	5 (E34) 525 i 24V	M50 B25	Petrol	2494	6	15
09/89→09/95	5 (E34) 525 i 24V	M52 B25 (Vanos)	Petrol	2494	6	15
10/91→09/95	5 (E34) 525 iX 24V	M52 B25 (Vanos)	Petrol	2494	6	15
04/93→09/95	5 (E34) 525 td	M51 D25	Diesel	2497	6	3
04/93→09/95	5 (E34) 525 td	M51 D25	Diesel	2498	6	3
09/91→09/95	5 (E34) 525 tds	M51 D25	Diesel	2497	6	3
09/91→09/95	5 (E34) 525 tds	M51 D25	Diesel	2498	6	3



CCM

x



01/88→08/91	5 (E34) 530 i	M30 B30	Petrol	2988	6	33
09/92→09/95	5 (E34) 530 i V8	M60 B30	Petrol	2997	V8	21
01/88→09/95	5 (E34) 535 i	M30 B35	Petrol	3430	6	35
09/92→09/95	5 (E34) 540 i V8	M60 B40	Petrol	3982	V8	34
02/00→06/03	5 (E39) 520 d	M47 204D1	Diesel	1951	4	12
02/00→06/03	5 (E39) 520 d	M47 D20	Diesel	1951	4	12
09/00→06/03	5 (E39) 520 i	M54 B22	Petrol	2171	6	5
11/95→09/00	5 (E39) 523 i	M52 B25 (Vanos)	Petrol	2494	6	15
02/00→06/03	5 (E39) 525 d	M57 D25	Diesel	2497	6	6
09/00→06/03	5 (E39) 525 i	M54 B25	Petrol	2494	6	17
01/97→06/03	5 (E39) 525 td	M51 D25	Diesel	2497	6	3
01/97→06/03	5 (E39) 525 td	M51 D25	Diesel	2498	6	3
01/96→06/03	5 (E39) 525 tds	M51 D25	Diesel	2497	6	3
01/96→06/03	5 (E39) 525 tds	M51 D25	Diesel	2498	6	3
11/95→09/00	5 (E39) 528 i	M52 B28	Petrol	2793	6	15
08/98→06/03	5 (E39) 530 d	M57 D30	Diesel	2926	6	12
09/00→06/03	5 (E39) 530 i	M54 B30	Petrol	2979	6	17
04/96→03/99	5 (E39) 535 i	M62 B35	Petrol	3498	V8	22
04/99→06/03	5 (E39) 535 i	M62 B35TU	Petrol	3498	V8	22
04/96→06/03	5 (E39) 540 i	M62 B 44	Petrol	4398	V8	36
07/05→03/10	5 (E60) 520 d	N47 D2 A	Diesel	1995	4	27
07/05→03/10	5 (E60) 520 d	N47 D20C	Diesel	1995	4	27
07/03→03/10	5 (E60) 520 i	M54 226S1	Petrol	2171	6	5
07/03→03/10	5 (E60) 520 i	M54 B22	Petrol	2171	6	5
04/06→12/09	5 (E60) 520 i	N46 B20B	Petrol	1995	4	26
07/05→03/10	5 (E60) 523 i	N52 B25	Petrol	2497	6	7
07/05→03/10	5 (E60) 523 i	N52 B25A	Petrol	2497	6	7
01/07→03/10	5 (E60) 525 d	M57 306D3	Diesel	2993	6	18
09/08→03/10	5 (E60) 525 d xDrive	M57 D30 (306D3)	Diesel	2993	6	18
09/03→03/10	5 (E60) 525 i	M54 B25	Petrol	2494	6	17
07/05→03/10	5 (E60) 525 i	N52 B25	Petrol	2497	6	7
07/05→03/10	5 (E60) 525 i	N52 B25A	Petrol	2497	6	7
01/07→03/10	5 (E60) 525 i	N53 B30	Petrol	2996	6	30
01/07→03/10	5 (E60) 525 i	N53 B30A	Petrol	2996	6	30
09/08→03/10	5 (E60) 525 i xDrive	N53 B30A	Petrol	2996	6	30
01/07→03/10	5 (E60) 525 xd	M57 306D3	Diesel	2993	6	18
07/05→03/10	5 (E60) 525 xi	N52 B25A	Petrol	2497	6	7
01/07→03/10	5 (E60) 525 xi	N53 B30A	Petrol	2996	6	30
07/03→03/10	5 (E60) 530 d	M57 306D3	Diesel	2993	6	18
07/03→03/10	5 (E60) 530 d	M57 D30 (306D2)	Diesel	2993	6	14
07/03→03/10	5 (E60) 530 d	M57 D30 (306D3)	Diesel	2993	6	18
07/03→03/10	5 (E60) 530 d	N57 306D2 Euro 4	Diesel	2993	6	19
09/08→03/10	5 (E60) 530 d xDrive	M57 N2306D3	Diesel	2993	6	18
07/03→03/10	5 (E60) 530 i	M54 B30	Petrol	2979	6	17
07/05→03/10	5 (E60) 530 i	N52 B30	Petrol	2996	6	30
03/05→03/10	5 (E60) 530 i	N52 B30A	Petrol	2996	6	30
01/07→03/10	5 (E60) 530 i	N53 B30	Petrol	2996	6	30
01/07→03/10	5 (E60) 530 i	N53 B30A	Petrol	2996	6	30
09/08→03/10	5 (E60) 530 i xDrive	N53 B30A	Petrol	2996	6	30
07/05→03/10	5 (E60) 530 xd	M57 306D3	Diesel	2993	6	18
07/05→03/10	5 (E60) 530 xi	N52 B30A	Petrol	2996	6	30
01/07→03/10	5 (E60) 530 xi	N53 B30A	Petrol	2996	6	30
09/04→03/10	5 (E60) 535 d	M57 306D4	Diesel	2993	6	19
09/03→03/10	5 (E60) 545 i	N62 B44	Petrol	4398	V8	37
01/13→	5 (F10) 518 d	N47 D20C	Diesel	1995	4	27
03/10→	5 (F10) 520 d	N47 D20C	Diesel	1995	4	27
02/13→	5 (F10) 520 d xDrive	N47 D20C	Diesel	1995	4	27

MODEL INDEX

Modelverzeichnis • Index de modele • Índice de Modelo
 Indeks modelu • Модель автомобиля • دليل الموديل

CCM
x

9

09/11→	5 (F10) 520 i	N20 B20A	Petrol	1997	4	24
03/10→	5 (F10) 523 i	N53 B30A	Petrol	2996	6	30
09/11→	5 (F10) 528 i	N20 B20A	Petrol	1997	4	24
03/10→	5 (F10) 528 i	N53 B30A	Petrol	2996	6	30
09/11→	5 (F10) 528 i xDrive	N20 B20A	Petrol	1997	4	24
09/11→	5 (F10) 530 i	N53 B30A	Petrol	2996	6	30
10/11→	5 Gran Turismo (F07) 520 d	N47 D20C	Diesel	1995	4	27
11/95→06/96	5 Touring (E34) 518 g	M43 B18	Petrol	1796	4	11
03/93→09/94	5 Touring (E34) 518 i	M40 B18	Petrol	1796	4	9
09/94→01/97	5 Touring (E34) 518 i	M43 B18	Petrol	1796	4	11
11/91→01/97	5 Touring (E34) 520 i	M50 B (20 6 S1)	Petrol	1991	6	4
11/91→01/97	5 Touring (E34) 520 i	M50 B20TU	Petrol	1991	6	4
11/91→01/97	5 Touring (E34) 525 i	M50 B25	Petrol	2494	6	15
02/92→01/97	5 Touring (E34) 525 ix	M50 B25	Petrol	2494	6	15
02/92→01/97	5 Touring (E34) 525 ix	M52 B25 (Vanos)	Petrol	2494	6	15
03/93→01/97	5 Touring (E34) 525 td	M51 D25	Diesel	2497	6	3
03/93→01/97	5 Touring (E34) 525 td	M51 D25	Diesel	2498	6	3
12/91→01/97	5 Touring (E34) 525 tds	M51 D25	Diesel	2497	6	3
12/91→01/97	5 Touring (E34) 525 tds	M51 D25	Diesel	2498	6	3
09/92→01/97	5 Touring (E34) 530 i V8	M60 B30	Petrol	2997	V8	21
09/93→01/97	5 Touring (E34) 540 i	M60 B40	Petrol	3982	V8	34
02/00→09/03	5 Touring (E39) 520 d	M47 204D1	Diesel	1951	4	12
02/00→09/03	5 Touring (E39) 520 d	M47 D20	Diesel	1951	4	12
09/00→05/04	5 Touring (E39) 520 i	M54 B22	Petrol	2171	6	5
01/97→09/00	5 Touring (E39) 523 i	M52 B25 (Vanos)	Petrol	2494	6	15
02/00→05/04	5 Touring (E39) 525 d	M57 D25	Diesel	2497	6	6
09/00→05/04	5 Touring (E39) 525 i	M54 B25	Petrol	2494	6	17
03/97→05/04	5 Touring (E39) 525 tds	M51 D25	Diesel	2497	6	3
03/97→05/04	5 Touring (E39) 525 tds	M51 D25	Diesel	2498	6	3
01/97→09/00	5 Touring (E39) 528 i	M52 B28	Petrol	2793	6	15
08/98→05/04	5 Touring (E39) 530 d	M57 D30	Diesel	2926	6	12
09/00→05/04	5 Touring (E39) 530 i	M54 B30	Petrol	2979	6	17
01/97→05/04	5 Touring (E39) 540 i	M62 B 44	Petrol	4398	V8	36
07/05→	5 Touring (E61) 520 d	N47 D2 A	Diesel	1995	4	27
07/05→	5 Touring (E61) 520 d	N47 D20C	Diesel	1995	4	27
07/05→	5 Touring (E61) 523 i	N52 B25	Petrol	2497	6	7
07/05→	5 Touring (E61) 523 i	N52 B25A	Petrol	2497	6	7
01/07→	5 Touring (E61) 525 d	M57 306D3	Diesel	2993	6	18
09/08→	5 Touring (E61) 525 d xDrive	M57 D30 (306D3)	Diesel	2993	6	18
06/04→	5 Touring (E61) 525 i	M54 B25	Petrol	2494	6	17
07/05→	5 Touring (E61) 525 i	N52 B25	Petrol	2497	6	7
07/05→	5 Touring (E61) 525 i	N52 B25A	Petrol	2497	6	7
01/07→	5 Touring (E61) 525 i	N53 B30	Petrol	2996	6	30
01/07→	5 Touring (E61) 525 i	N53 B30A	Petrol	2996	6	30
09/08→	5 Touring (E61) 525 i xDrive	N53 B30A	Petrol	2996	6	30
01/07→	5 Touring (E61) 525 xd	M57 306D3	Diesel	2993	6	18
07/05→	5 Touring (E61) 525 xi	N52 B25A	Petrol	2497	6	7
01/07→	5 Touring (E61) 525 xi	N53 B30A	Petrol	2996	6	30
07/05→	5 Touring (E61) 530 d	M57 306D3	Diesel	2993	6	18
06/04→	5 Touring (E61) 530 d	N57 306D2 Euro 4	Diesel	2993	6	19
09/08→	5 Touring (E61) 530 d xDrive	M57 D30 (306D3)	Diesel	2993	6	18
06/04→	5 Touring (E61) 530 i	M54 B30	Petrol	2979	6	17
07/05→	5 Touring (E61) 530 i	N52 B30	Petrol	2996	6	30
07/05→	5 Touring (E61) 530 i	N52 B30A	Petrol	2996	6	30
01/07→	5 Touring (E61) 530 i	N53 B30	Petrol	2996	6	30
01/07→	5 Touring (E61) 530 i	N53 B30A	Petrol	2996	6	30
09/08→	5 Touring (E61) 530 i xDrive	N53 B30A	Petrol	2996	6	30



CCM

x



07/05→	5 Touring (E61) 530 xd	M57 306D3	Diesel	2993	6	18
07/05→	5 Touring (E61) 530 xi	N52 B30A	Petrol	2996	6	30
01/07→	5 Touring (E61) 530 xi	N53 B30A	Petrol	2996	6	30
09/04→	5 Touring (E61) 535 d	M57 306D4	Diesel	2993	6	19
06/04→	5 Touring (E61) 545 i	N62 B44	Petrol	4398	V8	37
01/13→	5 Touring (F11) 518 d	N47 D20C	Diesel	1995	4	27
09/10→	5 Touring (F11) 520 d	N47 D20C	Diesel	1995	4	27
02/13→	5 Touring (F11) 520 d xDrive	N47 D20C	Diesel	1995	4	27
09/11→	5 Touring (F11) 520 i	N20 B20A	Petrol	1997	4	24
09/10→	5 Touring (F11) 523 i	N53 B30A	Petrol	2996	6	30
09/11→	5 Touring (F11) 528 i	N20 B20A	Petrol	1997	4	24
09/10→	5 Touring (F11) 528 i	N53 B30A	Petrol	2996	6	30
09/11→	5 Touring (F11) 528 i xDrive	N20 B20A	Petrol	1997	4	24
09/11→	5 Touring (F11) 530 i	N53 B30A	Petrol	2996	6	30
09/79→08/87	6 (E24) 628 CSi	M30 B28 (32/40 INAT)	Petrol	2788	6	31
04/76→08/79	6 (E24) 630 CS	M30 B30	Petrol	2988	6	33
04/85→09/90	6 (E24) 635 CSi	M30 B35	Petrol	3430	6	35
06/78→08/88	6 (E24) 635 CSi	M30 B35	Petrol	3453	6	38
10/86→10/88	6 (E24) M 635 CSi	S38 B35 (Kat)	Petrol	3453	6	39
09/04→	6 (E63) 630 i	N52 B30	Petrol	2996	6	30
09/04→	6 (E63) 630 i	N52 B30A	Petrol	2996	6	30
07/07→	6 (E63) 630 i	N53 B30	Petrol	2996	6	30
01/04→	6 (E63) 645 Ci	N62 B44	Petrol	4398	V8	37
09/04→	6 Convertible (E64) 630 i	N52 B30	Petrol	2996	6	30
09/04→	6 Convertible (E64) 630 i	N52 B30A	Petrol	2996	6	30
07/07→	6 Convertible (E64) 630 i	N53 B30	Petrol	2996	6	30
04/04→	6 Convertible (E64) 645 Ci	N62 B44	Petrol	4398	V8	37
07/77→06/86	7 (E23) 725 i	M30 B25 (32/40)	Petrol	2494	6	31
05/77→08/79	7 (E23) 728	M30 B28 (32/40 INAT)	Petrol	2788	6	31
07/78→08/86	7 (E23) 728 i	M30 B28 (32/40 INAT)	Petrol	2788	6	31
05/77→08/79	7 (E23) 730	M30 B30	Petrol	2988	6	33
04/85→08/86	7 (E23) 735 i	M30 B35	Petrol	3430	6	35
09/79→08/86	7 (E23) 735 i	M30 B35	Petrol	3453	6	38
05/83→08/86	7 (E23) 745 i	M30 B35	Petrol	3430	6	35
12/86→09/94	7 (E32) 730 i, iL	M30 B30	Petrol	2988	6	33
04/92→09/94	7 (E32) 730 i, iL V8	M60 B30	Petrol	2997	V8	21
09/86→09/92	7 (E32) 735 i, iL	M30 B35	Petrol	3430	6	35
09/86→12/87	7 (E32) 735 i, iL	M30 B35	Petrol	3430	6	35
04/92→09/94	7 (E32) 740 i, iL V8	M60 B40	Petrol	3982	V8	34
09/87→09/94	7 (E32) 750 i, iL V12	M70 B50	Petrol	4988	V12	23
04/96→11/01	7 (E38) 725 tds	M51 D25	Diesel	2497	6	3
04/96→11/01	7 (E38) 725 tds	M51 D25	Diesel	2498	6	3
08/95→11/01	7 (E38) 728 i, iL	M52 B28	Petrol	2793	6	15
08/98→04/00	7 (E38) 730 d	M57 D30	Diesel	2926	6	12
10/94→11/01	7 (E38) 730 i, iL	M60 B30	Petrol	2997	V8	21
01/96→11/01	7 (E38) 735 i, iL	M62 B35	Petrol	3498	V8	22
05/99→11/01	7 (E38) 740 d	M67 D39	Diesel	3901	V8	12
10/94→11/01	7 (E38) 740 i, iL	M60 B40	Petrol	3982	V8	34
01/96→11/01	7 (E38) 740 i, iL	M62 B 44	Petrol	4398	V8	36
03/03→	7 (E65, E66) 730 i, Li	M54 B30	Petrol	2979	6	17
03/05→	7 (E65, E66) 730 i, Li	N52 B30	Petrol	2996	6	30
03/05→	7 (E65, E66) 730 i, Li	N52 B30A	Petrol	2996	6	30
03/05→	7 (E65, E66) 3.0 730 i, Li	N52 B30A	Petrol	2996	6	30
11/01→	7 (E65, E66) 745 i, Li	N62 B44	Petrol	4398	V8	37
07/05→	7 (E65, E66) 730 Ld	M57 306D3	Diesel	2993	6	18
10/02→	7 (E65, E66) 730 d	M57 N2306D2 Euro 4	Diesel	2993	6	19
10/02→	7 (E65, E66) 730 d	M57 N306D2 Euro 4	Diesel	2993	6	20

MODEL INDEX

Modelverzeichnis • Index de modele • Índice de Modelo
Indeks modelu • Модель автомобиля • دليل الموديل



CCM

x



9

07/05→	7 (E65, E66) 730 Ld	N57 N306D2	Diesel	2993	6	19
06/08→	7 (F01, F02, F03, F04) 730 i	N52 B30A	Petrol	2996	6	30
06/08→	7 (F01, F02, F03, F04) 730 i	N52 B30BF	Petrol	2996	6	30
01/96→12/99	8 (E31) 840 Ci	M62 B 44	Petrol	4398	V8	36
02/93→02/96	8 (E31) 840 i	M60 B40	Petrol	3982	V8	34
04/90→10/94	8 (E31) 850 i, Ci	M70 B50	Petrol	4988	V12	23
01/73→12/78	530i	M30 B30E	Petrol	2988	6	32
01/76→12/78	630 CSi	M30 B30E	Petrol	2988	6	32
09/86→	730 i	M30 B30E	Petrol	2988	6	32
09/63→07/66	1500	M10 B16	Petrol	1574	4	8
01/70→11/72	1500- 2000	M10 B18	Petrol	1766	4	32
04/64→04/68	1500-2000 1600	M10 B16	Petrol	1574	4	8
07/69→09/71	1500-2000 1800	M10 B18	Petrol	1766	4	32
10/67→05/69	1600 GT Coupe 1.6	M10 B16	Petrol	1574	4	8
09/74→03/76	2000-3.2 Coupe (E9) 2.5 CS	M30 B25 (32/40)	Petrol	2494	6	31
01/69→04/71	2000-3.2 Coupe (E9) 2800 CS	M30 B28 (32/40 INAT)	Petrol	2788	6	31
05/71→03/76	2000-3.2 Coupe (E9) 3.0 CS	M30 B30	Petrol	2988	6	33
07/71→03/76	2000-3.2 Coupe (E9) 3.0 Csi	M30 B30	Petrol	2988	6	33
01/74→12/75	2000-3.2 Coupe (E9) 3.2 CSL	M30 B32	Petrol	3153	6	32
10/68→04/77	2500	M30 B25 (32/40)	Petrol	2494	6	31
02/75→04/77	2500-3.3 (E3) 2.8 L	M30 B28 (32/40 INAT)	Petrol	2788	6	31
10/68→07/75	2500-3.3 (E3) 2800	M30 B28 (32/40 INAT)	Petrol	2788	6	31
02/75→04/77	2500-3.3 (E3) 3.0 L	M30 B30	Petrol	2988	6	33
05/71→04/77	2500-3.3 (E3) 3.0 S	M30 B30	Petrol	2988	6	33
07/71→04/77	2500-3.3 (E3) 3.0 Si	M30 B30	Petrol	2988	6	33
04/12→	X1 (E84) sDrive 16 d	N47 D20C	Diesel	1995	4	27
03/09→	X1 (E84) sDrive 18 d	N47 D20C	Diesel	1995	4	27
03/09→	X1 (E84) sDrive 18 i	N46 B20B	Petrol	1995	4	26
10/09→	X1 (E84) sDrive 20 d	N47 D20C	Diesel	1995	4	27
09/11→	X1 (E84) sDrive 20 i	N20 B20A	Petrol	1997	4	24
03/09→	X1 (E84) xDrive 18 d	N47 D20C	Diesel	1995	4	27
10/09→	X1 (E84) xDrive 20 d	N47 D20C	Diesel	1995	4	27
09/11→	X1 (E84) xDrive 20 i	N20 B20A	Petrol	1997	4	24
10/09→	X1 (E84) xDrive 23 d	N47 SD20D	Diesel	1995	4	27
01/10→	X1 (E84) xDrive 25 i	N52 B30A	Petrol	2996	6	30
04/11→	X1 (E84) xDrive 28 i	N20 B20A	Petrol	1997	4	24
10/09→	X1 (E84) xDrive 28 i	N52 B30A	Petrol	2996	6	30
10/04→	X3 (E83) 2.0 d	M47 N204D4 Euro 4	Diesel	1995	4	13
09/07→	X3 (E83) 2.0 d	N47 D2 A	Diesel	1995	4	27
07/05→	X3 (E83) 2.0 i	N46 B20	Petrol	1995	4	26
07/05→	X3 (E83) 2.0 i	N46 B20A	Petrol	1995	4	26
01/04→	X3 (E83) 2.5 i	M54 B25	Petrol	2494	6	17
09/06→	X3 (E83) 2.5 si	N52 B25A	Petrol	2497	6	7
01/04→	X3 (E83) 3.0 d	M57 N2306D2 Euro 4	Diesel	2993	6	19
01/04→	X3 (E83) 3.0 i xDrive	M54 B30	Petrol	2979	6	17
09/06→	X3 (E83) 3.0 sd	M57 306D5	Diesel	2993	6	14
09/06→	X3 (E83) 3.0 si	N52 B30A	Petrol	2996	6	30
09/08→	X3 (E83) xDrive 18 d	N47 D20C	Diesel	1995	4	27
09/08→	X3 (E83) xDrive 20 d	N47 D20C	Diesel	1995	4	27
09/08→	X3 (E83) xDrive 20 i	N46 B20B	Petrol	1995	4	26
09/08→	X3 (E83) xDrive 25 i	N52 B25A	Petrol	2497	6	7
09/08→	X3 (E83) xDrive 30 d	M57 N2306D3	Diesel	2993	6	18
09/08→	X3 (E83) xDrive 30 i	N52 B30A	Petrol	2996	6	30
08/11→	X3 (F25) sDrive 18d	N47 D20C	Diesel	1995	4	27
09/10→	X3 (F25) xDrive 20 d	N47 D20C	Diesel	1995	4	27
09/11→	X3 (F25) xDrive 20 i	N20 B20A	Petrol	1997	4	24
08/11→	X3 (F25) xDrive 28 i	N20 B20A	Petrol	1997	4	24



CCM

x



9

04/11→	X3 (F25) xDrive 28 i	N52 B30A	Petrol	2996	6	30
08/04→	X5 (E53) 3.0 d	M57 N306D2 Euro 4	Diesel	2993	6	20
12/03→	X5 (E53) 3.0 d	M57 N306D4	Diesel	2993	6	19
05/00→	X5 (E53) 3.0 i	M54 B30	Petrol	2979	6	17
05/00→	X5 (E53) 4.4 i	M62 B 44	Petrol	4398	V8	36
12/03→	X5 (E53) 4.4 i	N62 B44	Petrol	4398	V8	37
02/07→09/08	X5 (E70) 3.0 d	M57 306D3	Diesel	2993	6	18
02/07→09/08	X5 (E70) 3.0 d	M57 D30 (306D3)	Diesel	2993	6	18
02/07→09/08	X5 (E70) 3.0 si	N52 B30	Petrol	2996	6	30
02/07→09/08	X5 (E70) 3.0 si	N52 B30A	Petrol	2996	6	30
09/08→03/10	X5 (E70) xDrive 30 i	N52 B30A	Petrol	2996	6	30
05/08→	X6 (E71, E72) 30 d	M57 N2306D3	Diesel	2993	6	18
09/10→	X6 (E71, E72) xDrive 30 d	M57 N2306D3	Diesel	2993	6	18
06/88→06/91	Z1 2.5	M20 B25	Petrol	2494	6	9
10/95→10/98	Z3 (E36) 1.8	M43 B18	Petrol	1796	4	11
07/98→01/03	Z3 (E36) 1.9	M43 194E1	Petrol	1895	4	28
07/98→01/03	Z3 (E36) 1.9	M43 B19	Petrol	1895	4	28
07/98→01/03	Z3 (E36) 1.9	M43 B19TU	Petrol	1895	4	28
10/95→03/99	Z3 (E36) 1.9	M44 B19	Petrol	1895	4	29
08/00→01/03	Z3 (E36) 2.2	M54 226S1	Petrol	2171	6	5
08/00→01/03	Z3 (E36) 2.2	M54 B22	Petrol	2171	6	5
04/97→06/00	Z3 (E36) 2.8	M52 B28	Petrol	2793	6	15
06/00→01/03	Z3 (E36) 3.0	M54 B30	Petrol	2979	6	17
07/97→06/00	Z3 Coupe (E36) 2.8	M52 B28	Petrol	2793	6	15
04/05→	Z4 (E85) 2.0 i	N46 B20	Petrol	1995	4	26
04/05→	Z4 (E85) 2.0 i	N46 B20A	Petrol	1995	4	26
10/03→	Z4 (E85) 2.2 i	M54 226S1	Petrol	2171	6	5
10/03→	Z4 (E85) 2.2 i	M54 B22	Petrol	2171	6	5
02/03→	Z4 (E85) 2.5 i	M54 B25	Petrol	2494	6	17
01/06→	Z4 (E85) 2.5 i	N52 B25A	Petrol	2497	6	7
01/06→	Z4 (E85) 2.5 si	N52 B25A	Petrol	2497	6	7
02/03→	Z4 (E85) 3.0 i	M54 B30	Petrol	2979	6	17
01/06→	Z4 (E85) 3.0 si	N52 B30	Petrol	2996	6	30
01/06→	Z4 (E85) 3.0 si	N52 B30A	Petrol	2996	6	30
04/13→	Z4 (E89) sDrive 18 i	N20 B20A	Petrol	1997	4	24
09/11→	Z4 (E89) sDrive 20 i	N20 B20A	Petrol	1997	4	24
05/09→	Z4 (E89) sDrive 23 i	N52 B25A	Petrol	2497	6	7
09/11→	Z4 (E89) sDrive 28 i	N20 B20A	Petrol	1997	4	24
05/09→	Z4 (E89) sDrive 30 i	N52 B30A	Petrol	2996	6	30
03/06→	Z4 Coupe (E86) 3.0 si	N52 B30	Petrol	2996	6	30
03/06→	Z4 Coupe (E86) 3.0 si	N52 B30A	Petrol	2996	6	30

ENGINE INDEX

Motorverzeichnis • Index de moteur • Índice de Motor
 Indeks silnika • Модель двигателя • دليل المحرك

CCM

9

M10 B16	Petrol	1574	4	84.00	8
M10 B18	Petrol	1766	4	89.00	32
M20 B20	Petrol	1991	6	80.00	1
M20 B23L	Petrol	2316	6	80.00	1
M20 B25	Petrol	2494	6	84.00	9
M20 B27	Petrol	2693	6	84.00	10
M21 D24W	Diesel	2443	6	80.00	2
M21 D24WA	Diesel	2443	6	80.00	2
M30 B25 (32/40)	Petrol	2494	6	86.00	31
M30 B28 (32/40 INAT)	Petrol	2788	6	86.00	31
M30 B30	Petrol	2988	6	89.00	33
M30 B30E	Petrol	2988	6	89.00	32
M30 B32	Petrol	3153	6	89.00	32
M30 B35	Petrol	3430	6	92.00	35
M30 B35	Petrol	3453	6	93.40	38
M40 B16	Petrol	1596	4	84.00	9
M40 B16C	Petrol	1596	4	84.00	9
M40 B18	Petrol	1796	4	84.00	9
M41 D18	Diesel	1665	4	80.00	3
M42 B18	Petrol	1796	4	84.00	11
M43 194E1	Petrol	1895	4	85.00	28
M43 B16	Petrol	1596	4	84.00	11
M43 B16 (16 4 E3)	Petrol	1596	4	84.00	11
M43 B18	Petrol	1796	4	84.00	11
M43 B19	Petrol	1895	4	85.00	28
M43 B19TU	Petrol	1895	4	85.00	28
M44 B19	Petrol	1895	4	85.00	29
M47 204D1	Diesel	1951	4	84.00	12
M47 D20	Diesel	1951	4	84.00	12
M47 N204D4 Euro 4	Diesel	1995	4	84.00	13
M47 N204D5	Diesel	1995	4	84.00	14
M50 B (20 6 S1)	Petrol	1991	6	80.00	4
M50 B20TU	Petrol	1991	6	80.00	4
M50 B25	Petrol	2494	6	84.00	15
M50 B25 (Vanos)	Petrol	2494	6	84.00	16
M51 D25	Diesel	2497	6	80.00	3
M51 D25	Diesel	2498	6	80.00	3
M52 B25 (Vanos)	Petrol	2494	6	84.00	15
M52 B28	Petrol	2793	6	84.00	15
M54 226S1	Petrol	2171	6	80.00	5
M54 B22	Petrol	2171	6	80.00	5
M54 B25	Petrol	2494	6	84.00	17
M54 B30	Petrol	2979	6	84.00	17
M57 306D3	Diesel	2993	6	84.00	18
M57 306D4	Diesel	2993	6	84.00	19
M57 306D5	Diesel	2993	6	84.00	14
M57 D25	Diesel	2497	6	80.00	6
M57 D30	Diesel	2926	6	84.00	12
M57 D30 (306D2)	Diesel	2993	6	84.00	14
M57 D30 (306D3)	Diesel	2993	6	84.00	18
M57 N2306D2 Euro 4	Diesel	2993	6	84.00	19
M57 N2306D3	Diesel	2993	6	84.00	18
M57 N306D2 Euro 4	Diesel	2993	6	84.00	20
M57 N306D4	Diesel	2993	6	84.00	19
M57 TU2D30 Euro 4	Diesel	2993	6	84.00	18
M60 B30	Petrol	2997	V8	84.00	21
M60 B40	Petrol	3982	V8	89.00	34
M62 B 44	Petrol	4398	V8	92.00	36
M62 B35	Petrol	3498	V8	84.00	22
M62 B35TU	Petrol	3498	V8	84.00	22

CCM
x

9

M67 D39	Diesel	3901	V8	84.00	12
M70 B50	Petrol	4988	V12	84.00	23
N20 B20A	Petrol	1997	4	84.00	24
N20 B20B	Petrol	1997	4	84.00	24
N26 B20A	Petrol	1997	4	84.00	24
N42 B18	Petrol	1796	4	84.00	25
N45 B16	Petrol	1596	4	84.00	26
N45 B16A	Petrol	1596	4	84.00	26
N46 B20	Petrol	1995	4	84.00	26
N46 B20A	Petrol	1995	4	84.00	26
N46 B20B	Petrol	1995	4	84.00	26
N46 B20BD	Petrol	1995	4	84.00	26
N46 B20C	Petrol	1995	4	84.00	26
N46 B20CC	Petrol	1995	4	84.00	26
N46 B20CD	Petrol	1995	4	84.00	26
N46 NB20B	Petrol	1995	4	84.00	26
N47 D2 A	Diesel	1995	4	84.00	27
N47 D20B	Diesel	1995	4	84.00	27
N47 D20C	Diesel	1995	4	84.00	27
N47 SD20D	Diesel	1995	4	84.00	27
N52 B25	Petrol	2497	6	82.00	7
N52 B25A	Petrol	2497	6	82.00	7
N52 B25C	Petrol	2497	6	82.00	7
N52 B30	Petrol	2996	6	85.00	30
N52 B30A	Petrol	2996	6	85.00	30
N52 B30AF	Petrol	2996	6	85.00	30
N52 B30B	Petrol	2996	6	85.00	30
N52 B30BF	Petrol	2996	6	85.00	30
N52 NB30A	Petrol	2996	6	85.00	30
N53 B30	Petrol	2996	6	85.00	30
N53 B30A	Petrol	2996	6	85.00	30
N57 306D2 Euro 4	Diesel	2993	6	84.00	19
N57 N306D2	Diesel	2993	6	84.00	19
N62 B44	Petrol	4398	V8	92.00	37
S14 B20	Petrol	1990	4	93.40	39
S14 B23	Petrol	2303	4	93.40	39
S38 B35 (Kat)	Petrol	3453	6	93.40	39



3 (E21) 320/6	09/77→08/82	M20 B20					1
3 (E30) 320 i	09/82→06/91		6cyl.				
3 Convertible (E30) 320 i	04/86→10/93		1991cc	90kW (122PS)			
3 Touring (E30) 320 i	01/88→12/91						
5 (E12) 520/6	09/77→05/81						
5 (E28) 520 i	06/81→12/87						TD5117
5 (E34) 520 i	01/88→08/91						

3 (E21) 323 i	01/78→08/82	M20 B23L					TD5259
3 (E30) 323 i	09/82→08/86		6cyl.	2316cc	102-110kW (139-150PS)		

08-131300-00	STD	80.00	1.500		001 IF CR P	KV1
08-131305-00	0.25mm				026 P	STD
08-131307-00	0.50mm				231 P	STD
[R45870]			3.500			

3 (E30) 324 d	09/85→08/91	M21 D24W					2
5 (E28) 524 d	03/86→12/87		6cyl.	2443cc	63kW (86PS)		
		Diesel				TD5165	

3 (E30) 324 td	09/87→08/91	M21 D24WA					TD443
3 Touring (E30) 324 td	01/88→06/93		6cyl.				
5 (E28) 524 td	09/83→12/87		2443cc	85kW (116PS)			
5 (E34) 524 td	03/88→09/95	Diesel	Turbo				

08-133100-10	STD	80.00	2.500		008 CR P	KV1
08-133105-10	0.25mm				005 IFU P	F12/F14
08-133107-10	0.50mm				231 CR P	STD
			3.500			

3 (E36) 318 tds	01/95→02/98	M41 D18					3
3 Compact (E36) 318 tds	01/95→08/00		4cyl.				
3 Touring (E36) 318 tds	01/95→10/99		1665cc	66kW (89PS)			
		Diesel	Turbo Intercooled			TD452	

3 (E36) 325 td	09/91→02/98	M51 D25					TD4229
5 (E34) 525 td	04/93→09/95		6cyl.				
5 (E39) 525 td	01/97→06/03		2497cc	85kW (116PS)			
5 Touring (E34) 525 td	03/93→01/97	Diesel	Turbo				

3 (E36) 325 tds	05/93→02/98	M51 D25					TD5285
3 Touring (E36) 325 tds	01/95→10/99		6cyl.				
5 (E34) 525 tds	09/91→09/95		2498cc	105kW (143PS)			
5 (E39) 525 tds	01/96→06/03	Diesel	Turbo Intercooled				
5 Touring (E34) 525 tds	12/91→01/97						
5 Touring (E39) 525 tds	03/97→05/04						
7 (E38) 725 tds	04/96→11/01						

08-704500-00	STD	80.00	3.000		008 CR P	KV1
08-704507-00	0.50mm				005 IFU P	IKA
[R49900]					231 CR P	STD
			3.000			



3 (E36) 320 i	09/90→02/98	M50 B (20 6 S1)			4
3 Coupe (E36) 320 i	03/92→04/99	6cyl.			
5 (E34) 520 i 24V	09/89→09/95	1991cc	110kW	(150PS)	
5 Touring (E34) 520 i	11/91→01/97				
				TD4227	

3 (E36) 320 i	09/90→02/98	M50 B20TU			TD21239
3 Convertible (E36) 320 i	12/93→04/99	6cyl.			
3 Coupe (E36) 320 i	03/92→04/99	1991cc	110kW	(150PS)	
3 Touring (E36) 320 i	01/95→10/99				
5 (E34) 520 i 24V	09/89→09/95				
5 Touring (E34) 520 i	11/91→01/97				

08-704900-00 →05/1992	STD	80.00	1.500		001 CR P	KV1
			1.750		026 P	STD
			3.000		236 P	STD
08-705000-00 08-705007-00 05/1992→	STD 0.50mm	80.00	1.500		001 CR P	KV1
			1.500		026 P	STD
			2.000		236 P	KV1
<i>[R66470]</i>						

3 (E46) 320 i	09/00→02/05	M54 226S1			5
3 Convertible (E46) 320 Ci,	09/00→	6cyl.			
3 Coupe (E46) 320 Ci		2171cc	125kW	(170PS)	
3 Touring (E46) 320 i	09/00→02/05				
5 (E60) 520 i	07/03→03/10				
Z3 (E36) 2.2	08/00→01/03				
Z4 (E85) 2.2 i	10/03→			TD17522	

3 (E46) 320 i	09/00→02/05	M54 B22			TD15969
3 Convertible (E46) 320 Ci,	09/00→	6cyl.			
3 Coupe (E46) 320 Ci		2171cc	125kW	(170PS)	
3 Touring (E46) 320 i	09/00→02/05				
5 (E39) 520 i	09/00→06/03				
5 (E60) 520 i	07/03→03/10				
5 Touring (E39) 520 i	09/00→05/04				
Z3 (E36) 2.2	08/00→01/03				
Z4 (E85) 2.2 i	10/03→				

08-422200-00 08-422207-00	STD 0.50mm	80.00	1.200		001 CK	ST
			1.500		026 P	GOE13
			2.000		236 P	GOE13



5 (E39) 525 d	02/00→06/03	M57 D25	6
5 Touring (E39) 525 d	02/00→05/04	6cyl. 2497cc 120kW (163PS)	
		Diesel Turbo Intercooled	TD21233

08-134200-00 ¹ STD <i>[R67690]</i>	80.00	2.500		001 CK P	KV1
		2.000		026 P	IKA
		3.000		231 CR P	STD
08-135400-00 ² STD <i>[R67700]</i>	80.00	3.000		008 CK P	KV1
		2.000		026 P	IKA
		3.000		231 NT	STD

¹ For Mahle OE piston ¹ Für OE-Kolben von Mahle ¹ Pour les pistones d'origine Mahle ¹ Para pistones originales Mahle
² For Nüral OE piston ² Für OE-Kolben von Nüral ² Pour les pistones d'origine Nüral ² Para pistones originales Nüral

3 (E90) 325 i	01/05→12/11	N52 B25	7
3 Convertible (E93) 325 i	03/07→	6cyl. 2497cc 130-160kW (177-218PS)	
3 Coupe (E92) 325 i	09/06→		
3 Touring (E91) 325 i	09/05→		
5 (E60) 523 i, 5 (E60) 525 i	07/05→03/10		
5 Touring (E61) 523 i,	07/05→		
5 Touring (E61) 525 i			TD21408

3 (E90) 323 i	04/06→12/11	N52 B25A	7
3 (E90) 325 i, 3 (E90) 325 xi	01/05→12/11	6cyl. 2497cc 130-160kW (177-218PS)	
3 Convertible (E93) 325 i	03/07→		
3 Coupe (E92) 325 i, 3 Coupe (E92) 325 xi	09/06→		
3 Touring (E91) 325 i	09/05→		
5 (E60) 523 i, 5 (E60) 525 i,	07/05→03/10		
5 (E60) 525 xi			
5 Touring (E61) 523 i,	07/05→		
5 Touring (E61) 525 i,			
5 Touring (E61) 525 xi			
X3 (E83) 2.5 si	09/06→		
X3 (E83) xDrive 25 i	09/08→		
Z4 (E85) 2.5 i, Z4 (E85) 2.5 si	01/06→		
Z4 (E89) sDrive 23 i	05/09→		TD18517

3 Coupe (E92) 325 i, 3 Coupe (E92) 325 xi	09/06→	N52 B25C	7
3 Touring (E91) 325 i,	09/05→	6cyl. 2497cc 160kW (218PS)	
3 Touring (E91) 325 xi			TD18169

08-440700-00 STD	82.00	1.200		001 NT	ST
		1.500		026 P	KV1
		2.000		712 NT	ST



1500	09/63→07/66	M10 B16							8
02 (E10) 1502	01/75→07/77		4cyl.						
02 (E10) 1600 Ti	09/67→11/69		1574cc	55-77kW	(75-105PS)				
02 (E10) 1600/2	12/67→12/71								
02 (E10) 1602	04/71→07/75								
02 Convertible (E10) 1600-2	12/67→10/71								
02 Touring (E6) 1600	05/71→04/73								
3 (E21) 315	03/81→03/84								
3 (E21) 316	08/75→08/80								
3 (E30) 315	09/82→12/91								
1500-2000 1600	04/64→04/68								
1600 GT Coupe 1.6	10/67→05/69								TD5170

08-128200-10	STD	84.00	1.750		001 IF CR P		KV1
08-128205-10	0.25mm		2.000		026 P		STD
08-128207-10	0.50mm		4.000		712 CR		ST

3 (E30) 325 i	09/83→06/91	M20 B25							9
3 (E30) 325 i X	03/86→08/91		6cyl.						
3 Convertible (E30) 325 i	12/85→10/93		2494cc	126kW	(171PS)				
3 Touring (E30) 325 i	07/87→03/93								
3 Touring (E30) 325 i X	06/88→10/93								
5 (E34) 525 i	01/88→08/91								
Z1 2.5	06/88→06/91								TD439

3 (E30) 316 i	09/87→06/91	M40 B16							
3 (E36) 316 i	09/90→09/93		4cyl.						
3 Touring (E30) 316 i	09/91→06/94		1596cc	73kW	(99PS)				TD5255

3 Convertible (E30) 316 i	09/87→06/90	M40 B16C							
			4cyl.						
			1596cc	73kW	(99PS)				TD21160

3 (E30) 318 i	09/87→06/91	M40 B18							
3 (E36) 318 i	12/90→10/93		4cyl.						
3 Convertible (E30) 318 i	09/90→10/93		1796cc	83kW	(113PS)				
3 Touring (E30) 318 i	09/87→06/94								
5 (E34) 518 i	08/89→09/95								
5 Touring (E34) 518 i	03/93→09/94								TD4224

08-106500-00	STD	84.00	1.500		001 IF CR P		IKA
08-106507-00	0.50mm		1.750		026 P		STD
			3.000		236 P		STD
08-702600-00	STD	84.00	1.500		001 IF CR P		F12/F14
08-702605-00	0.25mm		1.750		026 P		STD
08-702607-00	0.50mm		3.000		712 CR		ST

[R66480]



3 (E30) 325 e 2.7	10/83→12/88	M20 B27							
5 (E28) 525 e	09/81→12/87		6cyl.						10
			2693cc	90-95kW (122-129PS)					TD5269

08-133200-10	STD	84.00	1.500		001 IF CR P			KV1
			2.000		026 P			STD
			4.000		712 CR			ST

3 (E30) 318 is	09/89→08/91	M42 B18							
3 (E36) 318 is	03/93→02/98		4cyl.						11
3 Compact (E36) 318 ti	11/94→08/95		1796cc	103kW (140PS)					TD454
3 Coupe (E36) 318 is	03/92→10/95								

3 (E36) 316 i	09/90→02/98	M43 B16							
3 (E46) 316 i	04/00→02/05		4cyl.						
3 Compact (E36) 316 g,	03/94→08/00		1596cc	75kW (102PS)					
3 Compact (E36) 316 i									
3 Coupe (E36) 316 i	09/93→04/99								
3 Touring (E36) 316 i	01/96→10/99								TD455

3 (E46) 316 i	04/00→02/05	M43 B16 (16 4 E3)							
3 Coupe (E46) 316 Ci	04/00→		4cyl.						
			1596cc	77kW (105PS)					TD17055

3 (E36) 318 i	10/93→02/98	M43 B18							
3 Convertible (E36) 318 i	01/94→04/99		4cyl.						
3 Touring (E36) 318 i	07/95→10/99		1796cc	85kW (116PS)					
5 (E34) 518 i	08/89→09/95								
5 Touring (E34) 518 g	11/95→06/96								
5 Touring (E34) 518 i	09/94→01/97								
Z3 (E36) 1.8	10/95→10/98								TD456

08-704200-00	STD	84.00	1.500		001 IF CR P			KV1
			1.500		026 P			STD
			2.000		712 CR			ST
08-704207-00	0.50mm							
[R66490]								

3 (E46) 318 d	09/01→03/03	M47 204D1							
3 (E46) 320 d	02/98→04/05		4cyl.						12
3 Compact (E46) 320 td	10/01→12/02		1951cc	85-100kW (116-136PS)					
3 Touring (E46) 318 d	03/02→02/05	Diesel	Turbo Intercooled						
3 Touring (E46) 320 d	03/00→09/01								
5 (E39) 520 d	02/00→06/03								
5 Touring (E39) 520 d	02/00→09/03								TD18305

3 (E46) 318 d	09/01→03/03	M47 D20							
3 (E46) 320 d	04/98→09/01		4cyl.						
3 Touring (E46) 318 d	03/02→02/05		1951cc	100kW (136PS)					
3 Touring (E46) 320 d	03/00→09/01	Diesel	Turbo Intercooled						
5 (E39) 520 d	02/00→06/03								
5 Touring (E39) 520 d	02/00→09/03								TD9521

3 (E46) 330 d	10/99→02/05	M57 D30							
3 (E46) 330 xd	06/00→02/05		6cyl.						
3 Touring (E46) 330 d	10/99→02/05		2926cc	135kW (184PS)					
3 Touring (E46) 330 xd	06/00→02/05	Diesel	Turbo Intercooled						
5 (E39) 530 d	08/98→06/03								
5 Touring (E39) 530 d	08/98→05/04								
7 (E38) 730 d	08/98→04/00								TD12288





7 (E38) 740 d			05/99→11/01	M67 D39	V8cyl. 3901cc 180kW (245PS)	
					Diesel Turbo Intercooled	TD16525
08-114400-00	STD	84.00	3.000		008 CK P	KV1
08-114405-00	0.25mm		2.000		026 P	STD
[R60220]			3.000		231 CR P	STD
08-114400-10	STD	84.00	3.000		008 CK P	KV1
01/2001→			2.000		026 P	STD
			3.000		231 NT	ST

3 (E46) 318 d			03/03→02/05	M47 N204D4 Euro 4	4cyl. 1995cc 85-120kW (116-163PS)	13
3 (E46) 320 d			09/01→02/05		Diesel Turbo Intercooled	
3 (E90) 318 d, 3 (E90) 320 d			09/05→12/11			
3 Compact (E46) 318 td			03/03→02/05			
3 Compact (E46) 320 td			09/01→02/05			
3 Convertible (E46) 320 Cd			02/05→			
3 Coupe (E46) 320 Cd			11/03→			
3 Touring (E46) 318 d			03/03→02/05			
3 Touring (E46) 320 d			09/01→02/05			
3 Touring (E91) 318 d, 3 Touring (E91) 320 d			09/05→			
X3 (E83) 2.0 d			10/04→		TD17523	
08-114400-45	STD	84.00	3.000		008 CK P	KV1
			2.000		026 P	STD
			2.000		231 LKZ CR P	KV1



3 Touring (E91) 320 d			09/05→	M47 N204D5	4cyl. 1995cc 120kW (163PS)	14
					Diesel Turbo Intercooled	
X3 (E83) 3.0 sd			09/06→	M57 306D5	6cyl. 2993cc 210kW (286PS)	
					Diesel Bi-Turbo Intercooled	TD24380
5 (E60) 530 d			07/03→03/10	M57 D30 (306D2)	6cyl. 2993cc 150-155kW (204-211PS)	
					Diesel Turbo Intercooled	TD27248
08-114400-40	STD	84.00	3.000		008 CK P	KV1
08-114405-40	0.25mm		2.000		026 P	STD
			2.000		231 CK P	KV1





3 (E36) 325 i	09/90→09/95	M50 B25				15
3 Convertible (E36) 325 i	03/93→03/95		6cyl.			
3 Coupe (E36) 325 i	03/92→04/99		2494cc	141kW (192PS)		
5 (E34) 525 i 24V	09/89→09/95					
5 Touring (E34) 525 i	11/91→01/97					
5 Touring (E34) 525 ix	02/92→01/97					TD4228

3 (E36) 323 i 2.5	03/95→02/98	M52 B25 (Vanos)				16
3 (E46) 323 i	03/98→09/00		6cyl.			
3 Compact (E36) 323 ti	08/97→08/00		2494cc	125-141kW (170-192PS)		
3 Convertible (E36) 323 i	06/95→04/99					
3 Convertible (E46) 323 Ci	04/00→09/00					
3 Coupe (E36) 323 i	03/95→04/99					
3 Coupe (E46) 323 Ci	04/99→09/00					
3 Touring (E36) 323 i	09/95→10/99					
5 (E34) 525 i 24V	09/89→09/95					
5 (E34) 525 iX 24V	10/91→09/95					
5 (E39) 523 i	11/95→09/00					
5 Touring (E34) 525 ix	02/92→01/97					
5 Touring (E39) 523 i	01/97→09/00					

3 (E36) 328 i	01/95→02/98	M52 B28				17
3 (E46) 328 i	02/98→06/00		6cyl.			
3 Convertible (E36) 328 i	03/95→04/99		2793cc	142kW (193PS)		
3 Coupe (E36) 328 i	01/95→04/99					
3 Coupe (E46) 328 Ci	04/99→06/00					
3 Touring (E36) 328 i	01/95→10/99					
3 Touring (E46) 328 i	10/99→06/00					
5 (E39) 528 i	11/95→09/00					
5 Touring (E39) 528 i	01/97→09/00					
7 (E38) 728 i, iL	08/95→11/01					
Z3 (E36) 2.8	04/97→06/00					
Z3 Coupe (E36) 2.8	07/97→06/00					TD4231

08-705100-00	STD	84.00	1.500		001 CK P	KV1
08-705107-00	0.50mm		1.500		026 P	GOE13
[R66500]			2.000		712 CR	ST

3 (E36) 325 i	09/90→09/95	M50 B25 (Vanos)				16
3 Coupe (E36) 325 i	03/92→04/99		6cyl.			
			2494cc	141kW (192PS)		TD18476

08-705200-00	STD	84.00	1.500		001 P PS	KV1
08-705207-00	0.50mm		1.500		026 P	STD
			2.000		712 CR	ST

3 (E46) 325 i	09/00→02/05	M54 B25				17
3 Compact (E46) 325 ti	06/01→02/05		6cyl.			
3 Touring (E46) 325 i	09/00→02/05		2494cc	125-141kW (170-192PS)		
5 (E39) 525 i	09/00→06/03					
5 (E60) 525 i	09/03→03/10					
5 Touring (E39) 525 i	09/00→05/04					
5 Touring (E61) 525 i	06/04→					
X3 (E83) 2.5 i	01/04→					
Z4 (E85) 2.5 i	02/03→					





3 (E46) 330 i, 3 Touring (E46) 330 i	06/00→02/05	M54 B30			
5 (E39) 530 i	09/00→06/03		6cyl.		
5 (E60) 530 i	07/03→03/10		2979cc	170kW (231PS)	
5 Touring (E39) 530 i	09/00→05/04				
5 Touring (E61) 530 i	06/04→				
7 (E65, E66) 730 i, Li	03/03→				
X3 (E83) 3.0 i xDrive	01/04→				
X5 (E53) 3.0 i	05/00→				
Z3 (E36) 3.0	06/00→01/03				
Z4 (E85) 3.0 i	02/03→				TD21235

08-425300-00	STD	84.00	1.200		001 NT	ST
			1.500		026 P	GOE13
			2.000		236 P	KV1

3 (E90) 325 d	09/06→12/11	M57 306D3				18
3 (E90) 330 d, 3 (E90) 330 xd	09/05→12/11		6cyl.			
3 Coupe (E92) 330 d,	09/06→		2993cc	170kW (231PS)		
3 Coupe (E92) 330 xd,		Diesel	Turbo Intercooled			
3 Touring (E91) 325 d						
3 Touring (E91) 330 d,	09/05→					
3 Touring (E91) 330 xd						
5 (E60) 525 d, 5 (E60) 525 xd	01/07→03/10					
5 (E60) 530 d	07/03→03/10					
5 (E60) 530 xd	07/05→03/10					
5 Touring (E61) 525 d,	01/07→					
5 Touring (E61) 525 xd						
5 Touring (E61) 530 d,	07/05→					
5 Touring (E61) 530 xd, 7 (E65, E66) 730 Ld						
X5 (E70) 3.0 d	02/07→09/08				TD18985	

3 Convertible (E93) 325 d,	03/07→	M57 D30 (306D3)			
3 Convertible (E93) 330 d			6cyl.		
5 (E60) 525 d xDrive	09/08→03/10		2993cc	145-173kW (197-235PS)	
5 (E60) 530 d	07/03→03/10	Diesel	Turbo Intercooled		
5 Touring (E61) 525 d xDrive,	09/08→				
5 Touring (E61) 530 d xDrive					
X5 (E70) 3.0 d	02/07→09/08				TD27267

3 (E90) 330 d	01/09→12/11	M57 N2306D3			
3 Convertible (E93) 330 d	01/09→		6cyl.		
3 Coupe (E92) 325 d	04/10→		2993cc	150-180kW (204-245PS)	
3 Coupe (E92) 330 d, 3 Coupe (E92) 330 xd	01/09→	Diesel	Turbo Intercooled		
3 Touring (E91) 325 d	04/10→				
3 Touring (E91) 330 d,	01/09→				
3 Touring (E91) 330 d xDrive					
5 (E60) 530 d xDrive	09/08→03/10				
X3 (E83) xDrive 30 d	09/08→				
X6 (E71, E72) 30 d	05/08→				
X6 (E71, E72) xDrive 30 d	09/10→				TD24615





3 (E90) 330 d, 3 (E90) 330 xd	09/05→12/11	M57 TU2D30 Euro 4	
3 Convertible (E93) 325 d,	03/07→	6cyl.	
3 Convertible (E93) 330 d,		2993cc 145-173kW (197-235PS)	
3 Coupe (E92) 325 d		Diesel Turbo Intercooled	
3 Coupe (E92) 330 d,	09/06→		
3 Coupe (E92) 330 xd,			
3 Touring (E91) 325 d			
3 Touring (E91) 330 xd	09/05→		TD20843

08-421800-00 1 2 STD	84.00	2.500		001 GDC P	KV1
		2.000		023 P	F12/F14
		2.000		231 LKZ CR P	KV1

1 For Mahle OE piston

1 Für OE-Kolben von Mahle

1 Pour les pistones d'origine Mahle

1 Para pistones originales Mahle

2 TU2

2 TU2

2 TU2

2 TU2

5 (E60) 535 d	09/04→03/10	M57 306D4	
5 Touring (E61) 535 d	09/04→	6cyl.	
		2993cc 200kW (272PS)	19
		Diesel Bi-Turbo Intercooled	TD18035

7 (E65, E66) 730 d	10/02→	M57 N2306D2 Euro 4	
X3 (E83) 3.0 d	01/04→	6cyl.	
		2993cc 160kW (218PS)	
		Diesel Turbo Intercooled	TD20589

X5 (E53) 3.0 d	12/03→	M57 N306D4	
		6cyl.	
		2993cc 160kW (218PS)	
		Diesel Turbo Intercooled	TD18306

5 (E60) 530 d	07/03→03/10	N57 306D2 Euro 4	
5 Touring (E61) 530 d	06/04→	6cyl.	
		2993cc 160kW (218PS)	
		Diesel Turbo Intercooled	TD18307

7 (E65, E66) 730 Ld	07/05→	N57 N306D2	
		6cyl.	
		2993cc 170kW (231PS)	
		Diesel Turbo Intercooled	TD20592

08-114400-40 STD	84.00	3.000		008 CK P	KV1
		2.000		026 P	STD
		2.000		231 CK P	KV1
08-421800-00 1 2 STD	84.00	2.500		001 GDC P	KV1
		2.000		023 P	F12/F14
		2.000		231 LKZ CR P	KV1

1 For Mahle OE piston

1 Für OE-Kolben von Mahle

1 Pour les pistones d'origine Mahle

1 Para pistones originales Mahle

2 TU2

2 TU2

2 TU2

2 TU2



3 (E46) 330 d, 3 (E46) 330 xd	03/03→02/05	M57 N306D2 Euro 4	20
3 Convertible (E46) 330 Cd	08/05→	6cyl.	
3 Coupe (E46) 330 Cd	03/03→	2993cc 150kW (204PS)	
3 Touring (E46) 330 d,	03/03→02/05	Diesel Turbo Intercooled	
3 Touring (E46) 330 xd			
7 (E65, E66) 730 d	10/02→		
X5 (E53) 3.0 d	08/04→		TD17525

08-114400-40	STD	84.00	3.000		008 CK P	KV1
08-114405-40	0.25mm		2.000		026 P	STD
			2.000		231 CK P	KV1
08-114400-55 ¹	STD	84.00	2.500		001 CK P	KV1
			2.000		026 P	STD
			3.000		231 CR P	GOE13

¹ For Mahle OE piston

¹ Für OE-Kolben von Mahle

¹ Pour les pistons d'origine Mahle

¹ Para pistones originales Mahle

5 (E34) 530 i V8	09/92→09/95	M60 B30	21
5 Touring (E34) 530 i V8	09/92→01/97	V8cyl.	
7 (E32) 730 i, iL V8	04/92→09/94	2997cc 160kW (218PS)	
7 (E38) 730 i, iL	10/94→11/01		

08-704800-00	STD	84.00	1.500		001 P	F12/F14
			1.500		026 P	STD
			3.000		236 P	STD

5 (E39) 535 i	04/96→03/99	M62 B35	22
7 (E38) 735 i, iL	01/96→11/01	V8cyl.	
		3498cc 173kW (235PS)	TD21243

5 (E39) 535 i	04/99→06/03	M62 B35TU	22
		V8cyl.	
		3498cc 175-180kW (238-245PS)	TD21244

08-109900-00	STD	84.00	1.500		001 P	F12/F14
04/1996→09/1998			1.500		026	STD
			2.000		712 CR	ST
08-110700-00	STD	84.00	1.500		001 NT	ST
09/1998→			1.500		026 P	STD
			2.000		712 CR	ST

7 (E32) 750 i, iL V12	09/87→09/94	M70 B50	23
8 (E31) 850 i, Ci	04/90→10/94	V12cyl.	
		4988cc 220kW (299PS)	TD4236

08-702800-00	STD	84.00	1.750		001 IF CR P	KV1
			1.750		026 P	STD
			3.000		231 CR P	STD



1 (F20) 125 i	08/11→	N20 B20A				24
1 (F21) 125 i	12/11→		4cyl.			
3 (F30) 320 i	02/12→		1997cc	180kW (245PS)		
3 (F30) 320 i xDrive	11/11→		Turbo Intercooled			
3 (F30) 328 i, 3 (F30) 328 i xDrive	10/11→					
3 Gran Turismo (F34) 320 i,	03/13→					
3 Gran Turismo (F34) 320 i xDrive,						
3 Gran Turismo (F34) 328 i,						
3 Gran Turismo (F34) 328 i xDrive						
3 Touring (F31) 328 i,	06/12→					
3 Touring (F31) 328 i xDrive						
4 Coupe (F32) 428 i,	07/13→					
4 Coupe (F32) 428 i xDrive						
5 (F10) 520 i, 5 (F10) 528 i,	09/11→					
5 (F10) 528 i xDrive,						
5 Touring (F11) 520 i,						
5 Touring (F11) 528 i,						
5 Touring (F11) 528 i xDrive,						
X1 (E84) sDrive 20 i,						
X1 (E84) xDrive 20 i						
X1 (E84) xDrive 28 i	04/11→					
X3 (F25) xDrive 20 i	09/11→					
X3 (F25) xDrive 28 i	08/11→					
Z4 (E89) sDrive 18 i	04/13→					
Z4 (E89) sDrive 20 i,	09/11→					
Z4 (E89) sDrive 28 i						
						TD25629

3 Gran Turismo (F34) 320 i,	03/13→	N20 B20B				
3 Gran Turismo (F34) 320 i xDrive			4cyl.			
3 Touring (F31) 320 i,	06/12→		1997cc	135kW (184PS)		
3 Touring (F31) 320 i xDrive			Turbo Intercooled			
						TD26908

3 (F30) 328 i, 3 (F30) 328 i xDrive	10/11→	N26 B20A				
			4cyl.			
			1997cc	180kW (245PS)		
			Turbo Intercooled			
						TD26337

08-434600-00	STD	84.00	1.200		001 NT	ST
			1.500		026 P	F12/F14
			2.000		712 NT	ST

3 (E46) 316 i	02/02→02/05	N42 B18				25
3 Compact (E46) 316 ti	06/01→02/05		4cyl.			
3 Touring (E46) 316 i	03/02→02/05		1796cc	85kW (116PS)		
						TD17054

08-429800-00	STD	84.00	1.200		001 NT	ST
			1.500		026 P	GOE12
			2.000		712 CR	ST



3 (E46) 316 i	06/02→02/05	N45 B16			26	
3 (E90) 316 i	02/06→12/11		4cyl.			
3 Touring (E46) 316 i	06/02→02/05		1596cc	85kW (116PS)		
TD21404						
1 (E81) 116 i	03/07→09/12	N45 B16A				
1 (E87) 116 i	11/03→09/12		4cyl.			
3 (E46) 316 i	06/02→02/05		1596cc	85kW (116PS)		
3 (E90) 316 i	02/06→12/11					
3 Compact (E46) 316 ti	06/02→02/05					
3 Coupe (E46) 316 Ci	06/02→					
3 Touring (E46) 316 i	06/02→02/05					
TD18358						
3 (E46) 318 i	09/01→02/05	N46 B20				
3 (E90) 318 i	09/05→03/07		4cyl.			
3 (E90) 320 i	01/05→03/07		1995cc	95-110kW (129-150PS)		
3 Convertible (E46) 318 Ci	09/01→					
3 Convertible (E93) 320 i	03/07→08/07					
3 Coupe (E46) 318 Ci	09/01→					
3 Touring (E46) 318 i	09/01→02/05					
3 Touring (E91) 318 i	01/06→					
3 Touring (E91) 320 i	09/05→					
X3 (E83) 2.0 i	07/05→					
Z4 (E85) 2.0 i	04/05→					
TD21406						
1 (E87) 120 i	11/03→09/12	N46 B20A				
3 (E46) 318 i	09/01→02/05		4cyl.			
3 (E90) 320 i	01/05→03/07		1995cc	110kW (150PS)		
3 Compact (E46) 318 ti	09/01→02/05					
3 Coupe (E46) 318 Ci	03/05→					
3 Coupe (E92) 320 i	11/06→06/07					
3 Touring (E46) 318 i	09/01→02/05					
3 Touring (E91) 320 i	09/05→					
X3 (E83) 2.0 i	07/05→					
Z4 (E85) 2.0 i	04/05→					
TD18167						
1 (E81) 118 i, 1 (E81) 120 i	09/06→09/12	N46 B20B				
1 (E87) 118 i	07/04→09/12		4cyl.			
1 (E87) 120 i	11/03→09/12		1995cc	95kW (129PS)		
1 Convertible (E88) 118 i	09/08→					
1 Convertible (E88) 120 i	03/08→					
1 Coupe (E82) 120 i	09/09→					
3 (E90) 318 i	09/05→03/07					
3 Convertible (E46) 318 Ci	02/05→					
3 Touring (E91) 318 i	01/06→					
5 (E60) 520 i	04/06→12/09					
X1 (E84) sDrive 18 i	03/09→					
X3 (E83) xDrive 20 i	09/08→					
TD18945						
1 (E87) 120 i	11/03→09/12	N46 B20BD				
			4cyl.			
			1995cc	95-125kW (129-170PS)		
TD27479						
1 (E81) 120 i	09/06→09/12	N46 B20C				
1 (E87) 120 i	11/03→09/12		4cyl.			
1 Convertible (E88) 120 i	03/08→		1995cc	110kW (150PS)		
3 (E90) 320 i	01/05→03/07					
3 Touring (E91) 320 i	09/05→					
TD18168						
1 (E87) 120 i	11/03→09/12	N46 B20CC				
			4cyl.			
			1995cc	95-125kW (129-170PS)		
TD27476						
1 (E87) 120 i	11/03→09/12	N46 B20CD				
			4cyl.			
			1995cc	95-125kW (129-170PS)		
TD27477						





3 Convertible (E93) 320 i		03/07→08/07	N46 NB20B				
3 Coupe (E92) 320 i		11/06→06/07		4cyl.			
				1995cc	110kW (150PS)		
TD20962							
08-425700-00	STD	84.00	1.200		001 NT		ST
08-425707-00	0.50mm		1.500		026 P		GOE13
11/2005→			2.000		712 NT		ST
27							
1 (E81) 116 d		11/08→09/12	N47 D2 A				
1 (E81) 118 d, 1 (E81) 120 d		09/06→09/12		4cyl.			
1 (E87) 116 d		12/08→09/12		1995cc	85-120kW (116-163PS)		
1 (E87) 118 d, 1 (E87) 120 d		11/03→09/12		Diesel	Turbo Intercooled		
1 Convertible (E88) 118 d		09/08→					
1 Convertible (E88) 120 d		03/08→					
1 Coupe (E82) 120 d		10/07→					
3 (E90) 318 d		09/05→12/11					
3 (E90) 320 d		09/07→12/11					
3 Convertible (E93) 320 d,		03/07→					
3 Coupe (E92) 320 d, 3 Coupe (E92) 320 xd							
3 Touring (E91) 318 d		09/07→					
3 Touring (E91) 320 d		09/05→					
3 Touring (E91) 320 xd		09/07→					
5 (E60) 520 d		07/05→03/10					
5 Touring (E61) 520 d		07/05→					
X3 (E83) 2.0 d		09/07→					TD19922
1 (E81) 123 d, 1 (E87) 123 d		03/07→09/12	N47 D20B				
1 Convertible (E88) 123 d		09/08→		4cyl.			
1 Coupe (E82) 123 d		10/07→		1995cc	150kW (204PS)		
				Diesel	Bi-Turbo Intercooled		TD20845





1 (E81) 116 d	11/08→09/12	N47 D20C	
1 (E81) 118 d, 1 (E81) 120 d	09/06→09/12		4cyl.
1 (E87) 116 d	01/11→12/11		1995cc 85-135kW (116-184PS)
1 (E87) 118 d, 1 (E87) 120 d	11/03→09/12	Diesel	Turbo Intercooled
1 (F20) 116 d, 1 (F20) 118 d,	12/10→		
1 (F20) 120 d			
1 (F20) 120 d xDrive	02/12→		
1 (F21) 116 d	01/12→		
1 (F21) 118 d	12/11→		
1 (F21) 118 d xDrive	05/13→		
1 (F21) 120 d	07/12→		
1 (F21) 120 d xDrive	02/12→		
1 Convertible (E88) 118 d	09/08→		
1 Convertible (E88) 120 d	03/08→		
1 Coupe (E82) 118 d	09/09→		
1 Coupe (E82) 120 d	10/07→		
3 (E90) 316 d	07/09→12/11		
3 (E90) 318 d	09/05→12/11		
3 (E90) 320 d	01/05→12/11		
3 (E90) 320 d xDrive	07/08→12/11		
3 (E90) 320 xd	09/07→12/11		
3 (F30) 316 d, 3 (F30) 318 d	02/12→		
3 (F30) 318 d xDrive	11/12→		
3 (F30) 320 d, 3 (F30) 320 d xDrive	10/11→		
3 Convertible (E93) 320 d	01/08→		
3 Coupe (E92) 320 d	01/10→		
3 Coupe (E92) 320 d xDrive	09/08→		
3 Gran Turismo (F34) 318 d,	03/13→		
3 Gran Turismo (F34) 320 d,			
3 Gran Turismo (F34) 320 d xDrive			
3 Touring (E91) 316 d	09/09→		
3 Touring (E91) 318 d	07/07→		
3 Touring (E91) 320 d	09/05→		
3 Touring (E91) 320 d xDrive	09/08→		
3 Touring (F31) 316 d,	06/12→		
3 Touring (F31) 318 d			
3 Touring (F31) 318 d xDrive	01/13→		
3 Touring (F31) 320 d,	06/12→		
3 Touring (F31) 320 d xDrive			
4 Coupe (F32) 420 d	07/13→		
5 (E60) 520 d	07/05→03/10		
5 (F10) 518 d	01/13→		
5 (F10) 520 d	03/10→		
5 (F10) 520 d xDrive	02/13→		
5 Gran Turismo (F07) 520 d	10/11→		
5 Touring (E61) 520 d	07/05→		
5 Touring (F11) 518 d	01/13→		
5 Touring (F11) 520 d	09/10→		
5 Touring (F11) 520 d xDrive	02/13→		
X1 (E84) sDrive 16 d	04/12→		
X1 (E84) sDrive 18 d	03/09→		
X1 (E84) sDrive 20 d	10/09→		
X1 (E84) xDrive 18 d	03/09→		
X1 (E84) xDrive 20 d	10/09→		
X3 (E83) xDrive 18 d,	09/08→		
X3 (E83) xDrive 20 d			
X3 (F25) sDrive 18d	08/11→		
X3 (F25) xDrive 20 d	09/10→		

TD24405





X1 (E84) xDrive 23 d		10/09→	N47 SD20D		4cyl. 1995cc 150kW (204PS)	
			Diesel Bi-Turbo Intercooled			TD24642
08-432200-00	STD	84.00	1.750		001 GDC P	KV4
			1.750		026 P	F12/F14
			2.000		231 LKZ CR	ST
Z3 (E36) 1.9		07/98→01/03	M43 194E1		4cyl. 1895cc 85-87kW (116-118PS)	28
						TD18439
3 (E46) 318 i		02/98→09/01	M43 B19		4cyl. 1895cc 87kW (118PS)	
3 Coupe (E46) 318 Ci		11/99→09/01				
3 Touring (E46) 318 i		10/99→09/01				
Z3 (E36) 1.9		07/98→01/03				TD13608
3 (E46) 318 i		02/98→09/01	M43 B19TU		4cyl. 1895cc 77-87kW (105-118PS)	
3 Touring (E46) 318 i		10/99→09/01				
Z3 (E36) 1.9		07/98→01/03				TD21238
08-142200-00	STD	85.00	1.200		001 CK	ST
			1.500		026 P	GOE13
			2.000		712 CR	ST
3 (E36) 318 is		09/95→02/98	M44 B19		4cyl. 1895cc 103kW (140PS)	29
3 Compact (E36) 318 ti		07/95→08/00				
3 Coupe (E36) 318 is		09/95→04/99				
Z3 (E36) 1.9		10/95→03/99				TD4226
08-137200-00	STD	85.00	1.200		001 NT	ST
			1.500		026 P	GOE13
			2.000		712 CR	ST
			N51 B30A		6cyl. 2996cc 172kW (234PS)	30
						TD25630
3 (E90) 330 i		01/05→12/11	N52 B30		6cyl. 2996cc 190-200kW (258-272PS)	
3 Touring (E91) 330 i		09/05→				
5 (E60) 530 i		07/05→03/10				
5 Touring (E61) 530 i		07/05→				
6 (E63) 630 i, 6 Convertible (E64) 630 i		09/04→				
7 (E65, E66) 730 i, Li		03/05→				
X5 (E70) 3.0 si		02/07→09/08				
Z4 (E85) 3.0 si		01/06→				
Z4 Coupe (E86) 3.0 si		03/06→				TD21409





1 (E81) 130 i	09/06→09/12	N52 B30A		
1 (E87) 130 i	03/05→09/12		6cyl.	
1 Convertible (E88) 125 i	03/08→		2996cc	190-195kW (258-265PS)
3 (E90) 330 i, 3 (E90) 330 xi	01/05→12/11			
3 Coupe (E92) 330 i, 3 Coupe (E92) 330 xi	09/06→			
3 Touring (E91) 330 i,	09/05→			
3 Touring (E91) 330 xi				
5 (E60) 530 i	03/05→03/10			
5 (E60) 530 xi	07/05→03/10			
5 Touring (E61) 530 i,	07/05→			
5 Touring (E61) 530 xi				
6 (E63) 630 i, 6 Convertible (E64) 630 i	09/04→			
7 (E65, E66) 3.0 730 i, Li, 7 (E65, E66) 730 i, Li	03/05→			
7 (F01, F02, F03, F04) 730 i	06/08→			
X1 (E84) xDrive 25 i	01/10→			
X1 (E84) xDrive 28 i	10/09→			
X3 (E83) 3.0 si	09/06→			
X3 (E83) xDrive 30 i	09/08→			
X3 (F25) xDrive 28 i	04/11→			
X5 (E70) 3.0 si	02/07→09/08			
X5 (E70) xDrive 30 i	09/08→03/10			
Z4 (E85) 3.0 si	01/06→			
Z4 (E89) sDrive 30 i	05/09→			
Z4 Coupe (E86) 3.0 si	03/06→			TD18170
1 (E87) 130 i	03/05→09/12	N52 B30AF		
			6cyl.	
			2996cc	160-200kW (218-272PS)
				TD27482
1 (E81) 130 i	09/06→09/12	N52 B30B		
1 (E87) 130 i	03/05→09/12		6cyl.	
			2996cc	190-195kW (258-265PS)
				TD26670
1 (E81) 130 i	09/06→09/12	N52 B30BF		
1 (E87) 130 i	03/05→09/12		6cyl.	
7 (F01, F02, F03, F04) 730 i	06/08→		2996cc	190kW (258PS)
				TD26306
3 (E90) 328 i	07/05→11/07	N52 NB30A		
3 Coupe (E92) 328 i	08/06→11/07		6cyl.	
			2996cc	187kW (254PS)
				TD20582
3 (E90) 325 i, 3 (E90) 330 i	09/07→12/11	N53 B30		
3 Convertible (E93) 325 i,	03/07→		6cyl.	
3 Convertible (E93) 330 i			2996cc	160-200kW (218-272PS)
3 Coupe (E92) 325 i	09/07→			
3 Coupe (E92) 330 i	09/06→			
3 Touring (E91) 325 i,	09/07→			
3 Touring (E91) 330 i				
5 (E60) 525 i, 5 (E60) 530 i	01/07→03/10			
5 Touring (E61) 525 i,	01/07→			
5 Touring (E61) 530 i				
6 (E63) 630 i, 6 Convertible (E64) 630 i	07/07→			TD21410





1 Coupe (E82) 125 i	10/07→	N53 B30A		
3 (E90) 325 i	09/07→12/11		6cyl.	
3 (E90) 325 i xDrive	09/08→12/11		2996cc	160-200kW (218-272PS)
3 (E90) 325 xi, 3 (E90) 330 i	09/07→12/11			
3 (E90) 330 i xDrive	09/08→12/11			
3 (E90) 330 xi	09/07→12/11			
3 Convertible (E93) 325 i,	03/07→			
3 Convertible (E93) 330 i				
3 Coupe (E92) 325 i	09/07→			
3 Coupe (E92) 325 i xDrive	09/08→			
3 Coupe (E92) 325 xi	09/07→			
3 Coupe (E92) 330 i	09/06→			
3 Coupe (E92) 330 i xDrive	09/08→			
3 Touring (E91) 325 i	09/07→			
3 Touring (E91) 325 i xDrive	09/08→			
3 Touring (E91) 325 xi	09/07→			
3 Touring (E91) 330 i xDrive	09/08→			
3 Touring (E91) 330 xi	09/07→			
5 (E60) 525 i	01/07→03/10			
5 (E60) 525 i xDrive	09/08→03/10			
5 (E60) 525 xi, 5 (E60) 530 i	01/07→03/10			
5 (E60) 530 i xDrive	09/08→03/10			
5 (E60) 530 xi	01/07→03/10			
5 (F10) 523 i, 5 (F10) 528 i	03/10→			
5 (F10) 530 i	09/11→			
5 Touring (E61) 525 i	01/07→			
5 Touring (E61) 525 i xDrive	09/08→			
5 Touring (E61) 525 xi,	01/07→			
5 Touring (E61) 530 i				
5 Touring (E61) 530 i xDrive	09/08→			
5 Touring (E61) 530 xi	01/07→			
5 Touring (F11) 523 i,	09/10→			
5 Touring (F11) 528 i				
5 Touring (F11) 530 i	09/11→			TD20585

08-427300-00	STD	85.00	1.200		001 NT	ST
			1.500		026 P	F12/F14
			2.000		712 NT	ST

2500	10/68→04/77	M30 B25 (32/40)		
5 (E12) 525	08/73→05/81		6cyl.	
7 (E23) 725 i	07/77→06/86		2494cc	107-110kW (145-150PS)
2000-3.2 Coupe (E9) 2.5 CS	09/74→03/76			TD5204

31

5 (E12) 528	01/75→08/77	M30 B28 (32/40 INAT)		
5 (E12) 528 i	04/77→05/81		6cyl.	
5 (E28) 528 i	06/81→12/87		2788cc	121kW (165PS)
6 (E24) 628 CSi	09/79→08/87			
7 (E23) 728	05/77→08/79			
7 (E23) 728 i	07/78→08/86			
2000-3.2 Coupe (E9) 2800 CS	01/69→04/71			
2500-3.3 (E3) 2.8 L	02/75→04/77			
2500-3.3 (E3) 2800	10/68→07/75			TD5215

08-129500-00	STD	86.00	1.750		001 IF CR P	KV1
08-129505-00	0.25mm		2.000		026 P	STD
08-129507-00	0.50mm		4.000		231 P	STD



02 (E10) 1802, 02 Touring (E6) 1802	05/71→07/75	M10 B18								
3 (E21) 316	09/80→08/82		4cyl.						32	
3 (E21) 318	08/75→08/80		1766cc		66kW (89PS)					
3 (E21) 318 i	11/79→08/82									
3 (E30) 316	09/82→12/87									
3 (E30) 316 (Ecotronic)	09/83→12/90									
3 (E30) 316 i	08/87→08/88									
3 (E30) 318 i	09/82→08/88									
5 (E12) 518	07/74→05/81									
5 (E28) 518	06/81→08/84									
5 (E28) 518 i	09/83→12/87									
1500- 2000	01/70→11/72									
1500-2000 1800	07/69→09/71									
										TD5174

530i	01/73→12/78	M30 B30E							
630 CSi	01/76→12/78		6cyl.						
730 i	09/86→		2988cc						
			Injection						FM6600

2000-3.2 Coupe (E9) 3.2 CSL	01/74→12/75	M30 B32							
			6cyl.						
			3153cc		152kW (207PS)				
									TD5208

08-132900-00	STD	89.00	1.750		001 IF CR P		KV1
08-132905-00	0.25mm		2.000		026 P		STD
08-132907-00	0.50mm		4.000		231 CR P		STD
[R45900]							

5 (E34) 530 i	01/88→08/91	M30 B30							
6 (E24) 630 CS	04/76→08/79		6cyl.						33
7 (E23) 730	05/77→08/79		2988cc		145kW (197PS)				
7 (E32) 730 i, iL	12/86→09/94								
2000-3.2 Coupe (E9) 3.0 CS	05/71→03/76								
2000-3.2 Coupe (E9) 3.0 Csi	07/71→03/76								
2500-3.3 (E3) 3.0 L	02/75→04/77								
2500-3.3 (E3) 3.0 S	05/71→04/77								
2500-3.3 (E3) 3.0 Si	07/71→04/77								

08-700200-00	STD	89.00	1.500		001 IF CR P		KV1
			2.000		026 P		STD
			3.500		712 CR		ST

5 (E34) 540 i V8	09/92→09/95	M60 B40							
5 Touring (E34) 540 i	09/93→01/97		V8cyl.						34
7 (E32) 740 i, iL V8	04/92→09/94		3982cc		210kW (286PS)				
7 (E38) 740 i, iL	10/94→11/01								
8 (E31) 840 i	02/93→02/96								
									TD4233

08-127300-00	STD	89.00	1.500		001 P		F12/F14
			1.500		026 P		GOE13
			2.000		712		ST



5 (E28) 535 i, M 535 i	01/85→12/87	M30 B35					
5 (E34) 535 i	01/88→09/95		6cyl.				35
6 (E24) 635 CSi	04/85→09/90		3430cc	185kW (252PS)			
7 (E23) 745 i	05/83→08/86						
7 (E32) 735 i, iL	09/86→09/92						TD4221
5 (E28) 535 i, M 535 i	01/85→12/87	M30 B35					
7 (E23) 735 i	04/85→08/86		6cyl.				
			3430cc	141-162kW (192-220PS)			
							TD5272
7 (E32) 735 i, iL	09/86→12/87	M30 B35					
			6cyl.				
			3430cc	162kW (220PS)			
							TD5278

08-133900-00	STD	92.00	1.500		001 IF CR P	KV1
08-133907-00	0.50mm		2.000		026 P	STD
			3.500		231 CR P	STD

5 (E39) 540 i	04/96→06/03	M62 B 44					
5 Touring (E39) 540 i	01/97→05/04		V8cyl.				36
7 (E38) 740 i, iL	01/96→11/01		4398cc	210-255kW (286-347PS)			
8 (E31) 840 Ci	01/96→12/99						
X5 (E53) 4.4 i	05/00→						TD4235
08-109600-00	STD	92.00	1.500		001	F12/F14	
			1.500		026 P	STD	
			2.000		712	ST	

5 (E60) 545 i	09/03→03/10	N62 B44					
5 Touring (E61) 545 i	06/04→		V8cyl.				37
6 (E63) 645 Ci	01/04→		4398cc	240kW (326PS)			
6 Convertible (E64) 645 Ci	04/04→						
7 (E65, E66) 745 i, Li	11/01→						
X5 (E53) 4.4 i	12/03→						TD16268
08-432600-00	STD	92.00	1.200		001 NT	ST	
			1.500		026 P	F12/F14	
			2.000		712 NT	ST	



5 (E12) M 3.4	06/80→08/81	M30 B35	6cyl.	3453cc	160kW (218PS)	38
6 (E24) 635 CSi	06/78→08/88					
7 (E23) 735 i	09/79→08/86					
TD447						

6 (E24) 635 CSi	06/78→08/88	M30 B35	6cyl.	3453cc	160kW (218PS)	TD5245
-----------------	-------------	---------	-------	--------	---------------	---------------

08-133300-10 STD 07/1978→05/1981	93.40	1.750		001 IF MOL P	KV1
		2.500		026 MO P	IKA
		4.000		231 CR P	STD
08-700100-00 STD 07/1978→05/1981	93.40	1.500		001 IF CR P	KV1
		2.000		026	STD
		3.500		712 CR	ST

3 (E30) 320 is	05/88→12/90	S14 B20	4cyl.	1990cc	141kW (192PS)	39
TD18440						

3 (E30) M3 2.3	02/87→05/89	S14 B23	4cyl.	2303cc	147kW (200PS)	TD470
----------------	-------------	---------	-------	--------	---------------	--------------

3 (E30) M3 2.3	07/86→06/91	S14 B23	4cyl.	2303cc	143-162kW (195-220PS)	TD4238
3 Convertible (E30) M3 2.3	06/88→06/91					

6 (E24) M 635 CSi	10/86→10/88	S38 B35 (Kat)	6cyl.	3453cc	191kW (260PS)	TD5250
-------------------	-------------	---------------	-------	--------	---------------	---------------

08-704400-00 STD	93.40	1.500		001 IF MOL P	KV1
		1.500		026 P	IKA
		3.000		231 CR P	STD

MODEL INDEX

Modelverzeichnis • Index de modele • Índice de Modelo
Indeks modelu • Модель автомобиля • دليل المحرك



CCM

x



9

01/92→	R	R246 Boxer	Petrol	797	2	4
01/69→12/78	R60/5		Petrol	599	2	1
01/69→12/78	R60/6		Petrol	599	2	1
01/69→12/78	R60/7		Petrol	599	2	1
01/69→12/78	R60T/C		Petrol	599	2	1
01/69→	R65		Petrol	650	2	2
08/80→	R65LS		Petrol	650	2	2
08/80→	R65T		Petrol	650	2	2
01/69→12/77	R75/5		Petrol	746	2	3
01/69→12/77	R75/6		Petrol	746	2	3
01/69→12/77	R75/7		Petrol	746	2	3
01/69→12/77	R75C		Petrol	746	2	3
01/69→12/77	R75T		Petrol	746	2	3
01/77→	R80	R246 Boxer	Petrol	797	2	4
01/92→	R80 GS	R246 Boxer	Petrol	797	2	4
01/92→	R80 RT	R246 Boxer	Petrol	797	2	4
01/77→	R80C	R246 Boxer	Petrol	797	2	4
01/77→	R80T	R246 Boxer	Petrol	797	2	4
01/73→12/80	R90/6	900	Petrol	898	2	5
01/73→12/80	R90S	900	Petrol	898	2	5
01/76→12/85	R100RS	R246 Boxer	Petrol	980	2	6
01/76→12/85	R100RT	R246 Boxer	Petrol	980	2	6
01/76→12/85	R100S	R246 Boxer	Petrol	980	2	6
01/76→12/85	R100T	R246 Boxer	Petrol	980	2	6

ENGINE INDEX

Motorverzeichnis • Index de moteur • Índice de Motor
Indeks silnika • Модель двигателя • دليل المحرك



CCM

x



9

	Petrol	599	2	73.50	1
	Petrol	650	2	82.00	2
	Petrol	746	2	82.00	3
900	Petrol	898	2	90.00	5
R246 Boxer	Petrol	797	2	84.80	4
R246 Boxer	Petrol	980	2	94.00	6



R60/5, R60/6, R60/7, R60T/C		01/69→12/78		2cyl. 599cc		29kW (39PS)	1
FM5824							
08-700000-00	STD	73.50	1.750		001 IF CR P		KV1
			2.000		023 P		STD
			4.000		032 P		STD

R65		01/69→		2cyl.			2
R65LS, R65T		08/80→		650cc		33kW (45PS)	
FM5825							
08-700300-00	STD	82.00	1.750		001 IF P		IKA
			2.000		023 P		STD
			4.000		032 P		STD
08-700400-00 08-700411-00	STD 1.00mm	82.00	1.750		001 IF CR		KV1
			2.000		023 P		STD
			4.000		032 P		STD

R75/5, R75/6, R75/7, R75C, R75T		01/69→12/77		2cyl.			3
				746cc		37-44kW (50-60PS)	
FM5827							
08-700400-00 08-700411-00	STD 1.00mm	82.00	1.750		001 IF CR		KV1
			2.000		023 P		STD
			4.000		032 P		STD

R		01/92→		R246 Boxer			4
R80		01/77→		2cyl.			
R80 GS, R80 RT		01/92→		797cc		37-40kW (50-55PS)	
R80C, R80T		01/77→					
FM5829							
08-701100-00	STD	84.80	1.750		001 IF CR P		KV1
			2.000		026 P		STD
			4.000		032 P		STD
08-701200-00	STD	84.80	1.750		006 IF P		IKA
			2.000		026 P		STD
			4.000		232 P		STD



R90/6, R90S		01/73→12/80	900		2cyl. 898cc	44-50kW (60-68PS)	5
							FM5830

08-700800-00	STD	90.00	1.750		001 IF CR P	KV1
			2.000		023 P	STD
			4.000		230 P	STD

R100RS, R100RT, R100S, R100T		01/76→12/85	R246 Boxer		2cyl. 980cc	44-51kW (60-69PS)	6
							FM5831

08-700900-00 08-700905-00 01/1979→01/1981	STD 0.25mm	94.00	1.750		001 IF CR P	KV1
			2.000		026 P	STD
			4.000		230 P	STD
08-701000-00 01/1981→	STD	94.00	1.750		006 P	IKA
			2.000		026 P	STD
			4.000		232 P	STD

Modelverzeichnis • Index de modele • Índice de Modelo
Indeks modelu • Модель автомобиля • دليل المركب

MODEL INDEX



CCM

x



9

10/86→09/92	Cherokee 2.1 D 4x4	J8S	Diesel	2068	4	6
06/89→03/92	Cherokee 2.1 TD	J8S	Diesel	2068	4	6
10/86→09/90	Comanche 2.1 D	J8S	Diesel	2068	4	6
08/11→	Delta 1.4	198 A4.000 (Turbo CNG EcoFlex)	Bi-fuel (Petrol/ Gas)	1368	4	3
08/11→	Delta 1.4 16V	198 A7.000	Petrol	1368	4	3
08/11→	Delta 1.6 D Multijet	198 A2.000 (Multijet)	Diesel	1598	4	4
08/11→	Delta 2.0 D Multijet	198 A5.000 (Multijet)	Diesel	1956	4	5
10/86→09/92	Jeep Cherokee 2.1D	J8S	Diesel	2068	4	6
01/90→12/96	Le Baron Convertible 3.0 i V6	6G72	Petrol	2972	V6	7
09/89→12/95	Saratoga 3.0	6G72	Petrol	2972	V6	7
08/05→	Voyager 2.5 CRD	R 425	Diesel	2499	4	8
01/92→09/95	Voyager II 2.5 TD	M00 (HR 425 CL)	Diesel	2499	4	10
01/91→09/95	Voyager II 3.0 i	6G72	Petrol	2972	V6	7
02/00→	Voyager III 2.5 CRD TD	RG	Diesel	2499	4	9
01/95→03/01	Voyager III 2.5 TD	ENC	Diesel	2499	4	9
01/95→03/01	Voyager III 2.5 TD	VM425HR (M51)	Diesel	2500	4	10
01/95→03/01	Voyager III 2.5 TD	VM425HS (M52)	Diesel	2500	4	10
10/95→03/01	Voyager III 2.5 TDiC AWD	ENC	Diesel	2499	4	9
08/05→12/08	Voyager IV 2.5 CRD	EDK	Diesel	2499	4	8
02/00→12/08	Voyager IV 2.5 CRD	ENC	Diesel	2499	4	9
02/00→12/08	Voyager IV 2.5 CRD	VM425HR (M51)	Diesel	2500	4	10
02/00→12/08	Voyager IV 2.5 CRD	VM425HS (M52)	Diesel	2500	4	10
05/11→	Ypsilon 1.2	169 A4.000	Petrol	1242	4	2
05/11→	Ypsilon 1.3 Multijet	199 B1.000 Euro 5	Diesel	1248	4	1

Motorverzeichnis • Index de moteur • Índice de Motor
Indeks silnika • Модель двигателя • دليل المحرك

ENGINE INDEX



CCM

x



9

6G72	Petrol	2972	V6	91.10	7
169 A4.000	Petrol	1242	4	70.80	2
198 A2.000 (Multijet)	Diesel	1598	4	79.50	4
199 B1.000 Euro 5	Diesel	1248	4	69.60	1
EDK	Diesel	2499	4	92.00	8
ENC	Diesel	2499	4	92.00	9
RG	Diesel	2499	4	92.00	9
VM425HR (M51)	Diesel	2500	4	92.00	10
VM425HS (M52)	Diesel	2500	4	92.00	10



Ypsilon 1.3 Multijet	05/11→	199 B1.000 Euro 5	1
		4cyl. 1248cc 70kW (95PS)	
		Diesel Turbo Intercooled	TD26556

08-435700-00	STD	69.60	1.500		001 GDC P	KV4
08-435706-00	0.40mm		1.500		005 P	F12/F14
			2.000		231 LKZ CR P	GOE13

Ypsilon 1.2	05/11→	169 A4.000	2
		4cyl. 1242cc 51kW (69PS)	
			TD26555

08-138400-00	STD	70.80	1.190		001 P NT	KV1
08-138406-00	0.40mm		1.200		005 P	STD
08-138408-00	0.60mm		2.500		231 P	GOE12
<i>[R66670]</i>						

Delta 1.4	08/11→	198 A4.000 (Turbo CNG EcoFlex)	3
		4cyl. 1368cc 88kW (120PS)	
		Turbo Intercooled	TD26558





Delta 1.4 16V	08/11→	198 A7.000	
		4cyl. 1368cc 103kW (140PS)	
		Turbo Intercooled	TD26559







08-438300-00	STD	72.00	1.200		021 GDC P	KV1
08-438306-00	0.40mm		1.200		026 P	GOE13
			2.000		231 LKZ CR P	GOE13



Delta 1.6 D Multijet	08/11→	198 A2.000 (Multijet)	4
		4cyl. 1598cc 88kW (120PS)	
		Diesel Turbo Intercooled	TD26557



08-429300-00	STD	79.50	2.000		001 GDC P	KV4
			1.750		026 P	F12/F14
			2.000		231 LKZ CR P	GOE13



Delta 2.0 D Multijet		08/11→	198 A5.000 (Multijet)		5
			4cyl. 1956cc 121kW (165PS)		
			Diesel Turbo Intercooled		TD26560
08-436500-00	STD	83.00	1.500	 001 GDC P	KV4
08-436506-00	0.40mm		1.500	 050 P	F12/F14
			2.000	 231 LKZ CK P	GOE13
			 		

Cherokee 2.1 D 4x4, Cherokee 2.1 TD, Comanche 2.1 D			J8S		6
Jeep Cherokee 2.1D		10/86→09/92	4cyl. 2068cc 59-64kW (80-87PS)		
			Diesel		TD4254
08-335400-00	STD	86.00	2.500	 008 P PS	KV1
[R66420]			2.500	 023 P	STD
			4.000	 231 CR P	STD
08-337100-00	STD	86.00	2.250	 001 IF P PS	KV1
[R66340]			2.000	 005 IFU P	F12/F14
			3.000	 231 CR P	STD

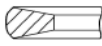
Le Baron Convertible 3.0 i V6		01/90→12/96	6G72		7
Saratoga 3.0		09/89→12/95	V6cyl. 2972cc 106kW (144PS)		
Voyager II 3.0 i		01/91→09/95			TD542
08-287600-00	STD	91.10	1.500	 001 CR P	IKA
			1.500	 005 P	STD
			4.000	 236 P	STD

Voyager IV 2.5 CRD		08/05→12/08	EDK		8
			4cyl. 2499cc 88kW (120PS)		
			Diesel		TD21953
Voyager 2.5 CRD		08/05→	R 425		
			4cyl. 2499cc		
			Diesel		FM12303
08-423100-00	STD	92.00	2.500	 008 CK P	KV1
			1.500	 026 P	IKA
			2.000	 231 NT	GOE12



CCM

x



9

02/70→10/85	2 CV 6	A06/635	Petrol	602	2	7
09/75→06/81	2 CV 6	M28/1 (AK2)	Petrol	602	2	7
08/78→10/88	Acadiane 6	M28 (AM2)	Petrol	602	2	7
01/63→05/68	Ami 6	M4 (AM)	Petrol	602	2	10
05/68→07/69	Ami 6	M28 (AM2)	Petrol	602	2	7
07/69→12/77	Ami 8	M28 (AM2)	Petrol	602	2	7
05/68→07/69	Ami Break 6	M28 (AM2)	Petrol	602	2	7
07/69→12/77	Ami Break 8	M28 (AM2)	Petrol	602	2	7
04/87→12/88	AX 1.3 Sport	TU2.4	Petrol	1294	4	14
09/86→07/92	AX 1.4 4x4	TU3FM (K2A)	Petrol	1360	4	14
06/91→07/92	AX 1.4 D 4x4	TUD3 (K9A)	Diesel	1360	4	16
	AX 1.4 GTi	TU3FJ2 (K2D)	Petrol	1360	4	14
08/91→12/96	AX 1.4 GTi	TU3FJ2 (KFY)	Petrol	1360	4	14
06/91→12/96	AX 1.4 GTi	TU3FJ2 (KFZ)	Petrol	1360	4	14
07/86→12/98	AX 10	TU9 (C1A)	Petrol	954	4	1
02/87→12/98	AX 10	TU9M (CDY/CDZ)	Petrol	954	4	1
09/86→12/97	AX 11	TU1 (H1B)	Petrol	1124	4	3
12/86→04/94	AX 11	TU1 K	Petrol	1124	4	3
09/86→12/97	AX 11	TU1M (HDZ)	Petrol	1124	4	3
06/91→07/92	AX 11 4x4	TU1 K	Petrol	1124	4	3
09/88→12/89	AX 11 CAT	TU1CP (HAZ)	Petrol	1124	4	3
	AX 14	K1B	Petrol	1360	4	14
01/89→12/91	AX 14	K1G	Petrol	1360	4	14
01/89→12/91	AX 14	TU3A (K6D)	Petrol	1360	4	14
01/89→12/91	AX 14	TU3A (K6E)	Petrol	1360	4	14
01/89→12/91	AX 14	TU3A (K6F)	Petrol	1360	4	14
12/86→12/88	AX 14	TU3CP (KAY)	Petrol	1360	4	14
06/88→12/89	AX 14	TU3F2 (K1F)	Petrol	1360	4	14
01/88→12/92	AX 14	TU3F2 (K2B)	Petrol	1360	4	14
01/88→12/92	AX 14	TU3FM (K2A)	Petrol	1360	4	14
04/87→04/97	AX 14	TU3FM (KDY)	Petrol	1360	4	14
04/87→04/97	AX 14	TU3M (KDX)	Petrol	1360	4	14
04/87→04/97	AX 14	TU3M (KDY)	Petrol	1360	4	14
04/87→04/97	AX 14	TU3M/Z (KDZ)	Petrol	1360	4	14
08/91→12/96	AX 14 4x4	TU3FM (KDY)	Petrol	1360	4	14
08/91→12/96	AX 14 4x4	TU3M (KDX)	Petrol	1360	4	14
08/91→12/96	AX 14 4x4	TU3M (KDY)	Petrol	1360	4	14
08/91→12/96	AX 14 4x4	TU3M/Z (KDZ)	Petrol	1360	4	14
09/88→06/92	AX 14 D	TUD3 (K9A)	Diesel	1360	4	16
08/91→12/97	AX 14 D	TUD3Y (K9Y)	Diesel	1360	4	16
01/89→12/91	AX 14 GT	TU3M/Z (KDZ)	Petrol	1360	4	14
08/94→12/97	AX 15 D	TUD5 (VJY)	Diesel	1527	4	18
08/94→12/97	AX 15 D	TUD5 (VJZ)	Diesel	1527	4	18
10/81→03/91	Axel 0.7	V06/644	Petrol	652	2	19
01/84→03/91	Axel 11	G11/631	Petrol	1129	4	9
07/96→	Berlingo 1.1 i	TU1JP (HFX)	Petrol	1124	4	4
07/96→	Berlingo 1.1 i	TU1M (HDZ)	Petrol	1124	4	3
11/02→	Berlingo 1.4	TU3JP (KFW)	Petrol	1360	4	15
11/02→	Berlingo 1.4 bivalent	TU3JP (KFW)	Petrol	1360	4	15
11/02→	Berlingo 1.4 GNC	TU3JP (KFW)	Petrol	1360	4	15
05/05→	Berlingo 1.4 Hybrid	TU3JP (KFW)	Petrol	1360	4	15
07/96→	Berlingo 1.4 i	TU3JP (KFW)	Petrol	1360	4	15
07/96→	Berlingo 1.4 i	TU3JP (KFX)	Petrol	1360	4	15
04/03→	Berlingo 1.4 i bivalent	TU3JP (KFW)	Petrol	1360	4	15
06/00→	Berlingo 1.4i	TU3A (KFW)	Petrol	1360	4	14
07/96→11/02	Berlingo 1.4i	TU3A (KFX)	Petrol	1360	4	14
04/08→	Berlingo 1.6	TU5JP4 (N6A)	Petrol	1587	4	20
04/08→	Berlingo 1.6	TU5JP4 (NFU/N6A)	Petrol	1587	4	20
10/00→	Berlingo 1.6 16V	TU5JP4 (N6A)	Petrol	1587	4	20
10/00→	Berlingo 1.6 16V	TU5JP4 (NFU/N6A)	Petrol	1587	4	20

MODEL INDEX

Modelverzeichnis • Index de modele • Índice de Modelo
Indeks modelu • Модель автомобиля • دليل الموديل



CCM

x



9

09/05→	Berlingo 1.6 HDI	DV6BTED4 (9HW) Euro 4	Diesel	1560	4	13
05/08→	Berlingo 1.6 HDI	DV6ETED (9HN) Euro 4	Diesel	1560	4	13
07/10→	Berlingo 1.6 HDi 110	DV6C (9HR)	Diesel	1560	4	13
08/05→	Berlingo 1.6 HDi 110	DV6TED4 (9HZ) Euro 4	Diesel	1560	4	12
07/10→	Berlingo 1.6 HDi 115	DV6C (9HR)	Diesel	1560	4	13
04/08→	Berlingo 1.6 HDi 75	DV6BTED4 (9HT) Euro 4	Diesel	1560	4	13
07/05→	Berlingo 1.6 HDI 75	DV6ETED (9HW) Euro 4	Diesel	1560	4	13
07/05→	Berlingo 1.6 HDI 90	DV6ATED4 (9HX) Euro 4	Diesel	1560	4	12
07/98→	Berlingo 1.8 D	XUD7 (A9A/161A)	Diesel	1769	4	23
05/97→	Berlingo 1.8 i	XU7JB (LFX)	Petrol	1761	4	28
04/97→	Berlingo 1.8 i 4WD	XU7JB (LFX)	Petrol	1761	4	28
07/98→	Berlingo 1.9 D	DW8 (WJZ) / DW8B (WJY)	Diesel	1868	4	26
07/98→	Berlingo 1.9 D	DW8B (WJY)	Diesel	1868	4	26
07/96→	Berlingo 1.9 D	XUD9A (DJY)	Diesel	1905	4	30
07/96→	Berlingo 1.9 D	XUD9A/L (D9B)	Diesel	1905	4	30
07/98→	Berlingo 1.9 D 4WD	DW8 (WJZ) / DW8B (WJY)	Diesel	1868	4	26
07/98→	Berlingo 1.9 D 4WD	DW8B (WJY)	Diesel	1868	4	26
11/02→10/05	Berlingo 2.0 HDi 4x4	DW10TD (RHY)	Diesel	1998	4	34
12/99→	Berlingo 2.0 HDI 90	DW10TD (RHY)	Diesel	1998	4	34
07/10→	Berlingo 90	DV6DTED (9HF) Euro 4	Diesel	1560	4	13
07/96→	Berlingo Box 1.1 i	TU1JP (HFX)	Petrol	1124	4	4
07/96→	Berlingo Box 1.1 i	TU1M (HDZ)	Petrol	1124	4	3
11/02→	Berlingo Box 1.4	TU3JP (KFW)	Petrol	1360	4	15
11/02→	Berlingo Box 1.4 bivalent	TU3JP (KFW)	Petrol	1360	4	15
07/96→	Berlingo Box 1.4 i	TU3JP (KFW)	Petrol	1360	4	15
07/96→	Berlingo Box 1.4 i	TU3JP (KFX)	Petrol	1360	4	15
04/03→	Berlingo Box 1.4 i bivalent	TU3JP (KFW)	Petrol	1360	4	15
04/08→	Berlingo Box 1.6	TU5JP4 (N6A)	Petrol	1587	4	20
04/08→	Berlingo Box 1.6	TU5JP4 (NFU/N6A)	Petrol	1587	4	20
10/00→	Berlingo Box 1.6 16V	TU5JP4 (N6A)	Petrol	1587	4	20
10/00→	Berlingo Box 1.6 16V	TU5JP4 (NFU/N6A)	Petrol	1587	4	20
07/10→	Berlingo Box 1.6 HDi 110	DV6C (9HR)	Diesel	1560	4	13
04/08→	Berlingo Box 1.6 HDi 110	DV6TED4 (9HZ) Euro 4	Diesel	1560	4	12
07/10→	Berlingo Box 1.6 HDi 115	DV6C (9HL)	Diesel	1560	4	13
04/08→	Berlingo Box 1.6 HDi 75	DV6BUTED4 (9HT) Euro 4	Diesel	1560	4	13
07/05→	Berlingo Box 1.6 HDI 75	DV6ETED (9HW) Euro 4	Diesel	1560	4	13
07/05→	Berlingo Box 1.6 HDI 90	DV6ATED4 (9HX) Euro 4	Diesel	1560	4	12
07/10→	Berlingo Box 1.6 HDi 90	DV6DTED (9HP) Euro 4	Diesel	1560	4	13
07/96→	Berlingo Box 1.8 D	XUD7 (A9A/161A)	Diesel	1769	4	23
08/99→10/02	Berlingo Box 1.8 i	XU7JB (LFX)	Petrol	1761	4	28
07/96→	Berlingo Box 1.9 D	XUD9A (DJY)	Diesel	1905	4	30
04/99→	Berlingo Box 1.9 D 70	DW8 (WJZ) / DW8B (WJY)	Diesel	1868	4	26
04/99→	Berlingo Box 1.9 D 70	DW8B (WJY)	Diesel	1868	4	26
07/98→	Berlingo Box 1.9 D 70 4WD	DW8 (WJZ) / DW8B (WJY)	Diesel	1868	4	26
07/98→	Berlingo Box 1.9 D 70 4WD	DW8B (WJY)	Diesel	1868	4	26
12/99→	Berlingo Box 2.0 HDI 90	DW10TD (RHY)	Diesel	1998	4	34
11/00→	Berlingo Box 2.0 HDI 90 4WD	DW10TD (RHY)	Diesel	1998	4	34
01/87→01/92	BX 1.6	XU5JA (B6D)	Petrol	1580	4	27
10/85→09/93	BX 1.8 D	XUD7 (161)	Diesel	1769	4	23
10/86→06/92	BX 11	TU1 K	Petrol	1124	4	3
10/88→06/92	BX 11	TU1M (HDZ)	Petrol	1124	4	3
	BX 14	KAZ	Petrol	1360	4	14
01/89→12/89	BX 14	TU3A (K1H)	Petrol	1360	4	14
01/89→02/93	BX 14	TU3M (KDY)	Petrol	1360	4	14
01/89→02/93	BX 14	TU3M/Z (KDZ)	Petrol	1360	4	14
04/83→07/89	BX 14 E	K1G	Petrol	1360	4	14
04/83→07/89	BX 14 E	TU3A (K6D)	Petrol	1360	4	14
04/83→07/89	BX 14 E	TU3A (K6E)	Petrol	1360	4	14
04/83→07/89	BX 14 E	TU3A (K6F)	Petrol	1360	4	14
09/85→02/93	BX 14 E	XY6 (150F) / XY8 (150A)	Petrol	1360	4	11

CCM
x

9

10/82→06/88	BX 14 E	XY6C (150A)	Petrol	1360	4	11
04/83→02/93	BX 14 E	XY6D (150C)	Petrol	1360	4	11
10/87→05/92	BX 15	XU51C (B1E)	Petrol	1580	4	27
10/82→06/88	BX 16	171C	Petrol	1580	4	27
10/82→06/88	BX 16	XU5 (171A)	Petrol	1580	4	27
09/87→02/93	BX 16	XU5 (B1AA)	Petrol	1580	4	27
09/88→02/93	BX 16	XU5CP (BAY/BAZ)	Petrol	1580	4	27
03/86→02/93	BX 16	XU5J (180Z)	Petrol	1580	4	27
09/88→02/93	BX 16	XU5J/J2/JA	Petrol	1580	4	27
10/82→06/88	BX 16	XU5S (171B)	Petrol	1580	4	27
07/85→02/93	BX 16	XU5S (171D)	Petrol	1580	4	27
01/87→02/93	BX 16	XU51C (B1E)	Petrol	1580	4	27
10/82→12/92	BX 16	XU52C	Petrol	1580	4	27
07/86→05/89	BX 19	XU92C (D2A)	Petrol	1905	4	28
09/86→11/89	BX 19	XU92C (D2C)	Petrol	1905	4	28
09/83→09/93	BX 19 D	XUD9 (162)	Diesel	1905	4	30
09/83→09/93	BX 19 D	XUD9 (D9A)	Diesel	1905	4	30
09/83→09/93	BX 19 D	XUD9 (DJZ)	Diesel	1905	4	30
03/87→02/93	BX 19 D	XUD9A/U (D9B)	Diesel	1905	4	30
04/89→02/93	BX 19 E 4x4	XU92C (D2F)	Petrol	1905	4	28
07/86→02/93	BX 19 GTi	XU9J2 (D6A)	Petrol	1905	4	28
06/88→02/93	BX 19 GTi	XU9JA (DKZ)	Petrol	1905	4	28
09/87→12/88	BX 19 GTi 16V	XU9J4 (D6C/DFW)	Petrol	1905	4	29
03/88→02/93	BX 19 GTi 16V	XU9J4 (DFW)	Petrol	1905	4	29
06/88→02/93	BX 19 GTi 4x4	XU9JA (DKZ)	Petrol	1905	4	28
01/87→01/92	BX Break 1.4	XY6D (150C)	Petrol	1360	4	11
01/87→01/92	BX Break 1.6	XU5JA (B6D)	Petrol	1580	4	27
02/92→12/94	BX Break 1.9 TZi	XU9J2 (D6A)	Petrol	1905	4	28
01/89→12/89	BX Break 14	TU3A (K1H)	Petrol	1360	4	14
01/89→02/93	BX Break 14	TU3M (KDY)	Petrol	1360	4	14
01/86→02/93	BX Break 14	XY6D (150C)	Petrol	1360	4	11
10/87→05/92	BX Break 15	XU51C (B1E)	Petrol	1580	4	27
04/83→01/92	BX Break 16	171C	Petrol	1580	4	27
06/85→06/88	BX Break 16	XU5 (171A)	Petrol	1580	4	27
09/88→12/94	BX Break 16	XU5CP (BAY/BAZ)	Petrol	1580	4	27
03/86→12/94	BX Break 16	XU5J (180Z)	Petrol	1580	4	27
09/88→12/94	BX Break 16	XU5J/J2/JA	Petrol	1580	4	27
06/85→06/88	BX Break 16	XU5S (171B)	Petrol	1580	4	27
07/85→12/94	BX Break 16	XU5S (171D)	Petrol	1580	4	27
09/88→12/94	BX Break 16	XU51C (B1E)	Petrol	1580	4	27
10/85→09/93	BX Break 18 D	XUD7 (161A)	Diesel	1769	4	23
06/88→12/94	BX Break 19	XU9JA (DKZ)	Petrol	1905	4	28
07/86→12/94	BX Break 19	XU92C (D2A)	Petrol	1905	4	28
12/87→12/89	BX Break 19	XU92C (D2C)	Petrol	1905	4	28
07/86→12/94	BX Break 19 CAT	XU9J1 (DFZ)	Petrol	1905	4	28
09/83→11/94	BX Break 19 D	XUD9 (162)	Diesel	1905	4	30
09/83→11/94	BX Break 19 D	XUD9 (D9A)	Diesel	1905	4	30
09/83→11/94	BX Break 19 D	XUD9 (DJZ)	Diesel	1905	4	30
03/87→12/94	BX Break 19 D	XUD9A/U (D9B)	Diesel	1905	4	30
03/88→12/94	BX Break TRD Turbo	XUD7TE (A8A)	Diesel	1769	4	24
03/88→12/94	BX Break TRD Turbo	XUD7TE (AJZ)	Diesel	1769	4	24
03/88→02/93	BX TRD Turbo	XUD7TE (A8A)	Diesel	1769	4	24
03/88→02/93	BX TRD Turbo	XUD7TE (AJZ)	Diesel	1769	4	24
06/05→	C1 1.0	1KR-FE	Petrol	998	3	2
06/05→	C1 1.0	CFA (384F)	Petrol	998	3	2
06/05→	C1 1.4 HDi	DV4TD	Diesel	1398	4	6
06/05→	C1 1.4 HDI	DV4TD (8HT)	Diesel	1398	4	6
09/03→	C2 1.1	TU1JP (HFX)	Petrol	1124	4	4
09/03→	C2 1.4	TU3JP-L4 (KfV)	Petrol	1360	4	15
09/03→	C2 1.4 HDi	DV4TD (8HX)	Diesel	1399	4	6

MODEL INDEX

Modelverzeichnis • Index de modele • Índice de Modelo
Indeks modelu • Модель автомобиля • دليل الموديل



CCM

x



9

09/03→	C2 1.6	TU5JP4 (N6A)	Petrol	1587	4	20
09/03→	C2 1.6	TU5JP4 (NFU/N6A)	Petrol	1587	4	20
09/05→	C2 1.6 HDi	DV6TED4 (9HZ) Euro 4	Diesel	1560	4	12
04/09→	C2 Enterprise 1.4 HDi	DV4TD (8HX)	Diesel	1399	4	6
	C3	DV6DBM (9HE) Euro 4	Diesel	1560	4	13
11/09→	C3	DV6ETEDM (9HK) Euro 4	Diesel	1560	4	13
02/02→	C3 1.1 i	TU1JP (HFX)	Petrol	1124	4	4
02/02→	C3 1.4 16V HDi	DV4TED4 (8HY)	Diesel	1399	4	6
02/02→	C3 1.4 HDi	DV4TD (8HX)	Diesel	1399	4	6
02/02→	C3 1.4 i	TU3JP-L4 (KFV)	Petrol	1360	4	15
02/02→	C3 1.4 i Bivalent	TU3JP-L4 (KFV)	Petrol	1360	4	15
01/02→11/02	C3 1.4i	TU3A (KFX)	Petrol	1360	4	14
02/02→	C3 1.6 16V	TU5JP4 (N6A)	Petrol	1587	4	20
02/02→	C3 1.6 16V	TU5JP4 (NFU/N6A)	Petrol	1587	4	20
10/05→	C3 1.6 16V HDi	DV6ATED4 (9HX) Euro 4	Diesel	1560	4	12
09/05→	C3 1.6 16V HDi	DV6TED4 (9HZ) Euro 4	Diesel	1560	4	12
11/09→	C3 II 1.1	TU1JP (HFX)	Petrol	1124	4	4
11/09→	C3 II 1.4	TU3A (KFT)	Petrol	1360	4	14
11/09→	C3 II 1.4	TU3A (KFV)	Petrol	1360	4	14
11/09→	C3 II 1.4 HDi 70	DV4TD (8HZ)	Diesel	1398	4	6
11/09→	C3 II 1.6 HDi	DV6DTED (9HP) Euro 4	Diesel	1560	4	13
11/09→	C3 II 1.6 HDi 110	DV6C (9HR)	Diesel	1560	4	13
11/09→	C3 II 1.6 HDi 90	DV6ATED4 (9HX) Euro 4	Diesel	1560	4	12
02/09→	C3 Picasso 1.6 HDi	DV6ATED4 (9HX) Euro 4	Diesel	1560	4	12
02/09→	C3 Picasso 1.6 HDi	DV6TED4 (9HZ) Euro 4	Diesel	1560	4	12
05/10→	C3 Picasso 1.6 HDi 110	DV6C (9HR)	Diesel	1560	4	13
01/13→	C3 Picasso 1.6 HDi 115	DV6C (9HL)	Diesel	1560	4	13
07/10→	C3 Picasso 1.6 HDi 90	DV6DTED (9HP) Euro 4	Diesel	1560	4	13
05/03→	C3 Pluriel 1.4	TU3JP-L4 (KFV)	Petrol	1360	4	15
04/04→	C3 Pluriel 1.4 HDi	DV4TD (8HX)	Diesel	1399	4	6
05/05→	C3 Pluriel 1.4 Hybrid	TU3JP-L4 (KFV)	Petrol	1360	4	15
05/03→	C3 Pluriel 1.6	TU5JP4 (N6A)	Petrol	1587	4	20
05/03→	C3 Pluriel 1.6	TU5JP4 (NFU/N6A)	Petrol	1587	4	20
11/04→	C4 1.6 16V	TU5JP4 (N6A)	Petrol	1587	4	20
11/04→	C4 1.6 16V	TU5JP4 (NFU/N6A)	Petrol	1587	4	20
09/07→	C4 1.6 16V Bio-Flex	TU5JP4 (N6A)	Petrol	1587	4	20
09/07→	C4 1.6 16V Bio-Flex	TU5JP4 (NFU/N6A)	Petrol	1587	4	20
11/04→	C4 1.6 HDi	DV6ATED4 (9HX) Euro 4	Diesel	1560	4	12
11/04→	C4 1.6 HDi	DV6TED4 (9HY)	Diesel	1560	4	12
11/04→	C4 1.6 HDi	DV6TED4 (9HZ) Euro 4	Diesel	1560	4	12
11/09→	C4 1.6 HDi 110	DV6C (9HR)	Diesel	1560	4	13
07/12→	C4 1.6 HDi 115	DV6C (9HR)	Diesel	1560	4	13
11/09→	C4 1.6 HDi 90	DV6DTED (9HP) Euro 4	Diesel	1560	4	13
07/08→	C4 2.0 HDi	DW10BTED4 (RHF)	Diesel	1997	4	34
11/04→	C4 2.0 HDi	DW10BTED4 (RHR) Euro 4	Diesel	1997	4	34
04/12→	C4 Aircross 1.6 HDi 115	DV6C (9HL)	Diesel	1560	4	13
05/12→	C4 Aircross 1.6 HDi 115 AWC	DV6C (9HL)	Diesel	1560	4	13
11/04→	C4 Coupe 1.6 16V	TU5JP4 (N6A)	Petrol	1587	4	20
11/04→	C4 Coupe 1.6 16V	TU5JP4 (NFU/N6A)	Petrol	1587	4	20
11/04→	C4 Coupe 1.6 HDi	DV6ATED4 (9HX) Euro 4	Diesel	1560	4	12
11/04→	C4 Coupe 1.6 HDi	DV6TED4 (9HY)	Diesel	1560	4	12
11/04→	C4 Coupe 1.6 HDi	DV6TED4 (9HZ) Euro 4	Diesel	1560	4	12
07/08→	C4 Coupe 2.0 HDi	DW10BTED4 (RHF)	Diesel	1997	4	34
11/04→	C4 Coupe 2.0 HDi	DW10BTED4 (RHR) Euro 4	Diesel	1997	4	34
10/06→	C4 Grand Picasso 1.6 HDi	DV6TED4 (9HY)	Diesel	1560	4	12
10/06→	C4 Grand Picasso 1.6 HDi	DV6TED4 (9HZ) Euro 4	Diesel	1560	4	12
09/10→	C4 Grand Picasso 1.6 HDi 110	DV6C (9HL)	Diesel	1560	4	13
09/10→	C4 Grand Picasso 1.6 HDi 110	DV6C (9HR)	Diesel	1560	4	13
10/06→	C4 Grand Picasso 2.0 HDi 138	DW10BTED4 (RHJ) Euro 4	Diesel	1997	4	34
10/06→	C4 Grand Picasso 2.0 HDi 138	DW10BTED4 (RHR) Euro 4	Diesel	1997	4	34



CCM

x



9

02/07→	C4 Picasso 1.6 HDi	DV6TED4 (9HY)	Diesel	1560	4	12
02/07→	C4 Picasso 1.6 HDi	DV6TED4 (9HZ) Euro 4	Diesel	1560	4	12
09/10→	C4 Picasso 1.6 HDi 110	DV6C (9HL)	Diesel	1560	4	13
09/10→	C4 Picasso 1.6 HDi 110	DV6C (9HR)	Diesel	1560	4	13
02/13→	C4 Picasso 1.6 HDi 90	DV6DTE4 (9HP) Euro 4	Diesel	1560	4	13
02/07→	C4 Picasso 2.0 HDi 138	DW10BTE4 (RHJ) Euro 4	Diesel	1997	4	34
02/07→	C4 Picasso 2.0 HDi 138	DW10BTE4 (RHR) Euro 4	Diesel	1997	4	34
07/06→	C4 Saloon 1.6 16V	TU5JP4 (N6A)	Petrol	1587	4	20
07/06→	C4 Saloon 1.6 16V	TU5JP4 (NFU/N6A)	Petrol	1587	4	20
07/06→	C4 Saloon 1.6 HDi	DV6TED4 (9HY)	Diesel	1560	4	12
07/06→	C4 Saloon 1.6 HDi	DV6TED4 (9HZ) Euro 4	Diesel	1560	4	12
09/04→	C5 1.6 HDi	DV6TED4 (9HY)	Diesel	1560	4	12
09/04→	C5 1.6 HDi	DV6TED4 (9HZ) Euro 4	Diesel	1560	4	12
07/10→	C5 1.6 HDi 110	DV6C (9HR)	Diesel	1560	4	13
01/12→	C5 1.6 HDi 115	DV6C (9HR)	Diesel	1560	4	13
03/01→08/04	C5 2.0 HDi	DW10ATED (RHS)	Diesel	1997	4	34
03/01→08/04	C5 2.0 HDi	DW10ATED (RHZ)	Diesel	1998	4	34
02/08→	C5 2.0 HDi	DW10BTE4 (RHF)	Diesel	1997	4	34
09/04→	C5 2.0 HDi	DW10BTE4 (RHR) Euro 4	Diesel	1997	4	34
03/01→08/04	C5 2.0 HDi	DW10TD (RHY)	Diesel	1998	4	34
04/09→	C5 2.0 HDi 140	DW10BTE4 (RHF)	Diesel	1997	4	34
03/01→	C5 2.2 HDi	DW12TED4/FAP (4HX)	Diesel	2179	4	34
07/10→	C5 2.2 HDi 200	DW12C (4HL)	Diesel	2179	4	35
02/08→	C5 2.7 HDi	DT17ED4	Diesel	2720	V6	25
04/09→	C5 3.0 HDi 240	DT20C (X8C) Euro 5	Diesel	2993	V6	33
04/09→	C5 3.0 HDi 240	DT20C Euro 5	Diesel	2993	V6	33
03/01→	C5 3.0 V6	ES9J4S (XFW)	Petrol	2946	V6	42
09/04→	C5 Break 1.6 HDi	DV6TED4 (9HY)	Diesel	1560	4	12
09/04→	C5 Break 1.6 HDi	DV6TED4 (9HZ) Euro 4	Diesel	1560	4	12
07/10→	C5 Break 1.6 HDi 110	DV6C (9HR)	Diesel	1560	4	13
01/12→	C5 Break 1.6 HDi 115	DV6C (9HR)	Diesel	1560	4	13
06/01→08/04	C5 Break 2.0 HDi	DW10ATED (RHS)	Diesel	1997	4	34
06/01→08/04	C5 Break 2.0 HDi	DW10ATED (RHZ)	Diesel	1998	4	34
09/04→	C5 Break 2.0 HDi	DW10BTE4 (RHR) Euro 4	Diesel	1997	4	34
06/01→08/04	C5 Break 2.0 HDi	DW10TD (RHY)	Diesel	1998	4	34
04/09→	C5 Break 2.0 HDi 140	DW10BTE4 (RHF)	Diesel	1997	4	34
06/01→	C5 Break 2.2 HDi	DW12TED4/FAP (4HX)	Diesel	2179	4	34
07/10→	C5 Break 2.2 HDi 200	DW12C (4HL)	Diesel	2179	4	35
02/08→	C5 Break 2.7 HDi	DT17ED4	Diesel	2720	V6	25
04/09→	C5 Break 3.0 HDi 240	DT20C (X8C) Euro 5	Diesel	2993	V6	33
04/09→	C5 Break 3.0 HDi 240	DT20C Euro 5	Diesel	2993	V6	33
06/01→08/04	C5 Break 3.0 V6	ES9J4S (XFW)	Petrol	2946	V6	42
02/08→	C5 II 2.7 HDi	DT17TED4 (UHZ)	Diesel	2720	V6	25
09/05→	C6 2.7 HDi	DT17ED4	Diesel	2720	V6	25
10/05→	C6 2.7 HDi	DT17TED4 (UHZ)	Diesel	2720	V6	25
04/09→	C6 3.0 HDi	DT20C (X8C) Euro 5	Diesel	2993	V6	33
04/09→	C6 3.0 HDi	DT20C Euro 5	Diesel	2993	V6	33
09/05→	C6 3.0 V6	ES9J4S (XFW)	Petrol	2946	V6	42
07/02→	C8 2.0 HDi	DW10ATED4 (RHM)	Diesel	1997	4	34
07/02→	C8 2.0 HDi	DW10ATED4 (RHT)	Diesel	1997	4	34
07/02→	C8 2.0 HDi	DW10ATED4 (RHW)	Diesel	1997	4	34
02/07→	C8 2.0 HDi	DW10UTED4 (RHK)	Diesel	1997	4	34
03/06→	C8 2.0 HDi 135	DW10BTE4 (RHR) Euro 4	Diesel	1997	4	34
07/02→	C8 2.2 HDi	DW12TED4 (4HW)	Diesel	2179	4	34
07/02→	C8 3.0 V6	ES9J4S (XFW)	Petrol	2946	V6	42
10/84→12/97	C15 1.0	TU9	Petrol	954	4	1
10/84→12/97	C15 1.0	XV8 (108C)	Petrol	954	4	1
10/84→12/96	C15 1.1	E1A	Petrol	1118	4	8
11/88→07/96	C15 1.1	TU1 K	Petrol	1124	4	3
10/84→12/96	C15 1.1	XW7 (109K)	Petrol	1124	4	5

MODEL INDEX

Modelverzeichnis • Index de modele • Índice de Modelo
Indeks modelu • Модель автомобиля • دليل الموديل



CCM

x



9

07/88→12/96	C15 1.1 i	TU1M (HDZ)	Petrol	1124	4	3
07/87→05/88	C15 1.3	G1A	Petrol	1294	4	17
07/87→12/96	C15 1.4	TU3A (K1H)	Petrol	1360	4	14
07/87→12/96	C15 1.4 E	TU3 (K3A)	Petrol	1360	4	14
05/87→12/96	C15 1.4 E	XY7 (150D)	Petrol	1360	4	11
05/91→12/96	C15 1.4 i	TU3FM (KDY)	Petrol	1360	4	14
05/91→12/96	C15 1.4 i	TU3M (KDY)	Petrol	1360	4	14
07/86→12/00	C15 1.8 D	XUD7 (161A)	Diesel	1769	4	23
08/88→07/96	C15 Estate 1.1	TU1M (HDZ)	Petrol	1124	4	3
05/91→07/96	C15 Estate 1.4	TU3M (KDY)	Petrol	1360	4	14
05/87→10/92	C15 Estate 1.4	XY7 (150D)	Petrol	1360	4	11
04/87→08/00	C15 Estate 1.8 D	XUD7 (161A)	Diesel	1769	4	23
11/81→01/94	C25 Box 1.8	169B	Petrol	1796	4	32
11/81→01/94	C25 Box 1.8	XM7T (169)	Petrol	1796	4	32
01/88→01/94	C25 Box 1.9 D 1400	XUD9A (DJY)	Diesel	1905	4	30
02/91→03/94	C25 Box 2.0	XN1T (170C)	Petrol	1971	4	44
09/81→03/94	C25 Box 2.0 E	XN1T (170A)	Petrol	1971	4	44
09/81→03/94	C25 Box 2.0 E	XN1T (170B)	Petrol	1971	4	44
11/81→01/94	C25 Box 2.5 D	CRD93L (U25/661)	Diesel	2499	4	49
11/81→01/94	C25 Box 2.5 D	CRD93L (U25/661)	Diesel	2500	4	49
08/91→01/94	C25 Box 2.5 DT	CRD93LS (U25/673)	Diesel	2500	4	50
08/91→01/94	C25 Box 2.5 DT 4x4	CRD93LS (U25/673)	Diesel	2500	4	50
11/81→01/94	C25 Bus 1.8	169B	Petrol	1796	4	32
11/81→01/94	C25 Bus 1.8	XM7T (169)	Petrol	1796	4	32
02/87→02/94	C25 Bus 1.8 E	169B	Petrol	1796	4	32
07/87→02/94	C25 Bus 1.8 E	XM7T (169)	Petrol	1796	4	32
07/87→02/94	C25 Bus 1.9 D	XUD9A/U (D9B)	Diesel	1905	4	30
02/91→02/94	C25 Bus 2.0	XN1T (170C)	Petrol	1971	4	44
09/81→02/94	C25 Bus 2.0 E	XN1T (170A)	Petrol	1971	4	44
09/81→02/94	C25 Bus 2.0 E	XN1T (170B)	Petrol	1971	4	44
10/85→02/94	C25 Bus 2.5 D	CRD93L (U25/661)	Diesel	2499	4	49
10/85→02/94	C25 Bus 2.5 D	CRD93L (U25/661)	Diesel	2500	4	49
01/87→02/94	C25 Bus 2.5 D 4x4	CRD93L (U25/661)	Diesel	2499	4	49
01/87→02/94	C25 Bus 2.5 D 4x4	CRD93L (U25/661)	Diesel	2500	4	49
08/87→02/94	C25 Bus 2.5 D Turbo	CRD93LS (U25/673)	Diesel	2500	4	50
08/87→02/94	C25 Bus 2.5 D Turbo 4x4	CRD93LS (U25/673)	Diesel	2500	4	50
01/87→03/94	C25 Platform/Chassis 2.0	XN1T (170C)	Petrol	1971	4	44
11/83→01/94	C25 Platform/Chassis 2.5 D	CRD93L (U25/661)	Diesel	2499	4	49
11/83→01/94	C25 Platform/Chassis 2.5 D	CRD93L (U25/661)	Diesel	2500	4	49
01/87→01/94	C25 Platform/Chassis 2.5 DT	CRD93LS (U25/673)	Diesel	2500	4	50
02/80→01/94	C35 Box 2.5 D	B25/637	Diesel	2499	4	49
02/80→01/94	C35 Box 2.5 D	B25/637	Diesel	2500	4	49
02/80→01/94	C35 Bus 2.5 D	B25/637	Diesel	2499	4	49
02/80→01/94	C35 Bus 2.5 D	B25/637	Diesel	2500	4	49
01/74→12/92	C35 D	XD3, XD3P	Diesel	2498	4	51
02/80→01/94	C35 Pickup 2.5 D	B25/637	Diesel	2499	4	49
02/80→01/94	C35 Pickup 2.5 D	B25/637	Diesel	2500	4	49
02/07→	C-Crosser 2.2 HDi	DW12MTED4 (4HN)	Diesel	2179	4	35
01/09→	C-Crosser Enterprise 2.2 HDi	DW12MTED4 (4HN)	Diesel	2179	4	35
04/83→08/85	CX I 25 D Turbo	M25-648	Diesel	2500	4	50
06/79→08/85	CX I 2000	829.A5	Petrol	1995	4	43
06/81→08/85	CX I 2200	J6TA 500 / J6RA 500	Petrol	2165	4	43
02/78→06/82	CX I 2500 D	M25/629	Diesel	2500	4	49
06/79→08/85	CX I Break 2000	829.A5	Petrol	1995	4	43
06/81→08/85	CX I Break 2200	J6TA 500 / J6RA 500	Petrol	2165	4	43
02/78→08/85	CX I Break 2500 D	M25/629	Diesel	2500	4	49
04/83→08/85	CX I Break 2500 D Turbo	M25-648	Diesel	2500	4	50
08/85→12/92	CX II 20 RE	829.A5	Petrol	1995	4	43
07/85→12/92	CX II 22 TRS	J6TA 500 / J6RA 500	Petrol	2165	4	43
08/85→12/92	CX II 25 D	M25/660	Diesel	2499	4	49



CCM

x



9

08/85→12/92	CX II 25 D	M25/660	Diesel	2500	4	49
01/87→12/92	CX II 25 D Turbo	M25/669	Diesel	2500	4	50
08/85→12/86	CX II 25 D Turbo	M25-648	Diesel	2500	4	50
08/85→08/86	CX II Break 20	829.A5	Petrol	1995	4	43
07/85→12/92	CX II Break 22 TRS	J6TA 500 / J6RA 500	Petrol	2165	4	43
07/85→07/89	CX II Break 22TRS	J6TA 500 / J6RA 500	Petrol	2165	4	43
05/86→12/92	CX II Break 25 D	M25/660	Diesel	2499	4	49
05/86→12/92	CX II Break 25 D	M25/660	Diesel	2500	4	49
01/87→12/92	CX II Break 25 D Turbo 2	M25/669	Diesel	2500	4	50
08/85→12/86	CX II Break 2500 D Turbo	M25-648	Diesel	2500	4	50
04/11→	D53	DV6DTEDM (9HJ) Euro 4	Diesel	1560	4	13
04/11→	D54 92	DV6DTEDM (9HJ) Euro 4	Diesel	1560	4	13
11/09→	DS3 1.6 HDi 110	DV6C (9HR)	Diesel	1560	4	13
08/12→	DS3 1.6 HDi 115	DV6C (9HL)	Diesel	1560	4	13
11/09→	DS3 1.6 HDi 90	DV6DTE (9HP) Euro 4	Diesel	1560	4	13
01/13→	DS3 Convertible 1.6 HDi 90	DV6DTE (9HP) Euro 4	Diesel	1560	4	13
04/11→	DS4 1.6 HDi 110	DV6C (9HR)	Diesel	1560	4	13
08/12→	DS4 1.6 HDi 115	DV6C (9HL)	Diesel	1560	4	13
05/11→	DS4 1.6 HDi 90	DV6DTE (9HP) Euro 4	Diesel	1560	4	13
11/11→	DS5 1.6 HDi 110	DV6C (9HR)	Diesel	1560	4	13
12/68→10/84	Dyane 6	M28 (AM2)	Petrol	602	2	7
05/72→12/80	Dyane 6	M28/1 (AK2)	Petrol	602	2	7
05/97→07/02	Evasion 1.8	XU7JP (LFW/LFZ/L6A)	Petrol	1761	4	28
11/94→07/02	Evasion 1.9 TD	XUD9BTF (DHX)	Diesel	1905	4	31
11/94→07/02	Evasion 1.9 TD	XUD9TF (D8B)	Diesel	1905	4	31
06/94→07/02	Evasion 2.0	XU10J2C (RFU)	Petrol	1998	4	39
05/98→04/00	Evasion 2.0 16V	XU10J4R (RFV)	Petrol	1998	4	39
08/99→07/02	Evasion 2.0 HDI	DW10ATED (RHZ)	Diesel	1998	4	34
09/99→07/02	Evasion 2.0 HDI 16V	DW10ATED4 (RHW)	Diesel	1997	4	34
06/94→07/02	Evasion 2.0 Turbo C.T.	XU10J2TE (RGX)	Petrol	1998	4	39
05/96→07/02	Evasion 2.1 TD	XUD11BTE (P8C)	Diesel	2088	4	37
09/77→07/81	GS 1.1	G11/631	Petrol	1129	4	9
09/79→07/86	GS A 1.3	G13/625	Petrol	1299	4	22
09/79→07/86	GS A 1.3	G13/646	Petrol	1299	4	22
09/77→06/80	GS Break 1.1	G11/631	Petrol	1129	4	9
09/79→07/86	GS Break A 1.3	G13/625	Petrol	1299	4	22
09/79→07/86	GS Break A 1.3	G13/646	Petrol	1299	4	22
07/80→05/82	GS Break A Spezial	G11/631	Petrol	1129	4	9
02/94→02/02	Jumper 2.5 TD	THZ	Diesel	2446	4	48
07/99→04/02	Jumper Box 1.9 D	XUD9A (DJY)	Diesel	1905	4	30
02/94→04/02	Jumper Box 1.9 D	XUD9A/U (D9B)	Diesel	1905	4	30
03/94→04/02	Jumper Box 1.9 TD	XUD9BTF (DHX)	Diesel	1905	4	31
03/94→04/02	Jumper Box 1.9 TD	XUD9UTF (D8C)	Diesel	1905	4	31
04/02→	Jumper Box 2.0	XU10J2	Petrol	1998	4	39
03/94→04/02	Jumper Box 2.0	XU10J2U (RFW)	Petrol	1998	4	39
10/96→01/02	Jumper Box 2.0 4x4	XU10J2U (RFW)	Petrol	1998	4	39
02/03→	Jumper Box 2.0 bivalent	XU10J2	Petrol	1998	4	39
04/02→	Jumper Box 2.0 HDi	DW10TD (RHV)	Diesel	1997	4	34
11/01→	Jumper Box 2.0 HDi	DW10UTD (RHV)	Diesel	1997	4	34
04/02→	Jumper Box 2.2 HDi	DW12UTED (4HY)	Diesel	2179	4	34
04/06→	Jumper Box 2.2 HDi 100	P22DTE (4HV) Euro 4	Diesel	2198	4	38
04/06→	Jumper Box 2.2 HDi 120	P22DTE (4HU) Euro 4	Diesel	2198	4	38
03/94→04/02	Jumper Box 2.5 D	DJ5 (T9A)	Diesel	2446	4	45
03/00→04/02	Jumper Box 2.5 D 4x4	DJ5 (T9A)	Diesel	2446	4	45
03/94→04/02	Jumper Box 2.5 TD	DJ5T (T8A)	Diesel	2446	4	46
12/96→11/00	Jumper Box 2.5 TDi	DJ5TED (THX)	Diesel	2446	4	47
03/00→11/00	Jumper Box 2.5 TDi 4x4	DJ5TED (THX)	Diesel	2446	4	47
01/99→02/02	Jumper Box 2.8 D	8140.63 (F28D)	Diesel	2798	4	53
05/04→	Jumper Box 2.8 HDi	8140.43N	Diesel	2798	4	52
09/00→	Jumper Box 2.8 HDi	8140.43S Euro 3	Diesel	2798	4	52

MODEL INDEX

Modelverzeichnis • Index de modele • Índice de Modelo
Indeks modelu • Модель автомобиля • دليل المحرك



CCM

x



9

09/00→	Jumper Box 2.8 HDi 4x4	8140.43S Euro 3	Diesel	2798	4	52
01/99→04/02	Jumper Bus 1.9 D	XUD9A/U (D9B)	Diesel	1905	4	30
02/94→04/02	Jumper Bus 1.9 TD	XUD9UTF (D8C)	Diesel	1905	4	31
08/96→04/02	Jumper Bus 1.9 TD 4x4	XUD9UTF (D8C)	Diesel	1905	4	31
04/02→	Jumper Bus 2.0	XU10J2	Petrol	1998	4	39
02/94→04/02	Jumper Bus 2.0	XU10J2U (RFW)	Petrol	1998	4	39
08/96→04/02	Jumper Bus 2.0 4x4	XU10J2U (RFW)	Petrol	1998	4	39
02/03→	Jumper Bus 2.0 bivalent	XU10J2	Petrol	1998	4	39
04/02→	Jumper Bus 2.0 HDi	DW10UTD (RHV)	Diesel	1997	4	34
04/02→	Jumper Bus 2.2 HDi	DW12UTED (4HY)	Diesel	2179	4	34
04/06→	Jumper Bus 2.2 HDi 100	P22DTE (4HV) Euro 4	Diesel	2198	4	38
04/06→	Jumper Bus 2.2 HDi 120	P22DTE (4HU) Euro 4	Diesel	2198	4	38
08/94→04/02	Jumper Bus 2.5 D	DJ5 (T9A)	Diesel	2446	4	45
08/96→04/02	Jumper Bus 2.5 D 4x4	DJ5 (T9A)	Diesel	2446	4	45
08/94→04/02	Jumper Bus 2.5 TD	DJ5T (T8A)	Diesel	2446	4	46
08/96→04/02	Jumper Bus 2.5 TD 4x4	DJ5T (T8A)	Diesel	2446	4	46
12/96→11/00	Jumper Bus 2.5 TDi	DJ5TED (THX)	Diesel	2446	4	47
12/96→11/00	Jumper Bus 2.5 TDi 4x4	DJ5TED (THX)	Diesel	2446	4	47
01/99→02/02	Jumper Bus 2.8 D	8140.63 (F28D)	Diesel	2798	4	53
09/00→	Jumper Bus 2.8 HDi	8140.43S Euro 3	Diesel	2798	4	52
09/00→04/02	Jumper Bus 2.8 HDi 4x4	8140.43S Euro 3	Diesel	2798	4	52
04/02→	Jumper Bus 2.8 HDi All-wheel Drive	8140.43S Euro 3	Diesel	2798	4	52
05/04→	Jumper Platform/Chassis 2.8 HDi	8140.43N	Diesel	2798	4	52
04/02→	Jumper Platform/ Chassis 2.0 HDi	DW10UTD (RHV)	Diesel	1997	4	34
04/06→	Jumper Platform/Chassis 2.2 HDi 120	P22DTE (4HU) Euro 4	Diesel	2198	4	38
04/06→	Jumper Platform/Chassis 2.2 HDi 100	P22DTE (4HV) Euro 4	Diesel	2198	4	38
03/94→04/02	Jumper Platform/Chassis 1.9 TD	XUD9BTF (DHX)	Diesel	1905	4	31
03/94→04/02	Jumper Platform/Chassis 1.9 TD	XUD9UTF (D8C)	Diesel	1905	4	31
03/94→04/02	Jumper Platform/Chassis 2.0	XU10J2U (RFW)	Petrol	1998	4	39
02/02→06/06	Jumper Platform/Chassis 2.2 HDi	DW12UTED (4HY)	Diesel	2179	4	34
04/02→	Jumper Platform/Chassis 2.2 HDi 16V	DW12UTED (4HY)	Diesel	2179	4	34
03/94→04/02	Jumper Platform/Chassis 2.5 D	DJ5 (T9A)	Diesel	2446	4	45
03/00→04/02	Jumper Platform/Chassis 2.5 D 4x4	DJ5 (T9A)	Diesel	2446	4	45
03/94→04/02	Jumper Platform/Chassis 2.5 TD	DJ5T (T8A)	Diesel	2446	4	46
12/96→04/02	Jumper Platform/Chassis 2.5 TDi	DJ5TED (THX)	Diesel	2446	4	47
03/00→04/02	Jumper Platform/Chassis 2.5 TDi 4x4	DJ5TED (THX)	Diesel	2446	4	47
01/99→02/02	Jumper Platform/Chassis 2.8 D	8140.63 (F28D)	Diesel	2798	4	53
09/00→	Jumper Platform/Chassis 2.8 HDi	8140.43S Euro 3	Diesel	2798	4	52
02/02→06/06	Jumper Platform/Chassis 2.8 HDi 4x4	F28TDCR Euro 3	Diesel	2798	4	52
10/95→	Jumpy 1.6	220 A2.000	Petrol	1581	4	41
01/07→	Jumpy 1.6 HDi 90	DV6UTED4 (9HU)	Diesel	1560	4	12
10/95→04/98	Jumpy 1.9 D	XUD9A/U (D9B)	Diesel	1905	4	30
04/98→	Jumpy 1.9 D 70	DW8 (WJZ) / DW8B (WJY)	Diesel	1868	4	26
10/95→	Jumpy 1.9 TD	XUD9BTF (DHX)	Diesel	1905	4	31
04/96→	Jumpy 1.9 TD	XUD9TF (D8B)	Diesel	1905	4	31
03/00→	Jumpy 2.0 HDi 110	DW10ATED (RHZ)	Diesel	1998	4	34
03/00→	Jumpy 2.0 HDi 110	DW10ATED4 (RHW)	Diesel	1997	4	34
01/07→	Jumpy 2.0 HDi 120	DW10UTED4 (RHK)	Diesel	1997	4	34
01/07→	Jumpy 2.0 HDi 140	DW10BTED4 (RHR) Euro 4	Diesel	1997	4	34
10/99→	Jumpy 2.0 HDi 95	DW10BTED (RHX)	Diesel	1997	4	34
10/95→08/00	Jumpy Box 1.6	220 A2.000	Petrol	1581	4	41
01/07→	Jumpy Box 1.6 HDi 90	DV6UTED4 (9HU)	Diesel	1560	4	12
10/95→	Jumpy Box 1.6 i	220 A2.000	Petrol	1581	4	41
10/95→08/98	Jumpy Box 1.9 D	XUD9A/U (D9B)	Diesel	1905	4	30
04/98→	Jumpy Box 1.9 D 70	DW8 (WJZ) / DW8B (WJY)	Diesel	1868	4	26
04/98→	Jumpy Box 1.9 D 70	DW8B (WJY)	Diesel	1868	4	26
10/95→	Jumpy Box 1.9 TD	XUD9BTF (DHX)	Diesel	1905	4	31
01/02→	Jumpy Box 2.0 HDi 110	DW10ATED (RHZ)	Diesel	1998	4	34
01/02→	Jumpy Box 2.0 HDi 110	DW10ATED4 (RHW)	Diesel	1997	4	34
01/07→	Jumpy Box 2.0 HDi 120	DW10UTED4 (RHK)	Diesel	1997	4	34



CCM

x



01/07→	Jumpy Box 2.0 HDi 140	DW10BTED4 (RHR) Euro 4	Diesel	1997	4	34
10/99→	Jumpy Box 2.0 HDi 95	DW10BTED (RHX)	Diesel	1997	4	34
10/99→	Jumpy Platform/Chassis 1.9 TD	XUD9TF (D8B)	Diesel	1905	4	31
12/03→10/06	Jumpy Platform/Chassis 2.0 HDi 110	DW10ATED4 (RHW)	Diesel	1997	4	34
12/03→10/06	Jumpy Platform/Chassis 2.0 HDi 110 16V	DW10ATED (RHZ)	Diesel	1998	4	34
10/99→	Jumpy Platform/Chassis 2.0 HDi 95	DW10BTED (RHX)	Diesel	1997	4	34
11/76→07/79	LNA 0.6	R06/627	Petrol	602	2	7
11/78→07/86	LNA 0.6	V06/630	Petrol	652	2	19
11/78→07/86	LNA 0.6	V06/644	Petrol	652	2	19
10/79→10/87	Mehari 0.6	A06/635	Petrol	602	2	7
05/68→10/87	Mehari 0.6	M28/1 (AK2)	Petrol	602	2	7
10/79→10/87	Mehari 4x4	A06/635	Petrol	602	2	7
02/08→	Nemo 1.4i	TU3A (KFX)	Petrol	1360	4	14
02/08→	Nemo Box 1.4	TU3A (KFV)	Petrol	1360	4	14
02/08→	Nemo Box 1.4 HDi	DV4TD (8HS)	Diesel	1398	4	6
04/09→	Nemo Estate 1.4	TU3A (KFT)	Petrol	1360	4	14
04/09→	Nemo Estate 1.4	TU3A (KFV)	Petrol	1360	4	14
04/09→	Nemo Estate 1.4 HDi	DV4TD (8HS)	Diesel	1398	4	6
	Picasso 90	DV6DBM (9HE) Euro 4	Diesel	1560	4	13
05/96→06/03	Saxo 1.0 X	TU9M (CDY/CDZ)	Petrol	954	4	1
05/96→09/03	Saxo 1.1 X, SX	TU1JP (HFX)	Petrol	1124	4	4
05/96→09/03	Saxo 1.1 X, SX	TU1M (HDZ)	Petrol	1124	4	3
05/96→06/03	Saxo 1.4 VTS	TU3JP (KFW)	Petrol	1360	4	15
05/96→06/03	Saxo 1.4 VTS	TU3JP (KFX)	Petrol	1360	4	15
02/96→09/03	Saxo 1.4i	TU3A (KFW)	Petrol	1360	4	14
02/96→09/03	Saxo 1.4i	TU3A (KFX)	Petrol	1360	4	14
09/96→09/03	Saxo 1.5 D	TUD5 (VJY)	Diesel	1527	4	18
09/96→06/01	Saxo 1.5 D	TUD5 (VJZ)	Diesel	1527	4	18
02/96→04/04	Saxo 1.6	TU5J4 (NFX)	Petrol	1587	4	20
02/96→06/03	Saxo 1.6	TU5JP (NFT/NFZ)	Petrol	1587	4	21
05/96→06/03	Saxo 1.6 VTL, VTR	TU5JP (NFT/NFZ)	Petrol	1587	4	21
06/96→09/03	Saxo 1.6 VTS	TU5J4 (NFX)	Petrol	1587	4	20
09/78→06/88	Visa 0.6	V06/630	Petrol	652	2	19
09/78→06/88	Visa 0.6	V06/644	Petrol	652	2	19
09/84→06/88	Visa 1.0	XV8 (108C)	Petrol	954	4	1
07/84→03/91	Visa 1.4	150 D	Petrol	1360	4	11
07/82→03/91	Visa 11 E	XW7 (109/5F)	Petrol	1124	4	5
09/78→06/88	Visa 11 E	XW7 (109K)	Petrol	1124	4	5
07/84→03/91	Visa 14	XY7 (150D)	Petrol	1360	4	11
03/82→03/91	Visa 14 GT	XY8 (150B)	Petrol	1360	4	11
01/85→06/86	Visa 16 GTI	XU5J (180A/B6D)	Petrol	1580	4	27
06/86→03/91	Visa 16 GTI	XU5JA (B6D)	Petrol	1580	4	27
04/84→03/91	Visa 17 D	XUD7 (161A)	Diesel	1769	4	23
03/83→10/88	Visa Convertible 11 RE	XW7 (109/5F)	Petrol	1124	4	5
07/80→06/82	Visa II Super X	129/5	Petrol	1219	4	11
03/93→01/98	Xantia 1.6 i	XU5JP (BFZ)	Petrol	1580	4	27
01/98→03/01	Xantia 1.6 i SX	XU5JP (BFZ)	Petrol	1580	4	27
04/97→04/03	Xantia 1.8 i	XU7JB (LFX)	Petrol	1761	4	28
03/93→01/98	Xantia 1.8 i	XU7JP (LFW/LFZ/L6A)	Petrol	1761	4	28
06/95→04/03	Xantia 1.8 i 16V	XU7JP4 (LFY)	Petrol	1761	4	29
06/94→01/98	Xantia 1.9 D	XUD9 (DJZ)	Diesel	1905	4	30
06/94→01/98	Xantia 1.9 D	XUD9A/L (D9B)	Diesel	1905	4	30
02/96→04/03	Xantia 1.9 SD	XUD9SD (DHW)	Diesel	1905	4	31
10/94→04/03	Xantia 1.9 Turbo D	XUD9BTF (DHX)	Diesel	1905	4	31
10/94→04/03	Xantia 1.9 Turbo D	XUD9TE (DHY)	Diesel	1905	4	31
02/99→04/03	Xantia 2.0 HDI 109	DW10ATED (RHZ)	Diesel	1998	4	34
03/99→04/03	Xantia 2.0 HDI 90	DW10TD (RHY)	Diesel	1998	4	34
03/93→04/03	Xantia 2.0 i	XU10J2C (RFX)	Petrol	1998	4	39
06/94→01/98	Xantia 2.0 i 16V	XU10J4 (RFT)	Petrol	1998	4	39
03/93→01/98	Xantia 2.0 i 16V	XU10J4 (RFY)	Petrol	1998	4	39

MODEL INDEX

Modelverzeichnis • Index de modele • Índice de Modelo
Indeks modelu • Модель автомобиля • دليل الموديل



CCM

x



9

06/95→04/03	Xantia 2.0 i 16V	XU10J4R (RFV)	Petrol	1998	4	39
06/95→04/03	Xantia 2.0 Turbo	XU10J2TE (RGX)	Petrol	1998	4	39
03/93→12/01	Xantia 2.0i	XU10J2C/Z L3 (RFX)	Petrol	1998	4	39
06/95→02/99	Xantia 2.1 Turbo D 12V	XUD11BTE (P8C)	Diesel	2088	4	37
01/97→01/98	Xantia 3.0 i 24V	ES9J4 (XFZ)	Petrol	2946	V6	42
01/98→04/03	Xantia 3.0 V6	ES9J4 (XFZ)	Petrol	2946	V6	42
04/97→04/03	Xantia Break 1.8 i	XU7JB (LFX)	Petrol	1761	4	28
06/95→01/98	Xantia Break 1.8 i	XU7JP (LFW/LFZ/L6A)	Petrol	1761	4	28
06/95→04/03	Xantia Break 1.8 i 16V	XU7JP4 (LFY)	Petrol	1761	4	29
04/97→04/03	Xantia Break 1.9 SD	XUD9SD (DHW)	Diesel	1905	4	31
06/95→04/03	Xantia Break 1.9 Turbo D	XUD9BTF (DHX)	Diesel	1905	4	31
06/95→01/98	Xantia Break 1.9 Turbo D	XUD9TE (DHY)	Diesel	1905	4	31
06/95→04/03	Xantia Break 1.9 Turbo D	XUD9TF (D8B)	Diesel	1905	4	31
02/99→04/03	Xantia Break 2.0 HDI 109	DW10ATED (RHZ)	Diesel	1998	4	34
03/99→04/03	Xantia Break 2.0 HDI 90	DW10TD (RHY)	Diesel	1998	4	34
06/95→04/03	Xantia Break 2.0 i	XU10J2C (RFX)	Petrol	1998	4	39
06/95→04/03	Xantia Break 2.0 i 16V	XU10J4R (RFV)	Petrol	1998	4	39
06/95→04/03	Xantia Break 2.0 Turbo	XU10J2TE (RGX)	Petrol	1998	4	39
06/96→02/99	Xantia Break 2.1 Turbo D 12V	XUD11BTE (P8C)	Diesel	2088	4	37
01/98→04/03	Xantia Break 3.0 V6	ES9J4 (XFZ)	Petrol	2946	V6	42
05/89→06/94	XM 2.0	R6A	Petrol	1998	4	39
05/89→06/94	XM 2.0 i	XU10J2 (RFZ)	Petrol	1998	4	39
05/94→10/00	XM 2.0 i 16V	XU10J4R (RFV)	Petrol	1998	4	39
09/92→06/94	XM 2.0 i Turbo	XU10J2TE (RGX/RGY)	Petrol	1998	4	39
05/94→10/00	XM 2.0 Turbo	XU10J2TE (RGX)	Petrol	1998	4	39
05/89→06/94	XM 2.1 D 12V	XUD11A (P9A/PJZ)	Diesel	2138	4	40
03/96→08/96	XM 2.1 D12 V SX	XUD11A (P9A/PJZ)	Diesel	2138	4	40
05/89→10/00	XM 2.1 TD 12V	XUD11ATE (P8A)	Diesel	2088	4	36
05/89→10/00	XM 2.1 TD 12V	XUD11ATE (PHZ)	Diesel	2088	4	36
05/89→10/00	XM 2.1 TD 12V	XUD11ATE (PJZ)	Diesel	2088	4	36
05/94→10/00	XM 2.1 TD 12V	XUD11BTE (P8C)	Diesel	2088	4	37
05/94→10/00	XM 2.5 TD	DK5ATE (THY)	Diesel	2446	4	48
04/97→10/00	XM 3.0 V6	ES9J4 (XFZ)	Petrol	2946	V6	42
05/89→06/94	XM Break 2.0	R6A	Petrol	1998	4	39
11/91→04/94	XM Break 2.0 i	XU10J2 (RFZ)	Petrol	1998	4	39
11/91→04/94	XM Break 2.0 i	XU102C (R2A)	Petrol	1998	4	39
05/94→10/00	XM Break 2.0 i 16V	XU10J4R (RFV)	Petrol	1998	4	39
05/94→10/00	XM Break 2.0 Turbo	XU10J2TE (RGX)	Petrol	1998	4	39
09/92→10/00	XM Break 2.0 Turbo	XU10J2TE (RGX/RGY)	Petrol	1998	4	39
11/91→04/94	XM Break 2.1 D 12V	XUD11A (P9A/PJZ)	Diesel	2138	4	40
07/94→06/96	XM Break 2.1 D12	XUD11A (P9A/PJZ)	Diesel	2138	4	40
11/91→04/94	XM Break 2.1 TD 12V	XUD11ATE (P8A)	Diesel	2088	4	36
11/91→10/00	XM Break 2.1 TD 12V	XUD11ATE (PHZ)	Diesel	2088	4	36
11/91→10/00	XM Break 2.1 TD 12V	XUD11ATE (PJZ)	Diesel	2088	4	36
11/91→10/00	XM Break 2.1 TD 12V	XUD11BTE (P8C)	Diesel	2088	4	37
05/94→10/00	XM Break 2.5 TD	DK5ATE (THY)	Diesel	2446	4	48
04/97→10/00	XM Break 3.0 V6	ES9J4 (XFZ)	Petrol	2946	V6	42
01/03→03/05	Xsara 1.4 HDi	DV4TD (8HX)	Diesel	1399	4	6
04/97→03/05	Xsara 1.4 i	TU3JP (KFW)	Petrol	1360	4	15
04/97→03/05	Xsara 1.4 i	TU3JP (KFX)	Petrol	1360	4	15
09/00→	Xsara 1.4i	TU3A (KFW)	Petrol	1360	4	14
04/97→09/00	Xsara 1.5 D	TUD5 (VJZ)	Diesel	1527	4	18
09/00→03/05	Xsara 1.6 16V	TU5JP4 (N6A)	Petrol	1587	4	20
09/00→03/05	Xsara 1.6 16V	TU5JP4 (NFU/N6A)	Petrol	1587	4	20
04/97→09/00	Xsara 1.6 i	TU5JP (NFT/NFZ)	Petrol	1587	4	21
04/97→09/00	Xsara 1.8 D	XUD7 (161A)	Diesel	1769	4	23
04/97→09/00	Xsara 1.8 D	XUD7 (A9A/161A)	Diesel	1769	4	23
04/97→09/00	Xsara 1.8 i	XU7JB (LFX)	Petrol	1761	4	28
04/97→09/00	Xsara 1.8 i 16V	XU7JP4 (LFY)	Petrol	1761	4	29
04/97→09/00	Xsara 1.8 i Aut.	XU7JP (LFW/LFZ/L6A)	Petrol	1761	4	28



CCM

x



9

07/98→03/05	Xsara 1.9 D	DW8 (WJZ) / DW8B (WJY)	Diesel	1868	4	26
07/98→03/05	Xsara 1.9 D	DW8B (WJY)	Diesel	1868	4	26
04/97→09/00	Xsara 1.9 D	XUD9A (DJY)	Diesel	1905	4	30
01/98→09/00	Xsara 1.9 SD	XUD9BSD (DHY)	Diesel	1905	4	31
04/97→09/00	Xsara 1.9 TD	XUD9TE (DHY)	Diesel	1905	4	31
07/98→09/00	Xsara 2.0 16V	XU10J4R (RFV)	Petrol	1998	4	39
05/01→03/05	Xsara 2.0 HDi 109	DW10ATED (RHZ)	Diesel	1998	4	34
02/99→03/05	Xsara 2.0 HDi 90	DW10TD (RHY)	Diesel	1998	4	34
09/00→03/05	Xsara Box 2.0 HDi	DW10TD (RHY)	Diesel	1998	4	34
01/03→08/05	Xsara Break 1.4 HDi	DV4TD (8HX)	Diesel	1399	4	6
10/97→08/05	Xsara Break 1.4 i	TU3JP (KFW)	Petrol	1360	4	15
10/97→08/05	Xsara Break 1.4 i	TU3JP (KFX)	Petrol	1360	4	15
10/97→09/00	Xsara Break 1.5 D	TUD5 (VJZ)	Diesel	1527	4	18
09/00→08/05	Xsara Break 1.6 16V	TU5JP4 (N6A)	Petrol	1587	4	20
09/00→08/05	Xsara Break 1.6 16V	TU5JP4 (NFU/N6A)	Petrol	1587	4	20
10/97→09/00	Xsara Break 1.6 i	TU5JP (NFT/NFZ)	Petrol	1587	4	21
10/97→09/00	Xsara Break 1.8 D	XUD7 (A9A/161A)	Diesel	1769	4	23
10/97→09/00	Xsara Break 1.8 i	XU7JB (LFX)	Petrol	1761	4	28
10/97→09/00	Xsara Break 1.8 i 16V	XU7JP4 (LFY)	Petrol	1761	4	29
10/97→09/00	Xsara Break 1.8 i Aut.	XU7JP (LFW/LFZ/L6A)	Petrol	1761	4	28
07/98→08/05	Xsara Break 1.9 D	DW8 (WJZ) / DW8B (WJY)	Diesel	1868	4	26
07/98→08/05	Xsara Break 1.9 D	DW8B (WJY)	Diesel	1868	4	26
10/97→09/00	Xsara Break 1.9 D	XUD9A (DJY)	Diesel	1905	4	30
01/98→09/00	Xsara Break 1.9 D	XUD9BSD (DHY)	Diesel	1905	4	31
10/97→09/00	Xsara Break 1.9 TD	XUD9TE (DHY)	Diesel	1905	4	31
07/98→09/00	Xsara Break 2.0 16V	XU10J4R (RFV)	Petrol	1998	4	39
05/01→08/05	Xsara Break 2.0 HDi 109	DW10ATED (RHZ)	Diesel	1998	4	34
02/99→08/05	Xsara Break 2.0 HDi 90	DW10TD (RHY)	Diesel	1998	4	34
01/03→03/05	Xsara Coupe 1.4 HDi	DV4TD (8HX)	Diesel	1399	4	6
03/98→03/05	Xsara Coupe 1.4 i	TU3JP (KFW)	Petrol	1360	4	15
03/98→03/05	Xsara Coupe 1.4 i	TU3JP (KFX)	Petrol	1360	4	15
09/00→03/05	Xsara Coupe 1.6 16V	TU5JP4 (N6A)	Petrol	1587	4	20
09/00→03/05	Xsara Coupe 1.6 16V	TU5JP4 (NFU/N6A)	Petrol	1587	4	20
02/98→09/00	Xsara Coupe 1.6 i	TU5JP (NFT/NFZ)	Petrol	1587	4	21
02/98→09/00	Xsara Coupe 1.8 i	XU7JB (LFX)	Petrol	1761	4	28
02/98→09/00	Xsara Coupe 1.8 i	XU7JP (LFW/LFZ/L6A)	Petrol	1761	4	28
02/98→09/00	Xsara Coupe 1.8 i 16V	XU7JP4 (LFY)	Petrol	1761	4	29
02/99→03/05	Xsara Coupe 1.9 D	DW8 (WJZ) / DW8B (WJY)	Diesel	1868	4	26
02/99→03/05	Xsara Coupe 1.9 D	DW8B (WJY)	Diesel	1868	4	26
02/98→09/00	Xsara Coupe 1.9 D	XUD9A (DJY)	Diesel	1905	4	30
02/98→09/00	Xsara Coupe 1.9 TD	XUD9TE (DHY)	Diesel	1905	4	31
08/98→08/00	Xsara Coupe 2.0	XU10J4R (RFV)	Petrol	1998	4	39
05/01→03/05	Xsara Coupe 2.0 HDi 109	DW10ATED (RHZ)	Diesel	1998	4	34
02/99→03/05	Xsara Coupe 2.0 HDi 90	DW10TD (RHY)	Diesel	1998	4	34
12/99→	Xsara Picasso 1.6	TU5JP (NFT/NFZ)	Petrol	1587	4	21
12/99→	Xsara Picasso 1.6	TU5JP (NFV)	Petrol	1587	4	21
09/05→	Xsara Picasso 1.6 16V	TU5JP4 (N6A)	Petrol	1587	4	20
09/05→	Xsara Picasso 1.6 16V	TU5JP4 (NFU/N6A)	Petrol	1587	4	20
05/04→	Xsara Picasso 1.6 HDi	DV6TED4 (9HY)	Diesel	1560	4	12
12/99→	Xsara Picasso 2.0 HDi	DW10ATED (RHZ)	Diesel	1998	4	34
12/99→	Xsara Picasso 2.0 HDi	DW10TD (RHY)	Diesel	1998	4	34
03/91→08/93	ZX 1.1	TU1 (H1B)	Petrol	1124	4	3
03/91→08/93	ZX 1.1	TU1 K	Petrol	1124	4	3
03/91→06/97	ZX 1.1	TU1M (HDZ)	Petrol	1124	4	3
03/91→06/97	ZX 1.4	TU3M/Z (KDZ)	Petrol	1360	4	14
07/94→10/97	ZX 1.4 D	TUD3Y (K9Y)	Diesel	1360	4	16
03/91→06/97	ZX 1.4 i	TU3JP (KFX)	Petrol	1360	4	15
03/91→06/97	ZX 1.4 i	TU3M (KDX)	Petrol	1360	4	14
03/91→06/97	ZX 1.4 i	TU3M/Z (KDZ)	Petrol	1360	4	14
03/91→06/97	ZX 1.6 i	XU5JP (BFZ)	Petrol	1580	4	27

MODEL INDEX

Modelverzeichnis • Index de modele • Índice de Modelo
Indeks modelu • Модель автомобиля • دليل الموديل



CCM

x



9

07/94→10/97	ZX 1.8	XU7JP (LFW/LFZ/L6A)	Petrol	1761	4	28
04/96→10/97	ZX 1.8	XU7JP4 (LFY)	Petrol	1761	4	29
06/93→06/97	ZX 1.8 D	XUD7 (161A)	Diesel	1769	4	23
07/92→06/97	ZX 1.8 i	XU7JP (LFW/LFZ/L6A)	Petrol	1761	4	28
01/96→06/97	ZX 1.8 i 16V	XU7JP4 (LFY)	Petrol	1761	4	29
03/91→06/97	ZX 1.9 D	XUD9 (DJZ)	Diesel	1905	4	30
07/93→06/97	ZX 1.9 D	XUD9A (DJY)	Diesel	1905	4	30
07/93→06/97	ZX 1.9 D	XUD9A/U (D9B)	Diesel	1905	4	30
03/91→06/97	ZX 1.9 i	XU9JA (DKZ)	Petrol	1905	4	28
07/92→06/97	ZX 1.9 TD	XUD9TE (DHY)	Diesel	1905	4	31
07/94→10/97	ZX 2.0	XU10J2C (RFX)	Petrol	1998	4	39
07/92→06/97	ZX 2.0 i	XU10J2C (RFX)	Petrol	1998	4	39
07/92→06/97	ZX 2.0 i 16V	XU10J4 (RFT)	Petrol	1998	4	39
07/92→10/94	ZX 2.0 i 16V	XU10J4 (RFY)	Petrol	1998	4	39
07/92→10/97	ZX 2.0i	XU10J2C/Z L3 (RFX)	Petrol	1998	4	39
10/93→10/97	ZX Break 1.4 i	TU3JP (KFX)	Petrol	1360	4	15
10/93→10/97	ZX Break 1.4 i	TU3M (KDX)	Petrol	1360	4	14
10/93→10/97	ZX Break 1.4 i	TU3M (KDY)	Petrol	1360	4	14
10/93→10/97	ZX Break 1.6 i	XU5JP (BFZ)	Petrol	1580	4	27
10/93→10/97	ZX Break 1.8 D	XUD7 (161A)	Diesel	1769	4	23
10/93→10/97	ZX Break 1.8 i	XU7JP (LFW/LFZ/L6A)	Petrol	1761	4	28
01/96→02/98	ZX Break 1.8 i 16V	XU7JP4 (LFY)	Petrol	1761	4	29
10/93→10/97	ZX Break 1.9 D	XUD9 (DJZ)	Diesel	1905	4	30
06/94→10/97	ZX Break 1.9 D	XUD9A/U (D9B)	Diesel	1905	4	30
10/93→10/97	ZX Break 1.9 TD	XUD9TE (DHY)	Diesel	1905	4	31



CCM

x



9

1KR-FE	Petrol	998	3	71.00	2
129/5	Petrol	1219	4	75.00	11
150 D	Petrol	1360	4	75.00	11
169B	Petrol	1796	4	84.00	32
171C	Petrol	1580	4	83.00	27
220 A2.000	Petrol	1581	4	86.40	41
829.A5	Petrol	1995	4	88.00	43
8140.43N	Diesel	2798	4	94.40	52
8140.43S Euro 3	Diesel	2798	4	94.40	52
8140.63 (F28D)	Diesel	2798	4	94.40	53
A06/635	Petrol	602	2	74.00	7
B25/637	Diesel	2499	4	93.00	49
B25/637	Diesel	2500	4	93.00	49
CFA (384F)	Petrol	998	3	71.00	2
CRD93L (U25/661)	Diesel	2499	4	93.00	49
CRD93L (U25/661)	Diesel	2500	4	93.00	49
CRD93LS (U25/673)	Diesel	2500	4	93.00	50
DJ5 (T9A)	Diesel	2446	4	92.00	45
DJ5T (T8A)	Diesel	2446	4	92.00	46
DJ5TED (THX)	Diesel	2446	4	92.00	47
DK5ATE (THY)	Diesel	2446	4	92.00	48
DT17ED4	Diesel	2720	V6	81.00	25
DT17TED4 (UHZ)	Diesel	2720	V6	81.00	25
DT20C (X8C) Euro 5	Diesel	2993	V6	84.00	33
DT20C Euro 5	Diesel	2993	V6	84.00	33
DV4TD	Diesel	1398	4	73.70	6
DV4TD (8HS)	Diesel	1398	4	73.70	6
DV4TD (8HT)	Diesel	1398	4	73.70	6
DV4TD (8HX)	Diesel	1399	4	73.70	6
DV4TD (8HZ)	Diesel	1398	4	73.70	6
DV4TED4 (8HY)	Diesel	1399	4	73.70	6
DV6ATED4 (9HX) Euro 4	Diesel	1560	4	75.00	12
DV6BTED4 (9HT) Euro 4	Diesel	1560	4	75.00	13
DV6BTED4 (9HW) Euro 4	Diesel	1560	4	75.00	13
DV6BUTED4 (9HT) Euro 4	Diesel	1560	4	75.00	13
DV6C (9HL)	Diesel	1560	4	75.00	13
DV6C (9HR)	Diesel	1560	4	75.00	13
DV6DBM (9HE) Euro 4	Diesel	1560	4	75.00	13
DV6DTED (9HF) Euro 4	Diesel	1560	4	75.00	13
DV6DTED (9HP) Euro 4	Diesel	1560	4	75.00	13
DV6DTEDM (9HJ) Euro 4	Diesel	1560	4	75.00	13
DV6ETED (9HN) Euro 4	Diesel	1560	4	75.00	13
DV6ETED (9HW) Euro 4	Diesel	1560	4	75.00	13
DV6ETEDM (9HK) Euro 4	Diesel	1560	4	75.00	13
DV6TED4 (9HY)	Diesel	1560	4	75.00	12
DV6TED4 (9HZ) Euro 4	Diesel	1560	4	75.00	12
DV6UTED4 (9HU)	Diesel	1560	4	75.00	12
DW8 (WJZ) / DW8B (WJY)	Diesel	1868	4	82.20	26
DW8B (WJY)	Diesel	1868	4	82.20	26
DW10ATED (RHS)	Diesel	1997	4	85.00	34
DW10ATED (RHZ)	Diesel	1998	4	85.00	34
DW10ATED4 (RHM)	Diesel	1997	4	85.00	34
DW10ATED4 (RHT)	Diesel	1997	4	85.00	34
DW10ATED4 (RHW)	Diesel	1997	4	85.00	34
DW10BTED (RHX)	Diesel	1997	4	85.00	34
DW10BTED4 (RHF)	Diesel	1997	4	85.00	34
DW10BTED4 (RHJ) Euro 4	Diesel	1997	4	85.00	34
DW10BTED4 (RHR) Euro 4	Diesel	1997	4	85.00	34
DW10TD (RHV)	Diesel	1997	4	85.00	34
DW10TD (RHY)	Diesel	1998	4	85.00	34

ENGINE INDEX

Motorverzeichnis • Index de moteur • Índice de Motor
Indeks silnika • Модель двигателя • دليل المحرك



CCM



9

DW10UTD (RHV)	Diesel	1997	4	85.00	34
DW10UTED4 (RHK)	Diesel	1997	4	85.00	34
DW12C (4HL)	Diesel	2179	4	85.00	35
DW12MTED4 (4HN)	Diesel	2179	4	85.00	35
DW12TED4 (4HW)	Diesel	2179	4	85.00	34
DW12TED4/FAP (4HX)	Diesel	2179	4	85.00	34
DW12UTED (4HY)	Diesel	2179	4	85.00	34
E1A	Petrol	1118	4	74.00	8
ES9J4 (XFZ)	Petrol	2946	V6	87.00	42
ES9J4S (XFW)	Petrol	2946	V6	87.00	42
F28TDCR Euro 3	Diesel	2798	4	94.40	52
G1A	Petrol	1294	4	76.50	17
G11/631	Petrol	1129	4	74.00	9
G13/625	Petrol	1299	4	79.40	22
G13/646	Petrol	1299	4	79.40	22
J6TA 500 / J6RA 500	Petrol	2165	4	88.00	43
K1B	Petrol	1360	4	75.00	14
K1G	Petrol	1360	4	75.00	14
KAZ	Petrol	1360	4	75.00	14
M4 (AM)	Petrol	602	2	74.00	10
M25/629	Diesel	2500	4	93.00	49
M25/660	Diesel	2499	4	93.00	49
M25/660	Diesel	2500	4	93.00	49
M25/669	Diesel	2500	4	93.00	50
M25-648	Diesel	2500	4	93.00	50
M28 (AM2)	Petrol	602	2	74.00	7
M28/1 (AK2)	Petrol	602	2	74.00	7
P22DTE (4HU) Euro 4	Diesel	2198	4	86.00	38
P22DTE (4HV) Euro 4	Diesel	2198	4	86.00	38
R06/627	Petrol	602	2	74.00	7
R6A	Petrol	1998	4	86.00	39
THZ	Diesel	2446	4	92.00	48
TU1 (H1B)	Petrol	1124	4	72.00	3
TU1 K	Petrol	1124	4	72.00	3
TU1CP (HAZ)	Petrol	1124	4	72.00	3
TU1JP (HFX)	Petrol	1124	4	72.00	4
TU1M (HDZ)	Petrol	1124	4	72.00	3
TU2.4	Petrol	1294	4	75.00	14
TU3 (K3A)	Petrol	1360	4	75.00	14
TU3A (K1H)	Petrol	1360	4	75.00	14
TU3A (K6D)	Petrol	1360	4	75.00	14
TU3A (K6E)	Petrol	1360	4	75.00	14
TU3A (K6F)	Petrol	1360	4	75.00	14
TU3A (KFT)	Petrol	1360	4	75.00	14
TU3A (KfV)	Petrol	1360	4	75.00	14
TU3A (KfW)	Petrol	1360	4	75.00	14
TU3A (KfX)	Petrol	1360	4	75.00	14
TU3CP (KAY)	Petrol	1360	4	75.00	14
TU3F2 (K1F)	Petrol	1360	4	75.00	14
TU3F2 (K2B)	Petrol	1360	4	75.00	14
TU3FJ2 (K2D)	Petrol	1360	4	75.00	14
TU3FJ2 (KfY)	Petrol	1360	4	75.00	14
TU3FJ2 (KfZ)	Petrol	1360	4	75.00	14
TU3FM (K2A)	Petrol	1360	4	75.00	14
TU3FM (KDY)	Petrol	1360	4	75.00	14
TU3JP (KfW)	Petrol	1360	4	75.00	15
TU3JP (KfX)	Petrol	1360	4	75.00	15
TU3JP-L4 (KfV)	Petrol	1360	4	75.00	15
TU3M (KDX)	Petrol	1360	4	75.00	14
TU3M (KDY)	Petrol	1360	4	75.00	14

Motorverzeichnis • Index de moteur • Índice de Motor
 Indeks silnika • Модель двигателя • دليل المحرك

ENGINE INDEX

CCM
x

9

TU3M/Z (KDZ)	Petrol	1360	4	75.00	14
TU5J4 (NFX)	Petrol	1587	4	78.50	20
TU5JP (NFT/NFZ)	Petrol	1587	4	78.50	21
TU5JP (NFV)	Petrol	1587	4	78.50	21
TU5JP4 (N6A)	Petrol	1587	4	78.50	20
TU5JP4 (NFU/N6A)	Petrol	1587	4	78.50	20
TU9	Petrol	954	4	70.00	1
TU9 (C1A)	Petrol	954	4	70.00	1
TU9M (CDY/CDZ)	Petrol	954	4	70.00	1
TUD3 (K9A)	Diesel	1360	4	75.00	16
TUD3Y (K9Y)	Diesel	1360	4	75.00	16
TUD5 (VJY)	Diesel	1527	4	77.00	18
TUD5 (VJZ)	Diesel	1527	4	77.00	18
V06/630	Petrol	652	2	77.00	19
V06/644	Petrol	652	2	77.00	19
XD3, XD3P	Diesel	2498	4	94.00	51
XM7T (169)	Petrol	1796	4	84.00	32
XN1T (170A)	Petrol	1971	4	88.00	44
XN1T (170B)	Petrol	1971	4	88.00	44
XN1T (170C)	Petrol	1971	4	88.00	44
XU5 (171A)	Petrol	1580	4	83.00	27
XU5 (B1AA)	Petrol	1580	4	83.00	27
XU5CP (BAY/BAZ)	Petrol	1580	4	83.00	27
XU5J (180A/B6D)	Petrol	1580	4	83.00	27
XU5J (180Z)	Petrol	1580	4	83.00	27
XU5J/J2/JA	Petrol	1580	4	83.00	27
XU5JA (B6D)	Petrol	1580	4	83.00	27
XU5JP (BFZ)	Petrol	1580	4	83.00	27
XU5S (171B)	Petrol	1580	4	83.00	27
XU5S (171D)	Petrol	1580	4	83.00	27
XU7JB (LFX)	Petrol	1761	4	83.00	28
XU7JP (LFW/LFZ/L6A)	Petrol	1761	4	83.00	28
XU7JP4 (LFY)	Petrol	1761	4	83.00	29
XU9J1 (DFZ)	Petrol	1905	4	83.00	28
XU9J2 (D6A)	Petrol	1905	4	83.00	28
XU9J4 (D6C/DFW)	Petrol	1905	4	83.00	29
XU9J4 (DFW)	Petrol	1905	4	83.00	29
XU9JA (DKZ)	Petrol	1905	4	83.00	28
XU10J2	Petrol	1998	4	86.00	39
XU10J2 (RFZ)	Petrol	1998	4	86.00	39
XU10J2C (RFU)	Petrol	1998	4	86.00	39
XU10J2C (RFX)	Petrol	1998	4	86.00	39
XU10J2C/Z L3 (RFX)	Petrol	1998	4	86.00	39
XU10J2TE (RGX)	Petrol	1998	4	86.00	39
XU10J2TE (RGX/RGY)	Petrol	1998	4	86.00	39
XU10J2U (RFW)	Petrol	1998	4	86.00	39
XU10J4 (RFT)	Petrol	1998	4	86.00	39
XU10J4 (RFY)	Petrol	1998	4	86.00	39
XU10J4R (RFV)	Petrol	1998	4	86.00	39
XU51C (B1E)	Petrol	1580	4	83.00	27
XU52C	Petrol	1580	4	83.00	27
XU92C (D2A)	Petrol	1905	4	83.00	28
XU92C (D2C)	Petrol	1905	4	83.00	28
XU92C (D2F)	Petrol	1905	4	83.00	28
XU102C (R2A)	Petrol	1998	4	86.00	39
XUD7 (161)	Diesel	1769	4	80.00	23
XUD7 (161A)	Diesel	1769	4	80.00	23
XUD7 (A9A/161A)	Diesel	1769	4	80.00	23
XUD7TE (A8A)	Diesel	1769	4	80.00	24
XUD7TE (AJZ)	Diesel	1769	4	80.00	24

ENGINE INDEX

Motorverzeichnis • Index de moteur • Índice de Motor
Indeks silnika • Модель двигателя • دليل المحرك



CCM

x



9

XUD9 (162)	Diesel	1905	4	83.00	30
XUD9 (D9A)	Diesel	1905	4	83.00	30
XUD9 (DJZ)	Diesel	1905	4	83.00	30
XUD9A (DJY)	Diesel	1905	4	83.00	30
XUD9A/L (D9B)	Diesel	1905	4	83.00	30
XUD9A/U (D9B)	Diesel	1905	4	83.00	30
XUD9BSD (DHV)	Diesel	1905	4	83.00	31
XUD9BTF (DHX)	Diesel	1905	4	83.00	31
XUD9SD (DHW)	Diesel	1905	4	83.00	31
XUD9TE (DHY)	Diesel	1905	4	83.00	31
XUD9TF (D8B)	Diesel	1905	4	83.00	31
XUD9UTF (D8C)	Diesel	1905	4	83.00	31
XUD11A (P9A/PJZ)	Diesel	2138	4	86.00	40
XUD11ATE (P8A)	Diesel	2088	4	85.00	36
XUD11ATE (PHZ)	Diesel	2088	4	85.00	36
XUD11ATE (PJZ)	Diesel	2088	4	85.00	36
XUD11BTE (P8C)	Diesel	2088	4	85.00	37
XV8 (108C)	Petrol	954	4	70.00	1
XW7 (109/5F)	Petrol	1124	4	72.00	5
XW7 (109K)	Petrol	1124	4	72.00	5
XY6 (150F) / XY8 (150A)	Petrol	1360	4	75.00	11
XY6C (150A)	Petrol	1360	4	75.00	11
XY6D (150C)	Petrol	1360	4	75.00	11
XY7 (150D)	Petrol	1360	4	75.00	11
XY8 (150B)	Petrol	1360	4	75.00	11



C15 1.0	10/84→12/97	TU9	4cyl. 954cc	33kW (45PS)	1
TD18545					
AX 10	07/86→12/98	TU9 (C1A)	4cyl. 954cc	33kW (45PS)	
TD5095					
AX 10 Saxo 1.0 X	02/87→12/98 05/96→06/03	TU9M (CDY/CDZ)	4cyl. 954cc	40kW (54PS)	
TD10787					
C15 1.0 Visa 1.0	10/84→12/97 09/84→06/88	XV8 (108C)	4cyl. 954cc	33kW (45PS)	
TD18544					

08-154200-00	STD	70.00	1.500		001 IF CR P	IKA
08-154206-00	0.40mm				005 IF P	STD
08-154208-00	0.60mm		1.500		712 CR	ST
01/1987→			3.000			
[R46910]						
08-317300-00	STD	70.00	2.000		001 IF CR P	STD
01/1983→			2.000		026 P	STD
[R66100]			4.000		712 CR	ST

C1 1.0	06/05→	1KR-FE	3cyl. 998cc	50kW (68PS)	2	
TD18548						
C1 1.0	06/05→	CFA (384F)	3cyl. 998cc	50kW (68PS)		
TD25073						
08-439600-00	STD	71.00	1.000		001 IF CR	ST
			1.000		026	ST
			1.500		231 PVD	ST



AX 11 ZX 1, 1	09/86→12/97 03/91→08/93	TU1 (H1B)	4cyl. 1124cc	40-44kW (55-60PS)	3	TD658
------------------	----------------------------	------------------	-----------------	-------------------	----------	--------------

AX 11 AX 11 4x4 BX 11 C15 1.1 ZX 1, 1	12/86→04/94 06/91→07/92 10/86→06/92 11/88→07/96 03/91→08/93	TU1 K	4cyl. 1124cc	40-44kW (54-60PS)		TD6562
---	---	--------------	-----------------	-------------------	--	---------------

AX 11 CAT	09/88→12/89	TU1CP (HAZ)	4cyl. 1124cc	40kW (54PS)		TD5083
-----------	-------------	--------------------	-----------------	-------------	--	---------------

AX 11 Berlingo 1.1 i, Berlingo Box 1.1 i BX 11 C15 1.1 i C15 Estate 1.1 Saxo 1.1 X, SX ZX 1.1	09/86→12/97 07/96→ 10/88→06/92 07/88→12/96 08/88→07/96 05/96→09/03 03/91→06/97	TU1M (HDZ)	4cyl. 1124cc	40kW (54PS)		TD661
---	--	-------------------	-----------------	-------------	--	--------------

08-154300-00 08-154307-00 01/1987→ [R60860]	STD 0.50mm	72.00	1.500 2.000 3.000	 001 IF CR P 026 P 712 CR		IKA STD ST
--	---------------	-------	-------------------------	------------------------------------	--	------------------

Berlingo 1.1 i, Berlingo Box 1.1 i C2 1.1 C3 1.1 i C3 II 1.1 Saxo 1.1 X, SX	07/96→ 09/03→ 02/02→ 11/09→ 05/96→09/03	TU1JP (HFX)	4cyl. 1124cc	44kW (60PS)	4	TD14730
---	---	--------------------	-----------------	-------------	----------	----------------

08-426300-00	STD	72.00	1.500 1.500 2.500	 001 NT 026 P 236 P		KV1 GOE13 GOE13
--------------	-----	-------	-------------------------	------------------------------	--	-----------------------

Visa 11 E Visa Convertible 11 RE	07/82→03/91 03/83→10/88	XW7 (109/5F)	4cyl. 1124cc	33-37kW (45-50PS)	5	TD566
-------------------------------------	----------------------------	---------------------	-----------------	-------------------	----------	--------------

C15 1.1 Visa 11 E	10/84→12/96 09/78→06/88	XW7 (109K)	4cyl. 1124cc	35kW (47PS)		TD563
----------------------	----------------------------	-------------------	-----------------	-------------	--	--------------

08-319400-00 [R66090]	STD	72.00	1.500 2.000 4.000	 001 IF CR P 026 P 712 CR		STD STD ST
--------------------------	-----	-------	-------------------------	------------------------------------	--	------------------



C1 1.4 HDi		06/05→	DV4TD	4cyl. 1398cc 40kW (54PS)	6	
			Diesel Turbo Intercooled	TD18550		
Nemo Box 1.4 HDi Nemo Estate 1.4 HDi		02/08→ 04/09→	DV4TD (8HS)	4cyl. 1398cc 50kW (68PS)	TD24698	
			Diesel Turbo Intercooled			
C1 1.4 HDi		06/05→	DV4TD (8HT)	4cyl. 1398cc 40kW (54PS)	TD25062	
			Diesel Turbo			
C2 1.4 HDi C2 Enterprise 1.4 HDi C3 1.4 HDi C3 Pluriel 1.4 HDi Xsara 1.4 HDi Xsara Break 1.4 HDi Xsara Coupe 1.4 HDi		09/03→ 04/09→ 02/02→ 04/04→ 01/03→03/05 01/03→08/05 01/03→03/05	DV4TD (8HX)	4cyl. 1399cc 52kW (71PS)	TD16425	
			Diesel Turbo Intercooled			
C3 II 1.4 HDi 70		11/09→	DV4TD (8HZ)	4cyl. 1398cc 50kW (68PS)	TD23773	
			Diesel Turbo Intercooled			
C3 1.4 16V HDi		02/02→	DV4TED4 (8HY)	4cyl. 1399cc 66kW (89PS)	TD16426	
			Diesel Turbo Intercooled			
08-135300-00	STD	73.70	2.500		008 CK P	KV1
08-135305-00	0.25mm				005 IFU P	GOE12
08-135307-00	0.50mm				231 CR P	GOE12
[R66770]			2.500			
2 CV 6 Mehari 0.6, Mehari 4x4		02/70→10/85 10/79→10/87	A06/635	2cyl. 602cc 21kW (29PS)	7	
				TD599		
Acadiane 6 Ami 6 Ami 8 Ami Break 6 Ami Break 8 Dyane 6		08/78→10/88 05/68→07/69 07/69→12/77 05/68→07/69 07/69→12/77 12/68→10/84	M28 (AM2)	2cyl. 602cc 21kW (29PS)	TD5084	
2 CV 6 Dyane 6 Mehari 0.6		09/75→06/81 05/72→12/80 05/68→10/87	M28/1 (AK2)	2cyl. 602cc 21kW (29PS)	TD705	





LNA 0.6			11/76→07/79	R06/627		2cyl. 602cc	21kW (29PS)		
									TD5090

08-144700-00 →12/1976 [R60900]	STD	74.00	1.500		001 IF CR P	IKA
			2.000		026 P	STD
			4.000		712 CR	ST
08-147100-00 01/1977→ [R60930]	STD	74.00	1.750		001 IF MO P	IKA
			2.000		026 P	STD
			3.500		712 CR	ST

C15 1.1			10/84→12/96	E1A		4cyl. 1118cc	40kW (54PS)		8
									TD648

08-344500-00 [R66370]	STD	74.00	1.750		001 IF CR P	IKA
			2.000		026 P	STD
			4.000		712 CR	ST

Axel 11			01/84→03/91	G11/631		4cyl. 1129cc	41-43kW (56-58PS)		9
GS 1.1			09/77→07/81						
GS Break 1.1			09/77→06/80						
GS Break A Spezial			07/80→05/82						TD651

08-147800-00	STD	74.00	1.750		001 IF MO P	IKA
			2.000		026 P	STD
			3.500		712 CR	ST

Ami 6			01/63→05/68	M4 (AM)		2cyl. 602cc	21kW (29PS)		10
									TD5180

08-144700-00 [R60900]	STD	74.00	1.500		001 IF CR P	IKA
			2.000		026 P	STD
			4.000		712 CR	ST

Visa II Super X			07/80→06/82	129/5		4cyl. 1219cc	42kW (57PS)		11
									TD574

Visa 1.4			07/84→03/91	150 D		4cyl. 1360cc	44kW (60PS)		TD6570
-----------------	--	--	-------------	--------------	--	------------------------	--------------------	--	---------------





BX 14 E	09/85→02/93	XY6 (150F) / XY8 (150A)	4cyl. 1360cc	49kW (67PS)	TD578
BX 14 E	10/82→06/88	XY6C (150A)	4cyl. 1360cc	46kW (63PS)	TD576
BX 14 E BX Break 1.4 BX Break 14	04/83→02/93 01/87→01/92 01/86→02/93	XY6D (150C)	4cyl. 1360cc	53kW (72PS)	TD582
C15 1.4 E C15 Estate 1.4 Visa 14	05/87→12/96 05/87→10/92 07/84→03/91	XY7 (150D)	4cyl. 1360cc	44kW (60PS)	TD5091
Visa 14 GT	03/82→03/91	XY8 (150B)	4cyl. 1360cc	46kW (63PS)	TD577

08-334200-00	STD	75.00	1.750		001 IF CR P	IKA
08-334207-00	0.50mm		2.000		026 P	STD
[R66320]			4.000		712 CR	ST

Berlingo 1.6 HDi 90, Berlingo Box 1.6 HDi 90	07/05→	DV6ATED4 (9HX) Euro 4	4cyl. 1560cc	66kW (89PS)	TD19913
C3 1.6 16V HDi	10/05→	Diesel	Turbo Intercooled		
C3 II 1.6 HDi 90	11/09→				
C3 Picasso 1.6 HDi	02/09→				
C4 1.6 HDi, C4 Coupe 1.6 HDi	11/04→				
C4 1.6 HDi, C4 Coupe 1.6 HDi	11/04→	DV6TED4 (9HY)	4cyl. 1560cc	80kW (109PS)	TD19911
C4 Grand Picasso 1.6 HDi	10/06→	Diesel	Turbo Intercooled		
C4 Picasso 1.6 HDi	02/07→				
C4 Saloon 1.6 HDi	07/06→				
C5 1.6 HDi, C5 Break 1.6 HDi	09/04→				
Xsara Picasso 1.6 HDi	05/04→				
Berlingo 1.6 HDi 110 Berlingo Box 1.6 HDi 110	08/05→ 04/08→	DV6TED4 (9HZ) Euro 4	4cyl. 1560cc	80kW (109PS)	TD19824
C2 1.6 HDi, C3 1.6 16V HDi	09/05→	Diesel	Turbo Intercooled		
C3 Picasso 1.6 HDi	02/09→				
C4 1.6 HDi, C4 Coupe 1.6 HDi	11/04→				
C4 Grand Picasso 1.6 HDi	10/06→				
C4 Picasso 1.6 HDi	02/07→				
C4 Saloon 1.6 HDi	07/06→				
C5 1.6 HDi, C5 Break 1.6 HDi	09/04→				
Jumpy 1.6 HDi 90, Jumpy Box 1.6 HDi 90	01/07→	DV6UTED4 (9HU)	4cyl. 1560cc	66kW (89PS)	TD24692
		Diesel	Turbo Intercooled		

08-424000-00	STD	75.00	3.000		008 CK P	KV1
08-424007-00	0.50mm		1.950		005 P	F12/F14
08-424008-00	0.60mm		2.500		231 LKZ CR P	GOE12





Berlingo 1.6 HDi 75	04/08→	DV6BTED4 (9HT) Euro 4 4cyl. 1560cc 55kW (75PS) Diesel Turbo Intercooled	13 TD21321
Berlingo 1.6 HDi	09/05→	DV6BTED4 (9HW) Euro 4 4cyl. 1560cc 55kW (75PS) Diesel Turbo/Intercooled Direct Injection	TD27840
Berlingo Box 1.6 HDi 75	04/08→	DV6BUTED4 (9HT) Euro 4 4cyl. 1560cc 55kW (75PS) Diesel Turbo Intercooled	TD21322
Berlingo Box 1.6 HDi 115 C3 Picasso 1.6 HDi 115 C4 Aircross 1.6 HDi 115 C4 Aircross 1.6 HDi 115 AWC C4 Grand Picasso 1.6 HDi 110, C4 Picasso 1.6 HDi 110 DS3 1.6 HDi 115, DS4 1.6 HDi 115	07/10→ 01/13→ 04/12→ 05/12→ 09/10→ 08/12→	DV6C (9HL) 4cyl. 1560cc 82kW (111PS) Diesel Turbo	TD26985
Berlingo 1.6 HDi 110, Berlingo 1.6 HDi 115, Berlingo Box 1.6 HDi 110 C3 II 1.6 HDi 110 C3 Picasso 1.6 HDi 110 C4 1.6 HDi 110 C4 1.6 HDi 115 C4 Grand Picasso 1.6 HDi 110, C4 Picasso 1.6 HDi 110 C5 1.6 HDi 110 C5 1.6 HDi 115 C5 Break 1.6 HDi 110 C5 Break 1.6 HDi 115 DS3 1.6 HDi 110 DS4 1.6 HDi 110 DS5 1.6 HDi 110	07/10→ 11/09→ 05/10→ 11/09→ 07/12→ 09/10→ 07/10→ 01/12→ 07/10→ 01/12→ 11/09→ 04/11→ 11/11→	DV6C (9HR) 4cyl. 1560cc 82kW (111PS) Diesel Turbo	TD25690
C3, Picasso 90		DV6DBM (9HE) Euro 4 4cyl. 1560cc 66kW (89PS) Diesel Turbo Intercooled	TD25095
Berlingo 90	07/10→	DV6DTE4 (9HF) Euro 4 4cyl. 1560cc 66kW (89PS) Diesel Turbo Intercooled	TD25094
Berlingo Box 1.6 HDi 90 C3 II 1.6 HDi C3 Picasso 1.6 HDi 90 C4 1.6 HDi 90 C4 Picasso 1.6 HDi 90 DS3 1.6 HDi 90 DS3 Convertible 1.6 HDi 90 DS4 1.6 HDi 90	07/10→ 11/09→ 07/10→ 11/09→ 02/13→ 11/09→ 01/13→ 05/11→	DV6DTE4 (9HP) Euro 4 4cyl. 1560cc 68kW (92PS) Diesel Turbo Intercooled	TD25092
D53, D54 92	04/11→	DV6DTE4M (9HJ) Euro 4 4cyl. 1560cc 68kW (92PS) Diesel Turbo Intercooled	TD25093
Berlingo 1.6 HDi	05/08→	DV6ETED (9HN) Euro 4 4cyl. 1560cc 55kW (75PS) Diesel Turbo Intercooled	TD25096





Berlingo 1.6 HDI 75, Berlingo Box 1.6 HDI 75		07/05→	DV6ETED (9HW) Euro 4				
			4cyl.	1560cc	55kW (75PS)		
			Diesel	Turbo Intercooled			TD25632
C3		11/09→	DV6ETEDM (9HK) Euro 4				
			4cyl.	1560cc	55kW (75PS)		
			Diesel	Turbo Intercooled			TD25097
08-433600-00	STD	75.00	2.500		008 CK P		KV1
08-433607-00	0.50mm		1.950		026 P		F12/F14
			2.000		231 LKZ CR P		KV1
AX 14			K1B				14
			4cyl.	1360cc	44kW (60PS)		TD665
AX 14 BX 14 E		01/89→12/91 04/83→07/89	K1G				
			4cyl.	1360cc	51kW (69PS)		TD6567
BX 14			KAZ				
			4cyl.	1360cc	44-55kW (54-75PS)		TD6566
AX 1.3 Sport		04/87→12/88	TU2.4				
			4cyl.	1294cc	70kW (95PS)		TD706
C15 1.4 E		07/87→12/96	TU3 (K3A)				
			4cyl.	1360cc	40-46kW (54-63PS)		TD6569
BX 14, BX Break 14 C15 1.4		01/89→12/89 07/87→12/96	TU3A (K1H)				
			4cyl.	1360cc	47-49kW (64-67PS)		TD4272
AX 14 BX 14 E		01/89→12/91 04/83→07/89	TU3A (K6D)				
			4cyl.	1360cc	53kW (72PS)		TD25067
AX 14 BX 14 E		01/89→12/91 04/83→07/89	TU3A (K6E)				
			4cyl.	1360cc	53kW (72PS)		TD25069
AX 14 BX 14 E		01/89→12/91 04/83→07/89	TU3A (K6F)				
			4cyl.	1360cc	53kW (72PS)		TD25068
C3 II 1.4 Nemo Estate 1.4		11/09→ 04/09→	TU3A (KFT)				
			4cyl.	1360cc	54kW (73PS)		TD25070





C3 II 1.4 Nemo Box 1.4 Nemo Estate 1.4	11/09→ 02/08→ 04/09→	TU3A (KfV) 4cyl. 1360cc	54kW (73PS)	TD23774
Berlingo 1.4i Saxo 1.4i Xsara 1.4i	06/00→ 02/96→09/03 09/00→	TU3A (KfW) 4cyl. 1360cc	55kW (75PS)	TD25066
Berlingo 1.4i C3 1.4i Nemo 1.4i Saxo 1.4i	07/96→11/02 01/02→11/02 02/08→ 02/96→09/03	TU3A (KfX) 4cyl. 1360cc	55kW (75PS)	TD25074
AX 14	12/86→12/88	TU3CP (KAY) 4cyl. 1360cc	44kW (60PS)	TD9546
AX 14	06/88→12/89	TU3F2 (K1F) 4cyl. 1360cc	49kW (67PS)	TD666
AX 14	01/88→12/92	TU3F2 (K2B) 4cyl. 1360cc	62kW (84PS)	TD669
AX 1.4 GTi		TU3FJ2 (K2D) 4cyl. 1360cc	55kW (75PS)	TD6568
AX 1.4 GTi	08/91→12/96	TU3FJ2 (KfY) 4cyl. 1360cc	66kW (89PS)	TD5078
AX 1.4 GTi	06/91→12/96	TU3FJ2 (KfZ) 4cyl. 1360cc	69kW (93PS)	TD5096
AX 1.4 4x4 AX 14	09/86→07/92 01/88→12/92	TU3FM (K2A) 4cyl. 1360cc	62kW (84PS)	TD668
AX 14 AX 14 4x4 C15 1.4 i	04/87→04/97 08/91→12/96 05/91→12/96	TU3FM (KDY) 4cyl. 1360cc	55kW (75PS)	TD4277
AX 14 AX 14 4x4 ZX 1.4 i ZX Break 1.4 i	04/87→04/97 08/91→12/96 03/91→06/97 10/93→10/97	TU3M (KDX) 4cyl. 1360cc	55kW (75PS)	TD5080
AX 14 AX 14 4x4 BX 14, BX Break 14 C15 1.4 i C15 Estate 1.4 ZX Break 1.4 i	04/87→04/97 08/91→12/96 01/89→02/93 05/91→12/96 05/91→07/96 10/93→10/97	TU3M (KDY) 4cyl. 1360cc	55kW (75PS)	TD5160





AX 14			04/87→04/97	TU3M/Z (KDZ)			
AX 14 4x4			08/91→12/96		4cyl.		
AX 14 GT			01/89→12/91		1360cc	55kW (75PS)	
BX 14			01/89→02/93				
ZX 1.4, ZX 1.4 i			03/91→06/97				TD683
08-154400-00	STD	75.00	1.750		001 IF CR P		IKA
08-154407-00	0.50mm		2.000		026 P		STD
[R60880]			3.000		236 P		STD
<hr/>							
Berlingo 1.4, Berlingo 1.4 bivalent,			11/02→	TU3JP (KFW)			15
Berlingo 1.4 GNC					4cyl.		
Berlingo 1.4 Hybrid			05/05→		1360cc	55kW (75PS)	
Berlingo 1.4 i			07/96→				
Berlingo 1.4 i bivalent			04/03→				
Berlingo Box 1.4,			11/02→				
Berlingo Box 1.4 bivalent							
Berlingo Box 1.4 i			07/96→				
Berlingo Box 1.4 i bivalent			04/03→				
Saxo 1.4 VTS			05/96→06/03				
Xsara 1.4 i			04/97→03/05				
Xsara Break 1.4 i			10/97→08/05				
Xsara Coupe 1.4 i			03/98→03/05				TD14731
<hr/>							
Berlingo 1.4 i, Berlingo Box 1.4 i			07/96→	TU3JP (KFX)			
Saxo 1.4 VTS			05/96→06/03		4cyl.		
Xsara 1.4 i			04/97→03/05		1360cc	55kW (75PS)	
Xsara Break 1.4 i			10/97→08/05				
Xsara Coupe 1.4 i			03/98→03/05				
ZX 1.4 i			03/91→06/97				
ZX Break 1.4 i			10/93→10/97				TD6554
<hr/>							
C2 1.4			09/03→	TU3JP-L4 (KFV)			
C3 1.4 i, C3 1.4 i Bivalent			02/02→		4cyl.		
C3 Pluriel 1.4			05/03→		1360cc	58kW (79PS)	
C3 Pluriel 1.4 Hybrid			05/05→				TD16464
08-138900-00	STD	75.00	1.500		001 CK P		KV1
[R67020]			1.500		026 P		GOE13
			2.500		236 P		GOE13
<hr/>							
AX 1.4 D 4x4			06/91→07/92	TUD3 (K9A)			16
AX 14 D			09/88→06/92		4cyl.		
					1360cc	39kW (53PS)	
					Diesel		TD5079
<hr/>							
AX 14 D			08/91→12/97	TUD3Y (K9Y)			
ZX 1.4 D			07/94→10/97		4cyl.		
					1360cc	39kW (53PS)	
					Diesel		TD5092
08-154500-00	STD	75.00	2.250		001 IF P PS		KV1
[R60980]			1.750		005 P		IKA
			3.000		231 CR P		STD



C15 1.3	07/87→05/88	G1A	4cyl. 1294cc	47kW (64PS)	17
					TD6565

08-346000-00	STD	76.50	1.750		001 IF CR P	IKA
[R66380]			2.000		026 P	STD
			4.000		712 CR	ST

AX 15 D	08/94→12/97	TUD5 (VJY)	4cyl. 1527cc	42kW (57PS)	18
Saxo 1.5 D	09/96→09/03	Diesel			TD11890

AX 15 D	08/94→12/97	TUD5 (VJZ)	4cyl. 1527cc	42kW (57PS)	18
Saxo 1.5 D	09/96→06/01	Diesel			TD4296
Xsara 1.5 D	04/97→09/00				
Xsara Break 1.5 D	10/97→09/00				

08-325800-00	STD	77.00	2.000		001 CK P	KV1
08-325806-00	0.40mm		1.750		005 P	STD
[R49960]			3.000		231 CR P	STD

LNA 0.6	11/78→07/86	V06/630	2cyl. 652cc	25kW (34PS)	19
Visa 0.6	09/78→06/88				TD737

Axel 0.7	10/81→03/91	V06/644	2cyl. 652cc	25kW (34PS)	19
LNA 0.6	11/78→07/86				TD738
Visa 0.6	09/78→06/88				

08-150900-00	STD	77.00	1.500		001 IF P	IKA
[R66410]			2.000		026 P	STD
			3.000		712 CR	ST

Do not fit chromed rings into aluminium cylinders Keine verchromten Segmente in diese Aluminiumzylinder einbauen Ne pas monter de segments chromés dans ces cylindres aluminium No quepa los anillos cromados en los cilindros de aluminio

Saxo 1.6	02/96→04/04	TU5J4 (NFX)	4cyl. 1587cc	87kW (118PS)	20
Saxo 1.6 VTS	06/96→09/03				TD10788

Berlingo 1.6	04/08→	TU5JP4 (N6A)	4cyl. 1587cc	78-80kW (106-109PS)	20
Berlingo 1.6 16V	10/00→				
Berlingo Box 1.6	04/08→				
Berlingo Box 1.6 16V	10/00→				
C2 1.6	09/03→				
C3 1.6 16V	02/02→				
C3 Pluriel 1.6	05/03→				
C4 1.6 16V	11/04→				
C4 1.6 16V Bio-Flex	09/07→				
C4 Coupe 1.6 16V	11/04→				
C4 Saloon 1.6 16V	07/06→				
Xsara 1.6 16V	09/00→03/05				
Xsara Break 1.6 16V	09/00→08/05				
Xsara Coupe 1.6 16V	09/00→03/05				
Xsara Picasso 1.6 16V	09/05→				TD21504





Berlingo 1.6	04/08→	TU5JP4 (NFU/N6A)			
Berlingo 1.6 16V	10/00→	4cyl.			
Berlingo Box 1.6	04/08→	1587cc	80kW (109PS)		
Berlingo Box 1.6 16V	10/00→				
C2 1.6	09/03→				
C3 1.6 16V	02/02→				
C3 Pluriel 1.6	05/03→				
C4 1.6 16V	11/04→				
C4 1.6 16V Bio-Flex	09/07→				
C4 Coupe 1.6 16V	11/04→				
C4 Saloon 1.6 16V	07/06→				
Xsara 1.6 16V	09/00→03/05				
Xsara Break 1.6 16V	09/00→08/05				
Xsara Coupe 1.6 16V	09/00→03/05				
Xsara Picasso 1.6 16V	09/05→				TD15308

08-139400-00	STD	78.50	1.200		001 CK P	KV1
08-139406-00	0.40mm		1.500		026 P	GOE13
08-139407-00	0.50mm		2.500		231 P	GOE13
[R67250]						

Saxo 1.6	02/96→06/03	TU5JP (NFT/NFZ)				21
Saxo 1.6 VTL, VTR	05/96→06/03	4cyl.				
Xsara 1.6 i	04/97→09/00	1587cc	66kW (89PS)			
Xsara Break 1.6 i	10/97→09/00					
Xsara Coupe 1.6 i	02/98→09/00					
Xsara Picasso 1.6	12/99→					TD9458

Xsara Picasso 1.6	12/99→	TU5JP (NFV)				
		4cyl.				
		1587cc	70kW (95PS)			
TD23392						

08-103800-00	STD	78.50	1.500		001 CK P	KV1
08-103806-00	0.40mm		1.500		026 P	STD
→eng.922897			3.000		231 CR P	STD
[R66740]						

GS A 1.3, GS Break A 1.3	09/79→07/86	G13/625				22
		4cyl.				
		1299cc	48kW (65PS)			
TD654						

GS A 1.3, GS Break A 1.3	09/79→07/86	G13/646				
		4cyl.				
		1299cc	48kW (65PS)			
TD655						

08-147900-00	① STD	79.40	1.500		001 IF MO P	IKA
			2.000		026 P	STD
			3.000		712 CR	ST

① Ring for 2nd groove with side notch

① Ring der s. Nut mit Flankensicherung

① Segment pour être monté dans la deuxième gorge

① Segmento destinado para el montaje en la segunda ranura con



BX 1.8 D	10/85→09/93	XUD7 (161)	4cyl. 1769cc	44kW (60PS)	23
		Diesel			TD586

BX Break 1.8 D	10/85→09/93	XUD7 (161A)	4cyl. 1769cc	44kW (60PS)	
C15 1.8 D	07/86→12/00				
C15 Estate 1.8 D	04/87→08/00				
Visa 1.8 D	04/84→03/91	Diesel			
Xsara 1.8 D	04/97→09/00				
ZX 1.8 D	06/93→06/97				
ZX Break 1.8 D	10/93→10/97				TD4258

Berlingo 1.8 D	07/98→	XUD7 (A9A/161A)	4cyl. 1769cc	44kW (60PS)	
Berlingo Box 1.8 D	07/96→				
Xsara 1.8 D	04/97→09/00	Diesel			
Xsara Break 1.8 D	10/97→09/00				TD6555

08-321500-00	STD	80.00	2.000		001 CR P	KV1
08-321507-00	0.50mm				005 P	STD
08-321510-00	0.80mm		2.000		231 CR P	STD
<i>[R66400]</i>			3.000			

BX TRD Turbo	03/88→02/93	XUD7TE (A8A)	4cyl. 1769cc	66kW (89PS)	24
BX Break TRD Turbo	03/88→12/94				
		Diesel	Turbo Intercooled		TD602

BX TRD Turbo	03/88→02/93	XUD7TE (AJZ)	4cyl. 1769cc	66kW (89PS)	
BX Break TRD Turbo	03/88→12/94				
		Diesel	Turbo Intercooled		TD604

08-323600-00	STD	80.00	3.000		008 MOL P	KV1
08-323607-00	0.50mm		2.000		005 P	STD
<i>[R49910]</i>			3.000		231 CR P	STD

C5 2.7 HDi, C5 Break 2.7 HDi	02/08→	DT17ED4	V6cyl. 2720cc	150kW (204PS)	25
C6 2.7 HDi	09/05→				
		Diesel	Bi-Turbo Intercooled		TD19827

C5 II 2.7 HDi	02/08→	DT17TED4 (UHZ)	V6cyl. 2720cc	150kW (204PS)	
C6 2.7 HDi	10/05→				
		Diesel	Bi-Turbo Intercooled		TD24868

08-432400-00	STD	81.00	2.000		001 IF CK	KV1
			2.000		005 IFU	GOE13
			2.000		231	F12/F14



Berlingo 1.9 D, Berlingo 1.9 D 4WD	07/98→			DW8 (WJZ) / DW8B (WJY)						
Berlingo Box 1.9 D 70	04/99→			4cyl.						26
Berlingo Box 1.9 D 70 4WD	07/98→			1868cc				51kW (69PS)		
Jumpy 1.9 D 70, Jumpy Box 1.9 D 70	04/98→			Diesel						
Xsara 1.9 D	07/98→03/05									
Xsara Break 1.9 D	07/98→08/05									
Xsara Coupe 1.9 D	02/99→03/05									TD10708
Berlingo 1.9 D, Berlingo 1.9 D 4WD	07/98→			DW8B (WJY)						
Berlingo Box 1.9 D 70	04/99→			4cyl.						
Berlingo Box 1.9 D 70 4WD	07/98→			1868cc				51kW (69PS)		
Jumpy Box 1.9 D 70	04/98→			Diesel						
Xsara 1.9 D	07/98→03/05									
Xsara Break 1.9 D	07/98→08/05									
Xsara Coupe 1.9 D	02/99→03/05									TD15310
08-104000-00	STD	82.20	2.000		001 CK P					KV1
08-104008-00	0.60mm									
[R60230]			2.000		026 P					STD
			3.000		231 CR P					STD
BX 16	10/82→06/88			171C						27
BX Break 16	04/83→01/92			4cyl.						
				1580cc				66kW (89PS)		TD593
BX 16	10/82→06/88			XU5 (171A)						
BX Break 16	06/85→06/88			4cyl.						
				1580cc				66kW (89PS)		TD591
BX 16	09/87→02/93			XU5 (B1AA)						
				4cyl.						
				1580cc				58-59kW (79-80PS)		TD12428
BX 15	10/87→05/92			XU51C (B1E)						
BX 16	01/87→02/93			4cyl.						
BX Break 15	10/87→05/92			1580cc				53kW (72PS)		TD607
BX Break 16	09/88→12/94									
BX 16	10/82→12/92			XU52C						
				4cyl.						
				1580cc				68kW (92PS)		TD14648
BX 16	09/88→02/93			XU5CP (BAY/BAZ)						
BX Break 16	09/88→12/94			4cyl.						
				1580cc				55kW (75PS)		TD9550
Visa 16 GTI	01/85→06/86			XU5J (180A/B6D)						
				4cyl.						
				1580cc				76kW (103PS)		TD596
BX 16	03/86→02/93			XU5J (180Z)						
BX Break 16	03/86→12/94			4cyl.						
				1580cc				76kW (103PS)		TD597
BX 16	09/88→02/93			XU5J/J2/JA						
BX Break 16	09/88→12/94			4cyl.						
				1580cc				76kW (103PS)		TD9551





BX 1.6, BX Break 1.6			01/87→01/92	XU5JA (B6D)			
Visa 16 GTI			06/86→03/91		4cyl.		
					1580cc	83kW (113PS)	TD4262
Xantia 1.6 i			03/93→01/98	XU5JP (BFZ)			
Xantia 1.6 i SX			01/98→03/01		4cyl.		
ZX 1.6 i			03/91→06/97		1580cc	65kW (88PS)	TD5101
ZX Break 1.6 i			10/93→10/97				
BX 16			10/82→06/88	XU5S (171B)			
BX Break 16			06/85→06/88		4cyl.		
					1580cc	66kW (89PS)	TD592
BX 16			07/85→02/93	XU5S (171D)			
BX Break 16			07/85→12/94		4cyl.		
					1580cc	64kW (87PS)	TD594
08-151200-00	STD	83.00	1.750		001 IF CR P		IKA
<i>[R60940]</i>			1.750		026 P		STD
			4.000		712 CR		ST
Berlingo 1.8 i			05/97→	XU7JB (LFX)			28
Berlingo 1.8 i 4WD			04/97→		4cyl.		
Berlingo Box 1.8 i			08/99→10/02		1761cc	66kW (89PS)	
Xantia 1.8 i, Xantia Break 1.8 i			04/97→04/03				
Xsara 1.8 i			04/97→09/00				
Xsara Break 1.8 i			10/97→09/00				
Xsara Coupe 1.8 i			02/98→09/00				TD9457
Evasion 1.8			05/97→07/02	XU7JP (LFW/LFZ/L6A)			
Xantia 1.8 i			03/93→01/98		4cyl.		
Xantia Break 1.8 i			06/95→01/98		1761cc	73kW (99PS)	
Xsara 1.8 i Aut.			04/97→09/00				
Xsara Break 1.8 i Aut.			10/97→09/00				
Xsara Coupe 1.8 i			02/98→09/00				
ZX 1.8			07/94→10/97				
ZX 1.8 i			07/92→06/97				
ZX Break 1.8 i			10/93→10/97				TD5116
BX 19			07/86→05/89	XU92C (D2A)			
BX Break 19			07/86→12/94		4cyl.		
					1905cc	76kW (103PS)	TD628
BX 19			09/86→11/89	XU92C (D2C)			
BX Break 19			12/87→12/89		4cyl.		
					1905cc	70kW (95PS)	TD629
BX 19 E 4x4			04/89→02/93	XU92C (D2F)			
					4cyl.		
					1905cc	80kW (109PS)	TD630
BX Break 19 CAT			07/86→12/94	XU9J1 (DFZ)			
					4cyl.		
					1905cc	90kW (122PS)	TD9548





BX 19 GTi			07/86→02/93	XU9J2 (D6A)				
BX Break 1.9 TZi			02/92→12/94		4cyl.	1905cc	90kW (122PS)	
								TD631
BX 19 GTi, BX 19 GTi 4x4			06/88→02/93	XU9JA (DKZ)				
BX Break 19			06/88→12/94		4cyl.	1905cc	90kW (122PS)	
ZX 1.9 i			03/91→06/97					TD647
08-322400-00	STD	83.00	1.500		001 IF MO P			IKA
[R60950]			1.500		005 IF P			STD
			4.000		231 CR P			STD
Xantia 1.8 i 16V, Xantia Break 1.8 i 16V			06/95→04/03	XU7JP4 (LFY)				
Xsara 1.8 i 16V			04/97→09/00		4cyl.	1761cc	66-85kW (90-116PS)	29
Xsara Break 1.8 i 16V			10/97→09/00					
Xsara Coupe 1.8 i 16V			02/98→09/00					
ZX 1.8			04/96→10/97					
ZX 1.8 i 16V			01/96→06/97					
ZX Break 1.8 i 16V			01/96→02/98					TD4279
BX 19 GTi 16V			09/87→12/88	XU9J4 (D6C/DFW)				
					4cyl.	1905cc	116kW (158PS)	
								TD632
BX 19 GTi 16V			03/88→02/93	XU9J4 (DFW)				
					4cyl.	1905cc	116kW (158PS)	
								TD640
08-323400-00	STD	83.00	1.500		001 P PS			KV1
[R60190]			1.500		026 P			STD
			3.000		231 CR P			STD
BX 19 D			09/83→09/93	XUD9 (162)				
BX Break 19 D			09/83→11/94		4cyl.	1905cc	47kW (64PS)	30
								TD587
					Diesel			
BX 19 D			09/83→09/93	XUD9 (D9A)				
BX Break 19 D			09/83→11/94		4cyl.	1905cc	55kW (72PS)	
								TD4265
					Diesel			
BX 19 D			09/83→09/93	XUD9 (DJZ)				
BX Break 19 D			09/83→11/94		4cyl.	1905cc	52kW (71PS)	
Xantia 1.9 D			06/94→01/98					
ZX 1.9 D			03/91→06/97		Diesel			
ZX Break 1.9 D			10/93→10/97					TD646
Berlingo 1.9 D, Berlingo Box 1.9 D			07/96→	XUD9A (DJY)				
C25 Box 1.9 D 1400			01/88→01/94		4cyl.	1905cc	51kW (69PS)	
Jumper Box 1.9 D			07/99→04/02					
Xsara 1.9 D			04/97→09/00		Diesel			
Xsara Break 1.9 D			10/97→09/00					
Xsara Coupe 1.9 D			02/98→09/00					
ZX 1.9 D			07/93→06/97					TD6556





Berlingo 1.9 D Xantia 1.9 D	07/96→ 06/94→01/98				XUD9A/L (D9B) 4cyl. 1905cc 50kW (68PS) Diesel	TD4267
BX 19 D BX Break 19 D C25 Bus 1.9 D Jumper Box 1.9 D Jumper Bus 1.9 D Jumpy 1.9 D Jumpy Box 1.9 D ZX 1.9 D ZX Break 1.9 D	03/87→02/93 03/87→12/94 07/87→02/94 02/94→04/02 01/99→04/02 10/95→04/98 10/95→08/98 07/93→06/97 06/94→10/97				XUD9A/U (D9B) 4cyl. 1905cc 66kW (89PS) Diesel	TD4266
08-152000-00 08-152003-00 08-152007-00 08-152010-00 08-152011-00	STD 0.125mm 0.50mm 0.80mm 1.00mm	83.00	2.000 2.000 3.000	 	001 CR P 005 P 231 CR P	KV1 STD STD
[R66390]						
Xsara 1.9 SD, Xsara Break 1.9 D	01/98→09/00				XUD9BSD (DHW) 4cyl. 1905cc 55kW (75PS) Diesel	31 TD22991
Evasion 1.9 TD Jumper Box 1.9 TD, Jumper Platform/ Chassis 1.9 TD Jumpy 1.9 TD, Jumpy Box 1.9 TD Xantia 1.9 Turbo D Xantia Break 1.9 Turbo D	11/94→07/02 03/94→04/02 10/95→ 10/94→04/03 06/95→04/03				XUD9BTF (DHX) 4cyl. 1905cc 66kW (89PS) Diesel Turbo Intercooled	TD4268
Xantia 1.9 SD Xantia Break 1.9 SD	02/96→04/03 04/97→04/03				XUD9SD (DHW) 4cyl. 1905cc 66kW (89PS) Diesel Turbo Intercooled	TD10689
Xantia 1.9 Turbo D Xantia Break 1.9 Turbo D Xsara 1.9 TD Xsara Break 1.9 TD Xsara Coupe 1.9 TD ZX 1.9 TD ZX Break 1.9 TD	10/94→04/03 06/95→01/98 04/97→09/00 10/97→09/00 02/98→09/00 07/92→06/97 10/93→10/97				XUD9TE (DHY) 4cyl. 1905cc 44-66kW (60-90PS) Diesel Turbo Intercooled	TD4269
Evasion 1.9 TD Jumpy 1.9 TD Jumpy Platform/Chassis 1.9 TD Xantia Break 1.9 Turbo D	11/94→07/02 04/96→ 10/99→ 06/95→04/03				XUD9TF (D8B) 4cyl. 1905cc 66kW (89PS) Diesel Turbo Intercooled	TD5046





Jumper Box 1.9 TD			03/94→04/02	XUD9UTF (D8C)			
Jumper Bus 1.9 TD			02/94→04/02	4cyl.			
Jumper Bus 1.9 TD 4x4			08/96→04/02	1905cc	68kW (92PS)		
Jumper Platform/Chassis 1.9 TD			03/94→04/02	Diesel	Turbo Intercooled	TD4264	
08-105500-00	STD	83.00	3.000		008 CK	KV1	
08-105507-00	0.50mm				005 IF NT	IKA	
08-105510-00	0.80mm		2.000		231 CR P	STD	
01/1997→			3.000				
[R60140]							
08-325500-00	STD	83.00	3.500		008 MOL P	KV1	
08-325507-00	0.50mm				005 P	STD	
→12/1996				2.000		231 CR P	STD
[R49920]			3.000				
C25 Box 1.8, C25 Bus 1.8			11/81→01/94	169B		32	
C25 Bus 1.8 E			02/87→02/94	4cyl.	1796cc 49-51kW (69-69PS)		
						TD6575	
C25 Box 1.8, C25 Bus 1.8			11/81→01/94	XM7T (169)		33	
C25 Bus 1.8 E			07/87→02/94	4cyl.	1796cc 51kW (69PS)		
						TD588	
08-315300-00	STD	84.00	1.500		001 IF CR P	KV1	
08-315307-00	0.50mm			2.000		026 P	STD
[R66060]				4.000		712 CR	ST
C5 3.0 HDi 240, C5 Break 3.0 HDi 240, C6 3.0 HDi			04/09→	DT20C (X8C) Euro 5		33	
				V6cyl.	2993cc 177kW (240PS)		
				Diesel	Bi-Turbo Intercooled	TD24869	
C5 3.0 HDi 240, C5 Break 3.0 HDi 240, C6 3.0 HDi			04/09→	DT20C Euro 5		33	
				V6cyl.	2993cc 177kW (240PS)		
				Diesel	Bi-Turbo Intercooled	TD23526	
08-439100-00	STD	84.00	2.000		001 IF CK P	KV1	
				2.000		005 IFU P	F12/F14
				2.000		231 LKZ CR P	GOE13



C5 2.0 HDi C5 Break 2.0 HDi	03/01→08/04 06/01→08/04	DW10ATED (RHS) 4cyl. 1997cc 79kW (107PS) Diesel Turbo Intercooled	34 TD20782
C5 2.0 HDi C5 Break 2.0 HDi Evasion 2.0 HDi Jumpy 2.0 HDi 110 Jumpy Box 2.0 HDi 110 Jumpy Platform/Chassis 2.0 HDi 110 16V Xantia 2.0 HDi 109, Xantia Break 2.0 HDi 109 Xsara 2.0 HDi 109 Xsara Break 2.0 HDi 109 Xsara Coupe 2.0 HDi 109 Xsara Picasso 2.0 HDi	03/01→08/04 06/01→08/04 08/99→07/02 03/00→ 01/02→ 12/03→10/06 02/99→04/03 05/01→03/05 05/01→08/05 05/01→03/05 12/99→	DW10ATED (RHZ) 4cyl. 1998cc 80kW (109PS) Diesel Turbo Intercooled	TD12829
C8 2.0 HDi	07/02→	DW10ATED4 (RHM) 4cyl. 1997cc 79kW (107PS) Diesel Turbo Intercooled	TD20786
C8 2.0 HDi	07/02→	DW10ATED4 (RHT) 4cyl. 1997cc 79kW (107PS) Diesel Turbo Intercooled	TD20785
C8 2.0 HDi Evasion 2.0 HDi 16V Jumpy 2.0 HDi 110 Jumpy Box 2.0 HDi 110 Jumpy Platform/Chassis 2.0 HDi 110	07/02→ 09/99→07/02 03/00→ 01/02→ 12/03→10/06	DW10ATED4 (RHW) 4cyl. 1997cc 80kW (109PS) Diesel Turbo Intercooled	TD20784
Jumpy 2.0 HDi 95, Jumpy Box 2.0 HDi 95, Jumpy Platform/Chassis 2.0 HDi 95	10/99→	DW10BTED (RHX) 4cyl. 1997cc 69kW (93PS) Diesel Turbo Intercooled	TD21039
C4 2.0 HDi, C4 Coupe 2.0 HDi C5 2.0 HDi C5 2.0 HDi 140, C5 Break 2.0 HDi 140	07/08→ 02/08→ 04/09→	DW10BTED4 (RHF) 4cyl. 1997cc 100-103kW (136-140PS) Diesel Turbo Intercooled	TD26795
C4 Grand Picasso 2.0 HDi 138 C4 Picasso 2.0 HDi 138	10/06→ 02/07→	DW10BTED4 (RHJ) Euro 4 4cyl. 1997cc 100kW (136PS) Diesel Turbo Intercooled	TD19825
C4 2.0 HDi, C4 Coupe 2.0 HDi C4 Grand Picasso 2.0 HDi 138 C4 Picasso 2.0 HDi 138 C5 2.0 HDi, C5 Break 2.0 HDi C8 2.0 HDi 135 Jumpy 2.0 HDi 140, Jumpy Box 2.0 HDi 140	11/04→ 10/06→ 02/07→ 09/04→ 03/06→ 01/07→	DW10BTED4 (RHR) Euro 4 4cyl. 1997cc 100kW (136PS) Diesel Turbo Intercooled	TD19912
Jumper Box 2.0 HDi	04/02→	DW10TD (RHV) 4cyl. 1997cc 62kW (84PS) Diesel Turbo Intercooled	TD24877





Berlingo 2.0 HDi 4x4	11/02→10/05	DW10TD (RHY)				
Berlingo 2.0 HDi 90,	12/99→	4cyl.				
Berlingo Box 2.0 HDi 90		1998cc	63kW (86PS)			
Berlingo Box 2.0 HDi 90 4WD	11/00→	Diesel	Turbo Intercooled			
C5 2.0 HDi	03/01→08/04					
C5 Break 2.0 HDi	06/01→08/04					
Xantia 2.0 HDi 90,	03/99→04/03					
Xantia Break 2.0 HDi 90						
Xsara 2.0 HDi 90	02/99→03/05					
Xsara Box 2.0 HDi	09/00→03/05					
Xsara Break 2.0 HDi 90	02/99→08/05					
Xsara Coupe 2.0 HDi 90	02/99→03/05					
Xsara Picasso 2.0 HDi	12/99→					TD15311
Jumper Box 2.0 HDi	11/01→	DW10UTD (RHW)				
Jumper Bus 2.0 HDi, Jumper Platform/ Chassis 2.0 HDi	04/02→	4cyl.				
		1997cc	62kW (84PS)			
		Diesel	Turbo Intercooled			TD16739
C8 2.0 HDi	02/07→	DW10UTED4 (RHK)				
Jumpy 2.0 HDi 120, Jumpy Box 2.0 HDi 120	01/07→	4cyl.				
		1997cc	79kW (107PS)			
		Diesel	Turbo Intercooled			TD20787
C8 2.2 HDi	07/02→	DW12TED4 (4HW)				
		4cyl.				
		2179cc	94kW (128PS)			
		Diesel				TD20024
C5 2.2 HDi	03/01→	DW12TED4/FAP (4HX)				
C5 Break 2.2 HDi	06/01→	4cyl.				
		2179cc	100kW (136PS)			
		Diesel	Turbo Intercooled			TD16165
Jumper Box 2.2 HDi, Jumper Bus 2.2 HDi	04/02→	DW12UTED (4HY)				
Jumper Platform/Chassis 2.2 HDi	02/02→06/06	4cyl.				
Jumper Platform/Chassis 2.2 HDi 16V	04/02→	2179cc	74kW (100PS)			
		Diesel	Turbo Intercooled			TD24468
08-114700-00	STD	85.00	3.500		008 CK P	KV1
08-114708-00	0.60mm		2.000		005 IFU P	STD
[R60410]			3.000		231 CR P	STD
C5 2.2 HDi 200, C5 Break 2.2 HDi 200	07/10→	DW12C (4HL)				
		4cyl.				
		2179cc	150kW (204PS)			
		Diesel	Turbo Intercooled			TD26899
C-Crosser 2.2 HDi	02/07→	DW12MTED4 (4HN)				
C-Crosser Enterprise 2.2 HDi	01/09→	4cyl.				
		2179cc	115kW (156PS)			
		Diesel	Turbo Intercooled			TD24713
08-436700-00	STD	85.00	2.500		008 GDC P	KV1
			2.000		005 IFU P	STD
			2.000		231 LKZ CK	GOE13



XM 2.1 TD 12V XM Break 2.1 TD 12V	05/89→10/00 11/91→04/94	XUD11ATE (P8A) 4cyl. 2088cc 80-81kW (109-110PS) Diesel Turbo Intercooled	36 TD711
--------------------------------------	----------------------------	--	--------------------

XM 2.1 TD 12V XM Break 2.1 TD 12V	05/89→10/00 11/91→10/00	XUD11ATE (PHZ) 4cyl. 2088cc 80-81kW (109-110PS) Diesel Turbo Intercooled	TD717
--------------------------------------	----------------------------	--	--------------

XM 2.1 TD 12V XM Break 2.1 TD 12V	05/89→10/00 11/91→10/00	XUD11ATE (PJZ) 4cyl. 2088cc 80kW (109PS) Diesel Turbo Intercooled	TD718
--------------------------------------	----------------------------	---	--------------

08-154900-00 STD 08-154908-00 0.60mm	85.00	3.000		008 P PS	KV1
[R60550]		2.000		005 P	F12/F14
		3.000		231 CR P	STD

Evasion 2.1 TD Xantia 2.1 Turbo D 12V Xantia Break 2.1 Turbo D 12V XM 2.1 TD 12V XM Break 2.1 TD 12V	05/96→07/02 06/95→02/99 06/96→02/99 05/94→10/00 11/91→10/00	XUD11BTE (P8C) 4cyl. 2088cc 81kW (110PS) Diesel Turbo Intercooled	37 TD4281
--	---	---	---------------------

08-126600-00 STD 08-126608-00 0.60mm	85.00	3.000		008 CK P	KV1
[R60670]		2.000		005 IF NT	IKA
		3.000		231 CR	STD

Jumper Box 2.2 HDi 120, Jumper Bus 2.2 HDi 120, Jumper Platform/ Chassis 2.2 HDi 120	04/06→	P22DTE (4HU) Euro 4 4cyl. 2198cc 88kW (120PS) Diesel Turbo Intercooled	38 TD24538
--	--------	--	----------------------

Jumper Box 2.2 HDi 100, Jumper Bus 2.2 HDi 100, Jumper Platform/ Chassis 2.2 HDi 100	04/06→	P22DTE (4HV) Euro 4 4cyl. 2198cc 74kW (100PS) Diesel Turbo Intercooled	TD24537
--	--------	--	----------------

08-427700-00 STD 08-427707-00 0.50mm	86.00	2.000		001 IF CK P	KV1
		2.000		026 P	GOE13
		2.000		231 NT	ST

XM 2.0, XM Break 2.0	05/89→06/94	R6A 4cyl. 1998cc 90-96kW (122-130PS) Diesel Turbo Intercooled	39 TD22606
----------------------	-------------	---	----------------------

XM Break 2.0 i	11/91→04/94	XU102C (R2A) 4cyl. 1998cc 79kW (107PS) Diesel Turbo Intercooled	TD12830
----------------	-------------	---	----------------

Jumper Box 2.0 Jumper Box 2.0 bivalent Jumper Bus 2.0 Jumper Bus 2.0 bivalent	04/02→ 02/03→ 04/02→ 02/03→	XU10J2 4cyl. 1998cc 89kW (121PS) Diesel Turbo Intercooled	TD16738
--	--------------------------------------	---	----------------





XM 2.0 i XM Break 2.0 i	05/89→06/94 11/91→04/94	XU10J2 (RFZ)	4cyl. 1998cc	89-90kW (121-122PS)	TD729
Evasion 2.0	06/94→07/02	XU10J2C (RFU)	4cyl. 1998cc	89kW (121PS)	TD4284
Xantia 2.0 i Xantia Break 2.0 i ZX 2.0 ZX 2.0 i	03/93→04/03 06/95→04/03 07/94→10/97 07/92→06/97	XU10J2C (RFX)	4cyl. 1998cc	89-90kW (120-122PS)	TD727
Xantia 2.0i ZX 2.0i	03/93→12/01 07/92→10/97	XU10J2C/Z L3 (RFX)	4cyl. 1998cc	89-95kW (121-129PS)	TD4286
Evasion 2.0 Turbo C.T. Xantia 2.0 Turbo, Xantia Break 2.0 Turbo XM 2.0 Turbo, XM Break 2.0 Turbo	06/94→07/02 06/95→04/03 05/94→10/00	XU10J2TE (RGX)	4cyl. 1998cc Turbo Intercooled	108kW (147PS)	TD4290
XM 2.0 i Turbo XM Break 2.0 Turbo	09/92→06/94 09/92→10/00	XU10J2TE (RGX/RGY)	4cyl. 1998cc Turbo Intercooled	108kW (147PS)	TD4291
Jumper Box 2.0 Jumper Box 2.0 4x4 Jumper Bus 2.0 Jumper Bus 2.0 4x4 Jumper Platform/Chassis 2.0	03/94→04/02 10/96→01/02 02/94→04/02 08/96→04/02 03/94→04/02	XU10J2U (RFW)	4cyl. 1998cc	80kW (109PS)	TD4285
Xantia 2.0 i 16V ZX 2.0 i 16V	06/94→01/98 07/92→06/97	XU10J4 (RFT)	4cyl. 1998cc	112kW (152PS)	TD5066
Xantia 2.0 i 16V ZX 2.0 i 16V	03/93→01/98 07/92→10/94	XU10J4 (RFY)	4cyl. 1998cc	112kW (152PS)	TD4288
Evasion 2.0 16V Xantia 2.0 i 16V, Xantia Break 2.0 i 16V XM 2.0 i 16V, XM Break 2.0 i 16V Xsara 2.0 16V, Xsara Break 2.0 16V Xsara Coupe 2.0	05/98→04/00 06/95→04/03 05/94→10/00 07/98→09/00 08/98→08/00	XU10J4R (RFV)	4cyl. 1998cc	99kW (135PS)	TD11667

08-154600-00	STD	86.00	1.500		001 IF MO P	IKA
08-154605-00	0.25mm		1.750		026 P	STD
08-154608-00	0.60mm		3.000		712 CR	ST
[R60210]						

XM 2.1 D 12V XM 2.1 D12 VSX XM Break 2.1 D 12V XM Break 2.1 D12	05/89→06/94 03/96→08/96 11/91→04/94 07/94→06/96	XUD11A (P9A/PJZ)	4cyl. 2138cc Diesel	61kW (82PS)	TD713	40
--	--	------------------	---------------------------	-------------	-------	-----------

08-154700-00	STD	86.00	2.500		001 P PS	KV1
			2.000		005 P	F12/F14
			3.000		231 CR P	STD
[R67440]						



Jumpy 1.6	10/95→	220 A2.000							
Jumpy Box 1.6	10/95→08/00		4cyl.						41
Jumpy Box 1.6 i	10/95→		1581cc	59kW (80PS)					
									TD6587

08-783700-00	STD	86.40	1.500		001 IF CR P		IKA
08-783706-00	0.40mm				026 P		STD
08-783708-00	0.60mm		1.750		712 CR		ST
08-783711-00	1.00mm		3.000				
[R46950]							

Xantia 3.0 i 24V	01/97→01/98	ES9J4 (XFZ)							
Xantia 3.0 V6, Xantia Break 3.0 V6	01/98→04/03		V6cyl.						42
XM 3.0 V6, XM Break 3.0 V6	04/97→10/00		2946cc	152kW (207PS)					
									TD5487

C5 3.0 V6	03/01→	ES9J4S (XFV)							
C5 Break 3.0 V6	06/01→08/04		V6cyl.						
C6 3.0 V6	09/05→		2946cc	152kW (207PS)					
C8 3.0 V6	07/02→								TD16164

08-101400-00	STD	87.00	1.500		001 CK P		KV1
[R66750]			1.500		026 P		STD
			3.000		236 P		STD

CX I 2000, CX I Break 2000	06/79→08/85	829.A5							
CX II 20 RE	08/85→12/92		4cyl.						43
CX II Break 20	08/85→08/86		1995cc	78kW (106PS)					
									TD4259

CX I 2200, CX I Break 2200	06/81→08/85	J6TA 500 / J6RA 500							
CX II 22 TRS, CX II Break 22 TRS	07/85→12/92		4cyl.						
CX II Break 22TRS	07/85→07/89		2165cc	83-85kW (113-116PS)					
									TD663

08-334400-00	STD	88.00	1.750		001 IF MO P		IKA
[R66300]			2.000		026 P		STD
			4.000		712 CR		ST

C25 Box 2.0 E	09/81→03/94	XN1T (170A)							
C25 Bus 2.0 E	09/81→02/94		4cyl.						44
			1971cc	57kW (77PS)					
									TD5164

C25 Box 2.0 E	09/81→03/94	XN1T (170B)							
C25 Bus 2.0 E	09/81→02/94		4cyl.						
			1971cc	57kW (77PS)					
									TD589

C25 Box 2.0	02/91→03/94	XN1T (170C)							
C25 Bus 2.0	02/91→02/94		4cyl.						
C25 Platform/Chassis 2.0	01/87→03/94		1971cc	57kW (77PS)					
									TD590

08-316900-00	STD	88.00	1.500		001 IF CR P		IKA	
08-316907-00	0.50mm			2.000		026 P		STD
[R66110]				4.000		712 CR		ST



Jumper Box 2.5 D	03/94→04/02	DJ5 (T9A)						45
Jumper Box 2.5 D 4x4	03/00→04/02		4cyl.					
Jumper Bus 2.5 D	08/94→04/02		2446cc	63kW (86PS)				
Jumper Bus 2.5 D 4x4	08/96→04/02	Diesel						
Jumper Platform/Chassis 2.5 D	03/94→04/02							
Jumper Platform/Chassis 2.5 D 4x4	03/00→04/02							TD4293

08-112400-00	STD	92.00	2.250		001 CK P		KV1
08-112407-00	0.50mm		2.000		026 P		GOE13
[R67380]			2.000		231 CR P		GOE12

Jumper Box 2.5 TD	03/94→04/02	DJ5T (T8A)						46
Jumper Bus 2.5 TD	08/94→04/02		4cyl.					
Jumper Bus 2.5 TD 4x4	08/96→04/02		2446cc	76kW (103PS)				
Jumper Platform/Chassis 2.5 TD	03/94→04/02	Diesel	Turbo Intercooled					TD4292

08-118900-00	STD	92.00	3.500		008 P PS		KV1
08-118907-00	0.50mm		2.000		026 P		GOE13
[R60450]			3.000		231 CR P		GOE13
08-326300-00	STD	92.00	3.000		008 P PS		KV1
08-326307-00	0.50mm		1.750		005 IF CR P		IKA
[R67430]			3.500		231 CR P		STD

Jumper Box 2.5 TDi	12/96→11/00	DJ5TED (THX)						47
Jumper Box 2.5 TDi 4x4	03/00→11/00		4cyl.					
Jumper Bus 2.5 TDi,	12/96→11/00		2446cc	79kW (107PS)				
Jumper Bus 2.5 TDi 4x4		Diesel	Turbo Intercooled					
Jumper Platform/Chassis 2.5 TDi	12/96→04/02							
Jumper Platform/Chassis 2.5 TDi 4x4	03/00→04/02							TD11889

08-135800-00	STD	92.00	3.500		008 P PS		KV1
08-135807-00	0.50mm		2.000		026 P		GOE13
[R66650]			3.500		231 CR P		GOE13

XM 2.5 TD, XM Break 2.5 TD	05/94→10/00	DK5ATE (THY)						48
			4cyl.					
			2446cc	95kW (129PS)				
		Diesel	Turbo Intercooled					TD4294

Jumper 2.5 TD	02/94→02/02	THZ						
			4cyl.					
			2446cc	76kW (103PS)				
		Diesel	Turbo Intercooled					TD6585

08-326300-00	STD	92.00	3.000		008 P PS		KV1
08-326307-00	0.50mm		1.750		005 IF CR P		IKA
[R67430]			3.500		231 CR P		STD



C35 Box 2.5 D, C35 Bus 2.5 D, C35 Pickup 2.5 D		02/80→01/94	B25/637	4cyl. 2500cc	51kW (69PS)	49
			Diesel			TD6895
			CRD93B	4cyl. 2499cc	50kW (68PS)	
			Diesel			TD6577
C25 Box 2.5 D		11/81→01/94	CRD93L (U25/661)	4cyl. 2500cc	54-55kW (73-75PS)	
C25 Bus 2.5 D		10/85→02/94				
C25 Bus 2.5 D 4x4		01/87→02/94				
C25 Platform/Chassis 2.5 D		11/83→01/94	Diesel			TD625
			M22-629	4cyl. 2499cc	55kW (75PS)	
			Diesel			TD23453
CX I 2500 D		02/78→06/82	M25/629	4cyl. 2500cc	55kW (75PS)	
CX I Break 2500 D		02/78→08/85				
			Diesel			TD693
CX II 25 D		08/85→12/92	M25/660	4cyl. 2500cc	54kW (73PS)	
CX II Break 25 D		05/86→12/92				
			Diesel			TD696
			M25-637	4cyl. 2499cc	55kW (75PS)	
			Diesel			TD23454
			M25-661	4cyl. 2499cc	55kW (75PS)	
			Diesel			TD23455
08-147300-10	STD	93.00	2.000		001 MOL P	KV1
→07/1984			2.000		005 IF P	STD
			4.000		231 CR P	STD
08-152700-00	STD	93.00	2.500		001 MOL P	KV1
08-152707-00	0.50mm		2.000		005 IF P	STD
08/1984→			4.000		231 CR P	STD
[R60970]						
08-214400-10	STD	93.00	2.000		001 CR P	KV1
[R60960]			2.000		005 IF P	STD
			4.000		231 CR P	STD
C25 Box 2.5 DT, C25 Box 2.5 DT 4x4		08/91→01/94	CRD93LS (U25/673)	4cyl. 2500cc	70kW (95PS)	50
C25 Bus 2.5 D Turbo,		08/87→02/94				
C25 Bus 2.5 D Turbo 4x4			Diesel	Turbo		TD626
C25 Platform/Chassis 2.5 DT		01/87→01/94				
CX II 25 D Turbo,		01/87→12/92	M25/669	4cyl. 2500cc	88kW (120PS)	
CX II Break 25 D Turbo 2						
			Diesel	Turbo Intercooled		TD702





CX I 25 D Turbo, CX I Break 2500 D Turbo		04/83→08/85	M25-648		4cyl.		
CX II 25 D Turbo,		08/85→12/86			2500cc	70kW (95PS)	
CX II Break 2500 D Turbo					Diesel	Turbo	TD694

08-152900-00	STD	93.00	3.000		008 MOL P		KV1
[R60990]			2.000		001 IF CR P		STD
			4.000		231 CR P		STD

C35 D		01/74→12/92	XD3, XD3P		4cyl.		51
					2498cc		
					Diesel		FM2303

08-318700-10	STD	94.00	2.000		001 CR P		KV1
08-318704-10	0.20mm						
08-318706-10	0.40mm		2.000		005 IF P		STD
08-318707-10	0.50mm						
08-318708-10	0.60mm		4.000		231 CR P		STD
08-318710-10	0.80mm						
[R66140]							

Jumper Box 2.8 HDi, Jumper Platform/Chassis 2.8 HDi		05/04→	8140.43N		4cyl.		52
					2798cc	107kW (146PS)	
					Diesel	Turbo Intercooled	TD18297

Jumper Box 2.8 HDi, Jumper Box 2.8 HDi 4x4, Jumper Bus 2.8 HDi		09/00→	8140.43S Euro 3		4cyl.		
Jumper Bus 2.8 HDi 4x4		09/00→04/02			2798cc	92kW (125PS)	
Jumper Bus 2.8 HDi All-wheel Drive		04/02→			Diesel	Turbo Intercooled	
Jumper Platform/Chassis 2.8 HDi		09/00→					TD17849

Jumper Platform/Chassis 2.8 HDi 4x4		02/02→06/06	F28TDCR Euro 3		4cyl.		
					2798cc	92kW (125PS)	
					Diesel	Turbo Intercooled	TD16741

08-122200-00	STD	94.40	2.500		008 CK P		KV1
08-122208-00	0.60mm						
[R60070]			2.000		005 P		IKA
			2.500		231 CR P		GOE12

Jumper Box 2.8 D, Jumper Bus 2.8 D, Jumper Platform/Chassis 2.8 D		01/99→02/02	8140.63 (F28D)		4cyl.		53
					2798cc	64kW (87PS)	
					Diesel		TD24977

08-108200-00	STD	94.40	3.000		008 CR P		KV1
08-108208-00	0.60mm						
[R60060]			2.000		026 P		STD
			2.500		231 CR P		STD



1

13.5 CU.FT (Air Compressor),
15 CU.FT. (Air Compressor)

1cyl.

FM353

08-522200-00	STD	66.69	1.976		005 IF	STD
[R31420]			1.976		005 IF	STD
			1.976		005 IF	STD
			1.976		005 IF	STD
			3.967		030	STD

Motorverzeichnis • Index de moteur • Índice de Motor
Indeks silnika • Модель двигателя • دليل المحرك

ENGINE INDEX



CCM

x



9

Bosch (MB OM355, Hino, Mitsubishi, Nissan)	Petrol	1	80.00	13
DAF 1160WS, Volvo	Petrol	2	75.00	7
IFA (L60, W50)	Petrol	1	70.00	4
Iveco (EuroTrakker 370,420)	Petrol	2	82.00	14
Knorr (MB OM355/360A, MAN D21)	Petrol	1	88.00	19
Knorr Bremse (Iveco ACX82)	Petrol	2	82.00	15
LKW	Petrol	1	72.00	6
MAN (D08)	Petrol		88.00	20
MAN (D25/28)	Petrol	1/2	90.00	21
MAN (D2066 (TGA 390,400,430))		1	92.00	23
Marelli (Fiat 619,673,684,690,691,697)	Petrol	1	70.00	5
Mercedes Benz (OM355/OM360/A/LA)	Petrol	1	88.00	20
Mercedes Benz (OM360/400/420/440)	Petrol	1/2	90.00	21
Mercedes Benz (OM447)	Petrol		100.00	25
Mercedes-Benz (OM312/314/321/352/352A)	Petrol	1	77.00	12
Mercedes-Benz (OM366)	Petrol	1	75.00	8
Mercedes-Benz (OM366/A/LA)	Petrol		88.00	20
Mercedes-Benz (OM402/501/502/541/542/LA)	Petrol	1	100.00	26
Westinghouse (DAF 825/1160)	Petrol	2	85.00	16
Westinghouse (Fiat 306,682,690)	Petrol	1	85.00	17
Westinghouse (MB OM314/352/362/364/366/A/LA)	Petrol	1	94.00	24
Westinghouse (MB OM352A/360, DAF 825/1160)	Petrol	1	75.00	9
Westinghouse (MB OM457/904/906, DAF 825/1160)	Petrol	1	85.00	18
Westinghouse (Volvo TD121)	Petrol	2	63.50	2
Westinghouse P4 (MB OM355)	Petrol	1	60.00	1
Westinghouse P4 (MB OM360)	Petrol	2	60.00	1
Westinghouse PT237 (KHD)	Petrol		75.00	10
Westinghouse TU-FLO 500 (Volvo TD50,60,70,100)	Petrol	2	63.50	3
Westinghouse WB15 (Scania DS11/14)	Petrol	2	75.00	11
Westinghouse WB15 (Volvo TD100)	Petrol	2	75.00	11
Westinghouse/Knorr (KHD FL413/F)	Petrol	1	90.00	21
Westinghouse/Knorr (KHD FL413/F)	Petrol	2	90.00	21
Westinghouse/Knorr (MB OM400/420/440, MAN D28)	Petrol	1	90.00	22



1

Westinghouse P4 (MB OM355) 1cyl. **FM8597**

Westinghouse P4 (MB OM360) 2cyl. **FM8792**

08-400600-20	STD	60.00	2.500		026	STD
			2.500		026	STD
			4.000		032	STD
08-403200-00	STD	60.00	2.500		026 P	STD
			2.500		026 P	STD
			4.000		032 P	STD

2

Westinghouse (Volvo TD121) 2cyl. **FM8598**

08-408600-00	STD	63.50	2.385		005 IF P	STD
08-408605-00	0.50mm		2.385		005 IF P	STD
08-408607-00	0.50mm		2.385		005 IF P	STD
			2.385		005 IF P	STD
			2.385		005 IF P	STD
			2.385		031 P	STD

3

Westinghouse TU-FLO 500 (Volvo TD50, 60, 70, 100) 2cyl. **FM8599**

08-990800-00	STD	63.50	2.385		005 IW P	STD
08-990805-00	0.25mm		2.385		005 IW P	STD
08-990807-00	0.50mm		2.385		005 IW P	STD
			3.160		001 IF P	STD
			3.160		032 P	STD

4

IFA (L60, W50) 1cyl. **FM8692**



08-248200-00	STD	70.00	2.500		001 P	STD
08-248207-00	0.50mm		2.500		001 P	STD
			4.000		030 P	STD
			4.000		030 P	STD



5

Marelli (Fiat 619, 673, 684, 690, 691, 697) 1cyl.

FM8624

08-207000-00	STD	70.00	2.000		005 IF P	STD
			2.000		023 P	STD
			4.000		032 P	STD

6

LKW 1cyl.



FM8977

08-269400-00	STD	72.00	2.000		005 P	STD
			2.000		005 P	STD
			4.170		031 P	STD

7

DAF 1160WS, Volvo 2cyl.

FM8794

08-325400-00	STD	75.00	2.000		026 P	STD
08-325405-00	0.25mm		2.000		026 P	STD
08-325407-00	0.50mm		4.000		232	STD

[R67240]

8

Mercedes-Benz (OM366) 1cyl.



FM8625

08-742500-00	STD	75.00	2.500		023 P	STD
			2.500		023 P	STD
			2.500		023 P	STD
			4.000		030 P	STD

9

Westinghouse (MB OM352A/360, DAF 825/1160) 1cyl.



FM8797

08-403600-00	STD	75.00	3.000		026 P	STD
08-403607-00	0.50mm		3.000		026 P	STD
			5.000		032 P	STD

10

Westinghouse PT237 (KHD)

FM8601

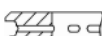
08-401200-00	STD	75.00	3.000		023 P	STD
			3.000		023 P	STD
			3.000		023 P	STD
			5.000		032 P	STD



11

Westinghouse WB15 (Scania DS11/14) 2cyl.

FM8603

Westinghouse WB15 (Volvo TD100) 2cyl.

FM1846

08-990700-00	STD	75.00	2.385		005 P	STD
08-990705-00	0.25mm				026 P	STD
08-990707-00	0.50mm					032 P
[R32840]			3.947			

12

Mercedes-Benz (OM312/314/321/352/352A) 1cyl.

FM8604

08-165800-00	STD	77.00	2.500		005 IF P	STD	
08-165805-00	0.25mm					005 IF P	STD
				2.500		023 P	STD
				3.000		031 P	STD
			4.000				

13

Bosch (MB OM355, Hino, Mitsubishi, Nissan) 1cyl.

FM8629

08-131900-00	STD	80.00	2.500		023 IF P	STD	
				2.500		023 IF P	STD
				2.500		023 IF P	STD
				4.000		031 P	STD

14

Iveco (EuroTrakker 370, 420) 2cyl.

FM25603

08-139900-00	STD	82.00	2.500		026 P	STD	
[R67390]				2.500		026 P	STD
				4.000		232 P	STD

15

Knorr Bremse (Iveco ACX82) 2cyl.

FM9263

08-529200-00	STD	82.00	1.500		026 P	GOE12	
08-529204-00	0.20mm					026 P	GOE12
08-529207-00	0.50mm					232 P	GOE12
[R49630]			3.000				



16

Westinghouse (DAF 825/1160) 2cyl.				FM8795		
08-741700-00	STD	85.00	2.000		005 IW P	STD
			2.000		005 IW P	STD
			2.000		005 IW P	STD
			4.747		031 P	STD

17

Westinghouse (Fiat 306, 682, 690) 1cyl.				FM8605		
08-401000-00	STD	85.00	2.500		005 P	STD
			2.500		023 P	STD
			2.500		023 P	STD
			4.000		712 CR	ST
			4.000		031 P	STD

18

Westinghouse (MB OM457/904/906, DAF 825/1160) 1cyl.				FM15572		
08-741200-00	STD	85.00	2.000		026 P	STD
08-741204-00	0.20mm		2.000		026 P	STD
08-741205-00	0.25mm		4.000		032 P	STD
08-741207-00	0.50mm					
[R67810]						

19

Knorr (MB OM355/360A, MAN D21) 1cyl.				FM8627		
08-251000-00	STD	88.00	2.000		023 IF P	STD
08-251007-00	0.50mm		2.000		023 P	STD
08-251011-00	1.00mm		2.500		023 IF P	STD
			5.000		231 P	STD

20

MAN (D08)				FM8628		
Mercedes Benz (OM355/OM360/A/LA) 1cyl.				FM8626		
Mercedes-Benz (OM366/A/LA)				FM8963		
08-742600-00	STD	88.00	2.500		026 P	STD
08-742605-00	0.25mm		2.500		026 P	STD
			4.000		032 P	STD
[R67975]						



21

MAN (D25/28) 1/2cyl. **FM5548**

Mercedes Benz (OM360/400/420/440) 1/2cyl. **FM5572**

Westinghouse/Knorr (KHD FL413/F) 1cyl. **FM8796**

Westinghouse/Knorr (KHD FL413/F) 2cyl. **FM8799**

08-136200-00	STD	90.00	2.500		023 P	STD
			2.500		023 P	STD
			4.000		231 P	STD
08-404500-00	STD	90.00	2.500		005 P	STD
			2.500		023 P	STD
			4.000		712 CR	ST

22

Westinghouse/Knorr 1cyl. **FM8964**
(MB OM400/420/440, MAN D28)

08-176300-00	STD	90.00	2.500		005 IF P	STD		
			08-176307-00	0.50mm		023 P	STD	
			08-176311-00	1.00mm	2.500		023 P	STD
			4.000		231 P	STD		

23

MAN (D2066 (TGA 390, 400, 430)) 1cyl. **FM15548**

08-434800-00	STD	92.00	2.500		005 IFU P	F12/F14
			2.500		026 P	F12/F14
			4.000		232 P	STD

24

Westinghouse 1cyl. **FM8607**
(MB OM314/352/362/364/366/A/LA)

08-177400-00	STD	94.00	2.500		023 IF P	STD	
			08-177405-00	0.25mm		023 IF P	STD
			08-177407-00	0.50mm	2.500		023 IF P

25

Mercedes Benz (OM447) **FM5603**

08-121700-00	STD	100.00	2.500		026 P	STD
			2.500		026 P	STD
			3.000		232 P	GOE13





26

Mercedes-Benz
(OM402/501/502/541/542/LA)

1cyl.

FM15603

08-140500-00	STD	100.00	2.500		026 P	STD
08-140507-00	0.50mm		2.500		026 P	STD
			4.000		231 CR	GOE13



							1
6 BT			6cyl.	5880cc	118kW (160PS)	Diesel Turbo	TD6966
Fatih 4BT			4cyl.	3900cc		Diesel	FM9010
08-155200-00	STD	102.00	3.000		008 CR P		KV1
			2.350		005 IF P		STD
			4.000		231 CR P		STD

							2
6 BT5.9			6cyl.	5880cc	108kW (147PS)	Diesel Turbo	TD6613
6 BTA			6cyl.	5880cc	118kW (160PS)	Diesel Turbo Intercooled	TD7047
08-145000-00 08-145007-00 08-145008-00	STD 0.50mm 0.60mm	102.00	3.000		008 CK P		KV1
			2.390		005 IF P		GOE13
			4.000		231 CR P		GOE13
[R66730]							

							3
BN 25			4cyl.			Diesel	FM9011
CD 85, CN, CN 96			6cyl.	5880cc	96kW (131PS)	Diesel	FM9012
08-742100-00	STD	102.00	2.400		001 CR P		KV1
			2.350		005 IF P		STD
			4.000		231 CR P		STD

							4
6 CT 8.3			6cyl.	8270cc	160kW (218PS)	Diesel Turbo	TD7558
08-155600-10	STD	114.00	3.500		008 IW CR P		KV1
			3.000		009 IWU P		F12/F14
			4.000		231 CR P		STD

							5
V6-155			6cyl.	378cc		Diesel	FM2848
V8-210			8cyl.	504cc		Diesel	FM2849
08-520800-00	STD	117.47	3.048		008 CR		
			2.381		005 IW		
			2.769		231		
[R31630K]							



CCM

x



9

01/65→	1210	688-09	Petrol	1108	4	2
12/72→05/83	1300 1.3	810-02/-99	Petrol	1289	4	3
12/72→05/83	1300 Estate 1.3	810-02/-99	Petrol	1289	4	3
06/83→08/90	1304 Platform/Chassis 1.3	810-02/-99	Petrol	1289	4	3
05/83→07/04	1310 Estate 1.3	810-02/-99	Petrol	1289	4	3
05/83→07/04	1310 Saloon 1.3	810-02/-99	Petrol	1289	4	3
04/10→	Duster 1.5 dCi	K9K 796	Diesel	1461	4	5
10/10→	Duster 1.5 dCi	K9K 892	Diesel	1461	4	5
06/10→	Duster 1.5 dCi	K9K 896	Diesel	1461	4	5
10/10→	Duster 1.5 dCi 4x4	K9K 894	Diesel	1461	4	5
06/10→	Duster 1.5 dCi 4x4	K9K 898	Diesel	1461	4	5
04/10→	Duster 1.6 16V	K4M 690	Petrol	1598	4	6
04/10→	Duster 1.6 16V	K4M 696	Petrol	1598	4	6
08/10→	Duster 1.6 16V Hi-Flex	K4M 696	Petrol	1598	4	6
04/11→	Duster 1.6 16V LPG	K4M 696	Petrol	1598	4	6
02/06→	Logan (LS_) 1.2 16V	D4F732		1149	4	1
09/04→	Logan 1.4	K7J 710	Petrol	1390	4	6
02/06→	Logan 1.4 MPI LPG	K7J 710	Petrol	1390	4	6
02/06→	Logan 1.4 MPI LPG	K7J 714	Petrol	1390	4	6
09/05→	Logan 1.5 dCi	K9K 790	Diesel	1461	4	5
01/06→	Logan 1.5 dCi	K9K 792 Euro 4	Diesel	1461	4	5
09/07→	Logan 1.5 dCi	K9K 796	Diesel	1461	4	5
05/10→	Logan 1.5 dCi	K9K 892	Diesel	1461	4	5
09/04→	Logan 1.6	K7M 710	Petrol	1598	4	6
02/06→	Logan 1.6 16V	K4M 690	Petrol	1598	4	6
02/06→	Logan 1.6 16V	K4M 696	Petrol	1598	4	6
07/10→	Logan 1.6 16V Flexifuel	K4M 696	Petrol	1598	4	6
03/09→	Logan Express 1.4	K7J 710	Petrol	1390	4	6
03/09→	Logan Express 1.5 dCi	K9K 792 Euro 4	Diesel	1461	4	5
03/09→	Logan Express 1.5 dCi	K9K 796	Diesel	1461	4	5
05/10→	Logan Express 1.5 dCi	K9K 892	Diesel	1461	4	5
03/09→	Logan Express 1.6	K7M 710	Petrol	1598	4	6
02/07→	Logan MCV 1.4	K7J 710	Petrol	1390	4	6
02/07→	Logan MCV 1.5 dCi	K9K 792 Euro 4	Diesel	1461	4	5
09/07→	Logan MCV 1.5 dCi	K9K 796	Diesel	1461	4	5
05/10→	Logan MCV 1.5 dCi	K9K 892	Diesel	1461	4	5
02/07→	Logan MCV 1.6	K7M 710	Petrol	1598	4	6
02/07→	Logan MCV 1.6 16V	K4M 690	Petrol	1598	4	6
02/07→	Logan MCV 1.6 16V	K4M 696	Petrol	1598	4	6
11/09→	Logan MCV 1.6 16V Hi-Flex	K4M 690	Petrol	1598	4	6
11/09→	Logan MCV 1.6 16V Hi-Flex	K4M 694	Petrol	1598	4	6
11/08→	Logan MCV 1.6 Bifuel	K7M 710	Petrol	1598	4	6
01/09→	Logan Pickup 1.4	K7J 710	Petrol	1390	4	6
03/08→	Logan Pickup 1.5 dCi	K9K 792 Euro 4	Diesel	1461	4	5
03/08→	Logan Pickup 1.5 dCi	K9K 796	Diesel	1461	4	5
05/10→	Logan Pickup 1.5 dCi	K9K 892	Diesel	1461	4	5
03/08→	Logan Pickup 1.6	K7M 710	Petrol	1598	4	6
04/96→03/01	Nova 1.4	C2J	Petrol	1397	4	4
11/08→	Sandero 1.2 16V	D4F732		1149	4	1
11/08→	Sandero 1.2 16V LPG	D4F732		1149	4	1
06/08→	Sandero 1.4	K7J 710	Petrol	1390	4	6
01/09→	Sandero 1.4 MPI LPG	K7J 714	Petrol	1390	4	6
11/08→	Sandero 1.5 dCi	K9K 792 Euro 4	Diesel	1461	4	5
11/08→	Sandero 1.5 dCi	K9K 796	Diesel	1461	4	5
05/10→	Sandero 1.5 dCi	K9K 892	Diesel	1461	4	5
06/08→	Sandero 1.6	K7M 710	Petrol	1598	4	6
07/11→	Sandero 1.6 16V	K4M 690	Petrol	1598	4	6
01/11→	Sandero 1.6 16V Bifuel	K4M 690	Petrol	1598	4	6
01/11→	Sandero 1.6 16V Bifuel	K4M 694	Petrol	1598	4	6
01/11→	Sandero 1.6 16V Bifuel	K4M 696	Petrol	1598	4	6

MODEL INDEX

Modelverzeichnis • Index de modele • Índice de Modelo
Indeks modelu • Модель автомобиля • دليل المحرك



CCM



9

01/13→	Sandero II 1.2	D4F732		1149	4	1
02/03→	Solenza 1.4	K7J 710	Petrol	1390	4	6
02/03→	Solenza 1.9 D	F8Q 630	Diesel	1870	4	7

ENGINE INDEX

Motorverzeichnis • Index de moteur • Índice de Motor
Indeks silnika • Модель двигателя • دليل المحرك



CCM



9

688-09		Petrol	1108	4	70.00	2
810-02/-99		Petrol	1289	4	73.00	3
C2J		Petrol	1397	4	76.00	4
D4F732			1149	4	69.00	1
F8Q 630		Diesel	1870	4	80.00	7
K4M 690		Petrol	1598	4	79.50	6
K4M 694		Petrol	1598	4	79.50	6
K4M 696		Petrol	1598	4	79.50	6
K7J 710		Petrol	1390	4	79.50	6
K7J 714		Petrol	1390	4	79.50	6
K7M 710		Petrol	1598	4	79.50	6
K9K 790		Diesel	1461	4	76.00	5
K9K 792 Euro 4		Diesel	1461	4	76.00	5
K9K 796		Diesel	1461	4	76.00	5
K9K 892		Diesel	1461	4	76.00	5
K9K 894		Diesel	1461	4	76.00	5
K9K 896		Diesel	1461	4	76.00	5
K9K 898		Diesel	1461	4	76.00	5



Logan 1.2 16V	02/06→	D4F732							1
Sandero 1.2 16V LPG	11/08→		4cyl.						
Sandero 1.2 16V	11/08→		1149cc	55kW (75PS)					
Sandero II 1.2	01/13→								
TD23529									

08-450000-00	STD	69.00	1.200		001 NT		ST
08-450007-00	0.50mm		1.500		005 IFU P		STD
			2.500		712 CR		ST

1210	01/65→	688-09						2	
			4cyl.						
			1108cc						
FM4916									

08-334600-00	STD	70.00	1.750		001 IF CR P		IKA
<i>[R66160]</i>			2.000		026 P		STD
			3.500		712 CR		ST

1300 1.3, 1300 Estate 1.3	12/72→05/83	810-02/-99						3	
1304 Platform/Chassis 1.3	06/83→08/90		4cyl.						
1310 Estate 1.3, 1310 Saloon 1.3	05/83→07/04		1289cc	40kW (54PS)					
TD13436									

08-333400-10	STD	73.00	1.750		001 IF CR P		IKA
<i>[R66220]</i>			2.000		026 P		STD
			4.000		712 CR		ST

Nova 1.4	04/96→03/01	C2J						4	
			4cyl.						
			1397cc	48kW (65PS)					
TD24574									

08-333500-00	STD	76.00	1.750		001 IF CR P		IKA
08-333505-00	0.25mm		2.000		026 P		STD
08-333507-00	0.50mm		4.000		712 CR		ST
<i>[R66190]</i>							

Logan 1.5 dCi	09/05→	K9K 790						5	
			4cyl.						
			1461cc	48kW (65PS)					
			Diesel	Turbo Intercooled					
TD18514									

Logan 1.5 dCi	01/06→	K9K 792 Euro 4						
Logan Express 1.5 dCi	03/09→		4cyl.					
Logan MCV 1.5 dCi	02/07→		1461cc	50kW (68PS)				
Logan Pickup 1.5 dCi	03/08→	Diesel	Turbo Intercooled					
Sandero 1.5 dCi	11/08→							TD19223

Duster 1.5 dCi	04/10→	K9K 796						
Logan 1.5 dCi	09/07→		4cyl.					
Logan Express 1.5 dCi	03/09→		1461cc	63kW (86PS)				
Logan MCV 1.5 dCi	09/07→	Diesel	Turbo Intercooled					
Logan Pickup 1.5 dCi	03/08→							
Sandero 1.5 dCi	11/08→							TD22403











Duster 1.5 dCi	10/10→				K9K 892			
Logan 1.5 dCi, Logan Express 1.5 dCi,	05/10→					4cyl.		
Logan MCV 1.5 dCi, Logan Pickup 1.5 dCi,						1461cc	55-66kW (75-90PS)	
Sandero 1.5 dCi					Diesel	Turbo Intercooled		TD24780
Duster 1.5 dCi 4x4	10/10→				K9K 894			
						4cyl.		
						1461cc	66-67kW (90-91PS)	
					Diesel	Turbo Intercooled		TD24783
Duster 1.5 dCi	06/10→				K9K 896			
						4cyl.		
						1461cc	79kW (107PS)	
					Diesel	Turbo Intercooled		TD24784
Duster 1.5 dCi 4x4	06/10→				K9K 898			
						4cyl.		
						1461cc	79-80kW (107-109PS)	
					Diesel	Turbo Intercooled		TD24785
08-123400-00	STD	76.00	2.000		001 IF CK P			KV1
08-123407-00	0.50mm		2.000		005 IFU P			GOE13
[R60620]			2.500		231 NT			GOE13
Duster 1.6 16V	04/10→				K4M 690			6
Logan 1.6 16V	02/06→					4cyl.		
Logan MCV 1.6 16V	02/07→					1598cc	77kW (105PS)	
Logan MCV 1.6 16V Hi-Flex	11/09→							
Sandero 1.6 16V	07/11→							
Sandero 1.6 16V Bifuel	01/11→							
Logan MCV 1.6 16V Hi-Flex	11/09→				K4M 694			TD24876
Sandero 1.6 16V Bifuel	01/11→					4cyl.		
						1598cc	77kW (105PS)	
Duster 1.6 16V	04/10→				K4M 696			TD24781
Duster 1.6 16V Hi-Flex	08/10→					4cyl.		
Duster 1.6 16V LPG	04/11→					1598cc	77kW (105PS)	
Logan 1.6 16V	02/06→							
Logan 1.6 16V Flexifuel	07/10→							
Logan MCV 1.6 16V	02/07→							
Sandero 1.6 16V Bifuel	01/11→							
Logan 1.4	09/04→				K7J 710			TD18140
Logan 1.4 MPI LPG	02/06→					4cyl.		
Logan Express 1.4	03/09→					1390cc	55kW (75PS)	
Logan MCV 1.4	02/07→							
Logan Pickup 1.4	01/09→							
Sandero 1.4	06/08→							
Solenza 1.4	02/03→							
Logan 1.4 MPI LPG	02/06→				K7J 714			TD23531
Sandero 1.4 MPI LPG	01/09→					4cyl.		
						1390cc	53kW (72PS)	







Logan 1.6	09/04→	K7M 710		
Logan Express 1.6	03/09→		4cyl.	
Logan MCV 1.6	02/07→		1598cc	64kW (87PS)
Logan MCV 1.6 Bifuel	11/08→			
Logan Pickup 1.6	03/08→			
Sandero 1.6	06/08→			TD18141

08-104200-00	STD	79.50	1.500		001 IF CR P	KV1
08-104207-00	0.50mm		1.500		026 P	STD
<i>[R60240]</i>						
			2.500		712 CR	ST
08-105200-00	STD	79.50	1.200		001 NT	ST
08-105207-00	0.50mm		1.500		026 P	STD
<i>[R60660]</i>						
			2.500		712 CR	ST

Solenza 1.9 D	02/03→	F8Q 630		
			4cyl.	
			1870cc	48kW (65PS)
			Diesel	TD22401

7

08-336500-00	STD	80.00	2.000		001 MO P	KV1
08-336505-00	0.25mm		2.000		005 IFU P	IKA
08-336507-00	0.50mm		3.000		231 CR P	STD
08-336510-00	0.80mm		<i>[R66330]</i>			



Matiz 0.8 Tico 0.8	09/98 → 01/96 →12/00	F8CV	3cyl. 796cc	38kW (52PS)	1
					TD18851

08-426800-00	STD	68.50	1.200		001 CR	ST
08-426807-00	0.50mm		1.500		005 P	STD
			2.800		712 CR P	ST

Lacetti Estate 1.5 SE, Lacetti Saloon 1.5 SE Nubira Saloon 1.5 SE	04/98 →05/99 06/99 →07/03	A15DMS	4cyl. 1498cc	81kW (110PS)	2
					TD19847

Espero 1.5 16V Nexia 1.5 16V, Nexia Saloon 1.5 16V	10/93 →06/99 02/95 →08/97	A15MF	4cyl. 1498cc	66kW (89PS)	
					TD742

Gentra Saloon 1.5 SE Lacetti Estate 1.5 SX, Lacetti Saloon 1.5 SX Lanos 1.5, Lanos Saloon 1.5	11/02 →04/05 04/97 →05/99 05/97 →	A15SMS	4cyl. 1498cc	63kW (86PS)	
					TD9507

Kalos 1.5, Kalos Saloon 1.5	11/02 →12/04	F15S	4cyl. 1498cc	62kW (84PS)	
					TD25314

08-438600-00	STD	76.50	1.500		001 CR P	STD
08-438605-00	0.25mm		1.500		026 P	STD
08-438607-00	0.50mm		3.000		712 CR	ST

Industrial		DV15T	8cyl. 14618cc		3
			Diesel	Turbo	FM9027

08-134800-00	STD	128.00	3.500		008 CR P	KV1
			3.000		026 CR P	GOE13
			4.000		231 CR P	GOE13



CCM

x



9

6 BT5.9	Diesel	5880	6	102.00	7
6 BTA	Diesel	5880	6	102.00	7
110E		1108	4	70.00	1
110F		1108	4	70.00	1
110G		1108	4	70.00	1
810/03/25/26/29		1289	4	73.00	2
BE 99 C Euro 3	Diesel	3920	4	102.00	7
BE 110 C Euro 3	Diesel	3920	4	102.00	7
BN 25	Diesel	2500	4	102.00	8
CD 85	Diesel	5880	6	102.00	8
CE 136 C Euro 3	Diesel	5880	6	102.00	7
CE 162 C Euro 3	Diesel	5880	6	102.00	7
CE 184 C Euro 3	Diesel	5880	6	102.00	7
CN 96	Diesel	5880	6	102.00	8
DD 575	Diesel	5750	6	100.62	6
DF 615	Diesel	6150	6	104.18	9
DH 825	Diesel	8250	6	118.00	11
DHB 825	Diesel	8250	6	118.00	11
DHR 825	Diesel	8250	6	118.00	11
DHS 825	Diesel	8250	6	118.00	11
DHT 825	Diesel	8250	6	118.00	11
DHTD 825	Diesel	8250	6	118.00	11
DHU 825	Diesel	8250	6	118.00	11
DJ5T	Diesel	2446	4	92.00	3
DK 1160	Diesel	11630	6	130.00	14
DKA 1160	Diesel	11600	6	130.00	14
DKB 1160	Diesel	11600	6	130.00	14
DKCL 1160	Diesel	11630	6	130.00	14
DKD 1160	Diesel	11630	6	130.00	14
DKDL 1160	Diesel	11630	6	130.00	14
DKFL 1160	Diesel	11630	6	130.00	14
DKL 1160	Diesel	11630	6	130.00	14
DKS 1160	Diesel	11600	6	130.00	14
DKS 1160 E	Diesel	11600	6	130.00	14
DKSB 1160	Diesel	11630	6	130.00	14
DKSE 1160	Diesel	11630	6	130.00	14
DKT 1160	Diesel	11600	6	130.00	14
DKTD 1160	Diesel	11600	6	130.00	14
DKTL 1160	Diesel	11600	6	130.00	14
DKV 1160	Diesel	11600	6	130.00	14
DKVL 1160	Diesel	11600	6	130.00	14
DKX 1160	Diesel	11600	6	130.00	14
DKX 1160 ATi	Diesel	11600	6	130.00	14
DKXE 1160	Diesel	11600	6	130.00	14
DKXE 1160 ATi	Diesel	11630	6	130.00	14
DKZ 1160 ATi	Diesel	11600	6	130.00	14
DNS 620	Diesel	6240	6	104.18	10
DNT 620	Diesel	6240	6	104.18	10
DNTD 620	Diesel	6240	6	104.18	10
DS 575	Diesel	5760	6	100.62	6
DT 615	Diesel	6150	6	104.18	9
DTD 615	Diesel	6150	6	104.18	9
DU 825	Diesel	8250	6	118.00	11
EN 55	Diesel	2498	4	94.00	4
ET 70	Diesel	2498	4	94.00	5
HS 200	Diesel	8250	6	118.00	11
HT 168	Diesel	8250	6	118.00	11
KT 191	Diesel	11627	6	130.00	14
LT 160	Diesel	11630	6	130.00	14
LT 195 1160	Diesel	11627	6	130.00	14

ENGINE INDEX

Motorverzeichnis • Index de moteur • Índice de Motor
 Indeks silnika • Модель двигателя • دليل المحرك

CCM
x

9

LT 210	Diesel	11630	6	130.00	14
MX 265 Euro 4/5 (Paccar MX)	Diesel	12900	6	130.00	15
MX 300 Euro 4/5 (Paccar MX)	Diesel	12900	6	130.00	15
MX 340 Euro 4/5 (Paccar MX)	Diesel	12900	6	130.00	15
MX 375 Euro 4/5 (Paccar MX)	Diesel	12900	6	130.00	15
PE 183 C Euro 3	Diesel	9200	6	118.00	12
PE 212 C Euro 3	Diesel	9200	6	118.00	12
PE 228 C Euro 3	Diesel	9200	6	118.00	12
PE 235 C Euro 3	Diesel	9200	6	118.00	12
PE 250 C Euro 3	Diesel	9200	6	118.00	12
PE 265 C Euro 3	Diesel	9200	6	118.00	12
PE 310 C Euro 3	Diesel	9200	6	118.00	12
PE 360 C Euro 3	Diesel	9200	6	118.00	12
PF 183 M Euro 2	Diesel	9200	6	118.00	12
PF 212 M Euro 2	Diesel	9200	6	118.00	12
PF 235 M Euro 2	Diesel	9200	6	118.00	12
RS 180	Diesel	8661	6	118.00	13
RS 180 L Euro 1	Diesel	8650	6	118.00	13
RS 180 M Euro 2	Diesel	8650	6	118.00	13
RS 200	Diesel	8650	6	118.00	13
RS 200 L Euro 1	Diesel	8650	6	118.00	13
RS 200 M Euro 2	Diesel	8650	6	118.00	13
RS 222	Diesel	8661	6	118.00	13
RS 222 L Euro 1	Diesel	8650	6	118.00	13
RS 222 M Euro 2	Diesel	8650	6	118.00	13
WS 222 G	Diesel	11630	6	130.00	16
WS 222 L	Diesel	11630	6	130.00	16
WS 225	Diesel	11600	6	130.00	16
WS 242	Diesel	11600	6	130.00	16
WS 242 L Euro 1	Diesel	11600	6	130.00	16
WS 242 M Euro 2	Diesel	11600	6	130.00	16
WS 259	Diesel	11600	6	130.00	16
WS 268	Diesel	11600	6	130.00	16
WS 268 L Euro 1	Diesel	11600	6	130.00	16
WS 268 M Euro 2	Diesel	11600	6	130.00	16
WS 282	Diesel	11600	6	130.00	16
WS 295	Diesel	11600	6	130.00	16
WS 295 L Euro 1	Diesel	11600	6	130.00	16
WS 295 M Euro 2	Diesel	11600	6	130.00	16
WS 315 L Euro 1	Diesel	11600	6	130.00	16
WS 315 M Euro 2	Diesel	11600	6	130.00	16
XD3P	Diesel	2498	4	94.00	4
XE 250 C Euro 3	Diesel	12580	6	130.00	16
XE 280 C Euro 3	Diesel	12580	6	130.00	16
XE 280 C1 Euro 3	Diesel	12580	6	130.00	17
XE 315 C1 Euro 3	Diesel	12580	6	130.00	17
XE 355 C1 Euro 3	Diesel	12580	6	130.00	17
XE 390 C1 Euro 3	Diesel	12580	6	130.00	17
XF 250 M Euro 2	Diesel	12580	6	130.00	16
XF 280 M Euro 2	Diesel	12580	6	130.00	16
XF 315 M Euro 2	Diesel	12580	6	130.00	16
XF 355 M Euro 2	Diesel	12580	6	130.00	16



							1
110E		4cyl.	1108cc	35kW (47PS)			TD21909
110F		4cyl.	1108cc	40kW (54PS)			TD21910
110G		4cyl.	1108cc	40kW (54PS)			TD21911
08-334600-00	STD	70.00	1.750		001 IF CR P		IKA
[R66160]	2.000			026 P		STD	
	3.500			712 CR		ST	

							2
810/03/25/26/29		4cyl.	1289cc	40kW (54PS)			FM1486
08-333400-10	STD	73.00	1.750		001 IF CR P		IKA
[R66220]	2.000			026 P		STD	
	4.000			712 CR		ST	

							3
DJ5T		4cyl.	2446cc	76-96kW (103-131PS)	Diesel	Turbo Intercooled	TD22210
08-326300-00	STD	92.00	3.000		008 P PS		KV1
08-326307-00	0.50mm		1.750		005 IF CR P		IKA
[R67430]			3.500		231 CR P		STD

							4
EN 55		4cyl.	2498cc	53kW (72PS)	Diesel		TD763
XD3P		4cyl.	2498cc	51-58kW (70-79PS)	Diesel		TD22215
08-318700-10	STD	94.00	2.000		001 CR P		KV1
08-318704-10	0.20mm		2.000		005 IF P		STD
08-318706-10	0.40mm		2.000		231 CR P		STD
08-318707-10	0.50mm		4.000				
08-318708-10	0.60mm						
08-318710-10	0.80mm						
08-318711-10	1.00mm						
[R66140]							

							5
ET 70		4cyl.	2498cc	71kW (96PS)	Diesel	Turbo Intercooled	TD764
08-320200-10	STD	94.00	3.000		008 MOL P		IKA
08-320204-10	0.20mm		2.000		005 P		IKA
08-320206-10	0.40mm		4.000		231 CR P		STD
08-320208-10	0.60mm						
08-320211-10	1.00mm						
[R66000]							

6

DD 575		6cyl.	5750cc	77kW (105PS)	Diesel		TD6609
DS 575		6cyl.	5760cc	97kW (132PS)	Diesel		TD6610
08-164500-10	STD	100.62	2.385		001 IF CR P		STD
			2.385		005 IF		STD
			2.385		026		STD
			6.350		231 P		STD
			6.350		031 P		STD

7

6 BT5.9		6cyl.	5880cc	108kW (147PS)	Diesel		TD6613
6 BTA		6cyl.	5880cc	118kW (160PS)	Diesel		TD7047
BE 110 C Euro 3		4cyl.	3920cc	110kW (150PS)	Diesel Turbo Intercooled		TD16714
BE 99 C Euro 3		4cyl.	3920cc	99kW (135PS)	Diesel Turbo Intercooled		TD16709
CE 136 C Euro 3		6cyl.	5880cc	136kW (185PS)	Diesel Turbo Intercooled		TD16712
CE 162 C Euro 3		6cyl.	5880cc	162kW (220PS)	Diesel Turbo Intercooled		TD16711
CE 184 C Euro 3		6cyl.	5880cc	184kW (250PS)	Diesel Turbo Intercooled		TD16710
08-145000-00	STD	102.00	3.000		008 CK P		KV1
08-145007-00	0.50mm		2.390		005 IF P		GOE13
08-145008-00	0.60mm		4.000		231 CR P		GOE13
<i>[R66730]</i>							



8

BN 25		4cyl.	2500cc		Diesel		FM6389
CD 85		6cyl.	5880cc	85kW (116PS)	Diesel		TD12556
CN 96		6cyl.	5880cc	96kW (131PS)	Diesel		TD12559
08-742100-00	STD	102.00	2.400		001 CR P		KV1
			2.350		005 IF P		STD
			4.000		231 CR P		STD





9

DF 615		6cyl.	6150cc	85kW (116PS)	Diesel		TD6601
DT 615		6cyl.	6150cc	111kW (151PS)	Diesel Turbo		TD6602
DTD 615		6cyl.	6150cc	101-123kW (137-167PS)	Diesel Turbo		TD6616
08-179000-10	STD	104.18	2.500		001 CR P		STD
			2.500		005 IF P		STD
			2.500		026 P		STD
			6.000		231 P		STD
			6.000		031 P		STD
<i>[R46300]</i>							





10

DNS 620		6cyl.	6240cc	156kW (212PS)	Diesel	Turbo Intercooled	TD6617
DNT 620		6cyl.	6240cc	132kW (180PS)	Diesel	Turbo	TD6615
DNTD 620		6cyl.	6240cc	116kW (158PS)	Diesel	Turbo	TD6614
08-741600-00	STD	104.18	3.000		008 CR P		IKA
[R46290]			2.500		005 CR P		STD
			4.000		231 CR P		STD

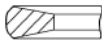

11

DH 825		6cyl.	8250cc	115-121kW (156-165PS)	Diesel		TD6603
DHB 825		6cyl.	8250cc	148kW (201PS)	Diesel	Turbo	TD13229
DHR 825		6cyl.	8250cc	150kW (204PS)	Diesel	Turbo	TD6619
DHS 825		6cyl.	8250cc	184-195kW (250-265PS)	Diesel	Turbo Intercooled	TD6625
DHT 825		6cyl.	8250cc	162-167kW (220-228PS)	Diesel	Turbo	TD6620
DHTD 825		6cyl.	8250cc	151kW (205PS)	Diesel	Turbo	TD6621
DHU 825		6cyl.	8250cc	169kW (230PS)	Diesel	Turbo	TD6623
DU 825		6cyl.	8250cc	159kW (216PS)	Diesel	Turbo	TD6618
HS 200		6cyl.	8250cc	200kW (272PS)	Diesel	Turbo Intercooled	TD6628
HT 168		6cyl.	8250cc	168kW (228PS)	Diesel	Turbo	TD6624
08-182500-10	STD	118.00	3.500		008 CR P		IKA
[R46310]			3.000		005 CR P		STD
			3.000		005 P		STD
			6.000		231 CR P		STD

12

PE 183 C Euro 3		6cyl.	9200cc	183kW (249PS)	Diesel	Turbo Intercooled	TD13328
PE 212 C Euro 3		6cyl.	9200cc	212kW (288PS)	Diesel	Turbo Intercooled	TD13329
PE 228 C Euro 3		6cyl.	9200cc	228kW (310PS)	Diesel	Turbo Intercooled	TD16701
PE 235 C Euro 3		6cyl.	9200cc	235kW (320PS)	Diesel	Turbo Intercooled	TD13330
PE 250 C Euro 3		6cyl.	9200cc	183kW (249PS)	Diesel	Turbo Intercooled	TD22813
PE 265 C Euro 3		6cyl.	9200cc	265kW (360PS)	Diesel	Turbo Intercooled	TD16700
PE 310 C Euro 3		6cyl.	9200cc	228kW (310PS)	Diesel	Turbo Intercooled	TD22814
PE 360 C Euro 3		6cyl.	9200cc	265kW (360PS)	Diesel	Turbo Intercooled	TD22815
PF 183 M Euro 2		6cyl.	9200cc	183kW (249PS)	Diesel	Turbo Intercooled	TD11909
PF 212 M Euro 2		6cyl.	9200cc	212kW (288PS)	Diesel	Turbo Intercooled	TD11910
PF 235 M Euro 2		6cyl.	9200cc	235kW (320PS)	Diesel	Turbo Intercooled	TD11911
08-140200-00	STD	118.00	3.500		008 CK P		KV1
			3.000		005 NT		F12/F14
			4.000		231 CR P		GOE13

13

RS 180	6cyl.	8661cc	180kW (245PS)	Diesel	Turbo Intercooled	TD12553
RS 180 L Euro 1	6cyl.	8650cc	180kW (245PS)	Diesel	Turbo Intercooled	TD6654
RS 180 M Euro 2	6cyl.	8650cc	180kW (245PS)	Diesel	Turbo Intercooled	TD6655
RS 200	6cyl.	8650cc	200kW (272PS)	Diesel	Turbo Intercooled	TD12554
RS 200 L Euro 1	6cyl.	8650cc	200kW (272PS)	Diesel	Turbo Intercooled	TD6656
RS 200 M Euro 2	6cyl.	8650cc	200kW (272PS)	Diesel	Turbo Intercooled	TD6657
RS 222	6cyl.	8661cc	222kW (302PS)	Diesel	Turbo Intercooled	TD12555
RS 222 L Euro 1	6cyl.	8650cc	222kW (302PS)	Diesel	Turbo Intercooled	TD6658
RS 222 M Euro 2	6cyl.	8650cc	222kW (302PS)	Diesel	Turbo Intercooled	TD6659
08-121600-00	STD	118.00	3.500		008 MOL P	KV1
			3.000		005 NT	F12/F14
			4.000		231 CR P	GOE13

14

DK 1160	6cyl.	11630cc	156kW (212PS)	Diesel	Turbo Intercooled	TD6606
DKA 1160	6cyl.	11600cc	169kW (230PS)	Diesel		TD6608
DKB 1160	6cyl.	11600cc	226kW (307PS)	Diesel	Turbo	TD6627
DKCL 1160	6cyl.	11630cc	156kW (212PS)	Diesel	Turbo Intercooled	TD20105
DKD 1160	6cyl.	11630cc	121kW (165PS)	Diesel	Turbo	TD6605
DKDL 1160	6cyl.	11630cc	121kW (165PS)	Diesel	Turbo Intercooled	TD6640
DKFL 1160	6cyl.	11630cc	191kW (260PS)	Diesel	Turbo Intercooled	TD20107
DKL 1160	6cyl.	11630cc	148-151kW (201-205PS)	Diesel	Turbo Intercooled	TD6641
DKS 1160	6cyl.	11600cc	228kW (310PS)	Diesel	Turbo	TD6629
DKS 1160 E	6cyl.	11600cc	206kW (280PS)	Diesel	Turbo Intercooled	TD6630
DKSB 1160	6cyl.	11630cc	228kW (310PS)	Diesel	Turbo Intercooled	TD20106
DKSE 1160	6cyl.	11630cc	206kW (280PS)	Diesel	Turbo Intercooled	TD22211
DKT 1160	6cyl.	11600cc	213kW (290PS)	Diesel	Turbo	TD6631
DKTD 1160	6cyl.	11600cc	188-191kW (256-260PS)	Diesel	Turbo	TD6632
DKTL 1160	6cyl.	11600cc	185kW (252PS)	Diesel	Turbo	TD6642
DKV 1160	6cyl.	11600cc	212kW (288PS)	Diesel	Turbo	TD6633
DKVL 1160	6cyl.	11600cc	206kW (280PS)	Diesel	Turbo	TD13288
DKX 1160	6cyl.	11600cc	243kW (330PS)	Diesel	Turbo Intercooled	TD6637
DKX 1160 ATi	6cyl.	11600cc	260kW (354PS)	Diesel	Turbo Intercooled	TD6638
DKXE 1160	6cyl.	11600cc	212kW (288PS)	Diesel	Turbo Intercooled	TD6634
DKXE 1160 ATi	6cyl.	11630cc	139-274kW (189-373PS)	Diesel	Turbo Intercooled	TD22212
DKZ 1160 ATi	6cyl.	11600cc	274kW (373PS)	Diesel	Turbo Intercooled	TD6639
KT 191	6cyl.	11627cc	256kW (348PS)	Diesel	Turbo Intercooled	FM5278
LT 160	6cyl.	11630cc	160-170kW (218-231PS)	Diesel		TD24104





LT 195 1160		6cyl.	11627cc	195kW (265PS)	Diesel	FM5310
LT 210		6cyl.	11630cc	206-210kW (280-286PS)	Diesel Turbo Intercooled	TD7173
08-174100-10	STD	130.00	3.160		008 CR P	IKA
[R46320]			3.160		005 CR P	STD
			3.160		005 CR P	STD
			6.335		231 CR P	STD



15

MX 265 Euro 4/5 (Paccar MX)		6cyl.	12900cc	265kW (360PS)	Diesel Turbo Intercooled	TD20056
MX 300 Euro 4/5 (Paccar MX)		6cyl.	12900cc	300kW (408PS)	Diesel Turbo Intercooled	TD18902
MX 340 Euro 4/5 (Paccar MX)		6cyl.	12900cc	340kW (462PS)	Diesel Turbo Intercooled	TD18903
MX 375 Euro 4/5 (Paccar MX)		6cyl.	12900cc	375kW (510PS)	Diesel Turbo Intercooled	TD18904
08-432500-00 ①	STD	130.00	4.000		008 IF GDC P	KV1
			3.160		005 NT	IKA
			4.000		231 CR P	GOE13
08-437500-00 ②	STD	130.00	3.000		008 IF GDC NT	ST
			2.500		005 IFU P	F12/F14
			3.000		231 LKZ GDC P	GOE13
① For Steel piston		① For Steel piston		① For Steel piston		① For Steel piston
② For Aluminium piston		② For Aluminium piston		② For Aluminium piston		② For Aluminium piston





16

WS 222 G	6cyl.	11630cc	222kW (302PS)	Diesel	Turbo Intercooled	TD6667
WS 222 L	6cyl.	11630cc	222kW (302PS)	Diesel	Turbo Intercooled	TD6660
WS 225	6cyl.	11600cc	225kW (306PS)	Diesel	Turbo Intercooled	TD6668
WS 242	6cyl.	11600cc	242kW (329PS)	Diesel	Turbo Intercooled	TD6669
WS 242 L Euro 1	6cyl.	11600cc	242kW (329PS)	Diesel	Turbo Intercooled	TD6662
WS 242 M Euro 2	6cyl.	11600cc	242kW (329PS)	Diesel	Turbo Intercooled	TD6663
WS 259	6cyl.	11600cc	259kW (352PS)	Diesel	Turbo Intercooled	TD6670
WS 268	6cyl.	11600cc	268kW (365PS)	Diesel	Turbo Intercooled	TD6671
WS 268 L Euro 1	6cyl.	11600cc	268kW (365PS)	Diesel	Turbo Intercooled	TD6664
WS 268 M Euro 2	6cyl.	11600cc	268kW (365PS)	Diesel	Turbo Intercooled	TD6665
WS 282	6cyl.	11600cc	282kW (384PS)	Diesel	Turbo Intercooled	TD11907
WS 295	6cyl.	11600cc	295kW (401PS)	Diesel	Turbo Intercooled	TD6675
WS 295 L Euro 1	6cyl.	11600cc	295kW (401PS)	Diesel	Turbo Intercooled	TD6677
WS 295 M Euro 2	6cyl.	11600cc	295kW (401PS)	Diesel	Turbo Intercooled	TD6678
WS 315 L Euro 1	6cyl.	11600cc	315kW (428PS)	Diesel	Turbo Intercooled	TD6680
WS 315 M Euro 2	6cyl.	11600cc	315kW (428PS)	Diesel	Turbo Intercooled	TD6681
XE 250 C Euro 3	6cyl.	12580cc	250kW (340PS)	Diesel	Turbo Intercooled	TD13331
XE 280 C Euro 3	6cyl.	12580cc	280kW (381PS)	Diesel	Turbo Intercooled	TD13332
XF 250 M Euro 2	6cyl.	12580cc	250kW (340PS)	Diesel	Turbo Intercooled	TD11912
XF 280 M Euro 2	6cyl.	12580cc	280kW (381PS)	Diesel	Turbo Intercooled	TD11913
XF 315 M Euro 2	6cyl.	12580cc	315kW (428PS)	Diesel	Turbo Intercooled	TD11914
XF 355 M Euro 2	6cyl.	12580cc	355kW (483PS)	Diesel	Turbo Intercooled	TD11915

08-743400-00	STD	130.00	4.000		008 P PS	KV1
[R46330]			3.160		005 CR P	STD
			4.000		231 CR P	STD

17

XE 280 C1 Euro 3	6cyl.	12580cc	280kW (381PS)	Diesel	Turbo Intercooled	TD22217
XE 315 C1 Euro 3	6cyl.	12580cc	315kW (428PS)	Diesel	Turbo Intercooled	TD22218
XE 355 C1 Euro 3	6cyl.	12580cc	355kW (483PS)	Diesel	Turbo Intercooled	TD22219
XE 390 C1 Euro 3	6cyl.	12580cc	390kW (530PS)	Diesel	Turbo Intercooled	TD22220

08-433300-00	STD	130.00	4.000		008 CK	KV1
			3.160		005	IKA
			4.000		231 CR P	STD

Modelverzeichnis • Index de modele • Índice de Modelo
Indeks modelu • Модель автомобиля • دليل المركب

MODEL INDEX



CCM

x



9

07/86→10/97	1000 Box 1.0	CB 10	Petrol	993	3	4
07/86→12/89	1000 Box 1.0 4x4	CB 10	Petrol	993	3	4
06/92→10/97	1000 Bus 1.0	CB 10	Petrol	993	3	4
06/92→10/97	1000 Pickup 1.0	CB 10	Petrol	993	3	4
01/10→	Boon 1.0	1KR-FE Euro 4	Petrol	998	3	2
10/77→02/83	Charade I 1.0	CB 20	Petrol	993	3	4
10/83→03/87	Charade II 1.0	CB 20	Petrol	993	3	4
03/87→12/92	Charade III 1.0 TD	CL	Diesel	993	3	5
	Charmant 1.2	3K	Petrol	1166	4	3
11/81→07/87	Charmant 1.3	4K	Petrol	1290	4	3
04/07→	Cuore VIII 1.0	1KR-FE Euro 4	Petrol	998	3	2
	Delta 2.0i	3S-FE	Petrol	1998	4	6
06/86→12/89	Hijet Box 0.8	CD	Petrol	843	3	1
06/86→12/89	Hijet Box 1.0	CB	Petrol	993	3	4
07/86→10/90	Hijet Box 1.0 4x4	CB 10	Petrol	993	3	4
06/86→12/89	Hijet Bus 0.8	CD	Petrol	843	3	1
06/86→12/89	Hijet Bus 1.0	CB	Petrol	993	3	4
07/86→10/90	Hijet Pickup 0.8	CD	Petrol	843	3	1
07/86→10/90	Hijet Pickup 1.0 Touring	CB 10	Petrol	993	3	4
07/86→10/90	Hijet Pickup 1.0 Touring 4x4	CB 10	Petrol	993	3	4
02/85→12/98	Rocky Hard Top 2.8 D	DL	Diesel	2765	4	7
02/85→12/98	Rocky Soft Top 2.8 D	DL	Diesel	2765	4	7
04/84→09/94	Rugger 2.8 D 4x4	DL	Diesel	2765	4	7
01/05→	Sirion 1.0	1KR-FE Euro 4	Petrol	998	3	2
04/05→	Sirion 1.0 DVVT 4WD	1KR-FE Euro 4	Petrol	998	3	2
09/83→05/86	Sparcar Box 0.8	CD	Petrol	843	3	1
09/83→05/86	Sparcar Box 1.0	CB	Petrol	993	3	4
09/83→05/86	Sparcar Bus 0.8	CD	Petrol	843	3	1
09/83→05/86	Sparcar Bus 1.0	CB	Petrol	993	3	4
04/05→	Storia 1.0	1KR-FE Euro 4	Petrol	998	3	2
08/82→11/95	Taft 2.8 D 4x4	DL	Diesel	2765	4	7
02/85→03/87	Wildcat/Rocky 2.8 D	DL	Diesel	2765	4	7
04/86→05/98	Zebra Box 0.8	CD	Petrol	843	3	1
07/87→05/98	Zebra Box 1.0	CB 10	Petrol	993	3	4
04/86→09/90	Zebra Bus 0.8	CD	Petrol	843	3	1
07/87→05/98	Zebra Bus 1.0	CB 10	Petrol	993	3	4
04/86→05/98	Zebra Pickup 0.8	CD	Petrol	843	3	1
07/87→05/98	Zebra Pickup 1.0	CB 10	Petrol	993	3	4

Motorverzeichnis • Index de moteur • Índice de Motor
Indeks silnika • Модель двигателя • دليل المحرك

ENGINE INDEX



CCM

x



9

1KR-FE Euro 4	Petrol	998	3	71.00	2
3K	Petrol	1166	4	75.00	3
3S-FE	Petrol	1998	4	86.00	6
4K	Petrol	1290	4	75.00	3
CB	Petrol	993	3	76.00	4
CB 10	Petrol	993	3	76.00	4
CB 20	Petrol	993	3	76.00	4
CD	Petrol	843	3	70.00	1
CL	Diesel	993	3	76.00	5
DL	Diesel	2765	4	92.00	7



Hijet Box 0.8, Hijet Bus 0.8	06/86→12/89	CD							
Hijet Pickup 0.8	07/86→10/90		3cyl.						1
Sparcar Box 0.8, Sparcar Bus 0.8	09/83→05/86		843cc		29kW (39PS)				
Zebra Box 0.8	04/86→05/98								
Zebra Bus 0.8	04/86→09/90								
Zebra Pickup 0.8	04/86→05/98								TD6699

08-743800-00	STD	70.00	1.500		001 CR P				IKA
			1.500		005 P				STD
			2.800		236 P				STD

Boon 1.0	01/10→	1KR-FE Euro 4							
Cuore VIII 1.0	04/07→		3cyl.						2
Sirion 1.0	01/05→		998cc		50kW (68PS)				
Sirion 1.0 DVVT 4WD, Storia 1.0	04/05→								TD20287

08-439600-00	STD	71.00	1.000		001 IF CR				ST
			1.000		026				ST
			1.500		231 PVD				ST

Charmant 1.2		3K							
			4cyl.						3
			1166cc		40kW (54PS)				
									TD770

Charmant 1.3	11/81→07/87	4K							
			4cyl.						
			1290cc		48kW (65PS)				
									TD774

08-371700-00	STD	75.00	2.000		001 CR P				STD
[R43280]			2.000		026 P				STD
			4.000		231 CR P				STD

Hijet Box 1.0, Hijet Bus 1.0	06/86→12/89	CB							
Sparcar Box 1.0, Sparcar Bus 1.0	09/83→05/86		3cyl.						4
			993cc		33kW (45PS)				
									TD782

1000 Box 1.0	07/86→10/97	CB 10							
1000 Box 1.0 4x4	07/86→12/89		3cyl.						
1000 Bus 1.0, 1000 Pickup 1.0	06/92→10/97		993cc		33kW (45PS)				
Hijet Box 1.0 4x4,	07/86→10/90								
Hijet Pickup 1.0 Touring,									
Hijet Pickup 1.0 Touring 4x4									
Zebra Box 1.0, Zebra Bus 1.0,	07/87→05/98								
Zebra Pickup 1.0									TD18852

Charade I 1.0	10/77→02/83	CB 20							
Charade II 1.0	10/83→03/87		3cyl.						
			993cc		37-38kW (50-52PS)				
									TD4308

08-962800-00	STD	76.00	1.500		001 CR P				IKA
[R40370]			1.500		026 P				STD
			2.800		236 P				STD



Charade III 1.0 TD		03/87→12/92		CL		3cyl. 993cc		27-35kW (37-48PS)		5		
				Diesel						TD4316		
08-744400-00	STD	76.00	2.000		007 CR P						KV1	
			1.500		005 P							STD
			3.000		231 CR P							STD

Delta 2.0i				3S-FE		4cyl. 1998cc		85-103kW (116-140PS)		6		
										TD22221		
08-439700-00	STD	86.00	1.200		001 NT						ST	
			1.200		026 P							STD
			3.000		712 CR							ST

Rocky Hard Top 2.8 D, Rocky Soft Top 2.8 D		02/85→12/98		DL		4cyl. 2765cc		51-54kW (69-73PS)		7	
Rugger 2.8 D 4x4		04/84→09/94									
Taft 2.8 D 4x4		08/82→11/95		Diesel							
Wildcat/Rocky 2.8 D		02/85→03/87								TD6694	
08-744000-00	STD	92.00	2.500		001 CR P						KV1
<i>[R44000]</i>			2.000		005 CR P						STD
			4.000		231 CR P						



1

AD3/49	3cyl.	2395cc	Diesel	FM428
AD3/55	3cyl.	2695cc	Diesel	FM430
AD4/49	4cyl.	3195cc	Diesel	FM429
AD4/55	4cyl.	3594cc	Diesel	FM431
AD4/55T	4cyl.	3594cc	Diesel Turbo	FM433
AD6/55	6cyl.	5392cc	Diesel	FM3822
AD6/55T	6cyl.	5392cc	Diesel Turbo	FM3823

08-520600-00	STD	100.04	2.380		005 CR
08-520607-00	.020		2.380		005
08-520611-00	.040		2.380		005
[R20844]			4.763		032



CCM

x



9

8360.05.670 (Magirus-Deutz)	Diesel	8100	6	115.00	29
BA 6M 816	Diesel	15204	6	142.00	41
BA 8M 816	Diesel	20272	V8	142.00	41
BA12M 816	Diesel	30408	V12	142.00	41
BA12M 816 C	Diesel	30408	V12	142.00	41
BA12M 816 CR	Diesel	30408	V12	142.00	41
BA12M 816 R	Diesel	30408	V12	142.00	41
BA12M 816 U	Diesel	30408	V12	142.00	41
BA12M 816 W	Diesel	30408	V12	142.00	41
BA16M 816	Diesel	40544	V16	142.00	41
BF 2L 912	Diesel	1884	2	100.00	12
BF 3L 2011	Diesel	2332	3	94.00	6
BF 3L 912	Diesel	2826	3	100.00	12
BF 3M 1011 F	Diesel	2184	3	91.00	2
BF 3M 2011	Diesel	2332	3	94.00	6
BF 4L 1011 F	Diesel	2731	4	91.00	2
BF 4L 1011 FT	Diesel	2732	4	91.00	2
BF 4L 1011E	Diesel	2730	4	91.00	3
BF 4L 2011	Diesel	3110	4	94.00	6
BF 4L 912	Diesel	3768	4	100.00	12
BF 4L 913	Diesel	4068	4	102.00	19
BF 4L 913 C	Diesel	4086	4	102.00	19
BF 4L 913 FC	Diesel	4086	4	102.00	20
BF 4L 913 T	Diesel	4086	4	102.00	21
BF 4L 913 T	Diesel	4086	4	102.00	22
BF 4L1011T	Diesel	2730	4	91.00	3
BF 4M 1011 F	Diesel	2912	4	91.00	2
BF 4M 1012 C Euro 1	Diesel	3192	4	94.00	7
BF 4M 1012 E Euro 2	Diesel	3192	4	94.00	7
BF 4M 1012 EC	Diesel	3192	4	94.00	7
BF 4M 1012 Euro 1	Diesel	3192	4	94.00	7
BF 4M 1013 C Euro 1	Diesel	4764	4	108.00	25
BF 4M 1013 E Euro 2	Diesel	4764	4	108.00	26
BF 4M 1013 Euro 1	Diesel	4764	4	108.00	25
BF 4M 1013E C Euro 2	Diesel	4764	4	108.00	26
BF 4M 2011	Diesel	3110	4	94.00	6
BF 4M 2012 C Euro 2	Diesel	4038	4	101.00	18
BF 4M 2012 Euro 2	Diesel	4038	4	101.00	18
BF 4M 2013 C	Diesel	3802	4	98.00	11
BF 5L 912	Diesel	4710	5	100.00	12
BF 6L 413 FR	Diesel	9572	6	125.00	35
BF 6L 413 FRW	Diesel	9572	6	125.00	35
BF 6L 513	Diesel	9572	6	125.00	36
BF 6L 513 C	Diesel	9572	V6	125.00	35
BF 6L 714A	Diesel	9500	V6	120.00	31
BF 6L 912	Diesel	5655	6	100.00	12
BF 6L 913	Diesel	6128	6	102.00	19
BF 6L 913 C	Diesel	6128	6	102.00	19
BF 6L 913 FC	Diesel	6128	6	102.00	20
BF 6L 913 T	Diesel	6128	6	102.00	21
BF 6L 913 T	Diesel	6128	6	102.00	22
BF 6M 1012 C Euro 1	Diesel	4788	6	94.00	7
BF 6M 1012 E	Diesel	4788	6	94.00	7
BF 6M 1012 EC	Diesel	4788	6	94.00	7
BF 6M 1012 Euro 1	Diesel	4788	6	94.00	7
BF 6M 1013 C Euro 1	Diesel	7145	6	108.00	25
BF 6M 1013 CP Euro 1	Diesel	7145	6	108.00	25
BF 6M 1013 E Euro 2	Diesel	7145	6	108.00	26
BF 6M 1013 EC Euro 2	Diesel	7145	6	108.00	26
BF 6M 1013 Euro 1	Diesel	7145	6	108.00	25

ENGINE INDEX

Motorverzeichnis • Index de moteur • Índice de Motor
Indeks silnika • Модель двигателя • دليل المحرك



CCM

x



9

BF 6M 1013 FC Euro 2/3	Diesel	7145	6	108.00	26
BF 6M 1013E CP Euro 2/3	Diesel	7145	6	108.00	26
BF 6M 1015 C	Diesel	11905	V6	132.00	39
BF 6M 2012 C Euro 2	Diesel	6057	6	101.00	18
BF 6M 2013	Diesel	5702	6	98.00	11
BF 6M 2013 C	Diesel	5702	6	98.00	11
BF 6M 716	Diesel		6	135.00	40
BF 8L 413 F	Diesel	12763	V8	125.00	35
BF 8L 413 FRW	Diesel	12763	8	125.00	35
BF 8L 513	Diesel	12763	V8	125.00	36
BF 8L 513 C	Diesel	13738	8	125.00	36
BF 8L 714A	Diesel	12667	V8	120.00	31
BF 8M 1015 C	Diesel	15874	V8	132.00	39
BF 8M 716	Diesel		8	135.00	40
BF10L 413 F	Diesel	15953	V10	125.00	35
BF10L 513	Diesel	15954	V10	125.00	36
BF10L 513 C	Diesel	15954	V10	125.00	36
BF10L 513 F	Diesel	15945	V10	125.00	35
BF10L 714A	Diesel	15833	V10	120.00	31
BF10LXE 413 FRW	Diesel	15945	10	125.00	35
BF12L 413 F	Diesel	19144	V12	125.00	35
BF12L 413 FRW	Diesel	19140	V12	125.00	35
BF12L 513	Diesel	19144	V12	125.00	36
BF12L 513 C	Diesel	19144	V12	125.00	35
BF12L 513 F	Diesel	19144	V12	125.00	35
BF12L 714A	Diesel	19000	V12	120.00	31
BF12M 716	Diesel		V12	135.00	40
BF16M 716	Diesel		V16	135.00	40
F 1L 411	Diesel		1	92.00	5
F 1L 511	Diesel	824	1	100.00	13
F 1L 511 D	Diesel	825	1	100.00	13
F 1L 514	Diesel	1330	1	110.00	28
F 1L 514 F	Diesel		1	115.00	30
F 1L 612	Diesel	850	1	95.00	9
F 1L 712	Diesel	850	1	95.00	9
F 1L 812	Diesel	850	1	95.00	10
F 2L 1011 F	Diesel	1366	2	91.00	4
F 2L 2011	Diesel	1554	2	94.00	8
F 2L 411	Diesel		2	92.00	5
F 2L 511	Diesel	824	2	100.00	13
F 2L 511 D	Diesel	1650	2	100.00	13
F 2L 514	Diesel	2660	2	110.00	28
F 2L 514 F	Diesel		2	115.00	30
F 2L 612	Diesel	1700	2	95.00	9
F 2L 712	Diesel	1700	2	95.00	9
F 2L 812	Diesel	1700	2	95.00	10
F 2L 912	Diesel	1885	2	100.00	14
F 2L 912 D	Diesel	1885	2	100.00	15
F 2L 912 W	Diesel	1884	2	100.00	16
F 2M 2011	Diesel	1555	2	94.00	8
F 3L 1011 F	Diesel	2049	3	91.00	4
F 3L 2011	Diesel	2332	3	94.00	8
F 3L 514	Diesel	3990	3	110.00	28
F 3L 514 F	Diesel		3	115.00	30
F 3L 612	Diesel	2552	3	95.00	9
F 3L 712	Diesel	2552	3	95.00	9
F 3L 812	Diesel	2552	3	95.00	10
F 3L 911	Diesel	2474	3	100.00	17
F 3L 912	Diesel	2827	3	100.00	14
F 3L 912 D	Diesel	2826	3	100.00	15



CCM

x



9

F 3L 912 W	Diesel	2826	3	100.00	16
F 3L 913 G	Diesel	3064	3	102.00	23
F 3M 1008	Diesel		3	72.00	1
F 3M 1011 F	Diesel	2185	3	91.00	4
F 3M 2011	Diesel	2332	3	94.00	8
F 4L 1011 F	Diesel	2732	4	91.00	4
F 4L 2011	Diesel	3110	4	94.00	8
F 4L 413 FR	Diesel	6381	4	125.00	37
F 4L 413 R	Diesel	5880	4	120.00	32
F 4L 514	Diesel	5320	4	110.00	28
F 4L 514 F	Diesel		4	115.00	30
F 4L 612	Diesel	3400	4	95.00	9
F 4L 712	Diesel	3400	4	95.00	9
F 4L 812	Diesel	3400	4	95.00	10
F 4L 911	Diesel	3300	4	100.00	17
F 4L 912	Diesel	3770	4	100.00	14
F 4L 912 D	Diesel	3770	4	100.00	15
F 4L 912 F	Diesel	4086	4	102.00	21
F 4L 912 W	Diesel	3770	4	100.00	16
F 4L 913	Diesel	4086	4	102.00	23
F 4L 913 D	Diesel	4086	4	102.00	24
F 4M 1008	Diesel		4	72.00	1
F 4M 1011 F	Diesel	2732	4	91.00	4
F 4M 2011	Diesel	3110	4	94.00	8
F 5L 413	Diesel	7070	5	120.00	32
F 5L 413 FR	Diesel	7976	5	125.00	37
F 5L 413 R	Diesel	7350	5	120.00	32
F 5L 912	Diesel	4712	5	100.00	14
F 5L 912 D	Diesel	4712	5	100.00	15
F 5L 912 F	Diesel	5107	5	102.00	21
F 5L 912 W	Diesel	4710	5	100.00	16
F 6L 312	Diesel	7480	6	115.00	30
F 6L 413	Diesel	8478	V6	120.00	32
F 6L 413	Diesel	8478	V6	120.00	33
F 6L 413 F	Diesel	9572	V6	125.00	37
F 6L 413 FR	Diesel	9572	6	125.00	37
F 6L 413 FW	Diesel	9572	V6	125.00	37
F 6L 413 L	Diesel	8482	V6	120.00	32
F 6L 413 R	Diesel	8822	6	120.00	32
F 6L 513	Diesel	10038	V6	128.00	38
F 6L 514	Diesel	7980	V6	110.00	28
F 6L 514 F	Diesel		V6	115.00	30
F 6L 612	Diesel	5104	6	95.00	9
F 6L 613	Diesel	7412	V6	110.00	28
F 6L 614	Diesel	7980	V6	110.00	28
F 6L 712	Diesel	5104	6	95.00	9
F 6L 714	Diesel	9500	6	120.00	31
F 6L 714 A	Diesel	9500	V6	120.00	31
F 6L 812 D	Diesel	5100	6	95.00	10
F 6L 814	Diesel	8730	6	115.00	30
F 6L 911	Diesel	4900	6	100.00	17
F 6L 912	Diesel	5660	6	100.00	14
F 6L 912 D	Diesel	5655	6	100.00	15
F 6L 912 F	Diesel	6128	6	102.00	21
F 6L 912 W	Diesel	5655	6	100.00	16
F 6L 913	Diesel	6128	6	102.00	23
F 6L 913 D	Diesel	6128	6	102.00	24
F 8L 312	Diesel	9970	8	115.00	30
F 8L 413	Diesel	11310	V8	120.00	33
F 8L 413 F	Diesel	12763	V8	125.00	37

ENGINE INDEX

Motorverzeichnis • Index de moteur • Índice de Motor
Indeks silnika • Модель двигателя • دليل المحرك



CCM

x



9

F 8L 413 FW	Diesel	12763	V8	125.00	37
F 8L 413 L	Diesel	11310	V8	120.00	32
F 8L 513	Diesel	13383	V8	128.00	38
F 8L 614	Diesel	10643	V8	110.00	28
F 8L 714	Diesel	12700	8	120.00	31
F 8L 714 A	Diesel	12667	V8	120.00	31
F 8L 814	Diesel	11633	V8	115.00	30
F 8L 914	Diesel	12667	V8	120.00	34
F10L 312	Diesel		V10	115.00	30
F10L 413	Diesel	14140	V10	120.00	33
F10L 413 F	Diesel	15953	V10	125.00	37
F10L 413 FW	Diesel	15953	V10	125.00	37
F10L 413 L	Diesel	14137	V10	120.00	32
F10L 513	Diesel	16728	V10	128.00	38
F10L 714	Diesel	15800	10	120.00	31
F10L 714 A	Diesel	15833	V10	120.00	31
F10L 814	Diesel	14542	10	115.00	30
F12L 312	Diesel		V12	115.00	30
F12L 413	Diesel	16960	V12	120.00	33
F12L 413 F	Diesel	19144	V12	125.00	37
F12L 413 FW	Diesel	19144	V12	125.00	37
F12L 513	Diesel	20074	V12	128.00	38
F12L 614	Diesel	15966	V12	110.00	28
F12L 714 A	Diesel	19000	V12	120.00	31
F12L 814	Diesel	17500	12	115.00	30
TCD 2012 L4 2V Euro 3	Diesel	4038	4	101.00	18
TCD 2012 L6 2V Euro 3	Diesel	6057	6	101.00	18
TCD 2013 L4 2V Euro 2	Diesel	4764	4	108.00	26
TCD 2013 L4 4V Euro 4	Diesel	4764	4	108.00	27
TCD 2013 L6 2V Euro 2	Diesel	7145	6	108.00	26
TCD 2013 L6 4V Euro 4	Diesel	7145	6	108.00	27



							1
F 3M 1008		3cyl.			Diesel		FM6098
F 4M 1008		4cyl.			Diesel		FM6099
08-252900-00	STD	72.00	2.000		001 IF CR P		KV1
			2.000		005 P		STD
			3.000		231 CR P		STD

							2
BF 3M 1011 F		3cyl.	2184cc	40-46kW (54-63PS)	Diesel Turbo		TD18487
BF 4L 1011 F		4cyl.	2731cc	28-55kW (38-75PS)	Diesel Turbo		TD17230
BF 4L 1011 FT		4cyl.	2732cc	46kW (63PS)	Diesel Turbo		TD17228
BF 4M 1011 F		4cyl.	2912cc	28-61kW (38-83PS)	Diesel Turbo		TD18489
08-103200-00 08-103207-00	STD 0.50mm	91.00	3.000		008 MO P		KV1
			2.000		005 P		STD
			3.000		231 P		STD

							3
BF 4L 1011E		4cyl.	2730cc	46-56kW (63-76PS)	Diesel		FM6101
BF 4L1011T		4cyl.	2730cc	46-56kW (63-76PS)	Diesel Turbo		FM16101
08-252300-00	STD	91.00	3.000		008 CR P		KV1
			2.500		005 P		STD
			3.500		231 CR P		STD

							4
F 2L 1011 F		2cyl.	1366cc	20-22kW (27-30PS)	Diesel		TD17224
F 3L 1011 F		3cyl.	2049cc	16-33kW (22-45PS)	Diesel		TD17225
F 3M 1011 F		3cyl.	2185cc	17-36kW (23-49PS)	Diesel		TD17232
F 4L 1011 F		4cyl.	2732cc	24-47kW (33-64PS)	Diesel		TD17227
F 4M 1011 F		4cyl.	2732cc	24-48kW (33-65PS)	Diesel		TD18488
08-252200-00 12/1988→12/1990	STD	91.00	2.980		001 CR P		KV1
			2.500		005 P		STD
			3.500		231 P		STD
08-252500-00 08-252507-00 03/1989→	STD 0.50mm	91.00	2.000		001 CR P		KV1
			2.000		005 P		STD
			3.000		231 P		STD



5

F 1L 411		1cyl.			Diesel	FM6102
F 2L 411		2cyl.			Diesel	FM6103
08-175000-00	STD	92.00	2.500		008 MOL P	IKA
			2.500		005 IF P	STD
			2.500		005 IF P	STD
			5.000		231 CR P	STD

6

BF 3L 2011		3cyl.	2332cc	42-45kW (57-61PS)	Diesel Turbo	TD17389
BF 3M 2011		3cyl.	2332cc	46-49kW (63-67PS)	Diesel Turbo	TD17384
BF 4L 2011		4cyl.	3110cc	55-58kW (75-79PS)	Diesel Turbo	TD17391
BF 4M 2011		4cyl.	3110cc	62-65kW (84-88PS)	Diesel Turbo	TD17386
08-142100-00 08-142107-00	STD 0.50mm	94.00	3.000		008 IF CK P	KV1
			2.000		005 IFU P	F12/F14
			3.000		231 CR P	STD

7





BF 4M 1012 C Euro 1		4cyl.	3192cc	74-82kW (101-112PS)	Diesel Turbo Intercooled	TD17236
BF 4M 1012 E Euro 2		4cyl.	3192cc	51-66kW (69-90PS)	Diesel Turbo	TD17239
BF 4M 1012 EC		4cyl.	3192cc	63-84kW (86-114PS)	Diesel Turbo Intercooled	TD17233
BF 4M 1012 Euro 1		4cyl.	3192cc	58-65kW (79-88PS)	Diesel Turbo Intercooled	TD17235
BF 6M 1012 C Euro 1		6cyl.	4788cc	111-123kW (151-167PS)	Diesel Turbo Intercooled	TD17238
BF 6M 1012 E		6cyl.	4788cc	90-100kW (122-136PS)	Diesel Turbo	TD17240
BF 6M 1012 EC		6cyl.	4788cc	113-125kW (154-170PS)	Diesel Turbo Intercooled	TD17234
BF 6M 1012 Euro 1		6cyl.	4788cc	88-98kW (120-133PS)	Diesel Turbo Intercooled	TD17237
08-252800-00 08-252807-00 [R67931]	STD 0.50mm	94.00	3.000		008 CR P	KV1
			2.000		005 P	STD
			3.000		231 CR P	STD

8





F 2L 2011		2cyl.	1554cc	21-23kW (29-31PS)	Diesel	TD17387
F 2M 2011		2cyl.	1555cc	23-24kW (31-33PS)	Diesel	TD17382
F 3L 2011		3cyl.	2332cc	34-36kW (46-49PS)	Diesel	TD17388
F 3M 2011		3cyl.	2332cc	34-37kW (46-50PS)	Diesel	TD17383
F 4L 2011		4cyl.	3110cc	45-48kW (61-65PS)	Diesel	TD17390
F 4M 2011		4cyl.	3110cc	46-49kW (63-67PS)	Diesel	TD17385
08-146500-00 08-146507-00	STD 0.50mm	94.00	2.000		001 CR	KV1
			2.000		005 IFU P	F12/F14
			3.000		231 P	F12/F14





9

F 1L 612		1cyl.	850cc		Diesel		FM6104
F 1L 712		1cyl.	850cc	9kW (12PS)	Diesel		TD17870
F 2L 612		2cyl.	1700cc	17kW (23PS)	Diesel		FM1914
F 2L 712		2cyl.	1700cc	13kW (18PS)	Diesel		TD17874
F 3L 612		3cyl.	2552cc	24kW (33PS)	Diesel		TD25761
F 3L 712		3cyl.	2552cc	28kW (38PS)	Diesel		TD17877
F 4L 612		4cyl.	3400cc		Diesel		FM6107
F 4L 712		4cyl.	3400cc	38kW (52PS)	Diesel		TD17879
F 6L 612		6cyl.	5104cc		Diesel		FM6108
F 6L 712		6cyl.	5104cc	66kW (89PS)	Diesel		TD19239
08-164400-00	STD	95.00	2.500		001 CR P		STD
08-164407-00	0.50mm		2.500		005 P		STD
08-164411-00	1.00mm		2.500		005 P		STD
			5.000		231 P		STD
			5.000		030 P		STD

10

F 1L 812		1cyl.	850cc	9kW (12PS)	Diesel		TD17871
F 2L 812		2cyl.	1700cc	15-22kW (20-30PS)	Diesel		TD17875
F 3L 812		3cyl.	2552cc	25-32kW (34-44PS)	Diesel		TD17878
F 4L 812		4cyl.	3400cc	33-39kW (45-53PS)	Diesel		TD17880
F 6L 812 D		6cyl.	5100cc	74kW (100PS)	Diesel		TD7448
08-166400-00	STD	95.00	2.500		001 CR P		IKA
08-166407-00	0.50mm		2.500		001 IF P		STD
08-166411-00	1.00mm		2.500		023 P		STD
			5.000		231 P		STD

11

BF 4M 2013 C		4cyl.	3802cc	125kW (170PS)	Diesel	Turbo Intercooled	TD17316
BF 6M 2013		6cyl.	5702cc	92kW (125PS)	Diesel	Turbo	TD17318
BF 6M 2013 C		6cyl.	5702cc	118-190kW (160-258PS)	Diesel	Turbo Intercooled	TD17317
08-127800-00	STD	98.00	3.000		008 IW CK P		KV1
			2.000		005 IFU P		F12/F14
			3.000		231 NT		F12/F14



12

BF 2L 912		2cyl.	1884cc		Diesel Turbo	FM6110
BF 3L 912		3cyl.	2826cc		Diesel Turbo	FM6111
BF 4L 912		4cyl.	3768cc		Diesel Turbo	FM6112
BF 5L 912		5cyl.	4710cc		Diesel Turbo	FM6113
BF 6L 912		6cyl.	5655cc	88-100kW (120-136PS)	Diesel Turbo	TD18348
08-172500-00	STD	100.00	3.000		008 CR P	KV1
08-172507-00	0.50mm		2.500		005 IF P	STD
08-172511-00	1.00mm		2.500		026 P	STD
[R32050K]			5.000		231 CR P	STD

13

F 1L 511		1cyl.	824cc	13kW (18PS)	Diesel	TD26611
F 1L 511 D		1cyl.	825cc	11-13kW (15-18PS)	Diesel	TD17869
F 2L 511		2cyl.	824cc	25kW (34PS)	Diesel	TD26612
F 2L 511 D		2cyl.	1650cc	22-26kW (30-35PS)	Diesel	TD17872
08-741800-00	STD	100.00	2.940		008 IF CR P	IKA
08-741807-00	0.50mm		2.550		005 IFU P	STD
08-741811-00	1.00mm		5.000		231 CR P	STD
04/1978→						
[R45190]						

14

F 2L 912		2cyl.	1885cc	21-28kW (32-38PS)	Diesel	TD18128
F 3L 912		3cyl.	2827cc	24-40kW (33-54PS)	Diesel	TD17207
F 4L 912		4cyl.	3770cc	32-54kW (44-73PS)	Diesel	TD17208
F 5L 912		5cyl.	4712cc	40-68kW (54-92PS)	Diesel	TD17209
F 6L 912		6cyl.	5660cc	48-82kW (65-112PS)	Diesel	TD17210
08-741800-00	STD	100.00	2.940		008 IF CR P	IKA
08-741807-00	0.50mm		2.550		005 IFU P	STD
08-741811-00	1.00mm		5.000		231 CR P	STD
01/1969→12/1993						
[R45190]						
08-744600-00	STD	100.00	2.940		008 IF CR P	KV1
08-744607-00	0.50mm		2.000		005 IFU P	STD
08-744611-00	1.00mm		3.500		231 CR P	STD
01/1993→						
[R66520]						



15



F 2L 912 D		2cyl.	1885cc	21-28kW (29-38PS)	Diesel	FM7020
F 3L 912 D		3cyl.	2826cc	26kW (35PS)	Diesel	TD19020
F 4L 912 D		4cyl.	3770cc	38kW (52PS)	Diesel	TD19021
F 5L 912 D		5cyl.	4712cc	58kW (79PS)	Diesel	TD19023
F 6L 912 D		6cyl.	5655cc	42kW (57PS)	Diesel	TD19030
08-122100-00	STD	100.00	2.940		008 IF CR P	KV1
			2.000		005 IFU P	STD
			3.000		231 CR P	GOE13
08-172500-00 08-172507-00 08-172511-00 01/1969→ [R32050K]	STD 0.50mm 1.00mm	100.00	3.000		008 CR P	KV1
			2.500		005 IF P	STD
			2.500		026 P	STD
			5.000		231 CR P	STD
			3.000		008 CR P	IKA
08-179400-00 08-179407-00 08-179411-00 01/1969→	STD 0.50mm 1.00mm	100.00	2.500		005 IF P	STD
			2.500		026 P	STD
			5.000		231 CR P	STD
			3.000		008 CR P	IKA
08-741800-00 08-741807-00 08-741811-00 01/1969→12/1993 [R45190]	STD 0.50mm 1.00mm	100.00	2.940		008 IF CR P	IKA
			2.550		005 IFU P	STD
			5.000		231 CR P	STD
08-744600-00 08-744607-00 08-744611-00 01/1993→ [R66520]	STD 0.50mm 1.00mm	100.00	2.940		008 IF CR P	KV1
			2.000		005 IFU P	STD
			3.500		231 CR P	STD

16



F 2L 912 W		2cyl.	1884cc	22kW (30PS)	Diesel	FM6565
F 3L 912 W		3cyl.	2826cc	25kW (34PS)	Diesel	TD19019
F 4L 912 W		4cyl.	3770cc	38kW (52PS)	Diesel	TD19022
F 5L 912 W		5cyl.	4710cc	61kW (82PS)	Diesel	FM6566
F 6L 912 W		6cyl.	5655cc	57kW (77PS)	Diesel	TD19024
08-179400-00 08-179407-00 08-179411-00 01/1969→	STD 0.50mm 1.00mm	100.00	3.000		008 CR P	IKA
			2.500		005 IF P	STD
			2.500		026 P	STD
			5.000		231 CR P	STD



17

F 3L 911		3cyl.	2474cc	29-37kW (40-50PS)	Diesel		FM1943
F 4L 911		4cyl.	3300cc	39-49kW (53-67PS)	Diesel		FM4266
F 6L 911		6cyl.	4900cc	51-74kW (80-100PS)	Diesel		FM4270
08-741800-00	STD	100.00	2.940		008 IF CR P		IKA
08-741807-00	0.50mm		2.550		005 IFU P		STD
08-741811-00	1.00mm		5.000		231 CR P		STD
04/1968→							
[R45190]							

18

BF 4M 2012 C Euro 2		4cyl.	4038cc	56-155kW (76-208PS)	Diesel	Turbo Intercooled	TD17259
BF 4M 2012 Euro 2		4cyl.	4038cc	74-93kW (101-126PS)	Diesel	Turbo Intercooled	TD17258
BF 6M 2012 C Euro 2		6cyl.	6057cc	80-155kW (109-209PS)	Diesel	Turbo Intercooled	TD17261
TCD 2012 L4 2V Euro 3		4cyl.	4038cc	83-103kW (113-140PS)	Diesel	Turbo Intercooled	TD19989
TCD 2012 L6 2V Euro 3		6cyl.	6057cc	105-165kW (142-224PS)	Diesel	Turbo Intercooled	TD19990
08-127900-00	STD	101.00	2.500		008 IW CK P		KV1
01/2001→			2.000		005 IFU P		F12/F14
			3.000		231 CR P		GOE13



19

BF 4L 913		4cyl.	4068cc	47-78kW (64-106PS)	Diesel Turbo	TD17203
BF 4L 913 C		4cyl.	4086cc	78-92kW (106-125PS)	Diesel Turbo Intercooled	TD21059
BF 6L 913		6cyl.	6128cc	70-118kW (95-160PS)	Diesel Turbo	TD17205
BF 6L 913 C		6cyl.	6128cc	81-142kW (110-193PS)	Diesel Turbo Intercooled	TD17206
08-135000-00 ¹ 01/1997→	STD	102.00	2.940		008 IW MOL P	KV1
			2.000		005 IFU P	STD
			3.000		231 CR P	STD
08-138700-00 ²	STD	102.00	2.940		008 IF MO P	KV1
			3.000		009 P	IKA
			3.000		231 CR P	GOE13
08-178400-10 08-178407-10	STD 0.50mm	102.00	3.000		008 MO P	KV1
			3.000		009 CR P	IKA
			2.500		005 IW	STD
			5.000		231 CR P	STD
08-252600-00	STD	102.00	2.940		008 IF MO P	KV1
			3.000		009 P	IKA
			3.500		231 CR P	STD
08-744700-00 08-744707-00 12/1989→	STD 0.50mm	102.00	2.940		008 IF MO P	KV1
			3.000		009 CR P	IKA
			3.500		231 CR P	STD

¹ OE 423-1717 ¹ OE 423-1717 ¹ OE 423-1717 ¹ OE 423-1717
² OE 423-1303 ² OE 423-1303 ² OE 423-1303 ² OE 423-1303

20

BF 4L 913 FC		4cyl.	4086cc	Diesel Turbo	FM26115	
BF 6L 913 FC		6cyl.	6128cc	Diesel Turbo	FM4273	
08-178400-10 08-178407-10 01/1980→	STD 0.50mm	102.00	3.000		008 MO P	KV1
			3.000		009 CR P	IKA
			2.500		005 IW	STD
			5.000		231 CR P	STD



21

BF 4L 913 T		4cyl.	4086cc	64-78kW (87-106PS)	Diesel Turbo	TD7270
BF 6L 913 T		6cyl.	6128cc	85-112kW (115-152PS)	Diesel Turbo	TD7286
F 4L 912 F		4cyl.	4086cc		Diesel	FM5922
F 5L 912 F		5cyl.	5107cc		Diesel	FM5925
F 6L 912 F		6cyl.	6128cc		Diesel	FM5926
08-744100-00 08-744107-00 01/1991→	STD 0.50mm	102.00	2.940		008 IF CR P	KV1
			2.550		005 P	STD
[R66540]			3.500		231 CR P	STD

22

BF 4L 913 T		4cyl.	4086cc	64-78kW (87-106PS)	Diesel Turbo	TD18347
BF 6L 913 T		6cyl.	6128cc	85-112kW (115-152PS)	Diesel Turbo	TD18350
08-174600-10 08-174607-10 01/1981→12/1991	STD 0.50mm	102.00	3.000		008 MO P	KV1
			2.500		005 IW P	STD
			2.500		023 P	STD
			5.000		231 CR P	STD

23

F 3L 913 G		3cyl.	3064cc	37kW (50PS)	Diesel	TD17201
F 3L 913 G		3cyl.	3064cc	37kW (50PS)	Diesel	FM6601
F 4L 913		4cyl.	4086cc	50-78kW (68-106PS)	Diesel	TD7277
F 6L 913		6cyl.	6128cc	96kW (131PS)	Diesel	TD7451
08-740900-00 08-740907-00 01/1984→	STD 0.50mm	102.00	2.940		008 IF MO P	KV1
			2.550		005 IF P	IKA
[R66530]			5.000		231 CR P	STD
08-744100-00 08-744107-00 01/1992→	STD 0.50mm	102.00	2.940		008 IF CR P	KV1
			2.550		005 P	STD
[R66540]			3.500		231 CR P	STD

24

F 4L 913 D		4cyl.	4086cc	34-59kW (46-80PS)	Diesel	TD17202
F 6L 913 D		6cyl.	6128cc	51-89kW (69-121PS)	Diesel	TD17204
08-174600-10 08-174607-10 04/1972→	STD 0.50mm	102.00	3.000		008 MO P	KV1
			2.500		005 IW P	STD
			2.500		023 P	STD
			5.000		231 CR P	STD



25

BF 4M 1013 C Euro 1		4cyl.	4764cc	104-115kW (141-156PS)	Diesel	Turbo Intercooled	TD17247
BF 4M 1013 Euro 1		4cyl.	4764cc	84-93kW (114-126PS)	Diesel	Turbo	TD17246
BF 6M 1013 C Euro 1		6cyl.	7145cc	153-170kW (208-231PS)	Diesel	Turbo Intercooled	TD17249
BF 6M 1013 CP Euro 1		6cyl.	7145cc	171-190kW (233-258PS)	Diesel	Turbo Intercooled	TD17250
BF 6M 1013 Euro 1		6cyl.	7145cc	126-141kW (171-192PS)	Diesel	Turbo	TD17248
08-123800-00	STD	108.00	3.000		008 IW CR P		KV1
			2.000		005 IF NT		IKA
			3.500		231 CR P		STD

26

BF 4M 1013 E Euro 2		4cyl.	4764cc	77-95kW (105-129PS)	Diesel	Turbo Intercooled	TD17244
BF 4M 1013E C Euro 2		4cyl.	4764cc	92-125kW (125-170PS)	Diesel	Turbo Intercooled	TD17241
BF 6M 1013 E Euro 2		6cyl.	7145cc	116-145kW (158-197PS)	Diesel	Turbo Intercooled	TD17245
BF 6M 1013 EC Euro 2		6cyl.	7145cc	139-174kW (189-237PS)	Diesel	Turbo Intercooled	TD17242
BF 6M 1013 FC Euro 2/3		6cyl.	7145cc	200-210kW (272-286PS)	Diesel	Turbo Intercooled	TD20768
BF 6M 1013E CP Euro 2/3		6cyl.	7145cc	176-195kW (239-265PS)	Diesel	Turbo Intercooled	TD17243
TCD 2013 L4 2V Euro 2		4cyl.	4764cc	120kW (163PS)	Diesel	Turbo Intercooled	TD20766
TCD 2013 L6 2V Euro 2		6cyl.	7145cc	200kW (272PS)	Diesel	Turbo Intercooled	TD19988
08-136900-00	STD	108.00	3.000		008 IW CK P		KV1
			2.000		005 IFU P		KV1
			3.500		231 CR P		STD

27

TCD 2013 L4 4V Euro 4		4cyl.	4764cc	158kW (215PS)	Diesel	Turbo Intercooled	TD20769
TCD 2013 L6 4V Euro 4		6cyl.	7145cc	243kW (330PS)	Diesel	Turbo Intercooled	TD20765
08-430000-00	STD	108.00	3.000		008 CK		KV1
			2.000		005 IFU		F12/F14
			3.500		231 CR		



28

F 1L 514	1cyl.	1330cc	11-13kW (15-18PS)	Diesel	TD25187
F 2L 514	2cyl.	2660cc	24kW (33PS)	Diesel	TD17873
F 3L 514	3cyl.	3990cc	37kW (50PS)	Diesel	TD17876
F 4L 514	4cyl.	5320cc	63kW (86PS)	Diesel	TD7446
F 6L 514	V6cyl.	7980cc	74kW (100PS)	Diesel	TD6774
F 6L 613	V6cyl.	7412cc	88-93kW (120-126PS)	Diesel	TD7450
F 6L 614	V6cyl.	7980cc	92kW (125PS)	Diesel	TD7470
F 8L 614	V8cyl.	10643cc	125kW (170PS)	Diesel	TD7457
F12L 614	V12cyl.	15966cc	184kW (250PS)	Diesel	TD7467

08-160800-00	STD	110.00	3.000		001 CR P	STD
08-160807-00	0.50mm		3.000		001 IF P	STD
08-160811-00	1.00mm		3.000		023 P	STD
08-160814-00	1.50mm		6.000		231 P	STD
			6.000		030 P	STD

29

8360.05.670 (Magirus-Deutz)	6cyl.	8100cc	119kW (162PS)	Diesel	TD7572	
08-214900-10	STD	115.00	2.500		001 IF CR P	IKA
[R47530]			2.500		005 P	STD
			4.000		231 CR P	STD
08-523000-00	STD	115.00	2.500		001 IF CR P	IKA
[R47510]			2.500		001 IF P	GOE12
			4.000		231 CR P	GOE12



30

F 1L 514 F	1cyl.			Diesel	FM5723	
F 2L 514 F	2cyl.			Diesel	FM5689	
F 3L 514 F	3cyl.			Diesel	FM5688	
F 4L 514 F	4cyl.			Diesel	FM5687	
F 6L 312	6cyl.	7480cc	110kW (150PS)	Diesel	TD7454	
F 6L 514 F	V6cyl.			Diesel	FM5682	
F 6L 814	6cyl.	8730cc	115-154kW (156-209PS)	Diesel	TD7455	
F 8L 312	8cyl.	9970cc	132kW (180PS)	Diesel	TD7460	
F 8L 814	V8cyl.	11633cc	154kW (210PS)	Diesel	TD7463	
F10L 312	V10cyl.			Diesel	FM6128	
F10L 814	10cyl.	14542cc	184kW (250PS)	Diesel	TD7466	
F12L 312	V12cyl.			Diesel	FM6129	
F12L 814	12cyl.	17500cc	210-228kW (286-310PS)	Diesel	TD6778	
08-167700-00	STD	115.00	3.000		001 CR P	KV1
			3.000		001 IF P	STD
			3.000		023 P	STD
			6.000		231 CR P	STD

31

BF 6L 714A	V6cyl.	9500cc		Diesel	FM6139	
BF 8L 714A	V8cyl.	12667cc		Diesel	FM6140	
BF10L 714A	V10cyl.	15833cc		Diesel	FM6141	
BF12L 714A	V12cyl.	19000cc		Diesel	FM6142	
F 6L 714	6cyl.	9500cc	110kW (150PS)	Diesel	TD7453	
F 6L 714 A	V6cyl.	9500cc		Diesel	FM6135	
F 8L 714	8cyl.	12700cc	143kW (195PS)	Diesel	TD7461	
F 8L 714 A	V8cyl.	12667cc		Diesel	FM6136	
F10L 714	10cyl.	15800cc	173kW (235PS)	Diesel	TD7465	
F10L 714 A	V10cyl.	15833cc		Diesel	FM6137	
F12L 714 A	V12cyl.	19000cc		Diesel	FM6138	
08-172800-10	STD	120.00	3.000		001 CR P	KV1
			3.000		001 IF P	STD
			3.000		023 P	STD
			6.000		231 CR P	STD
			6.000		030 P	STD



32

F 4L 413 R		4cyl.	5880cc	90kW (122PS)	Diesel	TD19026
F 5L 413		5cyl.	7070cc		Diesel	FM6143
F 5L 413 R		5cyl.	7350cc	83-112kW (113-152PS)	Diesel	TD17881
F 6L 413		V6cyl.	8478cc	99-130kW (135-177PS)	Diesel	TD7444
F 6L 413 L		V6cyl.	8482cc	137kW (186PS)	Diesel	FM5381
F 6L 413 R		6cyl.	8822cc	100-135kW (136-184PS)	Diesel	TD17884
F 8L 413 L		V8cyl.	11310cc	179kW (243PS)	Diesel	FM5382
F10L 413 L		V10cyl.	14137cc	198-224kW (270-305PS)	Diesel	FM5383
08-172900-10 03/1967→	STD	120.00	3.500		008 MO P	KV1
			3.000		005 IF P	STD
			3.000		026 P	STD
			6.000		231 CR P	STD

33

F 6L 413		V6cyl.	8478cc	99-130kW (135-177PS)	Diesel	TD18362
F 8L 413		V8cyl.	11310cc	169kW (230PS)	Diesel	TD18363
F10L 413		V10cyl.	14140cc	167-224kW (227-305PS)	Diesel	TD18352
F12L 413		V12cyl.	16960cc	250kW (340PS)	Diesel	TD18354
08-167600-10 08-167607-10 08-167611-10	STD 0.50mm 1.00mm	120.00	3.000		001 CR P	IKA
			3.000		001 IF P	STD
			3.000		026 P	STD
			6.000		231 CR P	STD
08-177800-00	STD	120.00	3.000		001 MO P	KV1
			3.000		005 IF P	STD
			3.000		023 P	STD
			6.000		231 CR P	STD

34

F 8L 914		V8cyl.	12667cc	169kW (230PS)	Diesel	TD7464
08-167600-10 08-167607-10 08-167611-10	STD 0.50mm 1.00mm	120.00	3.000		001 CR P	IKA
			3.000		001 IF P	STD
			3.000		026 P	STD
			6.000		231 CR P	STD



35

BF 6L 413 FR	6cyl.	9572cc	143kW (195PS)	Diesel	Turbo	TD19028
BF 6L 413 FRW	6cyl.	9572cc		Diesel	Turbo	FM6146
BF 6L 513 C	V6cyl.	9572cc	112-177kW (152-241PS)	Diesel	Turbo Intercooled	TD21275
BF 8L 413 F	V8cyl.	12763cc	212-235kW (288-320PS)	Diesel	Turbo	TD18351
BF 8L 413 FRW	8cyl.	12763cc		Diesel	Turbo	FM6147
BF10L 413 F	V10cyl.	15953cc	265-294kW (360-400PS)	Diesel	Turbo	TD18344
BF10L 513 F	V10cyl.	15945cc	253-294kW (344-400PS)	Diesel	Turbo	TD19241
BF10LXE 413 FRW	10cyl.	15945cc		Diesel	Turbo	FM6148
BF12L 413 F	V12cyl.	19144cc	268-353kW (364-480PS)	Diesel	Turbo	TD18346
BF12L 413 FRW	V12cyl.	19140cc		Diesel	Turbo	FM5677
BF12L 513 C	V12cyl.	19144cc	386-405kW (525-551PS)	Diesel	Turbo Intercooled	TD18498
BF12L 513 F	V12cyl.	19144cc	282-353kW (384-480PS)	Diesel	Turbo	TD19029

08-740300-00	STD	125.00	3.000		008 MO P	KV1
08-740307-00	0.50mm				005 IW P	STD
08-740311-00	1.00mm		2.500		231 CR P	STD
[R45150]			4.000			

36

BF 6L 513	6cyl.	9572cc	141-210kW (192-286PS)	Diesel	Turbo	TD19240
BF 8L 513	V8cyl.	12763cc	235-250kW (320-340PS)	Diesel	Turbo	TD18495
BF 8L 513 C	8cyl.	13738cc	265kW (360PS)	Diesel	Turbo Intercooled	TD26618
BF10L 513	V10cyl.	15954cc	218-305kW (296-415PS)	Diesel	Turbo	TD18127
BF10L 513 C	V10cyl.	15954cc	265-294kW (360-400PS)	Diesel	Turbo Intercooled	TD21060
BF12L 513	V12cyl.	19144cc	353-367kW (480-499PS)	Diesel	Turbo	TD18496

08-740500-00	STD	125.00	3.500		008 MOL P	KV1
01/1985→			3.000		009 CR P	STD
			4.000		231 CR P	STD
08-743500-00	STD	125.00	3.500		008 MOL P	KV1
08/1989→			2.500		005 IF CR P	STD
			4.000		231 CR P	STD



37

F 4L 413 FR	4cyl.	6381cc	94kW (128PS)	Diesel	TD18340
F 5L 413 FR	5cyl.	7976cc	94-118kW (128-160PS)	Diesel	TD17882
F 6L 413 F	V6cyl.	9572cc	104-188kW (141-256PS)	Diesel	TD18341
F 6L 413 FR	6cyl.	9572cc	112-141kW (152-192PS)	Diesel	TD21274
F 6L 413 FW	V6cyl.	9572cc	96-121kW (131-165PS)	Diesel	TD17883
F 8L 413 F	V8cyl.	12763cc	147-188kW (200-256PS)	Diesel	TD7256
F 8L 413 FW	V8cyl.	12763cc	129-150kW (175-204PS)	Diesel	TD17885
F10L 413 F	V10cyl.	15953cc	235kW (320PS)	Diesel	TD7331
F10L 413 FW	V10cyl.	15953cc	161-202kW (219-275PS)	Diesel	TD17886
F12L 413 F	V12cyl.	19144cc	224-282kW (305-384PS)	Diesel	TD6770
F12L 413 FW	V12cyl.	19144cc	193-243kW (262-330PS)	Diesel	TD17888

08-440400-00	STD	125.00	3.000		008 MO	KV1
08-440407-00	0.50mm		2.500		005 P	STD
08-440411-00	1.00mm		4.000		231 CR	STD

38

F 6L 513	V6cyl.	10038cc	141kW (192PS)	Diesel	FM6032
F 8L 513	V8cyl.	13383cc	155-194kW (211-264PS)	Diesel	TD18343
F10L 513	V10cyl.	16728cc	188-242kW (256-329PS)	Diesel	TD17887
F12L 513	V12cyl.	20074cc	282kW (384PS)	Diesel	TD18492

08-740400-00	STD	128.00	3.500		008 MOL P	KV1
01/1985→			3.000		005 P	STD
			4.000		231 CR P	STD

39

BF 6M 1015 C	V6cyl.	11905cc	250-345kW (340-469PS)	Diesel	Turbo Intercooled	TD17252
BF 8M 1015 C	V8cyl.	15874cc	333-459kW (453-624PS)	Diesel	Turbo Intercooled	TD17253

08-123900-00	STD	132.00	3.500		008 IW CR P	KV1
			2.450		005 CR P	IKA
			4.000		231 CR P	GOE13
08-123900-10 ¹	STD	132.00	3.500		008 IW CK	KV1
			2.450		005 CR	F12/F14
			4.000		231 LKZ CR	GOE13



¹ Euro 2



40

BF 6M 716		6cyl.			Diesel Turbo	FM6151
BF 8M 716		8cyl.			Diesel Turbo	FM6152
BF12M 716		V12cyl.			Diesel Turbo	FM6153
BF16M 716		V16cyl.			Diesel Turbo	FM6154
08-172600-00	STD	135.00	4.000		001 P	STD
			3.000		005 IF P	STD
			3.000		005 IF P	STD
			6.000		231 P	STD

41

BA 6M 816		6cyl.	15204cc		Diesel Turbo	FM6155
BA 8M 816		V8cyl.	20272cc		Diesel Turbo	FM6156
BA12M 816		V12cyl.	30408cc	247-564kW (336-767PS)	Diesel Turbo	TD21051
BA12M 816 C		V12cyl.	30408cc	608-770kW (827-1047PS)	Diesel Turbo Intercooled	TD21052
BA12M 816 CR		V12cyl.	30408cc	850-950kW (1156-1292PS)	Diesel Turbo Intercooled	TD21053
BA12M 816 R		V12cyl.	30408cc	720-866kW (979-1178PS)	Diesel Turbo Intercooled	TD21054
BA12M 816 U		V12cyl.	30408cc	615-650kW (836-884PS)	Diesel Turbo Intercooled	TD21055
BA12M 816 W		V12cyl.	30408cc	665-710kW (904-966PS)	Diesel Turbo Intercooled	TD21056
BA16M 816		V16cyl.	40544cc		Diesel Turbo	FM6158
08-251300-10	STD	142.00	4.000		008 CR P	KV1
			3.000		005 IF P	STD
			6.000		231 CR P	STD



1

FF-1		6cyl.	18300cc		Diesel	FM6393
08-781600-00	STD	112.00	3.500		008 CR P	IKA
			3.000		001 IF P	STD
			3.500		023 P	STD
			6.000		032 P	STD

2

4F		6cyl.	9981cc		Diesel	FM6392
4FU		6cyl.	9981cc		Diesel	FM16392
08-781500-00	STD	123.00	3.000		008 CR P	IKA
			3.000		005 P	STD
			3.000		026 P	STD
			6.000		032 P	STD

3

2EP-B, 2FUB-B		6cyl.	11640cc	170kW (231PS)	Diesel	FM5591
2F-B		6cyl.	11040cc		Diesel	FM8950
2FP-B		6cyl.	11040cc		Diesel	FM28950
2FU-B		6cyl.	11040cc		Diesel	FM18950
2FUP-B		6cyl.	11040cc		Diesel	FM38950
08-781800-00	STD	125.00	3.500		008 CR P	IKA
			3.000		005 P	STD
			6.000		231 CR P	STD



CCM

x



9

12/68→12/72	124 1400	124 B2.000	Petrol	1438	4	24
01/71→07/75	124 1500	124 AC.000	Petrol	1438	4	24
01/73→07/75	124 1500	124 B2.000	Petrol	1438	4	24
06/67→10/72	124 Coupe 1400 Sport	124 AC.000	Petrol	1438	4	24
08/72→12/75	124 Coupe 1600 Sport	132 AC.000	Petrol	1592	4	24
09/67→05/71	124 Familiare 1.4	124 B.0000	Petrol	1438	4	24
01/66→12/72	124 Spider 1500 Sport	124 AC.000	Petrol	1438	4	24
01/69→12/74	124 Spider 1600 Sport	132 AC.000	Petrol	1592	4	24
11/69→08/73	124 Spider 1600 Sport	132 AC.000	Petrol	1592	4	24
01/72→12/77	124 Spider 1800 Sport	132 A.C1.000	Petrol	1756	4	51
03/82→11/85	124 Spider 2000	132 C3.031	Petrol	1995	4	51
07/67→03/74	125 1.6	125 A.000	Petrol	1608	4	24
05/69→10/73	125 1.6	125 B.000	Petrol	1608	4	24
09/72→06/77	126 600	126 A.000	Petrol	594	2	17
07/77→09/87	126 650	126 A1.000	Petrol	652	2	21
07/77→09/87	126 650	126 A1.048	Petrol	652	2	21
07/81→09/00	126 650	126 A1.048	Petrol	652	2	21
01/83→06/96	126 650	141 A.000	Petrol	652	2	21
09/87→06/96	126 700	126 A2.000	Petrol	704	2	24
09/87→06/96	126 700	126 A2.048	Petrol	704	2	24
06/71→05/83	127 0.9	100 GL.000	Petrol	903	4	1
06/71→05/83	127 0.9	100 GL.048	Petrol	903	4	1
	127 0.9	100 GL.064	Petrol	903	4	1
04/77→12/86	127 1.0	127 A.000	Petrol	903	4	1
07/78→02/82	127 1.0 Sport	127 A1.000	Petrol	1049	4	19
04/81→12/86	127 1.3 Diesel	127 A5.000	Diesel	1301	4	20
12/81→05/83	127 1.3 Sport	127 A3.000	Petrol	1297	4	19
01/77→12/86	127 Panorama 1.0	127 A.000	Petrol	903	4	1
06/81→12/86	127 Panorama 1.3 D	127 A5.000	Diesel	1301	4	20
03/69→12/84	128 1.1	128 A.000	Petrol	1116	4	24
02/75→09/81	128 1.1	128 A.048	Petrol	1116	4	24
03/72→02/81	128 Coupe 1.1	128 AC5.000	Petrol	1116	4	24
08/75→02/81	128 Coupe 1.1	128 AC5.000	Petrol	1116	4	24
10/69→10/82	128 Familiare 1.1	128 A.000	Petrol	1116	4	24
02/75→02/81	128 Familiare 1.1	128 A.048	Petrol	1116	4	24
10/74→09/81	131 1.3 Mirafiori	131 A6.000	Petrol	1297	4	19
03/78→12/80	131 1.3 Super Mirafiori	131 B.000	Petrol	1297	4	19
10/74→09/81	131 1.6	131 A1.000	Petrol	1585	4	50
11/76→12/84	131 1.6	131 C2.000	Petrol	1585	4	50
03/78→01/84	131 1.6 Super	131 C3.000	Petrol	1585	4	50
03/79→03/82	131 1.6 Super Mirafiori	131 B1.000	Petrol	1585	4	51
01/76→07/80	131 2.0 Abarth Rally	131 B2.000	Petrol	1995	4	50
06/78→12/81	131 2.0 Racing	131 B2.000	Petrol	1995	4	50
01/81→12/84	131 2.0 Super	131 C4.000	Petrol	1995	4	50
06/78→02/84	131 2.5 D	8142.61	Diesel	2445	4	66
06/78→02/84	131 2.5 D	8144.61	Diesel	2445	4	66
03/75→12/78	131 Familiare/Panorama 1.3 Mirafiori	131 A6.000	Petrol	1297	4	19
11/80→04/85	131 Familiare/Panorama 1.6	131 C2.000	Petrol	1585	4	50
03/75→12/78	131 Familiare/Panorama 1.6 CL	131 A1.000	Petrol	1585	4	50
12/79→12/81	131 Familiare/Panorama 1.6 Super	131 C3.000	Petrol	1585	4	50
01/81→12/84	131 Familiare/Panorama 2.0 Super	131 C4.000	Petrol	1995	4	50
03/79→12/84	131 Familiare/Panorama 2.5 Super Diesel	8144.61	Diesel	2445	4	66
04/72→01/76	132 1.6	132 BB OA O	Petrol	1585	4	24
01/76→12/82	132 1.6	132 C.000	Petrol	1585	4	51
05/77→09/82	132 1.6	132 C.000	Petrol	1585	4	51
04/74→12/75	132 1.7 GLS	132 B1.000	Petrol	1756	4	51
11/75→01/77	132 1.7 GLS	132 B1.000	Petrol	1756	4	51
04/72→01/74	132 1.7 Special	132 B1.000	Petrol	1756	4	51
01/72→12/77	132 1600 GL	132 A.000	Petrol	1592	4	24
05/77→06/81	132 2.0	132 C2.000	Petrol	1995	4	50

MODEL INDEX

Modelverzeichnis • Index de modele • Índice de Modelo
Indeks modelu • Модель автомобиля • دليل الموديل



CCM

x



9

01/76→12/76	132 2.0 GLS	132 C2.000	Petrol	1995	4	50
01/80→12/82	132 2.0 i.e.	132 C3.000	Petrol	1995	4	50
07/78→07/82	132 2.5 D	8144.61	Diesel	2445	4	66
04/80→12/95	147 1.0	127 A.000	Petrol	903	4	1
10/76→12/95	147 1.0	127 A.000	Petrol	903	4	1
07/82→06/84	147 1.3 D	127 A5.000	Diesel	1301	4	20
07/82→07/83	147 1.3 D	127 A5.000	Diesel	1301	4	20
10/75→07/82	242-Serie Box 1.6	124 B3.000	Petrol	1585	4	50
08/80→07/82	242-Serie Box 2.5 D	B 25.637	Diesel	2498	4	68
10/75→07/82	242-Serie Bus 1.6	124 B3.000	Petrol	1585	4	50
01/65→12/75	500 0.5	110 F.000	Petrol	499	2	5
01/65→12/75	500 0.5	120.000	Petrol	499	2	5
10/07→	500 1.2	169 A4.000	Petrol	1242	4	12
12/10→	500 1.2 LPG	169 A4.000	Petrol	1242	4	12
10/07→	500 1.3 D Multijet	169 A1.000	Diesel	1248	4	6
12/09→	500 1.3 D Multijet	199 B1.000 Euro 5	Diesel	1248	4	8
10/07→	500 1.4	169 A3.000	Petrol	1368	4	13
08/08→	500 1.4 Abarth	312 A1.000	Petrol	1368	4	15
05/10→	500 1.4 Abarth	312 A3.000	Petrol	1368	4	15
08/08→	500 1.4 Abarth	312 A3.000	Petrol	1368	4	15
09/09→	500 C 1.2	169 A4.000	Petrol	1242	4	12
09/09→	500 C 1.3 D Multijet	169 A1.000	Diesel	1248	4	6
09/09→	500 C 1.3 D Multijet	199 B1.000 Euro 5	Diesel	1248	4	8
09/09→	500 C 1.4	169 A3.000	Petrol	1368	4	13
01/11→	500 C 1.4	312 A1.000	Petrol	1368	4	15
05/11→	500 C 1.4 Abarth	312 A1.000	Petrol	1368	4	15
09/09→	500 C 1.4 Abarth	312 A3.000	Petrol	1368	4	15
01/60→12/66	500 Estate 0.5	120.000	Petrol	499	2	5
09/12→	500L 1.3 D Multijet	199 B4.000 Euro 5	Diesel	1248	4	8
09/12→	500L 1.4	843 A1.000 Euro 4 (Fire)	Petrol	1368	4	13
07/64→10/72	850 0.8	100 G.000	Petrol	843	4	1
07/64→10/72	850 0.8	100 G.002	Petrol	844	4	1
	850 0.8	100 GL6.000	Petrol	843	4	1
03/68→10/72	850 0.8 Special	100 GB.000	Petrol	844	4	1
	850 0.8 Special	100 GBC.000	Petrol	903	4	1
	850 0.8 Special	100 GBC.040	Petrol	903	4	1
	850 0.8 Special	100 GBS.000	Petrol	903	4	1
03/68→10/72	850 0.8 Special	100 GC.000	Petrol	844	4	1
01/78→01/86	900 T/E Panorama 0.9	100 GF 000	Petrol	903	4	1
01/78→01/86	900 T/E Pulmino 0.9	100 GF 000	Petrol	903	4	1
04/81→12/85	Argenta 1600	132 D.000	Petrol	1585	4	51
06/78→12/85	Argenta 2000	132 C2.000	Petrol	1995	4	50
06/78→12/85	Argenta 2000	132 D1.000	Petrol	1995	4	50
06/81→07/86	Argenta 2000 i.e.	132 C3.000	Petrol	1995	4	50
06/81→11/85	Argenta 2500 Diesel	8144.61	Diesel	2445	4	66
07/83→08/85	Argenta 2500 Turbodiesel	8144.61.500.81	Diesel	2445	4	66
04/95→05/05	Barchetta 1.8 16V	183 A1.000 Euro 2	Petrol	1747	4	31
04/95→05/05	Barchetta 1.8 16V	188 A6.000 Euro 3	Petrol	1747	4	37
12/98→12/02	Brava 1.2 16V	182 B2.000 (Fire)	Petrol	1242	4	12
12/98→12/02	Brava 1.2 16V 80	182 B2.000 (Fire)	Petrol	1242	4	12
10/00→10/01	Brava 1.2 16V 80	188 A5.000 Euro 3 (Fire)	Petrol	1242	4	12
10/95→10/01	Brava 1.4	182 A5.000	Petrol	1371	4	30
10/95→08/98	Brava 1.4 12 V	182 A3.000	Petrol	1371	4	30
02/96→10/01	Brava 1.6 16V	182 A4.000 Euro 2	Petrol	1581	4	59
10/95→10/01	Brava 1.6 16V	182 A6.000 Euro 2	Petrol	1581	4	59
01/99→12/02	Brava 1.6 16V	182 B6.000 Euro 3	Petrol	1596	4	28
10/95→10/01	Brava 1.8 GT 16V	182 A2.000 Euro 2	Petrol	1747	4	31
10/95→10/01	Brava 1.9 D	160 A7.000	Diesel	1929	4	42
01/01→12/02	Brava 1.9 JTD	182 B4.000 Euro 2	Diesel	1910	4	33
09/00→10/01	Brava 1.9 JTD	182 B9.000	Diesel	1910	4	34



CCM

x



9

12/98→10/01	Brava 1.9 JTD 105	182 B4.000 Euro 2	Diesel	1910	4	33
03/96→10/01	Brava 1.9 TD 100 S	182 A7.000	Diesel	1910	4	32
03/96→10/01	Brava 1.9 TD 75 S	182 A8.000	Diesel	1910	4	32
09/98→08/00	Brava 2.0	182 B7.000 Euro 2	Petrol	1998	5	30
12/98→10/00	Bravo I 1.2 16V 80	182 B2.000 (Fire)	Petrol	1242	4	12
12/98→10/01	Bravo I 1.2 16V 80	182 B2.000 (Fire)	Petrol	1242	4	12
10/00→10/01	Bravo I 1.2 16V 80	188 A5.000 Euro 3 (Fire)	Petrol	1242	4	12
10/95→10/01	Bravo I 1.4	182 A3.000	Petrol	1371	4	30
10/95→10/01	Bravo I 1.4	182 A5.000	Petrol	1371	4	30
09/00→02/02	Bravo I 1.6	182 B6.000 Euro 3	Petrol	1596	4	28
03/96→10/01	Bravo I 1.6 16V	182 A4.000 Euro 2	Petrol	1581	4	59
10/95→10/01	Bravo I 1.6 16V	182 A6.000 Euro 2	Petrol	1581	4	59
10/95→10/01	Bravo I 1.8 GT	182 A2.000 Euro 2	Petrol	1747	4	31
10/95→10/01	Bravo I 1.9 D	160 A7.000	Diesel	1929	4	42
09/00→10/01	Bravo I 1.9 JTD	182 B9.000	Diesel	1910	4	34
12/98→10/01	Bravo I 1.9 JTD 105	182 B4.000 Euro 2	Diesel	1910	4	33
03/96→10/01	Bravo I 1.9 TD 100 S	182 A7.000	Diesel	1910	4	32
03/96→10/01	Bravo I 1.9 TD 75 S	182 A8.000	Diesel	1910	4	32
10/95→07/98	Bravo I 2.0 HGT 20V	182 A1.000 Euro 2	Petrol	1998	5	30
07/98→10/01	Bravo I 2.0 HGT 20V	182 B7.000 Euro 2	Petrol	1998	5	30
04/07→	Bravo II 1.4	192 B2.000	Petrol	1368	4	13
03/08→	Bravo II 1.4 16V	198 A7.000	Petrol	1368	4	15
11/09→	Bravo II 1.4 LPG	192 B2.000	Petrol	1368	4	13
09/07→	Bravo II 1.4 T-Jet	198 A1.000	Petrol	1368	4	15
09/07→	Bravo II 1.4 T-Jet	198 A4.000	Petrol	1368	4	15
03/08→	Bravo II 1.6 D Multijet	198 A2.000	Diesel	1598	4	23
04/07→	Bravo II 1.9 D Multijet	192 A8.000	Diesel	1910	4	36
04/07→	Bravo II 1.9 D Multijet	937A5.000	Diesel	1910	4	38
09/08→	Bravo II 2.0 D Multijet	198 A5.000	Diesel	1956	4	46
09/08→	Bravo II 2.0 D Multijet	844 A2.000	Diesel	1956	4	46
06/74→10/89	Campagnola 2.4 D	Sofim-8144.61.200	Diesel	2445	4	66
12/91→01/96	Cinquecento 0.7	170 A.000	Petrol	704	2	24
07/94→01/98	Cinquecento 0.7 i	170 A.046	Petrol	704	2	24
07/91→12/93	Cinquecento 0.9	170 A1.000	Petrol	903	4	2
07/91→12/93	Cinquecento 0.9 i.e.	170 A1.046	Petrol	903	4	2
07/91→07/99	Cinquecento 0.9 i.e. S	1170 A1.000	Petrol	899	4	1
07/91→07/99	Cinquecento 0.9 i.e. S	1170 A1.046	Petrol	899	4	2
10/94→01/98	Cinquecento 1.1 Sporting	176 B2.000 Euro 2 (Fire)	Petrol	1108	4	11
03/96→08/00	Coupe 1.8 16V	183 A1.000 Euro 2	Petrol	1747	4	31
11/93→08/96	Coupe 2.0 16V	836 A3.000	Petrol	1995	4	52
11/93→08/96	Coupe 2.0 16V Turbo	175 A1.000	Petrol	1995	4	52
08/96→04/98	Coupe 2.0 20V	182 A1.000 Euro 2	Petrol	1998	5	30
04/98→08/00	Coupe 2.0 20V	182 B3.000 Euro 2	Petrol	1998	5	30
08/96→08/00	Coupe 2.0 20V Turbo	175 A3.000	Petrol	1998	5	29
06/05→	Croma 1.9 D Multijet	939 A1.000	Diesel	1910	4	34
06/05→	Croma 1.9 D Multijet	939A2.000	Diesel	1910	4	38
06/05→	Croma 2.4 D Multijet	939A3.000	Diesel	2387	5	38
01/92→	Croma 2.5TD Eco	8140.97Y (Sofim)	Diesel	2499	4	65
12/85→12/90	Croma 1600	154 A.048	Petrol	1585	4	51
05/89→10/92	Croma 1900 Turbo D i.d.	154 C6.000	Diesel	1929	4	43
08/92→08/96	Croma 2000 16V	154 E1.000	Petrol	1995	4	52
12/85→02/89	Croma 2000 CHT	154 A1.000	Petrol	1995	4	51
10/87→08/96	Croma 2000 i.e.	154 C3.046	Petrol	1995	4	51
03/87→09/92	Croma 2000 i.e.	834 B.000	Petrol	1995	4	51
03/86→09/90	Croma 2000 i.e.	834 B.048	Petrol	1995	4	51
10/87→08/96	Croma 2000 i.e.	834 B.146	Petrol	1995	4	51
12/85→06/90	Croma 2000 i.e. Turbo	154 A2.000	Petrol	1995	4	51
06/87→08/96	Croma 2000 i.e. Turbo	154 C4.046	Petrol	1995	4	51
06/87→08/96	Croma 2000 i.e. Turbo	834 C.146	Petrol	1995	4	52
11/86→11/88	Croma 2000 i.e. Turbo	834 C.146	Petrol	1995	4	52

MODEL INDEX

Modelverzeichnis • Index de modele • Índice de Modelo
Indeks modelu • Модель автомобиля • دليل الموديل



CCM

x



9

12/85→12/89	Croma 2500 D	8144.67	Diesel	2500	4	67
12/85→08/89	Croma 2500 TD	8144.91	Diesel	2445	4	64
05/89→08/96	Croma 2500 TD	8144.97 (Sofim)	Diesel	2499	4	64
05/89→08/96	Croma 2500 TD	8144.97 Y (Sofim)	Diesel	2500	4	64
05/89→08/96	Croma 2500 TD	8144.97.2400	Diesel	2499	4	64
12/91→08/96	Croma 2500 TDE	8144.97 S (Sofim)	Diesel	2500	4	64
06/93→08/96	Croma 2500 V6	834 G.000	Petrol	2492	V6	61
03/01→	Doblo 1.2	223 A5.000 Euro 3 (Fire)	Petrol	1242	4	12
05/05→	Doblo 1.3 JTD	199 A2.000	Diesel	1248	4	6
12/04→05/05	Doblo 1.3 JTD 16V	188 A9.000	Diesel	1248	4	6
10/05→	Doblo 1.4	350 A1.000	Petrol	1368	4	14
09/02→	Doblo 1.6	182 B6.000 Euro 3	Petrol	1596	4	28
10/01→	Doblo 1.6 16V	182 B6.000 Euro 3	Petrol	1596	4	28
09/02→	Doblo 1.6 Natural Power	182 B6.000 Euro 3	Petrol	1596	4	28
03/01→	Doblo 1.9 D	223 A6.000	Diesel	1910	4	35
10/05→	Doblo 1.9 D Multijet	186A9.000	Diesel	1910	4	36
10/01→	Doblo 1.9 JTD	182 B9.000	Diesel	1910	4	34
07/03→	Doblo 1.9 JTD	223 A7.000	Diesel	1910	4	36
02/10→	Doblo Box Body / Estate 1.3 D Multijet	199 A3.000	Diesel	1248	4	7
10/11→	Doblo Box Body / Estate 1.4	198 A4.000	Petrol	1368	4	15
02/10→	Doblo Box Body / Estate 1.4	843 A1.000 Euro 4 (Fire)	Petrol	1368	4	13
06/10→	Doblo Box Body / Estate 1.4 Natural Power	198 A4.000	Petrol	1368	4	15
02/10→	Doblo Box Body / Estate 2.0 D Multijet	263 A1.000 Euro 5	Diesel	1956	4	46
03/01→	Doblo Cargo 1.2	223 A5.000 Euro 3 (Fire)	Petrol	1242	4	12
10/05→01/10	Doblo Cargo 1.3 D Multijet	199 A2.000	Diesel	1248	4	6
05/04→12/06	Doblo Cargo 1.3 JTD 16V	188 A8.000	Diesel	1248	4	6
05/04→12/06	Doblo Cargo 1.3 JTD 16V	188 A9.000	Diesel	1248	4	6
10/05→	Doblo Cargo 1.4	350 A1.000	Petrol	1368	4	14
10/01→	Doblo Cargo 1.6 16V	182 B6.000 Euro 3	Petrol	1596	4	28
09/02→	Doblo Cargo 1.6 Natural Power	182 B6.000 Euro 3	Petrol	1596	4	28
03/01→	Doblo Cargo 1.9 D	223 A6.000	Diesel	1910	4	35
10/01→	Doblo Cargo 1.9 JTD	182 B9.000	Diesel	1910	4	34
07/03→	Doblo Cargo 1.9 JTD	223 A7.000	Diesel	1910	4	36
12/06→	Doblo Cargo 1.9 JTD Multijet	186A9.000	Diesel	1910	4	36
02/10→	Doblo MPV 1.3 D Multijet	199 A3.000	Diesel	1248	4	7
10/11→	Doblo MPV 1.4	198 A4.000	Petrol	1368	4	15
02/10→	Doblo MPV 1.4	843 A1.000 Euro 4 (Fire)	Petrol	1368	4	13
02/10→	Doblo MPV 1.4 Natural Power	198 A4.000	Petrol	1368	4	15
02/10→	Doblo MPV 2.0 D Multijet	263 A1.000 Euro 5	Diesel	1956	4	46
02/10→	Doblo Platform/Chassis 1.3 D Multijet	199 A3.000	Diesel	1248	4	7
04/10→	Doblo Platform/Chassis 1.4	843 A1.000 Euro 4 (Fire)	Petrol	1368	4	13
02/10→	Doblo Platform/Chassis 2.0 D Multijet	263 A1.000 Euro 5	Diesel	1956	4	46
01/89→	Ducato 2.5D	8140.07	Diesel	2499	4	63
01/89→12/94	Ducato 2.5TD	8140.21.201-203 (Sofim)	Diesel	2445	4	64
01/89→12/94	Ducato 2.5TD 4x4	8140.21.201-203 (Sofim)	Diesel	2445	4	64
01/88→08/90	Ducato Box 1.9 D	149 B1.000	Diesel	1929	4	42
07/90→03/94	Ducato Box 1.9 D	149 B1.000	Diesel	1929	4	42
03/94→04/02	Ducato Box 1.9 D	230 A2.000	Diesel	1929	4	42
04/98→04/02	Ducato Box 1.9 D	DJY (XUD9A)	Diesel	1905	4	48
03/94→04/02	Ducato Box 1.9 TD	230 A3.000	Diesel	1929	4	44
03/89→03/94	Ducato Box 1.9 TD	280 A1.000	Diesel	1929	4	44
03/89→08/90	Ducato Box 1.9 TD	280 A1.000	Diesel	1929	4	44
04/98→04/02	Ducato Box 1.9 TD	DHX (XUD9TE)	Diesel	1905	4	47
08/94→04/02	Ducato Box 1.9 TD CAT	230 A4.000	Diesel	1929	4	44
07/85→08/90	Ducato Box 2.0	170 B	Petrol	1971	4	60
03/89→08/90	Ducato Box 2.0	170 D	Petrol	1971	4	60
03/94→04/02	Ducato Box 2.0	RFW (XU10J2)	Petrol	1998	4	56
01/82→08/90	Ducato Box 2.0	XN 1T	Petrol	1971	4	60
06/90→05/94	Ducato Box 2.0 4x4	170 D	Petrol	1971	4	60
11/94→04/02	Ducato Box 2.0 4x4	RFW (XU10J2)	Petrol	1998	4	56



CCM

x



9

04/02→	Ducato Box 2.0 JTD	DW10 (RHV)	Diesel	1997	4	53
10/01→04/02	Ducato Box 2.0 JTD	DW10 (RHV)	Diesel	1997	4	53
04/02→	Ducato Box 2.3 JTD	F1AE 0481 C Euro 3	Diesel	2287	4	62
01/82→08/90	Ducato Box 2.4 D	8144.61	Diesel	2445	4	66
09/86→10/87	Ducato Box 2.4 D 4x4	8140.61	Diesel	2445	4	66
09/86→05/90	Ducato Box 2.5 D	8140.61	Diesel	2445	4	66
03/94→04/02	Ducato Box 2.5 D	8140.67	Diesel	2500	4	63
03/94→04/02	Ducato Box 2.5 D	8140.67.2700	Diesel	2499	4	63
01/82→08/90	Ducato Box 2.5 D	8144.67	Diesel	2500	4	67
06/90→05/94	Ducato Box 2.5 D	8144.67	Diesel	2500	4	67
01/82→08/90	Ducato Box 2.5 D	8144.67.220	Diesel	2499	4	67
01/82→08/90	Ducato Box 2.5 D	CRD93L (U25-661)	Diesel	2500	4	68
09/86→05/90	Ducato Box 2.5 D 4x4	8140.61	Diesel	2445	4	66
09/86→05/90	Ducato Box 2.5 D 4x4	8144.61	Diesel	2445	4	66
03/89→08/90	Ducato Box 2.5 D 4x4	8144.67	Diesel	2500	4	67
07/90→03/94	Ducato Box 2.5 D 4x4	8144.67	Diesel	2500	4	67
07/90→03/94	Ducato Box 2.5 TD	8140.27 (Sofim)	Diesel	2500	4	64
07/90→03/94	Ducato Box 2.5 TD	8140.27.2100	Diesel	2500	4	64
06/94→08/98	Ducato Box 2.5 TD	8140.47	Diesel	2499	4	65
07/90→03/94	Ducato Box 2.5 TD 4x4	8140.27 (Sofim)	Diesel	2500	4	64
09/86→05/90	Ducato Box 2.5 TD 4x4	8140.27 (Sofim)	Diesel	2500	4	64
07/90→03/94	Ducato Box 2.5 TD 4x4	8140.27.2100	Diesel	2500	4	64
11/94→04/98	Ducato Box 2.5 TD 4x4	8140.47	Diesel	2499	4	65
03/94→04/02	Ducato Box 2.5 TDI	8140.47	Diesel	2499	4	65
03/94→04/02	Ducato Box 2.5 TDI	8140.47R (Sofim)	Diesel	2499	4	65
05/98→04/02	Ducato Box 2.5 TDI 4x4	8140.47	Diesel	2499	4	65
05/98→04/02	Ducato Box 2.8 D	8140.63 (Sofim)	Diesel	2798	4	71
08/98→04/02	Ducato Box 2.8 D 4x4	8140.63 (Sofim)	Diesel	2798	4	71
04/02→	Ducato Box 2.8 JTD	8140.43S Euro 3	Diesel	2800	4	70
11/00→04/02	Ducato Box 2.8 JTD	8140.43S Euro 3	Diesel	2800	4	70
07/02→	Ducato Box 2.8 JTD 4x4	8140.43S Euro 3	Diesel	2800	4	70
11/00→04/02	Ducato Box 2.8 JTD 4x4	8140.43S Euro 3	Diesel	2800	4	70
05/04→	Ducato Box 2.8 JTD Power	8140.43N Euro 3	Diesel	2798	4	70
05/98→09/01	Ducato Box 2.8 TD 4x4	8140.43	Diesel	2800	4	69
10/97→04/02	Ducato Box 2.8 TDI	8140.43	Diesel	2800	4	69
06/99→04/02	Ducato Box 2.8 TDI 4x4	8140.43	Diesel	2800	4	69
07/06→	Ducato Box 100 Multijet 2,2 D	4HV Euro 4	Diesel	2198	4	55
06/11→	Ducato Box 115 Multijet 2,0 D	250 A1.000 Euro 5	Diesel	1956	4	46
07/06→	Ducato Box 120 Multijet 2,3 D	F1AE0481D Euro 4	Diesel	2286	4	62
03/10→	Ducato Box 120 Multijet 2,3 D 4x4	F1AE0481D Euro 4	Diesel	2286	4	62
01/07→	Ducato Box 130 Multijet 2,3 D	F1AE0481N	Diesel	2287	4	62
08/06→	Ducato Box 130 Multijet 2,3 D	F1AE0481T	Diesel	2286	4	62
04/98→04/02	Ducato Bus 1.9 D	D9B (XUD9A/B/L/Y)	Diesel	1905	4	48
04/98→04/02	Ducato Bus 1.9 D	D9B (XUD9A)	Diesel	1905	4	48
04/98→04/02	Ducato Bus 1.9 D	DJY (XUD9A)	Diesel	1905	4	48
06/95→04/02	Ducato Bus 1.9 D Combinato	230 A2.000	Diesel	1929	4	42
04/98→04/02	Ducato Bus 1.9 TD	DHX (XUD9TE)	Diesel	1905	4	47
08/94→04/02	Ducato Bus 1.9 TD Combinato	230 A4.000	Diesel	1929	4	44
03/94→04/02	Ducato Bus 1.9 TD Panorama/Combinato	230 A3.000	Diesel	1929	4	44
11/94→11/01	Ducato Bus 2.0 4x4	RFW (XU10J2)	Petrol	1998	4	56
04/02→	Ducato Bus 2.0 JTD	DW10 (RHV)	Diesel	1997	4	53
10/01→04/02	Ducato Bus 2.0 JTD	DW10 (RHV)	Diesel	1997	4	53
03/94→04/02	Ducato Bus 2.0 Panorama/Combinato	RFW (XU10J2)	Petrol	1998	4	56
04/02→	Ducato Bus 2.3 JTD	F1AE 0481 C Euro 3	Diesel	2287	4	62
08/94→04/02	Ducato Bus 2.5 D Combinato	8140.67	Diesel	2500	4	63
08/94→04/02	Ducato Bus 2.5 D Combinato	8140.67.2700	Diesel	2499	4	63
06/94→08/98	Ducato Bus 2.5 TD	8140.47	Diesel	2499	4	65
11/94→04/98	Ducato Bus 2.5 TD 4x4	8140.47	Diesel	2499	4	65
04/97→04/02	Ducato Bus 2.5 TDI 4x4	8140.47	Diesel	2499	4	65
03/94→04/02	Ducato Bus 2.5 TDI Panorama/Combinato	8140.47	Diesel	2499	4	65

MODEL INDEX

Modelverzeichnis • Index de modele • Índice de Modelo
Indeks modelu • Модель автомобиля • دليل الموديل



CCM

x



9

07/94→04/02	Ducato Bus 2.5 TDI Panorama/Combinato	8140.47R (Sofim)	Diesel	2499	4	65
02/98→04/02	Ducato Bus 2.8 D	8140.63 (Sofim)	Diesel	2798	4	71
04/04→07/06	Ducato Bus 2.8 JTD	8140.43N Euro 3	Diesel	2798	4	70
04/02→	Ducato Bus 2.8 JTD	8140.43S Euro 3	Diesel	2800	4	70
11/00→04/02	Ducato Bus 2.8 JTD	8140.43S Euro 3	Diesel	2800	4	70
07/02→	Ducato Bus 2.8 JTD 4x4	8140.43S Euro 3	Diesel	2800	4	70
11/00→04/02	Ducato Bus 2.8 JTD 4x4	8140.43S Euro 3	Diesel	2800	4	70
10/97→04/02	Ducato Bus 2.8 TDI	8140.43	Diesel	2800	4	69
07/99→04/02	Ducato Bus 2.8 TDI 4x4	8140.43	Diesel	2800	4	69
07/06→	Ducato Bus 100 Multijet 2,2 D	4HV Euro 4	Diesel	2198	4	55
06/11→	Ducato Bus 115 Multijet 2,0 D	250 A1.000 Euro 5	Diesel	1956	4	46
07/06→	Ducato Bus 120 Multijet 2,3 D	F1AE0481D Euro 4	Diesel	2286	4	62
02/87→08/90	Ducato Panorama 1.9 D	149 B1.000	Diesel	1929	4	42
07/90→03/94	Ducato Panorama 1.9 D	149 B1.000	Diesel	1929	4	42
03/89→08/90	Ducato Panorama 1.9 TD	280 A1.000	Diesel	1929	4	44
07/90→03/94	Ducato Panorama 1.9 TD	280 A1.000	Diesel	1929	4	44
01/86→08/90	Ducato Panorama 2.0	170 B	Petrol	1971	4	60
07/90→03/94	Ducato Panorama 2.0	170 D	Petrol	1971	4	60
09/88→08/90	Ducato Panorama 2.0	170 D	Petrol	1971	4	60
07/82→05/85	Ducato Panorama 2.0	XN 1T	Petrol	1971	4	60
06/90→05/94	Ducato Panorama 2.0 4x4	170 D	Petrol	1971	4	60
07/82→12/85	Ducato Panorama 2.4 D	8144.61	Diesel	2445	4	66
01/86→08/90	Ducato Panorama 2.5 D	8144.67	Diesel	2500	4	67
07/90→03/94	Ducato Panorama 2.5 D	8144.67	Diesel	2500	4	67
01/86→08/90	Ducato Panorama 2.5 D	CRD93L (U25-661)	Diesel	2500	4	68
01/87→08/90	Ducato Panorama 2.5 D 4x4	8144.67	Diesel	2500	4	67
07/90→03/94	Ducato Panorama 2.5 D 4x4	8144.67	Diesel	2500	4	67
08/90→03/94	Ducato Panorama 2.5 TD	8140.27 (Sofim)	Diesel	2500	4	64
01/87→08/90	Ducato Panorama 2.5 TD	8144.21 (Sofim)	Diesel	2445	4	64
01/87→08/90	Ducato Panorama 2.5 TD	8144.21.220	Diesel	2445	4	64
01/91→03/94	Ducato Panorama 2.5 TD 4x4	8140.27 (Sofim)	Diesel	2500	4	64
01/86→08/90	Ducato Panorama 2.5 TD 4x4	8144.21 (Sofim)	Diesel	2445	4	64
01/88→08/90	Ducato Platform/Chassis 1.9 D	149 B1.000	Diesel	1929	4	42
03/94→04/02	Ducato Platform/Chassis 1.9 D	230 A2.000	Diesel	1929	4	42
04/98→04/02	Ducato Platform/Chassis 1.9 D	DJY (XUD9A)	Diesel	1905	4	48
03/94→04/02	Ducato Platform/Chassis 1.9 TD	230 A3.000	Diesel	1929	4	44
03/89→03/94	Ducato Platform/Chassis 1.9 TD	280 A1.000	Diesel	1929	4	44
03/89→08/90	Ducato Platform/Chassis 1.9 TD	280 A1.000	Diesel	1929	4	44
04/98→04/02	Ducato Platform/Chassis 1.9 TD	DHX (XUD9TE)	Diesel	1905	4	47
08/94→04/02	Ducato Platform/Chassis 1.9 TD CAT	230 A4.000	Diesel	1929	4	44
07/85→08/90	Ducato Platform/Chassis 2.0	170 B	Petrol	1971	4	60
07/90→03/94	Ducato Platform/Chassis 2.0	170 D	Petrol	1971	4	60
08/88→08/90	Ducato Platform/Chassis 2.0	170 D	Petrol	1971	4	60
06/98→04/02	Ducato Platform/Chassis 2.0	RFW (XU10J2)	Petrol	1998	4	56
06/90→05/94	Ducato Platform/Chassis 2.0 4x4	170 D	Petrol	1971	4	60
04/02→07/06	Ducato Platform/Chassis 2.0 JTD	DW10 (RHV)	Diesel	1997	4	53
07/01→04/02	Ducato Platform/Chassis 2.0 JTD	DW10 (RHV)	Diesel	1997	4	53
04/02→07/06	Ducato Platform/Chassis 2.3 JTD	F1AE 0481 C Euro 3	Diesel	2287	4	62
03/94→04/02	Ducato Platform/Chassis 2.5 D	8140.67	Diesel	2500	4	63
03/94→04/02	Ducato Platform/Chassis 2.5 D	8140.67.2700	Diesel	2499	4	63
07/82→08/90	Ducato Platform/Chassis 2.5 D	8144.67	Diesel	2500	4	67
07/90→03/94	Ducato Platform/Chassis 2.5 D	8144.67	Diesel	2500	4	67
07/82→08/90	Ducato Platform/Chassis 2.5 D	CRD93L (U25-661)	Diesel	2500	4	68
03/94→04/02	Ducato Platform/Chassis 2.5 D 4x4	8140.67	Diesel	2500	4	63
03/94→04/02	Ducato Platform/Chassis 2.5 D 4x4	8140.67.2700	Diesel	2499	4	63
03/89→08/90	Ducato Platform/Chassis 2.5 D 4x4	8144.67	Diesel	2500	4	67
07/90→03/94	Ducato Platform/Chassis 2.5 D 4x4	8144.67	Diesel	2500	4	67
07/90→03/94	Ducato Platform/Chassis 2.5 TD	8140.27 (Sofim)	Diesel	2500	4	64
06/94→04/98	Ducato Platform/Chassis 2.5 TD	8140.47	Diesel	2499	4	65
06/94→08/98	Ducato Platform/Chassis 2.5 TD	8140.47	Diesel	2499	4	65



CCM

x



9

01/86→08/90	Ducato Platform/Chassis 2.5 TD	8144.21 (Sofim)	Diesel	2445	4	64
07/90→03/94	Ducato Platform/Chassis 2.5 TD 4x4	8140.27 (Sofim)	Diesel	2500	4	64
11/94→04/98	Ducato Platform/Chassis 2.5 TD 4x4	8140.47	Diesel	2499	4	65
03/94→04/02	Ducato Platform/Chassis 2.5 TDI	8140.47	Diesel	2499	4	65
03/94→04/02	Ducato Platform/Chassis 2.5 TDI	8140.47R (Sofim)	Diesel	2499	4	65
06/98→04/02	Ducato Platform/Chassis 2.5 TDI 4x4	8140.47	Diesel	2499	4	65
02/98→04/02	Ducato Platform/Chassis 2.8 D	8140.63 (Sofim)	Diesel	2798	4	71
05/98→09/01	Ducato Platform/Chassis 2.8 iDTD 4x4	8140.43	Diesel	2800	4	69
03/01→04/02	Ducato Platform/Chassis 2.8 JTD	8140.43S Euro 3	Diesel	2800	4	70
04/02→07/06	Ducato Platform/Chassis 2.8 JTD	8140.43S Euro 3	Diesel	2800	4	70
11/00→04/02	Ducato Platform/Chassis 2.8 JTD	8140.43S Euro 3	Diesel	2800	4	70
10/01→04/02	Ducato Platform/Chassis 2.8 JTD 4x4	8140.43S Euro 3	Diesel	2800	4	70
10/02→07/06	Ducato Platform/Chassis 2.8 JTD 4x4	8140.43S Euro 3	Diesel	2800	4	70
05/04→07/06	Ducato Platform/Chassis 2.8 JTD Power	8140.43N Euro 3	Diesel	2798	4	70
05/98→11/01	Ducato Platform/Chassis 2.8 TD 4x4	8140.63 (Sofim)	Diesel	2798	4	71
12/98→04/02	Ducato Platform/Chassis 2.8 TDI	8140.43	Diesel	2800	4	69
07/06→	Ducato Platform/Chassis 100 Multijet 2,2 D	4HV Euro 4	Diesel	2198	4	55
06/11→	Ducato Platform/Chassis 115 Multijet 2,0 D	250 A1.000 Euro 5	Diesel	1956	4	46
03/10→	Ducato Platform/Chassis 120 Multijet 2,3 D	F1AE0481D Euro 4	Diesel	2286	4	62
07/06→	Ducato Platform/Chassis 120 Multijet 2,3 D	F1AE0481D Euro 4	Diesel	2286	4	62
01/07→	Ducato Platform/Chassis 130 Multijet 2,3 D	F1AE0481N	Diesel	2287	4	62
01/87→12/91	Duna 1.7 DS	149 B3.000	Diesel	1697	4	40
01/87→12/91	Duna Weekend 1.7 DS	149 B3.000	Diesel	1697	4	40
04/86→10/92	Elba 1.3 D	127 A5.000	Diesel	1301	4	20
04/89→12/96	Elba 1.7 D	146 B2.000	Diesel	1697	4	40
01/80→12/87	Fiorino 1.0	127 A.000	Petrol	903	4	1
03/82→12/87	Fiorino 1.3 D	127 A5.000	Diesel	1301	4	20
12/87→12/90	Fiorino 1.7 D	149 B3.000	Diesel	1697	4	40
10/77→12/84	Fiorino 900	100 GL.000	Petrol	903	4	1
01/80→12/87	Fiorino 1050	127 A.000	Petrol	903	4	1
11/92→10/96	Fiorino Box 1.4	146 C5.000	Petrol	1372	4	27
01/88→10/99	Fiorino Box 1.7 D	146 B2.000	Diesel	1697	4	40
11/96→05/00	Fiorino Box 1.7 TD	146 D7.000	Diesel	1697	4	41
05/88→10/96	Fiorino Box 60 1.7 D	146 B2.000	Diesel	1697	4	40
05/88→05/00	Fiorino Box 60 1.7 D	149 B3.000	Diesel	1697	4	40
01/97→05/01	Fiorino Box 65 1.7 TD	146 D7.000	Diesel	1697	4	41
05/94→05/01	Fiorino Box 70 i.e. 1.4	146 C5.000	Petrol	1372	4	27
05/94→05/01	Fiorino Box 70 i.e. 1.4	146 D5.000	Petrol	1372	4	27
02/08→	Fiorino Box Body / Estate 1.3 D Multijet	199 A2.000	Diesel	1248	4	6
02/08→	Fiorino Box Body / Estate 1.3 D Multijet	199 A9.000 Euro 5	Diesel	1248	4	8
07/09→	Fiorino Box Body / Estate 1.3 D Multijet	199 B1.000 Euro 5	Diesel	1248	4	8
10/09→	Fiorino Box Body / Estate 1.4 Natural Power	350 A1.000	Petrol	1368	4	14
05/84→12/88	Fiorino Pick Up 1.3 D	127 A5.000	Diesel	1301	4	20
05/94→05/01	Fiorino Pick Up 1.4	146 D5.000	Petrol	1372	4	27
10/93→10/99	Fiorino Pick Up 1.7 D	146 B2.000	Diesel	1697	4	40
05/88→10/99	Fiorino Pick Up 1.7 D	149 B3.000	Diesel	1697	4	40
01/97→05/01	Fiorino Pick Up 1.7 TD	146 D7.000	Diesel	1697	4	41
08/11→	Freemont 2.0 JTD	939 B5.000	Diesel	1956	4	46
08/11→	Freemont 2.0 JTD	940 A5.000 Euro 5	Diesel	1956	4	46
08/11→	Freemont 2.0 JTD 4x4	939 B5.000	Diesel	1956	4	46
01/04→	Idea 1.2 16V	188 A5.000 Euro 3 (Fire)	Petrol	1242	4	12
10/05→	Idea 1.3 D Multijet	199 A3.000	Diesel	1248	4	7
05/08→	Idea 1.3 D Multijet	199 B1.000 Euro 5	Diesel	1248	4	8
01/04→	Idea 1.3 JTD	188 A9.000	Diesel	1248	4	6
12/03→	Idea 1.4	192 B2.000	Petrol	1368	4	13
10/05→	Idea 1.4	350 A1.000	Petrol	1368	4	14
01/04→	Idea 1.4 16V	843 A1.000 Euro 4 (Fire)	Petrol	1368	4	13
03/09→	Idea 1.4 LPG	350 A1.000	Petrol	1368	4	14
01/04→	Idea 1.9 JTD	188 B2.000	Diesel	1910	4	36
06/07→	Linea 1.3 D Multijet	199 A3.000	Diesel	1248	4	7

MODEL INDEX

Modelverzeichnis • Index de modele • Índice de Modelo
Indeks modelu • Модель автомобиля • دليل الموديل



CCM

x



9

06/07→	Linea 1.4	350 A1.000	Petrol	1368	4	14
09/07→	Linea 1.4 T-Jet	198 A4.000	Petrol	1368	4	15
10/98→05/02	Marea 1.2 16V	182 B2.000 (Fire)	Petrol	1242	4	12
09/96→05/02	Marea 1.4 80 12V	182 A3.000	Petrol	1371	4	30
09/00→08/02	Marea 1.6	182 B6.000 Euro 3	Petrol	1596	4	28
03/99→08/00	Marea 1.6	185 A3.000 Euro 2	Petrol	1581	4	59
09/96→05/02	Marea 1.6 100 16V	182 A4.000 Euro 2	Petrol	1581	4	59
04/99→05/02	Marea 1.6 100 16V Bipower	185 A3.000 Euro 2	Petrol	1581	4	59
04/97→02/99	Marea 1.6 16V	185 A3.000 Euro 2	Petrol	1581	4	59
09/96→05/02	Marea 1.8 115 16V	182 A2.000 Euro 2	Petrol	1747	4	31
04/99→01/01	Marea 1.9 JTD 105	182 B4.000 Euro 2	Diesel	1910	4	33
01/01→05/02	Marea 1.9 JTD 110	186 A6.000 Euro 3	Diesel	1910	4	35
09/96→05/02	Marea 1.9 TD 100	182 A7.000	Diesel	1910	4	32
09/96→05/02	Marea 1.9 TD 75	182 A8.000	Diesel	1910	4	32
09/96→04/99	Marea 2.0 150 20V	182 A1.000 Euro 2	Petrol	1998	5	30
01/01→05/02	Marea 2.0 150 20V	185 A8.000 Euro 3	Petrol	1998	5	31
04/99→01/01	Marea 2.0 155 20V	182 B7.000 Euro 2	Petrol	1998	5	30
04/99→05/02	Marea 2.4 JTD 130	185 A6.000 Euro 2	Diesel	2387	5	33
04/99→05/02	Marea 2.4 JTD 130	839 A5.000 Euro 2	Diesel	2387	5	33
09/96→04/99	Marea 2.4 TD 125	185 A2.000	Diesel	2387	5	32
10/98→05/02	Marea Weekend 1.2 16V	182 B2.000 (Fire)	Petrol	1242	4	12
09/96→05/02	Marea Weekend 1.4 80 12V	182 A3.000	Petrol	1371	4	30
09/00→08/02	Marea Weekend 1.6	182 B6.000 Euro 3	Petrol	1596	4	28
09/96→05/02	Marea Weekend 1.6 100 16V	182 A4.000 Euro 2	Petrol	1581	4	59
09/96→05/02	Marea Weekend 1.8 115 16V	182 A2.000 Euro 2	Petrol	1747	4	31
04/99→05/02	Marea Weekend 1.9 JTD 105	182 B4.000 Euro 2	Diesel	1910	4	33
01/01→05/02	Marea Weekend 1.9 JTD 110	186 A6.000 Euro 3	Diesel	1910	4	35
09/96→05/02	Marea Weekend 1.9 TD 100	182 A7.000	Diesel	1910	4	32
09/96→05/02	Marea Weekend 1.9 TD 100	182 B9.000	Diesel	1910	4	34
09/96→05/02	Marea Weekend 1.9 TD 75	182 A8.000	Diesel	1910	4	32
09/96→04/99	Marea Weekend 2.0 150 20V	182 A1.000 Euro 2	Petrol	1998	5	30
01/01→05/02	Marea Weekend 2.0 150 20V	185 A8.000 Euro 3	Petrol	1998	5	31
04/99→02/03	Marea Weekend 2.0 155 20V	182 B7.000 Euro 2	Petrol	1998	5	30
04/99→05/02	Marea Weekend 2.4 JTD 130	185 A6.000 Euro 2	Diesel	2387	5	33
04/99→05/02	Marea Weekend 2.4 JTD 130	839 A5.000 Euro 2	Diesel	2387	5	33
09/96→04/99	Marea Weekend 2.4 TD 125	185 A2.000	Diesel	2387	5	32
03/01→08/05	Multipla 1.6	182 B6.000 Euro 3	Petrol	1596	4	28
05/04→08/05	Multipla 1.6	182 B6.000 Euro 3	Petrol	1596	4	28
09/00→06/10	Multipla 1.6	182 B6.000 Euro 3	Petrol	1596	4	28
04/99→06/10	Multipla 1.6 100 16V	182 A4.000 Euro 2	Petrol	1581	4	59
04/02→06/10	Multipla 1.6 16V	182 B6.000 Euro 3	Petrol	1596	4	28
10/01→06/10	Multipla 1.6 16V Bipower	182 B6.000 Euro 3	Petrol	1596	4	28
04/02→06/10	Multipla 1.9 JTD	186A9.000	Diesel	1910	4	36
04/99→06/10	Multipla 1.9 JTD 105	182 B4.000 Euro 2	Diesel	1910	4	33
03/01→07/02	Multipla 1.9 JTD 110	186 A6.000 Euro 3	Diesel	1910	4	35
07/02→06/10	Multipla 1.9 JTD 115	186 A8.000	Diesel	1910	4	34
06/98→	Palio 1.2	176 A8.000 (Fire)	Petrol	1242	4	12
06/98→	Palio 1.2	178 B5.000 Euro 3 (Fire)	Petrol	1242	4	12
06/98→	Palio 1.2	178E2.000 (Fire)	Petrol	1242	4	12
06/99→10/00	Palio 1.2	178E2.000 (Fire)	Petrol	1242	4	12
07/97→08/02	Palio 1.2	188 A4.000 Euro 3 (Fire)	Petrol	1242	4	12
04/96→	Palio 1.4	178 B2.000	Petrol	1372	4	27
06/03→	Palio 1.4	834 A1.000	Petrol	1368	4	16
04/96→	Palio 1.4 CAT	178B2.016	Petrol	1372	4	27
04/96→	Palio 1.6 16V	178 B3.000 Euro 2	Petrol	1581	4	59
04/96→02/01	Palio Weekend 1.2	178 B5.000 Euro 3 (Fire)	Petrol	1242	4	12
06/99→10/02	Palio Weekend 1.2	178E2.000 (Fire)	Petrol	1242	4	12
02/01→	Palio Weekend 1.2	188 A4.000 Euro 3 (Fire)	Petrol	1242	4	12
09/01→	Palio Weekend 1.2	188 A5.000 Euro 3 (Fire)	Petrol	1242	4	12
06/04→	Palio Weekend 1.2	178 E9.011	Flexfuel	1242	4	12

CCM

x

01/04→12/05	Palio Weekend 1.2 Biopower	178 E9.011	Flexfuel	1242	4	12
07/97→08/02	Palio Weekend 1.2 Flex	188 A4.000 Euro 3 (Fire)	Petrol	1242	4	12
07/97→08/02	Palio Weekend 1.2 LPG	188 A4.000 Euro 3 (Fire)	Petrol	1242	4	12
07/97→08/01	Palio Weekend 1.4	178 B2.000	Petrol	1372	4	27
10/05→	Palio Weekend 1.4	199 A1.000	Petrol	1368	4	14
04/96→02/01	Palio Weekend 1.6 16V	178 B3.000 Euro 2	Petrol	1581	4	59
02/01→	Palio Weekend 1.6 16V	182 B6.000 Euro 3	Petrol	1596	4	28
04/96→03/01	Palio Weekend 1.7 TD	176 A3.000	Diesel	1697	4	41
03/01→	Palio Weekend 1.9 D	223 A6.000	Diesel	1910	4	35
09/01→	Palio Weekend 1.9 JTD	188 A2.000 Euro 3	Diesel	1910	4	35
10/80→04/86	Panda 0.9 Fire S All-wheel Drive	146 A.048	Petrol	903	4	1
09/03→	Panda 1.1	187 A1.000 Euro 3 (Fire)	Petrol	1108	4	11
02/12→	Panda 1.2	169 A4.000	Petrol	1242	4	12
03/10→	Panda 1.2	169 A4.000	Petrol	1242	4	12
09/03→	Panda 1.2	188 A4.000 Euro 3 (Fire)	Petrol	1242	4	12
11/09→	Panda 1.2 4x4	169 A4.000	Petrol	1242	4	12
10/04→	Panda 1.2 4x4	188 A4.000 Euro 3 (Fire)	Petrol	1242	4	12
01/07→	Panda 1.2 Bi-Power / Natural Power	188 A4.000 Euro 3 (Fire)	Petrol	1242	4	12
06/12→	Panda 1.2 LPG	169 A4.000	Petrol	1242	4	12
11/10→	Panda 1.2 LPG	169 A4.000	Petrol	1242	4	12
04/09→	Panda 1.2 LPG	188 A4.000 Euro 3 (Fire)	Petrol	1242	4	12
06/06→	Panda 1.3 D Multijet	169 A1.000	Diesel	1248	4	6
09/03→	Panda 1.3 D Multijet	188 A8.000	Diesel	1248	4	6
09/03→	Panda 1.3 D Multijet	188 A9.000	Diesel	1248	4	6
02/12→	Panda 1.3 D Multijet	199 A9.000 Euro 5	Diesel	1248	4	8
09/10→	Panda 1.3 D Multijet 4x4	169 A1.000	Diesel	1248	4	6
10/04→	Panda 1.3 D Multijet 4x4	188 A8.000	Diesel	1248	4	6
10/04→	Panda 1.3 D Multijet 4x4	188 A9.000	Diesel	1248	4	6
06/12→	Panda 1.3 D Multijet 4x4	199 A9.000 Euro 5	Diesel	1248	4	8
10/06→	Panda 1.4	169 A3.000	Petrol	1368	4	13
09/10→	Panda 1.4 Bi-Power / Natural Power	350 A1.000	Petrol	1368	4	14
01/10→	Panda 1.4 Natural Power	350 A1.000	Petrol	1368	4	14
01/82→07/04	Panda 650	141 A.000	Petrol	652	2	21
01/86→01/95	Panda 750	141 B.000	Petrol	770	4	1
01/86→01/95	Panda 750	156 A4.000 (Fire)	Petrol	770	4	3
01/95→10/03	Panda 750	156 A4.048 (Fire)	Petrol	770	4	3
10/80→06/94	Panda 900	100 GL3.000	Petrol	903	4	1
10/80→06/94	Panda 900	146 A.000	Petrol	903	4	1
04/92→12/96	Panda 900	1170 A1.046	Petrol	899	4	2
09/82→08/83	Panda 950	A 112 B1.054	Petrol	965	4	4
09/83→12/86	Panda 950 4x4	A 112 B1.054	Petrol	965	4	4
01/86→04/92	Panda 1000	156 A2.100 (Fire)	Petrol	999	4	10
01/85→12/92	Panda 1000	156 A3.000	Petrol	999	4	10
01/86→07/89	Panda 1000 4x4	156 A2.100 (Fire)	Petrol	999	4	10
05/86→12/94	Panda 1000 4x4	156 A2.246 (Fire)	Petrol	999	4	10
01/86→12/92	Panda 1000 4x4	156 A3.000	Petrol	999	4	10
10/87→08/98	Panda 1000 i.e. CAT	156 A2.246 (Fire)	Petrol	999	4	10
05/91→12/99	Panda 1100	156 C.046 (Fire)	Petrol	1108	4	10
02/95→09/03	Panda 1100	176 B2.000 Euro 2 (Fire)	Petrol	1108	4	11
02/95→09/03	Panda 1100	187 A1.000 Euro 3 (Fire)	Petrol	1108	4	11
02/95→07/04	Panda 1100 4x4	176 B2.000 Euro 2 (Fire)	Petrol	1108	4	11
10/91→07/04	Panda 1100 Trekking 4x4	156 C.046 (Fire)	Petrol	1108	4	10
04/86→12/92	Panda 1300 D	156 A5.000	Diesel	1301	4	20
05/91→03/95	Panda Van 1.1	156 C.046 (Fire)	Petrol	1108	4	10
09/00→02/04	Panda Van 1.1	187 A1.000 Euro 3 (Fire)	Petrol	1108	4	11
09/04→	Panda Van 1.1	187 A1.000 Euro 3 (Fire)	Petrol	1108	4	11
09/10→	Panda Van 1.2	169 A4.000	Petrol	1242	4	12
09/04→	Panda Van 1.2	188 A4.000 Euro 3 (Fire)	Petrol	1242	4	12
09/10→	Panda Van 1.2 4x4	169 A4.000	Petrol	1242	4	12
09/04→	Panda Van 1.2 4x4	188 A4.000 Euro 3 (Fire)	Petrol	1242	4	12

MODEL INDEX

Modelverzeichnis • Index de modele • Índice de Modelo
Indeks modelu • Модель автомобиля • دليل الموديل



CCM

x



9

09/10→	Panda Van 1.2 LPG	169 A4.000	Petrol	1242	4	12
01/06→	Panda Van 1.3 JTD	169 A1.000	Diesel	1248	4	6
03/04→	Panda Van 1.3 JTD	188 A8.000	Diesel	1248	4	6
03/04→	Panda Van 1.3 JTD	188 A9.000	Diesel	1248	4	6
01/06→	Panda Van 1.3 Multijet 4x4	169 A1.000	Diesel	1248	4	6
10/09→	Panda Van 1.4 Natural Power	350 A1.000	Petrol	1368	4	14
01/86→07/92	Panda Van 750	141 B.000	Petrol	770	4	1
01/86→02/92	Panda Van 1000	156 A2.100 (Fire)	Petrol	999	4	10
08/92→02/04	Panda Van 1000 i.e	156 A2.246 (Fire)	Petrol	999	4	10
01/86→12/90	Penny Van 1.7 D	149 B3.000	Diesel	1697	4	40
03/85→12/96	Premio 1.6	159 A3.000	Petrol	1581	4	58
09/10→	Punto / Grande Punto 1.2	169 A4.000	Petrol	1242	4	12
10/05→12/11	Punto / Grande Punto 1.2	188 A4.000 Euro 3 (Fire)	Petrol	1242	4	12
10/05→	Punto / Grande Punto 1.2	199 A4.000	Petrol	1242	4	12
07/08→	Punto / Grande Punto 1.2 LPG	199 A4.000	Petrol	1242	4	12
06/09→	Punto / Grande Punto 1.3 D Multijet	199 A2.000	Diesel	1248	4	6
10/05→	Punto / Grande Punto 1.3 D Multijet	199 A2.000	Diesel	1248	4	6
10/05→	Punto / Grande Punto 1.3 D Multijet	199 A3.000	Diesel	1248	4	7
07/08→	Punto / Grande Punto 1.3 D Multijet	199 B2.000 Euro 5	Diesel	1248	4	8
04/10→	Punto / Grande Punto 1.3 D Multijet	199 B4.000 Euro 5	Diesel	1248	4	8
06/06→	Punto / Grande Punto 1.4	199 A7.000	Petrol	1368	4	14
10/05→	Punto / Grande Punto 1.4	350 A1.000	Petrol	1368	4	14
09/07→07/12	Punto / Grande Punto 1.4 16V	198 A1.000	Petrol	1368	4	15
10/05→	Punto / Grande Punto 1.4 16V	199 A6.000	Petrol	1368	4	13
12/07→	Punto / Grande Punto 1.4 Abarth	199 A8.000	Petrol	1368	4	15
12/07→	Punto / Grande Punto 1.4 Abarth	955 A8.000 Euro 5	Petrol	1368	4	15
12/08→	Punto / Grande Punto 1.4 LPG	350 A1.000	Petrol	1368	4	14
07/08→	Punto / Grande Punto 1.4 Natural Power	350 A1.000	Petrol	1368	4	14
09/07→	Punto / Grande Punto 1.4 T-Jet	198 A4.000	Petrol	1368	4	15
07/08→	Punto / Grande Punto 1.6 D Multijet	955 A3.000 Euro 5	Diesel	1598	4	23
10/05→	Punto / Grande Punto 1.9 D Multijet	199 A5.000	Diesel	1910	4	36
10/05→	Punto / Grande Punto 1.9 D Multijet	939 A1.000	Diesel	1910	4	34
03/12→	Punto 1.2	169 A4.000	Petrol	1242	4	12
04/97→09/99	Punto 1.2 16V	176 B9.000 (Fire)	Petrol	1242	4	12
09/99→	Punto 1.2 16V 80	188 A5.000 Euro 3 (Fire)	Petrol	1242	4	12
09/99→	Punto 1.2 60	188 A4.000 Euro 3 (Fire)	Petrol	1242	4	12
08/07→	Punto 1.2 Bifuel	188 A4.000 Euro 3 (Fire)	Petrol	1242	4	12
09/03→	Punto 1.2 Natural Power	188 A4.000 Euro 3 (Fire)	Petrol	1242	4	12
03/12→	Punto 1.3 D Multijet	199 A2.000	Diesel	1248	4	6
03/12→	Punto 1.3 D Multijet	199 A9.000 Euro 5	Diesel	1248	4	8
03/12→	Punto 1.3 D Multijet	199 B1.000 Euro 5	Diesel	1248	4	8
03/12→	Punto 1.3 D Multijet	199 B4.000 Euro 5	Diesel	1248	4	8
06/03→	Punto 1.3 JTD 16V	188 A9.000	Diesel	1248	4	6
11/05→	Punto 1.4	199 A6.000	Petrol	1368	4	13
03/12→	Punto 1.4	199 A7.000	Petrol	1368	4	14
03/12→	Punto 1.4	350 A1.000	Petrol	1368	4	14
09/03→	Punto 1.4	843 A1.000 Euro 4 (Fire)	Petrol	1368	4	13
03/12→	Punto 1.4 Bifuel	350 A1.000	Petrol	1368	4	14
01/94→09/96	Punto 1.4 GT Turbo	176 A4.000	Petrol	1372	4	26
09/96→09/99	Punto 1.4 GT Turbo	176 B6.000	Petrol	1372	4	26
03/12→	Punto 1.4 Natural Power	350 A1.000	Petrol	1368	4	14
01/94→04/97	Punto 1.6	176 A9.000	Petrol	1581	4	58
04/94→09/97	Punto 1.7 D	176 B3.000	Diesel	1697	4	40
01/94→09/99	Punto 1.7 TD	176 A3.000	Diesel	1697	4	41
01/94→09/99	Punto 1.7 TD	176 A5.000	Diesel	1697	4	41
09/96→09/99	Punto 1.7 TD	176 B7.000	Diesel	1697	4	41
09/99→	Punto 1.8 130 HGT	183 A1.000 Euro 2	Petrol	1747	4	31
09/99→	Punto 1.8 130 HGT	188 A6.000 Euro 3	Petrol	1747	4	37
09/99→	Punto 1.9 DS 60	188 A3.000	Diesel	1910	4	35
10/01→	Punto 1.9 JTD	188 A7.000 Euro 3	Diesel	1910	4	35



CCM

x



06/03→	Punto 1.9 JTD	188 B2.000	Diesel	1910	4	36
09/99→	Punto 1.9 JTD 80	188 A2.000 Euro 3	Diesel	1910	4	35
09/93→09/99	Punto 55 1.1	176 A6.000 (Fire)	Petrol	1108	4	11
09/93→09/99	Punto 55 1.1	176 B2.000 Euro 2 (Fire)	Petrol	1108	4	11
01/94→09/99	Punto 60 1.2	176 A7.000 (Fire)	Petrol	1242	4	12
03/94→09/99	Punto 60 1.2	176 B1.000	Petrol	1242	4	12
03/94→09/99	Punto 60 1.2	176 B4.000 (Fire)	Petrol	1242	4	12
10/93→09/99	Punto 75 1.2	176 A8.000 (Fire)	Petrol	1242	4	12
04/94→06/00	Punto Convertible 60 1.2	176 A7.000 (Fire)	Petrol	1242	4	12
05/95→06/00	Punto Convertible 60 1.2	176 B1.000	Petrol	1242	4	12
05/95→06/00	Punto Convertible 60 1.2	176 B4.000 (Fire)	Petrol	1242	4	12
04/97→06/00	Punto Convertible 85 16V 1.2	176 B9.000 (Fire)	Petrol	1242	4	12
04/94→04/97	Punto Convertible 90 1.6	176 A9.000	Petrol	1581	4	58
10/09→02/12	Punto Evo 1.2	169 A4.000	Petrol	1242	4	12
10/09→02/12	Punto Evo 1.2	199 A4.000	Petrol	1242	4	12
10/09→02/12	Punto Evo 1.3 D Multijet	199 A2.000	Diesel	1248	4	6
10/09→02/12	Punto Evo 1.3 D Multijet	199 A3.000	Diesel	1248	4	7
10/09→02/12	Punto Evo 1.3 D Multijet	199 A9.000 Euro 5	Diesel	1248	4	8
10/09→02/12	Punto Evo 1.3 D Multijet	199 B1.000 Euro 5	Diesel	1248	4	8
07/08→02/12	Punto Evo 1.3 D Multijet	199 B2.000 Euro 5	Diesel	1248	4	8
10/09→02/12	Punto Evo 1.3 D Multijet	199 B4.000 Euro 5	Diesel	1248	4	8
07/09→02/12	Punto Evo 1.4	199 A7.000	Petrol	1368	4	14
10/09→02/12	Punto Evo 1.4	350 A1.000	Petrol	1368	4	14
07/08→02/12	Punto Evo 1.4 Abarth	199 A8.000	Petrol	1368	4	15
07/08→02/12	Punto Evo 1.4 Abarth	955 A8.000 Euro 5	Petrol	1368	4	15
10/09→02/12	Punto Evo 1.4 Abarth	955 A8.000 Euro 5	Petrol	1368	4	15
06/09→02/12	Punto Evo 1.4 LPG	350 A1.000	Petrol	1368	4	14
10/09→02/12	Punto Evo 1.4 Natural Power	350 A1.000	Petrol	1368	4	14
10/09→02/12	Punto Evo 1.6 D Multijet	955 A3.000 Euro 5	Diesel	1598	4	23
03/09→	Punto Evo Box 1.3 D Multijet	199 A2.000	Diesel	1248	4	6
03/09→	Punto Evo Box 1.3 D Multijet	199 A9.000 Euro 5	Diesel	1248	4	8
03/09→	Punto Evo Box 1.4	350 A1.000	Petrol	1368	4	14
03/09→	Punto Evo Box 1.4 LPG	350 A1.000	Petrol	1368	4	14
03/09→	Punto Evo Box 1.4 Natural Power	350 A1.000	Petrol	1368	4	14
04/96→02/00	Punto Van 1.1	176 B2.000 Euro 2 (Fire)	Petrol	1108	4	11
02/00→10/09	Punto Van 1.2 60	188 A4.000 Euro 3 (Fire)	Petrol	1242	4	12
02/05→10/09	Punto Van 1.3 D Multijet	188 A9.000	Diesel	1248	4	6
04/08→	Punto Van 1.3 D Multijet	199 A2.000	Diesel	1248	4	6
01/10→02/12	Punto Van 1.3 D Multijet	199 A3.000	Diesel	1248	4	7
04/08→	Punto Van 1.3 D Multijet	199 A9.000 Euro 5	Diesel	1248	4	8
03/09→	Punto Van 1.3 D Multijet	199 B1.000 Euro 5	Diesel	1248	4	8
03/12→	Punto Van 1.3 D Multijet	199 B4.000 Euro 5	Diesel	1248	4	8
06/03→10/05	Punto Van 1.3 JTD	188 A9.000	Diesel	1248	4	6
04/08→	Punto Van 1.4	350 A1.000	Petrol	1368	4	14
03/09→	Punto Van 1.4 LPG	350 A1.000	Petrol	1368	4	14
03/09→	Punto Van 1.4 Natural Power	350 A1.000	Petrol	1368	4	14
04/96→02/00	Punto Van 1.7 D	176 B3.000	Diesel	1697	4	40
04/96→02/00	Punto Van 1.7 TD	176 A5.000	Diesel	1697	4	41
09/96→09/99	Punto Van 1.7 TD	176 B7.000	Diesel	1697	4	41
02/00→10/09	Punto Van 1.9 D 60	188 A3.000	Diesel	1910	4	35
02/00→10/09	Punto Van 1.9 JTD	188 A7.000 Euro 3	Diesel	1910	4	35
09/08→	Qubo 1.3 D Multijet	199 A2.000	Diesel	1248	4	6
07/10→	Qubo 1.3 D Multijet	199 B1.000 Euro 5	Diesel	1248	4	8
10/09→	Qubo 1.4 Natural Power	350 A1.000	Petrol	1368	4	14
09/83→12/86	Regata 60 Diesel 1.7	138 B6.000	Diesel	1714	4	45
05/85→03/89	Regata 60 Diesel 1.7	149 B3.000	Diesel	1697	4	40
04/84→07/89	Regata 65 Diesel 1.9	149 A1.000	Diesel	1929	4	42
09/83→07/86	Regata 70 1.3	138 B2.000	Petrol	1302	4	57
09/83→07/89	Regata 70 1.3	149 A3.000	Petrol	1302	4	57
09/83→07/89	Regata 70 1.3	149 A7.000	Petrol	1302	4	57

MODEL INDEX

Modelverzeichnis • Index de modele • Índice de Modelo
Indeks modelu • Модель автомобиля • دليل الموديل



CCM

x



9

12/83→12/87	Regata 75 1.5	138 B3.048	Petrol	1498	4	57
05/86→07/89	Regata 80 Turbo Diesel 1.9	831 D1.000	Diesel	1929	4	42
10/83→06/90	Regata 85 1.6	149 A.000	Petrol	1585	4	50
09/83→04/85	Regata 85 Super 1.5	138 B3.000	Petrol	1498	4	57
01/87→07/89	Regata 90 i.e. 1.6	149 C2.000	Petrol	1595	4	50
10/83→12/90	Regata 100 Super 1.6	149 A2.000	Petrol	1585	4	51
10/83→12/90	Regata 100 Super 1.6	149 A4.000	Petrol	1585	4	50
10/83→07/89	Regata 100 Super 1.6	149 C3.000	Petrol	1595	4	50
01/84→12/89	Regata Weekend 60 Diesel 1.7	149 B3.000	Diesel	1697	4	40
04/84→07/89	Regata Weekend 65 Diesel 1.9	149 A1.000	Diesel	1929	4	42
01/84→07/89	Regata Weekend 70 1.3	138 B2.000	Petrol	1302	4	57
09/84→07/89	Regata Weekend 75 1.5	138 B3.048	Petrol	1498	4	57
05/86→07/89	Regata Weekend 80 Turbo Diesel 1.9	831 D1.000	Diesel	1929	4	42
01/84→04/89	Regata Weekend 85 1.5	138 B3.000	Petrol	1498	4	57
01/87→07/89	Regata Weekend 90 i.e. 1.6	149 C2.000	Petrol	1595	4	50
09/84→12/86	Regata Weekend 100 1.6	149 A4.000	Petrol	1585	4	50
01/87→12/90	Regata Weekend 100 i.e. 1.6	149 C3.000	Petrol	1595	4	50
10/79→09/83	Ritmo Bertone Convertible 1.3	138 A1.000	Petrol	1302	4	57
02/83→01/84	Ritmo Bertone Convertible 1.5	138 A2.000	Petrol	1498	4	57
10/85→12/87	Ritmo Bertone Convertible 50 1.3	138 B2.000	Petrol	1302	4	57
01/80→07/89	Ritmo Bertone Convertible 85 1.5	138 A4.000	Petrol	1498	4	57
03/83→12/86	Ritmo Bertone Convertible 85 1.5	138 B3.000	Petrol	1498	4	57
10/85→12/87	Ritmo Bertone Convertible 100 1.6	138 AR.000	Petrol	1585	4	51
10/85→12/87	Ritmo Bertone Convertible 100 1.6	138 AR.048	Petrol	1585	4	51
09/78→09/82	Ritmo I 60 1.0	127 A6.000	Petrol	1049	4	19
01/78→09/82	Ritmo I 65 1.3	138 A1.000	Petrol	1302	4	57
11/83→08/85	Ritmo I 70 1.3	149 A3.000	Petrol	1302	4	57
11/83→08/85	Ritmo I 70 1.3	149 A7.000	Petrol	1302	4	57
01/81→09/82	Ritmo I 75 1.3	138 A3.000	Petrol	1302	4	57
01/78→10/82	Ritmo I 75 1.5	138 A2.000	Petrol	1498	4	57
01/81→05/87	Ritmo I 85 1.5	138 A4.000	Petrol	1498	4	57
09/85→12/87	Ritmo I 90 i.e. 1.6	149 C2.000	Petrol	1595	4	50
05/81→12/82	Ritmo I 105 Sport 1.6	138 AR.000	Petrol	1585	4	51
10/82→12/87	Ritmo II 60 1.1	138 B.000	Petrol	1116	4	24
10/82→10/85	Ritmo II 60 Diesel 1.7	138 B6.000	Diesel	1714	4	45
05/85→12/87	Ritmo II 60 Diesel 1.7	138 C.000	Diesel	1677	4	40
05/85→12/87	Ritmo II 60 Diesel 1.7	149 B3.000	Diesel	1697	4	40
01/83→04/85	Ritmo II 70 1.3	138 B2.000	Petrol	1302	4	57
09/85→12/88	Ritmo II 75 1.5	138 A2.000	Petrol	1498	4	57
12/85→12/87	Ritmo II 80 Turbo Diesel 1.9	831 D1.000	Diesel	1929	4	42
01/83→12/87	Ritmo II 85 1.5	138 B3.000	Petrol	1498	4	57
12/85→12/87	Ritmo II 90 1.6 i.e.	138 AR.000	Petrol	1585	4	51
01/83→12/87	Ritmo II 100 1.6	149 A4.000	Petrol	1585	4	50
01/83→12/87	Ritmo II 105 1.6	138 AR.000	Petrol	1585	4	51
01/07→	Scudo 1.6 D Multijet	9HU	Diesel	1560	4	18
01/07→	Scudo 2.0 D Multijet	RHK	Diesel	1997	4	53
01/07→	Scudo 2.0 D Multijet	RHR	Diesel	1997	4	53
01/07→	Scudo 2.0 D Multijet 4x4	RHK	Diesel	1997	4	53
02/96→12/06	Scudo Box 1.6	220 A 2.000	Petrol	1581	4	58
01/07→	Scudo Box 1.6 D Multijet	9HU	Diesel	1560	4	18
02/96→12/06	Scudo Box 1.9 D	D9B (XUD9/A/B/L/Y)	Diesel	1905	4	48
04/98→12/06	Scudo Box 1.9 D	WJZ (DW8)	Diesel	1868	4	39
02/98→12/06	Scudo Box 1.9 TD	D8B	Diesel	1905	4	47
02/96→12/06	Scudo Box 1.9 TD	DHX (XUD9TE)	Diesel	1905	4	47
02/98→12/06	Scudo Box 1.9 TD	DHX (XUD9TE)	Diesel	1905	4	47
01/07→	Scudo Box 2.0 D Multijet	RHK	Diesel	1997	4	53
01/07→	Scudo Box 2.0 D Multijet	RHR	Diesel	1997	4	53
01/07→	Scudo Box 2.0 D Multijet 4x4	RHK	Diesel	1997	4	53
12/99→12/06	Scudo Box 2.0 JTD	DW10 (RHX)	Diesel	1998	4	53
12/02→12/06	Scudo Box 2.0 JTD	DW10 (RHZ)	Diesel	1997	4	53



CCM

x



9

05/99→12/06	Scudo Box 2.0 JTD 16V	DW10ATED4 (RHS)	Diesel	1997	4	53
02/96→12/06	Scudo Combinato 1.6	220 A 2.000	Petrol	1581	4	58
02/96→04/98	Scudo Combinato 1.9 D	D9B (XUD9/A/B/L/Y)	Diesel	1905	4	48
04/98→12/06	Scudo Combinato 1.9 D	WJZ (DW8)	Diesel	1868	4	39
02/96→12/06	Scudo Combinato 1.9 TD	D8B	Diesel	1905	4	47
02/96→12/06	Scudo Combinato 1.9 TD Eco	DHX (XUD9TE)	Diesel	1905	4	47
01/04→12/06	Scudo Combinato 2.0 JTD	DW10 (RHX)	Diesel	1998	4	53
12/99→12/06	Scudo Combinato 2.0 JTD	DW10 (RHZ)	Diesel	1997	4	53
05/99→12/06	Scudo Combinato 2.0 JTD 16V	DW10ATED4 (RHS)	Diesel	1997	4	53
01/07→	Scudo Platform/Chassis 1.6 D Multijet	9HU	Diesel	1560	4	18
01/07→	Scudo Platform/Chassis 2.0 D Multijet	DW10BTED4	Diesel	1997	4	53
01/07→	Scudo Platform/Chassis 2.0 D Multijet	RHK	Diesel	1997	4	53
01/07→	Scudo Platform/Chassis 2.0 D Multijet	RHR	Diesel	1997	4	53
06/06→	Sedici 1.9 D Multijet	D19AA	Diesel	1910	4	36
06/06→	Sedici 1.9 D Multijet 4x4	D19AA	Diesel	1910	4	36
06/06→	Sedici 2.0 D Multijet	D20AA Euro 5	Diesel	1956	4	46
06/06→	Sedici 2.0 D Multijet 4x4	D20AA Euro 5	Diesel	1956	4	46
01/98→01/10	Seicento 0.9	1170 A1.046	Petrol	899	4	2
01/98→01/10	Seicento 1.1	176 B2.000 Euro 2 (Fire)	Petrol	1108	4	11
01/98→01/10	Seicento 1.1	187 A1.000 Euro 3 (Fire)	Petrol	1108	4	11
01/98→01/10	Seicento Van 0.9	1170 A1.046	Petrol	899	4	2
01/98→01/10	Seicento Van 1.1	176 B2.000 Euro 2 (Fire)	Petrol	1108	4	11
09/98→	Siena 1.2	178 B5.000 Euro 3 (Fire)	Petrol	1242	4	12
09/01→	Siena 1.2	188 A4.000 Euro 3 (Fire)	Petrol	1242	4	12
09/01→	Siena 1.2	188 A5.000 Euro 3 (Fire)	Petrol	1242	4	12
06/04→	Siena 1.2 Bipower	178 E9.011	Flexfuel	1242	4	12
09/03→	Siena 1.3 JTD	188 A9.000	Diesel	1248	4	6
11/07→	Siena 1.3 JTD	188 A9.000	Diesel	1248	4	6
04/96→	Siena 1.4	178 B2.000	Petrol	1372	4	27
01/07→	Siena 1.4	199 A1.000	Petrol	1368	4	14
11/07→	Siena 1.4	199 A1.000	Petrol	1368	4	14
06/04→	Siena 1.4 Bipower	178 F3.011	Flexfuel	1368	4	14
04/96→	Siena 1.4 CAT	178B2.016	Petrol	1372	4	27
11/00→	Siena 1.6	182 B6.000 Euro 3	Petrol	1596	4	28
09/98→	Siena 1.6 16V	178 B3.000 Euro 2	Petrol	1581	4	59
02/06→	Siena 1.7 TD	176 A3.000	Diesel	1697	4	41
11/00→	Siena 1.9 D	223 A6.000	Diesel	1910	4	35
02/02→11/06	Stilo 1.2 16V	188 A5.000 Euro 3 (Fire)	Petrol	1242	4	12
03/05→11/06	Stilo 1.4 16V	192 B2.000	Petrol	1368	4	13
01/04→11/06	Stilo 1.4 16V	843 A1.000 Euro 4 (Fire)	Petrol	1368	4	13
10/01→11/06	Stilo 1.6 16V	182 B6.000 Euro 3	Petrol	1596	4	28
10/01→11/06	Stilo 1.8 16V	192 A4.000 Euro 3	Petrol	1747	4	37
09/05→11/06	Stilo 1.9 D Multijet	192 A8.000	Diesel	1910	4	36
09/05→11/06	Stilo 1.9 D Multijet	937A5.000	Diesel	1910	4	38
10/01→11/06	Stilo 1.9 JTD	192 A1.000	Diesel	1910	4	34
02/02→11/06	Stilo 1.9 JTD	192 A3.000 Euro 3	Diesel	1910	4	35
01/04→11/06	Stilo 1.9 JTD	192 A5.000	Diesel	1910	4	38
04/04→11/06	Stilo 1.9 JTD	192 B1.000	Diesel	1910	4	38
09/03→11/06	Stilo 1.9 JTD	937A4.000	Diesel	1910	4	38
10/01→11/06	Stilo 1.9 JTD	937A7.000	Diesel	1910	4	36
03/05→08/08	Stilo Multi Wagon 1.4 16V	192 B2.000	Petrol	1368	4	13
01/04→08/08	Stilo Multi Wagon 1.4 16V	843 A1.000 Euro 4 (Fire)	Petrol	1368	4	13
01/03→08/08	Stilo Multi Wagon 1.6 16V	182 B6.000 Euro 3	Petrol	1596	4	28
01/03→08/08	Stilo Multi Wagon 1.8 16V	192 A4.000 Euro 3	Petrol	1747	4	37
09/05→08/08	Stilo Multi Wagon 1.9 D Multijet	192 A8.000	Diesel	1910	4	36
09/05→08/08	Stilo Multi Wagon 1.9 D Multijet	937A5.000	Diesel	1910	4	38
01/03→08/08	Stilo Multi Wagon 1.9 JTD	192 A1.000	Diesel	1910	4	34
01/03→08/08	Stilo Multi Wagon 1.9 JTD	192 A3.000 Euro 3	Diesel	1910	4	35
01/04→08/08	Stilo Multi Wagon 1.9 JTD	192 A5.000	Diesel	1910	4	38
04/04→08/08	Stilo Multi Wagon 1.9 JTD	192 B1.000	Diesel	1910	4	38

MODEL INDEX

Modelverzeichnis • Index de modele • Índice de Modelo
Indeks modelu • Модель автомобиля • دليل الموديل



CCM

x



9

09/03→08/08	Stilo Multi Wagon 1.9 JTD	937A4.000	Diesel	1910	4	38
01/03→08/08	Stilo Multi Wagon 1.9 JTD	937A7.000	Diesel	1910	4	36
06/99→	Strada 1.2	178 B5.000 Euro 3 (Fire)	Petrol	1242	4	12
04/03→	Strada 1.2	188 A4.000 Euro 3 (Fire)	Petrol	1242	4	12
10/10→	Strada 1.3 D Multijet	199 B1.000 Euro 5	Diesel	1248	4	8
06/99→	Strada 1.7 TD	176 A3.000	Diesel	1697	4	41
12/00→	Strada 1.9 D	223 A6.000	Diesel	1910	4	35
04/03→	Strada 1.9 JTD	188 A2.000 Euro 3	Diesel	1910	4	35
03/89→03/94	Talento Box 1.9 D	149 B1.000	Diesel	1929	4	42
03/89→03/94	Talento Box 2.0	170 B	Petrol	1971	4	60
03/89→03/94	Talento Bus 1.9 D	149 B1.000	Diesel	1929	4	42
03/89→03/94	Talento Bus 2.0	170 B	Petrol	1971	4	60
03/89→03/94	Talento Platform/Chassis 1.9 D	149 B1.000	Diesel	1929	4	42
03/89→03/94	Talento Platform/Chassis 2.0	170 B	Petrol	1971	4	60
03/91→08/96	Tempra 1.4 i.e.	159 A2.000	Petrol	1372	4	27
03/92→08/96	Tempra 1.4 i.e.	160 A1.046	Petrol	1372	4	27
03/92→08/96	Tempra 1.4 i.e.	836 A4.000	Petrol	1372	4	27
03/90→04/93	Tempra 1.6	159 A3.000	Petrol	1581	4	58
04/90→06/93	Tempra 1.6	159 A3.048	Petrol	1585	4	58
06/90→07/92	Tempra 1.6 i.e.	159 A3.046	Petrol	1585	4	58
06/92→08/96	Tempra 1.6 i.e.	159 A3.048	Petrol	1585	4	58
06/92→08/96	Tempra 1.6 i.e.	835 C1.000	Petrol	1581	4	58
03/90→08/96	Tempra 1.8 i.e.	159 A4.000	Petrol	1756	4	52
03/92→08/96	Tempra 1.8 i.e.	159 A4.046	Petrol	1756	4	52
09/93→08/96	Tempra 1.8 i.e.	835 C2.000	Petrol	1756	4	52
07/91→08/96	Tempra 1.9 D	149 A1.000	Diesel	1929	4	42
07/91→08/96	Tempra 1.9 D	160 A7.000	Diesel	1929	4	42
05/90→08/96	Tempra 1.9 TD	160 A6.000	Diesel	1929	4	41
07/92→08/96	Tempra 1.9 TD	160 B6.046	Diesel	1929	4	41
05/90→08/96	Tempra 1.9 TD	160 D1.000	Diesel	1929	4	41
10/90→08/96	Tempra 2.0 i.e.	159 A6.046	Petrol	1995	4	50
03/91→08/96	Tempra S.W. 1.4 i.e.	159 A2.000	Petrol	1372	4	27
10/92→08/96	Tempra S.W. 1.4 i.e.	160 A1.046	Petrol	1372	4	27
10/92→08/96	Tempra S.W. 1.4 i.e.	836 A4.000	Petrol	1372	4	27
12/90→04/93	Tempra S.W. 1.6	159 A3.000	Petrol	1581	4	58
10/90→08/96	Tempra S.W. 1.6 i.e.	159 A3.046	Petrol	1585	4	58
10/92→08/96	Tempra S.W. 1.6 i.e.	159 A3.048	Petrol	1585	4	58
10/90→08/96	Tempra S.W. 1.6 i.e.	835 C1.000	Petrol	1581	4	58
10/92→08/96	Tempra S.W. 1.6 i.e.	835 C1.000	Petrol	1581	4	58
07/92→06/93	Tempra S.W. 1.8 4x4	159 A4.000	Petrol	1756	4	52
03/90→08/96	Tempra S.W. 1.8 i.e.	159 A4.000	Petrol	1756	4	52
03/92→12/93	Tempra S.W. 1.8 i.e.	159 A4.046	Petrol	1756	4	52
09/93→08/96	Tempra S.W. 1.8 i.e.	835 C2.000	Petrol	1756	4	52
07/91→08/96	Tempra S.W. 1.9 D	149 A1.000	Diesel	1929	4	42
07/91→08/96	Tempra S.W. 1.9 D	160 A7.000	Diesel	1929	4	42
07/91→02/95	Tempra S.W. 1.9 TD	160 A6.000	Diesel	1929	4	41
03/92→06/93	Tempra S.W. 1.9 TD	160 B6.046	Diesel	1929	4	41
07/91→02/95	Tempra S.W. 1.9 TD	160 D1.000	Diesel	1929	4	41
01/91→03/95	Tempra S.W. 2.0 i.e.	159 A6.046	Petrol	1995	4	50
03/92→03/95	Tempra S.W. 2.0 i.e. 4x4	159 A6.046	Petrol	1995	4	50
01/88→10/91	Tipo 1.1	160 A3.000 (Fire)	Petrol	1108	4	10
07/87→12/89	Tipo 1.4	160 A1.000	Petrol	1372	4	27
07/87→12/89	Tipo 1.4	160 A1.048	Petrol	1372	4	27
05/89→04/95	Tipo 1.4 i.e.	159 A2.000	Petrol	1372	4	27
05/89→04/95	Tipo 1.4 i.e.	160 A1.046	Petrol	1372	4	27
05/89→04/95	Tipo 1.4 i.e.	836 A4.000	Petrol	1372	4	27
01/88→10/91	Tipo 1.6	160 A2.000	Petrol	1585	4	58
03/88→10/92	Tipo 1.6	160 A2.000	Petrol	1585	4	58
02/88→05/91	Tipo 1.6 i.e.	149 C2.046	Petrol	1585	4	50
07/90→01/93	Tipo 1.6 i.e.	159 A3.046	Petrol	1585	4	58



CCM

x



9

10/92→04/95	Tipo 1.6 i.e.	159 A3.048	Petrol	1585	4	58
10/92→04/95	Tipo 1.6 i.e.	835 C1.000	Petrol	1581	4	58
05/89→10/95	Tipo 1.6 SX DGT	159 A3.000	Petrol	1581	4	58
01/88→10/94	Tipo 1.7 D	149 B4.000	Diesel	1697	4	40
01/88→10/95	Tipo 1.7 D	149 B4.000	Diesel	1697	4	40
10/90→06/93	Tipo 1.8 i.e.	159 A4.000	Petrol	1756	4	52
10/94→04/95	Tipo 1.8 i.e.	159 A4.000	Petrol	1756	4	52
10/90→06/93	Tipo 1.8 i.e.	159 A4.046	Petrol	1756	4	52
04/93→04/95	Tipo 1.8 i.e.	835 C2.000	Petrol	1756	4	52
07/91→08/96	Tipo 1.9 D	149 A1.000	Diesel	1929	4	42
07/91→08/96	Tipo 1.9 D	160 A7.000	Diesel	1929	4	42
09/90→04/95	Tipo 1.9 TD	160 A6.000	Diesel	1929	4	41
09/90→04/95	Tipo 1.9 TD	160 A6.046	Diesel	1929	4	41
03/92→06/93	Tipo 1.9 TD	160 B6.046	Diesel	1929	4	41
09/90→04/95	Tipo 1.9 TD	160 D1.000	Diesel	1929	4	41
10/90→10/92	Tipo 2.0	159 A5.046	Petrol	1995	4	50
10/90→10/92	Tipo 2.0	159 A6.046	Petrol	1995	4	50
06/90→03/92	Tipo 2.0 i.e.	159 A5.046	Petrol	1995	4	50
03/90→04/95	Tipo 2.0 i.e.	159 A6.046	Petrol	1995	4	50
03/93→04/95	Tipo 2.0 i.e. 16V Sport	836 A3.000	Petrol	1995	4	52
05/97→08/02	Ulysse 1.8	LFW (XU7 JP)	Petrol	1762	4	49
02/95→08/02	Ulysse 1.9 TD	D8B (XUD9TE)	Diesel	1905	4	47
02/95→08/02	Ulysse 1.9 TD	DHX (XUD9TE)	Diesel	1905	4	47
06/94→08/02	Ulysse 2.0	RFU (XU10 J2C)	Petrol	1998	4	56
05/98→09/00	Ulysse 2.0 16V	XU10 (RFV)	Petrol	1998	4	56
05/06→06/11	Ulysse 2.0 D Multijet	RHK	Diesel	1997	4	53
05/06→06/11	Ulysse 2.0 D Multijet	RHR	Diesel	1997	4	53
10/99→08/02	Ulysse 2.0 JTD	DW10 (RHZ)	Diesel	1997	4	53
05/03→08/06	Ulysse 2.0 JTD	DW10ATED4	Diesel	1997	4	53
08/02→08/06	Ulysse 2.0 JTD	DW10ATED4 (RHS)	Diesel	1997	4	53
05/99→08/02	Ulysse 2.0 JTD 16V	DW10ATED4 (RHS)	Diesel	1997	4	53
06/94→08/02	Ulysse 2.0 Turbo	RGX	Petrol	1998	4	56
03/96→10/99	Ulysse 2.1 TD	P8C (XUD 11 BTE)	Diesel	2088	4	54
08/02→08/06	Ulysse 2.2 JTD	4HW (DW12ATED4)	Diesel	2179	4	53
06/89→02/92	Uno 1.0	156 A2.000	Petrol	999	4	10
	Uno 1.0	156 A2.0157	Petrol	999	4	10
	Uno 1.0	156 A2.050	Petrol	999	4	10
05/98→08/00	Uno 1.0 iE	156 A2.246 (Fire)	Petrol	999	4	10
01/92→06/06	Uno 1.1	160 A3.000 (Fire)	Petrol	1108	4	10
06/83→03/92	Uno 1.3 Super Diesel	127 A5.000	Diesel	1301	4	20
06/83→03/92	Uno 1.3 Super Diesel	146 B1.000	Diesel	1301	4	20
04/85→08/89	Uno 1.3 Turbo i.e.	146 A2.000	Petrol	1301	4	25
01/87→12/87	Uno 1.3 Turbo i.e.	146 A2.146	Petrol	1301	4	25
09/89→03/91	Uno 1.3 Turbo i.e.	146 A2.246	Petrol	1301	4	25
01/89→12/91	Uno 1.4	146 A8.000	Petrol	1372	4	26
07/91→07/96	Uno 1.4	160 A1.046	Petrol	1372	4	27
10/88→08/00	Uno 1.4 Turbo	146 A8.000	Petrol	1372	4	26
12/89→12/96	Uno 1.4 Turbo i.e.	146 A8.000	Petrol	1372	4	26
09/89→09/93	Uno 1.4 Turbo i.e.	146 A8.046	Petrol	1372	4	26
12/89→12/93	Uno 1.6	159 A3.046	Petrol	1585	4	58
11/94→08/00	Uno 1.7 D	146 B2.000	Diesel	1697	4	40
09/89→03/94	Uno 1.9 D	149 B5.046	Diesel	1929	4	42
01/86→	Uno 1.9D	154 B.000	Diesel	1929	4	43
02/84→12/88	Uno 45 0.9	146 A.000	Petrol	903	4	1
03/83→09/92	Uno 45 0.9	146 A.000	Petrol	903	4	1
03/83→09/92	Uno 45 0.9	146 A.1000	Petrol	903	4	1
	Uno 45 0.9	M020 AA.09.0	Petrol	903	4	1
06/86→12/93	Uno 45 1.0	156 A2.100 (Fire)	Petrol	999	4	10
04/84→10/95	Uno 45 i.e. 1.0	156 A2.246 (Fire)	Petrol	999	4	10
01/90→12/93	Uno 50 1.1	156 C.046 (Fire)	Petrol	1108	4	10

MODEL INDEX

Modelverzeichnis • Index de modele • Índice de Modelo
Indeks modelu • Модель автомобиля • دليل الموديل



CCM

x



9

01/83→08/89	Uno 55 1.1	138 B.000	Petrol	1116	4	24
04/89→12/92	Uno 60 1.1	160 A3.000 (Fire)	Petrol	1108	4	10
09/89→12/93	Uno 60 Diesel 1.7	146 B2.000	Diesel	1697	4	40
07/86→08/89	Uno 60 Diesel 1.7	149 B3.000	Diesel	1697	4	40
01/83→04/85	Uno 70 1.3	138 B2.000	Petrol	1302	4	57
05/85→08/89	Uno 70 1.3	149 A7.000	Petrol	1302	4	57
09/89→12/93	Uno 70 i.e. 1.4	146 C1.000	Petrol	1372	4	27
09/89→12/93	Uno 70 i.e. 1.4	160 A1.046	Petrol	1372	4	27
09/89→10/92	Uno 70 S 1.4	160 A1.048	Petrol	1372	4	27
10/86→10/90	Uno 70 TD 1.4	146 B.000	Diesel	1367	4	22
10/86→10/90	Uno 70 TD 1.4	146 B3.000	Diesel	1367	4	22
02/88→02/92	Uno Box 1.7 D	146 B2.000	Diesel	1697	4	40
02/88→02/92	Uno Box 1.7 D	149 B4.046	Diesel	1697	4	40
02/88→07/96	Uno Box 45 0.9	146 A.000	Petrol	903	4	1
02/88→07/96	Uno Box 45 0.9	146 A.1000	Petrol	903	4	1
	Uno Box 45 0.9	M020 AA.09.0	Petrol	903	4	1
11/78→12/89	X 1/9 1.5	138 AS.000	Petrol	1499	4	57

Motorverzeichnis • Index de moteur • Índice de Motor
Indeks silnika • Модель двигателя • دليل المحرك

ENGINE INDEX



CCM

x



9

4HU Euro 4	Diesel	2198	4	86.00	55
4HV Euro 4	Diesel	2198	4	86.00	55
4HW (DW12ATED4)	Diesel	2179	4	85.00	53
4HX (DW12TED4)	Diesel	2179	4	85.00	53
9HU	Diesel	1560	4	75.00	18
100 G.000	Petrol	843	4	65.00	1
100 G.002	Petrol	844	4	65.00	1
100 GB.000	Petrol	844	4	65.00	1
100 GBC.000	Petrol	903	4	65.00	1
100 GBC.040	Petrol	903	4	65.00	1
100 GBS.000	Petrol	903	4	65.00	1
100 GC.000	Petrol	844	4	65.00	1
100 GF 000	Petrol	903	4	65.00	1
100 GL.000	Petrol	903	4	65.00	1
100 GL.048	Petrol	903	4	65.00	1
100 GL.064	Petrol	903	4	65.00	1
100 GL3.000	Petrol	903	4	65.00	1
100 GL6.000	Petrol	843	4	65.00	1
110 D.000	Petrol	499	2	70.00	9
110 F.000	Petrol	499	2	67.40	5
120.000	Petrol	499	2	67.40	5
124 AC.000	Petrol	1438	4	80.00	24
124 B.0000	Petrol	1438	4	80.00	24
124 B2.000	Petrol	1438	4	80.00	24
124 B3.000	Petrol	1585	4	84.00	50
125 A.000	Petrol	1608	4	80.00	24
125 B.000	Petrol	1608	4	80.00	24
126 A.000	Petrol	594	2	73.50	17
126 A1.000	Petrol	652	2	77.00	21
126 A1.048	Petrol	652	2	77.00	21
126 A2.000	Petrol	704	2	80.00	24
126 A2.048	Petrol	704	2	80.00	24
127 A.000	Petrol	903	4	65.00	1
127 A1.000	Petrol	1049	4	76.00	19
127 A3.000	Petrol	1297	4	76.00	19
127 A5.000	Diesel	1301	4	76.00	20
127 A6.000	Petrol	1049	4	76.00	19
128 A.000	Petrol	1116	4	80.00	24
128 A.048	Petrol	1116	4	80.00	24
128 AC5.000	Petrol	1116	4	80.00	24
131 A1.000	Petrol	1585	4	84.00	50
131 A6.000	Petrol	1297	4	76.00	19
131 B.000	Petrol	1297	4	76.00	19
131 B1.000	Petrol	1585	4	84.00	51
131 B2.000	Petrol	1995	4	84.00	50
131 C2.000	Petrol	1585	4	84.00	50
131 C3.000	Petrol	1585	4	84.00	50
131 C4.000	Petrol	1995	4	84.00	50
132 A.000	Petrol	1592	4	80.00	24
132 A.C1.000	Petrol	1756	4	84.00	51
132 AC.000	Petrol	1592	4	80.00	24
132 B1.000	Petrol	1756	4	84.00	51
132 BB OA O	Petrol	1585	4	80.00	24
132 C.000	Petrol	1585	4	84.00	51
132 C2.000	Petrol	1995	4	84.00	50
132 C3.000	Petrol	1995	4	84.00	50
132 C3.031	Petrol	1995	4	84.00	51
132 D.000	Petrol	1585	4	84.00	51
132 D1.000	Petrol	1995	4	84.00	50
138 A1.000	Petrol	1302	4	86.40	57

ENGINE INDEX

Motorverzeichnis • Index de moteur • Índice de Motor
 Indeks silnika • Модель двигателя • دليل المحرك

CCM
x

9

138 A2.000	Petrol	1498	4	86.40	57
138 A3.000	Petrol	1302	4	86.40	57
138 A4.000	Petrol	1498	4	86.40	57
138 AR.000	Petrol	1585	4	84.00	51
138 AR.048	Petrol	1585	4	84.00	51
138 AS.000	Petrol	1499	4	86.40	57
138 B.000	Petrol	1116	4	80.00	24
138 B2.000	Petrol	1302	4	86.40	57
138 B3.000	Petrol	1498	4	86.40	57
138 B3.048	Petrol	1498	4	86.40	57
138 B6.000	Diesel	1714	4	83.00	45
138 C.000	Diesel	1677	4	82.60	40
141 A.000	Petrol	652	2	77.00	21
141 B.000	Petrol	770	4	65.00	1
146 A.000	Petrol	903	4	65.00	1
146 A.048	Petrol	903	4	65.00	1
146 A.1000	Petrol	903	4	65.00	1
146 A2.000	Petrol	1301	4	80.50	25
146 A2.146	Petrol	1301	4	80.50	25
146 A2.246	Petrol	1301	4	80.50	25
146 A8.000	Petrol	1372	4	80.50	26
146 A8.046	Petrol	1372	4	80.50	26
146 B.000	Diesel	1367	4	78.00	22
146 B1.000	Diesel	1301	4	76.00	20
146 B2.000	Diesel	1697	4	82.60	40
146 B3.000	Diesel	1367	4	78.00	22
146 C1.000	Petrol	1372	4	80.50	27
146 C5.000	Petrol	1372	4	80.50	27
146 D5.000	Petrol	1372	4	80.50	27
146 D7.000	Diesel	1697	4	82.60	41
149 A.000	Petrol	1585	4	84.00	50
149 A1.000	Diesel	1929	4	82.60	42
149 A2.000	Petrol	1585	4	84.00	51
149 A3.000	Petrol	1302	4	86.40	57
149 A4.000	Petrol	1585	4	84.00	50
149 A7.000	Petrol	1302	4	86.40	57
149 B1.000	Diesel	1929	4	82.60	42
149 B3.000	Diesel	1697	4	82.60	40
149 B4.000	Diesel	1697	4	82.60	40
149 B4.046	Diesel	1697	4	82.60	40
149 B5.046	Diesel	1929	4	82.60	42
149 C2.000	Petrol	1595	4	84.00	50
149 C2.046	Petrol	1585	4	84.00	50
149 C3.000	Petrol	1595	4	84.00	50
154 A.048	Petrol	1585	4	84.00	51
154 A1.000	Petrol	1995	4	84.00	51
154 A2.000	Petrol	1995	4	84.00	51
154 B.000	Diesel	1929	4	82.60	43
154 C3.046	Petrol	1995	4	84.00	51
154 C4.046	Petrol	1995	4	84.00	51
154 C6.000	Diesel	1929	4	82.60	43
154 E1.000	Petrol	1995	4	84.00	52
156 A2.000	Petrol	999	4	70.00	10
156 A2.0157	Petrol	999	4	70.00	10
156 A2.050	Petrol	999	4	70.00	10
156 A2.100 (Fire)	Petrol	999	4	70.00	10
156 A2.246 (Fire)	Petrol	999	4	70.00	10
156 A3.000	Petrol	999	4	70.00	10
156 A4.000 (Fire)	Petrol	770	4	65.00	3
156 A4.048 (Fire)	Petrol	770	4	65.00	3

Motorverzeichnis • Index de moteur • Índice de Motor
 Indeks silnika • Модель двигателя • دليل المحرك

ENGINE INDEX

CCM

x



9

156 A5.000	Diesel	1301	4	76.00	20
156 C.046 (Fire)	Petrol	1108	4	70.00	10
159 A2.000	Petrol	1372	4	80.50	27
159 A3.000	Petrol	1581	4	86.40	58
159 A3.046	Petrol	1585	4	86.40	58
159 A3.048	Petrol	1585	4	86.40	58
159 A4.000	Petrol	1756	4	84.00	52
159 A4.046	Petrol	1756	4	84.00	52
159 A5.046	Petrol	1995	4	84.00	50
159 A6.046	Petrol	1995	4	84.00	50
160 A1.000	Petrol	1372	4	80.50	27
160 A1.046	Petrol	1372	4	80.50	27
160 A1.048	Petrol	1372	4	80.50	27
160 A2.000	Petrol	1585	4	86.40	58
160 A3.000 (Fire)	Petrol	1108	4	70.00	10
160 A6.000	Diesel	1929	4	82.60	41
160 A6.046	Diesel	1929	4	82.60	41
160 A7.000	Diesel	1929	4	82.60	42
160 B6.046	Diesel	1929	4	82.60	41
160 D1.000	Diesel	1929	4	82.60	41
169 A1.000	Diesel	1248	4	69.60	6
169 A3.000	Petrol	1368	4	72.00	13
169 A4.000	Petrol	1242	4	70.80	12
170 A.000	Petrol	704	2	80.00	24
170 A.046	Petrol	704	2	80.00	24
170 A1.000	Petrol	903	4	65.00	2
170 A1.046	Petrol	903	4	65.00	2
170 B	Petrol	1971	4	88.00	60
170 D	Petrol	1971	4	88.00	60
175 A1.000	Petrol	1995	4	84.00	52
175 A3.000	Petrol	1998	5	82.00	29
176 A3.000	Diesel	1697	4	82.60	41
176 A4.000	Petrol	1372	4	80.50	26
176 A5.000	Diesel	1697	4	82.60	41
176 A6.000 (Fire)	Petrol	1108	4	70.00	11
176 A7.000 (Fire)	Petrol	1242	4	70.80	12
176 A8.000 (Fire)	Petrol	1242	4	70.80	12
176 A9.000	Petrol	1581	4	86.40	58
176 B1.000	Petrol	1242	4	70.80	12
176 B2.000 Euro 2 (Fire)	Petrol	1108	4	70.00	11
176 B3.000	Diesel	1697	4	82.60	40
176 B4.000 (Fire)	Petrol	1242	4	70.80	12
176 B6.000	Petrol	1372	4	80.50	26
176 B7.000	Diesel	1697	4	82.60	41
176 B9.000 (Fire)	Petrol	1242	4	70.80	12
178 B2.000	Petrol	1372	4	80.50	27
178 B3.000 Euro 2	Petrol	1581	4	86.40	59
178 B5.000 Euro 3 (Fire)	Petrol	1242	4	70.80	12
178 E8.011	Petrol	1242	4	70.80	12
178 E9.011	Flexfuel	1242	4	70.80	12
178 F3.011	Flexfuel	1368	4	72.00	14
178B2.016	Petrol	1372	4	80.50	27
178E2.000 (Fire)	Petrol	1242	4	70.80	12
182 A1.000 Euro 2	Petrol	1998	5	82.00	30
182 A2.000 Euro 2	Petrol	1747	4	82.00	31
182 A3.000	Petrol	1371	4	82.00	30
182 A4.000 Euro 2	Petrol	1581	4	86.40	59
182 A5.000	Petrol	1371	4	82.00	30
182 A6.000 Euro 2	Petrol	1581	4	86.40	59
182 A7.000	Diesel	1910	4	82.00	32

ENGINE INDEX

Motorverzeichnis • Index de moteur • Índice de Motor
 Indeks silnika • Модель двигателя • دليل المحرك

CCM

9

182 A8.000	Diesel	1910	4	82.00	32
182 B2.000 (Fire)	Petrol	1242	4	70.80	12
182 B3.000 Euro 2	Petrol	1998	5	82.00	30
182 B4.000 Euro 2	Diesel	1910	4	82.00	33
182 B6.000 Euro 3	Petrol	1596	4	80.50	28
182 B7.000 Euro 2	Petrol	1998	5	82.00	30
182 B9.000	Diesel	1910	4	82.00	34
183 A1.000 Euro 2	Petrol	1747	4	82.00	31
185 A2.000	Diesel	2387	5	82.00	32
185 A3.000 Euro 2	Petrol	1581	4	86.40	59
185 A6.000 Euro 2	Diesel	2387	5	82.00	33
185 A8.000 Euro 3	Petrol	1998	5	82.00	31
186 A6.000 Euro 3	Diesel	1910	4	82.00	35
186 A8.000	Diesel	1910	4	82.00	34
186A9.000	Diesel	1910	4	82.00	36
187 A1.000 Euro 3 (Fire)	Petrol	1108	4	70.00	11
188 A2.000 Euro 3	Diesel	1910	4	82.00	35
188 A3.000	Diesel	1910	4	82.00	35
188 A4.000 Euro 3 (Fire)	Petrol	1242	4	70.80	12
188 A5.000 Euro 3 (Fire)	Petrol	1242	4	70.80	12
188 A6.000 Euro 3	Petrol	1747	4	82.00	37
188 A7.000 Euro 3	Diesel	1910	4	82.00	35
188 A8.000	Diesel	1248	4	69.60	6
188 A9.000	Diesel	1248	4	69.60	6
188 B2.000	Diesel	1910	4	82.00	36
192 A1.000	Diesel	1910	4	82.00	34
192 A3.000 Euro 3	Diesel	1910	4	82.00	35
192 A4.000 Euro 3	Petrol	1747	4	82.00	37
192 A5.000	Diesel	1910	4	82.00	38
192 A8.000	Diesel	1910	4	82.00	36
192 B1.000	Diesel	1910	4	82.00	38
192 B2.000	Petrol	1368	4	72.00	13
198 A1.000	Petrol	1368	4	72.00	15
198 A2.000	Diesel	1598	4	79.50	23
198 A4.000	Petrol	1368	4	72.00	15
198 A5.000	Diesel	1956	4	83.00	46
198 A7.000	Petrol	1368	4	72.00	15
199 A1.000	Petrol	1368	4	72.00	14
199 A2.000	Diesel	1248	4	69.60	6
199 A3.000	Diesel	1248	4	69.60	7
199 A4.000	Petrol	1242	4	70.80	12
199 A5.000	Diesel	1910	4	82.00	36
199 A6.000	Petrol	1368	4	72.00	13
199 A7.000	Petrol	1368	4	72.00	14
199 A8.000	Petrol	1368	4	72.00	15
199 A9.000 Euro 5	Diesel	1248	4	69.60	8
199 B1.000 Euro 5	Diesel	1248	4	69.60	8
199 B2.000 Euro 5	Diesel	1248	4	69.60	8
199 B4.000 Euro 5	Diesel	1248	4	69.60	8
220 A 2.000	Petrol	1581	4	86.40	58
223 A3.011	Petrol	1242	4	70.80	12
223 A5.000 Euro 3 (Fire)	Petrol	1242	4	70.80	12
223 A6.000	Diesel	1910	4	82.00	35
223 A7.000	Diesel	1910	4	82.00	36
230 A2.000	Diesel	1929	4	82.60	42
230 A3.000	Diesel	1929	4	82.60	44
230 A4.000	Diesel	1929	4	82.60	44
250 A1.000 Euro 5	Diesel	1956	4	83.00	46
263 A1.000 Euro 5	Diesel	1956	4	83.00	46
280 A1.000	Diesel	1929	4	82.60	44

Motorverzeichnis • Index de moteur • Índice de Motor
 Indeks silnika • Модель двигателя • دليل المحرك

ENGINE INDEX

CCM

x



9

312 A1.000	Petrol	1368	4	72.00	15
312 A3.000	Petrol	1368	4	72.00	15
323 B6.600	Petrol	1368	4	72.00	13
350 A1.000	Petrol	1368	4	72.00	14
831 D1.000	Diesel	1929	4	82.60	42
834 A1.000	Petrol	1368	4	72.00	16
834 B.000	Petrol	1995	4	84.00	51
834 B.048	Petrol	1995	4	84.00	51
834 B.146	Petrol	1995	4	84.00	51
834 C.146	Petrol	1995	4	84.00	52
834 G.000	Petrol	2492	V6	88.00	61
835 C1.000	Petrol	1581	4	86.40	58
835 C2.000	Petrol	1756	4	84.00	52
836 A3.000	Petrol	1995	4	84.00	52
836 A4.000	Petrol	1372	4	80.50	27
839 A5.000 Euro 2	Diesel	2387	5	82.00	33
843 A1.000 Euro 4 (Fire)	Petrol	1368	4	72.00	13
844 A2.000	Diesel	1956	4	83.00	46
937A4.000	Diesel	1910	4	82.00	38
937A5.000	Diesel	1910	4	82.00	38
937A7.000	Diesel	1910	4	82.00	36
939 A1.000	Diesel	1910	4	82.00	34
939 B5.000	Diesel	1956	4	83.00	46
939A2.000	Diesel	1910	4	82.00	38
939A3.000	Diesel	2387	5	82.00	38
940 A5.000 Euro 5	Diesel	1956	4	83.00	46
955 A3.000 Euro 5	Diesel	1598	4	79.50	23
955 A8.000 Euro 5	Petrol	1368	4	72.00	15
1170 A1.000	Petrol	899	4	65.00	1
1170 A1.046	Petrol	899	4	65.00	2
8140.07	Diesel	2499	4	93.00	63
8140.21.201-203 (Sofim)	Diesel	2445	4	93.00	64
8140.27 (Sofim)	Diesel	2500	4	93.00	64
8140.27.2100	Diesel	2500	4	93.00	64
8140.27S.3700 Euro 1	Diesel	2499	4	93.00	65
8140.43	Diesel	2800	4	94.40	69
8140.43N Euro 3	Diesel	2798	4	94.40	70
8140.43S Euro 3	Diesel	2800	4	94.40	70
8140.47	Diesel	2499	4	93.00	65
8140.47R (Sofim)	Diesel	2499	4	93.00	65
8140.47R.2210	Diesel	2499	4	93.00	65
8140.61	Diesel	2445	4	93.00	66
8140.63 (Sofim)	Diesel	2798	4	94.40	71
8140.67	Diesel	2500	4	93.00	63
8140.67.2700	Diesel	2499	4	93.00	63
8140.97Y (Sofim)	Diesel	2499	4	93.00	65
8142.61	Diesel	2445	4	93.00	66
8144.21 (Sofim)	Diesel	2445	4	93.00	64
8144.21.220	Diesel	2445	4	93.00	64
8144.61	Diesel	2445	4	93.00	66
8144.61.500.81	Diesel	2445	4	93.00	66
8144.67	Diesel	2500	4	93.00	67
8144.67.220	Diesel	2499	4	93.00	67
8144.91	Diesel	2445	4	93.00	64
8144.97 (Sofim)	Diesel	2499	4	93.00	64
8144.97 S (Sofim)	Diesel	2500	4	93.00	64
8144.97 Y (Sofim)	Diesel	2500	4	93.00	64
8144.97.2400	Diesel	2499	4	93.00	64
A 112 B1.054	Petrol	965	4	67.20	4
B 25.637	Diesel	2498	4	93.00	68

ENGINE INDEX

Motorverzeichnis • Index de moteur • Índice de Motor
 Indeks silnika • Модель двигателя • دليل المحرك

CCM
x

9

CRD93L (U25-661)	Diesel	2500	4	93.00	68
D8B	Diesel	1905	4	83.00	47
D8B (XUD9TE)	Diesel	1905	4	83.00	47
D9B (XUD9A/B/L/Y)	Diesel	1905	4	83.00	48
D9B (XUD9A)	Diesel	1905	4	83.00	48
D19AA	Diesel	1910	4	82.00	36
D20AA Euro 5	Diesel	1956	4	83.00	46
DHX (XUD9TE)	Diesel	1905	4	83.00	47
DJY (XUD9)	Diesel	1905	4	83.00	48
DJY (XUD9A)	Diesel	1905	4	83.00	48
DW10 (RHV)	Diesel	1997	4	85.00	53
DW10 (RHX)	Diesel	1998	4	85.00	53
DW10 (RHZ)	Diesel	1997	4	85.00	53
DW10ATED4	Diesel	1997	4	85.00	53
DW10ATED4 (RHS)	Diesel	1997	4	85.00	53
DW10BTED4	Diesel	1997	4	85.00	53
F1AE 0481 C Euro 3	Diesel	2287	4	88.00	62
F1AE0481D Euro 4	Diesel	2286	4	88.00	62
F1AE0481N	Diesel	2287	4	88.00	62
F1AE0481T	Diesel	2286	4	88.00	62
LFW (XU7 JP)	Petrol	1762	4	83.00	49
M020 AA.09.0	Petrol	903	4	65.00	1
P8C (XUD 11 BTE)	Diesel	2088	4	85.00	54
RFU (XU10 J2C)	Petrol	1998	4	86.00	56
RFW (XU10J2)	Petrol	1998	4	86.00	56
RGX	Petrol	1998	4	86.00	56
RHK	Diesel	1997	4	85.00	53
RHR	Diesel	1997	4	85.00	53
Sofim-8144.61.200	Diesel	2445	4	93.00	66
WJZ (DW8)	Diesel	1868	4	82.20	39
XN 1T	Petrol	1971	4	88.00	60
XU10 (RFV)	Petrol	1998	4	86.00	56



850 0.8	07/64→10/72	100 G.000	4cyl. 843cc	25kW (34PS)	1	TD863
850 0.8	07/64→10/72	100 G.002	4cyl. 844cc	27kW (37PS)		TD864
850 0.8 Special	03/68→10/72	100 GB.000	4cyl. 844cc	35kW (47PS)		TD865
850 0.8 Special		100 GBC.000	4cyl. 903cc	38kW (52PS)		TD866
850 0.8 Special		100 GBC.040	4cyl. 903cc	38kW (52PS)		TD23115
850 0.8 Special		100 GBS.000	4cyl. 903cc	38kW (52PS)		TD867
850 0.8 Special		100 GC.000	4cyl. 844cc	38kW (52PS)		TD868
900 T/E Panorama 0.9, 900 T/E Pulmino 0.9	01/78→01/86	100 GF 000	4cyl. 903cc	34kW (46PS)		TD6939
127 0.9 Fiorino 900	06/71→05/83 10/77→12/84	100 GL.000	4cyl. 903cc	34kW (46PS)		TD870
127 0.9	06/71→05/83	100 GL.048	4cyl. 903cc	34kW (46PS)		TD4413
127 0.9		100 GL.064	4cyl. 903cc	33kW (45PS)		TD23116
Panda 900	10/80→06/94	100 GL3.000	4cyl. 903cc	34kW (46PS)		TD869
850 0.8		100 GL6.000	4cyl. 843cc	25kW (34PS)		TD21449
Cinquecento 0.9 i.e. S	07/91→07/99	1170 A1.000	4cyl. 899cc	29-30kW (40-41PS)		TD1030





127 1.0		04/77→12/86		127 A.000					
127 Panorama 1.0		01/77→12/86			4cyl.				
147 1.0		10/76→12/95			903cc	34kW (46PS)			
Fiorino 1.0, Fiorino 1050		01/80→12/87						TD887	
Panda 750		01/86→01/95		141 B.000					
Panda Van 750		01/86→07/92			4cyl.				
					770cc	25kW (34PS)		TD4370	
Panda 900		10/80→06/94		146 A.000					
Uno 45 0.9		03/83→09/92			4cyl.				
Uno Box 45 0.9		02/88→07/96			903cc	33kW (45PS)		TD4371	
Panda 0.9 Fire S All-wheel Drive		10/80→04/86		146 A.048					
					4cyl.				
					903cc	33kW (45PS)		TD934	
Uno 45 0.9		03/83→09/92		146 A.1000					
Uno Box 45 0.9		02/88→07/96			4cyl.				
					903cc	33kW (45PS)		TD4372	
Uno 45 0.9, Uno Box 45 0.9				M020 AA.09.0					
					4cyl.				
					903cc	33kW (45PS)		TD22241	
08-209800-00	STD	65.00	1.750		001 IF CR P			IKA	
08-209806-00	0.40mm				026 P			STD	
08-209808-00	0.60mm		2.000		231 P			STD	
[R46550]			3.947						
Cinquecento 0.9 i.e. S		07/91→07/99		1170 A1.046				2	
Panda 900		04/92→12/96			4cyl.				
Seicento 0.9, Seicento Van 0.9		01/98→01/10			899cc	30kW (41PS)		TD872	
Cinquecento 0.9		07/91→12/93		170 A1.000					
					4cyl.				
					903cc	30kW (41PS)		TD15810	
Cinquecento 0.9 i.e.		07/91→12/93		170 A1.046					
					4cyl.				
					903cc	30kW (41PS)		TD15811	
08-145100-00	STD	65.00	1.500		001 NT			KV1	
08-145106-00	0.40mm			1.500		005 IFU P			KV1
08-145108-00	0.60mm			3.000		231 P			GOE13
[R67928]									
08-145100-10	STD	65.00	1.500		001 P			IKA	
				1.500		005 IFU P			KV1
				3.000		231 P			GOE13
[R46990]									



Panda 750	01/86→01/95	156 A4.000 (Fire)	4cyl. 770cc	25kW (34PS)	3
TD11307					

Panda 750	01/95→10/03	156 A4.048 (Fire)	4cyl. 770cc	25kW (34PS)	4
TD11308					

08-782700-00 [R46920]	STD	65.00	1.500		001 IF CR P	IKA
			1.500		005 IF P	STD
			3.000		712 CR	ST

Panda 950 Panda 950 4x4	09/82→08/83 09/83→12/86	A 112 B1.054	4cyl. 965cc	35kW (47PS)	4
TD4412					

08-782600-00 08-782606-00 08-782608-00	STD	67.20	1.500		001 IF CR P	IKA
	0.40mm		1.750		026 P	STD
	0.60mm		3.947		712 CR	ST

500 0.5	01/65→12/75	110 F.000	2cyl. 499cc	13kW (18PS)	5
TD871					

500 0.5 500 Estate 0.5	01/65→12/75 01/60→12/66	120.000	2cyl. 499cc	13kW (18PS)	5
TD873					

08-527600-00 08-527606-00 08-527608-00 [R46570]	STD	67.40	2.000		001 CR P	GOE12
	0.40mm		2.000		001 P	GOE12
	0.60mm		2.000		023 P	GOE12
			3.960		232 P	GOE12

500 1.3 D Multijet 500 C 1.3 D Multijet Panda 1.3 D Multijet Panda 1.3 D Multijet 4x4 Panda Van 1.3 JTD, Panda Van 1.3 Multijet 4x4	10/07→ 09/09→ 06/06→ 09/10→ 01/06→	169 A1.000	4cyl. 1248cc	55kW (75PS)	6
TD20236					

Doblo Cargo 1.3 JTD 16V Panda 1.3 D Multijet Panda 1.3 D Multijet 4x4 Panda Van 1.3 JTD	05/04→12/06 09/03→ 10/04→ 03/04→	188 A8.000	4cyl. 1248cc	51kW (69PS)	6
TD23866					





Doblo 1.3 JTD 16V	12/04→05/05	188 A9.000	
Doblo Cargo 1.3 JTD 16V	05/04→12/06		4cyl.
Idea 1.3 JTD	01/04→		1248cc 51kW (69PS)
Panda 1.3 D Multijet	09/03→	Diesel	Turbo Intercooled
Panda 1.3 D Multijet 4x4	10/04→		
Panda Van 1.3 JTD	03/04→		
Punto 1.3 JTD 16V	06/03→		
Punto Van 1.3 D Multijet	02/05→10/09		
Punto Van 1.3 JTD	06/03→10/05		
Siena 1.3 JTD	09/03→		TD17456

Doblo 1.3 JTD	05/05→	199 A2.000	
Doblo Cargo 1.3 D Multijet	10/05→01/10		4cyl.
Fiorino Box Body / Estate 1.3 D Multijet	02/08→		1248cc 55kW (75PS)
Punto / Grande Punto 1.3 D Multijet	10/05→	Diesel	Turbo Intercooled
Punto 1.3 D Multijet	03/12→		
Punto Evo 1.3 D Multijet	10/09→02/12		
Punto Evo Box 1.3 D Multijet	03/09→		
Punto Van 1.3 D Multijet	04/08→		
Qubo 1.3 D Multijet	09/08→		TD20240

08-137600-00	STD	69.60	2.000		001 CK P	KV1
08-137606-00	0.40mm		1.500		023 P	F12/F14
[R66830]			2.000		231 P	F12/F14

Doblo Box Body / Estate 1.3 D Multijet,	02/10→	199 A3.000		7
Doblo MPV 1.3 D Multijet, Doblo Platform/ Chassis 1.3 D Multijet			4cyl.	
Idea 1.3 D Multijet	10/05→		1248cc 66kW (89PS)	
Linea 1.3 D Multijet	06/07→		Diesel	Turbo Intercooled
Punto / Grande Punto 1.3 D Multijet	10/05→			
Punto Evo 1.3 D Multijet	10/09→02/12			
Punto Van 1.3 D Multijet	01/10→02/12			TD20241

08-425600-00	STD	69.60	2.000		001 CK P	KV4
08-425606-00	0.40mm		1.500		005 NT	F12/F14
08-425608-00	0.60mm		2.000		231 CR P	GOE13

Fiorino Box Body / Estate 1.3 D Multijet	02/08→	199 A9.000 Euro 5		8
Panda 1.3 D Multijet	02/12→		4cyl.	
Panda 1.3 D Multijet 4x4	06/12→		1248cc 55kW (75PS)	
Punto 1.3 D Multijet	03/12→	Diesel	Turbo Intercooled	
Punto Evo 1.3 D Multijet	10/09→02/12			
Punto Evo Box 1.3 D Multijet	03/09→			
Punto Van 1.3 D Multijet	04/08→			TD23573

500 1.3 D Multijet	12/09→	199 B1.000 Euro 5	
500 C 1.3 D Multijet	09/09→		4cyl.
Fiorino Box Body / Estate 1.3 D Multijet	07/09→		1248cc 70kW (95PS)
Idea 1.3 D Multijet	05/08→	Diesel	Turbo Intercooled
Punto 1.3 D Multijet	03/12→		
Punto Evo 1.3 D Multijet	10/09→02/12		
Punto Van 1.3 D Multijet	03/09→		
Qubo 1.3 D Multijet	07/10→		
Strada 1.3 D Multijet	10/10→		TD23574





Punto / Grande Punto 1.3 D Multijet	07/08→	199 B2.000 Euro 5				
Punto Evo 1.3 D Multijet	07/08→02/12	4cyl. 1248cc 51kW (69PS)				
		Diesel Turbo Intercooled				TD23578
500L 1.3 D Multijet	09/12→	199 B4.000 Euro 5				
Punto / Grande Punto 1.3 D Multijet	04/10→	4cyl. 1248cc 62kW (84PS)				
Punto 1.3 D Multijet	03/12→	Diesel Turbo Intercooled				
Punto Evo 1.3 D Multijet	10/09→02/12					
Punto Van 1.3 D Multijet	03/12→					TD24898
08-435700-00	STD	69.60	1.500		001 GDC P	KV4
08-435706-00	0.40mm		1.500		005 P	F12/F14
			2.000		231 LKZ CR P	GOE13
110 D.000						9
					2cyl. 499cc 13kW (18PS)	
						TD23456
08-528300-00	STD	70.00	2.000		001 IF CR P	GOE12
08-528306-00	0.40mm		2.000		023 P	GOE12
[R47760]			3.500		230 P	GOE12
Uno 1.0						10
	06/89→02/92	156 A2.000			4cyl. 999cc 33-37kW (45-50PS)	
						TD16230
Uno 1.0		156 A2.0157			4cyl. 999cc 33kW (45PS)	
						TD22227
Uno 1.0		156 A2.050			4cyl. 999cc 33kW (45PS)	
						TD22228
Panda 1000	01/86→04/92	156 A2.100 (Fire)			4cyl. 999cc 41kW (55PS)	
Panda 1000 4x4	01/86→07/89					
Panda Van 1000	01/86→02/92					
Uno 45 1.0	06/86→12/93					TD4387
Panda 1000 4x4	05/86→12/94	156 A2.246 (Fire)			4cyl. 999cc 33kW (45PS)	
Panda 1000 i.e. CAT	10/87→08/98					
Panda Van 1000 i.e	08/92→02/04					
Uno 1.0 iE	05/98→08/00					
Uno 45 i.e. 1.0	04/84→10/95					TD994
Panda 1000	01/85→12/92	156 A3.000			4cyl. 999cc 33kW (45PS)	
Panda 1000 4x4	01/86→12/92					
						TD16209
Panda 1100	05/91→12/99	156 C.046 (Fire)			4cyl. 1108cc 37-43kW (50-58PS)	
Panda 1100 Trekking 4x4	10/91→07/04					
Panda Van 1.1	05/91→03/95					
Uno 50 1.1	01/90→12/93					TD4389





Tipo 1.1			01/88→10/91	160 A3.000 (Fire)		
Uno 1.1			01/92→06/06	4cyl.		
Uno 60 1.1			04/89→12/92	1108cc	41kW (55PS)	
TD10189						
08-154200-00	STD	70.00	1.500		001 IF CR P	IKA
08-154206-00	0.40mm		1.500		005 IF P	STD
08-154208-00	0.60mm		3.000		712 CR	ST
<i>[R46910]</i>						
Punto 55 1.1			09/93→09/99	176 A6.000 (Fire)		
				4cyl.		
				1108cc	40kW (54PS)	
11						
TD1036						
Cinquecento 1.1 Sporting			10/94→01/98	176 B2.000 Euro 2 (Fire)		
Panda 1100			02/95→09/03	4cyl.		
Panda 1100 4x4			02/95→07/04	1108cc	40kW (54PS)	
Punto 55 1.1			09/93→09/99			
Punto Van 1.1			04/96→02/00			
Seicento 1.1, Seicento Van 1.1			01/98→01/10			
TD4396						
Panda 1.1			09/03→	187 A1.000 Euro 3 (Fire)		
Panda 1100			02/95→09/03	4cyl.		
Panda Van 1.1			09/00→	1108cc	40kW (54PS)	
Seicento 1.1			01/98→01/10			
TD17847						
08-142300-00	STD	70.00	1.200		001 CR P	KV1
08-142306-00	0.40mm		1.200		005 P	STD
08-142308-00	0.60mm		2.500		236 P	STD
<i>[R48480]</i>						
500 1.2			10/07→	169 A4.000		
500 1.2 LPG			12/10→	4cyl.		
500 C 1.2			09/09→	1242cc	51kW (69PS)	
Panda 1.2			03/10→			
Panda 1.2 4x4			11/09→			
Panda 1.2 LPG			11/10→			
Panda Van 1.2, Panda Van 1.2 4x4,			09/10→			
Panda Van 1.2 LPG, Punto /						
Grande Punto 1.2						
Punto 1.2			03/12→			
Punto Evo 1.2			10/09→02/12			
TD20928						
Punto 60 1.2			01/94→09/99	176 A7.000 (Fire)		
Punto Convertible 60 1.2			04/94→06/00	4cyl.		
				1242cc	44kW (60PS)	
TD1037						
Palio 1.2			06/98→	176 A8.000 (Fire)		
Punto 75 1.2			10/93→09/99	4cyl.		
				1242cc	54kW (73PS)	
TD1038						
Punto 60 1.2			03/94→09/99	176 B1.000		
Punto Convertible 60 1.2			05/95→06/00	4cyl.		
				1242cc	44kW (60PS)	
TD1032						
Punto 60 1.2			03/94→09/99	176 B4.000 (Fire)		
Punto Convertible 60 1.2			05/95→06/00	4cyl.		
				1242cc	54kW (73PS)	
TD1076						





Punto 1.2 16V Punto Convertible 85 16V 1.2	04/97→09/99 04/97→06/00	176 B9.000 (Fire) 4cyl. 1242cc	63kW (86PS)	TD9727
Palio 1.2 Palio Weekend 1.2 Siena 1.2 Strada 1.2	06/98→ 04/96→02/01 09/98→ 06/99→	178 B5.000 Euro 3 (Fire) 4cyl. 1242cc	44kW (60PS)	TD10188
		178 E8.011 4cyl. 1242cc	48-49kW (65-67PS)	TD25005
Palio Weekend 1.2 Palio Weekend 1.2 Biopower Siena 1.2 Bipower	06/04→ 01/04→12/05 06/04→	178 E9.011 4cyl. 1242cc	51-52kW (69-71PS)	TD24630
Palio 1.2 Palio Weekend 1.2	06/98→ 06/99→10/02	178E2.000 (Fire) 4cyl. 1242cc	54kW (73PS)	TD16737
Brava 1.2 16V, Brava 1.2 16V 80 Bravo I 1.2 16V 80 Marea 1.2 16V, Marea Weekend 1.2 16V	12/98→12/02 12/98→10/01 10/98→05/02	182 B2.000 (Fire) 4cyl. 1242cc	60kW (81PS)	TD11807
Palio 1.2 Palio Weekend 1.2 Palio Weekend 1.2 Flex, Palio Weekend 1.2 LPG Panda 1.2 Panda 1.2 4x4 Panda 1.2 Bi-Power / Natural Power Panda 1.2 LPG Panda Van 1.2, Panda Van 1.2 4x4 Punto / Grande Punto 1.2 Punto 1.2 60 Punto 1.2 Bifuel Punto 1.2 Natural Power Punto Van 1.2 60 Siena 1.2 Strada 1.2	07/97→08/02 02/01→ 07/97→08/02 09/03→ 10/04→ 01/07→ 04/09→ 09/04→ 10/05→12/11 09/99→ 08/07→ 09/03→ 02/00→10/09 09/01→ 04/03→	188 A4.000 Euro 3 (Fire) 4cyl. 1242cc	44kW (60PS)	TD12790
Brava 1.2 16V 80, Bravo I 1.2 16V 80 Idea 1.2 16V Palio Weekend 1.2 Punto 1.2 16V 80 Siena 1.2 Stilo 1.2 16V	10/00→10/01 01/04→ 09/01→ 09/99→ 09/01→ 02/02→11/06	188 A5.000 Euro 3 (Fire) 4cyl. 1242cc	59kW (80PS)	TD12791
Punto / Grande Punto 1.2 Punto / Grande Punto 1.2 LPG Punto Evo 1.2	10/05→ 07/08→ 10/09→02/12	199 A4.000 4cyl. 1242cc	48kW (65PS)	TD20242
		223 A3.011 4cyl. 1242cc	59kW (80PS)	TD24997









Doblo 1.2, Doblo Cargo 1.2		03/01→	223 A5.000 Euro 3 (Fire)			
			4cyl.			
			1242cc	44kW (60PS)		
TD15828						
08-138400-00	STD	70.80	1.190		001 P NT	KV1
08-138406-00	0.40mm		1.200		005 P	STD
08-138408-00	0.60mm		2.500		231 P	GOE12
[R66670]						
500 1.4		10/07→	169 A3.000			13
500 C 1.4		09/09→	4cyl.			
Panda 1.4		10/06→	1368cc	74kW (100PS)		
TD20277						
Bravo II 1.4		04/07→	192 B2.000			
Bravo II 1.4 LPG		11/09→	4cyl.			
Idea 1.4		12/03→	1368cc	66kW (89PS)		
Stilo 1.4 16V		03/05→11/06				
Stilo Multi Wagon 1.4 16V		03/05→08/08				TD18571
Punto / Grande Punto 1.4 16V		10/05→	199 A6.000			
Punto 1.4		11/05→	4cyl.			
			1368cc	70kW (95PS)		
TD20929						
			323 B6.600			
			4cyl.			
			1368cc	66kW (89PS)		
TD24955						
500L 1.4		09/12→	843 A1.000 Euro 4 (Fire)			
Doblo Box Body / Estate 1.4,		02/10→	4cyl.			
Doblo MPV 1.4			1368cc	66-70kW (90-95PS)		
Doblo Platform/Chassis 1.4		04/10→				
Idea 1.4 16V		01/04→				
Punto 1.4		09/03→				
Stilo 1.4 16V		01/04→11/06				
Stilo Multi Wagon 1.4 16V		01/04→08/08				TD17978
08-433200-00	STD	72.00	1.000		001 IF NT	ST
08-433206-00	0.40mm		1.200		005 IF P	GOE13
			2.000		231 P	GOE13
TD17978						
Siena 1.4 Bipower		06/04→	178 F3.011			14
			4cyl.			
			1368cc	59-60kW (80-81PS)		
TD24633						
Palio Weekend 1.4		10/05→	199 A1.000			
Siena 1.4		01/07→	4cyl.			
			1368cc	57kW (77PS)		
TD25104						
Punto / Grande Punto 1.4		06/06→	199 A7.000			
Punto 1.4		03/12→	4cyl.			
Punto Evo 1.4		07/09→02/12	1368cc	55kW (75PS)		
TD23572						





Doblo 1.4, Doblo Cargo 1.4	10/05→	350 A1.000		
Fiorino Box Body / Estate 1.4 Natural Power	10/09→		4cyl.	
			1368cc	57-55kW (78-75PS)
Idea 1.4	10/05→			
Idea 1.4 LPG	03/09→			
Linea 1.4	06/07→			
Panda 1.4 Bi-Power / Natural Power	09/10→			
Panda 1.4 Natural Power	01/10→			
Panda Van 1.4 Natural Power	10/09→			
Punto / Grande Punto 1.4	10/05→			
Punto / Grande Punto 1.4 LPG	12/08→			
Punto / Grande Punto 1.4 Natural Power	07/08→			
Punto 1.4, Punto 1.4 Bifuel, Punto 1.4 Natural Power	03/12→			
Punto Evo 1.4	10/09→02/12			
Punto Evo 1.4 LPG	06/09→02/12			
Punto Evo 1.4 Natural Power	10/09→02/12			
Punto Evo Box 1.4, Punto Evo Box 1.4 LPG, Punto Evo Box 1.4 Natural Power	03/09→			
Punto Van 1.4	04/08→			
Punto Van 1.4 LPG, Punto Van 1.4 Natural Power	03/09→			
Qubo 1.4 Natural Power	10/09→			TD20248

08-436800-00	STD	72.00	1.000		001 IF NT	ST
08-436806-00	0.40mm		1.200		026 P	GOE13
			2.000		231 LKZ CR P	KV1
						

Bravo II 1.4 T-Jet	09/07→	198 A1.000		
Punto / Grande Punto 1.4 16V	09/07→07/12		4cyl.	
			1368cc	110kW (150PS)
			Turbo Intercooled	
				TD21045

15

Bravo II 1.4 T-Jet	09/07→	198 A4.000		
Doblo Box Body / Estate 1.4	10/11→		4cyl.	
Doblo Box Body / Estate 1.4 Natural Power	06/10→		1368cc	88kW (120PS)
			Turbo Intercooled	
Doblo MPV 1.4	10/11→			
Doblo MPV 1.4 Natural Power	02/10→			
Linea 1.4 T-Jet, Punto / Grande Punto 1.4 T-Jet	09/07→			
				TD21046

Bravo II 1.4 16V	03/08→	198 A7.000		
			4cyl.	
			1368cc	103kW (140PS)
			Turbo Intercooled	
				TD24595

Punto / Grande Punto 1.4 Abarth	12/07→	199 A8.000		
Punto Evo 1.4 Abarth	07/08→02/12		4cyl.	
			1368cc	114-132kW (155-180PS)
			Turbo Intercooled	
				TD24567

500 1.4 Abarth	08/08→	312 A1.000		
500 C 1.4	01/11→		4cyl.	
500 C 1.4 Abarth	05/11→		1368cc	99kW (135PS)
			Turbo Intercooled	
				TD21036

500 1.4 Abarth	08/08→	312 A3.000		
500 C 1.4 Abarth	09/09→		4cyl.	
			1368cc	103-132kW (140-180PS)
			Turbo Intercooled	
				TD24772





Punto / Grande Punto 1.4 Abarth	12/07→	955 A8.000 Euro 5	4cyl.			
Punto Evo 1.4 Abarth	07/08→02/12		1368cc	120kW (163PS)		
			Turbo Intercooled			TD24767

08-438300-00	STD	72.00	1.200		021 GDC P	KV1
08-438306-00	0.40mm		1.200		026 P	GOE13
			2.000		231 LKZ CR P	GOE13

Palio 1.4	06/03→	834 A1.000	4cyl.			16
			1368cc	70kW (95PS)		
						TD23867

08-138200-00	STD	72.00	1.190		021 P NT	KV1
[R66820]			1.200		055 P	KV1
			1.500		231 CR P	KV1

126 600	09/72→06/77	126 A.000	2cyl.			17
			594cc	17kW (23PS)		
						TD880

08-528400-00	STD	73.50	1.500		001 CR P	KV1
08-528406-00	0.40mm		2.000		023 P	GOE12
08-528408-00	0.60mm		3.947		232 P	GOE12
[R47770]						

Scudo 1.6 D Multijet,	01/07→	9HU	4cyl.			18
Scudo Box 1.6 D Multijet, Scudo Platform/			1560cc	66kW (89PS)		
Chassis 1.6 D Multijet			Diesel	Turbo Intercooled		TD24776

08-424000-00	STD	75.00	3.000		008 CK P	KV1
08-424007-00	0.50mm		1.950		005 P	F12/F14
08-424008-00	0.60mm		2.500		231 LKZ CR P	GOE12

127 1.0 Sport	07/78→02/82	127 A1.000	4cyl.			19
			1049cc	51kW (69PS)		
						TD4345

127 1.3 Sport	12/81→05/83	127 A3.000	4cyl.			
			1297cc	53kW (72PS)		
						TD4415

Ritmo I 60 1.0	09/78→09/82	127 A6.000	4cyl.			
			1049cc	44kW (60PS)		
						TD4347





131 1.3 Mirafiori	10/74→09/81	131 A6.000	4cyl.				
131 Familiare/Panorama 1.3 Mirafiori	03/75→12/78		1297cc	40kW (54PS)			TD897

131 1.3 Super Mirafiori	03/78→12/80	131 B.000	4cyl.				
			1297cc	60kW (81PS)			TD899

08-269700-00	STD	76.00	1.500		001 IF CR P	IKA	
08-269704-00	0.20mm				026 P	GOE13	
08-269706-00	0.40mm		2.000		712 CR	ST	
08-269710-00	0.80mm		3.947				
[R47260]							

127 1.3 Diesel	04/81→12/86	127 A5.000	4cyl.				20
127 Panorama 1.3 D	06/81→12/86		1301cc	33kW (45PS)			
147 1.3 D	07/82→06/84						
Elba 1.3 D	04/86→10/92	Diesel					
Fiorino 1.3 D	03/82→12/87						
Fiorino Pick Up 1.3 D	05/84→12/88						
Uno 1.3 Super Diesel	06/83→03/92						TD4346

Uno 1.3 Super Diesel	06/83→03/92	146 B1.000	4cyl.				
			1301cc	33kW (45PS)			TD948
		Diesel					

Panda 1300 D	04/86→12/92	156 A5.000	4cyl.				
			1301cc	33kW (45PS)			TD999
		Diesel					

08-215200-10	STD	76.00	2.500		008 CR P	KV1	
08-215206-10	0.40mm				005 P	STD	
08-215208-10	0.60mm		2.000		231 CR P	STD	
08-215211-10	1.00mm		3.000				
[R47020]							









126 650	07/77→09/87	126 A1.000	2cyl.				21
			652cc	18kW (24PS)			TD4343

126 650	07/77→09/00	126 A1.048	2cyl.				
			652cc	18kW (24PS)			TD881

126 650	01/83→06/96	141 A.000	2cyl.				
Panda 650	01/82→07/04		652cc	22kW (30PS)			TD9385

08-785500-00	STD	77.00	1.500		001 IF CR P	IKA	
08-785506-00	0.40mm				005 P	STD	
08-785507-00	0.50mm		2.000		712 CR	ST	
08-785508-00	0.60mm		3.947				
[R46740]							



Uno 70 TD 1.4		10/86→10/90	146 B.000	4cyl. 1367cc 51-53kW (69-70PS) Diesel Turbo Intercooled	22
				TD947	
Uno 70 TD 1.4		10/86→10/90	146 B3.000	4cyl. 1367cc 51-53kW (69-70PS) Diesel Turbo Intercooled	TD950
08-783200-00	STD	78.00	2.500	 008 MOL P	KV1
[R47090]			2.000	 005 IWU P	STD
			3.000	 231 CR P	STD
Bravo II 1.6 D Multijet		03/08→	198 A2.000	4cyl. 1598cc 88kW (120PS) Diesel Turbo Intercooled	23
				TD21047	
Punto / Grande Punto 1.6 D Multijet		07/08→	955 A3.000 Euro 5	4cyl. 1598cc 88kW (120PS) Diesel Turbo Intercooled	TD23575
Punto Evo 1.6 D Multijet		10/09→02/12			
08-429300-00	STD	79.50	2.000	 001 GDC P	KV4
			1.750	 026 P	F12/F14
			2.000	 231 LKZ CR P	GOE13
				 	
124 1500		01/71→07/75	124 AC.000	4cyl. 1438cc 66kW (89PS)	24
124 Coupe 1400 Sport		06/67→10/72			TD13413
124 Spider 1500 Sport		01/66→12/72			
124 Familiare 1.4		09/67→05/71	124 B.0000	4cyl. 1438cc 51kW (69PS)	TD18853
124 1400		12/68→12/72	124 B2.000	4cyl. 1438cc 59kW (80PS)	TD13412
124 1500		01/73→07/75			
125 1.6		07/67→03/74	125 A.000	4cyl. 1608cc 66kW (89PS)	TD878
125 1.6		05/69→10/73	125 B.000	4cyl. 1608cc 74kW (100PS)	TD879
126 700		09/87→06/96	126 A2.000	2cyl. 704cc 18kW (24PS)	TD4342
126 700		09/87→06/96	126 A2.048	2cyl. 704cc 18kW (24PS)	TD4344











128 1.1 128 Familiare 1.1	03/69→12/84 10/69→10/82	128 A.000	4cyl. 1116cc	33-48kW (45-65PS)	TD888
128 1.1 128 Familiare 1.1	02/75→09/81 02/75→02/81	128 A.048	4cyl. 1116cc	33kW (45PS)	TD5378
128 Coupe 1.1	03/72→02/81	128 AC5.000	4cyl. 1116cc	48kW (65PS)	TD891
132 1600 GL	01/72→12/77	132 A.000	4cyl. 1592cc	72kW (98PS)	TD19053
124 Coupe 1600 Sport 124 Spider 1600 Sport	08/72→12/75 01/69→12/74	132 AC.000	4cyl. 1592cc	74-81kW (100-110PS)	TD907
132 1.6	04/72→01/76	132 BB OA O	4cyl. 1585cc	72kW (98PS)	TD6825
Ritmo II 60 1.1 Uno 55 1.1	10/82→12/87 01/83→08/89	138 B.000	4cyl. 1116cc	41kW (55PS)	TD923
Cinquecento 0.7	12/91→01/96	170 A.000	2cyl. 704cc	22kW (30PS)	TD1028
Cinquecento 0.7 i	07/94→01/98	170 A.046	2cyl. 704cc	22kW (30PS)	TD15809
08-203100-00	STD	80.00	1.500	001 IF CR P	IKA
08-203104-00	0.20mm			026 P	STD
08-203106-00	0.40mm		2.000	232 P	STD
08-203108-00	0.60mm				
08-203110-00	0.80mm		3.947		
08-203111-00	1.00mm				
[R47750]					
Uno 1.3 Turbo i.e.	04/85→08/89	146 A2.000	4cyl. 1301cc	77kW (105PS) Turbo Intercooled	25 TD4373
Uno 1.3 Turbo i.e.	01/87→12/87	146 A2.146	4cyl. 1301cc	77kW (105PS) Turbo Intercooled	TD938













Uno 1.3 Turbo i.e.			09/89→03/91	146 A2.246		4cyl. 1301cc 77kW (105PS) Turbo Intercooled	TD932
08-780700-00	STD	80.50	1.500		001 MOL P		KV1
			2.000		005 IWU P		STD
			3.947		231 CR P		STD
Uno 1.4			01/89→12/91	146 A8.000			26
Uno 1.4 Turbo			10/88→08/00		4cyl.		
Uno 1.4 Turbo i.e.			12/89→12/96		1372cc 82-87kW (112-118PS) Turbo Intercooled	TD18372	
Uno 1.4 Turbo i.e.			09/89→09/93	146 A8.046		4cyl. 1372cc 82kW (111PS) Turbo Intercooled	TD944
Punto 1.4 GT Turbo			01/94→09/96	176 A4.000		4cyl. 1372cc 98kW (133PS) Turbo Intercooled	TD1034
Punto 1.4 GT Turbo			09/96→09/99	176 B6.000		4cyl. 1372cc 98kW (133PS) Turbo Intercooled	TD5492
08-524900-00	STD	80.50	1.500		001 MOL P		KV1
<i>[R60150]</i>			2.000		005 IWU P		GOE12
			3.000		231 CR P		GOE12
Uno 70 i.e. 1.4			09/89→12/93	146 C1.000		4cyl. 1372cc 51-53kW (69-72PS)	27 TD18821
Fiorino Box 1.4			11/92→10/96	146 C5.000		4cyl. 1372cc 49kW (67PS)	TD6816
Fiorino Box 70 i.e. 1.4			05/94→05/01				
Fiorino Box 70 i.e. 1.4, Fiorino Pick Up 1.4			05/94→05/01	146 D5.000		4cyl. 1372cc 49kW (67PS)	TD6817
Tempra 1.4 i.e., Tempra S.W. 1.4 i.e. Tipo 1.4 i.e.			03/91→08/96 05/89→04/95	159 A2.000		4cyl. 1372cc 53kW (72PS)	TD9728
Tipo 1.4			07/87→12/89	160 A1.000		4cyl. 1372cc 53kW (72PS)	TD1015











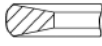

Tempra 1.4 i.e.			03/92→08/96	160 A1.046		
Tempra S.W. 1.4 i.e.			10/92→08/96		4cyl.	
Tipo 1.4 i.e.			05/89→04/95		1372cc	51kW (69PS)
Uno 1.4			07/91→07/96			
Uno 70 i.e. 1.4			09/89→12/93			TD1016
<hr/>						
Tipo 1.4			07/87→12/89	160 A1.048		
Uno 70 S 1.4			09/89→10/92		4cyl.	
					1372cc	52kW (71PS)
						TD4393
<hr/>						
Palio 1.4			04/96→	178 B2.000		
Palio Weekend 1.4			07/97→08/01		4cyl.	
Siena 1.4			04/96→		1372cc	51kW (69PS)
						TD16173
<hr/>						
Palio 1.4 CAT, Siena 1.4 CAT			04/96→	178B2.016		
					4cyl.	
					1372cc	51kW (69PS)
						TD16174
<hr/>						
Tempra 1.4 i.e.			03/92→08/96	836 A4.000		
Tempra S.W. 1.4 i.e.			10/92→08/96		4cyl.	
Tipo 1.4 i.e.			05/89→04/95		1372cc	51kW (69PS)
						TD893
<hr/>						
08-783600-00	STD	80.50	1.500		001 IF CR P	IKA
08-783606-00	0.40mm					
08-783608-00	0.60mm		1.750		026 P	STD
08-783610-00	0.80mm					
08-783611-00	1.00mm		3.000		712 CR	ST
<i>[R46940]</i>						
08-786700-00	STD	80.50	1.200		001 CR	ST
01/1995→			1.500		005 IWU P	STD
			3.000		231 P	STD
<hr/>						
Brava 1.6 16V			01/99→12/02	182 B6.000 Euro 3		
Bravo I 1.6			09/00→02/02		4cyl.	
Doblo 1.6			09/02→		1596cc	76kW (103PS)
Doblo 1.6 16V			10/01→			
Doblo 1.6 Natural Power			09/02→			
Doblo Cargo 1.6 16V			10/01→			
Doblo Cargo 1.6 Natural Power			09/02→			
Marea 1.6, Marea Weekend 1.6			09/00→08/02			
Multipla 1.6			09/00→06/10			
Multipla 1.6 16V			04/02→06/10			
Multipla 1.6 16V Bipower			10/01→06/10			
Palio Weekend 1.6 16V			02/01→			
Siena 1.6			11/00→			
Stilo 1.6 16V			10/01→11/06			
Stilo Multi Wagon 1.6 16V			01/03→08/08			TD16166
<hr/>						
08-124800-00	STD	80.50	1.200		001 P NT	KV1
08-124806-00	0.40mm					
08-124808-00	0.60mm		1.200		005 IWU P	KV1
			2.000		231 P	STD
<i>[R60590]</i>						

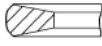

Coupe 2.0 20V Turbo		08/96→08/00	175 A3.000	5cyl. 1998cc 162kW (220PS) Turbo Intercooled	29	TD5491
08-529300-00	STD	82.00	1.200	 001 NT		KV1
08-529306-00	0.40mm		1.500	 005 IWU P		GOE12
[R60130]			3.000	 231 P		GOE12
Bravo I 2.0 HGT 20V		10/95→07/98	182 A1.000 Euro 2	5cyl. 1998cc 108kW (147PS)	30	TD4397
Coupe 2.0 20V		08/96→04/98				
Marea 2.0 150 20V,		09/96→04/99				
Marea Weekend 2.0 150 20V						
Brava 1.4 12 V		10/95→08/98	182 A3.000	4cyl. 1371cc 59kW (80PS)		TD4399
Bravo I 1.4		10/95→10/01				
Marea 1.4 80 12V,		09/96→05/02				
Marea Weekend 1.4 80 12V						
Brava 1.4, Bravo I 1.4		10/95→10/01	182 A5.000	4cyl. 1371cc 59kW (80PS)		TD4401
Coupe 2.0 20V		04/98→08/00	182 B3.000 Euro 2	5cyl. 1998cc 113kW (154PS)		TD11789
Brava 2.0		09/98→08/00	182 B7.000 Euro 2	5cyl. 1998cc 113kW (154PS)		TD15498
Bravo I 2.0 HGT 20V		07/98→10/01				
Marea 2.0 155 20V		04/99→01/01				
Marea Weekend 2.0 155 20V		04/99→02/03				
08-787000-00	STD	82.00	1.500	 001 CR P		KV1
08-787006-00	0.40mm		1.500	 026 P		STD
[R48590]			3.000	 712 CR		ST
Brava 1.8 GT 16V, Bravo I 1.8 GT		10/95→10/01	182 A2.000 Euro 2	4cyl. 1747cc 96kW (131PS)	31	TD4398
Marea 1.8 115 16V,		09/96→05/02				
Marea Weekend 1.8 115 16V						
Barchetta 1.8 16V		04/95→05/05	183 A1.000 Euro 2	4cyl. 1747cc 96kW (131PS)		TD4405
Coupe 1.8 16V		03/96→08/00				
Punto 1.8 130 HGT		09/99→				
Marea 2.0 150 20V,		01/01→05/02	185 A8.000 Euro 3	5cyl. 1998cc 113kW (154PS)		TD15830
Marea Weekend 2.0 150 20V						
08-118000-00	STD	82.00	1.190	 001 NT		KV1
08-118006-00	0.40mm		1.200	 005 IWU P		IKA
08-118008-00	0.60mm		2.000	 231 P		STD
[R60000]						



Brava 1.9 TD 100 S, Bravo I 1.9 TD 100 S		03/96→10/01	182 A7.000				32
Marea 1.9 TD 100, Marea Weekend 1.9 TD 100		09/96→05/02	4cyl. 1910cc 55kW (75PS)	Diesel	Turbo Intercooled	TD4403	
Brava 1.9 TD 75 S, Bravo I 1.9 TD 75 S		03/96→10/01	182 A8.000				
Marea 1.9 TD 75, Marea Weekend 1.9 TD 75		09/96→05/02	4cyl. 1910cc 55kW (75PS)	Diesel	Turbo Intercooled	TD4404	
Marea 2.4 TD 125, Marea Weekend 2.4 TD 125		09/96→04/99	185 A2.000				
			5cyl. 2387cc 91kW (124PS)	Diesel	Turbo Intercooled	TD4406	
08-523100-00	STD	82.00	3.000		008 CK P	KV1	
08-523108-00	0.60mm				005 IWU P	GOE12	
[R49860]					231 CR P	GOE12	
Brava 1.9 JTD		01/01→12/02	182 B4.000 Euro 2				33
Brava 1.9 JTD 105, Bravo I 1.9 JTD 105		12/98→10/01	4cyl.				
Marea 1.9 JTD 105		04/99→01/01	1910cc 77kW (105PS)	Diesel	Turbo Intercooled	TD11168	
Marea Weekend 1.9 JTD 105		04/99→05/02					
Multipla 1.9 JTD 105		04/99→06/10					
Marea 2.4 JTD 130, Marea Weekend 2.4 JTD 130		04/99→05/02	185 A6.000 Euro 2				
			5cyl. 2387cc 96kW (131PS)	Diesel	Turbo Intercooled	TD18145	
Marea 2.4 JTD 130, Marea Weekend 2.4 JTD 130		04/99→05/02	839 A5.000 Euro 2				
			5cyl. 2387cc 100kW (136PS)	Diesel	Turbo Intercooled	TD14408	
08-108000-00	STD	82.00	3.000		008 CK P	KV1	
08-108008-00	0.60mm				026 P	F12/F14	
[R49870]					231 CR P	GOE13	
Brava 1.9 JTD, Bravo I 1.9 JTD		09/00→10/01	182 B9.000				34
Doblo 1.9 JTD, Doblo Cargo 1.9 JTD		10/01→	4cyl.				
Marea Weekend 1.9 TD 100		09/96→05/02	1910cc 74-77kW (100-105PS)	Diesel	Turbo Intercooled	TD16399	
Multipla 1.9 JTD 115		07/02→06/10	186 A8.000				
			4cyl. 1910cc 85kW (116PS)	Diesel	Turbo Intercooled	TD18309	
Stilo 1.9 JTD		10/01→11/06	192 A1.000				
Stilo Multi Wagon 1.9 JTD		01/03→08/08	4cyl. 1910cc 85kW (116PS)	Diesel	Turbo Intercooled	TD16398	
Croma 1.9 D Multijet		06/05→	939 A1.000				
Punto / Grande Punto 1.9 D Multijet		10/05→	4cyl. 1910cc 88kW (120PS)	Diesel	Turbo Intercooled	TD18448	
08-124000-00	STD	82.00	2.000		001 CK P	KV1	
08-124006-00	0.40mm				026 P	F12/F14	
08-124008-00	0.60mm				231 CR P	GOE12	
06/2000→							
[R60580]							



Marea 1.9 JTD 110, Marea Weekend 1.9 JTD 110 Multipla 1.9 JTD 110	01/01→05/02 03/01→07/02	186 A6.000 Euro 3 4cyl. 1910cc 73kW (99PS) Diesel Turbo Intercooled	35
Palio Weekend 1.9 JTD Punto 1.9 JTD 80 Strada 1.9 JTD	09/01→ 09/99→ 04/03→	188 A2.000 Euro 3 4cyl. 1910cc 73kW (99PS) Diesel Turbo Intercooled	TD15831 TD12788
Punto 1.9 DS 60 Punto Van 1.9 D 60	09/99→ 02/00→10/09	188 A3.000 4cyl. 1910cc 44kW (60PS) Diesel	TD12789
Punto 1.9 JTD Punto Van 1.9 JTD	10/01→ 02/00→10/09	188 A7.000 Euro 3 4cyl. 1910cc 73kW (99PS) Diesel Turbo Intercooled	TD16409
Stilo 1.9 JTD Stilo Multi Wagon 1.9 JTD	02/02→11/06 01/03→08/08	192 A3.000 Euro 3 4cyl. 1910cc 73kW (99PS) Diesel Turbo Intercooled	TD16397
Doblo 1.9 D, Doblo Cargo 1.9 D, Palio Weekend 1.9 D Siena 1.9 D Strada 1.9 D	03/01→ 11/00→ 12/00→	223 A6.000 4cyl. 1910cc 44kW (60PS) Diesel	TD15829
08-107900-00 STD 08-107908-00 0.60mm →06/2000 [R49850]	82.00 2.500 2.000 2.000	 	001 CR P 026 P 231 CR P KV1 F12/F14 GOE13
08-124000-00 STD 08-124006-00 0.40mm 08-124008-00 0.60mm 06/2000→ [R60580]	82.00 2.000 2.000 2.000	 	001 CK P 026 P 231 CR P KV1 F12/F14 GOE12
Doblo 1.9 D Multijet Doblo Cargo 1.9 JTD Multijet Multipla 1.9 JTD	10/05→ 12/06→ 04/02→06/10	186A9.000 4cyl. 1910cc 88kW (120PS) Diesel Turbo Intercooled	36 TD19306
Idea 1.9 JTD Punto 1.9 JTD	01/04→ 06/03→	188 B2.000 4cyl. 1910cc 74kW (100PS) Diesel Turbo Intercooled	TD18291
Bravo II 1.9 D Multijet Stilo 1.9 D Multijet Stilo Multi Wagon 1.9 D Multijet	04/07→ 09/05→11/06 09/05→08/08	192 A8.000 4cyl. 1910cc 88kW (120PS) Diesel Turbo Intercooled	TD20238
Punto / Grande Punto 1.9 D Multijet	10/05→	199 A5.000 4cyl. 1910cc 96kW (131PS) Diesel Turbo Intercooled	TD20762
Doblo 1.9 JTD, Doblo Cargo 1.9 JTD	07/03→	223 A7.000 4cyl. 1910cc 77kW (105PS) Diesel	TD18318





Stilo 1.9 JTD			10/01→11/06	937A7.000			
Stilo Multi Wagon 1.9 JTD			01/03→08/08		4cyl.		
					1910cc	85kW (116PS)	
				Diesel	Turbo Intercooled		TD19307
Sedici 1.9 D Multijet,			06/06→	D19AA			
Sedici 1.9 D Multijet 4x4					4cyl.		
					1910cc	88kW (120PS)	
				Diesel			TD20930
08-124000-00	STD	82.00	2.000		001 CK P		KV1
08-124006-00	0.40mm						
08-124008-00	0.60mm		2.000		026 P		F12/F14
[R60580]			2.000		231 CR P		GOE12
Barchetta 1.8 16V			04/95→05/05	188 A6.000 Euro 3			
Punto 1.8 130 HGT			09/99→		4cyl.		
					1747cc	96kW (131PS)	
							37
							TD16408
Stilo 1.8 16V			10/01→11/06	192 A4.000 Euro 3			
Stilo Multi Wagon 1.8 16V			01/03→08/08		4cyl.		
					1747cc	96-98kW (130-133PS)	
							TD16395
08-145400-00	STD	82.00	1.200		021 NT		ST
08-145406-00	0.40mm						
[R67927]			1.200		005 IF P		KV1
			2.000		231		GOE12
Stilo 1.9 JTD			01/04→11/06	192 A5.000			
Stilo Multi Wagon 1.9 JTD			01/04→08/08		4cyl.		
					1910cc	103kW (140PS)	
				Diesel	Turbo Intercooled		38
							TD17980
Stilo 1.9 JTD			04/04→11/06	192 B1.000			
Stilo Multi Wagon 1.9 JTD			04/04→08/08		4cyl.		
					1910cc	100kW (136PS)	
				Diesel	Turbo Intercooled		TD18944
Stilo 1.9 JTD			09/03→11/06	937A4.000			
Stilo Multi Wagon 1.9 JTD			09/03→08/08		4cyl.		
					1910cc	93kW (126PS)	
				Diesel	Turbo Intercooled		TD18943
Bravo II 1.9 D Multijet			04/07→	937A5.000			
Stilo 1.9 D Multijet			09/05→11/06		4cyl.		
Stilo Multi Wagon 1.9 D Multijet			09/05→08/08		1910cc	110kW (150PS)	
				Diesel	Turbo Intercooled		TD18929
Croma 1.9 D Multijet			06/05→	939A2.000			
					4cyl.		
					1910cc	110kW (150PS)	
				Diesel	Turbo Intercooled		TD18449













Croma 2.4 D Multijet		06/05→	939A3.000		5cyl. 2387cc 147kW (200PS)	
			Diesel	Turbo Intercooled		TD18450
08-146100-00	STD	82.00	2.000		001 CK P	KV1
08-146106-00	0.40mm		2.000		023 IWU P	F12/F14
08-146108-00	0.60mm		2.000		231 CK P	GOE12
<i>[R67925]</i>						
Scudo Box 1.9 D, Scudo Combinato 1.9 D		04/98→12/06	WJZ (DW8)		4cyl. 1868cc 51kW (69PS)	39
			Diesel			TD16300
08-104000-00	STD	82.20	2.000		001 CK P	KV1
08-104008-00	0.60mm		2.000		026 P	STD
			3.000		231 CR P	STD
<i>[R60230]</i>						
Ritmo II 60 Diesel 1.7		05/85→12/87	138 C.000		4cyl. 1677cc 44kW (60PS)	40
			Diesel			TD925
Elba 1.7 D		04/89→12/96	146 B2.000		4cyl.	
Fiorino Box 1.7 D		01/88→10/99			1697cc 46kW (63PS)	
Fiorino Box 60 1.7 D		05/88→10/96	Diesel			
Fiorino Pick Up 1.7 D		10/93→10/99				
Uno 1.7 D		11/94→08/00				
Uno 60 Diesel 1.7		09/89→12/93				
Uno Box 1.7 D		02/88→02/92				TD949
Duna 1.7 DS, Duna Weekend 1.7 DS		01/87→12/91	149 B3.000		4cyl.	
Fiorino 1.7 D		12/87→12/90			1697cc 42kW (57PS)	
Fiorino Box 60 1.7 D		05/88→05/00	Diesel			
Fiorino Pick Up 1.7 D		05/88→10/99				
Penny Van 1.7 D		01/86→12/90				
Regata 60 Diesel 1.7		05/85→03/89				
Regata Weekend 60 Diesel 1.7		01/84→12/89				
Ritmo II 60 Diesel 1.7		05/85→12/87				
Uno 60 Diesel 1.7		07/86→08/89				TD967
Tipo 1.7 D		01/88→10/95	149 B4.000		4cyl.	
					1697cc 44kW (60PS)	
			Diesel			TD968
Uno Box 1.7 D		02/88→02/92	149 B4.046		4cyl.	
					1697cc 42-44kW (57-60PS)	
			Diesel			TD969





Punto 1.7 D			04/94→09/97	176 B3.000			
Punto Van 1.7 D			04/96→02/00		4cyl.		
					1697cc	42kW (57PS)	
				Diesel			TD9477
08-782300-00	STD	82.60	2.500		008 MOL P		KV1
08-782308-00	0.60mm		2.000		026 P		STD
→eng.690650			4.000		231 CR P		STD
[R47120]							
08-785400-00	STD	82.60	2.500		008 MOL P		KV1
08-785408-00	0.60mm		2.000		005 IFU P		STD
eng.690651→			3.000		231 CR P		STD
[R47130]							
Fiorino Box 1.7 TD			11/96→05/00	146 D7.000			
Fiorino Box 65 1.7 TD,			01/97→05/01		4cyl.		41
Fiorino Pick Up 1.7 TD					1697cc	46kW (63PS)	
				Diesel	Turbo		TD9472
Tempra 1.9 TD			05/90→08/96	160 A6.000			
Tempra S.W. 1.9 TD			07/91→02/95		4cyl.		
Tipo 1.9 TD			09/90→04/95		1929cc	66kW (89PS)	
				Diesel	Turbo Intercooled		TD4394
Tipo 1.9 TD			09/90→04/95	160 A6.046			
					4cyl.		
					1929cc	66kW (89PS)	
				Diesel	Turbo Intercooled		TD1022
Tempra 1.9 TD			07/92→08/96	160 B6.046			
Tempra S.W. 1.9 TD, Tipo 1.9 TD			03/92→06/93		4cyl.		
					1929cc	66kW (89PS)	
				Diesel	Turbo Intercooled		TD1025
Tempra 1.9 TD			05/90→08/96	160 D1.000			
Tempra S.W. 1.9 TD			07/91→02/95		4cyl.		
Tipo 1.9 TD			09/90→04/95		1929cc	68kW (92PS)	
				Diesel	Turbo Intercooled		TD1026
Palio Weekend 1.7 TD			04/96→03/01	176 A3.000			
Punto 1.7 TD			01/94→09/99		4cyl.		
Siena 1.7 TD			02/06→		1697cc	51-53kW (69-72PS)	
Strada 1.7 TD			06/99→	Diesel	Turbo		TD1033
Punto 1.7 TD			01/94→09/99	176 A5.000			
Punto Van 1.7 TD			04/96→02/00		4cyl.		
					1697cc	52kW (71PS)	
				Diesel	Turbo		TD1035
Punto 1.7 TD, Punto Van 1.7 TD			09/96→09/99	176 B7.000			
					4cyl.		
					1697cc	46kW (63PS)	
				Diesel	Turbo		TD5493
08-783800-00	STD	82.60	3.000		008 MOL P		KV1
08-783808-00	0.60mm		2.000		005 IFU P		F12/F14
[R47150]			3.000		231 CR P		STD

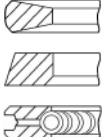

Regata 65 Diesel 1.9, Regata Weekend 65 Diesel 1.9 Tempra 1.9 D, Tempra S.W. 1.9 D, Tipo 1.9 D	04/84→07/89 07/91→08/96	149 A1.000	4cyl. 1929cc	48kW (65PS)	42 TD4378
Ducato Box 1.9 D Ducato Panorama 1.9 D Ducato Platform/Chassis 1.9 D Talento Box 1.9 D, Talento Bus 1.9 D, Talento Platform/Chassis 1.9 D	01/88→03/94 02/87→03/94 01/88→08/90 03/89→03/94	149 B1.000	4cyl. 1929cc	52kW (71PS)	TD963
Uno 1.9 D	09/89→03/94	149 B5.046	4cyl. 1929cc	44kW (60PS)	TD9602
Brava 1.9 D, Bravo I 1.9 D Tempra 1.9 D, Tempra S.W. 1.9 D, Tipo 1.9 D	10/95→10/01 07/91→08/96	160 A7.000	4cyl. 1929cc	48kW (65PS)	TD1023
Ducato Box 1.9 D Ducato Bus 1.9 D Combinato Ducato Platform/Chassis 1.9 D	03/94→04/02 06/95→04/02 03/94→04/02	230 A2.000	4cyl. 1929cc	60kW (81PS)	TD862
Regata 80 Turbo Diesel 1.9, Regata Weekend 80 Turbo Diesel 1.9 Ritmo II 80 Turbo Diesel 1.9	05/86→07/89 12/85→12/87	831 D1.000	4cyl. 1929cc	62kW (84PS)	TD4410

08-785400-00 08-785408-00 eng.690651→ [R47130]	STD 0.60mm	82.60	2.500 2.000 3.000	 008 MOL P 005 IFU P 231 CR P	KV1 STD STD
---	---------------	-------	-------------------------	---	-------------------

Uno 1.9D	01/86→	154 B.000	4cyl. 1929cc	68kW (92PS)	43 TD21460
Croma 1900 Turbo D i.d.	05/89→10/92	154 C6.000	4cyl. 1929cc	84kW (114PS)	TD9621

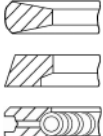
08-783400-00 [R47190]	STD	82.60	2.500 2.000 4.000	 008 MOL P 005 IWU P 231 CR P	KV1 IKA STD
--------------------------	-----	-------	-------------------------	--	-------------------

Ducato Box 1.9 TD, Ducato Bus 1.9 TD Panorama/Combinato, Ducato Platform/Chassis 1.9 TD	03/94→04/02	230 A3.000	4cyl. 1929cc	60kW (81PS)	44 TD5481
Ducato Box 1.9 TD CAT, Ducato Bus 1.9 TD Combinato, Ducato Platform/Chassis 1.9 TD CAT	08/94→04/02	230 A4.000	4cyl. 1929cc	60kW (81PS)	TD4407





Ducato Box 1.9 TD, Ducato Panorama 1.9 TD, Ducato Platform/ Chassis 1.9 TD		03/89→03/94	280 A1.000	4cyl. 1929cc	60kW (81PS)		
				Diesel	Turbo		TD1043
08-141400-00 →eng.0675108 [R67680]	STD	82.60	3.000		008 MOL P		KV1
			2.000		026 P		STD
			4.000		231 CR P		STD
08-783800-00 08-783808-00 [R47150]	STD 0.60mm	82.60	3.000		008 MOL P		KV1
			2.000		005 IFU P		F12/F14
			3.000		231 CR P		STD
Regata 60 Diesel 1.7 Ritmo II 60 Diesel 1.7		09/83→12/86 10/82→10/85	138 B6.000	4cyl. 1714cc	43kW (58PS)		45
				Diesel			TD922
08-215100-10 08-215108-10 08-215110-10 [R47000]	STD 0.60mm 0.80mm	83.00	2.500		008 MOL P		KV1
			2.000		026 P		STD
			4.000		231 CR P		STD
Bravo II 2.0 D Multijet		09/08→	198 A5.000	4cyl. 1956cc	121kW (165PS)		46
				Diesel			TD24569
Ducato Box 115 Multijet 2, 0 D, Ducato Bus 115 Multijet 2, 0 D, Ducato Platform/Chassis 115 Multijet 2, 0 D		06/11→	250 A1.000 Euro 5	4cyl. 1956cc	85kW (116PS)		
				Diesel	Turbo Intercooled		TD25173
Doblo Box Body / Estate 2.0 D Multijet, Doblo MPV 2.0 D Multijet, Doblo Platform/ Chassis 2.0 D Multijet		02/10→	263 A1.000 Euro 5	4cyl. 1956cc	99kW (135PS)		
				Diesel	Turbo Intercooled		TD24764
Bravo II 2.0 D Multijet		09/08→	844 A2.000	4cyl. 1956cc	121kW (165PS)		
				Diesel	Turbo Intercooled		TD24593
Freemont 2.0 JTD, Freemont 2.0 JTD 4x4		08/11→	939 B5.000	4cyl. 1956cc	100-125kW (140-170PS)		
				Diesel	Turbo Intercooled		TD26620
Freemont 2.0 JTD		08/11→	940 A5.000 Euro 5	4cyl. 1956cc	103kW (140PS)		
				Diesel	Turbo Intercooled		TD26672





Sedici 2.0 D Multijet, Sedici 2.0 D Multijet 4x4		06/06→	D20AA Euro 5		4cyl. 1956cc 99kW (135PS)	
			Diesel	Turbo Intercooled		TD24670
08-436500-00	STD	83.00	1.500		001 GDC P	KV4
08-436506-00	0.40mm		1.500		050 P	F12/F14
			2.000		231 LKZ CK P	GOE13
Scudo Box 1.9 TD Scudo Combinato 1.9 TD		02/98→12/06 02/96→12/06	D8B		4cyl. 1905cc 66kW (89PS)	47
			Diesel	Turbo Intercooled		TD6828
Ulysse 1.9 TD			D8B (XUD9TE)		4cyl. 1905cc 66-69kW (90-94PS)	
			Diesel	Turbo Intercooled		TD21263
Ducato Box 1.9 TD, Ducato Bus 1.9 TD, Ducato Platform/Chassis 1.9 TD		04/98→04/02	DHX (XUD9TE)		4cyl. 1905cc 66kW (89PS)	
Scudo Box 1.9 TD, Scudo Combinato 1.9 TD Eco		02/96→12/06	Diesel	Turbo Intercooled		
Ulysse 1.9 TD		02/95→08/02				TD4352
Scudo Box 1.9 TD, Ulysse 1.9 TD			DHX (XUD9TE)		4cyl. 1905cc 66-69kW (90-94PS)	
			Diesel	Turbo Intercooled		TD21264
08-105500-00	STD	83.00	3.000		008 CK	KV1
08-105507-00	0.50mm		2.000		005 IF NT	IKA
08-105510-00 01/1997→	0.80mm		3.000		231 CR P	STD
[R60140]						
08-325500-00	STD	83.00	3.500		008 MOL P	KV1
08-325507-00 →12/1996	0.50mm		2.000		005 P	STD
			3.000		231 CR P	STD
[R49920]						
Ducato Bus 1.9 D Scudo Box 1.9 D Scudo Combinato 1.9 D		04/98→04/02 02/96→12/06 02/96→04/98	D9B (XUD9/A/B/L/Y)		4cyl. 1905cc 49kW (67PS)	48
			Diesel			TD6827
Ducato Bus 1.9 D		04/98→04/02	D9B (XUD9A)		4cyl. 1905cc 47-52kW (64-71PS)	
			Diesel			TD21265
			DJY (XUD9)		4cyl. 1905cc 50-52kW (68-71PS)	
			Diesel			TD21267





Ducato Box 1.9 D, Ducato Bus 1.9 D, Ducato Platform/Chassis 1.9 D		04/98→04/02	DJY (XUD9A)		4cyl. 1905cc	50kW (68PS)		
			Diesel				TD12748	
08-152000-00	STD	83.00	2.000		001 CR P		KV1	
08-152003-00	0.125mm							
08-152007-00	0.50mm		2.000		005 P		STD	
08-152010-00	0.80mm							
08-152011-00	1.00mm		3.000		231 CR P		STD	
<i>[R66390]</i>								
Ulysse 1.8		05/97→08/02	LFW (XU7 JP)		4cyl. 1762cc	73kW (99PS)		49
							TD10167	
08-323400-00	STD	83.00	1.500		001 P PS		KV1	
<i>[R60190]</i>			1.500		026 P		STD	
			3.000		231 CR P		STD	
242-Serie Box 1.6, 242-Serie Bus 1.6		10/75→07/82	124 B3.000		4cyl. 1585cc	46kW (63PS)		50
							TD6898	
131 1.6		10/74→09/81	131 A1.000		4cyl. 1585cc	55kW (75PS)		
131 Familiare/Panorama 1.6 CL		03/75→12/78					TD896	
131 2.0 Abarth Rally		01/76→07/80	131 B2.000		4cyl. 1995cc	85kW (116PS)		
131 2.0 Racing		06/78→12/81					TD900	
131 1.6		11/76→12/84	131 C2.000		4cyl. 1585cc	45kW (61PS)		
131 Familiare/Panorama 1.6		11/80→04/85					TD4351	
131 1.6 Super		03/78→01/84	131 C3.000		4cyl. 1585cc	45kW (61PS)		
131 Familiare/Panorama 1.6 Super		12/79→12/81					TD904	
131 2.0 Super, 131 Familiare/ Panorama 2.0 Super		01/81→12/84	131 C4.000		4cyl. 1995cc	83-85kW (113-116PS)		
							TD4350	
132 2.0		05/77→06/81	132 C2.000		4cyl. 1995cc	82-84kW (112-115PS)		
132 2.0 GLS		01/76→12/76					TD910	
Argenta 2000		06/78→12/85						
132 2.0 i.e.		01/80→12/82	132 C3.000		4cyl. 1995cc	88-90kW (120-122PS)		
Argenta 2000 i.e.		06/81→07/86					TD4353	
Argenta 2000		06/78→12/85	132 D1.000		4cyl. 1995cc	83kW (113PS)		
							TD4354	





Regata 85 1.6		10/83→06/90	149 A.000	4cyl. 1585cc	60kW (81PS)	TD962
Regata 100 Super 1.6		10/83→12/90	149 A4.000	4cyl.		
Regata Weekend 100 1.6		09/84→12/86		1585cc	74kW (100PS)	TD4380
Ritmo II 100 1.6		01/83→12/87				
Regata 90 i.e. 1.6,		01/87→07/89	149 C2.000	4cyl.		
Regata Weekend 90 i.e. 1.6				1595cc	66kW (89PS)	TD4384
Ritmo I 90 i.e. 1.6		09/85→12/87				
Tipo 1.6 i.e.		02/88→05/91	149 C2.046	4cyl.		
				1585cc	61-77kW (83-105PS)	TD978
Regata 100 Super 1.6		10/83→07/89	149 C3.000	4cyl.		
Regata Weekend 100 i.e. 1.6		01/87→12/90		1595cc	61-76kW (83-103PS)	TD18856
Tipo 2.0		10/90→10/92	159 A5.046	4cyl.		
Tipo 2.0 i.e.		06/90→03/92		1995cc	80-85kW (109-116PS)	TD1011
Tempra 2.0 i.e.		10/90→08/96	159 A6.046	4cyl.		
Tempra S.W. 2.0 i.e.		01/91→03/95		1995cc	83-85kW (113-116PS)	
Tempra S.W. 2.0 i.e. 4x4		03/92→03/95				
Tipo 2.0		10/90→10/92				TD1012
Tipo 2.0 i.e.		03/90→04/95				
08-207600-00	STD	84.00	1.500		001 IF CR P	IKA
08-207604-00	0.20mm				026 P	STD
08-207606-00	0.40mm		2.000		712 CR	ST
08-207608-00	0.60mm		3.947			
[R28906]						
131 1.6 Super Mirafiori		03/79→03/82	131 B1.000	4cyl. 1585cc	72kW (98PS)	51 TD901
124 Spider 1800 Sport		01/72→12/77	132 A.C1.000	4cyl. 1756cc	87kW (118PS)	TD23121
132 1.7 GLS		04/74→01/77	132 B1.000	4cyl. 1756cc	82kW (111PS)	TD906
132 1.7 Special		04/72→01/74				
132 1.6		01/76→12/82	132 C.000	4cyl. 1585cc	72kW (98PS)	TD909
124 Spider 2000		03/82→11/85	132 C3.031	4cyl. 1995cc	76-77kW (103-105PS)	TD908





Argenta 1600	04/81→12/85	132 D.000	4cyl. 1585cc	72kW (98PS)	TD911
Ritmo Bertone Convertible 100 1.6	10/85→12/87	138 AR.000	4cyl. 1585cc	74kW (100PS)	TD919
Ritmo I 105 Sport 1.6	05/81→12/82				
Ritmo II 105 1.6	01/83→12/87				
Ritmo II 90 1.6 i.e.	12/85→12/87				
Ritmo Bertone Convertible 100 1.6	10/85→12/87	138 AR.048	4cyl. 1585cc	74kW (100PS)	TD920
Regata 100 Super 1.6	10/83→12/90	149 A2.000	4cyl. 1585cc	74kW (100PS)	TD4379
Croma 1600	12/85→12/90	154 A.048	4cyl. 1585cc	62kW (84PS)	TD11754
Croma 2000 CHT	12/85→02/89	154 A1.000	4cyl. 1995cc	66kW (89PS)	TD1077
Croma 2000 i.e. Turbo	12/85→06/90	154 A2.000	4cyl. 1995cc	114kW (155PS) Turbo Intercooled	TD1083
Croma 2000 i.e.	10/87→08/96	154 C3.046	4cyl. 1995cc	88kW (120PS)	TD984
Croma 2000 i.e. Turbo	06/87→08/96	154 C4.046	4cyl. 1995cc	113kW (154PS) Turbo Intercooled	TD986
Croma 2000 i.e.	03/87→09/92	834 B.000	4cyl. 1995cc	88kW (120PS)	TD1084
Croma 2000 i.e.	03/86→09/90	834 B.048	4cyl. 1995cc	88kW (120PS)	TD1085





Croma 2000 i.e.		10/87→08/96	834 B.146	4cyl. 1995cc	88kW (120PS)	TD11707
08-207600-00	STD	84.00	1.500		001 IF CR P	IKA
08-207604-00	0.20mm		2.000		026 P	STD
08-207606-00	0.40mm		3.947		712 CR	ST
08-207608-00	0.60mm					
<i>[R28906]</i>						
08-215300-10	STD	84.00	1.500		001 IF CR P	KV1
08-215306-10	0.40mm		2.000		026 P	STD
08-215308-10	0.60mm		3.947		232 P	STD
02/1988→						
<i>[R46970]</i>						
Croma 2000 16V		08/92→08/96	154 E1.000	4cyl. 1995cc	109kW (148PS)	52 TD989
Tempra 1.8 i.e.		03/90→08/96	159 A4.000	4cyl.		
Tempra S.W. 1.8 4x4		07/92→06/93		1756cc	76kW (103PS)	
Tempra S.W. 1.8 i.e.		03/90→08/96				TD1008
Tipo 1.8 i.e.		10/90→04/95				
Tempra 1.8 i.e.		03/92→08/96	159 A4.046	4cyl.		
Tempra S.W. 1.8 i.e.		03/92→12/93		1756cc	76kW (103PS)	
Tipo 1.8 i.e.		10/90→06/93				TD1009
Coupe 2.0 16V Turbo		11/93→08/96	175 A1.000	4cyl. 1995cc	137kW (186PS) Turbo Intercooled	TD4395
Croma 2000 i.e. Turbo		11/86→08/96	834 C.146	4cyl. 1995cc	110-112kW (150-152PS) Turbo Intercooled	TD1064
Tempra 1.8 i.e., Tempra S.W. 1.8 i.e.		09/93→08/96	835 C2.000	4cyl.		
Tipo 1.8 i.e.		04/93→04/95		1756cc	76kW (103PS)	
						TD1068
Coupe 2.0 16V		11/93→08/96	836 A3.000	4cyl.		
Tipo 2.0 i.e. 16V Sport		03/93→04/95		1995cc	109kW (148PS)	
						TD1071
08-142400-00	STD	84.00	1.500		001 IF CK	KV1
08-142406-00	0.40mm		1.500		026 P	STD
<i>[R60030]</i>			3.000		231 P	STD



Ulysse 2.2 JTD	08/02→08/06	4HW (DW12ATED4) 4cyl. 2179cc 94kW (128PS) Diesel Turbo Intercooled	53 TD16790
		4HX (DW12TED4) 4cyl. 2179cc 94-100kW (128-136PS) Diesel Turbo Intercooled	TD22230
Ducato Box 2.0 JTD, Ducato Bus 2.0 JTD Ducato Platform/Chassis 2.0 JTD	10/01→ 07/01→07/06	DW10 (RHV) 4cyl. 1997cc 81kW (110PS) Diesel Turbo Intercooled	TD16406
Scudo Box 2.0 JTD Scudo Combinato 2.0 JTD	12/99→12/06 01/04→12/06	DW10 (RHX) 4cyl. 1998cc 69kW (93PS) Diesel Turbo Intercooled	TD16299
Scudo Box 2.0 JTD Scudo Combinato 2.0 JTD Ulysse 2.0 JTD	12/02→12/06 12/99→12/06 10/99→08/02	DW10 (RHZ) 4cyl. 1997cc 66kW (89PS) Diesel Turbo Intercooled	TD16324
Ulysse 2.0 JTD	05/03→08/06	DW10ATED4 4cyl. 1997cc 79kW (107PS) Diesel Turbo Intercooled	TD18906
Scudo Box 2.0 JTD 16V, Scudo Combinato 2.0 JTD 16V Ulysse 2.0 JTD Ulysse 2.0 JTD 16V	05/99→12/06 08/02→08/06 05/99→08/02	DW10ATED4 (RHS) 4cyl. 1997cc 80kW (109PS) Diesel Turbo Intercooled	TD16789
Scudo Platform/Chassis 2.0 D Multijet	01/07→	DW10BTED4 4cyl. 1997cc 100kW (136PS) Diesel Turbo Intercooled	TD25755
Scudo 2.0 D Multijet, Scudo 2.0 D Multijet 4x4, Scudo Box 2.0 D Multijet, Scudo Box 2.0 D Multijet 4x4, Scudo Platform/Chassis 2.0 D Multijet Ulysse 2.0 D Multijet	01/07→ 05/06→06/11	RHK 4cyl. 1997cc 88kW (120PS) Diesel Turbo Intercooled	TD20267
Scudo 2.0 D Multijet, Scudo Box 2.0 D Multijet, Scudo Platform/ Chassis 2.0 D Multijet Ulysse 2.0 D Multijet	01/07→ 05/06→06/11	RHR 4cyl. 1997cc 100kW (136PS) Diesel Turbo Intercooled	TD20268

08-114700-00	STD	85.00	3.500		008 CK P	KV1
08-114708-00	0.60mm		2.000		005 IFU P	STD
[R60410]			3.000		231 CR P	STD



Ulysse 2.1 TD		03/96 → 10/99		P8C (XUD 11 BTE)			54
				4cyl. 2088cc 81kW (110PS)			
				Diesel Turbo Intercooled			TD960
08-126600-00	STD	85.00	3.000		008 CK P		KV1
08-126608-00	0.60mm				005 IF NT		IKA
[R60670]					231 CR		STD
08-154900-00	STD	85.00	3.000		008 P PS		KV1
08-154908-00	0.60mm				005 P		F12/F14
[R60550]					231 CR P		STD

				4HU Euro 4			55
				4cyl. 2198cc 88kW (120PS)			
				Diesel Turbo Intercooled			TD25655
Ducato Box 100 Multijet 2, 2 D, Ducato Bus 100 Multijet 2, 2 D, Ducato Platform/Chassis 100 Multijet 2, 2 D		07/06 →		4HV Euro 4			
				4cyl. 2198cc 74kW (100PS)			
				Diesel Turbo Intercooled			TD20266
08-427700-00	STD	86.00	2.000		001 IF CK P		KV1
08-427707-00	0.50mm				026 P		GOE13
					231 NT		ST

Ulysse 2.0		06/94 → 08/02		RFU (XU10 J2C)			56
				4cyl. 1998cc 88kW (120PS)			
				Turbo Intercooled			TD4349
Ducato Box 2.0		03/94 → 04/02		RFW (XU10J2)			
Ducato Box 2.0 4x4		11/94 → 04/02		4cyl. 1998cc 88kW (120PS)			
Ducato Bus 2.0 4x4		11/94 → 11/01					
Ducato Bus 2.0 Panorama/Combinato		03/94 → 04/02					
Ducato Platform/Chassis 2.0		06/98 → 04/02					TD6808
Ulysse 2.0 Turbo		06/94 → 08/02		RGX			
				4cyl. 1998cc 108kW (147PS)			
				Turbo Intercooled			TD4355
Ulysse 2.0 16V		05/98 → 09/00		XU10 (RFV)			
				4cyl. 1998cc 99kW (135PS)			
							TD18824
08-154600-00	STD	86.00	1.500		001 IF MO P		IKA
08-154605-00	0.25mm				026 P		STD
08-154608-00	0.60mm				712 CR		ST
[R60210]			3.000				



Ritmo Bertone Convertible 1.3 Ritmo I 65 1.3	10/79→09/83 01/78→09/82	138 A1.000	4cyl. 1302cc	48kW (65PS)	57	TD4368
Ritmo Bertone Convertible 1.5 Ritmo I 75 1.5 Ritmo II 75 1.5	02/83→01/84 01/78→10/82 09/85→12/88	138 A2.000	4cyl. 1498cc	55kW (75PS)		TD916
Ritmo I 75 1.3	01/81→09/82	138 A3.000	4cyl. 1302cc	55kW (75PS)		TD4362
Ritmo Bertone Convertible 85 1.5 Ritmo I 85 1.5	01/80→07/89 01/81→05/87	138 A4.000	4cyl. 1498cc	63kW (86PS)		TD4357
X 1/9 1.5	11/78→12/89	138 AS.000	4cyl. 1499cc	63kW (86PS)		TD4359
Regata 70 1.3 Regata Weekend 70 1.3 Ritmo Bertone Convertible 50 1.3 Ritmo II 70 1.3, Uno 70 1.3	09/83→07/86 01/84→07/89 10/85→12/87 01/83→04/85	138 B2.000	4cyl. 1302cc	50kW (68PS)		TD4363
Regata 85 Super 1.5 Regata Weekend 85 1.5 Ritmo Bertone Convertible 85 1.5 Ritmo II 85 1.5	09/83→04/85 01/84→04/89 03/83→12/86 01/83→12/87	138 B3.000	4cyl. 1498cc	55-61kW (75-83PS)		TD4365
Regata 75 1.5 Regata Weekend 75 1.5	12/83→12/87 09/84→07/89	138 B3.048	4cyl. 1498cc	55kW (75PS)		TD4364
Regata 70 1.3 Ritmo I 70 1.3	09/83→07/89 11/83→08/85	149 A3.000	4cyl. 1302cc	50kW (68PS)		TD958
Regata 70 1.3 Ritmo I 70 1.3 Uno 70 1.3	09/83→07/89 11/83→08/85 05/85→08/89	149 A7.000	4cyl. 1302cc	50kW (68PS)		TD4382
08-209700-00 STD 08-209706-00 0.40mm 08-209708-00 0.60mm [R47780]	86.40	1.500 2.000 3.947	 	001 IF CR P 026 P 712 CR	IKA STD ST	
Premio 1.6 Tempra 1.6 Tempra S.W. 1.6 Tipo 1.6 SX DGT	03/85→12/96 03/90→04/93 12/90→04/93 05/89→10/95	159 A3.000	4cyl. 1581cc	63kW (86PS)	58	TD9787
Tempra 1.6 i.e. Tempra S.W. 1.6 i.e. Tipo 1.6 i.e. Uno 1.6	06/90→07/92 10/90→08/96 07/90→01/93 12/89→12/93	159 A3.046	4cyl. 1585cc	57-62kW (78-84PS)		TD1006
Tempra 1.6 Tempra 1.6 i.e. Tempra S.W. 1.6 i.e. Tipo 1.6 i.e.	04/90→06/93 06/92→08/96 10/92→08/96 10/92→04/95	159 A3.048	4cyl. 1585cc	61kW (82PS)		TD1007





Tipo 1.6		01/88→10/92	160 A2.000	4cyl. 1585cc	61kW (82PS)	TD1019
Punto 1.6		01/94→04/97	176 A9.000	4cyl. 1581cc	65kW (88PS)	TD1039
Punto Convertible 90 1.6		04/94→04/97				
Scudo Box 1.6, Scudo Combinato 1.6		02/96→12/06	220 A 2.000	4cyl. 1581cc	55kW (75PS)	TD6826
Tempra 1.6 i.e.		06/92→08/96	835 C1.000	4cyl. 1581cc	55-57kW (75-78PS)	TD1067
Tempra S.W. 1.6 i.e.		10/90→08/96				
Tipo 1.6 i.e.		10/92→04/95				
08-783700-00	STD	86.40	1.500		001 IF CR P	IKA
08-783706-00	0.40mm		1.750		026 P	STD
08-783708-00	0.60mm		3.000		712 CR	ST
08-783711-00	1.00mm					
[R46950]						
Palio 1.6 16V		04/96→	178 B3.000 Euro 2	4cyl. 1581cc	74-78kW (100-106PS)	59 TD10187
Palio Weekend 1.6 16V		04/96→02/01				
Siena 1.6 16V		09/98→				
Brava 1.6 16V		02/96→10/01	182 A4.000 Euro 2	4cyl. 1581cc	76kW (103PS)	TD4400
Bravo I 1.6 16V		03/96→10/01				
Marea 1.6 100 16V,		09/96→05/02				
Marea Weekend 1.6 100 16V						
Multipla 1.6 100 16V		04/99→06/10				
Brava 1.6 16V, Bravo I 1.6 16V		10/95→10/01	182 A6.000 Euro 2	4cyl. 1581cc	66kW (89PS)	TD4402
Marea 1.6		03/99→08/00	185 A3.000 Euro 2	4cyl. 1581cc	68-76kW (92-103PS)	TD15650
Marea 1.6 100 16V Bipower		04/99→05/02				
Marea 1.6 16V		04/97→02/99				
08-786800-00	STD	86.40	1.500		001 IW CR P	KV1
08-786806-00	0.40mm		1.500		005 IWU P	STD
			3.000		712 CR	ST
[R60100]						
Ducato Box 2.0		07/85→08/90	170 B	4cyl. 1971cc	55kW (75PS)	60 TD4417
Ducato Panorama 2.0		01/86→08/90				
Ducato Platform/Chassis 2.0		07/85→08/90				
Talento Box 2.0, Talento Bus 2.0,		03/89→03/94				
Talento Platform/Chassis 2.0						
Ducato Box 2.0		03/89→08/90	170 D	4cyl. 1971cc	62kW (84PS)	TD5102
Ducato Box 2.0 4x4		06/90→05/94				
Ducato Panorama 2.0		09/88→03/94				
Ducato Panorama 2.0 4x4		06/90→05/94				
Ducato Platform/Chassis 2.0		08/88→03/94				
Ducato Platform/Chassis 2.0 4x4		06/90→05/94				





Ducato Box 2.0			01/82→08/90	XN 1T				
Ducato Panorama 2.0			07/82→05/85		4cyl.			
					1971cc	57kW (77PS)		TD4418
08-316900-00	STD	88.00	1.500		001 IF CR P			IKA
08-316907-00	0.50mm		2.000		026 P			STD
[R66110]			4.000		712 CR			ST
Croma 2500 V6			06/93→08/96	834 G.000				61
					V6cyl.			
					2492cc	121kW (165PS)		TD1066
08-110500-00	STD	88.00	1.500		001 IF CR P			IKA
[R46510]			1.750		026 P			STD
			4.000		712 CR			ST
Ducato Box 2.3 JTD, Ducato Bus 2.3 JTD			04/02→	F1AE 0481 C Euro 3				62
Ducato Platform/Chassis 2.3 JTD			04/02→07/06		4cyl.			
					2287cc	81kW (110PS)		
					Diesel	Turbo Intercooled		TD16407
Ducato Box 120 Multijet 2, 3 D			07/06→	F1AE0481D Euro 4				
Ducato Box 120 Multijet 2, 3 D 4x4			03/10→		4cyl.			
Ducato Bus 120 Multijet 2, 3 D,			07/06→		2286cc	88kW (120PS)		
Ducato Platform/Chassis 120 Multijet 2, 3 D					Diesel	Turbo Intercooled		TD20264
Ducato Box 130 Multijet 2, 3 D,			01/07→	F1AE0481N				
Ducato Platform/Chassis 130 Multijet 2, 3 D					4cyl.			
					2287cc	96kW (131PS)		
					Diesel	Turbo Intercooled		TD24778
Ducato Box 130 Multijet 2, 3 D			08/06→	F1AE0481T				
					4cyl.			
					2286cc	93kW (126PS)		
					Diesel	Turbo Intercooled		TD24632
08-138000-00	STD	88.00	2.500		008 CK P			KV1
08-138006-00	0.40mm		2.000		005 P			F12/F14
08-138008-00	0.60mm		2.500		231 CR P			GOE13
[R66800]								
Ducato 2.5D			01/89→	8140.07				63
					4cyl.			
					2499cc	55kW (75PS)		
					Diesel			FM19101
Ducato Box 2.5 D			03/94→04/02	8140.67				
Ducato Bus 2.5 D Combinato			08/94→04/02		4cyl.			
Ducato Platform/Chassis 2.5 D,			03/94→04/02		2500cc	55kW (75PS)		
Ducato Platform/Chassis 2.5 D 4x4					Diesel	Turbo		TD1052





Ducato Box 2.5 D, Ducato Bus 2.5 D Combinato, Ducato Platform/Chassis 2.5 D, Ducato Platform/Chassis 2.5 D 4x4						8140.67.2700 4cyl. 2499cc 62kW (84PS) Diesel			TD6810
08-425000-00	STD	93.00	3.000		008 CR P				KV1
08-425008-00	0.60mm		2.000		026 P				F12/F14
[R47250]			3.000		231 CR P				STD
Ducato 2.5TD, Ducato 2.5TD 4x4			01/89→12/94		8140.21.201-203 (Sofim) 4cyl. 2445cc 68kW (92PS) Diesel Turbo				64 FM9240
Ducato Box 2.5 TD Ducato Box 2.5 TD 4x4 Ducato Panorama 2.5 TD Ducato Panorama 2.5 TD 4x4 Ducato Platform/Chassis 2.5 TD, Ducato Platform/Chassis 2.5 TD 4x4			07/90→03/94 09/86→03/94 08/90→03/94 01/91→03/94 07/90→03/94		8140.27 (Sofim) 4cyl. 2500cc 70kW (95PS) Diesel Turbo				TD1047
Ducato Box 2.5 TD, Ducato Box 2.5 TD 4x4					8140.27.2100 4cyl. 2500cc 70kW (95PS) Diesel Turbo				TD6800
Ducato Panorama 2.5 TD Ducato Panorama 2.5 TD 4x4, Ducato Platform/Chassis 2.5 TD			01/87→08/90 01/86→08/90		8144.21 (Sofim) 4cyl. 2445cc 68kW (92PS) Diesel Turbo				TD4419
Ducato Panorama 2.5 TD			01/87→08/90		8144.21.220 4cyl. 2445cc 68kW (92PS) Diesel Turbo				TD6803
Croma 2500 TD			12/85→08/89		8144.91 4cyl. 2445cc 76kW (103PS) Diesel Turbo Intercooled				TD1058
Croma 2500 TD			05/89→08/96		8144.97 (Sofim) 4cyl. 2499cc 85kW (116PS) Diesel Turbo Intercooled				TD1061
Croma 2500 TDE			12/91→08/96		8144.97 S (Sofim) 4cyl. 2500cc 85kW (116PS) Diesel Turbo Intercooled				TD1059
Croma 2500 TD			05/89→08/96		8144.97 Y (Sofim) 4cyl. 2500cc 85kW (116PS) Diesel Turbo Intercooled				TD1060
Croma 2500 TD			05/89→08/96		8144.97.2400 4cyl. 2499cc 83-87kW (113-118PS) Diesel Turbo Intercooled				TD22316
08-245200-00	STD	93.00	3.000		008 CR P				KV1
08-245208-00	0.60mm		2.000		005 P				F12/F14
[R47080]			3.000		231 CR P				STD



Daily II	01/89→05/99	8140.27S.3700 Euro 1	4cyl.						65
			2499cc	77kW (105PS)					
		Diesel	Turbo Intercooled						TD20152
Ducato Box 2.5 TD	06/94→08/98	8140.47							
Ducato Box 2.5 TD 4x4	11/94→04/98		4cyl.						
Ducato Box 2.5 TDI	03/94→04/02		2499cc	85kW (116PS)					
Ducato Box 2.5 TDI 4x4	05/98→04/02	Diesel	Turbo Intercooled						
Ducato Bus 2.5 TD	06/94→08/98								
Ducato Bus 2.5 TD 4x4	11/94→04/98								
Ducato Bus 2.5 TDI 4x4	04/97→04/02								
Ducato Bus 2.5 TDI Panorama/Combinato	03/94→04/02								
Ducato Platform/Chassis 2.5 TD	06/94→08/98								
Ducato Platform/Chassis 2.5 TD 4x4	11/94→04/98								
Ducato Platform/Chassis 2.5 TDI	03/94→04/02								
Ducato Platform/Chassis 2.5 TDI 4x4	06/98→04/02								TD1048
Ducato Box 2.5 TDI	03/94→04/02	8140.47R (Sofim)	4cyl.						
Ducato Bus 2.5 TDI Panorama/Combinato	07/94→04/02		2499cc	85kW (116PS)					
Ducato Platform/Chassis 2.5 TDI	03/94→04/02	Diesel	Turbo Intercooled						TD1049
		8140.47R.2210	4cyl.						
			2499cc	80kW (109PS)					
		Diesel	Turbo Intercooled						TD6811
Croma 2.5TD Eco	01/92→	8140.97Y (Sofim)	4cyl.						
			2499cc	85kW (116PS)					
		Diesel	Turbo Intercooled						FM19100
08-520200-00	STD	93.00	3.000		008 CR				KV1
[R49350]			2.000		005 IWU P				F12/F14
			3.000		231 CR P				STD
Ducato Box 2.4 D 4x4	09/86→10/87	8140.61	4cyl.						66
Ducato Box 2.5 D, Ducato Box 2.5 D 4x4	09/86→05/90		2445cc	53kW (72PS)					
		Diesel							TD1050
131 2.5 D		8142.61	4cyl.						
			2445cc	53kW (72PS)					
		Diesel							TD1053
131 2.5 D	06/78→02/84	8144.61	4cyl.						
131 Familiare/Panorama 2.5 Super Diesel	03/79→12/84		2445cc	53kW (72PS)					
132 2.5 D	07/78→07/82								
Argenta 2500 Diesel	06/81→11/85	Diesel							
Ducato Box 2.4 D	01/82→08/90								
Ducato Box 2.5 D 4x4	09/86→05/90								
Ducato Panorama 2.4 D	07/82→12/85								TD4408
Argenta 2500 Turbodiesel	07/83→08/85	8144.61.500.81	4cyl.						
			2445cc	66kW (89PS)					
		Diesel	Turbo						TD1054





Campagnola 2.4 D		06/74→10/89	Sofim-8144.61.200		4cyl. 2445cc 53kW (72PS)		
			Diesel				TD6796
08-214400-10	STD	93.00	2.000		001 CR P		KV1
01/1978→05/1981			2.000		005 IF P		STD
[R60960]			4.000		231 CR P		STD
08-214500-10	STD	93.00	3.000		001 CR P		KV1
08-214508-10	0.60mm		2.000		005 IF P		STD
06/1981→			4.000		231 CR P		STD
	[R47010]						
Croma 2500 D		12/85→12/89	8144.67		4cyl. 2500cc 55kW (75PS)		67
Ducato Box 2.5 D		01/82→05/94					
Ducato Box 2.5 D 4x4		03/89→03/94					
Ducato Panorama 2.5 D		01/86→03/94	Diesel				
Ducato Panorama 2.5 D 4x4		01/87→03/94					
Ducato Platform/Chassis 2.5 D		07/82→03/94					
Ducato Platform/Chassis 2.5 D 4x4		03/89→03/94					TD1056
Ducato Box 2.5 D			8144.67.220		4cyl. 2499cc 55kW (75PS)		
			Diesel				TD6797
08-783300-00	STD	93.00	3.000		001 CR P		KV1
08-783308-00	0.60mm		2.000		026 P		STD
[R47100]			3.000		231 CR P		STD
242-Serie Box 2.5 D			B 25.637		4cyl. 2498cc 51kW (69PS)		68
			Diesel				TD21463
Ducato Box 2.5 D		01/82→08/90	CRD93L (U25-661)		4cyl. 2500cc 54-55kW (73-75PS)		
Ducato Panorama 2.5 D		01/86→08/90					
Ducato Platform/Chassis 2.5 D		07/82→08/90					TD22981
			Diesel				
08-152700-00	STD	93.00	2.500		001 MOL P		KV1
08-152707-00	0.50mm		2.000		005 IF P		STD
[R60970]			4.000		231 CR P		STD



Ducato Box 2.8 TD 4x4	05/98→09/01	8140.43					
Ducato Box 2.8 TDI	10/97→04/02		4cyl.				69
Ducato Box 2.8 TDI 4x4	06/99→04/02		2800cc	90kW (122PS)			
Ducato Bus 2.8 TDI	10/97→04/02	Diesel	Turbo				
Ducato Bus 2.8 TDI 4x4	07/99→04/02						
Ducato Platform/Chassis 2.8 iDTD 4x4	05/98→09/01						
Ducato Platform/Chassis 2.8 TDI	12/98→04/02						TD11769

08-122200-00	STD	94.40	2.500		008 CK P	KV1
08-122208-00	0.60mm		2.000		005 P	IKA
eng.2572280→			2.500		231 CR P	GOE12
[R60070]						
08-854700-00	STD	94.40	3.000		008 CR	GOE12
08-854708-00	0.60mm		2.000		005 IWU P	GOE12
→eng.2572279			3.000		231 CR	GOE12
[R49690]						

Ducato Box 2.8 JTD Power	05/04→	8140.43N Euro 3					70
Ducato Bus 2.8 JTD	04/04→07/06		4cyl.				
Ducato Platform/Chassis 2.8 JTD Power	05/04→07/06		2798cc	107kW (146PS)			
		Diesel	Turbo Intercooled				TD20450

Ducato Box 2.8 JTD,	11/00→	8140.43S Euro 3					
Ducato Box 2.8 JTD 4x4,			4cyl.				
Ducato Bus 2.8 JTD,			2800cc	94kW (128PS)			
Ducato Bus 2.8 JTD 4x4		Diesel	Turbo Intercooled				
Ducato Platform/Chassis 2.8 JTD	11/00→07/06						
Ducato Platform/Chassis 2.8 JTD 4x4	10/01→07/06						TD16196

08-122200-00	STD	94.40	2.500		008 CK P	KV1
08-122208-00	0.60mm		2.000		005 P	IKA
[R60070]			2.500		231 CR P	GOE12

Ducato Box 2.8 D	05/98→04/02	8140.63 (Sofim)					71
Ducato Box 2.8 D 4x4	08/98→04/02		4cyl.				
Ducato Bus 2.8 D, Ducato Platform/Chassis 2.8 D	02/98→04/02		2798cc	64kW (87PS)			
Ducato Platform/Chassis 2.8 TD 4x4	05/98→11/01	Diesel					TD12749

08-108200-00	STD	94.40	3.000		008 CR P	KV1
08-108208-00	0.60mm		2.000		026 P	STD
[R60060]			2.500		231 CR P	STD

ENGINE INDEX

Motorverzeichnis • Index de moteur • Índice de Motor
Indeks silnika • Модель двигателя • دليل المحرك



CCM

x



9

		CCM	x		
90/5 AA-Dover	Diesel	4178	4	107.18	6
110/6 AA-Dover	Diesel	5944	6	104.77	2
130/7 AA-Dover	Diesel	6227	6	107.18	6
590E	Diesel	5416	6	100.00	1
592E	Diesel	3610	4	100.00	1
2501E, 2502E, 2503E	Diesel	2589	3	106.69	5
2504E, 2508E (175 cu.in.)	Diesel	2867	3	106.69	5
2505E (192 cu.in.)	Diesel	3146	3	111.77	8
2506E (201cu.in.)	Diesel	3294	3	111.77	8
2701E, 2706E (240 cu.in.)	Diesel	3933	4	104.77	3
2704E, 2709E	Diesel	5944	6	104.77	3
2704ET (360 cu.in.)	Diesel	5944	6	104.77	4
2711E (255 cu.in.)	Diesel	4178	4	107.21	7
2712E (254 cu.in. Parent Block)	Diesel	4162	4	107.21	7
2713E (365 cu.in. Parent Block)	Diesel	5981	6	104.77	3
2714E (380 cu.in)	Diesel	6227	6	107.21	7
2715E D-Series parent blk (380 cu.in)	Diesel	6227	6	107.21	7
D233, 2508E	Diesel	3819	4	106.69	5



1

590E		6cyl.	5416cc		Diesel	FM2506
592E		4cyl.	3610cc		Diesel	FM2503
08-203500-10	STD	100.00	2.385		001 IF CR P	IKA
[R40000]			2.385		001 P	STD
			2.385		023 P	STD
			4.747		231 CR P	STD
			4.747		031 P	STD

2

110/6 AA-Dover		6cyl.	5944cc	110kW (150PS)	Diesel	TD6957
08-520900-00	STD	104.77	3.175		008 MOL	KV1
[R35620]			2.385		001 IFU	GOE12
			2.385		001 IFU	GOE12
			4.747		231	GOE12
08-782800-00	STD	104.77	3.175		008 CR P	KV1
			2.385		005 IF P	STD
			2.385		005 IF P	STD
			4.747		231 CR P	STD

3

2701E, 2706E (240 cu.in.)		4cyl.	3933cc		Diesel	FM2512	
2704E, 2709E		6cyl.	5944cc		Diesel	FM2514	
2713E (365 cu.in. Parent Block)		6cyl.	5981cc		Diesel	FM2542	
08-202800-00	STD	104.77	2.385		001 IF CR P	STD	
08-202807-00	.020			2.385		005 IF P	STD
08-202809-00	.030			2.385		023 P	STD
08-202811-00	.040			4.747		231 CR P	STD
[R40040]							

4

2704ET (360 cu.in.)		6cyl.	5944cc		Diesel Turbo	FM2537
08-523500-00	STD	104.77	3.175		008 P	IKA
[R25270]			2.381		001 IF P	IKA
			2.381		001 IF P	IKA
			4.762		231 CR P	GOE12



5

2501E, 2502E, 2503E		3cyl.	2589cc		Diesel	FM6738
2504E, 2508E (175 cu.in.)		3cyl.	2867cc		Diesel	FM6732
D233, 2508E		4cyl.	3819cc		Diesel	FM2974
08-208100-00	STD	106.69	2.385		001 IW CR P	KV1
08-208107-00	.020				001 IF P	STD
08-208109-00	.030		2.385		023 P	STD
08-208111-00	.040		2.385		231 CR P	STD
[R31620/2K/V2]			4.747			

6

130/7 AA-Dover		6cyl.	6227cc	94kW (128PS)	Diesel	TD6956
90/5 AA-Dover		4cyl.	4178cc	63-66kW (86-90PS)	Diesel	TD6954
08-782900-00	STD	107.18	2.385		001 CR P	KV1
08-782906-00	.015				005 P	GOE12
08-782910-00	.035		2.385		231 CR P	GOE12
[R35640]				4.747		
<small>☐ For Cast Iron Bores only</small>		<small>☐ Nur für Gußeisenbohrungen</small>		<small>☐ Pour intérieur cylindre seulement</small>		<small>☐ Para diámetro internos de hierro fundido solamente</small>

7

2711E (255 cu.in.)		4cyl.	4178cc		Diesel	FM2558
2712E (254 cu.in. Parent Block)		4cyl.	4162cc		Diesel	FM2559
2714E (380 cu.in.)		6cyl.	6227cc		Diesel	FM2560
2715E D-Series parent blk (380 cu.in.)		6cyl.	6227cc		Diesel	FM2562
08-214800-10	STD	107.21	2.385		001 CR P	KV1
08-214807-10	.020				005 IW P	STD
08-214809-10	.030		2.385		026 P	STD
08-214811-10	.040		2.385		231 CR P	STD
[R40110]			4.747			

8

2505E (192 cu.in.)		3cyl.	3146cc		Diesel	FM3456
2506E (201cu.in.)		3cyl.	3294cc		Diesel	FM3518
08-202400-10	STD	111.77	2.385		001 IW CR P	KV1
08-202407-10	.020				001 IW P	STD
08-202409-10	.030		2.385		023 P	STD
[R31640/2K/V2]				4.747		231 CR P



CCM

x



9

09/73→09/83	A-Series AO409	2402E York (Parent Block)	Diesel	3537	6	56
09/73→09/83	A-Series AO509	2402E York (Parent Block)	Diesel	3537	6	56
09/73→09/83	A-Series AO609	2402E York (Parent Block)	Diesel	3537	6	56
09/73→09/83	A-Series AO709	2402E York (Parent Block)	Diesel	3537	6	56
10/12→	B-Max 1.6 TDCi	T3JB	Diesel	1560	4	8
01/69→12/81	Capri	EV20H	Petrol	1995	V6	32
01/69→12/70	Capri 1300	KL 13 H (Uprated 711M)	Petrol	1298	4	23
01/72→12/72	Capri 1300	KL 13 HC (Uprated 711M)	Petrol	1298	4	23
01/69→12/70	Capri 1300	KL 13 L	Petrol	1298	4	23
01/71→12/73	Capri 1300	KL 13 L	Petrol	1298	4	23
01/68→12/72	Capri 1600	711M uprated	Petrol	1599	4	23
01/68→12/72	Capri 1600 GT	711M uprated	Petrol	1599	4	23
02/69→02/74	Capri 2000	NY	Petrol	1999	V6	32
02/74→08/77	Capri II 1.3	J1E	Petrol	1298	4	23
02/74→12/77	Capri II 1.6	LCE	Petrol	1593	4	42
02/74→12/77	Capri II 1.6	LEC	Petrol	1593	4	42
04/74→12/77	Capri II 2.0	TL 20 H	Petrol	1993	4	50
01/78→06/85	Capri III 1.3	J1E	Petrol	1298	4	23
01/78→04/87	Capri III 1.6	LCN	Petrol	1593	4	42
01/78→12/85	Capri III 2.0	NEN	Petrol	1993	4	50
01/78→12/85	Capri III 2.0	TL 20 H	Petrol	1993	4	50
06/79→12/85	Capri III 2.3 Super	YYN	Petrol	2293	V6	48
01/81→04/87	Capri III 2.8 Super Injection	PRN (TV28)	Petrol	2792	V6	55
02/07→	C-Max 1.6	HWDA	Petrol	1596	4	15
02/07→	C-Max 1.6	HWDB	Petrol	1596	4	15
02/07→	C-Max 1.6 TDCi	G8DA (Duratorq)	Diesel	1560	4	7
02/07→	C-Max 1.6 TDCi	G8DB (Duratorq)	Diesel	1560	4	7
02/07→	C-Max 1.6 TDCi	HHDA Euro 4	Diesel	1560	4	7
02/07→	C-Max 1.6 TDCi	HHDB Euro 4	Diesel	1560	4	7
02/07→	C-Max 1.8	QQDA (Duratec HE)	Petrol	1798	4	30
02/07→	C-Max 1.8	QQDB (Duratec HE)	Petrol	1798	4	30
02/07→	C-Max 1.8 Flexifuel	Q7DA (Duratec HE)	Petrol	1798	4	30
02/07→	C-Max 1.8 TDCi	KKDA Euro 4	Diesel	1753	4	26
02/07→	C-Max 2.0	AODA	Petrol	1999	4	41
02/07→	C-Max 2.0	AODB	Petrol	1999	4	41
02/07→	C-Max 2.0 TDCi	G6DA	Diesel	1997	4	34
02/07→	C-Max 2.0 TDCi	G6DB	Diesel	1997	4	34
02/07→	C-Max 2.0 TDCi	G6DD (Duratorq)	Diesel	1997	4	34
12/10→	C-Max II 1.6 TDCi	T1DA (Duratorq TDCI)	Diesel	1560	4	8
12/10→	C-Max II 1.6 TDCi	T1DB (Duratorq TDCI)	Diesel	1560	4	8
12/10→	C-Max II 1.6 TDCi	T3DA (Duratorq TDCI)	Diesel	1560	4	8
12/10→	C-Max II 1.6 TDCi	T3DB (Duratorq TDCI)	Diesel	1560	4	8
01/72→12/75	Consul	EV20H	Petrol	1995	V6	32
10/66→03/72	Cortina 1300	KL 13 H (Uprated 711M)	Petrol	1298	4	23
10/70→03/72	Cortina 1300	KL 13 H (Uprated 711M)	Petrol	1298	4	23
01/70→03/72	Cortina 1300	KL 13 L	Petrol	1298	4	23
10/66→03/72	Cortina 1300	KL 13 L	Petrol	1298	4	23
01/71→12/75	Cortina 1600	711M uprated	Petrol	1599	4	23
10/67→12/69	Cortina 1600	KL 16 L (751M)	Petrol	1599	4	23
10/70→03/72	Cortina 1600 GT	LCJ	Petrol	1593	4	42
01/81→	Cortina 2000 Ghia	EV20H	Petrol	1995	V6	32
01/81→	Cortina 2000 GL	EV20H	Petrol	1995	V6	32
01/81→	Cortina 2000 L	EV20H	Petrol	1995	V6	32
10/66→03/72	Cortina Coupe 1300	KL 13 H (Uprated 711M)	Petrol	1298	4	23
10/70→03/72	Cortina Coupe 1300	KL 13 H (Uprated 711M)	Petrol	1298	4	23
01/70→03/72	Cortina Coupe 1300	KL 13 L	Petrol	1298	4	23
10/66→03/72	Cortina Coupe 1300	KL 13 L	Petrol	1298	4	23
10/67→12/69	Cortina Coupe 1600	KL 16 L (751M)	Petrol	1599	4	23
10/70→03/72	Cortina Coupe 1600 GT	LCJ	Petrol	1593	4	42
10/66→03/72	Cortina Estate 1300	KL 13 H (Uprated 711M)	Petrol	1298	4	23

MODEL INDEX

Modelverzeichnis • Index de modele • Índice de Modelo
Indeks modelu • Модель автомобиля • دليل الموديل



CCM

x



9

10/70→03/72	Cortina Estate 1300	KL 13 H (Uprated 711M)	Petrol	1298	4	23
01/70→03/72	Cortina Estate 1300	KL 13 L	Petrol	1298	4	23
10/66→03/72	Cortina Estate 1300	KL 13 L	Petrol	1298	4	23
10/67→12/69	Cortina Estate 1600	KL 16 L (751M)	Petrol	1599	4	23
08/98→12/01	Cougar 2.0 16V	EDBA (ZH20 Zetec E)	Petrol	1988	4	33
08/98→12/01	Cougar 2.0 16V	EDBB (ZH20 Zetec E)	Petrol	1988	4	33
08/98→12/01	Cougar 2.0 16V	EDBC (ZH20 Zetec E)	Petrol	1988	4	33
08/98→12/01	Cougar 2.0 16V	EDBD (ZH20 Zetec E)	Petrol	1988	4	33
06/99→02/02	Courier Pickup 1.8 D	RTK (D18NA/Endura DE)	Diesel	1753	4	29
03/86→03/92	Econovan 1.4	UC	Petrol	1416	4	12
03/86→03/92	Econovan 2.0 D	RF	Diesel	1998	4	39
03/86→03/92	Econovan Box 1.4	UC	Petrol	1416	4	12
03/86→03/92	Econovan Box 2.0 D	RF	Diesel	1998	4	39
03/81→02/86	Escort '81 Express 1.1	GLB	Petrol	1117	4	5
03/81→02/86	Escort '81 Express 1.3	JPA	Petrol	1296	4	19
02/84→02/86	Escort '81 Express 1.6 D	LTA (D16)	Diesel	1608	4	21
05/86→07/90	Escort '86 Express 1.1	GSG	Petrol	1117	4	5
07/88→07/90	Escort '86 Express 1.3	JBA (BL13H)	Petrol	1299	4	6
02/86→07/90	Escort '86 Express 1.3	JBB (BL13H)	Petrol	1299	4	6
02/86→07/90	Escort '86 Express 1.3	JLA	Petrol	1299	4	5
02/86→07/90	Escort '86 Express 1.3	JLB	Petrol	1299	4	5
02/86→07/90	Escort '86 Express 1.4 i	F6B (HL14G CVH)	Petrol	1392	4	13
02/86→07/90	Escort '86 Express 1.4 i	F6D (HL14G CVH)	Petrol	1392	4	13
02/86→07/90	Escort '86 Express 1.4 i	FUC (HL14G CVH)	Petrol	1392	4	13
02/86→07/90	Escort '86 Express 1.6	LUC (HL16H CVH)	Petrol	1597	4	19
02/86→07/90	Escort '86 Express 1.6 D	LTA (D16)	Diesel	1608	4	21
07/88→07/90	Escort '86 Express 1.8 D	RTA (D18NA)	Diesel	1753	4	29
07/88→07/90	Escort '86 Express 1.8 D	RTB (D18NA)	Diesel	1753	4	29
07/90→12/94	Escort '91 Express 1.3	JBD	Petrol	1299	4	6
07/90→12/94	Escort '91 Express 1.4	F6F (HL14CFI CVH)	Petrol	1392	4	13
07/90→12/94	Escort '91 Express 1.4	F6G (HL14CFI CVH)	Petrol	1392	4	13
07/90→12/94	Escort '91 Express 1.8 D	RTH (D18NA)	Diesel	1753	4	29
01/95→	Escort '95 Box 1.4	F4B (HL14EFI CVH)	Petrol	1392	4	13
01/95→	Escort '95 Box 1.8 D	RTF (D18NA)	Diesel	1753	4	29
01/95→	Escort '95 Box 1.8 D	RTH (D18NA)	Diesel	1753	4	29
01/95→	Escort '95 Box 1.8 TD	RFD	Diesel	1753	4	28
01/95→	Escort '95 Box 1.8 TD	RFK	Diesel	1753	4	28
01/95→	Escort '95 Box 1.8 TD	RFS (D18TI/Endura DE)	Diesel	1753	4	28
12/95→06/01	Escort '95 Box 1.8 Turbo D	RVA (D18TC)	Diesel	1753	4	28
10/98→07/00	Escort Classic 1.6 16V	L1E (Zetec)	Petrol	1597	4	11
10/98→07/00	Escort Classic 1.8 TD	RFD	Diesel	1753	4	28
10/98→07/00	Escort Classic 1.8 TD	RFK	Diesel	1753	4	28
02/99→07/00	Escort Classic Turnier 1.6 16V	L1E (Zetec)	Petrol	1597	4	11
02/99→07/00	Escort Classic Turnier 1.8 TD	RFD	Diesel	1753	4	28
02/99→07/00	Escort Classic Turnier 1.8 TD	RFK	Diesel	1753	4	28
01/68→12/74	Escort I 1100	G1	Petrol	1098	4	23
06/68→06/71	Escort I 1100	G1	Petrol	1098	4	23
06/70→02/76	Escort I 1100	G2	Petrol	1098	4	23
06/68→06/71	Escort I 1100	KL11	Petrol	1098	4	23
09/73→02/76	Escort I 1300	J1F	Petrol	1298	4	23
06/70→02/76	Escort I 1300	J2	Petrol	1298	4	23
06/70→02/76	Escort I 1300	J3D	Petrol	1298	4	23
06/68→06/71	Escort I 1300 GT	KL 13 H (Uprated 711M)	Petrol	1298	4	23
06/70→02/76	Escort I Estate 1100	G1	Petrol	1098	4	23
06/70→02/76	Escort I Estate 1100	G2	Petrol	1098	4	23
06/68→06/71	Escort I Estate 1100	KL11	Petrol	1098	4	23
06/70→02/76	Escort I Estate 1300	J2	Petrol	1298	4	23
01/70→10/75	Escort I Mexico	KL 16 R	Petrol	1599	4	23
06/75→08/80	Escort II 1.1	G1	Petrol	1098	4	23
12/74→08/80	Escort II 1.1	G1	Petrol	1098	4	23



CCM

x



12/74→08/80	Escort II 1.1	G2	Petrol	1098	4	23
12/74→08/80	Escort II 1.3	J1F	Petrol	1298	4	23
03/79→08/80	Escort II 1.3	J2	Petrol	1298	4	23
12/74→08/80	Escort II 1.3	J2	Petrol	1298	4	23
12/74→08/80	Escort II 1.3	KL13L (J3)	Petrol	1298	4	23
12/74→08/80	Escort II 1.6 RS	LC (KL16G - 751M)	Petrol	1599	4	23
08/75→08/80	Escort II 2.0 RS	NE (N8C (TL20H))	Petrol	1993	4	50
04/75→08/80	Escort II Estate 1.1	G1	Petrol	1098	4	23
04/75→08/80	Escort II Estate 1.1	G2	Petrol	1098	4	23
04/75→08/80	Escort II Estate 1.3	J2	Petrol	1298	4	23
04/75→01/79	Escort II Estate 1.3	KL 13 H (Uprated 711M)	Petrol	1298	4	23
09/80→08/83	Escort III 1.1	GLB	Petrol	1117	4	5
09/80→08/83	Escort III 1.1	GMA	Petrol	1117	4	5
09/80→08/83	Escort III 1.1	GPA	Petrol	1117	4	5
08/83→12/85	Escort III 1.1	GSE	Petrol	1117	4	5
09/80→12/85	Escort III 1.3	JPA	Petrol	1296	4	19
09/80→12/85	Escort III 1.6	LP1	Petrol	1597	4	19
09/80→12/85	Escort III 1.6	LPA (HL16H CVH)	Petrol	1597	4	19
09/80→10/82	Escort III 1.6	LUA (HL16G CVH)	Petrol	1597	4	19
02/84→12/85	Escort III 1.6 D	LTA (D16)	Diesel	1608	4	21
07/85→12/85	Escort III 1.6 i	L4B (HL16I CVH)	Petrol	1598	4	19
11/84→12/85	Escort III 1.6 RS Turbo	LNA	Petrol	1597	4	20
10/82→12/85	Escort III 1.6 XR3i	LR1 (HL16I CVH)	Petrol	1597	4	19
10/82→12/85	Escort III 1.6 XR3i	LRA (HL16I CVH)	Petrol	1597	4	19
09/83→12/85	Escort III Convertible 1.3	JPA	Petrol	1296	4	19
09/83→12/85	Escort III Convertible 1.6	LP1	Petrol	1597	4	19
09/83→12/85	Escort III Convertible 1.6	LPA (HL16H CVH)	Petrol	1597	4	19
09/83→12/85	Escort III Convertible 1.6 i	LR1 (HL16I CVH)	Petrol	1597	4	19
09/83→12/85	Escort III Convertible 1.6 i	LRA (HL16I CVH)	Petrol	1597	4	19
09/80→08/83	Escort III Estate 1.1	GLB	Petrol	1117	4	5
09/80→08/83	Escort III Estate 1.1	GMA	Petrol	1117	4	5
08/83→12/85	Escort III Estate 1.1	GSE	Petrol	1117	4	5
03/81→12/85	Escort III Estate 1.3	JPA	Petrol	1296	4	19
09/80→12/85	Escort III Estate 1.6	LP1	Petrol	1597	4	19
09/80→12/85	Escort III Estate 1.6	LPA (HL16H CVH)	Petrol	1597	4	19
02/84→12/85	Escort III Estate 1.6 D	LTA (D16)	Diesel	1608	4	21
05/82→12/85	Escort III RS 1600i	LUAE	Petrol	1597	4	19
12/85→07/90	Escort IV 1.1	GSG	Petrol	1117	4	5
07/88→10/90	Escort IV 1.3	JBA (BL13H)	Petrol	1299	4	6
01/86→07/90	Escort IV 1.3	JBB (BL13H)	Petrol	1299	4	6
01/86→07/90	Escort IV 1.3	JLA	Petrol	1299	4	5
01/86→07/90	Escort IV 1.3	JLB	Petrol	1299	4	5
01/86→07/90	Escort IV 1.4	F6B (HL14G CVH)	Petrol	1392	4	13
01/86→07/90	Escort IV 1.4	F6D (HL14G CVH)	Petrol	1392	4	13
01/86→07/90	Escort IV 1.4	FUA (HL14G CVH)	Petrol	1392	4	13
10/85→10/90	Escort IV 1.4	FUAA (HL14G CVH)	Petrol	1392	4	13
01/86→07/90	Escort IV 1.4	FUC (HL14G CVH)	Petrol	1392	4	13
01/86→12/88	Escort IV 1.6	LP2 (HL16H CVH)	Petrol	1597	4	19
04/89→07/90	Escort IV 1.6	LUG (HL16H CVH)	Petrol	1597	4	19
01/86→01/89	Escort IV 1.6 D	LTC (D16)	Diesel	1608	4	21
01/86→05/90	Escort IV 1.6 i	L4B (HL16I CVH)	Petrol	1598	4	19
08/89→07/90	Escort IV 1.6 i	LJB (HL16I CVH)	Petrol	1597	4	19
01/86→07/90	Escort IV 1.6 Turbo RS	LNB (HL16T CVH)	Petrol	1597	4	20
01/86→08/89	Escort IV 1.6 XR3i	LR2 (HL16I CVH)	Petrol	1597	4	19
01/86→08/89	Escort IV 1.6 XR3i	LRB (HL16I CVH)	Petrol	1597	4	19
01/89→07/90	Escort IV 1.8 D	RTA (D18NA)	Diesel	1753	4	29
01/89→07/90	Escort IV 1.8 D	RTB (D18NA)	Diesel	1753	4	29
02/87→07/90	Escort IV Convertible 1.4	F6B (HL14G CVH)	Petrol	1392	4	13
02/87→07/90	Escort IV Convertible 1.4	F6D (HL14G CVH)	Petrol	1392	4	13
01/86→07/90	Escort IV Convertible 1.4	FUA (HL14G CVH)	Petrol	1392	4	13

MODEL INDEX

Modelverzeichnis • Index de modele • Índice de Modelo
Indeks modelu • Модель автомобиля • دليل الموديل



CCM

x



9

02/87→07/90	Escort IV Convertible 1.4	FUC (HL14G CVH)	Petrol	1392	4	13
01/86→12/87	Escort IV Convertible 1.6	LP2 (HL16H CVH)	Petrol	1597	4	19
01/86→12/87	Escort IV Convertible 1.6	LPA (HL16H CVH)	Petrol	1597	4	19
01/86→07/90	Escort IV Convertible 1.6 i	L4B (HL16I CVH)	Petrol	1598	4	19
08/89→07/90	Escort IV Convertible 1.6 i	LJB (HL16I CVH)	Petrol	1597	4	19
01/86→07/90	Escort IV Convertible 1.6 XR3i	LR2 (HL16I CVH)	Petrol	1597	4	19
01/86→07/90	Escort IV Convertible 1.6 XR3i	LRB (HL16I CVH)	Petrol	1597	4	19
10/85→09/90	Escort IV Estate 1.1	GSG	Petrol	1117	4	5
01/86→07/90	Escort IV Estate 1.3	JBB (BL13H)	Petrol	1299	4	6
01/86→07/90	Escort IV Estate 1.3	JLA	Petrol	1299	4	5
01/86→07/90	Escort IV Estate 1.3	JLB	Petrol	1299	4	5
01/86→07/90	Escort IV Estate 1.4	F6B (HL14G CVH)	Petrol	1392	4	13
01/86→07/90	Escort IV Estate 1.4	F6D (HL14G CVH)	Petrol	1392	4	13
01/86→07/90	Escort IV Estate 1.4	FUA (HL14G CVH)	Petrol	1392	4	13
10/85→10/90	Escort IV Estate 1.4	FUAA (HL14G CVH)	Petrol	1392	4	13
01/86→07/90	Escort IV Estate 1.4	FUC (HL14G CVH)	Petrol	1392	4	13
01/86→07/90	Escort IV Estate 1.6	LP2 (HL16H CVH)	Petrol	1597	4	19
01/86→01/89	Escort IV Estate 1.6 D	LTC (D16)	Diesel	1608	4	21
01/86→07/90	Escort IV Estate 1.6 i	L4B (HL16I CVH)	Petrol	1598	4	19
01/89→07/90	Escort IV Estate 1.8 D	RTA (D18NA)	Diesel	1753	4	29
01/89→07/90	Escort IV Estate 1.8 D	RTB (D18NA)	Diesel	1753	4	29
01/68→12/74	Escort Mk I	KL09H (711M)	Petrol	940	4	23
07/90→09/92	Escort V 1.3	J4B / BL13 (Endura E)	Petrol	1299	4	6
07/90→09/92	Escort V 1.3	J6A (BL13)	Petrol	1299	4	6
07/90→09/92	Escort V 1.4	F6F (HL14CFI CVH)	Petrol	1392	4	13
07/90→09/92	Escort V 1.4	F6G (HL14CFI CVH)	Petrol	1392	4	13
07/90→12/92	Escort V 1.6	LJF	Petrol	1597	4	19
07/90→08/92	Escort V 1.6	LUJ (HL16G CVH)	Petrol	1597	4	19
07/90→08/92	Escort V 1.6	LUK (HL16G CVH)	Petrol	1597	4	19
02/92→12/92	Escort V 1.8 16V XR3i	RDA (ZH18N/M/P Zetec E)	Petrol	1796	4	22
02/92→12/92	Escort V 1.8 16V XR3i	RQB (ZH18N/M/P Zetec E)	Petrol	1796	4	22
07/90→12/92	Escort V 1.8 D	RTE (D18NA)	Diesel	1753	4	29
07/90→12/92	Escort V 1.8 D	RTF (D18NA)	Diesel	1753	4	29
07/90→12/92	Escort V 1.8 D	RTH (D18NA)	Diesel	1753	4	29
07/90→12/92	Escort V Convertible 1.4	F6F (HL14CFI CVH)	Petrol	1392	4	13
07/90→12/92	Escort V Convertible 1.4	F6G (HL14CFI CVH)	Petrol	1392	4	13
07/90→12/92	Escort V Convertible 1.6	LJF	Petrol	1597	4	19
02/92→12/92	Escort V Convertible 1.8 16V XR3i	RDA (ZH18N/M/P Zetec E)	Petrol	1796	4	22
02/92→12/92	Escort V Convertible 1.8 16V XR3i	RQB (ZH18N/M/P Zetec E)	Petrol	1796	4	22
09/91→09/92	Escort V Estate 1.3	J4B / BL13 (Endura E)	Petrol	1299	4	6
09/91→09/92	Escort V Estate 1.3	J6A (BL13)	Petrol	1299	4	6
07/90→09/92	Escort V Estate 1.4	F6F (HL14CFI CVH)	Petrol	1392	4	13
07/90→09/92	Escort V Estate 1.4	F6G (HL14CFI CVH)	Petrol	1392	4	13
07/90→09/92	Escort V Estate 1.6	LJF	Petrol	1597	4	19
07/90→08/92	Escort V Estate 1.6	LUJ (HL16G CVH)	Petrol	1597	4	19
07/90→08/92	Escort V Estate 1.6	LUK (HL16G CVH)	Petrol	1597	4	19
02/92→12/92	Escort V Estate 1.8 16V	RDA (ZH18N/M/P Zetec E)	Petrol	1796	4	22
07/90→12/92	Escort V Estate 1.8 D	RTE (D18NA)	Diesel	1753	4	29
07/90→12/92	Escort V Estate 1.8 D	RTF (D18NA)	Diesel	1753	4	29
07/90→12/92	Escort V Estate 1.8 D	RTH (D18NA)	Diesel	1753	4	29
05/91→12/92	Escort V RS 2000	N7A (DH20)	Petrol	1998	4	37
09/92→01/95	Escort VI 1.3	J4B / BL13 (Endura E)	Petrol	1299	4	6
09/92→01/95	Escort VI 1.3	J6A (BL13)	Petrol	1299	4	6
01/94→01/95	Escort VI 1.4	F4B (HL14EFI CVH)	Petrol	1392	4	13
09/92→01/95	Escort VI 1.4	F6F (HL14CFI CVH)	Petrol	1392	4	13
09/92→01/95	Escort VI 1.4	F6G (HL14CFI CVH)	Petrol	1392	4	13
01/94→01/95	Escort VI 1.4	FUH (HL14EFI CVH)	Petrol	1392	4	13
09/92→01/95	Escort VI 1.6 i 16V	L1E (Zetec)	Petrol	1597	4	11
01/94→01/95	Escort VI 1.6 i 16V	L1H (ZH16 Zetec E)	Petrol	1597	4	11
09/92→01/95	Escort VI 1.8 16V XR3i	RQB (ZH18N/M/P Zetec E)	Petrol	1796	4	22



CCM

x



9

09/92→01/95	Escort VI 1.8 D	RTE (D18NA)	Diesel	1753	4	29
09/92→01/95	Escort VI 1.8 D	RTF (D18NA)	Diesel	1753	4	29
09/92→01/95	Escort VI 1.8 D	RTH (D18NA)	Diesel	1753	4	29
09/92→01/95	Escort VI 1.8 i 16V	RDA (ZH18N/M/P Zetec E)	Petrol	1796	4	22
02/93→01/95	Escort VI 1.8 TD	RFD	Diesel	1753	4	28
02/93→01/95	Escort VI 1.8 TD	RFK	Diesel	1753	4	28
02/93→01/95	Escort VI 1.8 TD	RFS (D18TI/Endura DE)	Diesel	1753	4	28
08/93→01/95	Escort VI 1.8 XR3i 16V 4x4	RDA (ZH18N/M/P Zetec E)	Petrol	1796	4	22
08/93→01/95	Escort VI 1.8 XR3i 16V 4x4	RQB (ZH18N/M/P Zetec E)	Petrol	1796	4	22
12/92→04/94	Escort VI Convertible 1.4	F6F (HL14CFI CVH)	Petrol	1392	4	13
12/92→04/94	Escort VI Convertible 1.4	F6G (HL14CFI CVH)	Petrol	1392	4	13
07/93→01/95	Escort VI Convertible 1.4 i	F4B (HL14EFI CVH)	Petrol	1392	4	13
12/92→01/95	Escort VI Convertible 1.6 16V XR3i	L1E (Zetec)	Petrol	1597	4	11
02/94→01/95	Escort VI Convertible 1.6 i 16V	L1H (ZH16 Zetec E)	Petrol	1597	4	11
12/92→01/95	Escort VI Convertible 1.8 16V XR3i	RDA (ZH18N/M/P Zetec E)	Petrol	1796	4	22
12/92→01/95	Escort VI Convertible 1.8 16V XR3i	RQB (ZH18N/M/P Zetec E)	Petrol	1796	4	22
09/92→01/95	Escort VI Estate 1.3	J4B / BL13 (Endura E)	Petrol	1299	4	6
09/92→01/95	Escort VI Estate 1.3	J6A (BL13)	Petrol	1299	4	6
01/94→01/95	Escort VI Estate 1.4	F4B (HL14EFI CVH)	Petrol	1392	4	13
09/92→01/95	Escort VI Estate 1.4	F6F (HL14CFI CVH)	Petrol	1392	4	13
09/92→01/95	Escort VI Estate 1.4	F6G (HL14CFI CVH)	Petrol	1392	4	13
01/94→01/95	Escort VI Estate 1.4	FUH (HL14EFI CVH)	Petrol	1392	4	13
09/92→01/95	Escort VI Estate 1.6 i 16V	L1E (Zetec)	Petrol	1597	4	11
01/94→01/95	Escort VI Estate 1.6 i 16V	L1H (ZH16 Zetec E)	Petrol	1597	4	11
09/92→01/95	Escort VI Estate 1.8 D	RTH (D18NA)	Diesel	1753	4	29
01/93→01/95	Escort VI Estate 1.8 i 16V	RDA (ZH18N/M/P Zetec E)	Petrol	1796	4	22
02/93→01/95	Escort VI Estate 1.8 i 16V	RQB (ZH18N/M/P Zetec E)	Petrol	1796	4	22
02/93→01/95	Escort VI Estate 1.8 TD	RFD	Diesel	1753	4	28
02/93→01/95	Escort VI Estate 1.8 TD	RFK	Diesel	1753	4	28
09/92→01/95	Escort VI RS 2000	N7A (DH20)	Petrol	1998	4	37
08/93→01/95	Escort VI RS 2000 4x4	N7A (DH20)	Petrol	1998	4	37
09/92→01/95	Escort VI RS Cosworth 4x4	N5F	Petrol	1993	4	52
08/93→01/95	Escort VI Saloon 1.3	J4B / BL13 (Endura E)	Petrol	1299	4	6
08/93→01/95	Escort VI Saloon 1.3	J6A (BL13)	Petrol	1299	4	6
08/93→01/95	Escort VI Saloon 1.4	F4B (HL14EFI CVH)	Petrol	1392	4	13
08/93→04/94	Escort VI Saloon 1.4	F6F (HL14CFI CVH)	Petrol	1392	4	13
08/93→04/94	Escort VI Saloon 1.4	F6G (HL14CFI CVH)	Petrol	1392	4	13
08/93→01/95	Escort VI Saloon 1.4	FUH (HL14EFI CVH)	Petrol	1392	4	13
08/93→01/95	Escort VI Saloon 1.6 i 16V	L1E (Zetec)	Petrol	1597	4	11
01/94→01/95	Escort VI Saloon 1.6 i 16V	L1H (ZH16 Zetec E)	Petrol	1597	4	11
08/93→01/95	Escort VI Saloon 1.6 i 16V	L1K (Zetec E)	Petrol	1597	4	11
08/93→01/95	Escort VI Saloon 1.8 D	RTE (D18NA)	Diesel	1753	4	29
08/93→01/95	Escort VI Saloon 1.8 D	RTF (D18NA)	Diesel	1753	4	29
08/93→01/95	Escort VI Saloon 1.8 D	RTH (D18NA)	Diesel	1753	4	29
08/93→01/95	Escort VI Saloon 1.8 i 16V	RDA (ZH18N/M/P Zetec E)	Petrol	1796	4	22
08/93→01/95	Escort VI Saloon 1.8 TD	RFD	Diesel	1753	4	28
08/93→01/95	Escort VI Saloon 1.8 TD	RFK	Diesel	1753	4	28
01/95→10/98	Escort VII 1.3	J4B / BL13 (Endura E)	Petrol	1299	4	6
01/95→10/98	Escort VII 1.3	J6A (BL13)	Petrol	1299	4	6
01/95→10/98	Escort VII 1.4	F4B (HL14EFI CVH)	Petrol	1392	4	13
01/95→10/98	Escort VII 1.6 16V	L1E (Zetec)	Petrol	1597	4	11
01/95→10/98	Escort VII 1.6 16V 4x4	L1E (Zetec)	Petrol	1597	4	11
01/95→08/95	Escort VII 1.6 i 16V	L1H (ZH16 Zetec E)	Petrol	1597	4	11
01/95→08/95	Escort VII 1.8 16V	RDA (ZH18N/M/P Zetec E)	Petrol	1796	4	22
01/95→10/98	Escort VII 1.8 16V	RKC (ZH18N/M/P Zetec E)	Petrol	1796	4	22
01/95→12/96	Escort VII 1.8 D	RTE (D18NA)	Diesel	1753	4	29
01/95→12/96	Escort VII 1.8 D	RTF (D18NA)	Diesel	1753	4	29
01/95→12/96	Escort VII 1.8 D	RTH (D18NA)	Diesel	1753	4	29
01/95→10/98	Escort VII 1.8 TD	RFD	Diesel	1753	4	28
01/95→10/98	Escort VII 1.8 TD	RFK	Diesel	1753	4	28

MODEL INDEX

Modelverzeichnis • Index de modele • Índice de Modelo
Indeks modelu • Модель автомобиля • دليل الموديل



CCM

x



9

12/95→10/98	Escort VII 1.8 Turbo D	RVA (D18TC)	Diesel	1753	4	28
02/95→08/98	Escort VII Convertible 1.4	F4B (HL14EFI CVH)	Petrol	1392	4	13
02/95→09/99	Escort VII Convertible 1.6 16V XR3i	L1E (Zetec)	Petrol	1597	4	11
02/95→12/96	Escort VII Convertible 1.6 16V XR3i	L1H (ZH16 Zetec E)	Petrol	1597	4	11
02/95→08/98	Escort VII Convertible 1.8 16V XR3i	RDA (ZH18N/M/P Zetec E)	Petrol	1796	4	22
10/95→08/98	Escort VII Convertible 1.8 16V XR3i	RKC (ZH18N/M/P Zetec E)	Petrol	1796	4	22
02/95→08/00	Escort VII Convertible 1.8 16V XR3i	RQB (ZH18N/M/P Zetec E)	Petrol	1796	4	22
09/95→08/98	Escort VII Convertible 1.8 TD	RFD	Diesel	1753	4	28
09/95→08/98	Escort VII Convertible 1.8 TD	RFK	Diesel	1753	4	28
10/96→08/99	Escort VII Convertible 1.8 Turbo D	RVA (D18TC)	Diesel	1753	4	28
01/95→01/99	Escort VII Estate 1.3	J4B / BL13 (Endura E)	Petrol	1299	4	6
01/95→01/99	Escort VII Estate 1.3	J6A (BL13)	Petrol	1299	4	6
01/95→02/99	Escort VII Estate 1.4	F4B (HL14EFI CVH)	Petrol	1392	4	13
01/95→02/99	Escort VII Estate 1.4	FUH (HL14EFI CVH)	Petrol	1392	4	13
01/95→02/99	Escort VII Estate 1.6 16V	L1E (Zetec)	Petrol	1597	4	11
01/95→08/95	Escort VII Estate 1.6 i 16V	L1H (ZH16 Zetec E)	Petrol	1597	4	11
01/95→08/95	Escort VII Estate 1.8 16V	RDA (ZH18N/M/P Zetec E)	Petrol	1796	4	22
01/95→02/99	Escort VII Estate 1.8 16V	RKC (ZH18N/M/P Zetec E)	Petrol	1796	4	22
01/95→02/99	Escort VII Estate 1.8 D	RTE (D18NA)	Diesel	1753	4	29
01/95→02/99	Escort VII Estate 1.8 D	RTF (D18NA)	Diesel	1753	4	29
01/95→02/99	Escort VII Estate 1.8 D	RTH (D18NA)	Diesel	1753	4	29
01/95→02/99	Escort VII Estate 1.8 TD	RFD	Diesel	1753	4	28
01/95→02/99	Escort VII Estate 1.8 TD	RFK	Diesel	1753	4	28
12/95→02/99	Escort VII Estate 1.8 Turbo D	RVA (D18TC)	Diesel	1753	4	28
02/95→02/98	Escort VII RS 2000	N7A (DH20)	Petrol	1998	4	37
02/95→10/98	Escort VII RS 2000 4x4	N7A (DH20)	Petrol	1998	4	37
02/95→10/98	Escort VII RS Cosworth 4x4	N5F	Petrol	1993	4	52
01/95→02/99	Escort VII Saloon 1.3	J4B / BL13 (Endura E)	Petrol	1299	4	6
01/95→02/99	Escort VII Saloon 1.3	J6A (BL13)	Petrol	1299	4	6
01/95→02/99	Escort VII Saloon 1.4	F4B (HL14EFI CVH)	Petrol	1392	4	13
01/95→02/99	Escort VII Saloon 1.4	FUH (HL14EFI CVH)	Petrol	1392	4	13
01/95→02/99	Escort VII Saloon 1.6 i 16V	L1E (Zetec)	Petrol	1597	4	11
01/95→08/95	Escort VII Saloon 1.6 i 16V	L1H (ZH16 Zetec E)	Petrol	1597	4	11
01/95→02/99	Escort VII Saloon 1.6 i 16V	L1K (Zetec E)	Petrol	1597	4	11
01/95→08/95	Escort VII Saloon 1.8 16V	RDA (ZH18N/M/P Zetec E)	Petrol	1796	4	22
01/95→02/99	Escort VII Saloon 1.8 16V	RKC (ZH18N/M/P Zetec E)	Petrol	1796	4	22
01/95→12/96	Escort VII Saloon 1.8 D	RTE (D18NA)	Diesel	1753	4	29
01/95→12/96	Escort VII Saloon 1.8 D	RTF (D18NA)	Diesel	1753	4	29
01/95→12/96	Escort VII Saloon 1.8 D	RTH (D18NA)	Diesel	1753	4	29
01/95→02/99	Escort VII Saloon 1.8 TD	RFD	Diesel	1753	4	28
01/95→02/99	Escort VII Saloon 1.8 TD	RFK	Diesel	1753	4	28
12/95→02/99	Escort VII Saloon 1.8 Turbo D	RVA (D18TC)	Diesel	1753	4	28
10/77→11/86	Fiesta Box 1.0	TKA	Petrol	957	4	5
08/83→11/89	Fiesta Box 1.0	TKB	Petrol	957	4	5
02/96→	Fiesta Box 1.3	J4C (Endura E)	Petrol	1299	4	6
09/91→02/96	Fiesta Box 1.3	J6B (BL13)	Petrol	1299	4	6
09/86→09/89	Fiesta Box 1.4	F6A	Petrol	1393	4	13
04/96→10/99	Fiesta Box 1.4 i	FHA (Zetec SE)	Petrol	1388	4	10
09/83→09/89	Fiesta Box 1.6 D	LTB (D16)	Diesel	1608	4	21
03/89→12/95	Fiesta Box 1.8 D	RTC (D18NA)	Diesel	1753	4	29
09/91→02/96	Fiesta Box 1.8 D	RTC (D18NA)	Diesel	1753	4	29
03/89→12/95	Fiesta Box 1.8 D	RTD (D18NA)	Diesel	1753	4	29
09/91→02/96	Fiesta Box 1.8 D	RTD (D18NA)	Diesel	1753	4	29
03/89→12/95	Fiesta Box 1.8 D	RTG (D18NA)	Diesel	1753	4	29
09/91→02/96	Fiesta Box 1.8 D	RTG (D18NA)	Diesel	1753	4	29
02/96→	Fiesta Box 1.8 D	RTK (D18NA/Endura DE)	Diesel	1753	4	29
05/98→	Fiesta Box D 1.8	RTJ (D18NA/Endura DE)	Diesel	1753	4	29
05/98→	Fiesta Box D 1.8	RTK (D18NA/Endura DE)	Diesel	1753	4	29
05/76→08/83	Fiesta I 0.9	TKA	Petrol	957	4	5
05/76→08/83	Fiesta I 0.9	TKW	Petrol	957	4	5



CCM

x



05/76→08/83	Fiesta I 0.9	TLA	Petrol	957	4	5
08/77→08/83	Fiesta I 1.3	J3E	Petrol	1298	4	23
08/81→08/83	Fiesta I 1.6 XR2	L3E (KL16G - 751M)	Petrol	1599	4	23
09/83→02/89	Fiesta II 1.0	TKB	Petrol	957	4	5
09/83→11/89	Fiesta II 1.0	TLB (BL10H)	Petrol	999	4	1
09/83→02/89	Fiesta II 1.1	GLC	Petrol	1117	4	5
09/83→02/89	Fiesta II 1.1	GSF	Petrol	1117	4	5
09/83→01/87	Fiesta II 1.3	JPC	Petrol	1296	4	19
09/83→09/89	Fiesta II 1.3	JPC	Petrol	1296	4	19
10/86→02/89	Fiesta II 1.4	F6A	Petrol	1393	4	13
10/86→02/89	Fiesta II 1.4	F6C	Petrol	1392	4	13
10/85→11/89	Fiesta II 1.4	FUB	Petrol	1392	4	13
09/83→01/87	Fiesta II 1.4	FUBA	Petrol	1392	4	13
02/87→02/89	Fiesta II 1.4	FUD	Petrol	1392	4	13
01/85→11/89	Fiesta II 1.6	LP3	Petrol	1597	4	19
04/84→02/89	Fiesta II 1.6 D	LTB (D16)	Diesel	1608	4	21
04/84→02/89	Fiesta II 1.6 XR2	LUB (HL16G CVH)	Petrol	1597	4	19
03/84→02/89	Fiesta II 1.6 XR2	LUD (HL16G CVH)	Petrol	1597	4	19
03/89→12/95	Fiesta III 1.0	TLB (BL10H)	Petrol	999	4	1
03/89→12/95	Fiesta III 1.1	G6A (BL11)	Petrol	1118	4	1
03/89→12/95	Fiesta III 1.1	GUD (BL11H)	Petrol	1118	4	1
03/89→12/95	Fiesta III 1.1	GUE (BL11H)	Petrol	1118	4	1
03/89→12/92	Fiesta III 1.3	JBC (BL13H)	Petrol	1299	4	6
05/91→01/97	Fiesta III 1.3 CAT	J6B (BL13)	Petrol	1299	4	6
03/89→12/95	Fiesta III 1.4	F6E (HL14CFI CVH)	Petrol	1392	4	13
11/92→12/96	Fiesta III 1.4	FUF	Petrol	1392	4	13
03/89→12/95	Fiesta III 1.4	FUG (HL14G CVH)	Petrol	1392	4	13
03/89→12/95	Fiesta III 1.4	FUJ (HL14G CVH)	Petrol	1392	4	13
03/89→12/95	Fiesta III 1.4 CAT	F4A (HL14EFI CVH)	Petrol	1392	4	13
01/89→01/94	Fiesta III 1.6	LUH	Petrol	1597	4	11
03/89→12/92	Fiesta III 1.6	LUH	Petrol	1597	4	11
01/94→12/95	Fiesta III 1.6 i 16V	L1G (Zetec E)	Petrol	1597	4	11
03/90→10/92	Fiesta III 1.6 Turbo	LHA (HL16T CVH)	Petrol	1597	4	20
03/89→03/93	Fiesta III 1.6 XR2i	LJD	Petrol	1597	4	19
02/92→12/95	Fiesta III 1.8 16V	RDB (ZH18N/M/P Zetec E)	Petrol	1796	4	22
03/89→12/95	Fiesta III 1.8 D	RTC (D18NA)	Diesel	1753	4	29
03/89→12/95	Fiesta III 1.8 D	RTD (D18NA)	Diesel	1753	4	29
03/89→12/95	Fiesta III 1.8 D	RTG (D18NA)	Diesel	1753	4	29
03/93→12/95	Fiesta III 1.8 TD	RFL (D18T)	Diesel	1753	4	28
02/92→12/95	Fiesta III 1.8 XR2i 16V	RQC (ZH18N/M/P Zetec E)	Petrol	1796	4	22
08/95→01/02	Fiesta IV 1.25 i 16V	DHA (Zetec SE)	Petrol	1242	4	2
08/95→01/02	Fiesta IV 1.25 i 16V	DHB (Zetec SE)	Petrol	1242	4	2
08/95→01/02	Fiesta IV 1.25 i 16V	DHC (Zetec SE)	Petrol	1242	4	2
08/95→01/02	Fiesta IV 1.25 i 16V	DHD (Zetec SE)	Petrol	1242	4	2
08/95→01/02	Fiesta IV 1.25 i 16V	DHE (Zetec SE)	Petrol	1242	4	2
08/95→01/02	Fiesta IV 1.25 i 16V	DHF (Zetec SE)	Petrol	1242	4	2
08/95→01/02	Fiesta IV 1.25 i 16V	DHG (Zetec SE)	Petrol	1242	4	2
08/95→01/02	Fiesta IV 1.3 i	J4C (Endura E)	Petrol	1299	4	6
08/95→01/02	Fiesta IV 1.3 i	J4J (Endura E)	Petrol	1299	4	6
08/95→01/02	Fiesta IV 1.3 i	J4L (Endura E)	Petrol	1299	4	6
08/95→01/02	Fiesta IV 1.3 i	J4Q (Endura E)	Petrol	1299	4	6
08/95→01/02	Fiesta IV 1.3 i	J4R (Endura E)	Petrol	1299	4	6
08/95→01/02	Fiesta IV 1.3 i	J4T (Endura E)	Petrol	1299	4	6
08/95→01/02	Fiesta IV 1.3 i	JJA (Endura E)	Petrol	1299	4	6
08/95→01/02	Fiesta IV 1.3 i	JJC (Endura E)	Petrol	1299	4	6
08/95→01/02	Fiesta IV 1.3 i	JJE/Endura E (Endura E)	Petrol	1299	4	6
08/95→01/02	Fiesta IV 1.3 i	JJJ (Endura E)	Petrol	1299	4	6
08/95→01/02	Fiesta IV 1.3 i	JJK (Endura E)	Petrol	1299	4	6
08/95→01/02	Fiesta IV 1.3 i	JJM (Endura E)	Petrol	1299	4	6
04/96→01/02	Fiesta IV 1.4 i 16V	FHA (Zetec SE)	Petrol	1388	4	10

MODEL INDEX

Modelverzeichnis • Index de modele • Índice de Modelo
Indeks modelu • Модель автомобиля • دليل الموديل



CCM

x



9

04/96→01/02	Fiesta IV 1.4 i 16V	FHE (Zetec SE)	Petrol	1388	4	10
02/00→01/02	Fiesta IV 1.6 16V Sport	L1T (Zetec SE)	Petrol	1596	4	14
02/00→01/02	Fiesta IV 1.6 16V Sport	L1V (Zetec SE)	Petrol	1596	4	14
08/95→04/00	Fiesta IV 1.8 D	RTJ (D18NA/Endura DE)	Diesel	1753	4	29
08/95→04/00	Fiesta IV 1.8 D	RTK (D18NA/Endura DE)	Diesel	1753	4	29
11/01→	Fiesta V 1.4 16V	FXJA	Petrol	1388	4	10
11/01→	Fiesta V 1.4 16V	FXJB	Petrol	1388	4	10
11/01→	Fiesta V 1.4 TDCi	F6JA / DV4TD (Duratorq)	Diesel	1399	4	3
11/01→	Fiesta V 1.4 TDCi	F6JB (DV4TED)	Diesel	1399	4	3
11/01→	Fiesta V 1.6 16V	FYJA (Duratec)	Petrol	1596	4	14
11/01→	Fiesta V 1.6 16V	FYJB (Duratec)	Petrol	1597	4	14
11/04→	Fiesta V 1.6 TDCi	HHJA (Duratorq)	Diesel	1560	4	7
11/04→	Fiesta V 1.6 TDCi	HHJB (Duratorq)	Diesel	1560	4	7
03/05→	Fiesta V ST150	N4JB (Duratec ST)	Petrol	1999	4	41
10/03→	Fiesta Van 1.4 TDCi	F6JA / DV4TD (Duratorq)	Diesel	1399	4	3
01/09→	Fiesta Van 1.4 TDCi	F6JB (DV4TED)	Diesel	1399	4	3
10/03→	Fiesta Van 1.4 TDCi	F6JB (DV4TED)	Diesel	1399	4	3
01/09→	Fiesta Van 1.6 TDCi	HHJC (Duratorq TDCi)	Diesel	1560	4	7
01/09→	Fiesta Van 1.6 TDCi	HHJD (Duratorq TDCi)	Diesel	1560	4	7
01/09→	Fiesta Van 1.6 TDCi	HHJE (Duratorq TDCi)	Diesel	1560	4	7
02/10→	Fiesta Van 1.6 TDCi	TZJA (Duratorq TDCi)	Diesel	1560	4	8
02/10→	Fiesta Van 1.6 TDCi	TZJB (Duratorq TDCi)	Diesel	1560	4	8
10/08→	Fiesta VI 1.4	SPJA (Duratec)	Petrol	1388	4	9
01/09→	Fiesta VI 1.4 TDCi	F6JB (DV4TED)	Diesel	1399	4	3
10/08→	Fiesta VI 1.6 TDCi	HHJC (Duratorq TDCi)	Diesel	1560	4	7
10/08→	Fiesta VI 1.6 TDCi	HHJD (Duratorq TDCi)	Diesel	1560	4	7
10/08→	Fiesta VI 1.6 TDCi	HHJE (Duratorq TDCi)	Diesel	1560	4	7
02/10→	Fiesta VI 1.6 TDCi	T3JA (Duratorq TDCi)	Diesel	1560	4	8
02/10→	Fiesta VI 1.6 TDCi	TZJA (Duratorq TDCi)	Diesel	1560	4	8
02/10→	Fiesta VI 1.6 TDCi	TZJB (Duratorq TDCi)	Diesel	1560	4	8
10/08→	Fiesta VI 1.6 TDCi	UBJA (Duratorq TDCi)	Diesel	1560	4	7
10/08→	Fiesta VI 1.6 Ti	HXJA (Duratec Ti-VCT)	Petrol	1596	4	15
10/98→11/04	Focus 1.4 16V	FXDA (Zetec SE)	Petrol	1388	4	10
10/98→11/04	Focus 1.4 16V	FXDB (Zetec SE)	Petrol	1388	4	10
10/98→11/04	Focus 1.4 16V	FXDC (Zetec SE)	Petrol	1388	4	10
10/98→11/04	Focus 1.4 16V	FXDD (Zetec SE)	Petrol	1388	4	10
10/98→11/04	Focus 1.6 16V	FYDA (Zetec SE)	Petrol	1596	4	14
10/98→11/04	Focus 1.6 16V	FYDB (Zetec SE)	Petrol	1596	4	14
10/98→11/04	Focus 1.6 16V	FYDC (Zetec SE)	Petrol	1596	4	14
10/98→11/04	Focus 1.6 16V	FYDD (Zetec SE)	Petrol	1596	4	14
10/98→11/04	Focus 1.6 16V	FYDH (Zetec SE)	Petrol	1596	4	14
01/02→11/04	Focus 1.6 16V Flexifuel	FYDH (Zetec SE)	Petrol	1596	4	14
08/99→11/04	Focus 1.8 DI / TDDi	BHDA (Endura DI)	Diesel	1753	4	26
08/99→11/04	Focus 1.8 DI / TDDi	BHDB (Endura DI)	Diesel	1753	4	26
03/01→11/04	Focus 1.8 TDCi	F9DA (Duratorq)	Diesel	1753	4	26
03/01→11/04	Focus 1.8 TDCi	F9DB (Duratorq)	Diesel	1753	4	26
08/02→11/04	Focus 1.8 TDCi	FFDA (Duratorq)	Diesel	1753	4	26
10/98→11/04	Focus 1.8 Turbo DI / TDDi	C9DA (Endura DI)	Diesel	1753	4	26
10/98→11/04	Focus 1.8 Turbo DI / TDDi	C9DB (Endura DI)	Diesel	1753	4	26
10/98→11/04	Focus 1.8 Turbo DI / TDDi	C9DC (Endura DI)	Diesel	1753	4	26
10/98→11/04	Focus 2.0 16V	EDDB (ZH20 Zetec E)	Petrol	1988	4	33
10/98→11/04	Focus 2.0 16V	EDDC (ZH20 Zetec E)	Petrol	1988	4	33
10/98→11/04	Focus 2.0 16V	EDDF (ZH20 Zetec E)	Petrol	1988	4	33
10/03→03/07	Focus C-MAX 1.6	HWDA	Petrol	1596	4	15
10/03→03/07	Focus C-MAX 1.6	HWDB	Petrol	1596	4	15
10/03→03/07	Focus C-MAX 1.6 TDCi	G8DA (Duratorq)	Diesel	1560	4	7
10/03→03/07	Focus C-MAX 1.6 TDCi	G8DB (Duratorq)	Diesel	1560	4	7
02/05→03/07	Focus C-MAX 1.6 TDCi	HHDA Euro 4	Diesel	1560	4	7
02/05→03/07	Focus C-MAX 1.6 TDCi	HHDB Euro 4	Diesel	1560	4	7
08/04→03/07	Focus C-MAX 1.6 Ti	HXDA	Petrol	1596	4	15

CCM
x

9

08/04→03/07	Focus C-MAX 1.6 Ti	SIDA (Duratec Ti-VCT)	Petrol	1596	4	15
10/03→03/07	Focus C-MAX 1.8	CSDA (Duratec HE)	Petrol	1798	4	30
10/03→03/07	Focus C-MAX 1.8	CSDB (Duratec HE)	Petrol	1798	4	30
04/04→03/07	Focus C-MAX 1.8	Q7DA (Duratec HE)	Petrol	1798	4	30
04/04→03/07	Focus C-MAX 1.8	QQDA (Duratec HE)	Petrol	1798	4	30
04/04→03/07	Focus C-MAX 1.8	QQDB (Duratec HE)	Petrol	1798	4	30
01/06→03/07	Focus C-MAX 1.8 Flexifuel	Q7DA (Duratec HE)	Petrol	1798	4	30
01/05→03/07	Focus C-MAX 1.8 TDCi	KKDA Euro 4	Diesel	1753	4	26
03/04→03/07	Focus C-MAX 2.0	AODA	Petrol	1999	4	41
03/04→03/07	Focus C-MAX 2.0	AODB	Petrol	1999	4	41
10/03→03/07	Focus C-MAX 2.0 TDCi	G6DA	Diesel	1997	4	34
10/03→03/07	Focus C-MAX 2.0 TDCi	G6DB	Diesel	1997	4	34
10/03→03/07	Focus C-MAX 2.0 TDCi	G6DD (Duratorq)	Diesel	1997	4	34
02/99→11/04	Focus Estate 1.4 16V	FXDA (Zetec SE)	Petrol	1388	4	10
02/99→11/04	Focus Estate 1.4 16V	FXDB (Zetec SE)	Petrol	1388	4	10
02/99→11/04	Focus Estate 1.4 16V	FXDC (Zetec SE)	Petrol	1388	4	10
02/99→11/04	Focus Estate 1.4 16V	FXDD (Zetec SE)	Petrol	1388	4	10
02/99→11/04	Focus Estate 1.6 16V	FYDA (Zetec SE)	Petrol	1596	4	14
02/99→11/04	Focus Estate 1.6 16V	FYDB (Zetec SE)	Petrol	1596	4	14
02/99→11/04	Focus Estate 1.6 16V	FYDC (Zetec SE)	Petrol	1596	4	14
02/99→11/04	Focus Estate 1.6 16V	FYDD (Zetec SE)	Petrol	1596	4	14
02/99→11/04	Focus Estate 1.6 16V	FYDH (Zetec SE)	Petrol	1596	4	14
01/02→11/04	Focus Estate 1.6 16V Flexifuel	FYDH (Zetec SE)	Petrol	1596	4	14
08/99→11/04	Focus Estate 1.8 DI / TDDi	BHDA (Endura DI)	Diesel	1753	4	26
08/99→11/04	Focus Estate 1.8 DI / TDDi	BHDB (Endura DI)	Diesel	1753	4	26
03/01→11/04	Focus Estate 1.8 TDCi	F9DA (Duratorq)	Diesel	1753	4	26
03/01→11/04	Focus Estate 1.8 TDCi	F9DB (Duratorq)	Diesel	1753	4	26
08/02→11/04	Focus Estate 1.8 TDCi	FFDA (Duratorq)	Diesel	1753	4	26
02/99→11/04	Focus Estate 1.8 Turbo DI / TDDi	C9DA (Endura DI)	Diesel	1753	4	26
02/99→11/04	Focus Estate 1.8 Turbo DI / TDDi	C9DB (Endura DI)	Diesel	1753	4	26
02/99→11/04	Focus Estate 1.8 Turbo DI / TDDi	C9DC (Endura DI)	Diesel	1753	4	26
02/99→11/04	Focus Estate 2.0 16V	EDDB (ZH20 Zetec E)	Petrol	1988	4	33
02/99→11/04	Focus Estate 2.0 16V	EDDC (ZH20 Zetec E)	Petrol	1988	4	33
02/99→11/04	Focus Estate 2.0 16V	EDDF (ZH20 Zetec E)	Petrol	1988	4	33
11/04→	Focus II 1.4	ASDA	Petrol	1388	4	9
11/04→	Focus II 1.4	ASDB	Petrol	1388	4	9
11/04→	Focus II 1.6	HWDA	Petrol	1596	4	15
11/04→	Focus II 1.6	HWDB	Petrol	1596	4	15
10/09→	Focus II 1.6 LPG	SIDA (Duratec Ti-VCT)	Petrol	1596	4	15
11/04→	Focus II 1.6 TDCi	G8DA (Duratorq)	Diesel	1560	4	7
11/04→	Focus II 1.6 TDCi	G8DB (Duratorq)	Diesel	1560	4	7
01/05→	Focus II 1.6 TDCi	HHDA Euro 4	Diesel	1560	4	7
01/05→	Focus II 1.6 TDCi	HHDB Euro 4	Diesel	1560	4	7
11/04→	Focus II 1.6 Ti	HXDA	Petrol	1596	4	15
11/04→	Focus II 1.6 Ti	HXDB (Duratec Ti-VCT)	Petrol	1596	4	15
03/06→	Focus II 1.8	QQDB (Duratec HE)	Petrol	1798	4	30
01/06→	Focus II 1.8 Flexifuel	Q7DA (Duratec HE)	Petrol	1798	4	30
01/05→	Focus II 1.8 TDCi	KKDA Euro 4	Diesel	1753	4	26
01/05→	Focus II 1.8 TDCi	KKDB Euro 4	Diesel	1753	4	26
11/04→	Focus II 2.0	AODA	Petrol	1999	4	41
11/04→	Focus II 2.0	AODB	Petrol	1999	4	41
11/04→	Focus II 2.0 TDCi	G6DA	Diesel	1997	4	34
11/04→	Focus II 2.0 TDCi	G6DB	Diesel	1997	4	34
11/04→	Focus II 2.0 TDCi	G6DD (Duratorq)	Diesel	1997	4	34
10/06→	Focus II Convertible 1.6	HWDA	Petrol	1596	4	15
10/06→	Focus II Convertible 1.6	HWDB	Petrol	1596	4	15
10/06→	Focus II Convertible 2.0	AODA	Petrol	1999	4	41
10/06→	Focus II Convertible 2.0	AODB	Petrol	1999	4	41
10/06→	Focus II Convertible 2.0 TDCi	G6DA	Diesel	1997	4	34
10/06→	Focus II Convertible 2.0 TDCi	G6DB	Diesel	1997	4	34

MODEL INDEX

Modelverzeichnis • Index de modele • Índice de Modelo
Indeks modelu • Модель автомобиля • دليل الموديل



CCM

x



9

10/06→	Focus II Convertible 2.0 TDCi	G6DD (Duratorq)	Diesel	1997	4	34
11/04→	Focus II Estate 1.4	ASDA	Petrol	1388	4	9
11/04→	Focus II Estate 1.4	ASDB	Petrol	1388	4	9
11/04→	Focus II Estate 1.6	HWDA	Petrol	1596	4	15
11/04→	Focus II Estate 1.6	HWDB	Petrol	1596	4	15
10/09→	Focus II Estate 1.6 LPG	SIDA (Duratec Ti-VCT)	Petrol	1596	4	15
11/04→	Focus II Estate 1.6 TDCi	G8DA (Duratorq)	Diesel	1560	4	7
11/04→	Focus II Estate 1.6 TDCi	G8DB (Duratorq)	Diesel	1560	4	7
11/04→	Focus II Estate 1.6 TDCi	HHDA Euro 4	Diesel	1560	4	7
11/04→	Focus II Estate 1.6 TDCi	HHDB Euro 4	Diesel	1560	4	7
11/04→	Focus II Estate 1.6 Ti	HXDA	Petrol	1596	4	15
11/04→	Focus II Estate 1.6 Ti	HXDB (Duratec Ti-VCT)	Petrol	1596	4	15
03/06→	Focus II Estate 1.8	Q7DA (Duratec HE)	Petrol	1798	4	30
03/06→	Focus II Estate 1.8	QQDB (Duratec HE)	Petrol	1798	4	30
01/06→	Focus II Estate 1.8 Flexifuel	Q7DA (Duratec HE)	Petrol	1798	4	30
11/04→	Focus II Estate 1.8 TDCi	KKDA Euro 4	Diesel	1753	4	26
11/04→	Focus II Estate 1.8 TDCi	KKDB Euro 4	Diesel	1753	4	26
11/04→	Focus II Estate 2.0	AODA	Petrol	1999	4	41
11/04→	Focus II Estate 2.0	AODB	Petrol	1999	4	41
11/04→	Focus II Estate 2.0 TDCi	G6DA	Diesel	1997	4	34
11/04→	Focus II Estate 2.0 TDCi	G6DB	Diesel	1997	4	34
11/04→	Focus II Estate 2.0 TDCi	G6DD (Duratorq)	Diesel	1997	4	34
04/05→	Focus II Saloon 1.4	ASDA	Petrol	1388	4	9
04/05→	Focus II Saloon 1.4	ASDB	Petrol	1388	4	9
04/05→	Focus II Saloon 1.6	HWDA	Petrol	1596	4	15
04/05→	Focus II Saloon 1.6	HWDB	Petrol	1596	4	15
04/05→	Focus II Saloon 1.6 TDCi	G8DA (Duratorq)	Diesel	1560	4	7
04/05→	Focus II Saloon 1.6 TDCi	G8DB (Duratorq)	Diesel	1560	4	7
04/05→	Focus II Saloon 1.6 TDCi	HHDA Euro 4	Diesel	1560	4	7
04/05→	Focus II Saloon 1.6 TDCi	HHDB Euro 4	Diesel	1560	4	7
04/05→	Focus II Saloon 1.6 Ti	HXDA	Petrol	1596	4	15
04/05→	Focus II Saloon 1.6 Ti	HXDB (Duratec Ti-VCT)	Petrol	1596	4	15
03/06→	Focus II Saloon 1.8	QQDB (Duratec HE)	Petrol	1798	4	30
06/06→	Focus II Saloon 1.8 Flexifuel	Q7DA (Duratec HE)	Petrol	1798	4	30
04/05→	Focus II Saloon 1.8 TDCi	KKDA Euro 4	Diesel	1753	4	26
04/05→	Focus II Saloon 1.8 TDCi	KKDB Euro 4	Diesel	1753	4	26
04/05→	Focus II Saloon 2.0	AODA	Petrol	1999	4	41
04/05→	Focus II Saloon 2.0	AODB	Petrol	1999	4	41
04/05→	Focus II Saloon 2.0 TDCi	G6DA	Diesel	1997	4	34
04/05→	Focus II Saloon 2.0 TDCi	G6DB	Diesel	1997	4	34
04/05→	Focus II Saloon 2.0 TDCi	G6DD (Duratorq)	Diesel	1997	4	34
04/11→	Focus III 1.6 TDCi	T1DA (Duratorq TDCI)	Diesel	1560	4	8
04/11→	Focus III 1.6 TDCi	T1DB (Duratorq TDCI)	Diesel	1560	4	8
04/11→	Focus III 1.6 TDCi	T3DA (Duratorq TDCI)	Diesel	1560	4	8
04/11→	Focus III 1.6 TDCi	T3DB (Duratorq TDCI)	Diesel	1560	4	8
05/12→	Focus III 1.6 TDCi ECONetic	NGDA (Duratorq TDCI)	Diesel	1560	4	8
04/11→	Focus III Saloon 1.6 TDCi	T1DA (Duratorq TDCI)	Diesel	1560	4	8
04/11→	Focus III Saloon 1.6 TDCi	T1DB (Duratorq TDCI)	Diesel	1560	4	8
04/11→	Focus III Saloon 1.6 TDCi	T3DA (Duratorq TDCI)	Diesel	1560	4	8
04/11→	Focus III Saloon 1.6 TDCi	T3DB (Duratorq TDCI)	Diesel	1560	4	8
05/11→	Focus III Turnier 1.6 TDCi	T1DA (Duratorq TDCI)	Diesel	1560	4	8
05/11→	Focus III Turnier 1.6 TDCi	T1DB (Duratorq TDCI)	Diesel	1560	4	8
05/11→	Focus III Turnier 1.6 TDCi	T3DA (Duratorq TDCI)	Diesel	1560	4	8
05/11→	Focus III Turnier 1.6 TDCi	T3DB (Duratorq TDCI)	Diesel	1560	4	8
05/12→	Focus III Turnier 1.6 TDCi ECONetic	NGDA (Duratorq TDCI)	Diesel	1560	4	8
02/99→11/04	Focus Saloon 1.4 16V	FXDA (Zetec SE)	Petrol	1388	4	10
02/99→11/04	Focus Saloon 1.4 16V	FXDB (Zetec SE)	Petrol	1388	4	10
02/99→11/04	Focus Saloon 1.4 16V	FXDC (Zetec SE)	Petrol	1388	4	10
02/99→11/04	Focus Saloon 1.4 16V	FXDD (Zetec SE)	Petrol	1388	4	10
02/99→11/04	Focus Saloon 1.6 16V	FYDA (Zetec SE)	Petrol	1596	4	14

CCM
x

9

02/99→11/04	Focus Saloon 1.6 16V	FYDB (Zetec SE)	Petrol	1596	4	14
02/99→11/04	Focus Saloon 1.6 16V	FYDC (Zetec SE)	Petrol	1596	4	14
02/99→11/04	Focus Saloon 1.6 16V	FYDD (Zetec SE)	Petrol	1596	4	14
02/99→11/04	Focus Saloon 1.6 16V	FYDH (Zetec SE)	Petrol	1596	4	14
03/01→11/04	Focus Saloon 1.8 TDCi	F9DA (Duratorq)	Diesel	1753	4	26
03/01→11/04	Focus Saloon 1.8 TDCi	F9DB (Duratorq)	Diesel	1753	4	26
08/02→11/04	Focus Saloon 1.8 TDCi	FFDA (Duratorq)	Diesel	1753	4	26
08/01→03/05	Focus Saloon 1.8 Turbo DI / TDDi	BHDA (Endura DI)	Diesel	1753	4	26
08/01→03/05	Focus Saloon 1.8 Turbo DI / TDDi	BHDB (Endura DI)	Diesel	1753	4	26
02/99→11/04	Focus Saloon 1.8 Turbo DI / TDDi	C9DA (Endura DI)	Diesel	1753	4	26
02/99→11/04	Focus Saloon 1.8 Turbo DI / TDDi	C9DB (Endura DI)	Diesel	1753	4	26
02/99→11/04	Focus Saloon 1.8 Turbo DI / TDDi	C9DC (Endura DI)	Diesel	1753	4	26
02/99→11/04	Focus Saloon 2.0 16V	EDDB (ZH20 Zetec E)	Petrol	1988	4	33
02/99→11/04	Focus Saloon 2.0 16V	EDDC (ZH20 Zetec E)	Petrol	1988	4	33
02/99→11/04	Focus Saloon 2.0 16V	EDDF (ZH20 Zetec E)	Petrol	1988	4	33
08/02→	Fusion 1.4	FXJA	Petrol	1388	4	10
08/02→	Fusion 1.4	FXJB	Petrol	1388	4	10
08/02→	Fusion 1.4 TDCi	F6JA / DV4TD (Duratorq)	Diesel	1399	4	3
08/02→	Fusion 1.4 TDCi	F6JB (DV4TED)	Diesel	1399	4	3
08/02→	Fusion 1.6	FYJA (Duratec)	Petrol	1596	4	14
08/02→	Fusion 1.6	FYJB (Duratec)	Petrol	1597	4	14
11/04→	Fusion 1.6 TDCi	HHJA (Duratorq)	Diesel	1560	4	7
11/04→	Fusion 1.6 TDCi	HHJB (Duratorq)	Diesel	1560	4	7
05/06→	Galaxy 1.8 TDCi	FFWA	Diesel	1753	4	27
05/06→	Galaxy 1.8 TDCi	QYWA	Diesel	1753	4	27
03/95→05/06	Galaxy 1.9 TDI	1Z	Diesel	1896	4	17
08/97→04/00	Galaxy 1.9 TDI	AFN	Diesel	1896	4	17
03/95→05/06	Galaxy 1.9 TDI	AHU	Diesel	1896	4	17
03/95→05/06	Galaxy 1.9 TDI	ANU	Diesel	1896	4	17
05/06→	Galaxy 2.0	AOWA	Petrol	1999	4	41
11/95→05/06	Galaxy 2.0 i	NSE (DL20)	Petrol	1998	4	37
11/95→05/06	Galaxy 2.0 i	ZVSA (DL20)	Petrol	1998	4	37
07/10→	Galaxy 2.2 TDCi	KNWA (Duratorq TDCI)	Diesel	2179	4	35
07/10→	Galaxy 2.2 TDCi	KNWB (Duratorq TDCI)	Diesel	2179	4	35
01/97→05/06	Galaxy 2.3 16V	Y5B	Petrol	2295	4	45
11/95→04/00	Galaxy 2.8 i V6	AAA	Petrol	2792	V6	24
11/95→04/00	Galaxy 2.8 i V6	AMY	Petrol	2792	V6	24
04/96→04/00	Galaxy 2.8 i V6 4x4	AAA	Petrol	2792	V6	24
04/96→04/00	Galaxy 2.8 i V6 4x4	AMY	Petrol	2792	V6	24
04/00→05/06	Galaxy 2.8 V6	AYL	Petrol	2792	V6	24
07/81→08/85	Granada 1.6	LCK	Petrol	1593	4	42
01/77→12/82	Granada 1.9 D	XD88, XDP88	Diesel	1948	4	44
01/77→12/82	Granada 1.9 D GL	XD88, XDP88	Diesel	1948	4	44
01/77→12/82	Granada 1.9 D L	XD88, XDP88	Diesel	1948	4	44
01/77→12/82	Granada 1.9 D Turnier	XD88, XDP88	Diesel	1948	4	44
08/81→08/85	Granada 2.0	NEK (N8C (TL20H))	Petrol	1993	4	50
08/79→08/85	Granada 2.0	NEP (N8C (TL20H))	Petrol	1993	4	50
01/75→08/77	Granada 2.0	NY	Petrol	1999	V6	32
08/77→08/85	Granada 2.0	NYP	Petrol	1999	V6	32
01/75→12/75	Granada 2.0	TL 20 LC	Petrol	1994	4	50
01/76→07/77	Granada 2.0	TL 20 LC	Petrol	1994	4	50
08/77→08/82	Granada 2.1 D	WTA (XD90)	Diesel	2112	4	49
01/75→08/77	Granada 2.3	YYH (TV23)	Petrol	2293	V6	48
08/77→06/79	Granada 2.3	YYH (TV23)	Petrol	2293	V6	48
06/79→08/85	Granada 2.3	YYP (TV23)	Petrol	2293	V6	48
06/81→08/85	Granada 2.3	YYU (TV23)	Petrol	2293	V6	48
01/82→	Granada 2.3 D	XD2S	Diesel	2304	4	60
01/87→08/89	Granada 2.4 EFi Ghia	TV24	Petrol	2394	V6	31
01/87→08/89	Granada 2.4 EFi Ghia X	TV24	Petrol	2394	V6	31
01/87→08/89	Granada 2.4 EFi GL	TV24	Petrol	2394	V6	31

MODEL INDEX

Modelverzeichnis • Index de modele • Índice de Modelo
Indeks modelu • Модель автомобиля • دليل الموديل



CCM

x



9

08/82→08/85	Granada 2.5 D	STP (XD3/XD3P)	Diesel	2498	4	61
08/77→08/85	Granada 2.8	PYA (TV28)	Petrol	2792	V6	55
06/81→08/85	Granada 2.8	PYU (TV28)	Petrol	2792	V6	55
08/77→08/81	Granada 2.8 i	PRB (TV28)	Petrol	2792	V6	55
10/82→08/85	Granada 2.8 i	PRC (TV28)	Petrol	2792	V6	55
08/77→08/85	Granada 2.8 i	PRD (TV28)	Petrol	2792	V6	55
01/75→12/85	Granada 2000 Ghia	EV20H	Petrol	1995	V6	32
01/75→12/85	Granada 2000 GL	EV20H	Petrol	1995	V6	32
01/75→12/85	Granada 2000 L	EV20H	Petrol	1995	V6	32
08/81→08/85	Granada Estate 2.0	NEK (N8C (TL20H))	Petrol	1993	4	50
08/79→08/85	Granada Estate 2.0	NEP (N8C (TL20H))	Petrol	1993	4	50
01/75→08/77	Granada Estate 2.0	NY	Petrol	1999	V6	32
08/77→06/85	Granada Estate 2.0	NYP	Petrol	1999	V6	32
01/75→12/75	Granada Estate 2.0	TL 20 LC	Petrol	1994	4	50
01/76→07/77	Granada Estate 2.0	TL 20 LC	Petrol	1994	4	50
08/77→06/79	Granada Estate 2.3	YYH (TV23)	Petrol	2293	V6	48
06/79→08/85	Granada Estate 2.3	YYP (TV23)	Petrol	2293	V6	48
06/81→06/85	Granada Estate 2.3	YYU (TV23)	Petrol	2293	V6	48
08/82→08/85	Granada Estate 2.5 D	STP (XD3/XD3P)	Diesel	2498	4	61
08/77→08/85	Granada Estate 2.8	PYA (TV28)	Petrol	2792	V6	55
06/81→08/85	Granada Estate 2.8	PYU (TV28)	Petrol	2792	V6	55
08/77→08/81	Granada Estate 2.8 i	PRB (TV28)	Petrol	2792	V6	55
10/82→08/85	Granada Estate 2.8 i	PRC (TV28)	Petrol	2792	V6	55
08/77→08/85	Granada Estate 2.8 i	PRD (TV28)	Petrol	2792	V6	55
12/10→	Grand C-Max 1.6 TDCi	T1DA (Duratorq TDCI)	Diesel	1560	4	8
12/10→	Grand C-Max 1.6 TDCi	T1DB (Duratorq TDCI)	Diesel	1560	4	8
12/10→	Grand C-Max 1.6 TDCi	T3DA (Duratorq TDCI)	Diesel	1560	4	8
12/10→	Grand C-Max 1.6 TDCi	T3DB (Duratorq TDCI)	Diesel	1560	4	8
08/02→11/08	Ka 1.3 i	A9A (Duratec)	Petrol	1299	4	4
08/02→11/08	Ka 1.3 i	A9B (Duratec)	Petrol	1299	4	4
09/96→11/08	Ka 1.3 i	J4D/Endura E (Endura E)	Petrol	1299	4	6
09/96→11/08	Ka 1.3 i	J4K (Endura E)	Petrol	1299	4	6
09/96→11/08	Ka 1.3 i	J4M (Endura E)	Petrol	1299	4	6
09/96→11/08	Ka 1.3 i	J4N (Endura E)	Petrol	1299	4	6
09/96→11/08	Ka 1.3 i	J4P (Endura E)	Petrol	1299	4	6
09/96→11/08	Ka 1.3 i	J4S (Endura E)	Petrol	1299	4	6
09/96→10/02	Ka 1.3 i	JJB/Endura E (Endura E)	Petrol	1299	4	6
06/98→11/08	Ka 1.3 i	JJD (Endura E)	Petrol	1299	4	6
06/98→11/08	Ka 1.3 i	JJF (Endura E)	Petrol	1299	4	6
06/98→11/08	Ka 1.3 i	JJG (Endura E)	Petrol	1299	4	6
06/98→11/08	Ka 1.3 i	JJH (Endura E)	Petrol	1299	4	6
06/98→11/08	Ka 1.3 i	JJL (Endura E)	Petrol	1299	4	6
05/02→05/05	Ka Van 1.3 i	J4D/Endura E (Endura E)	Petrol	1299	4	6
05/02→05/05	Ka Van 1.3 i	J4K (Endura E)	Petrol	1299	4	6
05/02→05/05	Ka Van 1.3 i	J4M (Endura E)	Petrol	1299	4	6
05/02→05/05	Ka Van 1.3 i	J4N (Endura E)	Petrol	1299	4	6
05/02→05/05	Ka Van 1.3 i	J4P (Endura E)	Petrol	1299	4	6
05/02→05/05	Ka Van 1.3 i	J4S (Endura E)	Petrol	1299	4	6
03/04→	Maverick 2.3 16V	GZ	Petrol	2261	4	41
02/93→08/96	Mondeo I 1.6 i 16V	L1F (Zetec)	Petrol	1597	4	11
07/94→08/96	Mondeo I 1.6 i 16V	L1J (Zetec E)	Petrol	1597	4	11
02/93→08/96	Mondeo I 1.8 i 16V	RKA (ZH18N/M/P Zetec E)	Petrol	1796	4	22
07/94→08/96	Mondeo I 1.8 i 16V	RKB (ZH18N/M/P Zetec E)	Petrol	1796	4	22
02/93→08/96	Mondeo I 1.8 i 16V 4x4	RKA (ZH18N/M/P Zetec E)	Petrol	1796	4	22
06/93→08/96	Mondeo I 1.8 TD	RFM	Diesel	1753	4	28
10/95→08/96	Mondeo I 1.8 TD	RFM	Diesel	1753	4	28
06/93→08/96	Mondeo I 1.8 TD	RFN	Diesel	1753	4	28
10/95→08/96	Mondeo I 1.8 TD	RFN	Diesel	1753	4	28
02/93→08/96	Mondeo I 2.0 i 16V	NGA (ZH20 Zetec E)	Petrol	1988	4	33
12/94→08/96	Mondeo I 2.0 i 16V	NGA (ZH20 Zetec E)	Petrol	1988	4	33



CCM

x



9

12/94→08/96	Mondeo I 2.0 i 16V 4x4	NGA (ZH20 Zetec E)	Petrol	1988	4	33
04/93→08/96	Mondeo I Estate 1.6 i 16V	L1F (Zetec)	Petrol	1597	4	11
07/94→08/96	Mondeo I Estate 1.6 i 16V	L1J (Zetec E)	Petrol	1597	4	11
04/93→08/96	Mondeo I Estate 1.8 i 16V	RKA (ZH18N/M/P Zetec E)	Petrol	1796	4	22
07/94→08/96	Mondeo I Estate 1.8 i 16V	RKB (ZH18N/M/P Zetec E)	Petrol	1796	4	22
04/93→08/96	Mondeo I Estate 1.8 i 16V 4x4	RKA (ZH18N/M/P Zetec E)	Petrol	1796	4	22
06/93→08/96	Mondeo I Estate 1.8 TD	RFM	Diesel	1753	4	28
11/95→08/96	Mondeo I Estate 1.8 TD	RFM	Diesel	1753	4	28
06/93→08/96	Mondeo I Estate 1.8 TD	RFN	Diesel	1753	4	28
11/95→08/96	Mondeo I Estate 1.8 TD	RFN	Diesel	1753	4	28
01/93→08/96	Mondeo I Estate 2.0 i 16V	NGA (ZH20 Zetec E)	Petrol	1988	4	33
04/93→08/96	Mondeo I Estate 2.0 i 16V	NGA (ZH20 Zetec E)	Petrol	1988	4	33
04/93→08/96	Mondeo I Estate 2.0 i 16V 4x4	NGA (ZH20 Zetec E)	Petrol	1988	4	33
12/94→08/96	Mondeo I Estate 2.0 i 16V 4x4	NGA (ZH20 Zetec E)	Petrol	1988	4	33
02/93→08/96	Mondeo I Saloon 1.6 i 16V	L1F (Zetec)	Petrol	1597	4	11
07/94→08/96	Mondeo I Saloon 1.6 i 16V	L1J (Zetec E)	Petrol	1597	4	11
02/93→08/96	Mondeo I Saloon 1.8 4x4	RKA (ZH18N/M/P Zetec E)	Petrol	1796	4	22
02/93→08/96	Mondeo I Saloon 1.8 i 16V	RKA (ZH18N/M/P Zetec E)	Petrol	1796	4	22
01/94→08/96	Mondeo I Saloon 1.8 i 16V	RKB (ZH18N/M/P Zetec E)	Petrol	1796	4	22
06/93→08/96	Mondeo I Saloon 1.8 TD	RFM	Diesel	1753	4	28
10/95→08/96	Mondeo I Saloon 1.8 TD	RFM	Diesel	1753	4	28
06/93→08/96	Mondeo I Saloon 1.8 TD	RFN	Diesel	1753	4	28
10/95→08/96	Mondeo I Saloon 1.8 TD	RFN	Diesel	1753	4	28
02/93→08/96	Mondeo I Saloon 2.0 i 16V	NGA (ZH20 Zetec E)	Petrol	1988	4	33
02/93→08/96	Mondeo I Saloon 2.0 i 16V 4x4	NGA (ZH20 Zetec E)	Petrol	1988	4	33
12/94→08/96	Mondeo I Saloon 2.0 i 16V 4x4	NGA (ZH20 Zetec E)	Petrol	1988	4	33
09/96→11/00	Mondeo II 1.6 i	L1J (Zetec E)	Petrol	1597	4	11
05/98→11/00	Mondeo II 1.6 i 16V	L1L (Zetec E)	Petrol	1597	4	11
05/98→11/00	Mondeo II 1.6 i 16V	L1N (Zetec E)	Petrol	1597	4	11
05/98→11/00	Mondeo II 1.6 i 16V	L1Q (Zetec E)	Petrol	1597	4	11
09/96→11/00	Mondeo II 1.8 i	RKB (ZH18N/M/P Zetec E)	Petrol	1796	4	22
09/96→11/00	Mondeo II 1.8 i	RKF (ZH18N/M/P Zetec E)	Petrol	1796	4	22
09/96→11/00	Mondeo II 1.8 i	RKH (ZH18N/M/P Zetec E)	Petrol	1796	4	22
09/96→11/00	Mondeo II 1.8 i	RKJ (ZH18N/M/P Zetec E)	Petrol	1796	4	22
09/96→11/00	Mondeo II 1.8 i	RKK (ZH18N/M/P Zetec E)	Petrol	1796	4	22
09/96→11/00	Mondeo II 1.8 TD	RFN	Diesel	1753	4	28
09/96→11/00	Mondeo II 2.0 i	NGA (ZH20 Zetec E)	Petrol	1988	4	33
09/96→11/00	Mondeo II Estate 1.6 i	L1J (Zetec E)	Petrol	1597	4	11
05/98→11/00	Mondeo II Estate 1.6 i 16V	L1L (Zetec E)	Petrol	1597	4	11
05/98→11/00	Mondeo II Estate 1.6 i 16V	L1N (Zetec E)	Petrol	1597	4	11
05/98→11/00	Mondeo II Estate 1.6 i 16V	L1Q (Zetec E)	Petrol	1597	4	11
09/96→11/00	Mondeo II Estate 1.8 i	RKB (ZH18N/M/P Zetec E)	Petrol	1796	4	22
09/96→11/00	Mondeo II Estate 1.8 i	RKF (ZH18N/M/P Zetec E)	Petrol	1796	4	22
09/96→11/00	Mondeo II Estate 1.8 i	RKH (ZH18N/M/P Zetec E)	Petrol	1796	4	22
09/96→11/00	Mondeo II Estate 1.8 i	RKJ (ZH18N/M/P Zetec E)	Petrol	1796	4	22
09/96→11/00	Mondeo II Estate 1.8 i	RKK (ZH18N/M/P Zetec E)	Petrol	1796	4	22
09/96→11/00	Mondeo II Estate 1.8 TD	RFN	Diesel	1753	4	28
09/96→11/00	Mondeo II Estate 2.0 i	NGA (ZH20 Zetec E)	Petrol	1988	4	33
09/96→11/00	Mondeo II Saloon 1.6 i	L1J (Zetec E)	Petrol	1597	4	11
05/98→11/00	Mondeo II Saloon 1.6 i 16V	L1L (Zetec E)	Petrol	1597	4	11
05/98→11/00	Mondeo II Saloon 1.6 i 16V	L1N (Zetec E)	Petrol	1597	4	11
05/98→11/00	Mondeo II Saloon 1.6 i 16V	L1Q (Zetec E)	Petrol	1597	4	11
09/96→11/00	Mondeo II Saloon 1.8 i	RKB (ZH18N/M/P Zetec E)	Petrol	1796	4	22
09/96→11/00	Mondeo II Saloon 1.8 i	RKF (ZH18N/M/P Zetec E)	Petrol	1796	4	22
09/96→11/00	Mondeo II Saloon 1.8 i	RKH (ZH18N/M/P Zetec E)	Petrol	1796	4	22
09/96→11/00	Mondeo II Saloon 1.8 i	RKJ (ZH18N/M/P Zetec E)	Petrol	1796	4	22
09/96→11/00	Mondeo II Saloon 1.8 i	RKK (ZH18N/M/P Zetec E)	Petrol	1796	4	22
09/96→11/00	Mondeo II Saloon 1.8 TD	RFN	Diesel	1753	4	28
09/96→11/00	Mondeo II Saloon 2.0 i	NGA (ZH20 Zetec E)	Petrol	1988	4	33
11/00→08/07	Mondeo III 1.8 16V	CGBA (Duratec HE)	Petrol	1796	4	30

MODEL INDEX

Modelverzeichnis • Index de modele • Índice de Modelo
Indeks modelu • Модель автомобиля • دليل الموديل



CCM

x



9

11/00→08/07	Mondeo III 1.8 16V	CGBB (Duratec HE)	Petrol	1796	4	30
11/00→08/07	Mondeo III 1.8 16V	CHBA	Petrol	1796	4	30
11/00→08/07	Mondeo III 1.8 16V	CHBB	Petrol	1796	4	30
11/00→08/07	Mondeo III 2.0 16V	CJBA (Duratec HE)	Petrol	1999	4	41
11/00→08/07	Mondeo III 2.0 16V	CJBB (Duratec HE)	Petrol	1999	4	41
11/00→08/07	Mondeo III 2.0 16V DI / TDDi / TDCi	D5BA (Duratorq)	Diesel	1998	4	36
11/00→08/07	Mondeo III 2.0 16V DI / TDDi / TDCi	SDBA (Duratorq)	Diesel	1998	4	36
11/00→08/07	Mondeo III 2.0 16V TDDi / TDCi	D6BA (Duratorq)	Diesel	1998	4	36
11/00→08/07	Mondeo III 2.0 16V TDDi / TDCi	HJBA (Duratorq)	Diesel	1998	4	36
11/00→08/07	Mondeo III 2.0 16V TDDi / TDCi	HJBB (Duratorq)	Diesel	1998	4	36
11/00→08/07	Mondeo III 2.0 16V TDDi / TDCi	HJBC (Duratorq)	Diesel	1998	4	36
10/01→08/07	Mondeo III 2.0 TDCi	FMBA (Duratorq)	Diesel	1998	4	36
10/01→08/07	Mondeo III 2.0 TDCi	N7BA (Duratorq)	Diesel	1998	4	36
09/04→08/07	Mondeo III 2.2 TDCi	QJBA (Duratorq)	Diesel	2198	4	38
09/04→08/07	Mondeo III 2.2 TDCi	QJBB (Duratorq)	Diesel	2198	4	38
09/04→08/07	Mondeo III 2.2 TDCi	QJBC (Duratorq)	Diesel	2198	4	38
09/04→08/07	Mondeo III 2.2 TDCi	QJBD (Duratorq)	Diesel	2198	4	38
11/00→08/07	Mondeo III Estate 1.8 16V	CGBA (Duratec HE)	Petrol	1796	4	30
11/00→08/07	Mondeo III Estate 1.8 16V	CGBB (Duratec HE)	Petrol	1796	4	30
11/00→08/07	Mondeo III Estate 1.8 16V	CHBA	Petrol	1796	4	30
11/00→08/07	Mondeo III Estate 1.8 16V	CHBB	Petrol	1796	4	30
11/00→08/07	Mondeo III Estate 2.0 16V	CJBA (Duratec HE)	Petrol	1999	4	41
11/00→08/07	Mondeo III Estate 2.0 16V	CJBB (Duratec HE)	Petrol	1999	4	41
11/00→08/07	Mondeo III Estate 2.0 16V DI / TDDi / TDCi	D5BA (Duratorq)	Diesel	1998	4	36
11/00→08/07	Mondeo III Estate 2.0 16V DI / TDDi / TDCi	SDBA (Duratorq)	Diesel	1998	4	36
11/00→08/07	Mondeo III Estate 2.0 16V TDDi / TDCi	D6BA (Duratorq)	Diesel	1998	4	36
11/00→08/07	Mondeo III Estate 2.0 16V TDDi / TDCi	HJBA (Duratorq)	Diesel	1998	4	36
11/00→08/07	Mondeo III Estate 2.0 16V TDDi / TDCi	HJBB (Duratorq)	Diesel	1998	4	36
11/00→08/07	Mondeo III Estate 2.0 16V TDDi / TDCi	HJBC (Duratorq)	Diesel	1998	4	36
10/01→08/07	Mondeo III Estate 2.0 TDCi	FMBA (Duratorq)	Diesel	1998	4	36
10/01→08/07	Mondeo III Estate 2.0 TDCi	N7BA (Duratorq)	Diesel	1998	4	36
09/04→08/07	Mondeo III Estate 2.2 TDCi	QJBA (Duratorq)	Diesel	2198	4	38
09/04→08/07	Mondeo III Estate 2.2 TDCi	QJBB (Duratorq)	Diesel	2198	4	38
09/04→08/07	Mondeo III Estate 2.2 TDCi	QJBC (Duratorq)	Diesel	2198	4	38
09/04→08/07	Mondeo III Estate 2.2 TDCi	QJBD (Duratorq)	Diesel	2198	4	38
11/00→08/07	Mondeo III Saloon 1.8 16V	CGBA (Duratec HE)	Petrol	1796	4	30
11/00→08/07	Mondeo III Saloon 1.8 16V	CGBB (Duratec HE)	Petrol	1796	4	30
11/00→08/07	Mondeo III Saloon 1.8 16V	CHBA	Petrol	1796	4	30
11/00→08/07	Mondeo III Saloon 1.8 16V	CHBB	Petrol	1796	4	30
11/00→08/07	Mondeo III Saloon 2.0 16V	CJBA (Duratec HE)	Petrol	1999	4	41
11/00→08/07	Mondeo III Saloon 2.0 16V	CJBB (Duratec HE)	Petrol	1999	4	41
11/00→08/07	Mondeo III Saloon 2.0 16V DI / TDDi / TDCi	D5BA (Duratorq)	Diesel	1998	4	36
11/00→08/07	Mondeo III Saloon 2.0 16V DI / TDDi / TDCi	SDBA (Duratorq)	Diesel	1998	4	36
11/00→08/07	Mondeo III Saloon 2.0 16V TDDi / TDCi	D6BA (Duratorq)	Diesel	1998	4	36
11/00→08/07	Mondeo III Saloon 2.0 16V TDDi / TDCi	HJBA (Duratorq)	Diesel	1998	4	36
11/00→08/07	Mondeo III Saloon 2.0 16V TDDi / TDCi	HJBB (Duratorq)	Diesel	1998	4	36
11/00→08/07	Mondeo III Saloon 2.0 16V TDDi / TDCi	HJBC (Duratorq)	Diesel	1998	4	36
10/01→08/07	Mondeo III Saloon 2.0 TDCi	FMBA (Duratorq)	Diesel	1998	4	36
10/01→08/07	Mondeo III Saloon 2.0 TDCi	N7BA (Duratorq)	Diesel	1998	4	36
09/04→08/07	Mondeo III Saloon 2.2 TDCi	QJBA (Duratorq)	Diesel	2198	4	38
09/04→08/07	Mondeo III Saloon 2.2 TDCi	QJBB (Duratorq)	Diesel	2198	4	38
09/04→08/07	Mondeo III Saloon 2.2 TDCi	QJBC (Duratorq)	Diesel	2198	4	38
09/04→08/07	Mondeo III Saloon 2.2 TDCi	QJBD (Duratorq)	Diesel	2198	4	38
02/11→	Mondeo IV 1.6 TDCi	T1BA (Duratorq TDCI)	Diesel	1560	4	8
02/11→	Mondeo IV 1.6 TDCi	T1BB (Duratorq TDCI)	Diesel	1560	4	8
02/11→	Mondeo IV 1.6 TDCi	T1BC (Duratorq TDCI)	Diesel	1560	4	8
03/07→	Mondeo IV 1.6 Ti	RHBA	Petrol	1596	4	15
03/07→	Mondeo IV 1.8 TDCi	FFBA	Diesel	1753	4	27
06/07→	Mondeo IV 1.8 TDCi	KHBA (Duratorq TDCI)	Diesel	1753	4	27
06/07→	Mondeo IV 1.8 TDCi	QYBA (Duratorq TDCI)	Diesel	1753	4	27



CCM

x



9

07/10→	Mondeo IV 2.2 TDCi	KNBA (Duratorq TDCI)	Diesel	2179	4	35
07/10→	Mondeo IV 2.2 TDCi	KNBB (Duratorq TDCI)	Diesel	2179	4	35
03/07→	Mondeo IV Saloon 1.6 Ti	RHBA	Petrol	1596	4	15
03/07→	Mondeo IV Saloon 1.8 TDCi	FFBA	Diesel	1753	4	27
06/07→	Mondeo IV Saloon 1.8 TDCi	KHBA (Duratorq TDCI)	Diesel	1753	4	27
06/07→	Mondeo IV Saloon 1.8 TDCi	QYBA (Duratorq TDCI)	Diesel	1753	4	27
02/11→	Mondeo IV Turnier 1.6 TDCi	T1BA (Duratorq TDCI)	Diesel	1560	4	8
02/11→	Mondeo IV Turnier 1.6 TDCi	T1BB (Duratorq TDCI)	Diesel	1560	4	8
02/11→	Mondeo IV Turnier 1.6 TDCi	T1BC (Duratorq TDCI)	Diesel	1560	4	8
03/07→	Mondeo IV Turnier 1.6 Ti	RHBA	Petrol	1596	4	15
03/07→	Mondeo IV Turnier 1.8 TDCi	FFBA	Diesel	1753	4	27
06/07→	Mondeo IV Turnier 1.8 TDCi	KHBA (Duratorq TDCI)	Diesel	1753	4	27
06/07→	Mondeo IV Turnier 1.8 TDCi	QYBA (Duratorq TDCI)	Diesel	1753	4	27
07/10→	Mondeo IV Turnier 2.2 TDCi	KNBA (Duratorq TDCI)	Diesel	2179	4	35
07/83→03/86	Orion I 1.3	JPA	Petrol	1296	4	19
07/83→03/86	Orion I 1.6	LP1	Petrol	1597	4	19
07/83→03/86	Orion I 1.6	LPA (HL16H CVH)	Petrol	1597	4	19
02/84→03/86	Orion I 1.6 D	LTA (D16)	Diesel	1608	4	21
07/83→03/86	Orion I 1.6 i	LR1 (HL16I CVH)	Petrol	1597	4	19
07/83→03/86	Orion I 1.6 i	LRA (HL16I CVH)	Petrol	1597	4	19
12/85→07/90	Orion II 1.3	JBB (BL13H)	Petrol	1299	4	6
12/85→07/90	Orion II 1.3	JLA	Petrol	1299	4	5
12/85→07/90	Orion II 1.3	JLB	Petrol	1299	4	5
11/86→07/88	Orion II 1.3	JPA	Petrol	1296	4	19
12/85→07/90	Orion II 1.4	FUA (HL14G CVH)	Petrol	1392	4	13
03/86→07/90	Orion II 1.4	FUAA (HL14G CVH)	Petrol	1392	4	13
01/86→07/90	Orion II 1.4	FUC (HL14G CVH)	Petrol	1392	4	13
02/87→07/90	Orion II 1.4 CAT	F6B (HL14G CVH)	Petrol	1392	4	13
02/87→07/90	Orion II 1.4 CAT	F6D (HL14G CVH)	Petrol	1392	4	13
04/86→12/88	Orion II 1.6	LP2 (HL16H CVH)	Petrol	1597	4	19
12/85→07/90	Orion II 1.6	LUC (HL16H CVH)	Petrol	1597	4	19
03/86→08/90	Orion II 1.6	LUG (HL16H CVH)	Petrol	1597	4	19
12/85→01/89	Orion II 1.6 D	LTC (D16)	Diesel	1608	4	21
08/89→07/90	Orion II 1.6 i	LJB (HL16I CVH)	Petrol	1597	4	19
03/86→07/90	Orion II 1.6 i	LRB (HL16I CVH)	Petrol	1597	4	19
03/86→07/90	Orion II 1.6 i CAT	L4B (HL16I CVH)	Petrol	1598	4	19
01/89→07/90	Orion II 1.8 D	RTA (D18NA)	Diesel	1753	4	29
01/89→07/90	Orion II 1.8 D	RTB (D18NA)	Diesel	1753	4	29
07/90→12/93	Orion III 1.3	J4B / BL13 (Endura E)	Petrol	1299	4	6
07/90→12/93	Orion III 1.3	J6A (BL13)	Petrol	1299	4	6
07/90→12/93	Orion III 1.4	F6F (HL14CFI CVH)	Petrol	1392	4	13
07/90→12/93	Orion III 1.4	F6G (HL14CFI CVH)	Petrol	1392	4	13
07/90→12/93	Orion III 1.4	FUH (HL14EFI CVH)	Petrol	1392	4	13
07/90→12/92	Orion III 1.6	LUJ (HL16G CVH)	Petrol	1597	4	19
07/90→12/92	Orion III 1.6	LUK (HL16G CVH)	Petrol	1597	4	19
07/90→09/92	Orion III 1.6 i	LJF	Petrol	1597	4	19
07/92→12/93	Orion III 1.6 i 16V	L1E (Zetec)	Petrol	1597	4	11
07/92→12/93	Orion III 1.6 i 16V	L1K (Zetec E)	Petrol	1597	4	11
11/90→12/93	Orion III 1.8 D	RTE (D18NA)	Diesel	1753	4	29
11/90→12/93	Orion III 1.8 D	RTF (D18NA)	Diesel	1753	4	29
11/90→12/93	Orion III 1.8 D	RTH (D18NA)	Diesel	1753	4	29
02/92→12/93	Orion III 1.8 i 16V	RDA (ZH18N/M/P Zetec E)	Petrol	1796	4	22
01/92→12/93	Orion III 1.8 i 16V	RQB (ZH18N/M/P Zetec E)	Petrol	1796	4	22
03/92→12/93	Orion III 1.8 TD	RFD	Diesel	1753	4	28
03/92→12/93	Orion III 1.8 TD	RFK	Diesel	1753	4	28
04/82→09/87	P 100 I 1.6	LCR	Petrol	1594	4	43
10/87→12/92	P 100 II 1.8 TD	RFA (D18T)	Diesel	1753	4	28
10/87→12/92	P 100 II 2.0	NAE (TL20L)	Petrol	1993	4	51
11/97→10/00	Puma 1.4 16V	FHD (Zetec SE)	Petrol	1388	4	10
11/97→10/00	Puma 1.4 16V	FHF (Zetec SE)	Petrol	1388	4	10

MODEL INDEX

Modelverzeichnis • Index de modele • Índice de Modelo
Indeks modelu • Модель автомобиля • دليل الموديل



CCM

x



9

08/00→06/02	Puma 1.6 16V	L1W	Petrol	1596	4	14
06/99→02/02	Ranger 1.8	RKA (ZH18N/M/P Zetec E)	Petrol	1796	4	22
04/85→08/89	Scorpio 2.0	NE1	Petrol	1993	4	51
04/85→08/89	Scorpio 2.0	NE4	Petrol	1993	4	51
01/82→	Scorpio 2.3 D	XD2S	Diesel	2304	4	60
01/86→12/94	Scorpio 2.4 EFi	TV24	Petrol	2394	V6	31
04/85→02/92	Scorpio I 1.8	REC	Petrol	1796	4	40
04/85→08/89	Scorpio I 2.0	N8D (N8C (TL20H))	Petrol	1993	4	51
04/85→08/89	Scorpio I 2.0	NEL (N8C (TL20H))	Petrol	1993	4	51
02/92→09/94	Scorpio I 2.0 i	NRA	Petrol	1993	4	51
04/85→02/92	Scorpio I 2.0 i	NRA	Petrol	1993	4	51
02/92→09/94	Scorpio I 2.0 i	NRI	Petrol	1993	4	51
04/85→02/92	Scorpio I 2.0 i	NRI	Petrol	1993	4	51
09/86→09/88	Scorpio I 2.4 i	ARC	Petrol	2394	V6	31
10/88→02/92	Scorpio I 2.4 i	ARD	Petrol	2394	V6	31
10/88→09/94	Scorpio I 2.4 i CAT	ARD	Petrol	2394	V6	31
12/85→02/92	Scorpio I 2.5 D	STR (XD3/XD3P)	Diesel	2498	4	61
08/93→09/94	Scorpio I 2.5 TD	SCB	Diesel	2500	4	53
06/88→07/93	Scorpio I 2.5 TD	SFA (XD3T)	Diesel	2498	4	60
06/88→07/93	Scorpio I 2.5 TD	SFB (XD3T)	Diesel	2498	4	60
04/85→11/86	Scorpio I 2.8 i	PRE (TV28)	Petrol	2792	V6	55
10/85→11/86	Scorpio I 2.8 i 4x4	PRE (TV28)	Petrol	2792	V6	55
09/86→09/94	Scorpio I 2.9 i	BRC	Petrol	2935	V6	54
09/86→09/94	Scorpio I 2.9 i	BRD	Petrol	2935	V6	54
09/86→09/94	Scorpio I 2.9 i	BRE	Petrol	2935	V6	54
09/86→09/94	Scorpio I 2.9 i	BRF	Petrol	2935	V6	54
04/91→09/94	Scorpio I 2.9 i 24V	BOA	Petrol	2935	V6	54
09/86→09/94	Scorpio I 2.9 i 4x4	BRC	Petrol	2935	V6	54
05/88→02/93	Scorpio I 2.9 i 4x4	BRD	Petrol	2935	V6	54
05/88→02/93	Scorpio I 2.9 i 4x4	BRE	Petrol	2935	V6	54
05/88→02/93	Scorpio I 2.9 i 4x4	BRF	Petrol	2935	V6	54
10/87→09/94	Scorpio I 2.9 i CAT	BRE	Petrol	2935	V6	54
09/91→09/94	Scorpio I Estate 2.0 i	N9F (DL20)	Petrol	1998	4	37
09/91→09/94	Scorpio I Estate 2.4 i	ARD	Petrol	2394	V6	31
10/90→08/92	Scorpio I Estate 2.5 D	STR (XD3/XD3P)	Diesel	2498	4	61
08/93→09/94	Scorpio I Estate 2.5 TD	SCB	Diesel	2500	4	53
09/91→07/93	Scorpio I Estate 2.5 TD	SFA (XD3T)	Diesel	2498	4	60
09/91→07/93	Scorpio I Estate 2.5 TD	SFB (XD3T)	Diesel	2498	4	60
08/93→09/94	Scorpio I Estate 2.9 24V	BOA	Petrol	2935	V6	54
09/91→09/94	Scorpio I Estate 2.9 i	BRD	Petrol	2935	V6	54
09/91→09/94	Scorpio I Estate 2.9 i	BRE	Petrol	2935	V6	54
09/91→09/94	Scorpio I Estate 2.9 i	BRF	Petrol	2935	V6	54
05/88→02/93	Scorpio I Estate 2.9 i 4x4	BRD	Petrol	2935	V6	54
05/88→02/93	Scorpio I Estate 2.9 i 4x4	BRE	Petrol	2935	V6	54
05/88→02/93	Scorpio I Estate 2.9 i 4x4	BRF	Petrol	2935	V6	54
01/86→10/88	Scorpio I Saloon 1.8	REC	Petrol	1796	4	40
11/92→09/93	Scorpio I Saloon 1.9	NRA	Petrol	1993	4	51
02/92→09/94	Scorpio I Saloon 2.0 i	N9F (DL20)	Petrol	1998	4	37
10/88→10/94	Scorpio I Saloon 2.4 i	ARD	Petrol	2394	V6	31
12/89→12/94	Scorpio I Saloon 2.5 D	STR (XD3/XD3P)	Diesel	2498	4	61
08/93→09/94	Scorpio I Saloon 2.5 TD	SCB	Diesel	2500	4	53
06/88→07/93	Scorpio I Saloon 2.5 TD	SFA (XD3T)	Diesel	2498	4	60
06/88→07/93	Scorpio I Saloon 2.5 TD	SFB (XD3T)	Diesel	2498	4	60
09/86→12/94	Scorpio I Saloon 2.9 i	BRD	Petrol	2935	V6	54
09/86→12/94	Scorpio I Saloon 2.9 i	BRE	Petrol	2935	V6	54
09/86→12/94	Scorpio I Saloon 2.9 i	BRF	Petrol	2935	V6	54
04/91→09/94	Scorpio I Saloon 2.9 i 24V	BOA	Petrol	2935	V6	54
12/89→10/94	Scorpio I Saloon 2.9 i 4x4	BRD	Petrol	2935	V6	54
12/89→10/94	Scorpio I Saloon 2.9 i 4x4	BRE	Petrol	2935	V6	54
12/89→10/94	Scorpio I Saloon 2.9 i 4x4	BRF	Petrol	2935	V6	54

CCM
x

9

10/94→08/98	Scorpio II 2.0 i	NSD (DL20)	Petrol	1998	4	37
10/94→08/98	Scorpio II 2.0 i 16V	N3A (DH20)	Petrol	1998	4	37
06/96→08/98	Scorpio II 2.3 i 16V	Y5A	Petrol	2295	4	45
10/94→08/98	Scorpio II 2.5 TD	SCC	Diesel	2500	4	53
09/96→08/98	Scorpio II 2.5 TD	VM	Diesel	2500	4	53
02/95→08/98	Scorpio II 2.9 i	BRG	Petrol	2935	V6	54
10/94→08/98	Scorpio II 2.9 i 24V	BOB	Petrol	2935	V6	54
10/94→08/98	Scorpio II Estate 2.0 i	NSD (DL20)	Petrol	1998	4	37
10/94→08/98	Scorpio II Estate 2.0 i 16V	N3A (DH20)	Petrol	1998	4	37
06/96→08/98	Scorpio II Estate 2.3 i 16V	Y5A	Petrol	2295	4	45
10/94→08/98	Scorpio II Estate 2.5 TD	SCC	Diesel	2500	4	53
09/96→08/98	Scorpio II Estate 2.5 TD	VM	Diesel	2500	4	53
02/95→08/98	Scorpio II Estate 2.9 i	BRG	Petrol	2935	V6	54
10/94→08/98	Scorpio II Estate 2.9 i 24V	BOB	Petrol	2935	V6	54
01/87→02/93	Sierra 1.6	LSE (TL16E E-MAX)	Petrol	1593	4	25
01/84→02/93	Sierra 1.6	TL 16 L	Petrol	1593	4	42
10/89→02/93	Sierra 1.6 i	L6B	Petrol	1597	4	19
01/87→05/88	Sierra 1.8	R2A	Petrol	1796	4	40
05/88→02/93	Sierra 1.8	R2C (HL18H CVH)	Petrol	1769	4	18
05/88→02/93	Sierra 1.8	R6A (HL18H CVH)	Petrol	1769	4	18
01/87→05/88	Sierra 1.8	RED	Petrol	1796	4	40
10/87→09/89	Sierra 1.8	RED	Petrol	1796	4	40
10/87→09/89	Sierra 1.8	REF	Petrol	1796	4	40
08/88→02/93	Sierra 1.8 TD	RFA (D18T)	Diesel	1753	4	28
08/88→02/93	Sierra 1.8 TD	RFB (D18T)	Diesel	1753	4	28
08/88→02/93	Sierra 1.8 TD	RFL (D18T)	Diesel	1753	4	28
01/87→02/93	Sierra 2.0	N8C (DL20H)	Petrol	1998	4	37
01/87→02/93	Sierra 2.0	NES (N8C (TL20H))	Petrol	1993	4	51
01/90→02/93	Sierra 2.0 16V Cosworth 4x4	N5C	Petrol	1993	4	52
01/90→02/93	Sierra 2.0 4x4	N9C (DL20)	Petrol	1998	4	37
01/87→02/93	Sierra 2.0 i	N4A	Petrol	1993	4	51
01/87→02/93	Sierra 2.0 i	N4I	Petrol	1993	4	51
01/90→02/93	Sierra 2.0 i	N9C (DL20)	Petrol	1998	4	37
01/87→12/89	Sierra 2.0 i	NE5	Petrol	1993	4	51
01/87→12/89	Sierra 2.0 i	NEJ	Petrol	1993	4	51
01/87→12/90	Sierra 2.0 RS Cosworth	N5B	Petrol	1993	4	52
01/82→12/85	Sierra 2.0 V6	EV20H	Petrol	1995	V6	32
01/82→	Sierra 2.3 D	XD2S	Diesel	2304	4	60
01/87→09/89	Sierra 2.3 D	YTR (XD2/XD2P/XD94)	Diesel	2304	4	61
01/87→09/89	Sierra 2.3 D	YTT (XD2/XD2P/XD94)	Diesel	2304	4	61
08/87→02/93	Sierra 2.8 i	PR8 (TV28)	Petrol	2792	V6	55
08/88→02/93	Sierra 2.9 4x4	B4B	Petrol	2935	V6	54
08/88→02/93	Sierra 2.9 4x4	B4C	Petrol	2935	V6	54
08/88→02/93	Sierra 2.9 i	B4B	Petrol	2935	V6	54
08/88→02/93	Sierra 2.9 i	B4C	Petrol	2935	V6	54
01/82→12/85	Sierra 2300 Ghia	XD2S	Diesel	2304	4	60
01/82→12/85	Sierra 2300 GL	XD2S	Diesel	2304	4	60
08/82→12/86	Sierra Estate 1.6	LCS	Petrol	1593	4	25
08/82→12/86	Sierra Estate 1.6	LCT	Petrol	1593	4	25
08/82→12/86	Sierra Estate 1.6	LSD (TL16E E-MAX)	Petrol	1593	4	25
01/87→02/93	Sierra Estate 1.6	LSE (TL16E E-MAX)	Petrol	1593	4	25
10/89→02/93	Sierra Estate 1.6 i	L6B	Petrol	1597	4	19
01/87→05/88	Sierra Estate 1.8	R2A	Petrol	1796	4	40
05/88→02/93	Sierra Estate 1.8	R2C (HL18H CVH)	Petrol	1769	4	18
05/88→02/93	Sierra Estate 1.8	R6A (HL18H CVH)	Petrol	1769	4	18
10/84→12/86	Sierra Estate 1.8	REB	Petrol	1796	4	40
01/87→05/88	Sierra Estate 1.8	RED	Petrol	1796	4	40
10/87→05/88	Sierra Estate 1.8	RED	Petrol	1796	4	40
10/87→05/88	Sierra Estate 1.8	REF	Petrol	1796	4	40
08/88→02/93	Sierra Estate 1.8 TD	RFA (D18T)	Diesel	1753	4	28

MODEL INDEX

Modelverzeichnis • Index de modele • Índice de Modelo
Indeks modelu • Модель автомобиля • دليل الموديل



CCM

x



9

08/88→02/93	Sierra Estate 1.8 TD	RFB (D18T)	Diesel	1753	4	28
08/88→02/93	Sierra Estate 1.8 TD	RFL (D18T)	Diesel	1753	4	28
01/87→02/93	Sierra Estate 2.0	N8C (DL20H)	Petrol	1998	4	37
01/87→02/93	Sierra Estate 2.0	NES (N8C (TL20H))	Petrol	1993	4	51
08/82→12/86	Sierra Estate 2.0	NET (N8C (TL20H))	Petrol	1993	4	51
03/85→12/86	Sierra Estate 2.0	NR2	Petrol	1993	4	51
03/85→12/86	Sierra Estate 2.0	NRB	Petrol	1993	4	51
10/85→12/86	Sierra Estate 2.0	NRD	Petrol	1993	4	51
08/82→10/84	Sierra Estate 2.0	NYT	Petrol	1999	V6	32
02/90→02/93	Sierra Estate 2.0 4x4	N9C (DL20)	Petrol	1998	4	37
05/89→02/93	Sierra Estate 2.0 4x4	N9C (DL20)	Petrol	1998	4	37
01/87→02/93	Sierra Estate 2.0 i	N4A	Petrol	1993	4	51
01/87→02/93	Sierra Estate 2.0 i	N4I	Petrol	1993	4	51
05/89→02/93	Sierra Estate 2.0 i	N9C (DL20)	Petrol	1998	4	37
01/87→02/93	Sierra Estate 2.0 i	NE5	Petrol	1993	4	51
01/87→02/93	Sierra Estate 2.0 i	NEJ	Petrol	1993	4	51
08/82→12/86	Sierra Estate 2.3	YYT	Petrol	2293	V6	48
01/87→02/93	Sierra Estate 2.3 D	YTR (XD2/XD2P/XD94)	Diesel	2304	4	61
08/82→12/86	Sierra Estate 2.3 D	YTT (XD2/XD2P/XD94)	Diesel	2304	4	61
01/87→08/88	Sierra Estate 2.8 4x4	PRG (TV28)	Petrol	2792	V6	55
01/87→02/93	Sierra Estate 2.8 i	PR7 (TV28)	Petrol	2792	V6	55
01/87→02/93	Sierra Estate 2.8 i	PR8 (TV28)	Petrol	2792	V6	55
08/82→12/86	Sierra Estate 2.8 i 4x4	PR6 (TV28)	Petrol	2792	V6	55
01/87→02/93	Sierra Estate 2.8 i 4x4	PR7 (TV28)	Petrol	2792	V6	55
08/82→12/86	Sierra Estate 2.8 XR4i	PR5 (TV28)	Petrol	2792	V6	55
08/82→12/86	Sierra Estate 2.8 XR4i	PR6 (TV28)	Petrol	2792	V6	55
08/88→02/93	Sierra Estate 2.9	B4B	Petrol	2935	V6	54
08/88→02/93	Sierra Estate 2.9	B4C	Petrol	2935	V6	54
08/88→02/93	Sierra Estate 2.9 4x4	B4B	Petrol	2935	V6	54
08/88→02/93	Sierra Estate 2.9 4x4	B4C	Petrol	2935	V6	54
08/88→02/93	Sierra Estate 2.9 i	B4B	Petrol	2935	V6	54
08/88→02/93	Sierra Estate 2.9 i	B4C	Petrol	2935	V6	54
08/82→12/86	Sierra Hatchback 1.6	LCS	Petrol	1593	4	25
08/82→12/86	Sierra Hatchback 1.6	LCT	Petrol	1593	4	25
08/82→12/86	Sierra Hatchback 1.6	LSD (TL16E E-MAX)	Petrol	1593	4	25
08/84→12/86	Sierra Hatchback 1.6	LSD (TL16E E-MAX)	Petrol	1593	4	25
01/87→02/93	Sierra Hatchback 1.6	LSE (TL16E E-MAX)	Petrol	1593	4	25
10/89→02/93	Sierra Hatchback 1.6 i	L6B	Petrol	1597	4	19
01/87→05/88	Sierra Hatchback 1.8	R2A	Petrol	1796	4	40
05/88→02/93	Sierra Hatchback 1.8	R2C (HL18H CVH)	Petrol	1769	4	18
05/88→02/93	Sierra Hatchback 1.8	R6A (HL18H CVH)	Petrol	1769	4	18
10/84→12/86	Sierra Hatchback 1.8	REB	Petrol	1796	4	40
01/87→05/88	Sierra Hatchback 1.8	RED	Petrol	1796	4	40
10/87→05/88	Sierra Hatchback 1.8	RED	Petrol	1796	4	40
10/87→05/88	Sierra Hatchback 1.8	REF	Petrol	1796	4	40
08/88→02/93	Sierra Hatchback 1.8 TD	RFA (D18T)	Diesel	1753	4	28
08/88→02/93	Sierra Hatchback 1.8 TD	RFB (D18T)	Diesel	1753	4	28
08/88→02/93	Sierra Hatchback 1.8 TD	RFL (D18T)	Diesel	1753	4	28
01/87→02/93	Sierra Hatchback 2.0	N8C (DL20H)	Petrol	1998	4	37
01/87→02/93	Sierra Hatchback 2.0	NES (N8C (TL20H))	Petrol	1993	4	51
08/82→12/86	Sierra Hatchback 2.0	NET (N8C (TL20H))	Petrol	1993	4	51
10/85→12/86	Sierra Hatchback 2.0	NRD	Petrol	1993	4	51
08/82→10/84	Sierra Hatchback 2.0	NYT	Petrol	1999	V6	32
01/90→02/93	Sierra Hatchback 2.0 16V Cosworth 4x4	N5D	Petrol	1993	4	52
01/90→02/93	Sierra Hatchback 2.0 16V Cosworth 4x4 CAT	N5C	Petrol	1993	4	52
10/85→02/87	Sierra Hatchback 2.0 4x4	N5B	Petrol	1993	4	52
10/91→03/93	Sierra Hatchback 2.0 4x4	N9C (DL20)	Petrol	1998	4	37
01/87→02/93	Sierra Hatchback 2.0 i	N4A	Petrol	1993	4	51
01/87→02/93	Sierra Hatchback 2.0 i	N4I	Petrol	1993	4	51
06/89→02/93	Sierra Hatchback 2.0 i	N9C (DL20)	Petrol	1998	4	37



CCM

x



9

01/87→02/93	Sierra Hatchback 2.0 i	NE5	Petrol	1993	4	51
01/87→02/93	Sierra Hatchback 2.0 i	NEJ	Petrol	1993	4	51
03/85→12/86	Sierra Hatchback 2.0 i	NR2	Petrol	1993	4	51
03/85→12/86	Sierra Hatchback 2.0 i	NRB	Petrol	1993	4	51
11/87→01/90	Sierra Hatchback 2.0 RS Cosworth	N5B	Petrol	1993	4	52
08/82→12/86	Sierra Hatchback 2.3	YYT	Petrol	2293	V6	48
01/87→09/89	Sierra Hatchback 2.3 D	YTR (XD2/XD2P/XD94)	Diesel	2304	4	61
08/82→12/86	Sierra Hatchback 2.3 D	YTT (XD2/XD2P/XD94)	Diesel	2304	4	61
01/87→02/93	Sierra Hatchback 2.8 i	PR8 (TV28)	Petrol	2792	V6	55
09/83→12/86	Sierra Hatchback 2.8 i XR 4x4	PR5 (TV28)	Petrol	2792	V6	55
09/83→12/86	Sierra Hatchback 2.8 i XR 4x4	PR6 (TV28)	Petrol	2792	V6	55
01/87→02/93	Sierra Hatchback 2.8 i XR 4x4	PR7 (TV28)	Petrol	2792	V6	55
01/87→08/88	Sierra Hatchback 2.8 i XR 4x4	PRG (TV28)	Petrol	2792	V6	55
02/85→12/86	Sierra Hatchback 2.8 XR 4x4	PRT (TV28)	Petrol	2792	V6	55
08/82→12/86	Sierra Hatchback 2.8 XR4i	PR5 (TV28)	Petrol	2792	V6	55
08/82→12/86	Sierra Hatchback 2.8 XR4i	PR6 (TV28)	Petrol	2792	V6	55
08/82→12/86	Sierra Hatchback 2.8 XR4i	PRT (TV28)	Petrol	2792	V6	55
08/88→02/93	Sierra Hatchback 2.9 i	B4B	Petrol	2935	V6	54
08/88→02/93	Sierra Hatchback 2.9 i	B4C	Petrol	2935	V6	54
08/88→02/93	Sierra Hatchback 2.9 i XR 4x4	B4A	Petrol	2935	V6	54
08/88→02/93	Sierra Hatchback 2.9 i XR 4x4	B4B	Petrol	2935	V6	54
08/88→02/93	Sierra Hatchback 2.9 i XR 4x4	B4C	Petrol	2935	V6	54
01/07→	S-Max 1.8 TDCi	FFWA	Diesel	1753	4	27
05/06→	S-Max 1.8 TDCi	QYWA	Diesel	1753	4	27
05/06→	S-Max 2.0	AOWA	Petrol	1999	4	41
07/10→	S-Max 2.2 TDCi	KNWA (Duratorq TDCI)	Diesel	2179	4	35
07/79→07/82	Taurus '80 Turnier 1.6	LAR	Petrol	1593	4	42
07/79→07/82	Taurus '80 Turnier 1.6	LCJ	Petrol	1593	4	42
07/79→07/82	Taurus '80 Turnier 2.0	NER (N8C (TL20H))	Petrol	1993	4	50
07/79→07/82	Taurus '80 Turnier 2.0	NWR	Petrol	1999	V6	32
07/79→07/82	Taurus '80 Turnier 2.3	YYR	Petrol	2293	V6	48
05/75→07/79	Taurus 1.6	LCJ	Petrol	1593	4	42
08/76→07/79	Taurus 2.0	NEG	Petrol	1993	4	50
05/75→07/79	Taurus 2.0	NYR	Petrol	1999	V6	32
08/76→07/79	Taurus 2.0	TL 20 H	Petrol	1993	4	50
05/75→07/79	Taurus 2.3	YYF	Petrol	2293	V6	48
08/66→12/70	Taurus 12 M	12M, 15M, 17M	Petrol	1498	V4	48
08/66→06/71	Taurus 12M 1.3	KL 13 L	Petrol	1298	4	23
08/66→12/70	Taurus 15 M	12M, 15M, 17M	Petrol	1498	V4	48
08/64→12/70	Taurus 17 M	12M, 15M, 17M	Petrol	1498	V4	48
07/79→07/82	Taurus '80 1.6	LAR	Petrol	1593	4	42
07/79→07/82	Taurus '80 1.6	LCJ	Petrol	1593	4	42
07/79→07/82	Taurus '80 2.0	NER (N8C (TL20H))	Petrol	1993	4	50
07/79→07/82	Taurus '80 2.0	NWR	Petrol	1999	V6	32
07/79→07/82	Taurus '80 2.3	YYR	Petrol	2293	V6	48
01/70→05/75	Taurus 1600	LCJ	Petrol	1593	4	42
08/70→02/76	Taurus 1600	LCJ	Petrol	1593	4	42
08/73→02/76	Taurus 2000	NEG	Petrol	1993	4	50
01/69→12/82	Taurus 2000 Ghia	EV20H	Petrol	1995	V6	32
01/69→12/82	Taurus 2000 GL	EV20H	Petrol	1995	V6	32
01/69→12/82	Taurus 2000 L	EV20H	Petrol	1995	V6	32
08/73→02/76	Taurus Coupe 2000	NEE	Petrol	1993	4	50
05/75→07/79	Taurus Turnier 1.6	LCJ	Petrol	1593	4	42
08/76→07/79	Taurus Turnier 2.0	NEG	Petrol	1993	4	50
05/75→07/79	Taurus Turnier 2.0	NYR	Petrol	1999	V6	32
08/76→07/79	Taurus Turnier 2.0	TL 20 H	Petrol	1993	4	50
05/75→07/79	Taurus Turnier 2.3	YYF	Petrol	2293	V6	48
06/07→	Tourneo Connect 1.8 Di	BHPA (Endura DI)	Diesel	1753	4	27
06/07→	Tourneo Connect 1.8 Di	P7PA (Duratorq TDCI)	Diesel	1753	4	27
06/07→	Tourneo Connect 1.8 Di	P7PB (Duratorq TDCI)	Diesel	1753	4	27

MODEL INDEX

Modelverzeichnis • Index de modele • Índice de Modelo
Indeks modelu • Модель автомобиля • دليل الموديل



CCM

x



9

06/07→	Tourneo Connect 1.8 Di	R2PA (Duratorq TDCI)	Diesel	1753	4	27
08/06→	Tourneo Connect 1.8 TDCi	RWPA (Duratorq)	Diesel	1753	4	27
08/06→	Tourneo Connect 1.8 TDCi	RWPC (Duratorq TDCI)	Diesel	1753	4	27
08/06→	Tourneo Connect 1.8 TDCi	RWPD (Duratorq TDCI)	Diesel	1753	4	27
06/07→	Tourneo Connect 1.8 Turbo Di	HCPA (Duratorq)	Diesel	1753	4	27
06/07→	Tourneo Connect 1.8 Turbo Di	HCPB (Duratorq)	Diesel	1753	4	27
06/07→	Tourneo Connect 1.8 Turbo Di	P9PA (Duratorq TDCI)	Diesel	1753	4	27
06/07→	Tourneo Connect 1.8 Turbo Di	P9PB (Duratorq TDCI)	Diesel	1753	4	27
06/07→	Tourneo Connect 1.8 Turbo Di	P9PC (Duratorq TDCI)	Diesel	1753	4	27
06/07→	Tourneo Connect 1.8 Turbo Di	P9PD (Duratorq TDCI)	Diesel	1753	4	27
06/07→	Tourneo Connect 1.8 Turbo Di	R3PA (Duratorq TDCI)	Diesel	1753	4	27
06/07→	Tourneo Connect 1.8 Turbo Di	RWPE (Duratorq TDCI)	Diesel	1753	4	27
06/07→	Tourneo Connect 1.8 Turbo Di	RWPF (Duratorq TDCI)	Diesel	1753	4	27
01/70→12/78	Transit 90	4.108	Diesel	1760	4	16
01/70→12/78	Transit 115	4.108	Diesel	1760	4	16
01/70→12/78	Transit 125	4.108	Diesel	1760	4	16
01/70→12/78	Transit 130	4.108	Diesel	1760	4	16
01/70→12/78	Transit 150	4.108	Diesel	1760	4	16
01/70→12/78	Transit 175	4.108	Diesel	1760	4	16
11/77→10/86	Transit Box 1.6	4RB	Petrol	1593	4	42
09/85→09/92	Transit Box 1.6	LAT	Petrol	1594	4	43
11/77→07/82	Transit Box 2.0	4RC (TL20L)	Petrol	1993	4	50
11/77→10/86	Transit Box 2.0	4RC (TL20L)	Petrol	1993	4	50
09/85→09/92	Transit Box 2.0	NAT (TL20L)	Petrol	1993	4	51
09/85→09/92	Transit Box 2.0	NAV (TL20L)	Petrol	1993	4	51
08/00→05/06	Transit Box 2.0 DI	ABFA (Duratorq DI)	Diesel	1998	4	36
08/00→05/06	Transit Box 2.0 DI	D3FA (Duratorq DI)	Diesel	1998	4	36
08/00→05/06	Transit Box 2.0 DI	F3FA (Duratorq DI)	Diesel	1998	4	36
08/02→05/06	Transit Box 2.0 TDCi	FIFA (Duratorq)	Diesel	1998	4	36
04/06→	Transit Box 2.2 TDCi	P8FA	Diesel	2198	4	38
04/06→	Transit Box 2.2 TDCi	P8FB	Diesel	2198	4	38
10/07→	Transit Box 2.2 TDCi	PGFA	Diesel	2198	4	38
10/07→	Transit Box 2.2 TDCi	PGFB	Diesel	2198	4	38
04/06→	Transit Box 2.2 TDCi	QVFA	Diesel	2198	4	38
04/06→	Transit Box 2.2 TDCi	QWFA	Diesel	2198	4	38
03/01→03/06	Transit Box 2.3	E5FA	Petrol	2295	4	45
03/01→03/06	Transit Box 2.3	E5FC	Petrol	2295	4	45
04/01→05/06	Transit Box 2.3 16V [RWD]	E5FA	Petrol	2295	4	45
04/01→05/06	Transit Box 2.3 16V [RWD]	E5FC	Petrol	2295	4	45
11/77→10/86	Transit Box 2.4 D	4AA (2401E York Parent Block)	Diesel	2358	4	56
01/00→05/06	Transit Box 2.4 DI	D2FA (Duratorq DI)	Diesel	2402	4	46
01/00→05/06	Transit Box 2.4 DI	D2FB (Duratorq DI)	Diesel	2402	4	46
01/00→05/06	Transit Box 2.4 DI	D2FE (Duratorq DI)	Diesel	2402	4	46
01/00→05/06	Transit Box 2.4 DI [RWD]	D4FA (Duratorq DI)	Diesel	2402	4	46
01/00→05/06	Transit Box 2.4 DI [RWD]	F4FA (Duratorq DI)	Diesel	2402	4	46
08/00→08/03	Transit Box 2.4 TD	F4FA (Duratorq DI)	Diesel	2402	4	46
03/04→05/06	Transit Box 2.4 TDCi	H9FA (Duratorq)	Diesel	2402	4	47
04/06→	Transit Box 2.4 TDCi	JXFA	Diesel	2402	4	47
04/06→	Transit Box 2.4 TDCi	PHFA	Diesel	2402	4	47
04/06→	Transit Box 2.4 TDCi	PHFC	Diesel	2402	4	47
11/06→	Transit Box 2.4 TDCi 4x4	H9FB	Diesel	2402	4	47
08/00→08/03	Transit Box 2.4 TDdi	D4FA (Duratorq DI)	Diesel	2402	4	46
07/01→05/06	Transit Box 2.4 TDE	DOFA (Duratorq DI)	Diesel	2402	4	47
03/04→05/06	Transit Box 2.4 TDE	FXFA (Duratorq DI)	Diesel	2402	4	46
01/86→09/91	Transit Box 2.5 D	4AB (D25)	Diesel	2496	4	57
10/83→10/86	Transit Box 2.5 D	4AB (D25)	Diesel	2496	4	57
10/88→09/91	Transit Box 2.5 D	4BA (D25)	Diesel	2496	4	57
10/88→09/91	Transit Box 2.5 D	4CA (D25)	Diesel	2496	4	57
05/91→06/94	Transit Box 2.5 DI	4BC (D25)	Diesel	2496	4	58
05/91→06/94	Transit Box 2.5 DI	4CC (D25)	Diesel	2496	4	58



CCM

x



9

05/91→06/94	Transit Box 2.5 DI	4DA (D25)	Diesel	2496	4	58
05/99→03/00	Transit Box 2.5 DI	4ED (D25)	Diesel	2496	4	59
05/91→06/94	Transit Box 2.5 DI	4FA (D25)	Diesel	2496	4	58
06/94→03/00	Transit Box 2.5 DI	4FA (D25)	Diesel	2496	4	58
06/94→03/00	Transit Box 2.5 DI	4FB (D25)	Diesel	2496	4	58
06/94→03/00	Transit Box 2.5 DI	4FC (D25)	Diesel	2496	4	58
06/94→03/00	Transit Box 2.5 DI	4FD (D25)	Diesel	2496	4	58
10/92→06/94	Transit Box 2.5 DI	4GA (D25T)	Diesel	2496	4	58
06/94→03/00	Transit Box 2.5 DI	4HB (D25)	Diesel	2496	4	58
06/94→03/00	Transit Box 2.5 DI	4HC (D25)	Diesel	2496	4	58
05/91→06/94	Transit Box 2.5 TD	4EA (D25T)	Diesel	2496	4	59
06/94→03/00	Transit Box 2.5 TD	4GA (D25T)	Diesel	2496	4	58
06/94→03/00	Transit Box 2.5 TD	4GB (D25T)	Diesel	2496	4	59
06/94→03/00	Transit Box 2.5 TD	4GC (D25T)	Diesel	2496	4	59
06/94→03/00	Transit Box 2.5 TD	4GD (D25T)	Diesel	2496	4	59
06/94→03/00	Transit Box 2.5 TD	4GE (D25T)	Diesel	2496	4	59
06/94→03/00	Transit Box 2.5 TD	4GF (D25T)	Diesel	2496	4	59
10/98→03/00	Transit Box 2.5 TD	4HA (D25T)	Diesel	2496	4	59
10/98→03/00	Transit Box 2.5 TD	4HD (D25T)	Diesel	2496	4	59
06/94→03/00	Transit Box 2.5 TDI	4EB (D25T)	Diesel	2496	4	59
06/94→03/00	Transit Box 2.5 TDI	4EC (D25T)	Diesel	2496	4	59
12/77→10/86	Transit Bus 1.6	4RB	Petrol	1593	4	42
12/85→01/89	Transit Bus 1.6	LAT	Petrol	1594	4	43
11/77→10/86	Transit Bus 2.0	4RC (TL20L)	Petrol	1993	4	50
12/77→07/82	Transit Bus 2.0	4RC (TL20L)	Petrol	1993	4	50
11/85→09/92	Transit Bus 2.0	NAT (TL20L)	Petrol	1993	4	51
11/85→09/92	Transit Bus 2.0	NAV (TL20L)	Petrol	1993	4	51
08/00→05/06	Transit Bus 2.0 DI	ABFA (Duratorq DI)	Diesel	1998	4	36
08/00→05/06	Transit Bus 2.0 DI	D3FA (Duratorq DI)	Diesel	1998	4	36
08/00→05/06	Transit Bus 2.0 DI	F3FA (Duratorq DI)	Diesel	1998	4	36
08/02→05/06	Transit Bus 2.0 TDCi	FIFA (Duratorq)	Diesel	1998	4	36
04/06→	Transit Bus 2.2 TDCi	P8FA	Diesel	2198	4	38
04/06→	Transit Bus 2.2 TDCi	P8FB	Diesel	2198	4	38
10/07→	Transit Bus 2.2 TDCi	PGFA	Diesel	2198	4	38
10/07→	Transit Bus 2.2 TDCi	PGFB	Diesel	2198	4	38
04/06→	Transit Bus 2.2 TDCi	QVFA	Diesel	2198	4	38
04/06→	Transit Bus 2.2 TDCi	QWFA	Diesel	2198	4	38
08/00→03/06	Transit Bus 2.3	E5FA	Petrol	2295	4	45
08/00→05/06	Transit Bus 2.3 16V [RWD]	E5FA	Petrol	2295	4	45
08/00→05/06	Transit Bus 2.3 16V [RWD]	E5FC	Petrol	2295	4	45
12/77→10/86	Transit Bus 2.4 D	4AA (2401E York Parent Block)	Diesel	2358	4	56
01/00→05/06	Transit Bus 2.4 DI	D2FA (Duratorq DI)	Diesel	2402	4	46
01/00→05/06	Transit Bus 2.4 DI	D2FB (Duratorq DI)	Diesel	2402	4	46
01/00→05/06	Transit Bus 2.4 DI	D2FE (Duratorq DI)	Diesel	2402	4	46
01/00→05/06	Transit Bus 2.4 DI [RWD]	D4FA (Duratorq DI)	Diesel	2402	4	46
01/00→05/06	Transit Bus 2.4 DI [RWD]	F4FA (Duratorq DI)	Diesel	2402	4	46
03/04→05/06	Transit Bus 2.4 TDCi	H9FA (Duratorq)	Diesel	2402	4	47
04/06→	Transit Bus 2.4 TDCi	JXFA	Diesel	2402	4	47
04/06→	Transit Bus 2.4 TDCi	PHFA	Diesel	2402	4	47
04/06→	Transit Bus 2.4 TDCi	PHFC	Diesel	2402	4	47
11/06→	Transit Bus 2.4 TDCi 4x4	H9FB	Diesel	2402	4	47
10/01→03/06	Transit Bus 2.4 TDdi	D2FE (Duratorq DI)	Diesel	2402	4	46
07/01→05/06	Transit Bus 2.4 TDE	DOFA (Duratorq DI)	Diesel	2402	4	47
03/04→05/06	Transit Bus 2.4 TDE	FXFA (Duratorq DI)	Diesel	2402	4	46
09/88→09/92	Transit Bus 2.5 D	4AB (D25)	Diesel	2496	4	57
10/83→10/86	Transit Bus 2.5 D	4AB (D25)	Diesel	2496	4	57
12/85→01/89	Transit Bus 2.5 D	4AB (D25)	Diesel	2496	4	57
09/88→09/92	Transit Bus 2.5 D	4BA (D25)	Diesel	2496	4	57
09/88→09/92	Transit Bus 2.5 D	4CA (D25)	Diesel	2496	4	57
08/91→07/94	Transit Bus 2.5 DI	4BC (D25)	Diesel	2496	4	58

MODEL INDEX

Modelverzeichnis • Index de modele • Índice de Modelo
Indeks modelu • Модель автомобиля • دليل الموديل



CCM

x



9

08/91→07/94	Transit Bus 2.5 DI	4CC (D25)	Diesel	2496	4	58
09/91→07/94	Transit Bus 2.5 DI	4DA (D25)	Diesel	2496	4	58
08/97→03/00	Transit Bus 2.5 DI	4ED (D25)	Diesel	2496	4	59
08/91→07/94	Transit Bus 2.5 DI	4FA (D25)	Diesel	2496	4	58
08/94→03/00	Transit Bus 2.5 DI	4FA (D25)	Diesel	2496	4	58
08/94→03/00	Transit Bus 2.5 DI	4FB (D25)	Diesel	2496	4	58
08/94→03/00	Transit Bus 2.5 DI	4FC (D25)	Diesel	2496	4	58
08/94→03/00	Transit Bus 2.5 DI	4FD (D25)	Diesel	2496	4	58
07/94→03/00	Transit Bus 2.5 DI	4HB (D25)	Diesel	2496	4	58
07/94→03/00	Transit Bus 2.5 DI	4HC (D25)	Diesel	2496	4	58
09/91→07/94	Transit Bus 2.5 TD	4EA (D25T)	Diesel	2496	4	59
07/94→03/00	Transit Bus 2.5 TD	4EB (D25T)	Diesel	2496	4	59
07/94→03/00	Transit Bus 2.5 TD	4EC (D25T)	Diesel	2496	4	59
01/95→03/00	Transit Bus 2.5 TD	4GA (D25T)	Diesel	2496	4	58
10/92→07/94	Transit Bus 2.5 TD	4GA (D25T)	Diesel	2496	4	58
01/95→03/00	Transit Bus 2.5 TD	4GB (D25T)	Diesel	2496	4	59
10/92→07/94	Transit Bus 2.5 TD	4GB (D25T)	Diesel	2496	4	59
01/95→03/00	Transit Bus 2.5 TD	4GC (D25T)	Diesel	2496	4	59
10/92→07/94	Transit Bus 2.5 TD	4GC (D25T)	Diesel	2496	4	59
01/95→03/00	Transit Bus 2.5 TD	4GD (D25T)	Diesel	2496	4	59
01/95→03/00	Transit Bus 2.5 TD	4GE (D25T)	Diesel	2496	4	59
01/95→03/00	Transit Bus 2.5 TD	4GF (D25T)	Diesel	2496	4	59
08/94→06/00	Transit Bus 2.5 TD	4HA (D25T)	Diesel	2496	4	59
08/94→06/00	Transit Bus 2.5 TD	4HD (D25T)	Diesel	2496	4	59
06/07→	Transit Connect 1.8 Di	BHPA (Endura DI)	Diesel	1753	4	27
06/07→	Transit Connect 1.8 Di	P7PA (Duratorq TDCI)	Diesel	1753	4	27
06/07→	Transit Connect 1.8 Di	P7PB (Duratorq TDCI)	Diesel	1753	4	27
06/07→	Transit Connect 1.8 Di	R2PA (Duratorq TDCI)	Diesel	1753	4	27
06/07→	Transit Connect 1.8 TDCi	HCPA (Duratorq)	Diesel	1753	4	27
06/07→	Transit Connect 1.8 TDCi	HCPB (Duratorq)	Diesel	1753	4	27
06/07→	Transit Connect 1.8 TDCi	P9PA (Duratorq TDCI)	Diesel	1753	4	27
06/07→	Transit Connect 1.8 TDCi	P9PB (Duratorq TDCI)	Diesel	1753	4	27
06/07→	Transit Connect 1.8 TDCi	P9PC (Duratorq TDCI)	Diesel	1753	4	27
06/07→	Transit Connect 1.8 TDCi	P9PD (Duratorq TDCI)	Diesel	1753	4	27
06/07→	Transit Connect 1.8 TDCi	R3PA (Duratorq TDCI)	Diesel	1753	4	27
08/06→	Transit Connect 1.8 TDCi	RWPA (Duratorq)	Diesel	1753	4	27
08/06→	Transit Connect 1.8 TDCi	RWPC (Duratorq TDCI)	Diesel	1753	4	27
08/06→	Transit Connect 1.8 TDCi	RWPD (Duratorq TDCI)	Diesel	1753	4	27
06/07→	Transit Connect 1.8 TDCi	RWPE (Duratorq TDCI)	Diesel	1753	4	27
06/07→	Transit Connect 1.8 TDCi	RWPF (Duratorq TDCI)	Diesel	1753	4	27
11/77→10/86	Transit Platform/Chassis 1.6	B	Petrol	1593	4	42
11/77→07/82	Transit Platform/Chassis 2.0	4RC (TL20L)	Petrol	1993	4	50
11/77→10/86	Transit Platform/Chassis 2.0	4RC (TL20L)	Petrol	1993	4	50
01/86→09/92	Transit Platform/Chassis 2.0	NAT (TL20L)	Petrol	1993	4	51
01/86→09/92	Transit Platform/Chassis 2.0	NAV (TL20L)	Petrol	1993	4	51
08/00→05/06	Transit Platform/Chassis 2.0 DI	ABFA (Duratorq DI)	Diesel	1998	4	36
08/00→05/06	Transit Platform/Chassis 2.0 DI	D3FA (Duratorq DI)	Diesel	1998	4	36
08/00→05/06	Transit Platform/Chassis 2.0 DI	F3FA (Duratorq DI)	Diesel	1998	4	36
08/02→05/06	Transit Platform/Chassis 2.0 TDCi	FIFA (Duratorq)	Diesel	1998	4	36
04/06→	Transit Platform/Chassis 2.2 TDCi	P8FA	Diesel	2198	4	38
04/06→	Transit Platform/Chassis 2.2 TDCi	P8FB	Diesel	2198	4	38
10/07→	Transit Platform/Chassis 2.2 TDCi	PGFA	Diesel	2198	4	38
10/07→	Transit Platform/Chassis 2.2 TDCi	PGFB	Diesel	2198	4	38
04/06→	Transit Platform/Chassis 2.2 TDCi	QVFA	Diesel	2198	4	38
04/06→	Transit Platform/Chassis 2.2 TDCi	QWFA	Diesel	2198	4	38
04/01→05/06	Transit Platform/Chassis 2.3 16V	E5FA	Petrol	2295	4	45
04/01→05/06	Transit Platform/Chassis 2.3 16V	E5FC	Petrol	2295	4	45
11/77→09/85	Transit Platform/Chassis 2.4 D	4AA (2401E York Parent Block)	Diesel	2358	4	56
01/00→05/06	Transit Platform/Chassis 2.4 DI	D2FA (Duratorq DI)	Diesel	2402	4	46
01/00→05/06	Transit Platform/Chassis 2.4 DI	D2FB (Duratorq DI)	Diesel	2402	4	46



CCM

x



01/00→05/06	Transit Platform/Chassis 2.4 DI	D2FE (Duratorq DI)	Diesel	2402	4	46
01/00→05/06	Transit Platform/Chassis 2.4 DI	D4FA (Duratorq DI)	Diesel	2402	4	46
01/00→05/06	Transit Platform/Chassis 2.4 DI	F4FA (Duratorq DI)	Diesel	2402	4	46
03/04→05/06	Transit Platform/Chassis 2.4 TDCi	H9FA (Duratorq)	Diesel	2402	4	47
04/06→	Transit Platform/Chassis 2.4 TDCi	JXFA	Diesel	2402	4	47
04/06→	Transit Platform/Chassis 2.4 TDCi	PHFA	Diesel	2402	4	47
04/06→	Transit Platform/Chassis 2.4 TDCi	PHFC	Diesel	2402	4	47
11/06→	Transit Platform/Chassis 2.4 TDCi 4x4	H9FB	Diesel	2402	4	47
08/00→08/03	Transit Platform/Chassis 2.4 TDdi	D4FA (Duratorq DI)	Diesel	2402	4	46
07/01→05/06	Transit Platform/Chassis 2.4 TDE	DOFA (Duratorq DI)	Diesel	2402	4	47
03/04→05/06	Transit Platform/Chassis 2.4 TDE	FXFA (Duratorq DI)	Diesel	2402	4	46
01/86→01/89	Transit Platform/Chassis 2.5 D	4AB (D25)	Diesel	2496	4	57
10/83→10/86	Transit Platform/Chassis 2.5 D	4AB (D25)	Diesel	2496	4	57
09/88→09/92	Transit Platform/Chassis 2.5 DI	4BA (D25)	Diesel	2496	4	57
09/91→08/94	Transit Platform/Chassis 2.5 DI	4BC (D25)	Diesel	2496	4	58
09/88→09/92	Transit Platform/Chassis 2.5 DI	4CA (D25)	Diesel	2496	4	57
09/91→08/94	Transit Platform/Chassis 2.5 DI	4CC (D25)	Diesel	2496	4	58
09/91→08/94	Transit Platform/Chassis 2.5 DI	4DA (D25)	Diesel	2496	4	58
05/99→03/00	Transit Platform/Chassis 2.5 DI	4ED (D25)	Diesel	2496	4	59
08/94→03/00	Transit Platform/Chassis 2.5 DI	4FA (D25)	Diesel	2496	4	58
09/91→08/94	Transit Platform/Chassis 2.5 DI	4FA (D25)	Diesel	2496	4	58
08/94→03/00	Transit Platform/Chassis 2.5 DI	4FB (D25)	Diesel	2496	4	58
08/94→03/00	Transit Platform/Chassis 2.5 DI	4FC (D25)	Diesel	2496	4	58
08/94→03/00	Transit Platform/Chassis 2.5 DI	4FD (D25)	Diesel	2496	4	58
08/94→03/00	Transit Platform/Chassis 2.5 DI	4HB (D25)	Diesel	2496	4	58
08/94→03/00	Transit Platform/Chassis 2.5 DI	4HC (D25)	Diesel	2496	4	58
09/91→08/94	Transit Platform/Chassis 2.5 TD	4EA (D25T)	Diesel	2496	4	59
08/94→03/00	Transit Platform/Chassis 2.5 TD	4EB (D25T)	Diesel	2496	4	59
08/94→03/00	Transit Platform/Chassis 2.5 TD	4EC (D25T)	Diesel	2496	4	59
08/94→03/00	Transit Platform/Chassis 2.5 TD	4GA (D25T)	Diesel	2496	4	58
11/92→08/94	Transit Platform/Chassis 2.5 TD	4GA (D25T)	Diesel	2496	4	58
08/94→03/00	Transit Platform/Chassis 2.5 TD	4GB (D25T)	Diesel	2496	4	59
08/94→03/00	Transit Platform/Chassis 2.5 TD	4GC (D25T)	Diesel	2496	4	59
08/94→03/00	Transit Platform/Chassis 2.5 TD	4GD (D25T)	Diesel	2496	4	59
08/94→03/00	Transit Platform/Chassis 2.5 TD	4GE (D25T)	Diesel	2496	4	59
08/94→03/00	Transit Platform/Chassis 2.5 TD	4GF (D25T)	Diesel	2496	4	59
10/98→07/00	Transit Platform/Chassis 2.5 TD	4HA (D25T)	Diesel	2496	4	59
10/98→07/00	Transit Platform/Chassis 2.5 TD	4HD (D25T)	Diesel	2496	4	59
09/99→	Transit TD	DT24N Duratorq	Diesel	2402	4	46
09/99→	Transit TDi	DT24H Duratorq	Diesel	2402	4	46
09/99→	Transit TDi	DT24P Duratorq	Diesel	2402	4	46
10/07→	Transit Tourneo 2.2 TDCi	PGFA	Diesel	2198	4	38
10/07→	Transit Tourneo 2.2 TDCi	PGFB	Diesel	2198	4	38
07/06→	Transit Tourneo 2.2 TDCi	QVFA	Diesel	2198	4	38
07/06→	Transit Tourneo 2.2 TDCi	QWFA	Diesel	2198	4	38
08/94→06/00	Transit Tourneo 2.4 D	4HA (D25T)	Diesel	2496	4	59
11/94→12/00	Transit Tourneo 2.5 DI	4FA (D25)	Diesel	2496	4	58
11/94→12/00	Transit Tourneo 2.5 DI	4FB (D25)	Diesel	2496	4	58
11/94→12/00	Transit Tourneo 2.5 DI	4FC (D25)	Diesel	2496	4	58
11/94→12/00	Transit Tourneo 2.5 DI	4FD (D25)	Diesel	2496	4	58
11/94→12/00	Transit Tourneo 2.5 DI	4HA (D25T)	Diesel	2496	4	59
11/94→12/00	Transit Tourneo 2.5 DI	4HB (D25)	Diesel	2496	4	58
11/94→12/00	Transit Tourneo 2.5 DI	4HC (D25)	Diesel	2496	4	58
04/98→12/00	Transit Tourneo 2.5 TD	4EB (D25T)	Diesel	2496	4	59
04/98→12/00	Transit Tourneo 2.5 TD	4EC (D25T)	Diesel	2496	4	59
11/94→12/00	Transit Tourneo 2.5 TD	4GA (D25T)	Diesel	2496	4	58
11/94→12/00	Transit Tourneo 2.5 TD	4GB (D25T)	Diesel	2496	4	59
11/94→12/00	Transit Tourneo 2.5 TD	4GC (D25T)	Diesel	2496	4	59
01/65→12/70	Transit V20	4.108	Diesel	1760	4	16
01/65→12/70	Transit V30	4.108	Diesel	1760	4	16

MODEL INDEX

Modelverzeichnis • Index de modele • Índice de Modelo
Indeks modelu • Модель автомобиля • دليل الموديل



CCM

x



9

01/65→12/70	Transit V40	4.108	Diesel	1760	4	16
01/65→12/70	Transit V50	4.108	Diesel	1760	4	16
01/65→12/70	Transit V60	4.108	Diesel	1760	4	16

ENGINE INDEX

Motorverzeichnis • Index de moteur • Índice de Motor
Indeks silnika • Модель двигателя • دليل المحرك



CCM

x



9

1Z	Diesel	1896	4	79.50	17
4.108	Diesel	1760	4	79.38	16
4AA (2401E York Parent Block)	Diesel	2358	4	93.67	56
4AB (D25)	Diesel	2496	4	93.67	57
4BA (D25)	Diesel	2496	4	93.67	57
4BC (D25)	Diesel	2496	4	93.67	58
4CA (D25)	Diesel	2496	4	93.67	57
4CC (D25)	Diesel	2496	4	93.67	58
4DA (D25)	Diesel	2496	4	93.67	58
4EA (D25T)	Diesel	2496	4	93.67	59
4EB (D25T)	Diesel	2496	4	93.67	59
4EC (D25T)	Diesel	2496	4	93.67	59
4ED (D25)	Diesel	2496	4	93.67	59
4FA (D25)	Diesel	2496	4	93.67	58
4FB (D25)	Diesel	2496	4	93.67	58
4FC (D25)	Diesel	2496	4	93.67	58
4FD (D25)	Diesel	2496	4	93.67	58
4GA (D25T)	Diesel	2496	4	93.67	58
4GB (D25T)	Diesel	2496	4	93.67	59
4GC (D25T)	Diesel	2496	4	93.67	59
4GD (D25T)	Diesel	2496	4	93.67	59
4GE (D25T)	Diesel	2496	4	93.67	59
4GF (D25T)	Diesel	2496	4	93.67	59
4HA (D25T)	Diesel	2496	4	93.67	59
4HB (D25)	Diesel	2496	4	93.67	58
4HC (D25)	Diesel	2496	4	93.67	58
4HD (D25T)	Diesel	2496	4	93.67	59
4RB	Petrol	1593	4	87.65	42
4RC (TL20L)	Petrol	1993	4	90.80	50
12M, 15M, 17M	Petrol	1498	V4	90.00	48
711M uprated	Petrol	1599	4	80.98	23
2402E York (Parent Block)	Diesel	3537	6	93.67	56
A9A (Duratec)	Petrol	1299	4	74.00	4
A9B (Duratec)	Petrol	1299	4	74.00	4
AAA	Petrol	2792	V6	81.00	24
ABFA (Duratorq DI)	Diesel	1998	4	86.00	36
AFN	Diesel	1896	4	79.50	17
AHU	Diesel	1896	4	79.50	17
AMY	Petrol	2792	V6	81.00	24
ANU	Diesel	1896	4	79.50	17
AODA	Petrol	1999	4	87.50	41
AODB	Petrol	1999	4	87.50	41
AOWA	Petrol	1999	4	87.50	41
ARC	Petrol	2394	V6	84.00	31
ARD	Petrol	2394	V6	84.00	31

Motorverzeichnis • Index de moteur • Índice de Motor
Indeks silnika • Модель двигателя • دليل المحرك

ENGINE INDEX



CCM

x



9

ASDA	Petrol	1388	4	76.00	9
ASDB	Petrol	1388	4	76.00	9
AYL	Petrol	2792	V6	81.00	24
B	Petrol	1593	4	87.65	42
B4A	Petrol	2935	V6	93.00	54
B4B	Petrol	2935	V6	93.00	54
B4C	Petrol	2935	V6	93.00	54
BHDA (Endura DI)	Diesel	1753	4	82.50	26
BHDB (Endura DI)	Diesel	1753	4	82.50	26
BHPA (Endura DI)	Diesel	1753	4	82.50	27
BOA	Petrol	2935	V6	93.00	54
BOB	Petrol	2935	V6	93.00	54
BRC	Petrol	2935	V6	93.00	54
BRD	Petrol	2935	V6	93.00	54
BRE	Petrol	2935	V6	93.00	54
BRF	Petrol	2935	V6	93.00	54
BRG	Petrol	2935	V6	93.00	54
C9DA (Endura DI)	Diesel	1753	4	82.50	26
C9DB (Endura DI)	Diesel	1753	4	82.50	26
C9DC (Endura DI)	Diesel	1753	4	82.50	26
CGBA (Duratec HE)	Petrol	1796	4	83.00	30
CGBB (Duratec HE)	Petrol	1796	4	83.00	30
CHBA	Petrol	1796	4	83.00	30
CHBB	Petrol	1796	4	83.00	30
CJBA (Duratec HE)	Petrol	1999	4	87.50	41
CJBB (Duratec HE)	Petrol	1999	4	87.50	41
CSDA (Duratec HE)	Petrol	1798	4	83.00	30
CSDB (Duratec HE)	Petrol	1798	4	83.00	30
D2FA (Duratorq DI)	Diesel	2402	4	89.90	46
D2FB (Duratorq DI)	Diesel	2402	4	89.90	46
D2FE (Duratorq DI)	Diesel	2402	4	89.90	46
D3FA (Duratorq DI)	Diesel	1998	4	86.00	36
D4FA (Duratorq DI)	Diesel	2402	4	89.90	46
D5BA (Duratorq)	Diesel	1998	4	86.00	36
D6BA (Duratorq)	Diesel	1998	4	86.00	36
DHA (Zetec SE)	Petrol	1242	4	71.90	2
DHB (Zetec SE)	Petrol	1242	4	71.90	2
DHC (Zetec SE)	Petrol	1242	4	71.90	2
DHD (Zetec SE)	Petrol	1242	4	71.90	2
DHE (Zetec SE)	Petrol	1242	4	71.90	2
DHF (Zetec SE)	Petrol	1242	4	71.90	2
DHG (Zetec SE)	Petrol	1242	4	71.90	2
DOFA (Duratorq DI)	Diesel	2402	4	89.90	47
DT24H Duratorq	Diesel	2402	4	89.90	46
DT24N Duratorq	Diesel	2402	4	89.90	46
DT24P Duratorq	Diesel	2402	4	89.90	46
E5FA	Petrol	2295	4	89.60	45
E5FC	Petrol	2295	4	89.60	45
EDBA (ZH20 Zetec E)	Petrol	1988	4	84.80	33
EDBB (ZH20 Zetec E)	Petrol	1988	4	84.80	33
EDBC (ZH20 Zetec E)	Petrol	1988	4	84.80	33
EDBD (ZH20 Zetec E)	Petrol	1988	4	84.80	33
EDDB (ZH20 Zetec E)	Petrol	1988	4	84.80	33
EDDC (ZH20 Zetec E)	Petrol	1988	4	84.80	33
EDDF (ZH20 Zetec E)	Petrol	1988	4	84.80	33
EV20H	Petrol	1995	V6	84.00	32
F3FA (Duratorq DI)	Diesel	1998	4	86.00	36
F4A (HL14EFI CVH)	Petrol	1392	4	77.24	13
F4B (HL14EFI CVH)	Petrol	1392	4	77.24	13
F4FA (Duratorq DI)	Diesel	2402	4	89.90	46

ENGINE INDEX

Motorverzeichnis • Index de moteur • Índice de Motor
Indeks silnika • Модель двигателя • دليل المحرك



CCM



9

Engine Model	Fuel Type	CCM	Cylinders	Stroke (mm)	Displacement (liters)
F6A	Petrol	1393	4	77.24	13
F6B (HL14G CVH)	Petrol	1392	4	77.24	13
F6C	Petrol	1392	4	77.24	13
F6D (HL14G CVH)	Petrol	1392	4	77.24	13
F6E (HL14CFI CVH)	Petrol	1392	4	77.24	13
F6F (HL14CFI CVH)	Petrol	1392	4	77.24	13
F6G (HL14CFI CVH)	Petrol	1392	4	77.24	13
F6JA / DV4TD (Duratorq)	Diesel	1399	4	73.70	3
F6JB (DV4TED)	Diesel	1399	4	73.70	3
F9DA (Duratorq)	Diesel	1753	4	82.50	26
F9DB (Duratorq)	Diesel	1753	4	82.50	26
FFBA	Diesel	1753	4	82.50	27
FFDA (Duratorq)	Diesel	1753	4	82.50	26
FFWA	Diesel	1753	4	82.50	27
FHA (Zetec SE)	Petrol	1388	4	76.00	10
FHD (Zetec SE)	Petrol	1388	4	76.00	10
FHE (Zetec SE)	Petrol	1388	4	76.00	10
FHF (Zetec SE)	Petrol	1388	4	76.00	10
FIFA (Duratorq)	Diesel	1998	4	86.00	36
FMBA (Duratorq)	Diesel	1998	4	86.00	36
FUA (HL14G CVH)	Petrol	1392	4	77.24	13
FUAA (HL14G CVH)	Petrol	1392	4	77.24	13
FUB	Petrol	1392	4	77.24	13
FUBA	Petrol	1392	4	77.24	13
FUC (HL14G CVH)	Petrol	1392	4	77.24	13
FUD	Petrol	1392	4	77.24	13
FUF	Petrol	1392	4	77.24	13
FUG (HL14G CVH)	Petrol	1392	4	77.24	13
FUH (HL14EFI CVH)	Petrol	1392	4	77.24	13
FUJ (HL14G CVH)	Petrol	1392	4	77.24	13
FXDA (Zetec SE)	Petrol	1388	4	76.00	10
FXDB (Zetec SE)	Petrol	1388	4	76.00	10
FXDC (Zetec SE)	Petrol	1388	4	76.00	10
FXDD (Zetec SE)	Petrol	1388	4	76.00	10
FXFA (Duratorq DI)	Diesel	2402	4	89.90	46
FXJA	Petrol	1388	4	76.00	10
FXJB	Petrol	1388	4	76.00	10
FYDA (Zetec SE)	Petrol	1596	4	79.00	14
FYDB (Zetec SE)	Petrol	1596	4	79.00	14
FYDC (Zetec SE)	Petrol	1596	4	79.00	14
FYDD (Zetec SE)	Petrol	1596	4	79.00	14
FYDH (Zetec SE)	Petrol	1596	4	79.00	14
FYJA (Duratec)	Petrol	1596	4	79.00	14
FYJB (Duratec)	Petrol	1597	4	79.00	14
G1	Petrol	1098	4	80.98	23
G2	Petrol	1098	4	80.98	23
G6A (BL11)	Petrol	1118	4	68.70	1
G6DA	Diesel	1997	4	85.00	34
G6DB	Diesel	1997	4	85.00	34
G6DD (Duratorq)	Diesel	1997	4	85.00	34
G8DA (Duratorq)	Diesel	1560	4	75.00	7
G8DB (Duratorq)	Diesel	1560	4	75.00	7
GLB	Petrol	1117	4	74.00	5
GLC	Petrol	1117	4	74.00	5
GMA	Petrol	1117	4	74.00	5
GPA	Petrol	1117	4	74.00	5
GSE	Petrol	1117	4	74.00	5
GSF	Petrol	1117	4	74.00	5
GSG	Petrol	1117	4	74.00	5
GUD (BL11H)	Petrol	1118	4	68.70	1

Motorverzeichnis • Index de moteur • Índice de Motor
Indeks silnika • Модель двигателя • دليل المحرك

ENGINE INDEX



CCM

x



9

GUE (BL11H)	Petrol	1118	4	68.70	1
GZ	Petrol	2261	4	87.50	41
H9FA (Duratorq)	Diesel	2402	4	89.90	47
H9FB	Diesel	2402	4	89.90	47
HCPA (Duratorq)	Diesel	1753	4	82.50	27
HCPB (Duratorq)	Diesel	1753	4	82.50	27
HHDA Euro 4	Diesel	1560	4	75.00	7
HHDB Euro 4	Diesel	1560	4	75.00	7
HHJA (Duratorq)	Diesel	1560	4	75.00	7
HHJB (Duratorq)	Diesel	1560	4	75.00	7
HHJC (Duratorq TDCI)	Diesel	1560	4	75.00	7
HHJD (Duratorq TDCI)	Diesel	1560	4	75.00	7
HHJE (Duratorq TDCI)	Diesel	1560	4	75.00	7
HJBA (Duratorq)	Diesel	1998	4	86.00	36
HJBB (Duratorq)	Diesel	1998	4	86.00	36
HJBC (Duratorq)	Diesel	1998	4	86.00	36
HWDA	Petrol	1596	4	79.00	15
HWDB	Petrol	1596	4	79.00	15
HXDA	Petrol	1596	4	79.00	15
HXDB (Duratec Ti-VCT)	Petrol	1596	4	79.00	15
HXJA (Duratec Ti-VCT)	Petrol	1596	4	79.00	15
J1E	Petrol	1298	4	80.98	23
J1F	Petrol	1298	4	80.98	23
J2	Petrol	1298	4	80.98	23
J3D	Petrol	1298	4	80.98	23
J3E	Petrol	1298	4	80.98	23
J4B / BL13 (Endura E)	Petrol	1299	4	74.00	6
J4C (Endura E)	Petrol	1299	4	74.00	6
J4D/Endura E (Endura E)	Petrol	1299	4	74.00	6
J4J (Endura E)	Petrol	1299	4	74.00	6
J4K (Endura E)	Petrol	1299	4	74.00	6
J4L (Endura E)	Petrol	1299	4	74.00	6
J4M (Endura E)	Petrol	1299	4	74.00	6
J4N (Endura E)	Petrol	1299	4	74.00	6
J4P (Endura E)	Petrol	1299	4	74.00	6
J4Q (Endura E)	Petrol	1299	4	74.00	6
J4R (Endura E)	Petrol	1299	4	74.00	6
J4S (Endura E)	Petrol	1299	4	74.00	6
J4T (Endura E)	Petrol	1299	4	74.00	6
J6A (BL13)	Petrol	1299	4	74.00	6
J6B (BL13)	Petrol	1299	4	74.00	6
JBA (BL13H)	Petrol	1299	4	74.00	6
JBB (BL13H)	Petrol	1299	4	74.00	6
JBC (BL13H)	Petrol	1299	4	74.00	6
JBD	Petrol	1299	4	74.00	6
JBE	Petrol	1299	4	74.00	6
JJA (Endura E)	Petrol	1299	4	74.00	6
JJB/Endura E (Endura E)	Petrol	1299	4	74.00	6
JJC (Endura E)	Petrol	1299	4	74.00	6
JJD (Endura E)	Petrol	1299	4	74.00	6
JJE/Endura E (Endura E)	Petrol	1299	4	74.00	6
JJF (Endura E)	Petrol	1299	4	74.00	6
JJG (Endura E)	Petrol	1299	4	74.00	6
JJH (Endura E)	Petrol	1299	4	74.00	6
JJJ (Endura E)	Petrol	1299	4	74.00	6
JJK (Endura E)	Petrol	1299	4	74.00	6
JJL (Endura E)	Petrol	1299	4	74.00	6
JJM (Endura E)	Petrol	1299	4	74.00	6
JLA	Petrol	1299	4	74.00	5
JLB	Petrol	1299	4	74.00	5

ENGINE INDEX

Motorverzeichnis • Index de moteur • Índice de Motor
Indeks silnika • Модель двигателя • دليل المحرك



CCM



9

		CCM	x		9
JPA	Petrol	1296	4	79.96	19
JPC	Petrol	1296	4	79.96	19
JXFA	Diesel	2402	4	89.90	47
KHBA (Duratorq TDCI)	Diesel	1753	4	82.50	27
KKDA Euro 4	Diesel	1753	4	82.50	26
KKDB Euro 4	Diesel	1753	4	82.50	26
KL 13 H (Uprated 711M)	Petrol	1298	4	80.98	23
KL 13 HC (Uprated 711M)	Petrol	1298	4	80.98	23
KL 13 L	Petrol	1298	4	80.98	23
KL 16 G (751M)	Petrol	1599	4	80.98	23
KL 16 L (751M)	Petrol	1599	4	80.98	23
KL 16 R	Petrol	1599	4	80.98	23
KL09H (711M)	Petrol	940	4	80.98	23
KL11	Petrol	1098	4	80.98	23
KL13L (J3)	Petrol	1298	4	80.98	23
KNBA (Duratorq TDCI)	Diesel	2179	4	85.00	35
KNBB (Duratorq TDCI)	Diesel	2179	4	85.00	35
KNWA (Duratorq TDCI)	Diesel	2179	4	85.00	35
KNWB (Duratorq TDCI)	Diesel	2179	4	85.00	35
L1E (Zetec)	Petrol	1597	4	76.00	11
L1F (Zetec)	Petrol	1597	4	76.00	11
L1G (Zetec E)	Petrol	1597	4	76.00	11
L1H (ZH16 Zetec E)	Petrol	1597	4	76.00	11
L1J (Zetec E)	Petrol	1597	4	76.00	11
L1K (Zetec E)	Petrol	1597	4	76.00	11
L1L (Zetec E)	Petrol	1597	4	76.00	11
L1N (Zetec E)	Petrol	1597	4	76.00	11
L1Q (Zetec E)	Petrol	1597	4	76.00	11
L1T (Zetec SE)	Petrol	1596	4	79.00	14
L1V (Zetec SE)	Petrol	1596	4	79.00	14
L1W	Petrol	1596	4	79.00	14
L3E (KL16G - 751M)	Petrol	1599	4	80.98	23
L4B (HL16I CVH)	Petrol	1598	4	79.96	19
L6B	Petrol	1597	4	79.96	19
LAR	Petrol	1593	4	87.65	42
LAT	Petrol	1594	4	87.65	43
LC (KL16G - 751M)	Petrol	1599	4	80.98	23
LCE	Petrol	1593	4	87.65	42
LCJ	Petrol	1593	4	87.65	42
LCK	Petrol	1593	4	87.65	42
LCN	Petrol	1593	4	87.65	42
LCR	Petrol	1594	4	87.65	43
LCS	Petrol	1593	4	81.30	25
LCT	Petrol	1593	4	81.30	25
LEC	Petrol	1593	4	87.65	42
LHA (HL16T CVH)	Petrol	1597	4	79.96	20
LJB (HL16I CVH)	Petrol	1597	4	79.96	19
LJD	Petrol	1597	4	79.96	19
LJF	Petrol	1597	4	79.96	19
LNA	Petrol	1597	4	79.96	20
LNB (HL16T CVH)	Petrol	1597	4	79.96	20
LP1	Petrol	1597	4	79.96	19
LP2 (HL16H CVH)	Petrol	1597	4	79.96	19
LP3	Petrol	1597	4	79.96	19
LPA (HL16H CVH)	Petrol	1597	4	79.96	19
LR1 (HL16I CVH)	Petrol	1597	4	79.96	19
LR2 (HL16I CVH)	Petrol	1597	4	79.96	19
LRA (HL16I CVH)	Petrol	1597	4	79.96	19
LRB (HL16I CVH)	Petrol	1597	4	79.96	19
LSD (TL16E E-MAX)	Petrol	1593	4	81.30	25

Motorverzeichnis • Index de moteur • Índice de Motor
Indeks silnika • Модель двигателя • دليل المحرك

ENGINE INDEX



CCM

x



9

LSE (TL16E E-MAX)	Petrol	1593	4	81.30	25
LTA (D16)	Diesel	1608	4	80.00	21
LTB (D16)	Diesel	1608	4	80.00	21
LTC (D16)	Diesel	1608	4	80.00	21
LUA (HL16G CVH)	Petrol	1597	4	79.96	19
LUAE	Petrol	1597	4	79.96	19
LUB (HL16G CVH)	Petrol	1597	4	79.96	19
LUC (HL16H CVH)	Petrol	1597	4	79.96	19
LUD (HL16G CVH)	Petrol	1597	4	79.96	19
LUG (HL16H CVH)	Petrol	1597	4	79.96	19
LUH	Petrol	1597	4	76.00	11
LUJ (HL16G CVH)	Petrol	1597	4	79.96	19
LUK (HL16G CVH)	Petrol	1597	4	79.96	19
N3A (DH20)	Petrol	1998	4	86.00	37
N4A	Petrol	1993	4	90.80	51
N4I	Petrol	1993	4	90.80	51
N4JB (Duratec ST)	Petrol	1999	4	87.50	41
N5B	Petrol	1993	4	90.82	52
N5C	Petrol	1993	4	90.82	52
N5D	Petrol	1993	4	90.82	52
N5F	Petrol	1993	4	90.82	52
N7A (DH20)	Petrol	1998	4	86.00	37
N7BA (Duratorq)	Diesel	1998	4	86.00	36
N8C (DL20H)	Petrol	1998	4	86.00	37
N8D (N8C (TL20H))	Petrol	1993	4	90.80	51
N9C (DL20)	Petrol	1998	4	86.00	37
N9F (DL20)	Petrol	1998	4	86.00	37
NAE (TL20L)	Petrol	1993	4	90.80	51
NAT (TL20L)	Petrol	1993	4	90.80	51
NAV (TL20L)	Petrol	1993	4	90.80	51
NE (N8C (TL20H))	Petrol	1993	4	90.80	50
NE1	Petrol	1993	4	90.80	51
NE4	Petrol	1993	4	90.80	51
NE5	Petrol	1993	4	90.80	51
NEE	Petrol	1993	4	90.80	50
NEG	Petrol	1993	4	90.80	50
NEJ	Petrol	1993	4	90.80	51
NEK (N8C (TL20H))	Petrol	1993	4	90.80	50
NEL (N8C (TL20H))	Petrol	1993	4	90.80	51
NEN	Petrol	1993	4	90.80	50
NEP (N8C (TL20H))	Petrol	1993	4	90.80	50
NER (N8C (TL20H))	Petrol	1993	4	90.80	50
NES (N8C (TL20H))	Petrol	1993	4	90.80	51
NET (N8C (TL20H))	Petrol	1993	4	90.80	51
NGA (ZH20 Zetec E)	Petrol	1988	4	84.80	33
NGDA (Duratorq TDCI)	Diesel	1560	4	75.00	8
NR2	Petrol	1993	4	90.80	51
NRA	Petrol	1993	4	90.80	51
NRB	Petrol	1993	4	90.80	51
NRD	Petrol	1993	4	90.80	51
NRI	Petrol	1993	4	90.80	51
NSD (DL20)	Petrol	1998	4	86.00	37
NSE (DL20)	Petrol	1998	4	86.00	37
NWR	Petrol	1999	V6	84.00	32
NY	Petrol	1999	V6	84.00	32
NYP	Petrol	1999	V6	84.00	32
NYR	Petrol	1999	V6	84.00	32
NYT	Petrol	1999	V6	84.00	32
P7PA (Duratorq TDCI)	Diesel	1753	4	82.50	27
P7PB (Duratorq TDCI)	Diesel	1753	4	82.50	27

ENGINE INDEX

Motorverzeichnis • Index de moteur • Índice de Motor
Indeks silnika • Модель двигателя • دليل المحرك



CCM



9

P8FA	Diesel	2198	4	86.00	38
P8FB	Diesel	2198	4	86.00	38
P9PA (Duratorq TDCI)	Diesel	1753	4	82.50	27
P9PB (Duratorq TDCI)	Diesel	1753	4	82.50	27
P9PC (Duratorq TDCI)	Diesel	1753	4	82.50	27
P9PD (Duratorq TDCI)	Diesel	1753	4	82.50	27
PGFA	Diesel	2198	4	86.00	38
PGFB	Diesel	2198	4	86.00	38
PHFA	Diesel	2402	4	89.90	47
PHFC	Diesel	2402	4	89.90	47
PR5 (TV28)	Petrol	2792	V6	93.00	55
PR6 (TV28)	Petrol	2792	V6	93.00	55
PR7 (TV28)	Petrol	2792	V6	93.00	55
PR8 (TV28)	Petrol	2792	V6	93.00	55
PRB (TV28)	Petrol	2792	V6	93.00	55
PRC (TV28)	Petrol	2792	V6	93.00	55
PRD (TV28)	Petrol	2792	V6	93.00	55
PRE (TV28)	Petrol	2792	V6	93.00	55
PRG (TV28)	Petrol	2792	V6	93.00	55
PRN (TV28)	Petrol	2792	V6	93.00	55
PRT (TV28)	Petrol	2792	V6	93.00	55
PYA (TV28)	Petrol	2792	V6	93.00	55
PYU (TV28)	Petrol	2792	V6	93.00	55
Q7DA (Duratec HE)	Petrol	1798	4	83.00	30
QJBA (Duratorq)	Diesel	2198	4	86.00	38
QJBB (Duratorq)	Diesel	2198	4	86.00	38
QJBC (Duratorq)	Diesel	2198	4	86.00	38
QJBD (Duratorq)	Diesel	2198	4	86.00	38
QQDA (Duratec HE)	Petrol	1798	4	83.00	30
QQDB (Duratec HE)	Petrol	1798	4	83.00	30
QVFA	Diesel	2198	4	86.00	38
QWFA	Diesel	2198	4	86.00	38
QYBA (Duratorq TDCI)	Diesel	1753	4	82.50	27
QYWA	Diesel	1753	4	82.50	27
R2A	Petrol	1796	4	86.20	40
R2C (HL18H CVH)	Petrol	1769	4	79.94	18
R2PA (Duratorq TDCI)	Diesel	1753	4	82.50	27
R3PA (Duratorq TDCI)	Diesel	1753	4	82.50	27
R6A (HL18H CVH)	Petrol	1769	4	79.94	18
RDA (ZH18N/M/P Zetec E)	Petrol	1796	4	80.60	22
RDB (ZH18N/M/P Zetec E)	Petrol	1796	4	80.60	22
REB	Petrol	1796	4	86.20	40
REC	Petrol	1796	4	86.20	40
RED	Petrol	1796	4	86.20	40
REF	Petrol	1796	4	86.20	40
RF	Diesel	1998	4	86.00	39
RFA (D18T)	Diesel	1753	4	82.50	28
RFB (D18T)	Diesel	1753	4	82.50	28
RFD	Diesel	1753	4	82.50	28
RFK	Diesel	1753	4	82.50	28
RFL (D18T)	Diesel	1753	4	82.50	28
RFM	Diesel	1753	4	82.50	28
RFN	Diesel	1753	4	82.50	28
RFS (D18TI/Endura DE)	Diesel	1753	4	82.50	28
RFU	Diesel	1753	4	82.50	28
RHBA	Petrol	1596	4	79.00	15
RKA (ZH18N/M/P Zetec E)	Petrol	1796	4	80.60	22
RKB (ZH18N/M/P Zetec E)	Petrol	1796	4	80.60	22
RKC (ZH18N/M/P Zetec E)	Petrol	1796	4	80.60	22
RKF (ZH18N/M/P Zetec E)	Petrol	1796	4	80.60	22



CCM



9

RKH (ZH18N/M/P Zetec E)	Petrol	1796	4	80.60	22
RKJ (ZH18N/M/P Zetec E)	Petrol	1796	4	80.60	22
RKK (ZH18N/M/P Zetec E)	Petrol	1796	4	80.60	22
RQB (ZH18N/M/P Zetec E)	Petrol	1796	4	80.60	22
RQC (ZH18N/M/P Zetec E)	Petrol	1796	4	80.60	22
RTA (D18NA)	Diesel	1753	4	82.50	29
RTB (D18NA)	Diesel	1753	4	82.50	29
RTC (D18NA)	Diesel	1753	4	82.50	29
RTD (D18NA)	Diesel	1753	4	82.50	29
RTE (D18NA)	Diesel	1753	4	82.50	29
RTF (D18NA)	Diesel	1753	4	82.50	29
RTG (D18NA)	Diesel	1753	4	82.50	29
RTH (D18NA)	Diesel	1753	4	82.50	29
RTJ (D18NA/Endura DE)	Diesel	1753	4	82.50	29
RTK (D18NA/Endura DE)	Diesel	1753	4	82.50	29
RVA (D18TC)	Diesel	1753	4	82.50	28
RWPA (Duratorq)	Diesel	1753	4	82.50	27
RWPC (Duratorq TDCI)	Diesel	1753	4	82.50	27
RWPD (Duratorq TDCI)	Diesel	1753	4	82.50	27
RWPE (Duratorq TDCI)	Diesel	1753	4	82.50	27
RWPF (Duratorq TDCI)	Diesel	1753	4	82.50	27
SCB	Diesel	2500	4	92.00	53
SCC	Diesel	2500	4	92.00	53
SDBA (Duratorq)	Diesel	1998	4	86.00	36
SFA (XD3T)	Diesel	2498	4	94.00	60
SFB (XD3T)	Diesel	2498	4	94.00	60
SIDA (Duratec Ti-VCT)	Petrol	1596	4	79.00	15
SPJA (Duratec)	Petrol	1388	4	76.00	9
STP (XD3/XD3P)	Diesel	2498	4	94.00	61
STR (XD3/XD3P)	Diesel	2498	4	94.00	61
T1BA (Duratorq TDCI)	Diesel	1560	4	75.00	8
T1BB (Duratorq TDCI)	Diesel	1560	4	75.00	8
T1BC (Duratorq TDCI)	Diesel	1560	4	75.00	8
T1DA (Duratorq TDCI)	Diesel	1560	4	75.00	8
T1DB (Duratorq TDCI)	Diesel	1560	4	75.00	8
T3DA (Duratorq TDCI)	Diesel	1560	4	75.00	8
T3DB (Duratorq TDCI)	Diesel	1560	4	75.00	8
T3JA (Duratorq TDCI)	Diesel	1560	4	75.00	8
T3JB	Diesel	1560	4	75.00	8
TKA	Petrol	957	4	74.00	5
TKB	Petrol	957	4	74.00	5
TKW	Petrol	957	4	74.00	5
TL 16 L	Petrol	1593	4	87.65	42
TL 20 H	Petrol	1993	4	90.80	50
TL 20 LC	Petrol	1994	4	90.80	50
TLA	Petrol	957	4	74.00	5
TLB (BL10H)	Petrol	999	4	68.70	1
TV24	Petrol	2394	V6	84.00	31
TZJA (Duratorq TDCI)	Diesel	1560	4	75.00	8
TZJB (Duratorq TDCI)	Diesel	1560	4	75.00	8
UBJA (Duratorq TDCI)	Diesel	1560	4	75.00	7
UC	Petrol	1416	4	77.00	12
VM	Diesel	2500	4	92.00	53
WTA (XD90)	Diesel	2112	4	90.00	49
XD2S	Diesel	2304	4	94.00	60
XD3P	Diesel	2498	4	94.00	61
XD88, XDP88	Diesel	1948	4	88.00	44
Y5A	Petrol	2295	4	89.60	45
Y5B	Petrol	2295	4	89.60	45
YTR (XD2/XD2P/XD94)	Diesel	2304	4	94.00	61

ENGINE INDEX

Motorverzeichnis • Index de moteur • Índice de Motor
Indeks silnika • Модель двигателя • دليل المحرك



CCM



9

		CCM	x		
YTT (XD2/XD2P/XD94)	Diesel	2304	4	94.00	61
YYF	Petrol	2293	V6	90.00	48
YYH (TV23)	Petrol	2293	V6	90.00	48
YYN	Petrol	2293	V6	90.00	48
YYP (TV23)	Petrol	2293	V6	90.00	48
YYR	Petrol	2293	V6	90.00	48
YYT	Petrol	2293	V6	90.00	48
YYU (TV23)	Petrol	2293	V6	90.00	48
ZVSA (DL20)	Petrol	1998	4	86.00	37



Fiesta III 1.1		03/89→12/95	G6A (BL11)		4cyl. 1118cc CFi HCS	37kW (50PS)	1	TD4455
Fiesta III 1.1		03/89→12/95	GUD (BL11H)		4cyl. 1118cc HCS	40kW (54PS)		TD1209
Fiesta III 1.1		03/89→12/95	GUE (BL11H)		4cyl. 1118cc HCS	40kW (54PS)		TD1210
Fiesta II 1.0 Fiesta III 1.0		09/83→11/89 03/89→12/95	TLB (BL10H)		4cyl. 999cc HCS	33kW (45PS)		TD1454
08-784100-00	STD	68.70	1.500		001 IF MO P			IKA
08-784107-00	0.50mm		1.750		026 P			STD
08-784111-00	1.00mm		3.000		712 CR			ST
[R43430]								

Fiesta IV 1.25 i 16V		08/95→01/02	DHA (Zetec SE)		4cyl. 1242cc	55kW (75PS)	2	TD12069
Fiesta IV 1.25 i 16V		08/95→01/02	DHB (Zetec SE)		4cyl. 1242cc	55kW (75PS)		TD12070
Fiesta IV 1.25 i 16V		08/95→01/02	DHC (Zetec SE)		4cyl. 1242cc	55kW (75PS)		TD15921
Fiesta IV 1.25 i 16V		08/95→01/02	DHD (Zetec SE)		4cyl. 1242cc	55kW (75PS)		TD15922
Fiesta IV 1.25 i 16V		08/95→01/02	DHE (Zetec SE)		4cyl. 1242cc	55kW (75PS)		TD15923
Fiesta IV 1.25 i 16V		08/95→01/02	DHF (Zetec SE)		4cyl. 1242cc	55kW (75PS)		TD15924
Fiesta IV 1.25 i 16V		08/95→01/02	DHG (Zetec SE)		4cyl. 1242cc	55kW (75PS)		TD15925
08-102200-00	STD	71.90	1.200		001 CR			KV1
08-102207-00	0.50mm		1.500		026 P			GOE13
			2.500		712 CR			ST
[R49750]								



Fiesta V 1.4 TDCi	11/01→	F6JA / DV4TD (Duratorq)	3
Fiesta Van 1.4 TDCi	10/03→	4cyl.	
Fusion 1.4 TDCi	08/02→	1399cc 50kW (68PS)	
		Diesel Turbo Intercooled	TD17307

Fiesta V 1.4 TDCi	11/01→	F6JB (DV4TED)	4
Fiesta Van 1.4 TDCi	10/03→	4cyl.	
Fiesta VI 1.4 TDCi	01/09→	1399cc 50kW (68PS)	
Fusion 1.4 TDCi	08/02→	Diesel Turbo Intercooled	TD17346

08-135300-00	STD	73.70	2.500		008 CK P	KV1
08-135305-00	0.25mm		1.950		005 IFU P	GOE12
08-135307-00	0.50mm		2.500		231 CR P	GOE12
[R66770]						

Ka 1.3 i	08/02→11/08	A9A (Duratec)	4
		4cyl.	
		1299cc 51kW (69PS)	
			TD18764

Ka 1.3 i	08/02→11/08	A9B (Duratec)	4
		4cyl.	
		1299cc 51kW (69PS)	
			TD18765

08-449000-00	STD	74.00	1.200		001 CR P	STD
08-449007-00	0.50mm		1.500		026 P	STD
			2.000		231 CR P	STD

Escort '81 Express 1.1	03/81→02/86	GLB	5
Escort III 1.1, Escort III Estate 1.1	09/80→08/83	4cyl.	
		1117cc 37kW (50PS)	
		CVH	TD1197

Fiesta II 1.1	09/83→02/89	GLC	4
		4cyl.	
		1117cc 37kW (50PS)	
			TD1198

Escort III 1.1, Escort III Estate 1.1	09/80→08/83	GMA	4
		4cyl.	
		1117cc 40kW (54PS)	
		CVH	TD1200

Escort III 1.1	09/80→08/83	GPA	4
		4cyl.	
		1117cc 43kW (58PS)	
		CVH	TD1201

Escort III 1.1, Escort III Estate 1.1	08/83→12/85	GSE	4
		4cyl.	
		1117cc 37kW (50PS)	
		CVH	TD1203

Fiesta II 1.1	09/83→02/89	GSF	4
		4cyl.	
		1117cc 37kW (50PS)	
		CVH	TD1204

Escort '86 Express 1.1	05/86→07/90	GSG	4
Escort IV 1.1	12/85→07/90	4cyl.	
Escort IV Estate 1.1	10/85→09/90	1117cc 37kW (50PS)	
		CVH	TD1205





Escort '86 Express 1.3	02/86→07/90	JLA	4cyl.	1299cc	44kW (60PS)	TD1236
Escort IV 1.3, Escort IV Estate 1.3	01/86→07/90					
Orion II 1.3	12/85→07/90					
Escort '86 Express 1.3	02/86→07/90	JLB	4cyl.	1299cc	44kW (60PS)	TD1237
Escort IV 1.3, Escort IV Estate 1.3	01/86→07/90					
Orion II 1.3	12/85→07/90					
Fiesta Box 1.0	10/77→11/86	TKA	4cyl.	957cc	29kW (39PS)	TD4495
Fiesta I 0.9	05/76→08/83					
Fiesta Box 1.0	08/83→11/89	TKB	4cyl.	957cc	33kW (45PS)	TD1452
Fiesta II 1.0	09/83→02/89					
Fiesta I 0.9	05/76→08/83	TKW	4cyl.	957cc	29kW (39PS)	TD4496
Fiesta I 0.9	05/76→08/83	TLA	4cyl.	957cc	33kW (45PS)	TD1453
08-208800-00	STD	74.00	1.600		001 IF CR P	IKA
08-208807-00	0.50mm		2.000		026 P	STD
08-208811-00	1.00mm		4.000		712 CR	ST
[R28676]						
Escort V 1.3	07/90→09/92	J4B / BL13 (Endura E)	4cyl.	1299cc	44kW (60PS)	TD4458
Escort V Estate 1.3	09/91→09/92					
Escort VI 1.3, Escort VI Estate 1.3	09/92→01/95					
Escort VI Saloon 1.3	08/93→01/95					
Escort VII 1.3	01/95→10/98					
Escort VII Estate 1.3	01/95→01/99					
Escort VII Saloon 1.3	01/95→02/99					
Orion III 1.3	07/90→12/93					
Fiesta Box 1.3	02/96→	J4C (Endura E)	4cyl.	1299cc	44kW (60PS)	TD11087
Fiesta IV 1.3 i	08/95→01/02					
Ka 1.3 i	09/96→11/08	J4D/Endura E (Endura E)	4cyl.	1299cc	44kW (60PS)	TD12084
Ka Van 1.3 i	05/02→05/05					
Fiesta IV 1.3 i	08/95→01/02	J4J (Endura E)	4cyl.	1299cc	44kW (60PS)	TD12073
Ka 1.3 i	09/96→11/08	J4K (Endura E)	4cyl.	1299cc	44kW (60PS)	TD12085
Ka Van 1.3 i	05/02→05/05					

6





Fiesta IV 1.3 i	08/95→01/02	J4L (Endura E) 4cyl. 1299cc	44kW (60PS)	TD15930
Ka 1.3 i Ka Van 1.3 i	09/96→11/08 05/02→05/05	J4M (Endura E) 4cyl. 1299cc	44kW (60PS)	TD15952
Ka 1.3 i Ka Van 1.3 i	09/96→11/08 05/02→05/05	J4N (Endura E) 4cyl. 1299cc	44kW (60PS)	TD15953
Ka 1.3 i Ka Van 1.3 i	09/96→11/08 05/02→05/05	J4P (Endura E) 4cyl. 1299cc	44kW (60PS)	TD15954
Fiesta IV 1.3 i	08/95→01/02	J4Q (Endura E) 4cyl. 1299cc	44kW (60PS)	TD15931
Fiesta IV 1.3 i	08/95→01/02	J4R (Endura E) 4cyl. 1299cc	44kW (60PS)	TD15932
Ka 1.3 i Ka Van 1.3 i	09/96→11/08 05/02→05/05	J4S (Endura E) 4cyl. 1299cc	44kW (60PS)	TD15955
Fiesta IV 1.3 i	08/95→01/02	J4T (Endura E) 4cyl. 1299cc	44kW (60PS)	TD15933
Escort V 1.3 Escort V Estate 1.3 Escort VI 1.3, Escort VI Estate 1.3 Escort VI Saloon 1.3 Escort VII 1.3 Escort VII Estate 1.3 Escort VII Saloon 1.3 Orion III 1.3	07/90→09/92 09/91→09/92 09/92→01/95 08/93→01/95 01/95→10/98 01/95→01/99 01/95→02/99 07/90→12/93	J6A (BL13) 4cyl. 1299cc CFi HCS	44kW (60PS)	TD1223
Fiesta Box 1.3 Fiesta III 1.3 CAT	09/91→02/96 05/91→01/97	J6B (BL13) 4cyl. 1299cc CFi HCS	44kW (60PS)	TD1224
Escort '86 Express 1.3 Escort IV 1.3	07/88→07/90 07/88→10/90	JBA (BL13H) 4cyl. 1299cc HCS	46kW (63PS)	TD1227
Escort '86 Express 1.3 Escort IV 1.3, Escort IV Estate 1.3 Orion II 1.3	02/86→07/90 01/86→07/90 12/85→07/90	JBB (BL13H) 4cyl. 1299cc HCS	44kW (60PS)	TD4459
Fiesta III 1.3	03/89→12/92	JBC (BL13H) 4cyl. 1299cc HCS	44-46kW (60-63PS)	TD1229







Escort '91 Express 1.3	07/90→12/94	JBD	4cyl. 1299cc CFi HCS	46kW (63PS)	TD1230
		JBE	4cyl. 1299cc HCS	44kW (60PS)	TD1231
Fiesta IV 1.3 i	08/95→01/02	JJA (Endura E)	4cyl. 1299cc EFi	37kW (50PS)	TD12071
Ka 1.3 i	09/96→10/02	JJB/Endura E (Endura E)	4cyl. 1299cc	37kW (50PS)	TD12083
Fiesta IV 1.3 i	08/95→01/02	JJC (Endura E)	4cyl. 1299cc	37kW (50PS)	TD12072
Ka 1.3 i	06/98→11/08	JJD (Endura E)	4cyl. 1299cc EFi	36kW (49PS)	TD12082
Fiesta IV 1.3 i	08/95→01/02	JJE/Endura E (Endura E)	4cyl. 1299cc	37kW (50PS)	TD15926
Ka 1.3 i	06/98→11/08	JJF (Endura E)	4cyl. 1299cc	36kW (49PS)	TD15948
Ka 1.3 i	06/98→11/08	JJG (Endura E)	4cyl. 1299cc	36kW (49PS)	TD15949
Ka 1.3 i	06/98→11/08	JJH (Endura E)	4cyl. 1299cc	36kW (49PS)	TD15950
Fiesta IV 1.3 i	08/95→01/02	JJJ (Endura E)	4cyl. 1299cc	37kW (50PS)	TD15927
Fiesta IV 1.3 i	08/95→01/02	JJK (Endura E)	4cyl. 1299cc	37kW (50PS)	TD15928
Ka 1.3 i	06/98→11/08	JJL (Endura E)	4cyl. 1299cc	36kW (49PS)	TD15951









Fiesta IV 1.3 i		08/95→01/02	JJM (Endura E) 4cyl. 1299cc 37kW (50PS)		TD15929	
08-785000-00	STD	74.00	1.500		001 IF CR P	IKA
08-785007-00	0.50mm		1.750		026 P	STD
08-785011-00	1.00mm		3.000		712 CR	ST
[R43440]						
C-Max 1.6 TDCi		02/07→	G8DA (Duratorq) 4cyl. 1560cc 80kW (109PS)		7	
Focus C-MAX 1.6 TDCi		10/03→03/07	Diesel Turbo Intercooled			
Focus II 1.6 TDCi,		11/04→			TD18508	
Focus II Estate 1.6 TDCi		04/05→				
Focus II Saloon 1.6 TDCi						
C-Max 1.6 TDCi		02/07→	G8DB (Duratorq) 4cyl. 1560cc 80kW (109PS)			
Focus C-MAX 1.6 TDCi		10/03→03/07	Diesel Turbo Intercooled			
Focus II 1.6 TDCi,		11/04→			TD18509	
Focus II Estate 1.6 TDCi		04/05→				
Focus II Saloon 1.6 TDCi						
C-Max 1.6 TDCi		02/07→	HHDA Euro 4 4cyl. 1560cc 66kW (89PS)			
Focus C-MAX 1.6 TDCi		02/05→03/07	Diesel Turbo Intercooled			
Focus II 1.6 TDCi		01/05→			TD18478	
Focus II Estate 1.6 TDCi		11/04→				
Focus II Saloon 1.6 TDCi		04/05→				
C-Max 1.6 TDCi		02/07→	HHDB Euro 4 4cyl. 1560cc 66kW (89PS)			
Focus C-MAX 1.6 TDCi		02/05→03/07	Diesel Turbo Intercooled			
Focus II 1.6 TDCi		01/05→			TD18479	
Focus II Estate 1.6 TDCi		11/04→				
Focus II Saloon 1.6 TDCi		04/05→				
Fiesta V 1.6 TDCi, Fusion 1.6 TDCi		11/04→	HHJA (Duratorq) 4cyl. 1560cc 66kW (89PS)			
			Diesel Turbo Intercooled			
					TD17988	
Fiesta V 1.6 TDCi, Fusion 1.6 TDCi		11/04→	HHJB (Duratorq) 4cyl. 1560cc 66kW (89PS)			
			Diesel Turbo Intercooled			
					TD17989	
Fiesta Van 1.6 TDCi		01/09→	HHJC (Duratorq TDCI) 4cyl. 1560cc 66kW (89PS)			
Fiesta VI 1.6 TDCi		10/08→	Diesel Turbo Intercooled			
					TD24416	
Fiesta Van 1.6 TDCi		01/09→	HHJD (Duratorq TDCI) 4cyl. 1560cc 66kW (89PS)			
Fiesta VI 1.6 TDCi		10/08→	Diesel Turbo Intercooled			
					TD23543	
Fiesta Van 1.6 TDCi		01/09→	HHJE (Duratorq TDCI) 4cyl. 1560cc 66kW (89PS)			
Fiesta VI 1.6 TDCi		10/08→	Diesel Turbo Intercooled			
					TD24417	





Fiesta VI 1.6 TDCi		10/08→	UBJA (Duratorq TDCI)			
			4cyl.			
			1560cc 55kW (75PS)			
			Diesel	Turbo Intercooled		TD24419
08-424000-00	STD	75.00	3.000		008 CK P	KV1
08-424007-00	0.50mm		1.950		005 P	F12/F14
08-424008-00	0.60mm		2.500		231 LKZ CR P	GOE12
						
Focus III 1.6 TDCi ECONetic, Focus III Turnier 1.6 TDCi ECONetic		05/12→	NGDA (Duratorq TDCI)			8
			4cyl.			
			1560cc 77kW (105PS)			
			Diesel	Turbo Intercooled		TD26481
Mondeo IV 1.6 TDCi, Mondeo IV Turnier 1.6 TDCi		02/11→	T1BA (Duratorq TDCI)			
			4cyl.			
			1560cc 85kW (116PS)			
			Diesel	Turbo Intercooled		TD26475
Mondeo IV 1.6 TDCi, Mondeo IV Turnier 1.6 TDCi		02/11→	T1BB (Duratorq TDCI)			
			4cyl.			
			1560cc 85kW (116PS)			
			Diesel	Turbo Intercooled		TD26476
Mondeo IV 1.6 TDCi, Mondeo IV Turnier 1.6 TDCi		02/11→	T1BC (Duratorq TDCI)			
			4cyl.			
			1560cc 85kW (116PS)			
			Diesel	Turbo Intercooled		TD26477
C-Max II 1.6 TDCi Focus III 1.6 TDCi, Focus III Saloon 1.6 TDCi Focus III Turnier 1.6 TDCi Grand C-Max 1.6 TDCi		12/10→ 04/11→ 05/11→ 12/10→	T1DA (Duratorq TDCI)			
			4cyl.			
			1560cc 85kW (116PS)			
			Diesel	Turbo Intercooled		TD25883
C-Max II 1.6 TDCi Focus III 1.6 TDCi, Focus III Saloon 1.6 TDCi Focus III Turnier 1.6 TDCi Grand C-Max 1.6 TDCi		12/10→ 04/11→ 05/11→ 12/10→	T1DB (Duratorq TDCI)			
			4cyl.			
			1560cc 85kW (116PS)			
			Diesel	Turbo Intercooled		TD25884
C-Max II 1.6 TDCi Focus III 1.6 TDCi, Focus III Saloon 1.6 TDCi Focus III Turnier 1.6 TDCi Grand C-Max 1.6 TDCi		12/10→ 04/11→ 05/11→ 12/10→	T3DA (Duratorq TDCI)			
			4cyl.			
			1560cc 70kW (95PS)			
			Diesel	Turbo Intercooled		TD25881
C-Max II 1.6 TDCi Focus III 1.6 TDCi, Focus III Saloon 1.6 TDCi Focus III Turnier 1.6 TDCi Grand C-Max 1.6 TDCi		12/10→ 04/11→ 05/11→ 12/10→	T3DB (Duratorq TDCI)			
			4cyl.			
			1560cc 70kW (95PS)			
			Diesel	Turbo Intercooled		TD25882
Fiesta VI 1.6 TDCi		02/10→	T3JA (Duratorq TDCI)			
			4cyl.			
			1560cc 70kW (95PS)			
			Diesel	Turbo Intercooled		TD26473
B-Max 1.6 TDCi		10/12→	T3JB			
			4cyl.			
			1560cc 70kW (95PS)			
			Diesel	Turbo Intercooled		TD28069





Fiesta Van 1.6 TDCi, Fiesta VI 1.6 TDCi		02/10→	TZJA (Duratorq TDCI)				
			4cyl.				
			1560cc	70kW (95PS)			
			Diesel	Turbo Intercooled			TD24420
Fiesta Van 1.6 TDCi, Fiesta VI 1.6 TDCi		02/10→	TZJB (Duratorq TDCI)				
			4cyl.				
			1560cc	70kW (95PS)			
			Diesel	Turbo Intercooled			TD24421
08-433600-00	STD	75.00	2.500		008 CK P		KV1
08-433607-00	0.50mm		1.950		026 P		F12/F14
			2.000		231 LKZ CR P		KV1
Focus II 1.4, Focus II Estate 1.4		11/04→	ASDA				9
Focus II Saloon 1.4		04/05→	4cyl.				
			1388cc	59kW (80PS)			TD18501
Focus II 1.4, Focus II Estate 1.4		11/04→	ASDB				
Focus II Saloon 1.4		04/05→	4cyl.				
			1388cc	59kW (80PS)			TD18502
Fiesta VI 1.4		10/08→	SPJA (Duratec)				
			4cyl.				
			1388cc	71kW (96PS)			TD23538
08-426100-00	STD	76.00	1.200		001 NT		ST
08-426107-00	0.50mm		1.500		005 P		STD
			2.500		712 NT		ST
Fiesta Box 1.4 i		04/96→10/99	FHA (Zetec SE)				10
Fiesta IV 1.4 i 16V		04/96→01/02	4cyl.				
			1388cc	66kW (89PS)			TD12074
Puma 1.4 16V		11/97→10/00	FHD (Zetec SE)				
			4cyl.				
			1388cc	66kW (89PS)			TD11327
Fiesta IV 1.4 i 16V		04/96→01/02	FHE (Zetec SE)				
			4cyl.				
			1388cc	66kW (89PS)			TD15934
Puma 1.4 16V		11/97→10/00	FHF (Zetec SE)				
			4cyl.				
			1388cc	66kW (89PS)			TD15919
Focus 1.4 16V		10/98→11/04	FXDA (Zetec SE)				
Focus Estate 1.4 16V,		02/99→11/04	4cyl.				
Focus Saloon 1.4 16V			1388cc	55kW (75PS)			TD12075
Focus 1.4 16V		10/98→11/04	FXDB (Zetec SE)				
Focus Estate 1.4 16V,		02/99→11/04	4cyl.				
Focus Saloon 1.4 16V			1388cc	55kW (75PS)			TD15892





Focus 1.4 16V Focus Estate 1.4 16V, Focus Saloon 1.4 16V	10/98→11/04 02/99→11/04	FXDC (Zetec SE)	4cyl. 1388cc	55kW (75PS)	TD12076
Focus 1.4 16V Focus Estate 1.4 16V, Focus Saloon 1.4 16V	10/98→11/04 02/99→11/04	FXDD (Zetec SE)	4cyl. 1388cc	55kW (75PS)	TD15893
Fiesta V 1.4 16V Fusion 1.4	11/01→ 08/02→	FXJA	4cyl. 1388cc	59kW (80PS)	TD17304
Fiesta V 1.4 16V Fusion 1.4	11/01→ 08/02→	FXJB	4cyl. 1388cc	59kW (80PS)	TD17305
08-102300-00 STD 08-102307-00 0.50mm [R49760]	76.00	1.200 1.500 2.500	 	001 NT 026 P 712 CR	ST STD ST
Escort Classic 1.6 16V Escort Classic Turnier 1.6 16V Escort VI 1.6 i 16V Escort VI Convertible 1.6 16V XR3i Escort VI Estate 1.6 i 16V Escort VI Saloon 1.6 i 16V Escort VII 1.6 16V, Escort VII 1.6 16V 4x4 Escort VII Convertible 1.6 16V XR3i Escort VII Estate 1.6 16V, Escort VII Saloon 1.6 i 16V Orion III 1.6 i 16V	10/98→07/00 02/99→07/00 09/92→01/95 12/92→01/95 09/92→01/95 08/93→01/95 01/95→10/98 02/95→09/99 01/95→02/99 07/92→12/93	L1E (Zetec)	4cyl. 1597cc	66kW (89PS)	TD1249
Mondeo I 1.6 i 16V Mondeo I Estate 1.6 i 16V Mondeo I Saloon 1.6 i 16V	02/93→08/96 04/93→08/96 02/93→08/96	L1F (Zetec)	4cyl. 1597cc	66kW (89PS)	TD10069
Fiesta III 1.6 i 16V	01/94→12/95	L1G (Zetec E)	4cyl. 1597cc	66kW (89PS)	TD9467
Escort VI 1.6 i 16V Escort VI Convertible 1.6 i 16V Escort VI Estate 1.6 i 16V, Escort VI Saloon 1.6 i 16V Escort VII 1.6 i 16V Escort VII Convertible 1.6 16V XR3i Escort VII Estate 1.6 i 16V, Escort VII Saloon 1.6 i 16V	01/94→01/95 02/94→01/95 01/94→01/95 01/95→08/95 02/95→12/96 01/95→08/95	L1H (ZH16 Zetec E)	4cyl. 1597cc	65kW (88PS)	TD5105
Mondeo I 1.6 i 16V, Mondeo I Estate 1.6 i 16V, Mondeo I Saloon 1.6 i 16V Mondeo II 1.6 i, Mondeo II Estate 1.6 i, Mondeo II Saloon 1.6 i	07/94→08/96 09/96→11/00	L1J (Zetec E)	4cyl. 1597cc	65kW (88PS)	TD4464

11





Escort VI Saloon 1.6 i 16V Escort VII Saloon 1.6 i 16V Orion III 1.6 i 16V		08/93→01/95 01/95→02/99 07/92→12/93	L1K (Zetec E) 4cyl. 1597cc 66kW (89PS)		TD10849
Mondeo II 1.6 i 16V, Mondeo II Estate 1.6 i 16V, Mondeo II Saloon 1.6 i 16V		05/98→11/00	L1L (Zetec E) 4cyl. 1597cc 70kW (95PS)		TD12087
Mondeo II 1.6 i 16V, Mondeo II Estate 1.6 i 16V, Mondeo II Saloon 1.6 i 16V		05/98→11/00	L1N (Zetec E) 4cyl. 1597cc 70kW (95PS)		TD15990
Mondeo II 1.6 i 16V, Mondeo II Estate 1.6 i 16V, Mondeo II Saloon 1.6 i 16V		05/98→11/00	L1Q (Zetec E) 4cyl. 1597cc 70kW (95PS)		TD16010
Fiesta III 1.6		01/89→01/94	LUH 4cyl. 1597cc 65kW (88PS) CVH		TD1305
08-786300-00 STD 08-786307-00 0.50mm 07/1992→04/1994 [R46060]	76.00	1.500 1.600 2.500	 	001 CR P 026 P 236 P	IKA STD STD
08-786600-00 STD 01/1993→ [R67460]	76.00	1.200 1.600 2.500	 	001 CR P 023 P 231 CR P	KV1 STD STD
08-786900-00 STD 05/1994→ [R67570]	76.00	1.200 1.600 2.500	 	001 NT 026 P 231 CR P	ST STD STD
Econovan 1.4, Econovan Box 1.4		03/86→03/92	UC 4cyl. 1416cc 48kW (65PS)		12 TD1469
08-283900-00 STD [R40510]	77.00	1.500 2.000 4.000	 	001 IF CR P 026 P 236 P	IKA STD STD



Fiesta III 1.4 CAT	03/89→12/95	F4A (HL14EFI CVH) 4cyl. 1392cc	55kW (75PS)	13 TD10007
Escort '95 Box 1.4	01/95→	F4B (HL14EFI CVH) 4cyl. 1392cc	55kW (75PS)	TD4447
Escort VI 1.4	01/94→01/95			
Escort VI Convertible 1.4 i	07/93→01/95			
Escort VI Estate 1.4	01/94→01/95			
Escort VI Saloon 1.4	08/93→01/95			
Escort VII 1.4	01/95→10/98			
Escort VII Convertible 1.4	02/95→08/98			
Escort VII Estate 1.4,	01/95→02/99			
Escort VII Saloon 1.4				
Fiesta Box 1.4	09/86→09/89	F6A 4cyl. 1393cc	52-54kW (71-73PS)	TD4448
Fiesta II 1.4	10/86→02/89			
		CFi CVH		
Escort '86 Express 1.4 i	02/86→07/90	F6B (HL14G CVH) 4cyl. 1392cc	55kW (75PS)	TD1171
Escort IV 1.4	01/86→07/90			
Escort IV Convertible 1.4	02/87→07/90			
Escort IV Estate 1.4	01/86→07/90	CVH		
Orion II 1.4 CAT	02/87→07/90			
Fiesta II 1.4	10/86→02/89	F6C 4cyl. 1392cc	52kW (71PS)	TD4450
		CFi CVH		
Escort '86 Express 1.4 i	02/86→07/90	F6D (HL14G CVH) 4cyl. 1392cc	55kW (75PS)	TD1174
Escort IV 1.4	01/86→07/90			
Escort IV Convertible 1.4	02/87→07/90			
Escort IV Estate 1.4	01/86→07/90	CVH		
Orion II 1.4 CAT	02/87→07/90			
Fiesta III 1.4	03/89→12/95	F6E (HL14CFI CVH) 4cyl. 1392cc	52kW (71PS)	TD4451
		CVH		
Escort '91 Express 1.4	07/90→12/94	F6F (HL14CFI CVH) 4cyl. 1392cc	52kW (71PS)	TD1177
Escort V 1.4	07/90→09/92			
Escort V Convertible 1.4	07/90→12/92			
Escort V Estate 1.4	07/90→09/92	CVH		
Escort VI 1.4	09/92→01/95			
Escort VI Convertible 1.4	12/92→04/94			
Escort VI Estate 1.4	09/92→01/95			
Escort VI Saloon 1.4	08/93→04/94			
Orion III 1.4	07/90→12/93			
Escort '91 Express 1.4	07/90→12/94	F6G (HL14CFI CVH) 4cyl. 1392cc	52kW (71PS)	TD1178
Escort V 1.4	07/90→09/92			
Escort V Convertible 1.4	07/90→12/92			
Escort V Estate 1.4	07/90→09/92	CVH		
Escort VI 1.4	09/92→01/95			
Escort VI Convertible 1.4	12/92→04/94			
Escort VI Estate 1.4	09/92→01/95			
Escort VI Saloon 1.4	08/93→04/94			
Orion III 1.4	07/90→12/93			
Escort IV 1.4, Escort IV Convertible 1.4,	01/86→07/90	FUA (HL14G CVH) 4cyl. 1392cc	55kW (75PS)	TD4453
Escort IV Estate 1.4				
Orion II 1.4	12/85→07/90	CVH		





Escort IV 1.4, Escort IV Estate 1.4 Orion II 1.4	10/85→10/90 03/86→07/90	FUAA (HL14G CVH)	4cyl. 1392cc CVH	51kW (69PS)	TD1181
Fiesta II 1.4	10/85→11/89	FUB	4cyl. 1392cc CVH	55kW (75PS)	TD1182
Fiesta II 1.4	09/83→01/87	FUBA	4cyl. 1392cc	51kW (69PS)	TD1183
Escort '86 Express 1.4 i Escort IV 1.4 Escort IV Convertible 1.4 Escort IV Estate 1.4, Orion II 1.4	02/86→07/90 01/86→07/90 02/87→07/90 01/86→07/90	FUC (HL14G CVH)	4cyl. 1392cc CVH	55kW (75PS)	TD1184
Fiesta II 1.4	02/87→02/89	FUD	4cyl. 1392cc CVH	54kW (73PS)	TD1185
Fiesta III 1.4	11/92→12/96	FUF	4cyl. 1392cc CVH	55kW (75PS)	TD1186
Fiesta III 1.4	03/89→12/95	FUG (HL14G CVH)	4cyl. 1392cc CVH	55kW (75PS)	TD1187
Escort VI 1.4, Escort VI Estate 1.4 Escort VI Saloon 1.4 Escort VII Estate 1.4, Escort VII Saloon 1.4 Orion III 1.4	01/94→01/95 08/93→01/95 01/95→02/99 07/90→12/93	FUH (HL14EFI CVH)	4cyl. 1392cc	55kW (75PS)	TD1188
Fiesta III 1.4	03/89→12/95	FUJ (HL14G CVH)	4cyl. 1392cc CVH	55kW (75PS)	TD1189
08-781100-00 08-781107-00 08-781111-00 [R42330]	STD 0.50mm 1.00mm 77.24	1.600 2.000 4.000	 	001 IF MO P 026 P 712 CR	IKA STD ST
Focus 1.6 16V Focus Estate 1.6 16V, Focus Saloon 1.6 16V	10/98→11/04 02/99→11/04	FYDA (Zetec SE)	4cyl. 1596cc	74kW (100PS)	14 TD12077
Focus 1.6 16V Focus Estate 1.6 16V, Focus Saloon 1.6 16V	10/98→11/04 02/99→11/04	FYDB (Zetec SE)	4cyl. 1596cc	74kW (100PS)	TD15894
Focus 1.6 16V Focus Estate 1.6 16V, Focus Saloon 1.6 16V	10/98→11/04 02/99→11/04	FYDC (Zetec SE)	4cyl. 1596cc	74kW (100PS)	TD12078





Focus 1.6 16V Focus Estate 1.6 16V, Focus Saloon 1.6 16V	10/98→11/04 02/99→11/04	FYDD (Zetec SE)	4cyl. 1596cc	74kW (100PS)	TD15895
Focus 1.6 16V Focus 1.6 16V Flexifuel Focus Estate 1.6 16V Focus Estate 1.6 16V Flexifuel Focus Saloon 1.6 16V	10/98→11/04 01/02→11/04 02/99→11/04 01/02→11/04 02/99→11/04	FYDH (Zetec SE)	4cyl. 1596cc	74kW (100PS)	TD18776
Fiesta V 1.6 16V Fusion 1.6	11/01→ 08/02→	FYJA (Duratec)	4cyl. 1596cc	74kW (100PS)	TD17306
Fiesta V 1.6 16V Fusion 1.6	11/01→ 08/02→	FYJB (Duratec)	4cyl. 1597cc	74kW (100PS)	TD18778
Fiesta IV 1.6 16V Sport	02/00→01/02	L1T (Zetec SE)	4cyl. 1596cc	76kW (103PS)	TD15935
Fiesta IV 1.6 16V Sport	02/00→01/02	L1V (Zetec SE)	4cyl. 1596cc	76kW (103PS)	TD15936
Puma 1.6 16V	08/00→06/02	L1W	4cyl. 1596cc	76kW (103PS)	TD18770
08-141300-00 08-141307-00 [R49770]	STD 0.50mm 79.00	1.200 1.500 2.000	 	001 NT 026 P 712 CR	ST GOE13 STD ST
C-Max 1.6 Focus C-MAX 1.6 Focus II 1.6 Focus II Convertible 1.6 Focus II Estate 1.6 Focus II Saloon 1.6	02/07→ 10/03→03/07 11/04→ 10/06→ 11/04→ 04/05→	HWDA	4cyl. 1596cc	74kW (100PS)	15 TD18503
C-Max 1.6 Focus C-MAX 1.6 Focus II 1.6 Focus II Convertible 1.6 Focus II Estate 1.6 Focus II Saloon 1.6	02/07→ 10/03→03/07 11/04→ 10/06→ 11/04→ 04/05→	HWDB	4cyl. 1596cc	74kW (100PS)	TD18504
Focus C-MAX 1.6 Ti Focus II 1.6 Ti, Focus II Estate 1.6 Ti Focus II Saloon 1.6 Ti	08/04→03/07 11/04→ 04/05→	HXDA	4cyl. 1596cc	85kW (116PS)	TD18505
Focus II 1.6 Ti, Focus II Estate 1.6 Ti Focus II Saloon 1.6 Ti	11/04→ 04/05→	HXDB (Duratec Ti-VCT)	4cyl. 1596cc	85kW (116PS)	TD23365





Fiesta VI 1.6 Ti		10/08→	HXJA (Duratec Ti-VCT)			
				4cyl.		
				1596cc	88kW (120PS)	TD23541
Mondeo IV 1.6 Ti, Mondeo IV Saloon 1.6 Ti, Mondeo IV Turnier 1.6 Ti		03/07→	RHBA			
				4cyl.		
				1596cc	81kW (110PS)	TD23301
Focus C-MAX 1.6 Ti		08/04→03/07	SIDA (Duratec Ti-VCT)			
Focus II 1.6 LPG, Focus II Estate 1.6 LPG		10/09→		4cyl.		
				1596cc	85kW (116PS)	TD23366
08-428100-00	STD	79.00	1.200		001 NT	ST
01/2004→			1.500		026 P	GOE13
			2.000		712 NT	ST
Transit 115, Transit 125, Transit 130, Transit 150, Transit 175, Transit 90		01/70→12/78	4.108			16
Transit V20, Transit V30, Transit V40, Transit V50, Transit V60		01/65→12/70		4cyl.		
				1760cc		
				Diesel		FM1346
08-313400-00	STD	79.38	1.990		001 IF CR P	STD
[R34610]			1.600		001 IF P	STD
			1.600		023 P	STD
			4.747		231 P	STD
			4.747		031 P	STD
08-315200-00	STD	79.38	1.990		001 IF CR P	KV1
[R34590]			1.600		005 IF P	STD
			1.600		005 IF P	STD
			3.160		026 P	STD
			4.747		231 P	STD
Galaxy 1.9 TDI		03/95→05/06	1Z			17
				4cyl.		
				1896cc	66kW (89PS)	
				Diesel	Turbo Intercooled	TD11370
Galaxy 1.9 TDI		08/97→04/00	AFN			
				4cyl.		
				1896cc	81kW (110PS)	
				Diesel	Turbo Intercooled	TD11368
Galaxy 1.9 TDI		03/95→05/06	AHU			
				4cyl.		
				1896cc	66kW (89PS)	
				Diesel	Turbo Intercooled	TD11369





Galaxy 1.9 TDI		03/95→05/06	ANU	4cyl. 1896cc 66kW (89PS)		
			Diesel	Turbo Intercooled		TD14917
08-114900-00	STD	79.50	1.750		001 CK P	KV1
08-114905-00	0.25mm		2.000		005 IFU P	STD
08-114907-00	0.50mm		3.000		231 CR P	STD
08-114911-00	1.00mm					
[R60370]						
Sierra 1.8, Sierra Estate 1.8, Sierra Hatchback 1.8		05/88→02/93	R2C (HL18H CVH)	4cyl. 1769cc 64kW (87PS)		18
						TD1418
Sierra 1.8, Sierra Estate 1.8, Sierra Hatchback 1.8		05/88→02/93	R6A (HL18H CVH)	4cyl. 1769cc 63kW (86PS)		
						TD17422
08-785100-00	STD	79.94	1.500		001 IF MO P	IKA
08-785107-00	0.50mm		1.500		026 P	STD
			3.000		231 P	STD
[R43730]						
Escort '81 Express 1.3		03/81→02/86	JPA	4cyl. 1296cc 51kW (69PS)		19
Escort III 1.3		09/80→12/85		CVH		
Escort III Convertible 1.3		09/83→12/85				
Escort III Estate 1.3		03/81→12/85				
Orion I 1.3		07/83→03/86				
Orion II 1.3		11/86→07/88				TD1238
Fiesta II 1.3		09/83→09/89	JPC	4cyl. 1296cc 51kW (69PS)		
				CVH		TD1239
Escort III 1.6 i		07/85→12/85	L4B (HL16I CVH)	4cyl. 1598cc 66kW (89PS)		
Escort IV 1.6 i		01/86→05/90		CVH		
Escort IV Convertible 1.6 i,		01/86→07/90				
Escort IV Estate 1.6 i						
Orion II 1.6 i CAT		03/86→07/90				TD1252
Sierra 1.6 i, Sierra Estate 1.6 i, Sierra Hatchback 1.6 i		10/89→02/93	L6B	4cyl. 1597cc 59kW (80PS)		
				CFi CVH		TD1254
Escort IV 1.6 i,		08/89→07/90	LJB (HL16I CVH)	4cyl. 1597cc 75kW (102PS)		
Escort IV Convertible 1.6 i,				CVH		
Orion II 1.6 i						TD1275
Fiesta III 1.6 XR2i		03/89→03/93	LJD	4cyl. 1597cc 75-81kW (102-110PS)		
				EFi CVH		TD4465
Escort V 1.6, Escort V Convertible 1.6		07/90→12/92	LJF	4cyl. 1597cc 75-81kW (102-110PS)		
Escort V Estate 1.6, Orion III 1.6 i		07/90→09/92		EFi CVH		TD4466





Escort III 1.6	09/80→12/85	LP1			
Escort III Convertible 1.6	09/83→12/85		4cyl.		
Escort III Estate 1.6	09/80→12/85		1597cc	58kW (79PS)	
Orion I 1.6	07/83→03/86		CVH		TD1283
Escort IV 1.6	01/86→12/88	LP2 (HL16H CVH)			
Escort IV Convertible 1.6	01/86→12/87		4cyl.		
Escort IV Estate 1.6	01/86→07/90		1597cc	58kW (79PS)	
Orion II 1.6	04/86→12/88		CVH		TD1284
Fiesta II 1.6	01/85→11/89	LP3			
			4cyl.		
			1597cc	58kW (79PS)	
			CVH		TD1285
Escort III 1.6	09/80→12/85	LPA (HL16H CVH)			
Escort III Convertible 1.6	09/83→12/85		4cyl.		
Escort III Estate 1.6	09/80→12/85		1597cc	58kW (79PS)	
Escort IV Convertible 1.6	01/86→12/87		CVH		
Orion I 1.6	07/83→03/86				TD1286
Escort III 1.6 XR3i	10/82→12/85	LR1 (HL16I CVH)			
Escort III Convertible 1.6 i	09/83→12/85		4cyl.		
Orion I 1.6 i	07/83→03/86		1597cc	77kW (105PS)	
			CVH		TD1287
Escort IV 1.6 XR3i	01/86→08/89	LR2 (HL16I CVH)			
Escort IV Convertible 1.6 XR3i	01/86→07/90		4cyl.		
			1597cc	77kW (105PS)	
			CVH		TD1288
Escort III 1.6 XR3i	10/82→12/85	LRA (HL16I CVH)			
Escort III Convertible 1.6 i	09/83→12/85		4cyl.		
Orion I 1.6 i	07/83→03/86		1597cc	66-77kW (90-105PS)	
			CVH		TD1289
Escort IV 1.6 XR3i	01/86→08/89	LRB (HL16I CVH)			
Escort IV Convertible 1.6 XR3i	01/86→07/90		4cyl.		
Orion II 1.6 i	03/86→07/90		1597cc	77kW (105PS)	
			CVH		TD1290
Escort III 1.6	09/80→10/82	LUA (HL16G CVH)			
			4cyl.		
			1597cc	65-71kW (88-96PS)	
			CVH		TD1298
Escort III RS 1600i	05/82→12/85	LUAE			
			4cyl.		
			1597cc	85kW (116PS)	
					TD1299
Fiesta II 1.6 XR2	04/84→02/89	LUB (HL16G CVH)			
			4cyl.		
			1597cc	71kW (96PS)	
			CVH		TD1300
Escort '86 Express 1.6	02/86→07/90	LUC (HL16H CVH)			
Orion II 1.6	12/85→07/90		4cyl.		
			1597cc	66kW (89PS)	
			CVH		TD1301
Fiesta II 1.6 XR2	03/84→02/89	LUD (HL16G CVH)			
			4cyl.		
			1597cc	70kW (95PS)	
			CVH		TD1302
Escort IV 1.6	04/89→07/90	LUG (HL16H CVH)			
Orion II 1.6	03/86→08/90		4cyl.		
			1597cc	66kW (89PS)	
			CVH		TD1304





Escort V 1.6, Escort V Estate 1.6 Orion III 1.6		07/90→08/92 07/90→12/92	LUJ (HL16G CVH) 4cyl. 1597cc 66kW (89PS) CVH		001 IF MO P 026 P 712 CR	IKA STD ST	TD1306
Escort V 1.6, Escort V Estate 1.6 Orion III 1.6		07/90→08/92 07/90→12/92	LUK (HL16G CVH) 4cyl. 1597cc 66kW (89PS) CVH		001 IF MO P 026 P 712 CR	IKA STD ST	TD1308
08-214100-00 08-214107-00 08-214109-00 08-214111-00	STD 0.50mm 0.75mm 1.00mm	79.96	1.600 2.000 4.000		001 IF MO P 026 P 712 CR	IKA STD ST	TD1306
<i>[R33716]</i>							
Fiesta III 1.6 Turbo		03/90→10/92	LHA (HL16T CVH) 4cyl. 1597cc 96kW (131PS) Turbo Intercooled		001 MO P 005 P 231 CR P	KV1 GOE12 GOE12	20 TD1273
Escort III 1.6 RS Turbo		11/84→12/85	LNA 4cyl. 1597cc 97kW (132PS) Turbo Intercooled		001 MO P 005 P 231 CR P	KV1 GOE12 GOE12	TD1281
Escort IV 1.6 Turbo RS		01/86→07/90	LNB (HL16T CVH) 4cyl. 1597cc 97kW (132PS) Turbo Intercooled		001 MO P 005 P 231 CR P	KV1 GOE12 GOE12	TD1282
08-529000-00 08-529007-00	STD 0.50mm	79.96	1.500 2.000 4.000		001 MO P 005 P 231 CR P	KV1 GOE12 GOE12	TD1282
<i>[R49310]</i>							
Escort '81 Express 1.6 D Escort '86 Express 1.6 D Escort III 1.6 D, Escort III Estate 1.6 D Orion I 1.6 D		02/84→02/86 02/86→07/90 02/84→12/85 02/84→03/86	LTA (D16) 4cyl. 1608cc 40kW (54PS) Diesel		001 CR P 005 IF P 231 CR P	KV1 STD STD	21 TD1295
Fiesta Box 1.6 D Fiesta II 1.6 D		09/83→09/89 04/84→02/89	LTB (D16) 4cyl. 1608cc 40kW (54PS) Diesel		001 CR P 005 IF P 231 CR P	KV1 STD STD	TD1296
Escort IV 1.6 D, Escort IV Estate 1.6 D Orion II 1.6 D		01/86→01/89 12/85→01/89	LTC (D16) 4cyl. 1608cc 40kW (54PS) Diesel		001 CR P 005 IF P 231 CR P	KV1 STD STD	TD1297
08-215500-10 08-215507-10 08-215511-10	STD 0.50mm 1.00mm	80.00	2.000 2.000 3.000		001 CR P 005 IF P 231 CR P	KV1 STD STD	TD1297
<i>[R40220]</i>							



Escort V 1.8 16V XR3i, Escort V Convertible 1.8 16V XR3i, Escort V Estate 1.8 16V	02/92→12/92	RDA (ZH18N/M/P Zetec E) 4cyl. 1796cc 77kW (105PS)	22
Escort VI 1.8 i 16V Escort VI 1.8 XR3i 16V 4x4 Escort VI Convertible 1.8 16V XR3i Escort VI Estate 1.8 i 16V Escort VI Saloon 1.8 i 16V Escort VII 1.8 16V Escort VII Convertible 1.8 16V XR3i Escort VII Estate 1.8 16V, Escort VII Saloon 1.8 16V Orion III 1.8 i 16V	09/92→01/95 08/93→01/95 12/92→01/95 01/93→01/95 08/93→01/95 01/95→08/95 02/95→08/98 01/95→08/95		TD1419
Fiesta III 1.8 16V	02/92→12/95	RDB (ZH18N/M/P Zetec E) 4cyl. 1796cc 77kW (105PS)	TD1420
Mondeo I 1.8 i 16V, Mondeo I 1.8 i 16V 4x4 Mondeo I Estate 1.8 i 16V, Mondeo I Estate 1.8 i 16V 4x4 Mondeo I Saloon 1.8 4x4, Mondeo I Saloon 1.8 i 16V Ranger 1.8	02/93→08/96 04/93→08/96 02/93→08/96 06/99→02/02	RKA (ZH18N/M/P Zetec E) 4cyl. 1796cc 85kW (116PS)	TD4487
Mondeo I 1.8 i 16V, Mondeo I Estate 1.8 i 16V Mondeo I Saloon 1.8 i 16V Mondeo II 1.8 i, Mondeo II Estate 1.8 i, Mondeo II Saloon 1.8 i	07/94→08/96 01/94→08/96 09/96→11/00	RKB (ZH18N/M/P Zetec E) 4cyl. 1796cc 85kW (116PS)	TD12091
Escort VII 1.8 16V Escort VII Convertible 1.8 16V XR3i Escort VII Estate 1.8 16V, Escort VII Saloon 1.8 16V	01/95→10/98 10/95→08/98 01/95→02/99	RKC (ZH18N/M/P Zetec E) 4cyl. 1796cc 85kW (116PS)	TD5107
Mondeo II 1.8 i, Mondeo II Estate 1.8 i, Mondeo II Saloon 1.8 i	09/96→11/00	RKF (ZH18N/M/P Zetec E) 4cyl. 1796cc 85kW (116PS)	TD12088
Mondeo II 1.8 i, Mondeo II Estate 1.8 i, Mondeo II Saloon 1.8 i	09/96→11/00	RKH (ZH18N/M/P Zetec E) 4cyl. 1796cc 85kW (116PS)	TD15991
Mondeo II 1.8 i, Mondeo II Estate 1.8 i, Mondeo II Saloon 1.8 i	09/96→11/00	RKJ (ZH18N/M/P Zetec E) 4cyl. 1796cc 85kW (116PS)	TD12089
Mondeo II 1.8 i, Mondeo II Estate 1.8 i, Mondeo II Saloon 1.8 i	09/96→11/00	RKK (ZH18N/M/P Zetec E) 4cyl. 1796cc 85kW (116PS)	TD16011
Escort V 1.8 16V XR3i, Escort V Convertible 1.8 16V XR3i Escort VI 1.8 16V XR3i Escort VI 1.8 XR3i 16V 4x4 Escort VI Convertible 1.8 16V XR3i Escort VI Estate 1.8 i 16V Escort VII Convertible 1.8 16V XR3i Orion III 1.8 i 16V	02/92→12/92 09/92→01/95 08/93→01/95 12/92→01/95 02/93→01/95 02/95→08/00 01/92→12/93	RQB (ZH18N/M/P Zetec E) 4cyl. 1796cc 96kW (131PS)	TD1431





Fiesta III 1.8 XR2i 16V	02/92→12/95	RQC (ZH18N/M/P Zetec E)	4cyl. 1796cc 96kW (131PS)	TD1432
--------------------------------	-------------	--------------------------------	-------------------------------------	---------------

08-107300-00 STD 08-107307-00 0.50mm 08/1995→04/1998 [R49790]	80.60	1.200 1.600 2.500	001 NT 026 P 236 P	ST STD STD
08-136600-00 STD 08-136607-00 0.50mm 05/1998→ [R66680]	80.60	1.200 1.500 2.500	001 NT 026 P 712 CR	ST STD ST
08-786000-00 ¹ STD 08-786007-00 0.50mm [R46080]	80.60	1.500 1.600 3.000	001 CR P 026 P 236 P	IKA STD STD
08-786500-00 STD 08-786507-00 0.50mm 01/1993→08/1995 [R46070]	80.60	1.500 1.600 2.500	001 MOL P 026 P 236 P	KV1 STD STD
¹ Suitable for early engines with 3mm wide oil control ring	¹ Verwendbar für frühe Maschinen mit 3mm breitem Ölsteuerring	¹ Approprié à de premiers moteurs avec l'anneau de commande d'huile de 3mm	¹ Conveniente para los motores tempranos con el anillo de control de aceite de 3mm	

Capri 1600, Capri 1600 GT Cortina 1600	01/68→12/72 01/71→12/75	711M updated	4cyl. 1599cc	23 FM2350
---	----------------------------	---------------------	------------------------	----------------------------

Escort I 1100 Escort I Estate 1100 Escort II 1.1 Escort II Estate 1.1	01/68→12/74 06/70→02/76 12/74→08/80 04/75→08/80	G1	4cyl. 1098cc 32kW (44PS)	TD4454
--	--	-----------	------------------------------------	---------------

Escort I 1100, Escort I Estate 1100 Escort II 1.1 Escort II Estate 1.1	06/70→02/76 12/74→08/80 04/75→08/80	G2	4cyl. 1098cc 35kW (47PS)	TD1191
---	---	-----------	------------------------------------	---------------

Capri II 1.3 Capri III 1.3	02/74→08/77 01/78→06/85	J1E	4cyl. 1298cc 40kW (54PS)	TD1216
---	----------------------------	------------	------------------------------------	---------------

Escort I 1300 Escort II 1.3	09/73→02/76 12/74→08/80	J1F	4cyl. 1298cc 40kW (54PS)	TD4457
--	----------------------------	------------	------------------------------------	---------------

Escort I 1300, Escort I Estate 1300 Escort II 1.3 Escort II Estate 1.3	06/70→02/76 12/74→08/80 04/75→08/80	J2	4cyl. 1298cc 44kW (60PS)	TD1217
---	---	-----------	------------------------------------	---------------

Escort I 1300	06/70→02/76	J3D	4cyl. 1298cc 52-54kW (71-73PS)	TD5480
----------------------	-------------	------------	--	---------------





Fiesta I 1.3	08/77→08/83	J3E	4cyl. 1298cc	49kW (67PS)	TD1221
Capri 1300	01/69→12/70	KL 13 H (Uprated 711M)	4cyl. 1298cc	40-48kW (54-65PS)	TD22533
Cortina 1300, Cortina Coupe 1300, Cortina Estate 1300	10/66→03/72				
Escort I 1300 GT	06/68→06/71				
Escort II Estate 1.3	04/75→01/79				
Capri 1300	01/72→12/72	KL 13 HC (Uprated 711M)	4cyl. 1298cc	53kW (72PS)	TD22534
Capri 1300	01/69→12/73	KL 13 L	4cyl. 1298cc	37-41kW (50-56PS)	TD22535
Cortina 1300, Cortina Coupe 1300, Cortina Estate 1300	10/66→03/72				
Taunus 12M 1.3	08/66→06/71				
		KL 16 G (751M)	4cyl. 1599cc CVH	65-71kW (88-96PS)	TD1396
Cortina 1600, Cortina Coupe 1600, Cortina Estate 1600	10/67→12/69	KL 16 L (751M)	4cyl. 1599cc	47kW (64PS)	TD22536
Escort I Mexico	01/70→10/75	KL 16 R	4cyl. 1599cc	63kW (86PS)	TD22537
Escort Mk I	01/68→12/74	KL09H (711M)	4cyl. 940cc	26kW (35PS)	FM655
Escort I 1100, Escort I Estate 1100	06/68→06/71	KL11	4cyl. 1098cc	29kW (39PS)	TD22407
Escort II 1.3	12/74→08/80	KL13L (J3)	4cyl. 1298cc	51kW (69PS)	TD1219
Fiesta I 1.6 XR2	08/81→08/83	L3E (KL16G - 751M)	4cyl. 1599cc	62kW (84PS)	TD1251





Escort II 1.6 RS			12/74→08/80	LC (KL16G - 751M)	4cyl. 1599cc	62kW (84PS)	TD1261	
08-207400-00	STD	80.98	1.600		001 IF CR P		IKA	
			2.000		026 P		STD	
			3.947		712 CR		ST	
08-780600-10	STD	80.98	1.600		001 CR P		STD	
08-780607-10	.020			2.000		023 P	STD	
08-780609-10	.030			3.947		231 P	STD	
08-780611-10	.040							
08-780614-10	.060							
08-780617-10	.090							
<i>[R25106]</i>								
Galaxy 2.8 i V6			11/95→04/00	AAA	V6cyl. 2792cc	128kW (174PS)	24 TD5106	
Galaxy 2.8 i V6 4x4			04/96→04/00					
Galaxy 2.8 i V6			11/95→04/00	AMY	V6cyl. 2792cc	128kW (174PS)	TD17559	
Galaxy 2.8 i V6 4x4			04/96→04/00					
Galaxy 2.8 V6			04/00→05/06	AYL	V6cyl. 2792cc	150kW (204PS)	TD14919	
08-501900-00	STD	81.00	1.500		001 P PS		KV1	
08-501907-00	0.50mm			1.750		026 P		STD
				3.000		231 CR P		STD
<i>[R60300]</i>								
Sierra Estate 1.6, Sierra Hatchback 1.6			08/82→12/86	LCS	4cyl. 1593cc	55kW (75PS)	25 TD1268	
Sierra Estate 1.6, Sierra Hatchback 1.6			08/82→12/86	LCT	4cyl. 1593cc	55kW (75PS)	TD1269	
Sierra Estate 1.6, Sierra Hatchback 1.6			08/82→12/86	LSD (TL16E E-MAX)	4cyl. 1593cc	55kW (75PS)	TD1291	
Sierra 1.6, Sierra Estate 1.6, Sierra Hatchback 1.6			01/87→02/93	LSE (TL16E E-MAX)	4cyl. 1593cc	55kW (75PS)	TD1293	
08-784600-00	STD	81.30	1.600		001 IF MO P		IKA	
08-784607-00	0.50mm			2.000		005 IF P		STD
08-784611-00	1.00mm			4.000		712 CR		ST
<i>[R39930]</i>								



Focus 1.8 DI / TDDi, Focus Estate 1.8 DI / TDDi Focus Saloon 1.8 Turbo DI / TDDi	08/99→11/04 08/01→03/05	BHDA (Endura DI) 4cyl. 1753cc 55kW (75PS) Diesel Turbo Intercooled	26 TD15903
Focus 1.8 DI / TDDi, Focus Estate 1.8 DI / TDDi Focus Saloon 1.8 Turbo DI / TDDi	08/99→11/04 08/01→03/05	BHDB (Endura DI) 4cyl. 1753cc 55kW (75PS) Diesel Turbo Intercooled	TD15904
Focus 1.8 Turbo DI / TDDi Focus Estate 1.8 Turbo DI / TDDi, Focus Saloon 1.8 Turbo DI / TDDi	10/98→11/04 02/99→11/04	C9DA (Endura DI) 4cyl. 1753cc 66kW (89PS) Diesel Turbo Intercooled	TD15905
Focus 1.8 Turbo DI / TDDi Focus Estate 1.8 Turbo DI / TDDi, Focus Saloon 1.8 Turbo DI / TDDi	10/98→11/04 02/99→11/04	C9DB (Endura DI) 4cyl. 1753cc 66kW (89PS) Diesel Turbo Intercooled	TD15906
Focus 1.8 Turbo DI / TDDi Focus Estate 1.8 Turbo DI / TDDi, Focus Saloon 1.8 Turbo DI / TDDi	10/98→11/04 02/99→11/04	C9DC (Endura DI) 4cyl. 1753cc 66kW (89PS) Diesel Turbo Intercooled	TD12081
Focus 1.8 TDCi, Focus Estate 1.8 TDCi, Focus Saloon 1.8 TDCi	03/01→11/04	F9DA (Duratorq) 4cyl. 1753cc 74kW (100PS) Diesel Turbo Intercooled	TD17524
Focus 1.8 TDCi, Focus Estate 1.8 TDCi, Focus Saloon 1.8 TDCi	03/01→11/04	F9DB (Duratorq) 4cyl. 1753cc 85kW (116PS) Diesel Turbo Intercooled	TD17526
Focus 1.8 TDCi, Focus Estate 1.8 TDCi, Focus Saloon 1.8 TDCi	08/02→11/04	FFDA (Duratorq) 4cyl. 1753cc 85kW (116PS) Diesel Turbo Intercooled	TD17521
C-Max 1.8 TDCi Focus C-MAX 1.8 TDCi Focus II 1.8 TDCi Focus II Estate 1.8 TDCi Focus II Saloon 1.8 TDCi	02/07→ 01/05→03/07 01/05→ 11/04→ 04/05→	KKDA Euro 4 4cyl. 1753cc 85kW (116PS) Diesel Turbo Intercooled	TD18480
Focus II 1.8 TDCi Focus II Estate 1.8 TDCi Focus II Saloon 1.8 TDCi	01/05→ 11/04→ 04/05→	KKDB Euro 4 4cyl. 1753cc 85kW (116PS) Diesel Turbo Intercooled	TD23303

08-107000-00 STD	82.50	2.500		007 CK P	KV1
08-107007-00 0.50mm		2.000		026 P	STD
08-107011-00 1.00mm		3.000		231 CR P	STD
[R60080]					

Tourneo Connect 1.8 Di, Transit Connect 1.8 Di	06/07→	BHPA (Endura DI) 4cyl. 1753cc 55kW (75PS) Diesel Turbo Intercooled	27 TD20062
Mondeo IV 1.8 TDCi, Mondeo IV Saloon 1.8 TDCi, Mondeo IV Turnier 1.8 TDCi	03/07→	FFBA 4cyl. 1753cc 74kW (100PS) Diesel Turbo Intercooled	TD23304





Galaxy 1.8 TDCi S-Max 1.8 TDCi	05/06→ 01/07→	FFWA	4cyl. 1753cc	74kW (100PS)	Diesel Turbo	TD20047
Tourneo Connect 1.8 Turbo Di, Transit Connect 1.8 TDCi	06/07→	HCPA (Duratorq)	4cyl. 1753cc	66kW (89PS)	Diesel Turbo Intercooled	TD18779
Tourneo Connect 1.8 Turbo Di, Transit Connect 1.8 TDCi	06/07→	HCPB (Duratorq)	4cyl. 1753cc	66kW (89PS)	Diesel Turbo Intercooled	TD18780
Mondeo IV 1.8 TDCi, Mondeo IV Saloon 1.8 TDCi, Mondeo IV Turnier 1.8 TDCi	06/07→	KHBA (Duratorq TDCI)	4cyl. 1753cc	92kW (125PS)	Diesel Turbo Intercooled	TD23372
Tourneo Connect 1.8 Di, Transit Connect 1.8 Di	06/07→	P7PA (Duratorq TDCI)	4cyl. 1753cc	55kW (75PS)	Diesel Turbo Intercooled	TD24465
Tourneo Connect 1.8 Di, Transit Connect 1.8 Di	06/07→	P7PB (Duratorq TDCI)	4cyl. 1753cc	55kW (75PS)	Diesel Turbo Intercooled	TD24466
Tourneo Connect 1.8 Turbo Di, Transit Connect 1.8 TDCi	06/07→	P9PA (Duratorq TDCI)	4cyl. 1753cc	66kW (89PS)	Diesel Turbo Intercooled	TD25795
Tourneo Connect 1.8 Turbo Di, Transit Connect 1.8 TDCi	06/07→	P9PB (Duratorq TDCI)	4cyl. 1753cc	66kW (89PS)	Diesel Turbo Intercooled	TD25796
Tourneo Connect 1.8 Turbo Di, Transit Connect 1.8 TDCi	06/07→	P9PC (Duratorq TDCI)	4cyl. 1753cc	66kW (89PS)	Diesel Turbo Intercooled	TD25797
Tourneo Connect 1.8 Turbo Di, Transit Connect 1.8 TDCi	06/07→	P9PD (Duratorq TDCI)	4cyl. 1753cc	66kW (89PS)	Diesel Turbo Intercooled	TD25798
Mondeo IV 1.8 TDCi, Mondeo IV Saloon 1.8 TDCi, Mondeo IV Turnier 1.8 TDCi	06/07→	QYBA (Duratorq TDCI)	4cyl. 1753cc	92kW (125PS)	Diesel Turbo Intercooled	TD23371
Galaxy 1.8 TDCi, S-Max 1.8 TDCi	05/06→	QYWA	4cyl. 1753cc	92kW (125PS)	Diesel Turbo Intercooled	TD19112
Tourneo Connect 1.8 Di, Transit Connect 1.8 Di	06/07→	R2PA (Duratorq TDCI)	4cyl. 1753cc	55kW (75PS)	Diesel Turbo Intercooled	TD24467
Tourneo Connect 1.8 Turbo Di, Transit Connect 1.8 TDCi	06/07→	R3PA (Duratorq TDCI)	4cyl. 1753cc	66kW (89PS)	Diesel Turbo Intercooled	TD25799







Touneo Connect 1.8 TDCi, Transit Connect 1.8 TDCi		08/06→	RWPA (Duratorq)			
			4cyl.			
			1753cc	81kW (110PS)		
			Diesel	Turbo Intercooled		TD20063
Touneo Connect 1.8 TDCi, Transit Connect 1.8 TDCi		08/06→	RWPC (Duratorq TDCI)			
			4cyl.			
			1753cc	81kW (110PS)		
			Diesel	Turbo Intercooled		TD25793
Touneo Connect 1.8 TDCi, Transit Connect 1.8 TDCi		08/06→	RWPD (Duratorq TDCI)			
			4cyl.			
			1753cc	81kW (110PS)		
			Diesel	Turbo Intercooled		TD25794
Touneo Connect 1.8 Turbo Di, Transit Connect 1.8 TDCi		06/07→	RWPE (Duratorq TDCI)			
			4cyl.			
			1753cc	66kW (89PS)		
			Diesel	Turbo Intercooled		TD25800
Touneo Connect 1.8 Turbo Di, Transit Connect 1.8 TDCi		06/07→	RWPF (Duratorq TDCI)			
			4cyl.			
			1753cc	66kW (89PS)		
			Diesel	Turbo Intercooled		TD25801
08-437000-00	STD	82.50	1.750		001 IF NT	ST
08-437007-00	0.50mm		2.000		026 IFU P	F12/F14
01/2007→			2.000		231 NT	ST
P 100 II 1.8 TD		10/87→12/92	RFA (D18T)			28
Sierra 1.8 TD, Sierra Estate 1.8 TD, Sierra Hatchback 1.8 TD		08/88→02/93	4cyl.			
			1753cc	55kW (75PS)		
			Diesel	Turbo		TD1426
Sierra 1.8 TD, Sierra Estate 1.8 TD, Sierra Hatchback 1.8 TD		08/88→02/93	RFB (D18T)			
			4cyl.			
			1753cc	55kW (75PS)		
			Diesel	Turbo		TD1427
Escort '95 Box 1.8 TD		01/95→	RFD			
Escort Classic 1.8 TD		10/98→07/00	4cyl.			
Escort Classic Turnier 1.8 TD		02/99→07/00	1753cc	66kW (89PS)		
Escort VI 1.8 TD, Escort VI Estate 1.8 TD		02/93→01/95	Diesel	Turbo Intercooled		
Escort VI Saloon 1.8 TD		08/93→01/95				
Escort VII 1.8 TD		01/95→10/98				
Escort VII Convertible 1.8 TD		09/95→08/98				
Escort VII Estate 1.8 TD,		01/95→02/99				
Escort VII Saloon 1.8 TD						
Orion III 1.8 TD		03/92→12/93				TD4484
Escort '95 Box 1.8 TD		01/95→	RFK			
Escort Classic 1.8 TD		10/98→07/00	4cyl.			
Escort Classic Turnier 1.8 TD		02/99→07/00	1753cc	66kW (89PS)		
Escort VI 1.8 TD, Escort VI Estate 1.8 TD		02/93→01/95	Diesel	Turbo Intercooled		
Escort VI Saloon 1.8 TD		08/93→01/95				
Escort VII 1.8 TD		01/95→10/98				
Escort VII Convertible 1.8 TD		09/95→08/98				
Escort VII Estate 1.8 TD,		01/95→02/99				
Escort VII Saloon 1.8 TD						
Orion III 1.8 TD		03/92→12/93				TD4485
Fiesta III 1.8 TD		03/93→12/95	RFL (D18T)			
Sierra 1.8 TD, Sierra Estate 1.8 TD, Sierra Hatchback 1.8 TD		08/88→02/93	4cyl.			
			1753cc	55kW (75PS)		
			Diesel	Turbo		TD4486





Mondeo I 1.8 TD, Mondeo I Estate 1.8 TD, Mondeo I Saloon 1.8 TD	06/93→08/96				RFM	4cyl. 1753cc 65kW (88PS)		
					Diesel	Turbo Intercooled		TD1428
Mondeo I 1.8 TD, Mondeo I Estate 1.8 TD, Mondeo I Saloon 1.8 TD	06/93→08/96				RFN	4cyl. 1753cc 65kW (88PS)		
Mondeo II 1.8 TD, Mondeo II Estate 1.8 TD, Mondeo II Saloon 1.8 TD	09/96→11/00				Diesel	Turbo Intercooled		TD1429
Escort '95 Box 1.8 TD Escort VI 1.8 TD	01/95→ 02/93→01/95				RFS (D18TI/Endura DE)	4cyl. 1753cc 66kW (89PS)		
					Diesel	Turbo Intercooled		TD16143
					RFU	4cyl. 1753cc 57kW (77PS)		
					Diesel	Turbo		TD23181
Escort '95 Box 1.8 Turbo D Escort VII 1.8 Turbo D Escort VII Convertible 1.8 Turbo D Escort VII Estate 1.8 Turbo D, Escort VII Saloon 1.8 Turbo D	12/95→06/01 12/95→10/98 10/96→08/99 12/95→02/99				RVA (D18TC)	4cyl. 1753cc 51kW (69PS)		
					Diesel	Turbo		TD5104
08-785200-00 08-785207-00	STD 0.50mm	82.50	2.500		008 IF CR P			KV1
			2.000		005 P			GOE13
[R46090]			3.000		231 CR P			STD
Escort '86 Express 1.8 D Escort IV 1.8 D, Escort IV Estate 1.8 D, Orion II 1.8 D	07/88→07/90 01/89→07/90				RTA (D18NA)	4cyl. 1753cc 44kW (60PS)		29
					Diesel			TD1434
Escort '86 Express 1.8 D Escort IV 1.8 D, Escort IV Estate 1.8 D, Orion II 1.8 D	07/88→07/90 01/89→07/90				RTB (D18NA)	4cyl. 1753cc 44kW (60PS)		
					Diesel			TD1435
Fiesta Box 1.8 D Fiesta III 1.8 D	03/89→02/96 03/89→12/95				RTC (D18NA)	4cyl. 1753cc 44kW (60PS)		
					Diesel			TD4489
Fiesta Box 1.8 D Fiesta III 1.8 D	03/89→02/96 03/89→12/95				RTD (D18NA)	4cyl. 1753cc 44kW (60PS)		
					Diesel			TD1437
Escort V 1.8 D, Escort V Estate 1.8 D Escort VI 1.8 D Escort VI Saloon 1.8 D Escort VII 1.8 D Escort VII Estate 1.8 D Escort VII Saloon 1.8 D Orion III 1.8 D	07/90→12/92 09/92→01/95 08/93→01/95 01/95→12/96 01/95→02/99 01/95→12/96 11/90→12/93				RTE (D18NA)	4cyl. 1753cc 44kW (60PS)		
					Diesel			TD1438





Escort '95 Box 1.8 D	01/95→				RTF (D18NA)		
Escort V 1.8 D, Escort V Estate 1.8 D	07/90→12/92				4cyl.		
Escort VI 1.8 D	09/92→01/95				1753cc	44kW (60PS)	
Escort VI Saloon 1.8 D	08/93→01/95				Diesel		
Escort VII 1.8 D	01/95→12/96						
Escort VII Estate 1.8 D	01/95→02/99						
Escort VII Saloon 1.8 D	01/95→12/96						
Orion III 1.8 D	11/90→12/93						TD1439
Fiesta Box 1.8 D	03/89→02/96				RTG (D18NA)		
Fiesta III 1.8 D	03/89→12/95				4cyl.		
					1753cc	44kW (60PS)	
					Diesel		TD1440
Escort '91 Express 1.8 D	07/90→12/94				RTH (D18NA)		
Escort '95 Box 1.8 D	01/95→				4cyl.		
Escort V 1.8 D, Escort V Estate 1.8 D	07/90→12/92				1753cc	44kW (60PS)	
Escort VI 1.8 D, Escort VI Estate 1.8 D	09/92→01/95				Diesel		
Escort VI Saloon 1.8 D	08/93→01/95						
Escort VII 1.8 D	01/95→12/96						
Escort VII Estate 1.8 D	01/95→02/99						
Escort VII Saloon 1.8 D	01/95→12/96						
Orion III 1.8 D	11/90→12/93						TD1441
Fiesta Box D 1.8	05/98→				RTJ (D18NA/Endura DE)		
Fiesta IV 1.8 D	08/95→04/00				4cyl.		
					1753cc	44kW (60PS)	
					Diesel		TD10068
Courier Pickup 1.8 D	06/99→02/02				RTK (D18NA/Endura DE)		
Fiesta Box 1.8 D	02/96→				4cyl.		
Fiesta Box D 1.8	05/98→				1753cc	44kW (60PS)	
Fiesta IV 1.8 D	08/95→04/00				Diesel		TD10067
08-783500-00	STD	82.50	2.000		001 CR P		KV1
08-783507-00	0.50mm		2.000		005 P		STD
08-783511-00	1.00mm		3.000		231 CR P		STD
[R43390]							
Mondeo III 1.8 16V, Mondeo III Estate 1.8 16V, Mondeo III Saloon 1.8 16V	11/00→08/07				CGBA (Duratec HE)		30
					4cyl.		
					1796cc	81kW (110PS)	TD15907
Mondeo III 1.8 16V, Mondeo III Estate 1.8 16V, Mondeo III Saloon 1.8 16V	11/00→08/07				CGBB (Duratec HE)		
					4cyl.		
					1796cc	81kW (110PS)	TD15908
Mondeo III 1.8 16V, Mondeo III Estate 1.8 16V, Mondeo III Saloon 1.8 16V	11/00→08/07				CHBA		
					4cyl.		
					1796cc	85-92kW (115-125PS)	TD15909
Mondeo III 1.8 16V, Mondeo III Estate 1.8 16V, Mondeo III Saloon 1.8 16V	11/00→08/07				CHBB		
					4cyl.		
					1796cc	85-92kW (115-125PS)	TD15910
Focus C-MAX 1.8	10/03→03/07				CSDA (Duratec HE)		
					4cyl.		
					1798cc	88kW (120PS)	TD18975





Focus C-MAX 1.8		10/03→03/07	CSDB (Duratec HE)	4cyl. 1798cc	88kW (120PS)	TD18976
C-Max 1.8 Flexifuel		02/07→	Q7DA (Duratec HE)	4cyl.		
Focus C-MAX 1.8		04/04→03/07		4cyl.		
Focus C-MAX 1.8 Flexifuel		01/06→03/07		1798cc	92kW (125PS)	
Focus II 1.8 Flexifuel		01/06→				
Focus II Estate 1.8		03/06→				
Focus II Estate 1.8 Flexifuel		01/06→				
Focus II Saloon 1.8 Flexifuel		06/06→				TD18974
C-Max 1.8		02/07→	QQDA (Duratec HE)	4cyl.		
Focus C-MAX 1.8		04/04→03/07		4cyl.		
				1798cc	92kW (125PS)	TD18788
C-Max 1.8		02/07→	QQDB (Duratec HE)	4cyl.		
Focus C-MAX 1.8		04/04→03/07		4cyl.		
Focus II 1.8, Focus II Estate 1.8,		03/06→		1798cc	92kW (125PS)	
Focus II Saloon 1.8						TD18787
08-429400-00	STD	83.00	1.200		001 NT	ST
08-429407-00	0.50mm		1.200		026 P	STD
			2.500		712 NT	ST
<hr/>						
Scorpio I 2.4 i		09/86→09/88	ARC	V6cyl. 2394cc	96kW (131PS)	31 TD1144
Scorpio I 2.4 i		10/88→02/92	ARD	V6cyl.		
Scorpio I 2.4 i CAT		10/88→09/94		V6cyl.		
Scorpio I Estate 2.4 i		09/91→09/94		2394cc	92kW (125PS)	
Scorpio I Saloon 2.4 i		10/88→10/94				TD1145
Granada 2.4 EFi Ghia,		01/87→08/89	TV24	V6cyl.		
Granada 2.4 EFi Ghia X,				2394cc		
Granada 2.4 EFi GL						
Scorpio 2.4 EFi		01/86→12/94				FM5486
08-782400-00	STD	84.00	1.600		001 IF MO P	IKA
[R67480]			1.750		026 P	STD
			3.500		712 CR	ST
<hr/>						
Capri		01/69→12/81	EV20H	V6cyl.		32
Consul		01/72→12/75		V6cyl.		
Cortina 2000 Ghia, Cortina 2000 GL,		01/81→		1995cc	62kW (84PS)	
Cortina 2000 L						
Granada 2000 Ghia, Granada 2000 GL,		01/75→12/85				
Granada 2000 L						
Sierra 2.0 V6		01/82→12/85				
Taurus 2000 Ghia, Taurus 2000 GL,		01/69→12/82				
Taurus 2000 L						FM3203
Taurus '80 Turnier 2.0, Taurus '80 2.0		07/79→07/82	NWR	V6cyl.		
				1999cc	66kW (89PS)	
						TD1374





Capri 2000		02/69→02/74	NY				
Granada 2.0, Granada Estate 2.0		01/75→08/77		V6cyl.	1999cc	66kW (89PS)	TD4479
Granada 2.0		08/77→08/85	NYP				
Granada Estate 2.0		08/77→06/85		V6cyl.	1999cc	66kW (89PS)	TD4480
Taurus 2.0, Taurus Turnier 2.0		05/75→07/79	NYR				
				V6cyl.	1999cc	66kW (89PS)	TD1379
Sierra Estate 2.0, Sierra Hatchback 2.0		08/82→10/84	NYT				
				V6cyl.	1999cc	66kW (89PS)	TD1380
08-780200-00 →07/1984	STD	84.00	2.000		001 IF MO P		IKA
			3.000		026 P		STD
			5.000		236 P		STD
Cougar 2.0 16V		08/98→12/01	EDBA (ZH20 Zetec E)				33
				4cyl.	1988cc	96-100kW (131-136PS)	TD12068
Cougar 2.0 16V		08/98→12/01	EDBB (ZH20 Zetec E)				
				4cyl.	1988cc	96-100kW (131-136PS)	TD15916
Cougar 2.0 16V		08/98→12/01	EDBC (ZH20 Zetec E)				
				4cyl.	1988cc	96-100kW (131-136PS)	TD15917
Cougar 2.0 16V		08/98→12/01	EDBD (ZH20 Zetec E)				
				4cyl.	1988cc	96-100kW (131-136PS)	TD15918
Focus 2.0 16V		10/98→11/04	EDDB (ZH20 Zetec E)				
Focus Estate 2.0 16V,		02/99→11/04		4cyl.	1988cc	96kW (131PS)	TD15900
Focus Saloon 2.0 16V							
Focus 2.0 16V		10/98→11/04	EDDC (ZH20 Zetec E)				
Focus Estate 2.0 16V,		02/99→11/04		4cyl.	1988cc	96kW (131PS)	TD12080
Focus Saloon 2.0 16V							
Focus 2.0 16V		10/98→11/04	EDDF (ZH20 Zetec E)				
Focus Estate 2.0 16V,		02/99→11/04		4cyl.	1988cc	96kW (131PS)	TD15902
Focus Saloon 2.0 16V							





Mondeo I 2.0 i 16V	02/93→08/96	NGA (ZH20 Zetec E)	
Mondeo I 2.0 i 16V 4x4	12/94→08/96	4cyl.	
Mondeo I Estate 2.0 i 16V	01/93→08/96	1988cc	100kW (136PS)
Mondeo I Estate 2.0 i 16V 4x4	04/93→08/96		
Mondeo I Saloon 2.0 i 16V,	02/93→08/96		
Mondeo I Saloon 2.0 i 16V 4x4	02/93→08/96		
Mondeo II 2.0 i, Mondeo II Estate 2.0 i,	09/96→11/00		
Mondeo II Saloon 2.0 i		TD4475	

08-107400-00 01/1995→	STD	84.80	1.200		001 NT	ST
			1.500		001 MO P	KV1
			3.000		712 CR	ST
08-786400-00 08-786407-00 [R48110]	STD 0.50mm	84.80	1.500		001 CR P	IKA
			1.750		026 P	STD
			3.000		712 CR	ST

C-Max 2.0 TDCi	02/07→	G6DA		34
Focus C-MAX 2.0 TDCi	10/03→03/07	4cyl.		
Focus II 2.0 TDCi	11/04→	1997cc	100kW (136PS)	
Focus II Convertible 2.0 TDCi	10/06→	Diesel	Turbo Intercooled	
Focus II Estate 2.0 TDCi	11/04→			
Focus II Saloon 2.0 TDCi	04/05→			TD18510

C-Max 2.0 TDCi	02/07→	G6DB		
Focus C-MAX 2.0 TDCi	10/03→03/07	4cyl.		
Focus II 2.0 TDCi	11/04→	1997cc	100kW (136PS)	
Focus II Convertible 2.0 TDCi	10/06→	Diesel	Turbo Intercooled	
Focus II Estate 2.0 TDCi	11/04→			
Focus II Saloon 2.0 TDCi	04/05→			TD18511

C-Max 2.0 TDCi	02/07→	G6DD (Duratorq)		
Focus C-MAX 2.0 TDCi	10/03→03/07	4cyl.		
Focus II 2.0 TDCi	11/04→	1997cc	100kW (136PS)	
Focus II Convertible 2.0 TDCi	10/06→	Diesel	Turbo Intercooled	
Focus II Estate 2.0 TDCi	11/04→			
Focus II Saloon 2.0 TDCi	04/05→			TD18790

08-114700-00 08-114708-00 [R60410]	STD 0.60mm	85.00	3.500		008 CK P	KV1
			2.000		005 IFU P	STD
			3.000		231 CR P	STD

Mondeo IV 2.2 TDCi, Mondeo IV Turnier 2.2 TDCi	07/10→	KNBA (Duratorq TDCI)		35
		4cyl.		
		2179cc	147kW (200PS)	
		Diesel	Turbo Intercooled	TD26808

Mondeo IV 2.2 TDCi	07/10→	KNBB (Duratorq TDCI)		
		4cyl.		
		2179cc	146kW (199PS)	
		Diesel	Turbo Intercooled	TD26809

Galaxy 2.2 TDCi, S-Max 2.2 TDCi	07/10→	KNWA (Duratorq TDCI)		
		4cyl.		
		2179cc	147kW (200PS)	
		Diesel	Turbo Intercooled	TD26488





Galaxy 2.2 TDCi		07/10→	KNWB (Duratorq TDCI)		
			4cyl.		
			2179cc	146kW (199PS)	
			Diesel	Turbo Intercooled	TD26489
08-436700-00	STD	85.00	2.500	 008 GDC P	KV1
			2.000	 005 IFU P	STD
			2.000	 231 LKZ CK	GOE13
			 		
Transit Box 2.0 DI, Transit Bus 2.0 DI, Transit Platform/Chassis 2.0 DI		08/00→05/06	ABFA (Duratorq DI)		36
			4cyl.		
			1998cc	55kW (75PS)	
			Diesel	Turbo	TD15888
Transit Box 2.0 DI, Transit Bus 2.0 DI, Transit Platform/Chassis 2.0 DI		08/00→05/06	D3FA (Duratorq DI)		
			4cyl.		
			1998cc	55kW (75PS)	
			Diesel	Turbo	TD15551
Mondeo III 2.0 16V DI / TDDi / TDCi, Mondeo III Estate 2.0 16V DI / TDDi / TDCi, Mondeo III Saloon 2.0 16V DI / TDDi / TDCi		11/00→08/07	D5BA (Duratorq)		
			4cyl.		
			1998cc	66kW (89PS)	
			Diesel	Turbo Intercooled	TD15914
Mondeo III 2.0 16V TDDi / TDCi, Mondeo III Estate 2.0 16V TDDi / TDCi, Mondeo III Saloon 2.0 16V TDDi / TDCi		11/00→08/07	D6BA (Duratorq)		
			4cyl.		
			1998cc	85kW (116PS)	
			Diesel	Turbo Intercooled	TD15915
Transit Box 2.0 DI, Transit Bus 2.0 DI, Transit Platform/Chassis 2.0 DI		08/00→05/06	F3FA (Duratorq DI)		
			4cyl.		
			1998cc	63kW (86PS)	
			Diesel	Turbo Intercooled	TD18777
Transit Box 2.0 TDCi, Transit Bus 2.0 TDCi, Transit Platform/ Chassis 2.0 TDCi		08/02→05/06	FIFA (Duratorq)		
			4cyl.		
			1998cc	92kW (125PS)	
			Diesel	Turbo Intercooled	TD18839
Mondeo III 2.0 TDCi, Mondeo III Estate 2.0 TDCi, Mondeo III Saloon 2.0 TDCi		10/01→08/07	FMBA (Duratorq)		
			4cyl.		
			1998cc	96kW (131PS)	
			Diesel	Turbo Intercooled	TD18761
Mondeo III 2.0 16V TDDi / TDCi, Mondeo III Estate 2.0 16V TDDi / TDCi, Mondeo III Saloon 2.0 16V TDDi / TDCi		11/00→08/07	HJBA (Duratorq)		
			4cyl.		
			1998cc	85kW (116PS)	
			Diesel	Turbo Intercooled	TD17547
Mondeo III 2.0 16V TDDi / TDCi, Mondeo III Estate 2.0 16V TDDi / TDCi, Mondeo III Saloon 2.0 16V TDDi / TDCi		11/00→08/07	HJBB (Duratorq)		
			4cyl.		
			1998cc	85kW (116PS)	
			Diesel	Turbo Intercooled	TD17548
Mondeo III 2.0 16V TDDi / TDCi, Mondeo III Estate 2.0 16V TDDi / TDCi, Mondeo III Saloon 2.0 16V TDDi / TDCi		11/00→08/07	HJBC (Duratorq)		
			4cyl.		
			1998cc	85kW (116PS)	
			Diesel	Turbo Intercooled	TD17549
Mondeo III 2.0 TDCi, Mondeo III Estate 2.0 TDCi, Mondeo III Saloon 2.0 TDCi		10/01→08/07	N7BA (Duratorq)		
			4cyl.		
			1998cc	96kW (131PS)	
			Diesel	Turbo Intercooled	TD18762





Mondeo III 2.0 16V DI / TDDi / TDCi, Mondeo III Estate 2.0 16V DI / TDDi / TDCi, Mondeo III Saloon 2.0 16V DI / TDDi / TDCi		11/00→08/07	SDBA (Duratorq)		TD18763
			Diesel	Turbo Intercooled	
08-112700-00	STD	86.00	2.500	007 CK P	KV1
08-112707-00	0.50mm		2.000	026 P	STD
[R60440]			3.000	231 NT	STD
08-140700-00 ①	STD	86.00	2.000	001 CK P	
08-140707-00	0.50mm		2.000	026 P	GOE13
[R67400]			3.000	231 NT	ST
08-140800-00 ②	STD	86.00	2.000	001 CK P	KV1
08-140807-00	0.50mm		2.000	026 P	GOE13
[R67410]			2.000	231 NT	ST

① Only fit to pistons equivalent to OE 24811 and 24653
② Only fit to pistons equivalent to OE 24878 and 24879

① Nur gepasst worden zu den Kolben gleichwertig mit OE 24811 u nd 24653
② Nur gepasst worden zu den Kolben gleichwertig mit OE 24878 u nd 24879

① Seulement adapté aux pistons équivalents à OE 24811 et 24653
② Seulement adapté aux pistons équivalents à OE 24878 et 24879

① Cabido solamente a los pistones equivalentes a OE 24811 y 24 653
② Cabido solamente a los pistones equivalentes a OE 24878 y 24 879







Scorpio II 2.0 i 16V, Scorpio II Estate 2.0 i 16V	10/94→08/98	N3A (DH20)	4cyl. 1998cc	100kW (136PS)	37 TD4470
Escort V RS 2000	05/91→12/92	N7A (DH20)	4cyl.		
Escort VI RS 2000	09/92→01/95		1998cc	110kW (150PS)	
Escort VI RS 2000 4x4	08/93→01/95				
Escort VII RS 2000	02/95→02/98				
Escort VII RS 2000 4x4	02/95→10/98				TD1328
Sierra 2.0, Sierra Estate 2.0, Sierra Hatchback 2.0	01/87→02/93	N8C (DL20H)	4cyl. 1998cc	77kW (105PS)	TD1332
Sierra 2.0 4x4, Sierra 2.0 i	01/90→02/93	N9C (DL20)	4cyl.		
Sierra Estate 2.0 4x4, Sierra Estate 2.0 i	05/89→02/93		1998cc	88kW (120PS)	
Sierra Hatchback 2.0 4x4	10/91→03/93		EFi		
Sierra Hatchback 2.0 i	06/89→02/93				TD1337
Scorpio I Estate 2.0 i Scorpio I Saloon 2.0 i	09/91→09/94 02/92→09/94	N9F (DL20)	4cyl. 1998cc	85kW (116PS)	TD1339
Scorpio II 2.0 i, Scorpio II Estate 2.0 i	10/94→08/98	NSD (DL20)	4cyl. 1998cc	85kW (116PS)	TD4476
Galaxy 2.0 i	11/95→05/06	NSE (DL20)	4cyl. 1998cc	85kW (116PS)	TD5109





Galaxy 2.0 i		11/95→05/06	ZVSA (DL20)		4cyl. 1998cc	85kW (116PS)		
					EFi			TD17158
08-784200-00	STD	86.00	1.600		001 IF MO P			IKA
08-784207-00	0.50mm		1.750		026 P			STD
[R47990]			3.000		712 CR			ST
Transit Box 2.2 TDCi, Transit Bus 2.2 TDCi, Transit Platform/ Chassis 2.2 TDCi		04/06→	P8FA		4cyl. 2198cc	63kW (86PS)		38 TD20042
					Diesel	Turbo Intercooled		
Transit Box 2.2 TDCi, Transit Bus 2.2 TDCi, Transit Platform/ Chassis 2.2 TDCi		04/06→	P8FB		4cyl. 2198cc	63kW (86PS)		TD21066
					Diesel	Turbo Intercooled		
Transit Box 2.2 TDCi, Transit Bus 2.2 TDCi, Transit Platform/ Chassis 2.2 TDCi, Transit Tourneo 2.2 TDCi		10/07→	PGFA		4cyl. 2198cc	103kW (140PS)		TD21067
					Diesel	Turbo Intercooled		
Transit Box 2.2 TDCi, Transit Bus 2.2 TDCi, Transit Platform/ Chassis 2.2 TDCi, Transit Tourneo 2.2 TDCi		10/07→	PGFB		4cyl. 2198cc	103kW (140PS)		TD24463
					Diesel	Turbo Intercooled		
Mondeo III 2.2 TDCi, Mondeo III Estate 2.2 TDCi, Mondeo III Saloon 2.2 TDCi		09/04→08/07	QJBA (Duratorq)		4cyl. 2198cc	114kW (155PS)		TD18756
					Diesel	Turbo Intercooled		
Mondeo III 2.2 TDCi, Mondeo III Estate 2.2 TDCi, Mondeo III Saloon 2.2 TDCi		09/04→08/07	QJBB (Duratorq)		4cyl. 2198cc	114kW (155PS)		TD18757
					Diesel	Turbo Intercooled		
Mondeo III 2.2 TDCi, Mondeo III Estate 2.2 TDCi, Mondeo III Saloon 2.2 TDCi		09/04→08/07	QJBC (Duratorq)		4cyl. 2198cc	110kW (150PS)		TD18782
					Diesel	Turbo Intercooled		
Mondeo III 2.2 TDCi, Mondeo III Estate 2.2 TDCi, Mondeo III Saloon 2.2 TDCi		09/04→08/07	QJBD (Duratorq)		4cyl. 2198cc	110kW (150PS)		TD18783
					Diesel	Turbo Intercooled		
Transit Box 2.2 TDCi, Transit Bus 2.2 TDCi, Transit Platform/ Chassis 2.2 TDCi Transit Tourneo 2.2 TDCi		04/06→ 07/06→	QVFA		4cyl. 2198cc	81kW (110PS)		TD20043
					Diesel	Turbo Intercooled		
Transit Box 2.2 TDCi, Transit Bus 2.2 TDCi, Transit Platform/ Chassis 2.2 TDCi Transit Tourneo 2.2 TDCi		04/06→ 07/06→	QWFA		4cyl. 2198cc	96kW (131PS)		TD20044
					Diesel	Turbo Intercooled		
08-427700-00	STD	86.00	2.000		001 IF CK P			KV1
08-427707-00	0.50mm		2.000		026 P			GOE13
			2.000		231 NT			ST



Econovan 2.0 D, Econovan Box 2.0 D		03/86→03/92	RF	4cyl. 1998cc	41kW (55PS)	39
			Diesel			TD1425
08-283600-00	STD	86.00	2.000		001 CR P	KV1
08-283607-00	0.50mm		2.000		005 IW P	STD
08-283611-00	1.00mm		4.000		231 CR P	STD
[R42580]						
Sierra 1.8, Sierra Estate 1.8, Sierra Hatchback 1.8		01/87→05/88	R2A	4cyl. 1796cc	66kW (89PS)	40
						TD4483
Sierra Estate 1.8, Sierra Hatchback 1.8		10/84→12/86	REB	4cyl. 1796cc	66kW (89PS)	40
						TD1421
Scorpio I 1.8		04/85→02/92	REC	4cyl. 1796cc	66kW (89PS)	40
Scorpio I Saloon 1.8		01/86→10/88				TD1422
Sierra 1.8		01/87→09/89	RED	4cyl. 1796cc	66kW (89PS)	40
Sierra Estate 1.8, Sierra Hatchback 1.8		01/87→05/88				TD1423
Sierra 1.8		10/87→09/89	REF	4cyl. 1796cc	66kW (89PS)	40
Sierra Estate 1.8, Sierra Hatchback 1.8		10/87→05/88				TD1424
08-780000-00	STD	86.20	1.600		001 IF MO P	IKA
08-780007-00	0.50mm		2.000		026 P	STD
[R41250]			4.000		712 CR	ST
C-Max 2.0		02/07→	AODA	4cyl. 1999cc	107kW (146PS)	41
Focus C-MAX 2.0		03/04→03/07				TD18506
Focus II 2.0		11/04→				
Focus II Convertible 2.0		10/06→				
Focus II Estate 2.0		11/04→				
Focus II Saloon 2.0		04/05→				
C-Max 2.0		02/07→	AODB	4cyl. 1999cc	107kW (146PS)	41
Focus C-MAX 2.0		03/04→03/07				TD18507
Focus II 2.0		11/04→				
Focus II Convertible 2.0		10/06→				
Focus II Estate 2.0		11/04→				
Focus II Saloon 2.0		04/05→				
Galaxy 2.0, S-Max 2.0		05/06→	AOWA	4cyl. 1999cc	107kW (146PS)	41
						TD20039
Mondeo III 2.0 16V, Mondeo III Estate 2.0 16V, Mondeo III Saloon 2.0 16V		11/00→08/07	CJBA (Duratec HE)	4cyl. 1999cc	107kW (146PS)	41
						TD15911





Mondeo III 2.0 16V, Mondeo III Estate 2.0 16V, Mondeo III Saloon 2.0 16V		11/00→08/07	CJBB (Duratec HE)	4cyl. 1999cc	107kW (146PS)	TD15912
Maverick 2.3 16V		03/04→	GZ	4cyl. 2261cc	108kW (147PS)	TD20057
Fiesta V ST150		03/05→	N4JB (Duratec ST)	4cyl. 1999cc	110kW (150PS)	TD18781
08-423400-00	STD	87.50	1.200		001 CR P	ST
08-423407-00	0.50mm		1.200		026 P	STD
			2.500		712 CR	ST
Transit Box 1.6 Transit Bus 1.6		11/77→10/86 12/77→10/86	4RB	4cyl. 1593cc	46kW (63PS)	42 TD9440
Transit Platform/Chassis 1.6		11/77→10/86	B	4cyl. 1593cc	46kW (63PS)	TD4439
Taurus '80 Turnier 1.6, Taurus '80 1.6		07/79→07/82	LAR	4cyl. 1593cc	51kW (69PS)	TD11328
Capri II 1.6		02/74→12/77	LCE	4cyl. 1593cc	53kW (72PS)	TD1263
Cortina 1600 GT, Cortina Coupe 1600 GT Taurus '80 Turnier 1.6 Taurus 1.6 Taurus 1600 Taurus '80 1.6 Taurus Turnier 1.6		10/70→03/72 07/79→07/82 05/75→07/79 01/70→02/76 07/79→07/82 05/75→07/79	LCJ	4cyl. 1593cc	53-54kW (72-73PS)	TD1264
Granada 1.6		07/81→08/85	LCK	4cyl. 1593cc	55kW (75PS)	TD1265
Capri III 1.6		01/78→04/87	LCN	4cyl. 1593cc	54kW (73PS)	TD1266
Capri II 1.6		02/74→12/77	LEC	4cyl. 1593cc	65kW (88PS)	TD11229





Sierra 1.6			01/84→02/93	TL 16 L	4cyl. 1593cc	50kW (68PS)	TD1389
08-205800-00	STD	87.65	2.000		001 IW CR P		IKA
08-205807-00 →08/1982	0.50mm		2.500		026 P		STD
[R25286]			4.000		712 CR		ST
08-780500-00 08/1982→	STD	87.65	1.600		001 IF MO P		IKA
			2.000		026 P		STD
			4.000		712 CR		ST
Transit Box 1.6			09/85→09/92	LAT	4cyl. 1594cc	46-48kW (63-65PS)	43 TD17086
Transit Bus 1.6			12/85→01/89				
P 100 I 1.6			04/82→09/87	LCR	4cyl. 1594cc	54kW (73PS)	TD1267
08-780500-00	STD	87.65	1.600		001 IF MO P		IKA
			2.000		026 P		STD
			4.000		712 CR		ST
Granada 1.9 D, Granada 1.9 D GL, Granada 1.9 D L, Granada 1.9 D Turnier			01/77→12/82	XD88, XDP88	4cyl. 1948cc		44 FM1421
				Diesel			
08-313800-10	STD	88.00	2.000		001 IW CR P		KV1
[R66050]			2.000		005 P		STD
			2.000		026 P		STD
			4.500		231 CR P		STD
Transit Box 2.3			03/01→03/06	E5FA	4cyl. 2295cc	107kW (146PS)	45 TD16167
Transit Box 2.3 16V [RWD]			04/01→05/06				
Transit Bus 2.3			08/00→03/06				
Transit Bus 2.3 16V [RWD]			08/00→05/06				
Transit Platform/Chassis 2.3 16V			04/01→05/06				
Transit Box 2.3			03/01→03/06	E5FC	4cyl. 2295cc	103kW (140PS)	TD20058
Transit Box 2.3 16V [RWD]			04/01→05/06				
Transit Bus 2.3 16V [RWD]			08/00→05/06				
Transit Platform/Chassis 2.3 16V			04/01→05/06				
Scorpio II 2.3 i 16V, Scorpio II Estate 2.3 i 16V			06/96→08/98	Y5A	4cyl. 2295cc	108kW (147PS)	TD12092





Galaxy 2.3 16V		01/97→05/06	Y5B		4cyl. 2295cc	107kW (146PS)	TD5497
08-107600-00	STD	89.60	1.600		001 P PS		KV1
08-107607-00	0.50mm		1.500		026 P		STD
[R49820]			2.500		712 CR		ST
Transit Box 2.4 DI, Transit Bus 2.4 DI, Transit Platform/Chassis 2.4 DI		01/00→05/06	D2FA (Duratorq DI)		4cyl. 2402cc	66kW (89PS)	46 TD15549
					Diesel	Turbo Intercooled	
Transit Box 2.4 DI, Transit Bus 2.4 DI, Transit Platform/Chassis 2.4 DI		01/00→05/06	D2FB (Duratorq DI)		4cyl. 2402cc	66kW (89PS)	TD20037
					Diesel	Turbo Intercooled	
Transit Box 2.4 DI, Transit Bus 2.4 DI Transit Bus 2.4 TDDi Transit Platform/Chassis 2.4 DI		01/00→05/06 10/01→03/06 01/00→05/06	D2FE (Duratorq DI)		4cyl. 2402cc	66kW (89PS)	TD15552
					Diesel	Turbo Intercooled	
Transit Box 2.4 DI [RWD] Transit Box 2.4 TDDi Transit Bus 2.4 DI [RWD], Transit Platform/Chassis 2.4 DI Transit Platform/Chassis 2.4 TDDi		01/00→05/06 08/00→08/03 01/00→05/06 08/00→08/03	D4FA (Duratorq DI)		4cyl. 2402cc	88kW (120PS)	TD15550
					Diesel	Turbo Intercooled	
Transit TDi		09/99→	DT24H Duratorq		4cyl. 2402cc	88kW (120PS)	FM5710
					Diesel	Turbo Intercooled	
Transit TD		09/99→	DT24N Duratorq		4cyl. 2402cc	55kW (75PS)	FM5702
					Diesel	Turbo	
Transit TDi		09/99→	DT24P Duratorq		4cyl. 2402cc	66kW (89PS)	FM5709
					Diesel	Turbo Intercooled	
Transit Box 2.4 DI [RWD] Transit Box 2.4 TD Transit Bus 2.4 DI [RWD], Transit Platform/Chassis 2.4 DI		01/00→05/06 08/00→08/03 01/00→05/06	F4FA (Duratorq DI)		4cyl. 2402cc	55kW (75PS)	TD15548
					Diesel	Turbo Intercooled	
Transit Box 2.4 TDE, Transit Bus 2.4 TDE, Transit Platform/Chassis 2.4 TDE		03/04→05/06	FXFA (Duratorq DI)		4cyl. 2402cc	85kW (116PS)	TD18798
					Diesel	Turbo Intercooled	
08-113500-00	STD	89.90	2.500		007 CK P		KV1
08-113507-00	0.50mm		2.000		005 IF P		STD
08-113511-00	1.00mm		3.000		231 CR P		STD
[R60090]							



Transit Box 2.4 TDE, Transit Bus 2.4 TDE, Transit Platform/Chassis 2.4 TDE		07/01→05/06	DOFA (Duratorq DI)		47	
			4cyl. 2402cc 92kW (125PS)	Diesel Turbo Intercooled TD20038		
Transit Box 2.4 TDCi, Transit Bus 2.4 TDCi, Transit Platform/ Chassis 2.4 TDCi		03/04→05/06	H9FA (Duratorq)		48	
			4cyl. 2402cc 100-103kW (135-140PS)	Diesel Turbo Intercooled TD20036		
Transit Box 2.4 TDCi 4x4, Transit Bus 2.4 TDCi 4x4, Transit Platform/Chassis 2.4 TDCi 4x4		11/06→	H9FB		48	
			4cyl. 2402cc 103kW (140PS)	Diesel Turbo Intercooled TD20033		
Transit Box 2.4 TDCi, Transit Bus 2.4 TDCi, Transit Platform/ Chassis 2.4 TDCi		04/06→	JXFA		48	
			4cyl. 2402cc 85kW (116PS)	Diesel Turbo Intercooled TD20034		
Transit Box 2.4 TDCi, Transit Bus 2.4 TDCi, Transit Platform/ Chassis 2.4 TDCi		04/06→	PHFA		48	
			4cyl. 2402cc 74kW (100PS)	Diesel Turbo Intercooled TD20035		
Transit Box 2.4 TDCi, Transit Bus 2.4 TDCi, Transit Platform/ Chassis 2.4 TDCi		04/06→	PHFC		48	
			4cyl. 2402cc 74kW (100PS)	Diesel Turbo Intercooled TD21068		
08-148100-00	STD	89.90	2.000		001 CK P	KV1
08-148105-00	0.25mm		2.000		026 P	KV1
08-148107-00	0.50mm		2.000		231 NT	ST
Taurus 12 M, Taurus 15 M Taurus 17 M		08/66→12/70 08/64→12/70	12M, 15M, 17M		48	
			V4cyl. 1498cc	FM2422		
Taurus 2.3, Taurus Turnier 2.3		05/75→07/79	YYF		48	
			V6cyl. 2293cc 79kW (107PS)	TD1485		
Granada 2.3 Granada Estate 2.3		01/75→06/79 08/77→06/79	YYH (TV23)		48	
			V6cyl. 2293cc 79kW (107PS)	TD4497		
Capri III 2.3 Super		06/79→12/85	YYN		48	
			V6cyl. 2293cc 84kW (114PS)	TD1487		
Granada 2.3, Granada Estate 2.3		06/79→08/85	YYP (TV23)		48	
			V6cyl. 2293cc 82-84kW (111-114PS)	TD1488		
Taurus '80 Turnier 2.3, Taurus '80 2.3		07/79→07/82	YYR		48	
			V6cyl. 2293cc 84kW (114PS)	TD1489		
Sierra Estate 2.3, Sierra Hatchback 2.3		08/82→12/86	YYT		48	
			V6cyl. 2293cc 84kW (114PS)	TD1490		





Granada 2.3			06/81→08/85	YYU (TV23)			
Granada Estate 2.3			06/81→06/85		V6cyl. 2293cc	82-84kW (111-114PS)	TD1491
08-204500-00	STD	90.00	2.000		001 IF MO P		IKA
			3.000		026 P		STD
			4.000		712 CR		ST
Granada 2.1 D			08/77→08/82	WTA (XD90)			49
					4cyl. 2112cc	46kW (63PS)	TD1478
				Diesel			
08-314900-10	STD	90.00	2.000		001 IW CR P		KV1
[R66070]			2.000		001 P		STD
			2.000		023 P		STD
			4.500		231 CR P		STD
Transit Box 2.0, Transit Bus 2.0, Transit Platform/Chassis 2.0			11/77→10/86	4RC (TL20L)			50
					4cyl. 1993cc	43-57kW (59-78PS)	TD9441
Escort II 2.0 RS			08/75→08/80	NE (N8C (TL20H))			
					4cyl. 1993cc	77kW (105PS)	TD4473
Taurus Coupe 2000			08/73→02/76	NEE			
					4cyl. 1993cc	72kW (98PS)	TD1353
Taurus 2.0			08/76→07/79	NEG			
Taurus 2000			08/73→02/76		4cyl. 1993cc	72kW (98PS)	
Taurus Turnier 2.0			08/76→07/79				TD1354
Granada 2.0, Granada Estate 2.0			08/81→08/85	NEK (N8C (TL20H))			
					4cyl. 1993cc	77kW (105PS)	TD1356
Capri III 2.0			01/78→12/85	NEN			
					4cyl. 1993cc	73kW (99PS)	TD1358
Granada 2.0, Granada Estate 2.0			08/79→08/85	NEP (N8C (TL20H))			
					4cyl. 1993cc	77kW (105PS)	TD1359
Taurus '80 Turnier 2.0, Taurus '80 2.0			07/79→07/82	NER (N8C (TL20H))			
					4cyl. 1993cc	77kW (105PS)	TD4474





Capri II 2.0 Capri III 2.0 Taunus 2.0, Taunus Turnier 2.0	04/74→12/77 01/78→12/85 08/76→07/79	TL 20 H	4cyl. 1993cc	72-74kW (98-101PS)	TD1391	
Granada 2.0, Granada Estate 2.0	01/75→07/77	TL 20 LC	4cyl. 1994cc	73kW (99PS)	TD19004	
08-206600-00 08-206607-00 08-206611-00 08-206617-00	STD 0.50mm 1.00mm 2.286mm	90.80	2.000 2.500 4.000	 	001 IF CR P 026 P 712 CR	IKA STD ST
[R25256]						
Sierra 2.0 i, Sierra Estate 2.0 i, Sierra Hatchback 2.0 i	01/87→02/93	N4A	4cyl. 1993cc EFi	85kW (116PS)	51 TD1318	
Sierra 2.0 i, Sierra Estate 2.0 i, Sierra Hatchback 2.0 i	01/87→02/93	N4I	4cyl. 1993cc EFi	85kW (116PS)	TD1320	
Scorpio I 2.0	04/85→08/89	N8D (N8C (TL20H))	4cyl. 1993cc	77kW (105PS)	TD1334	
P 100 II 2.0	10/87→12/92	NAE (TL20L)	4cyl. 1993cc	57kW (77PS)	TD1342	
Transit Box 2.0 Transit Bus 2.0 Transit Platform/Chassis 2.0	09/85→09/92 11/85→09/92 01/86→09/92	NAT (TL20L)	4cyl. 1993cc	57kW (77PS)	TD4472	
Transit Box 2.0 Transit Bus 2.0 Transit Platform/Chassis 2.0	09/85→09/92 11/85→09/92 01/86→09/92	NAV (TL20L)	4cyl. 1993cc	55-57kW (75-78PS)	TD1344	
Scorpio 2.0	04/85→08/89	NE1	4cyl. 1993cc	74kW (100PS)	TD1347	
Scorpio 2.0	04/85→08/89	NE4	4cyl. 1993cc	74kW (100PS)	TD1350	
Sierra 2.0 i Sierra Estate 2.0 i, Sierra Hatchback 2.0 i	01/87→12/89 01/87→02/93	NE5	4cyl. 1993cc	74kW (100PS)	TD1351	
Sierra 2.0 i Sierra Estate 2.0 i, Sierra Hatchback 2.0 i	01/87→12/89 01/87→02/93	NEJ	4cyl. 1993cc	74kW (100PS)	TD1355	





Scorpio I 2.0		04/85→08/89	NEL (N8C (TL20H))	4cyl. 1993cc	77kW (105PS)	TD1357
Sierra 2.0, Sierra Estate 2.0, Sierra Hatchback 2.0		01/87→02/93	NES (N8C (TL20H))	4cyl. 1993cc	77kW (105PS)	TD1361
Sierra Estate 2.0, Sierra Hatchback 2.0		08/82→12/86	NET (N8C (TL20H))	4cyl. 1993cc	77kW (105PS)	TD1362
Sierra Estate 2.0, Sierra Hatchback 2.0 i		03/85→12/86	NR2	4cyl. 1993cc	85kW (116PS)	TD1364
Scorpio I 2.0 i Scorpio I Saloon 1.9		04/85→09/94 11/92→09/93	NRA	4cyl. 1993cc EFi	85kW (116PS)	TD1365
Sierra Estate 2.0, Sierra Hatchback 2.0 i		03/85→12/86	NRB	4cyl. 1993cc	85kW (116PS)	TD1367
Sierra Estate 2.0, Sierra Hatchback 2.0		10/85→12/86	NRD	4cyl. 1993cc	74kW (100PS)	TD1369
Scorpio I 2.0 i		04/85→09/94	NRI	4cyl. 1993cc EFi	85kW (116PS)	TD1370
08-780300-00	STD	90.80	1.600		001 IF MO P	IKA
08-780307-00	0.50mm					
08-780309-00	0.75mm					
08-780311-00	1.00mm					
08-780314-00	1.50mm					
[R40230]						
Sierra 2.0 RS Cosworth		01/87→12/90	N5B	4cyl. 1993cc	150kW (204PS)	52 TD1322
Sierra Hatchback 2.0 4x4		10/85→02/87				
Sierra Hatchback 2.0 RS Cosworth		11/87→01/90			Turbo Intercooled	
Sierra 2.0 16V Cosworth 4x4, Sierra Hatchback 2.0 16V Cosworth 4x4 CAT		01/90→02/93	N5C	4cyl. 1993cc	162kW (220PS)	TD1323
					Turbo Intercooled	
Sierra Hatchback 2.0 16V Cosworth 4x4		01/90→02/93	N5D	4cyl. 1993cc	162kW (220PS)	TD1324
					Turbo Intercooled	





Escort VI RS Cosworth 4x4		09/92→01/95	N5F		4cyl.			
Escort VII RS Cosworth 4x4		02/95→10/98			1993cc	162-167kW (220-227PS)		
					Turbo Intercooled			TD1326
08-529100-00	STD	90.82	1.500		001 MOL P			KV1
[R49420]			1.750		005 P			GOE12
			3.000		231 CR P			GOE12
Scorpio I 2.5 TD, Scorpio I Estate 2.5 TD, Scorpio I Saloon 2.5 TD		08/93→09/94	SCB		4cyl.	2500cc	85kW (116PS)	53
					Diesel	Turbo Intercooled		TD1443
Scorpio II 2.5 TD, Scorpio II Estate 2.5 TD		10/94→08/98	SCC		4cyl.	2500cc	85kW (116PS)	
					Diesel	Turbo Intercooled		TD4490
Scorpio II 2.5 TD, Scorpio II Estate 2.5 TD		09/96→08/98	VM		4cyl.	2500cc	92kW (125PS)	
					Diesel	Turbo Intercooled		TD5496
08-110100-00	STD	92.00	2.500		008 CR P			KV1
[R47730]			2.000		026 P			STD
			4.000		231 CR P			STD
Sierra Hatchback 2.9 i XR 4x4		08/88→02/93	B4A		V6cyl.	2935cc	143-152kW (195-207PS)	54
					Efi			TD5108
Sierra 2.9 4x4, Sierra 2.9 i, Sierra Estate 2.9, Sierra Estate 2.9 4x4, Sierra Estate 2.9 i, Sierra Hatchback 2.9 i, Sierra Hatchback 2.9 i XR 4x4		08/88→02/93	B4B		V6cyl.	2935cc	143-152kW (195-207PS)	
					Efi			TD1147
Sierra 2.9 4x4, Sierra 2.9 i, Sierra Estate 2.9, Sierra Estate 2.9 4x4, Sierra Estate 2.9 i, Sierra Hatchback 2.9 i, Sierra Hatchback 2.9 i XR 4x4		08/88→02/93	B4C		V6cyl.	2935cc	143-152kW (195-207PS)	
					Efi			TD4440
Scorpio I 2.9 i 24V Scorpio I Estate 2.9 24V Scorpio I Saloon 2.9 i 24V		04/91→09/94 08/93→09/94 04/91→09/94	BOA		V6cyl.	2935cc	143-152kW (195-207PS)	
					Efi			TD1151
Scorpio II 2.9 i 24V, Scorpio II Estate 2.9 i 24V		10/94→08/98	BOB		V6cyl.	2935cc	143-152kW (195-207PS)	
					Efi			TD4441
Scorpio I 2.9 i, Scorpio I 2.9 i 4x4		09/86→09/94	BRC		V6cyl.	2935cc	143-152kW (195-207PS)	
								TD4442





Scorpio I 2.9 i	09/86→09/94	BRD				
Scorpio I 2.9 i 4x4	05/88→02/93		V6cyl.			
Scorpio I Estate 2.9 i	09/91→09/94		2935cc	143-152kW (195-207PS)		
Scorpio I Estate 2.9 i 4x4	05/88→02/93		EFi			
Scorpio I Saloon 2.9 i	09/86→12/94					
Scorpio I Saloon 2.9 i 4x4	12/89→10/94					TD4443
Scorpio I 2.9 i	09/86→09/94	BRE				
Scorpio I 2.9 i 4x4	05/88→02/93		V6cyl.			
Scorpio I 2.9 i CAT	10/87→09/94		2935cc	143-152kW (195-207PS)		
Scorpio I Estate 2.9 i	09/91→09/94		EFi			
Scorpio I Estate 2.9 i 4x4	05/88→02/93					
Scorpio I Saloon 2.9 i	09/86→12/94					
Scorpio I Saloon 2.9 i 4x4	12/89→10/94					TD1153
Scorpio I 2.9 i	09/86→09/94	BRF				
Scorpio I 2.9 i 4x4	05/88→02/93		V6cyl.			
Scorpio I Estate 2.9 i	09/91→09/94		2935cc	143-152kW (195-207PS)		
Scorpio I Estate 2.9 i 4x4	05/88→02/93		EFi			
Scorpio I Saloon 2.9 i	09/86→12/94					
Scorpio I Saloon 2.9 i 4x4	12/89→10/94					TD1154
Scorpio II 2.9 i, Scorpio II Estate 2.9 i	02/95→08/98	BRG				
			V6cyl.			
			2935cc	143-152kW (195-207PS)		
			EFi			TD4444
08-782500-00	STD	93.00	1.600		001 IF MO P	IKA
[R67470]			1.750		026 P	STD
			3.500		231 CR P	STD
Sierra Estate 2.8 XR4i	08/82→12/86	PR5 (TV28)				55
Sierra Hatchback 2.8 i XR 4x4	09/83→12/86		V6cyl.			
Sierra Hatchback 2.8 XR4i	08/82→12/86		2792cc	107kW (146PS)		TD1404
			EFi			
Sierra Estate 2.8 i 4x4, Sierra Estate 2.8 XR4i	08/82→12/86	PR6 (TV28)				
Sierra Hatchback 2.8 i XR 4x4	09/83→12/86		V6cyl.			
Sierra Hatchback 2.8 XR4i	08/82→12/86		2792cc	105kW (143PS)		TD1405
			EFi			
Sierra Estate 2.8 i, Sierra Estate 2.8 i 4x4, Sierra Hatchback 2.8 i XR 4x4	01/87→02/93	PR7 (TV28)				
			V6cyl.			
			2792cc	107kW (146PS)		TD1406
			EFi			
Sierra 2.8 i	08/87→02/93	PR8 (TV28)				
Sierra Estate 2.8 i, Sierra Hatchback 2.8 i	01/87→02/93		V6cyl.			
			2792cc	105-107kW (143-145PS)		TD1407
			EFi			
Granada 2.8 i, Granada Estate 2.8 i	08/77→08/81	PRB (TV28)				
			V6cyl.			
			2792cc	118kW (160PS)		TD4481
			EFi			
Granada 2.8 i, Granada Estate 2.8 i	10/82→08/85	PRC (TV28)				
			V6cyl.			
			2792cc	108-110kW (147-150PS)		TD1408
			EFi			
Granada 2.8 i, Granada Estate 2.8 i	08/77→08/85	PRD (TV28)				
			V6cyl.			
			2792cc	108-110kW (147-150PS)		TD1410
			EFi			





Scorpio I 2.8 i		04/85→11/86	PRE (TV28)	V6cyl.	2792cc	110kW (150PS)	TD1411
Scorpio I 2.8 i 4x4		10/85→11/86		EFi			
Sierra Estate 2.8 4x4, Sierra Hatchback 2.8 i XR 4x4		01/87→08/88	PRG (TV28)	V6cyl.	2792cc	110kW (150PS)	TD1412
Capri III 2.8 Super Injection		01/81→04/87	PRN (TV28)	V6cyl.	2792cc	118kW (160PS)	TD4482
Sierra Hatchback 2.8 XR 4x4 Sierra Hatchback 2.8 XR4i		02/85→12/86 08/82→12/86	PRT (TV28)	V6cyl.	2792cc	110kW (150PS)	TD1414
Granada 2.8, Granada Estate 2.8		08/77→08/85	PYA (TV28)	V6cyl.	2792cc	97-99kW (132-135PS)	TD1415
Granada 2.8, Granada Estate 2.8		06/81→08/85	PYU (TV28)	V6cyl.	2792cc	97-99kW (132-135PS)	TD1417
08-214700-00	STD	93.00	2.000		001 IF MO P		IKA
[R31130K]			2.500		026 P		STD
			4.000		712 CR		ST
A-Series AO409, A-Series AO509, A-Series AO609, A-Series AO709		09/73→09/83	2402E York (Parent Block)	6cyl.	3537cc		56
				Diesel			FM2463
Transit Box 2.4 D		11/77→10/86	4AA (2401E York Parent Block)	4cyl.	2358cc	46kW (63PS)	TD17094
Transit Bus 2.4 D		12/77→10/86					
Transit Platform/Chassis 2.4 D		11/77→09/85					
08-207300-10	STD	93.67	2.385		007 CR P		IKA
08-207311-10	1.00mm		2.385		023 P		STD
08-207321-10	0.65mm		4.747		231 CR P		STD
[R40120]							
Transit Box 2.5 D		10/83→09/91	4AB (D25)	4cyl.	2496cc	50kW (68PS)	TD1113
Transit Bus 2.5 D		10/83→09/92					
Transit Platform/Chassis 2.5 D		10/83→01/89					
				Diesel			
Transit Box 2.5 D		10/88→09/91	4BA (D25)	4cyl.	2496cc	52kW (71PS)	TD1114
Transit Bus 2.5 D, Transit Platform/ Chassis 2.5 DI		09/88→09/92					
				Diesel			





Transit Box 2.5 D			10/88→09/91	4CA (D25)			
Transit Bus 2.5 D, Transit Platform/ Chassis 2.5 DI			09/88→09/92		4cyl.		
					2496cc	52kW (71PS)	
				Diesel			TD1116
08-780100-00	STD	93.67	2.000		001 CR		KV1
08-780111-00	1.00mm				005		STD
08-780121-00	0.65mm		2.000		231 CR		STD
→10/1988			4.000				
[R39920]							
08-784800-00	STD	93.67	2.500		008 IF MOL P		KV1
08-784811-00	1.00mm				005 IF P		IKA
08-784821-00	0.65mm		2.000		231 CR P		STD
11/1988→			4.000				
[R45060]							
Transit Box 2.5 DI			05/91→06/94	4BC (D25)			58
Transit Bus 2.5 DI			08/91→07/94		4cyl.		
Transit Platform/Chassis 2.5 DI			09/91→08/94		2496cc	52kW (71PS)	
				Diesel			TD1115
Transit Box 2.5 DI			05/91→06/94	4CC (D25)			
Transit Bus 2.5 DI			08/91→07/94		4cyl.		
Transit Platform/Chassis 2.5 DI			09/91→08/94		2496cc	52kW (71PS)	
				Diesel			TD1117
Transit Box 2.5 DI			05/91→06/94	4DA (D25)			
Transit Bus 2.5 DI			09/91→07/94		4cyl.		
Transit Platform/Chassis 2.5 DI			09/91→08/94		2496cc	59kW (80PS)	
				Diesel			TD1118
Transit Box 2.5 DI			05/91→03/00	4FA (D25)			
Transit Bus 2.5 DI			08/91→03/00		4cyl.		
Transit Platform/Chassis 2.5 DI			09/91→03/00		2496cc	51kW (69PS)	
Transit Tourneo 2.5 DI			11/94→12/00	Diesel			TD1120
Transit Box 2.5 DI			06/94→03/00	4FB (D25)			
Transit Bus 2.5 DI, Transit Platform/ Chassis 2.5 DI			08/94→03/00		4cyl.		
Transit Tourneo 2.5 DI			11/94→12/00		2496cc	51kW (69PS)	
				Diesel			TD4426
Transit Box 2.5 DI			06/94→03/00	4FC (D25)			
Transit Bus 2.5 DI, Transit Platform/ Chassis 2.5 DI			08/94→03/00		4cyl.		
Transit Tourneo 2.5 DI			11/94→12/00		2496cc	51kW (69PS)	
				Diesel			TD4428
Transit Box 2.5 DI			06/94→03/00	4FD (D25)			
Transit Bus 2.5 DI, Transit Platform/ Chassis 2.5 DI			08/94→03/00		4cyl.		
Transit Tourneo 2.5 DI			11/94→12/00		2496cc	51kW (69PS)	
				Diesel			TD15209
Transit Box 2.5 DI			10/92→06/94	4GA (D25T)			
Transit Box 2.5 TD			06/94→03/00		4cyl.		
Transit Bus 2.5 TD			10/92→03/00		2496cc	63kW (86PS)	
Transit Platform/Chassis 2.5 TD			11/92→03/00	Diesel	Turbo		
Transit Tourneo 2.5 TD			11/94→12/00				TD4430
Transit Box 2.5 DI			06/94→03/00	4HB (D25)			
Transit Bus 2.5 DI			07/94→03/00		4cyl.		
Transit Platform/Chassis 2.5 DI			08/94→03/00		2496cc	56kW (76PS)	
Transit Tourneo 2.5 DI			11/94→12/00	Diesel			TD4436





Transit Box 2.5 DI			06/94→03/00	4HC (D25)				
Transit Bus 2.5 DI			07/94→03/00		4cyl.			
Transit Platform/Chassis 2.5 DI			08/94→03/00		2496cc	56kW (76PS)		
Transit Tourneo 2.5 DI			11/94→12/00	Diesel				TD15210
08-123700-00	STD	93.67	2.500		007 IF MOL P			KV1
08-123711-00	1.00mm				005 IF P			IKA
08-123721-00	0.65mm		2.000		231 CR P			STD
01/1995→			4.000					
[R49520]								
08-784800-00	STD	93.67	2.500		008 IF MOL P			KV1
08-784811-00	1.00mm				005 IF P			IKA
08-784821-00	0.65mm		2.000		231 CR P			STD
→01/1995			4.000					
[R45060]								
Transit Box 2.5 TD			05/91→06/94	4EA (D25T)				59
Transit Bus 2.5 TD			09/91→07/94		4cyl.			
Transit Platform/Chassis 2.5 TD			09/91→08/94		2496cc	74kW (100PS)		
				Diesel	Turbo			TD1119
Transit Box 2.5 TDI			06/94→03/00	4EB (D25T)				
Transit Bus 2.5 TD			07/94→03/00		4cyl.			
Transit Platform/Chassis 2.5 TD			08/94→03/00		2496cc	74kW (100PS)		
Transit Tourneo 2.5 TD			04/98→12/00	Diesel	Turbo			TD4424
Transit Box 2.5 TDI			06/94→03/00	4EC (D25T)				
Transit Bus 2.5 TD			07/94→03/00		4cyl.			
Transit Platform/Chassis 2.5 TD			08/94→03/00		2496cc	74kW (100PS)		
Transit Tourneo 2.5 TD			04/98→12/00	Diesel	Turbo			TD15214
Transit Box 2.5 DI			05/99→03/00	4ED (D25)				
Transit Bus 2.5 DI			08/97→03/00		4cyl.			
Transit Platform/Chassis 2.5 DI			05/99→03/00		2496cc	85kW (116PS)		
				Diesel				TD12093
Transit Box 2.5 TD			06/94→03/00	4GB (D25T)				
Transit Bus 2.5 TD			10/92→03/00		4cyl.			
Transit Platform/Chassis 2.5 TD			08/94→03/00		2496cc	63kW (86PS)		
Transit Tourneo 2.5 TD			11/94→12/00	Diesel	Turbo			TD4432
Transit Box 2.5 TD			06/94→03/00	4GC (D25T)				
Transit Bus 2.5 TD			10/92→03/00		4cyl.			
Transit Platform/Chassis 2.5 TD			08/94→03/00		2496cc	63kW (86PS)		
Transit Tourneo 2.5 TD			11/94→12/00	Diesel	Turbo			TD4433
Transit Box 2.5 TD			06/94→03/00	4GD (D25T)				
Transit Bus 2.5 TD			01/95→03/00		4cyl.			
Transit Platform/Chassis 2.5 TD			08/94→03/00		2496cc	63kW (86PS)		
				Diesel	Turbo			TD15211
Transit Box 2.5 TD			06/94→03/00	4GE (D25T)				
Transit Bus 2.5 TD			01/95→03/00		4cyl.			
Transit Platform/Chassis 2.5 TD			08/94→03/00		2496cc	63kW (86PS)		
				Diesel	Turbo			TD15212
Transit Box 2.5 TD			06/94→03/00	4GF (D25T)				
Transit Bus 2.5 TD			01/95→03/00		4cyl.			
Transit Platform/Chassis 2.5 TD			08/94→03/00		2496cc	63kW (86PS)		
				Diesel	Turbo			TD15213
Transit Box 2.5 TD			10/98→03/00	4HA (D25T)				
Transit Bus 2.5 TD			08/94→06/00		4cyl.			
Transit Platform/Chassis 2.5 TD			10/98→07/00		2496cc	55kW (75PS)		
Transit Tourneo 2.4 D			08/94→06/00	Diesel	Turbo			
Transit Tourneo 2.5 DI			11/94→12/00					TD4434





Transit Box 2.5 TD		10/98→03/00	4HD (D25T)			
Transit Bus 2.5 TD		08/94→06/00	4cyl.			
Transit Platform/Chassis 2.5 TD		10/98→07/00	2496cc	55kW (75PS)		
			Diesel	Turbo		TD16250
08-123700-00	STD	93.67	2.500		007 IF MOL P	KV1
08-123711-00	1.00mm		2.000		005 IF P	IKA
08-123721-00	0.65mm		4.000		231 CR P	STD
[R49520]						
Scorpio I 2.5 TD		06/88→07/93	SFA (XD3T)			60
Scorpio I Estate 2.5 TD		09/91→07/93	4cyl.			
Scorpio I Saloon 2.5 TD		06/88→07/93	2498cc	68kW (92PS)		
			Diesel	Turbo		TD4492
Scorpio I 2.5 TD		06/88→07/93	SFB (XD3T)			
Scorpio I Estate 2.5 TD		09/91→07/93	4cyl.			
Scorpio I Saloon 2.5 TD		06/88→07/93	2498cc	68kW (92PS)		
			Diesel	Turbo		TD4493
Granada 2.3 D, Scorpio 2.3 D, Sierra 2.3 D		01/82→	XD2S			
Sierra 2300 Ghia, Sierra 2300 GL		01/82→12/85	4cyl.			
			2304cc	51kW (69PS)		
			Diesel	Turbo		FM1429
08-320200-10	STD	94.00	3.000		008 MOL P	IKA
08-320204-10	0.20mm		2.000		005 P	IKA
08-320206-10	0.40mm		4.000		231 CR P	STD
08-320208-10	0.60mm					
08-320211-10	1.00mm					
[R66000]						
Granada 2.5 D, Granada Estate 2.5 D		08/82→08/85	STP (XD3/XD3P)			61
			4cyl.			
			2498cc	51kW (69PS)		
			Diesel			TD1448
Scorpio I 2.5 D		12/85→02/92	STR (XD3/XD3P)			
Scorpio I Estate 2.5 D		10/90→08/92	4cyl.			
Scorpio I Saloon 2.5 D		12/89→12/94	2498cc	51kW (69PS)		
			Diesel			TD1449
			XD3P			
			4cyl.			
			2498cc	53-58kW (72-79PS)		
			Diesel			TD22249
Sierra 2.3 D		01/87→09/89	YTR (XD2/XD2P/XD94)			
Sierra Estate 2.3 D		01/87→02/93	4cyl.			
Sierra Hatchback 2.3 D		01/87→09/89	2304cc	49kW (67PS)		
			Diesel			TD1482
Sierra 2.3 D		01/87→09/89	YTT (XD2/XD2P/XD94)			
Sierra Estate 2.3 D,		08/82→12/86	4cyl.			
Sierra Hatchback 2.3 D			2304cc	49kW (67PS)		
			Diesel			TD1483
08-318700-10	STD	94.00	2.000		001 CR P	KV1
08-318704-10	0.20mm		2.000		005 IF P	STD
08-318706-10	0.40mm		4.000		231 CR P	STD
08-318707-10	0.50mm					
08-318708-10	0.60mm					
08-318710-10	0.80mm					
08-318711-10	1.00mm					
[R66140]						

Motorverzeichnis • Index de moteur • Índice de Motor
Indeks silnika • Модель двигателя • دليل المحرك

ENGINE INDEX



CCM

x



9

3.152	Diesel	2500	3	91.49	1
6Y series (256 cu.in.)	Diesel	4195	4	106.69	3
6Y series 32D (158 cu.in.)	Diesel	2589	3	106.69	3
6Y series 40D (175 cu.in.)	Diesel	2867	3	106.69	3
6Y, 7A series (256 cu.in.)	Diesel	4195	4	111.77	6
7A series (201 cu.in.)	Diesel	3294	3	111.77	6
7A series (256 cu.in.)	Diesel	4195	4	106.69	3
7A series 32D (158 cu.in.)	Diesel	2589	3	106.69	3
7A series 32D (180 cu.in.)	Diesel	2950	3	106.69	3
7A series 40D (175 cu.in.)	Diesel	2867	3	106.69	3
56G	Diesel	3819	4	106.69	3
268 cu.in. (7600)	Diesel	4391	4	111.77	5
268 cu.in. (7600,7700)	Diesel	4391	4	111.77	5
401 cu.in. (TW20,TW30)	Diesel	6571	6	111.77	5
592E	Diesel	3610	4	100.00	2
2715E D-Series parent blk (380 cu.in)	Diesel	6227	6	107.21	4
BSD 332 (192 cu.in.)	Diesel	3146	3	111.77	6
BSD333 (201 cu.in.)	Diesel	3294	3	111.77	7
BSD333 >87 (201 cu.in.)	Diesel	3294	3	111.77	6
BSD333H (201 cu.in.)	Diesel	3294	3	111.77	7
BSD442 (256 cu.in.)	Diesel	4195	4	111.77	6
BSD444 (268 cu.in.)	Diesel	4391	4	111.77	7
BSD444T (268 cu.in.)	Diesel	4391	4	111.77	5



1

3.152		3cyl.	2500cc	22-33kW (30-45PS)	Diesel	Indirect Injection	FM1351
08-314600-00 ¹ eng.1935854→ [R34560K]	STD	91.49	2.385		001 IW CR P		STD
			2.385		005 IF P		STD
			3.160		026 P		STD
			6.335		231 P		STD
			6.335		031 P		STD
08-525100-00 →eng.1935853 [R34550]	STD	91.49	2.385		001 P		GOE12
			2.385		005 P		GOE12
			3.160		026 P		GOE12
			6.350		030		GOE12
			6.350		030		GOE12

¹ Not for chromed cylinders

¹ Nicht für verchromte Zylinder

¹ Non appropriés pour cylindres chromés

¹ No se usan para cilindros cromados

2

592E		4cyl.	3610cc		Diesel		FM2503
08-203500-10 [R40000]	STD	100.00	2.385		001 IF CR P		IKA
			2.385		001 P		STD
			2.385		023 P		STD
			4.747		231 CR P		STD
			4.747		031 P		STD

3

56G		4cyl.	3819cc		Diesel		FM2974
6Y series (256 cu.in.)		4cyl.	4195cc		Diesel		FM6757
6Y series 32D (158 cu.in.)		3cyl.	2589cc		Diesel		FM6738
6Y series 40D (175 cu.in.)		3cyl.	2867cc		Diesel		FM6732
6Y series 40D (175 cu.in.)		3cyl.	2867cc		Diesel		FM6733
7A series (256 cu.in.)		4cyl.	4195cc		Diesel		FM6756
7A series 32D (158 cu.in.)		3cyl.	2589cc		Diesel		FM6736
7A series 32D (180 cu.in.)		3cyl.	2950cc		Diesel		FM6735
7A series 40D (175 cu.in.)		3cyl.	2867cc		Diesel		FM6734
08-208100-00 STD 08-208107-00 .020 08-208109-00 .030 08-208111-00 .040 [R31620/2K/V2]		106.69	2.385		001 IW CR P		KV1
			2.385		001 IF P		STD
			2.385		023 P		STD
			4.747		231 CR P		STD



4

2715E D-Series parent blk (380 cu.in)		6cyl.	6227cc		Diesel	FM2562
08-214800-10	STD	107.21	2.385		001 CR P	KV1
08-214807-10	.020				005 IW P	STD
08-214809-10	.030		2.385		026 P	STD
08-214811-10	.040		2.385		231 CR P	STD
[R40110]			4.747			

5

268 cu.in. (7600)		4cyl.	4391cc		Diesel	FM6749
268 cu.in. (7600,7700)		4cyl.	4391cc		Diesel	FM6753
401 cu.in. (TW20,TW30)		6cyl.	6571cc		Diesel Turbo	FM6768
BSD444T (268 cu.in.)		4cyl.	4391cc		Diesel Turbo	FM3522
08-100100-00	STD	111.77	3.160		008 CR P	KV1
08-100107-00	.020				001 IW P	STD
08-100109-00	.030		2.385		023 P	STD
08-100111-00	.040		2.385		231 CR P	STD
10/1972→			4.747			
[R31650/2K/V1]						

6

6Y, 7A series (256 cu.in.)		4cyl.	4195cc		Diesel	FM6745
7A series (201 cu.in.)		3cyl.	3294cc		Diesel	FM6730
BSD 332 (192 cu.in.)		3cyl.	3146cc		Diesel	FM3456
BSD333 >87 (201 cu.in.)		3cyl.	3294cc		Diesel	FM3518
BSD442 (256 cu.in.)		4cyl.	4195cc		Diesel	FM6747
08-202400-10	STD	111.77	2.385		001 IW CR P	KV1
08-202407-10	.020				001 IW P	STD
08-202409-10	.030		2.385		023 P	STD
[R31640/2K/V2]				4.747		231 CR P



7

BSD333 (201 cu.in.)		3cyl.	3294cc		Diesel	Direct Injection	FM33519
BSD333H (201 cu.in.)		3cyl.	3294cc		Diesel		FM3519
BSD444 (268 cu.in.)		4cyl.	4391cc		Diesel		FM3521
08-100100-00	STD	111.77	3.160		008 CR P		KV1
08-100107-00	.020				001 IW P		STD
08-100109-00	.030		2.385		023 P		STD
08-100111-00	.040		2.385		231 CR P		STD
01/1972→			4.747				
[R31650/2K/V1]							
08-202400-10	STD	111.77	2.385		001 IW CR P		KV1
08-202407-10	.020		2.385		001 IW P		STD
08-202409-10	.030		2.385		023 P		STD
01/1968→09/1972			2.385		231 CR P		STD
			4.747				
[R31640/2K/V2]							



1

6LX	6cyl.	10450cc	Diesel	FM3681
6LXB	6cyl.	10450cc	Diesel	FM3683
6LXB MARINE	6cyl.	10450cc	Diesel	FM3684
8LX	8cyl.	13930cc	Diesel	FM3686
8LXB	8cyl.	13930cc	Diesel	FM3688
8LXB MARINE	8cyl.	13930cc	Diesel	FM3689

08-522000-00	STD	120.65	2.385		001 CR	KV1
08-522009-00	.030		2.385		001 CR	KV1
[R40020]			4.747		036	KV1



						1
B		4cyl.	2977cc	59kW (80PS)	Diesel	FM1716
08-526300-00 STD	95.00		2.500		007 CR	KV1
01/1978→12/1980			2.500		005 CR	STD
[R34990]			4.500		231 CR	STD

						2
3B, 3BK		4cyl.	3432cc		Diesel	FM3346
08-374000-00 STD	102.00		2.500		007 CR P	KV1
01/1981→12/1985			2.500		005 P	STD
[R41840]			4.500		231 CR P	STD

Modelverzeichnis • Index de modele • Índice de Modelo
 Indeks modelu • Модель автомобиля • دليل الموديل

MODEL INDEX

CCM

x



9

01/76→12/78	Accord 1600	EF	Petrol	1599	4	2
01/78→12/83	Accord 1800 CVCC	EK	Petrol	1751	4	4
01/78→09/83	Accord I 1.6 L/EX	EL	Petrol	1602	4	4
01/79→09/83	Accord I Hatchback 1.6 L/EX	EL	Petrol	1602	4	4
01/86→03/88	Accord III 2.0 12V	A20A1	Petrol	1955	4	6
01/87→12/89	Accord III 2.0 12V	A20A3	Petrol	1955	4	6
11/85→12/89	Accord III 2.0 EX	A20A1	Petrol	1955	4	6
11/85→05/89	Accord III 2.0 EX	A20A2	Petrol	1955	4	6
01/86→12/89	Accord III 2.0 EXi	A20A3	Petrol	1955	4	6
11/85→12/87	Accord III 2.0 EXi	A20A4	Petrol	1955	4	6
01/86→12/86	Accord III Aerodeck 2.0	A20A2	Petrol	1955	4	6
10/87→12/89	Accord III Aerodeck 2.0 EX	A20A1	Petrol	1955	4	6
11/85→05/89	Accord III Aerodeck 2.0 EX	A20A2	Petrol	1955	4	6
10/87→12/89	Accord III Aerodeck 2.0 EXi	A20A3	Petrol	1955	4	6
11/85→12/87	Accord III Aerodeck 2.0 EXi	A20A4	Petrol	1955	4	6
04/96→10/98	Accord V 2.0 TDi	20T2N	Diesel	1994	4	7
02/99→12/02	Accord VI 2.0 Turbo DI	20T2N	Diesel	1994	4	7
12/99→10/00	Accord VI Hatchback 2.0 TDi	20T2N	Diesel	1994	4	7
01/04→	Accord VII 2.2 i-CTDi	N22A1	Diesel	2204	4	8
01/04→	Accord VII Tourer 2.2 i-CTDi	N22A1	Diesel	2204	4	8
01/80→12/83	Ballade 1500 CVCC	EM	Petrol	1488	4	2
02/97→11/99	City Saloon 1.8 D	XUD7T	Diesel	1769	4	5
01/80→12/85	Civic 1500 CVCC	EM	Petrol	1488	4	2
09/80→09/83	Civic I Saloon 1300 L	EN1	Petrol	1335	4	1
09/79→09/83	Civic II Estate 1300	EN1	Petrol	1335	4	1
09/79→09/83	Civic II Hatchback 1300 L	EN1	Petrol	1335	4	1
01/88→12/92	Civic II Shuttle 1.6 4x4	D16A	Petrol	1590	4	3
01/94→11/95	Civic V Coupe 1.6 i	D16Y7	Petrol	1590	4	3
10/91→11/95	Civic V Hatchback 1.5 i 16V	D15Z1 (VTEC)	Petrol	1493	4	3
06/93→09/95	Civic V Saloon 1.5	D15Z1 (VTEC)	Petrol	1493	4	3
10/93→12/95	Civic V Saloon 1.5	D15Z1 (VTEC)	Petrol	1493	4	3
10/91→11/95	Civic V Saloon 1.5 i 16V	D15Z1 (VTEC)	Petrol	1493	4	3
04/98→02/01	Civic VI Aerodeck 2.0 i D	20T2N	Diesel	1994	4	7
05/96→04/99	Civic VI Coupe 1.6	D16Y7	Petrol	1590	4	3
03/96→03/00	Civic VI Coupe 1.6 i	D16Y7	Petrol	1590	4	3
03/96→03/00	Civic VI Coupe 1.6 i Vtec	D16Y8	Petrol	1590	4	3
01/97→02/01	Civic VI Fastback 2.0 i TD	20T2R	Diesel	1994	4	7
11/98→10/00	Civic VI Fastback 2.0 TDiC	20T2N	Diesel	1994	4	7
11/95→02/01	Civic VI Hatchback 1.6 i	D16Y5	Petrol	1590	4	3
11/98→10/00	Civic VI Hatchback 2.0 TDiC	20T2N	Diesel	1994	4	7
11/95→02/01	Civic VI Saloon 1.6 i Vtec	D16Y8	Petrol	1590	4	3
01/06→	Civic VIII Hatchback 2.2 CTDi	N22A2	Diesel	2204	4	8
08/94→10/96	Concerto 1.8 TD	XUD7T	Diesel	1769	4	5
02/05→09/06	CR-V II 2.2 CTDi	N22A2	Diesel	2204	4	8
01/07→	CR-V III 2.2 i-CTDi 4WD	N22A2	Diesel	2204	4	8
10/87→05/88	CRX II 1.6 i 16V	D16A	Petrol	1590	4	3
03/92→12/98	CRX III 1.6 ESi	D16Y8	Petrol	1590	4	3
10/95→09/99	Domani 1.6	D16A	Petrol	1590	4	3
10/95→09/99	Domani 1.6 All-wheel Drive	D16A	Petrol	1590	4	3
07/05→	FR-V 2.2 i CTDi	N22A1	Diesel	2204	4	8
01/78→12/83	Prelude 1800 CVCC	EK	Petrol	1751	4	4
11/78→10/82	Prelude I Coupe 1.6	EL	Petrol	1602	4	4
02/80→12/84	Quintet 1.6 EX	EL	Petrol	1602	4	4

ENGINE INDEX

Motorverzeichnis • Index de moteur • Índice de Motor
Indeks silnika • Модель двигателя • دليل المحرك



CCM

x



9

20T2N	Diesel	1994	4	84.45	7
20T2R	Diesel	1994	4	84.45	7
A20A1	Petrol	1955	4	82.70	6
A20A2	Petrol	1955	4	82.70	6
A20A3	Petrol	1955	4	82.70	6
A20A4	Petrol	1955	4	82.70	6
D15Z1 (VTEC)	Petrol	1493	4	75.00	3
D16A	Petrol	1590	4	75.00	3
D16Y5	Petrol	1590	4	75.00	3
D16Y7	Petrol	1590	4	75.00	3
D16Y8	Petrol	1590	4	75.00	3
EF	Petrol	1599	4	74.00	2
EK	Petrol	1751	4	77.00	4
EL	Petrol	1602	4	77.00	4
EM	Petrol	1488	4	74.00	2
EN1	Petrol	1335	4	72.00	1
N22A1	Diesel	2204	4	85.00	8
N22A2	Diesel	2204	4	85.00	8
XUD7T	Diesel	1769	4	80.00	5



Civic I Saloon 1300 L			09/80→09/83	EN1				1
Civic II Estate 1300,			09/79→09/83		4cyl.			
Civic II Hatchback 1300 L					1335cc	51kW (69PS)		
TD4529								
08-228300-00	STD	72.00	1.500		001 IF CR P			IKA
			1.500		005 P			STD
			4.000		236 P			STD
<hr/>								
Accord 1600			01/76→12/78	EF				2
					4cyl.			
					1599cc	60kW (81PS)		
FM803								
Ballade 1500 CVCC			01/80→12/83	EM				3
Civic 1500 CVCC			01/80→12/85		4cyl.			
					1488cc	63kW (86PS)		
FM3242								
08-228400-00	STD	74.00	1.500		001 IF CR P			IKA
			1.500		005 P			STD
			4.000		236 P			STD
<hr/>								
Civic V Hatchback 1.5 i 16V			10/91→11/95	D15Z1 (VTEC)				3
Civic V Saloon 1.5			06/93→12/95		4cyl.			
Civic V Saloon 1.5 i 16V			10/91→11/95		1493cc	69kW (93PS)		
TD1551								
Civic II Shuttle 1.6 4x4			01/88→12/92	D16A				3
CRX II 1.6 i 16V			10/87→05/88		4cyl.			
Domani 1.6, Domani 1.6 All-wheel Drive			10/95→09/99		1590cc	79-91kW (107-124PS)		
TD17638								
Civic VI Hatchback 1.6 i			11/95→02/01	D16Y5				3
					4cyl.			
					1590cc	84kW (114PS)		
TD14488								
Civic V Coupe 1.6 i			01/94→11/95	D16Y7				3
Civic VI Coupe 1.6			05/96→04/99		4cyl.			
Civic VI Coupe 1.6 i			03/96→03/00		1590cc	77kW (105PS)		
TD11128								
Civic VI Coupe 1.6 i Vtec			03/96→03/00	D16Y8				3
Civic VI Saloon 1.6 i Vtec			11/95→02/01		4cyl.			
CRX III 1.6 ESi			03/92→12/98		1590cc	84-92kW (114-125PS)		
TD4521								
08-433700-00	STD	75.00	1.000		001 CR			ST
08-433707-00	0.50mm		1.200		005			
			2.850		231 CR			STD



Accord 1800 CVCC, Prelude 1800 CVCC	01/78→12/83	EK	4cyl. 1751cc	71kW (96PS)	4
					FM805

Accord I 1.6 L/EX	01/78→09/83	EL	4cyl. 1602cc	60kW (81PS)	
Accord I Hatchback 1.6 L/EX	01/79→09/83				
Prelude I Coupe 1.6	11/78→10/82				
Quintet 1.6 EX	02/80→12/84				TD1573

08-227700-00	STD	77.00	1.500		001 IF CR P	IKA
			1.500		005 P	STD
			4.000		236 P	STD

City Saloon 1.8 D	02/97→11/99	XUD7T	4cyl. 1769cc	58kW (79PS)	5
Concerto 1.8 TD	08/94→10/96				
					TD18393

08-323600-00	STD	80.00	3.000		008 MOL P	KV1
			2.000		005 P	STD
			3.000		231 CR P	STD
[R49910]						

Accord III 2.0 12V	01/86→03/88	A20A1	4cyl. 1955cc	75kW (102PS)	6
Accord III 2.0 EX	11/85→12/89				
Accord III Aerodeck 2.0 EX	10/87→12/89				TD4498

Accord III 2.0 EX	11/85→05/89	A20A2	4cyl. 1955cc	78kW (106PS)	
Accord III Aerodeck 2.0	01/86→12/86				
Accord III Aerodeck 2.0 EX	11/85→05/89				TD1515

Accord III 2.0 12V	01/87→12/89	A20A3	4cyl. 1955cc	85kW (116PS)	
Accord III 2.0 EXi	01/86→12/89				
Accord III Aerodeck 2.0 EXi	10/87→12/89				TD4499

Accord III 2.0 EXi, Accord III Aerodeck 2.0 EXi	11/85→12/87	A20A4	4cyl. 1955cc	90kW (122PS)	
					TD1517

08-227800-00	STD	82.70	1.500		001 CR P	IKA
			1.500		005 P	STD
			4.000		236 P	STD



Accord V 2.0 TDi	04/96→10/98	20T2N				7
Accord VI 2.0 Turbo DI	02/99→12/02		4cyl.			
Accord VI Hatchback 2.0 TDi	12/99→10/00		1994cc	77kW (105PS)		
Civic VI Aerodeck 2.0 i D	04/98→02/01	Diesel	Turbo			
Civic VI Fastback 2.0 TDiC, Civic VI Hatchback 2.0 TDiC	11/98→10/00				TD5390	

Civic VI Fastback 2.0 i TD	01/97→02/01	20T2R				
			4cyl.			
			1994cc	63kW (86PS)		
		Diesel	Turbo			TD22035

08-119800-00 STD	84.45	3.000		008 IF PS	KV1
08-119807-00 0.50mm →eng.(V) 10P13888B		2.000		026 P	F12/F14
[R49390]		3.000		231 CR	STD

Accord VII 2.2 i-CTDi, Accord VII Tourer 2.2 i-CTDi	01/04→	N22A1				8
FR-V 2.2 i CTDi	07/05→		4cyl.			
			2204cc	103kW (140PS)		
		Diesel	Turbo Intercooled			TD18260

Civic VIII Hatchback 2.2 CTDi	01/06→	N22A2				
CR-V II 2.2 CTDi	02/05→09/06		4cyl.			
CR-V III 2.2 i-CTDi 4WD	01/07→		2204cc	103kW (140PS)		
		Diesel	Turbo Intercooled			TD20327

08-439000-00 STD	85.00	2.500		008 NT PVD	ST
		1.500		001 IFU NT	ST
		2.000		231 NT	ST

MODEL INDEX

Modelverzeichnis • Index de modele • Índice de Modelo
Indeks modelu • Модель автомобиля • دليل الموديل



CCM

x



9

10/94→01/00	Accent I 1.5 i 12V	G4EK	Petrol	1495	4	4
09/99→10/02	Accent II 1.5	G4EK	Petrol	1495	4	4
04/02→11/05	Accent II 1.5 CRDi	D3EA	Diesel	1493	3	7
12/02→11/05	Accent II 1.6	G4ED-G	Petrol	1599	4	5
11/05→11/10	Accent III 1.4 GL	G4EE Euro 4	Petrol	1399	4	3
11/05→11/10	Accent III 1.5 CRDi GLS	D4FA	Diesel	1493	4	1
11/05→11/10	Accent III 1.6 GLS	G4ED Euro 4	Petrol	1599	4	5
11/05→11/10	Accent Saloon 1.4 GL	G4EE Euro 4	Petrol	1399	4	3
01/02→11/05	Accent Saloon 1.5 CRDi	D3EA	Diesel	1493	3	7
11/05→11/10	Accent Saloon 1.5 CRDi GLS	D4FA	Diesel	1493	4	1
10/94→01/00	Accent Saloon 1.5 i 12V	G4EK	Petrol	1495	4	4
12/02→11/05	Accent Saloon 1.6	G4ED-G	Petrol	1599	4	5
11/05→11/10	Accent Saloon 1.6 GLS	G4ED Euro 4	Petrol	1599	4	5
01/87→	Canter 3.3	4D31	Diesel	3298	4	12
03/02→08/09	Coupe 1.6 16V	G4ED-G	Petrol	1599	4	5
05/03→07/06	Elantra 1.6	G4ED-G	Petrol	1599	4	5
06/00→07/06	Elantra 1.6	G4ED-G	Petrol	1599	4	5
04/01→07/06	Elantra 2.0 CRDi	D4EA	Diesel	1991	4	7
05/03→07/06	Elantra Saloon 1.6	G4ED-G	Petrol	1599	4	5
06/00→07/06	Elantra Saloon 1.6	G4ED-G	Petrol	1599	4	5
04/01→07/06	Elantra Saloon 2.0 CRDi	D4EA	Diesel	1991	4	7
	Galloper 2.4	4D55T	Diesel	2346	4	10
01/96→	Galloper 2.5	4D56Ti	Diesel	2476	4	10
08/91→07/98	Galloper I 2.5 TD	4D56T	Diesel	2477	4	10
08/91→07/98	Galloper I 2.5 TD intercooler	4D56T	Diesel	2477	4	10
08/91→07/98	Galloper I 3.0 V6	6G72	Petrol	2972	V6	11
01/80→12/86	Galloper Jeep 2.4	4D55	Diesel	2346	4	9
08/05→06/09	Getz 1.4 i	G4EE Euro 4	Petrol	1399	4	3
03/03→09/05	Getz 1.5 CRDi	D3EA	Diesel	1493	3	7
08/05→06/09	Getz 1.5 CRDi	D4FA	Diesel	1493	4	1
07/04→08/05	Getz 1.5 CRDi GLS	D4FA	Diesel	1493	4	1
08/05→06/09	Getz 1.5 CRDi GLS	D4FA	Diesel	1493	4	1
08/05→06/09	Getz 1.6	G4ED-G	Petrol	1599	4	5
09/02→09/05	Getz 1.6	G4ED-G	Petrol	1599	4	5
01/80→12/86	Grace 2.4 Van 1 ton	4D55	Diesel	2346	4	9
06/06→12/07	H-1 / Starex 2.5 CRDi	D4CB Euro 4	Diesel	2497	4	8
12/02→04/04	H-1 / Starex 2.5 CRDi	D4CB Euro 4	Diesel	2497	4	8
12/02→04/04	H-1 / Starex 2.5 CRDi 4WD	D4CB Euro 4	Diesel	2497	4	8
07/01→04/04	H-1 Box 2.5 CRDi	D4CB Euro 4	Diesel	2497	4	8
08/03→04/04	H-1 Box 2.5 CRDi	D4CB Euro 4	Diesel	2497	4	8
02/08→	H-1 Cargo 2.5 CRDi	D4CB Euro 4	Diesel	2497	4	8
08/11→	H-1 Cargo 2.5 CRDi	D4CB Euro 4	Diesel	2497	4	8
05/08→	H-1 Travel 2.5 CRDi	D4CB Euro 4	Diesel	2497	4	8
07/08→	H-1 Travel 2.5 CRDi	D4CB Euro 4	Diesel	2497	4	8
08/11→	H-1 Travel 2.5 CRDi	D4CB Euro 4	Diesel	2497	4	8
10/07→11/11	i30 2.0 CRDi	D4EA	Diesel	1991	4	7
02/08→06/12	i30 CW 2.0 CRDi	D4EA	Diesel	1991	4	7
10/08→06/12	i30 CW 2.0 CRDi	D4EA	Diesel	1991	4	7
10/90→11/95	Lantra I 1.5 i.e.	G15B	Petrol	1468	4	2
12/96→09/00	Lantra II 1.5 12V	G4EK	Petrol	1495	4	4
04/97→10/00	Lantra II Wagon 1.5 12V	G4EK	Petrol	1495	4	4
10/01→08/10	Matrix 1.5 CRDi	D3EA	Diesel	1493	3	7
12/04→08/10	Matrix 1.5 CRDi	D4FA	Diesel	1493	4	1
08/05→08/10	Matrix 1.5 CRDi VGT	D4FA	Diesel	1493	4	1
06/01→08/10	Matrix 1.6	G4ED-G	Petrol	1599	4	5
01/90→01/95	Pony / Excel Saloon 1.5	G15B	Petrol	1468	4	2
01/90→01/95	Pony / Excel Saloon 1.5 i	G15B	Petrol	1468	4	2
10/85→09/89	Pony 1.5	G15B	Petrol	1468	4	2
10/89→01/95	Pony 1.5	G15B	Petrol	1468	4	2
10/89→01/95	Pony 1.5 i	G15B	Petrol	1468	4	2

Modelverzeichnis • Index de modele • Índice de Modelo
Indeks modelu • Модель автомобиля • دليل الموديل

MODEL INDEX



CCM

x



9

10/85→09/89	Pony Saloon 1.5	G15B	Petrol	1468	4	2
02/03→04/04	Porter Box 2.5 CRDi	D4CB Euro 4	Diesel	2497	4	8
05/04→	Porter Box 2.5 CRDi	D4CB Euro 4	Diesel	2497	4	8
02/03→04/04	Porter Bus 2.5 CRDi	D4CB Euro 4	Diesel	2497	4	8
02/03→04/04	Porter Pickup 2.5 CRDi	D4CB Euro 4	Diesel	2497	4	8
01/80→12/86	Porter Truck 2.4	4D55	Diesel	2346	4	9
01/85→12/86	Rosa Bus 3.3	4D31	Diesel	3298	4	12
04/92→05/96	S Coupe 1.5 i	G4EK	Petrol	1495	4	4
02/90→05/96	S Coupe 1.5 i	G15B	Petrol	1468	4	2
08/01→03/06	Santa FÉ I 2.0 CRDi	D4EA	Diesel	1991	4	7
04/01→03/06	Santa FÉ I 2.0 CRDi 4x4	D4EA	Diesel	1991	4	7
08/03→03/06	Santa FÉ I 2.0 CRDi 4x4	D4EA	Diesel	1991	4	7
11/03→02/06	Santa FÉ I 2.0 CRDi All-wheel Drive	D4EA	Diesel	1991	4	7
10/01→11/04	Sonata IV 2.0 CRDi Dynamic	D4EA	Diesel	1991	4	7
02/06→	Sonata V 2.0 CRDi	D4EA	Diesel	1991	4	7
03/09→	Sonata V 2.0 CRDi	D4EA	Diesel	1991	4	7
10/83→12/91	Stellar 1.6	G32B	Petrol	1597	4	6
10/06→	Tiburon Coupe 1.6 CVT	G4ED-G	Petrol	1599	4	5
04/01→07/08	Trajat 2.0 CRDi	D4EA	Diesel	1991	4	7
08/05→07/08	Trajat 2.0 CRDi	D4EA	Diesel	1991	4	7
01/82→09/85	Truck 3.5 ton	4D31T	Diesel	3298	4	13
01/06→03/10	Tucson 2.0 CRDi	D4EA	Diesel	1991	4	7
01/07→03/10	Tucson 2.0 CRDi	D4EA	Diesel	1991	4	7
01/09→03/10	Tucson 2.0 CRDi	D4EA	Diesel	1991	4	7
08/04→03/10	Tucson 2.0 CRDi	D4EA	Diesel	1991	4	7
01/06→03/10	Tucson 2.0 CRDi All-wheel Drive	D4EA	Diesel	1991	4	7
01/07→03/10	Tucson 2.0 CRDi All-wheel Drive	D4EA	Diesel	1991	4	7
01/09→03/10	Tucson 2.0 CRDi All-wheel Drive	D4EA	Diesel	1991	4	7
08/04→03/10	Tucson 2.0 CRDi All-wheel Drive	D4EA	Diesel	1991	4	7

Motorverzeichnis • Index de moteur • Índice de Motor
Indeks silnika • Модель двигателя • دليل المحرك

ENGINE INDEX



CCM

x



9

4D31	Diesel	3298	4	100.00	12
4D31T	Diesel	3298	4	100.00	13
4D55	Diesel	2346	4	91.10	9
4D55T	Diesel	2346	4	91.10	10
4D56T	Diesel	2477	4	91.10	10
4D56Ti	Diesel	2476	4	91.10	10
6G72	Petrol	2972	V6	91.10	11
D3EA	Diesel	1493	3	83.00	7
D4CB Euro 4	Diesel	2497	4	91.00	8
D4EA	Diesel	1991	4	83.00	7
D4FA	Diesel	1493	4	75.00	1
G4ED Euro 4	Petrol	1599	4	76.50	5
G4ED-G	Petrol	1599	4	76.50	5
G4EE Euro 4	Petrol	1399	4	75.50	3
G4EK	Petrol	1495	4	75.50	4
G15B	Petrol	1468	4	75.50	2
G32B	Petrol	1597	4	76.90	6



Accent III 1.5 CRDi GLS, Accent Saloon 1.5 CRDi GLS	11/05→11/10	D4FA	4cyl.	1
Getz 1.5 CRDi	08/05→06/09		1493cc 75kW (102PS)	
Getz 1.5 CRDi GLS	07/04→06/09	Diesel	Turbo Intercooled	
Matrix 1.5 CRDi	12/04→08/10			
Matrix 1.5 CRDi VGT	08/05→08/10			TD18229

08-849000-00	STD	75.00	1.750		001 IF NT	ST
08-849007-00	0.50mm		1.750		005 IW CR P	STD
			3.000		231 NT	ST

Lantra I 1.5 i.e., Pony / Excel Saloon 1.5, Pony / Excel Saloon 1.5 i	10/90→11/95	G15B	4cyl.	2
Pony 1.5	01/90→01/95		1468cc 53kW (72PS)	
Pony 1.5 i	10/85→01/95			
Pony Saloon 1.5	10/89→01/95			
S Coupe 1.5 i	10/85→09/89			
	02/90→05/96			TD1636

08-286700-00	STD	75.50	1.500		001 CR P	IKA
[R42150]			1.500		005 P	STD
			4.000		236 P	STD

Accent III 1.4 GL, Accent Saloon 1.4 GL	11/05→11/10	G4EE Euro 4	4cyl.	3
Getz 1.4 i	08/05→06/09		1399cc 71kW (96PS)	
				TD20722

08-849200-50	STD	75.50	1.200		001 IF CR	ST
08-849207-50	0.50mm		1.200		026 P	F12/F14
			2.000		712	ST

Accent I 1.5 i 12V	10/94→01/00	G4EK	4cyl.	4
Accent II 1.5	09/99→10/02		1495cc 66kW (89PS)	
Accent Saloon 1.5 i 12V	10/94→01/00			
Lantra II 1.5 12V	12/96→09/00			
Lantra II Wagon 1.5 12V	04/97→10/00			
S Coupe 1.5 i	04/92→05/96			TD4569

08-435400-00	STD	75.50	1.500		001 CR P	KV1
08-435407-00	0.50mm		1.500		005 P	GOE13
			3.000		712 CR	ST



Accent III 1.6 GLS, Accent Saloon 1.6 GLS		11/05→11/10	G4ED Euro 4		4cyl. 1599cc 77-82kW (105-112PS)		5
TD20721							

Accent II 1.6, Accent Saloon 1.6		12/02→11/05	G4ED-G		4cyl. 1599cc 76-79kW (103-107PS)		TD16146
Coupe 1.6 16V		03/02→08/09					
Elantra 1.6, Elantra Saloon 1.6		06/00→07/06					
Getz 1.6		09/02→06/09					
Matrix 1.6		06/01→08/10					
Tiburon Coupe 1.6 CVVT		10/06→					

08-848300-50	STD	76.50	1.200		001 IF CR	ST
08-848307-50	0.50mm		1.200		026 P	GOE13
			2.000		712 NT	ST

Stellar 1.6		10/83→12/91	G32B		4cyl. 1597cc 55-74kW (75-101PS)		6
TD1637							

08-285400-00	STD	76.90	2.000		001 CR P	STD
[R27416K]			2.000		026 P	STD
			4.000		712 CR	ST

Accent II 1.5 CRDi		04/02→11/05	D3EA		3cyl. 1493cc 60kW (81PS)		7
Accent Saloon 1.5 CRDi		01/02→11/05					
Getz 1.5 CRDi		03/03→09/05					
Matrix 1.5 CRDi		10/01→08/10	Diesel		Turbo Intercooled		
TD16283							

Elantra 2.0 CRDi, Elantra Saloon 2.0 CRDi		04/01→07/06	D4EA		4cyl. 1991cc 83kW (113PS)		TD16321
i30 2.0 CRDi		10/07→11/11					
i30 CW 2.0 CRDi		02/08→06/12					
Santa FÉ I 2.0 CRDi		08/01→03/06	Diesel		Turbo Intercooled		
Santa FÉ I 2.0 CRDi 4x4		04/01→03/06					
Santa FÉ I 2.0 CRDi All-wheel Drive		11/03→02/06					
Sonata IV 2.0 CRDi Dynamic		10/01→11/04					
Sonata V 2.0 CRDi		02/06→					
Trajet 2.0 CRDi		04/01→07/08					
Tucson 2.0 CRDi,		08/04→03/10					
Tucson 2.0 CRDi All-wheel Drive							

08-431900-00	STD	83.00	1.950		008 CK	ST
08-431907-00	0.50mm		2.000		005 CR P	STD
			3.000		231 NT	ST



H-1 / Starex 2.5 CRDi		12/02→12/07	D4CB Euro 4		8
H-1 / Starex 2.5 CRDi 4WD		12/02→04/04	4cyl.		
H-1 Box 2.5 CRDi		07/01→04/04	2497cc 103-125kW (140-170PS)		
H-1 Cargo 2.5 CRDi		02/08→	Diesel Turbo Intercooled		
H-1 Travel 2.5 CRDi		05/08→			
Porter Box 2.5 CRDi		02/03→			
Porter Bus 2.5 CRDi,		02/03→04/04			TD21021
Porter Pickup 2.5 CRDi					

08-431700-00	STD	91.00	2.500		007 CK P	KV4
08-431707-00	0.50mm		2.000		001 IW CR P	GOE13
			3.000		231 NT	ST

Galopper Jeep 2.4, Grace 2.4 Van 1 ton, Porter Truck 2.4		01/80→12/86	4D55		9
			4cyl.		
			2346cc		
			Diesel		FM3377

08-288000-00	STD	91.10	2.500		001 MO P	KV1
[R43660]			2.000		005 CR P	STD
			4.000		231 CR P	STD
08-521200-00	STD	91.10	2.000		001	KV1
08-521207-00	0.50mm		2.000		005 CR	STD
[R44110]			4.000		231 CR	STD

Galopper 2.4			4D55T		10
			4cyl.		
			2346cc 49kW (67PS)		
			Diesel Turbo Intercooled		FM3828

Galopper I 2.5 TD, Galopper I 2.5 TD intercooler		08/91→07/98	4D56T		TD18860
			4cyl.		
			2477cc 62-70kW (84-95PS)		
			Diesel Turbo Intercooled		

Galopper 2.5		01/96→	4D56Ti		FM15062
			4cyl.		
			2476cc 73kW (99PS)		
			Diesel Turbo Intercooled		

08-287100-00	STD	91.10	2.500		007 IFU MO P	KV1
08-287107-00	0.50mm		2.000		011 IFU CR P	STD
[R42640]			4.000		231 CR P	STD

Galopper I 3.0 V6		08/91→07/98	6G72		11
			V6cyl.		
			2972cc 104kW (141PS)		
					TD18862

08-287600-00	STD	91.10	1.500		001 CR P	IKA
			1.500		005 P	STD
			4.000		236 P	STD



Canter 3.3			01/87→	4D31				
Rosa Bus 3.3			01/85→12/86		4cyl.			12
					3298cc			
					Diesel			FM19502

08-288200-00	STD	100.00	3.000		007 CR P		KV1
[R42660]			2.000		005 P		STD
			5.000		231 CR P		STD

Truck 3.5 ton			01/82→09/85	4D31T				
					4cyl.			13
					3298cc			
					Diesel	Turbo		FM9515

08-520400-00	STD	100.00	3.000		007 CR P		KV1
[R45310]			2.000		005 P		STD
			4.000		231 CR P		GOE13



4VD14.5						4cyl.		6600cc	Diesel		1		
											FM6397		
08-245300-00	STD	120.00	3.500		001 CR P	STD							
08-245311-00	1.00mm						3.500		005 P	STD			
							5.000		231 CR P	STD			
08-246900-00	STD	120.00	3.000		001 CR P	STD							
08-246907-00	0.50mm						3.000		005 P	STD			
08-246911-00	1.00mm						5.000		231 CR	STD			

6VD13.5						6cyl.		9200cc	Diesel		2		
											FM6398		
08-246900-00	STD	120.00	3.000		001 CR P	STD							
08-246907-00	0.50mm						3.000		005 P	STD			
08-246911-00	1.00mm						5.000		231 CR	STD			

Motorverzeichnis • Index de moteur • Índice de Motor
Indeks silnika • Модель двигателя • دليل المحرك

ENGINE INDEX



CCM

x







9



Model	Fuel Type	CCM	x	Value	Value
D-155	Diesel	2540	3	98.42	2
D-179	Diesel	2930	3	98.42	3
D-206	Diesel	3380	4	98.42	2
D-239	Diesel	3915	4	98.42	3
D-246	Diesel	4025	4	100.00	4
D-268	Diesel	4389	4	100.00	5
D-310	Diesel	5070	6	98.42	2
D-358	Diesel	5863	6	98.42	3
DD-74	Diesel	1217	2	87.31	1
DD-111	Diesel	1825	3	87.31	1
DD-148	Diesel	2434	4	87.31	1
DT-466	Diesel	466	6	109.23	6
DT-466C	Diesel	466	6	109.23	6
DTI-466B	Diesel	466	6	109.23	6
DU-11	Diesel	1825	3	87.31	1
DU-148	Diesel	2434	4	87.31	1
DU-155	Diesel	2540	3	98.42	3
UD-206	Diesel	3380	4	98.42	3





1

DD-111		3cyl.	1825cc	17-19kW (24-26PS)	Diesel	FM6400
DD-148		4cyl.	2434cc	27kW (37PS)	Diesel	FM6401
DD-74		2cyl.	1217cc	12-14kW (17-19PS)	Diesel	FM6399
DU-11		3cyl.	1825cc	26kW (35PS)	Diesel	FM16400
DU-148		4cyl.	2434cc	28kW (38PS)	Diesel	FM16401
08-241300-00	STD	87.31	2.385		001 IW CR P	STD
			2.385		023 P	STD
			2.385		023 P	STD
			4.747		032 P	STD
			4.747		032 P	STD



2

D-155		3cyl.	2540cc	27-36kW (37-49PS)	Diesel	TD18801
D-206		4cyl.	3380cc	40-44kW (54-60PS)	Diesel	TD18803
D-310		6cyl.	5070cc	62-68kW (84-92PS)	Diesel	TD18806
08-243300-00	STD	98.42	3.160		001 IF CR P	KV1
[R38520]			2.385		005 IF P	STD
			4.747		231 CR P	STD

3



D-179		3cyl.	2930cc	36-38kW (49-52PS)	Diesel	TD18802
D-239		4cyl.	3915cc	45-56kW (61-76PS)	Diesel	TD18804
D-358		6cyl.	5863cc	74-101kW (101-137PS)	Diesel	TD18807
DU-155		3cyl.	2540cc	32-33kW (43-45PS)	Diesel	FM16402
UD-206		4cyl.	3380cc		Diesel	FM16404
08-243600-00	STD	98.42	3.160		008 IF CR P	KV1
[R31560/2K]			2.385		005 IF P	STD
			4.747		231 CR P	STD

4



D-246		4cyl.	4025cc	54-60kW (73-82PS)	Diesel	TD18805
08-243400-00	STD	100.00	3.160		001 IF CR P	KV1
			2.385		005 IW	STD
			4.747		231 CR P	STD



5

D-268		4cyl.	4389cc	57-63kW (78-86PS)	Diesel	TD18811
08-244800-00	STD	100.00	3.160		008 CR P	KV1
			2.385		005 IW CR P	STD
			4.747		231 CR P	STD

6

DT-466		6cyl.	466cc		Diesel Turbo	FM7322
DT-466C		6cyl.	466cc		Diesel Turbo	FM7325
DTI-466B		6cyl.	466cc		Diesel Turbo Intercooled	FM7324
08-244600-00	STD	109.23	3.160		008 CR P	
			3.160		009 CR P	STD
			6.335		231 CR P	STD

ENGINE INDEX

Motorverzeichnis • Index de moteur • Índice de Motor
Indeks silnika • Модель двигателя • دليل المحرك



CCM

x



9

Engine Model	Fuel Type	CCM	Stroke	Power (kW)	Speed (rpm)
3TF120T	Diesel	3	92.00	6	
3TNE63-N	Diesel	3	83.00	2	
3TS86-K	Diesel	3	86.00	5	
4TN100-M	Diesel	4	100.00	7	
4TNE62-S	Diesel	4	62.00	1	
1610	Diesel	2	85.00	3	
1700	Diesel	2	86.00	4	



1

4TNE62-S		4cyl.		Diesel		FM6406
08-960100-00	STD	62.00	1.500		001 CR P	IKA
[R48510]	1.500			005 P	STD	
	2.800			236 P	STD	

2

3TNE63-N		3cyl.		Diesel		FM6407
08-292800-00	STD	83.00	2.500		001 IF CR P	KV1
[R39150]	2.000			005 IF	STD	
	2.000			005 IF	STD	
	4.500			231 CR P	STD	
	4.500			031	STD	

3

1610		2cyl.		Diesel		FM6408
08-295400-00	STD	85.00	2.000		001 IF CR P	KV1
[R42720]	2.000			005 IF P	STD	
	4.000			231 CR P	STD	

4

1700		2cyl.		Diesel		FM6409
08-247200-00 ¹	STD	86.00	2.000		001 CR P	KV1
08-247207-00	0.50mm		2.000		005 P	STD
08-247211-00	1.00mm		2.000		005 P	STD
			5.000		231 CR P	STD

¹ For Cast Iron Bores only

¹ Nur für Gußeisenbohrungen

¹ Pour intérieur cylindre seulement

¹ Para diámetro internos de hierro fundido solamente

5

3TS86-K		3cyl.		Diesel		FM6410
08-283600-00	STD	86.00	2.000		001 CR P	KV1
08-283607-00	0.50mm		2.000		005 IW P	STD
08-283611-00	1.00mm		4.000		231 CR P	STD
[R42580]						



						6
3TF120T		3cyl.	Diesel			FM6411
08-373800-00	STD	92.00	2.000		007 CR P	KV1
[R42780]	2.000			005 P	STD	
	4.000			231 CR P	STD	

						7
4TN100-M		4cyl.	Diesel			FM6412
08-288200-00	STD	100.00	3.000		007 CR P	KV1
[R42660]	2.000			005 P	STD	
	5.000			231 CR P	STD	



CCM

x



9

04/83→06/89	Aska 2.0 D	4FC1	Diesel	1995	4	3
01/81→12/86	Campo 2.0 D	C190	Diesel	1951	4	4
01/83→12/91	Campo 2.2 D	C 223	Diesel	2238	4	6
01/83→12/90	Campo 2.2 D 4WD	C 223	Diesel	2238	4	6
01/83→12/90	Campo 2.5 D	4JA1	Diesel	2499	4	7
01/83→12/90	Campo 2.5 D 4WD	4JA1	Diesel	2499	4	7
01/74→10/88	Elf	G161	Petrol	1584	4	2
01/74→10/88	Elf	G161Z	Petrol	1584	4	2
01/71→12/88	Elf 150 200'0	C190	Diesel	1951	4	4
01/71→12/88	Elf 150 2000	C190	Diesel	1951	4	4
12/78→07/84	Elf 150 2400	C 240	Diesel	2369	4	4
07/75→06/84	Elf 250 2400	C 240	Diesel	2369	4	4
10/85→09/03	Elf Box 2.8 D	4JB1	Diesel	2771	4	7
10/85→09/92	Elf Box 2.8 TD	4JB1-T	Diesel	2772	4	7
10/85→09/92	Elf Platform/Chassis 2.8 TD	4JB1-T	Diesel	2772	4	7
10/85→09/03	Elf Platform/Chassis 2.8 D N-Serie NHR 55 E	4JB1	Diesel	2771	4	7
01/79→	Elf Truck	4BD1	Diesel	3856	4	8
01/83→01/88	Fargo Bus 2.2 D 4WD	4FD1	Diesel	2189	4	5
01/71→12/88	Fastar 2.0 D	C190	Diesel	1951	4	4
01/71→12/88	Florian 2.00	C190	Diesel	1951	4	4
01/74→10/88	Gemini	G161	Petrol	1584	4	2
01/74→10/88	Gemini	G161Z	Petrol	1584	4	2
02/88→12/90	Gemini 1.5 D	4EC1	Diesel	1488	4	1
02/88→12/90	Gemini 1.5 TD	4EC1T	Diesel	1488	4	1
01/71→12/88	Gemini 2.0 D	C190	Diesel	1951	4	4
06/74→12/90	Gemini Saloon 1.5 D	4EC1	Diesel	1488	4	1
02/88→12/90	Gemini Saloon 1.5 TD	4EC1T	Diesel	1488	4	1
01/71→12/83	Journey 2.0 D	C190	Diesel	1951	4	4
12/78→06/81	Micro Bus 2400	C 240	Diesel	2369	4	4
01/89→	Midi Box 2.2 D	4FD1	Diesel	2189	4	5
09/88→	Midi Box 2.2 D 4WD	4FD1	Diesel	2189	4	5
01/89→	Midi Bus 2.2 D	4FD1	Diesel	2189	4	5
01/89→	Midi Bus 2.2 D 4WD	4FD1	Diesel	2189	4	5
01/89→	Midi Van 2.2 D	4FD1	Diesel	2189	4	5
01/89→	Midi Van 2.2 D 4WD	4FD1	Diesel	2189	4	5
08/79→07/82	Pick Up 1.8	4FB1	Diesel	1817	4	3
09/91→08/99	TFR/TFS Pickup 2.8 D	4JB1	Diesel	2771	4	7
09/91→08/99	TFR/TFS Pickup 2.8 D All-wheel Drive	4JB1	Diesel	2771	4	7
06/69→06/85	TLO 13	C 240	Diesel	2369	4	4
06/70→06/79	TLO 23	C 240	Diesel	2369	4	4
05/84→12/89	Trooper 2.2 D 4x4	C 223	Diesel	2238	4	6
10/87→12/91	Trooper 2.8 TD	4JB1-T	Diesel	2772	4	7
05/84→07/89	Trooper Open Off-Road Vehicle 2.2 D 4x4	C 223	Diesel	2238	4	6
07/75→	Truck / Bus	6BD1	Diesel	5785	6	8
01/79→	Truck / Bus	6BD1T	Diesel	5785	6	8

ENGINE INDEX

Motorverzeichnis • Index de moteur • Índice de Motor
Indeks silnika • Модель двигателя • دليل المحرك



CCM

x



9

4BD1	Diesel	3856	4	102.00	8
4EC1	Diesel	1488	4	76.00	1
4EC1T	Diesel	1488	4	76.00	1
4FB1	Diesel	1817	4	84.00	3
4FC1	Diesel	1995	4	84.00	3
4FD1	Diesel	2189	4	88.00	5
4JA1	Diesel	2499	4	93.00	7
4JB1	Diesel	2771	4	93.00	7
4JB1-T	Diesel	2772	4	93.00	7
6BD1	Diesel	5785	6	102.00	8
6BD1T	Diesel	5785	6	102.00	8
C 223	Diesel	2238	4	88.00	6
C 240	Diesel	2369	4	86.00	4
C190	Diesel	1951	4	86.00	4
G161	Petrol	1584	4	82.00	2
G161Z	Petrol	1584	4	82.00	2



Gemini 1.5 D			02/88→12/90	4EC1					1
Gemini Saloon 1.5 D			06/74→12/90		4cyl.				
					1488cc	37kW (50PS)			
				Diesel					TD4575
Gemini 1.5 TD, Gemini Saloon 1.5 TD			02/88→12/90	4EC1T					
					4cyl.				
					1488cc	49-54kW (67-73PS)			
				Diesel	Turbo				TD4576
08-307000-00	STD	76.00	2.000		001 CR P				KV1
08-307007-00	0.50mm				005 P				STD
08-307011-00	1.00mm		1.500		231 CR P				STD
<i>[R43910]</i>			3.000						
Elf, Gemini			01/74→10/88	G161					2
					4cyl.				
					1584cc	59kW (80PS)			
									TD1688
Elf, Gemini			01/74→10/88	G161Z					
					4cyl.				
					1584cc	74kW (100PS)			
									TD1689
08-247000-00	STD	82.00	2.000		001 CR P				STD
			2.000		026 P				STD
			4.000		712 CR				ST
Pick Up 1.8			08/79→07/82	4FB1					3
					4cyl.				
					1817cc	41-45kW (56-61PS)			
				Diesel					TD22269
Aska 2.0 D			04/83→06/89	4FC1					
					4cyl.				
					1995cc	49-54kW (66-73PS)			
				Diesel					TD1664
08-245400-00	STD	84.00	2.500		001 CR P				KV1
<i>[R41860]</i>			2.000		005 CR P				STD
			4.000		231 CR P				STD



Elf 150 2400	12/78→07/84	C 240				4
Elf 250 2400	07/75→06/84		4cyl.			
Micro Bus 2400	12/78→06/81		2369cc	44-55kW (60-75PS)		
TLO 13	06/69→06/85	Diesel				
TLO 23	06/70→06/79					TD26269

Campo 2.0 D	01/81→12/86	C190				
Elf 150 2000, Elf 150 200'0, Fastar 2.0 D,	01/71→12/88		4cyl.			
Florian 2.00, Gemini 2.0 D			1951cc	40kW (54PS)		
Journey 2.0 D	01/71→12/83	Diesel				TD1685

08-247200-00 ¹	STD	86.00	2.000		001 CR P	KV1
08-247207-00	0.50mm				005 P	STD
08-247211-00	1.00mm		2.000		005 P	STD
			2.000		231 CR P	STD
			5.000			
08-247200-10	STD	86.00	2.000		001	STD
[R40320]			2.000		023	STD
			2.000		023	STD
			5.000		231	STD
08-247300-00 ¹	STD	86.00	2.500		001 CR P	KV1
01/1982→			2.000		005 P	STD
[R41530]			5.000		231 CR P	STD

¹ For Cast Iron Bores only

¹ Nur für Gußeisenbohrungen

¹ Pour intérieur cylindre seulement

¹ Para diámetro internos de hierro fundido solamente

Fargo Bus 2.2 D 4WD	01/83→01/88	4FD1				5
Midi Box 2.2 D	01/89→		4cyl.			
Midi Box 2.2 D 4WD	09/88→		2189cc	45-54kW (61-73PS)		
Midi Bus 2.2 D, Midi Bus 2.2 D 4WD,	01/89→	Diesel				
Midi Van 2.2 D, Midi Van 2.2 D 4WD						TD1667

08-247600-00	STD	88.00	2.000		001 P	IKA
[R42520]			2.000		005 P	STD
			4.000		236 P	STD

Campo 2.2 D	01/83→12/91	C 223				6
Campo 2.2 D 4WD	01/83→12/90		4cyl.			
Trooper 2.2 D 4x4	05/84→12/89		2238cc	39kW (53PS)		
Trooper Open Off-Road Vehicle 2.2 D 4x4	05/84→07/89	Diesel				
						TD1686

08-247600-00	STD	88.00	2.000		001 P	IKA
12/1983→			2.000		005 P	STD
[R42520]			4.000		236 P	STD



Campo 2.5 D, Campo 2.5 D 4WD	01/83→12/90	4JA1	4cyl. 2499cc	50-56kW (68-76PS)	7
		Diesel			TD1668
Elf Box 2.8 D, Elf Platform/Chassis 2.8 D	10/85→09/03	4JB1	4cyl. 2771cc	50-74kW (68-101PS)	
N-Serie NHR 55 E	09/91→08/99				
TFR/TFS Pickup 2.8 D, TFR/ TFS Pickup 2.8 D All-wheel Drive		Diesel			TD1670
Elf Box 2.8 TD, Elf Platform/ Chassis 2.8 TD	10/85→09/92	4JB1-T	4cyl. 2772cc	64-74kW (87-101PS)	
Trooper 2.8 TD	10/87→12/91		Turbo		TD1671

08-246200-00 STD	93.00	2.000		001 P	STD
01/1992→		2.000		026 P	STD
		4.000		231 P	STD
08-248000-00 ① STD	93.00	2.000		001 CR P	KV1
01/1984→		2.000		005 P	STD
		4.000		231 CR P	STD
08-248000-10 ② STD	93.00	2.000		001	KV1
[R43680]		2.000		026	STD
		4.000		231	STD

① Not for chromed cylinders ① Nicht für verchromte Zylinder ① Non appropriés pour cylindres chromés ① No se usan para cilindros cromados
 ② Ringset only for AE/Nural piston ② Ringsätze Ringset nur für AE/Nüral Kolben ② Ringset seulement pour le piston d'AE/Nural ② Ringset solamente para el pistón de AE/Nural

Elf Truck	01/79→	4BD1	4cyl. 3856cc	78kW (106PS)	8
		Diesel			TD1660
Truck / Bus	07/75→	6BD1	6cyl. 5785cc	110kW (150PS)	
		Diesel			TD7208
Truck / Bus	01/79→	6BD1T	6cyl. 5785cc	132kW (180PS)	
		Diesel	Turbo		TD7209

08-522500-00 STD	102.00	3.000		001 P	STD
[R42550]		2.500		026 P	STD
		5.000		236 P	STD

ENGINE INDEX

Motorverzeichnis • Index de moteur • Índice de Motor
Indeks silnika • Модель двигателя • دليل المحرك



CCM



9

203 A/61	Diesel	11548	6	130.00	45
203 H	Diesel	10676	6	125.00	38
203 H 61	Diesel	11548	6	130.00	45
203.000	Diesel	10676	6	125.00	38
213 H	Diesel	4678	6	95.00	12
213.000	Diesel	4678	6	95.00	12
230 A.000	Diesel	2693	4	95.00	12
310 H/61	Diesel	11548	6	130.00	45
604.03/31/34/35/41	Diesel	6872	4	125.00	38
615.000	Diesel	2270	4	85.00	2
803 A.062 (8030.01)	Diesel	2339	3	95.00	12
804A (8040.01)	Diesel	3119	4	95.00	12
806 A (8060.01/.11)	Diesel	4678	6	95.00	12
8025.01	Diesel	1559	2	95.00	12
8025.02	Diesel	1728	2	100.00	14
8030.02	Diesel	2592	3	100.00	14
8035.02	Diesel	2592	3	100.00	14
8035.04	Diesel	2748	3	103.00	20
8035.05	Diesel	2930	3	104.00	22
8035.06	Diesel	2708	3	100.00	15
8035.06.200	Diesel	2708	3	100.00	16
8035.06.206	Diesel	2708	3	100.00	16
8035.06.208	Diesel	2708	3	100.00	16
8035.06.216	Diesel	2708	3	100.00	16
8035.06.220	Diesel	2708	3	100.00	16
8035.06.222	Diesel	2708	3	100.00	16
8035.06.223	Diesel	2708	3	100.00	16
8035.06.306	Diesel	2708	3	100.00	16
8035.06.307	Diesel	2708	3	100.00	16
8035.06.308	Diesel	2708	3	100.00	16
8035.06.309	Diesel	2708	3	100.00	16
8035.06.317	Diesel	2708	3	100.00	16
8035.06.320	Diesel	2708	3	100.00	16
8035.06.321	Diesel	2708	3	100.00	16
8035.06.322	Diesel	2708	3	100.00	16
8035.06.323	Diesel	2708	3	100.00	16
8035.42	Diesel	2748	3	103.00	20
8040.02	Diesel	3455	4	100.00	17
8040.02	Diesel	3456	4	100.00	17
8040.02.041	Diesel	3456	4	100.00	17
8040.02.267	Diesel	3456	4	100.00	17
8040.02.300	Diesel	3455	4	100.00	17
8040.02.360	Diesel	3456	4	100.00	17
8040.02.367	Diesel	3456	4	100.00	17
8040.04.200	Diesel	3666	4	103.00	20
8040.05.200	Diesel	3908	4	104.00	22
8040.05.203	Diesel	3908	4	104.00	22
8040.05.230	Diesel	3908	4	104.00	22
8040.05.233	Diesel	3908	4	104.00	22
8040.05.235	Diesel	3908	4	104.00	22
8040.05.4990	Diesel	3908	4	104.00	23
8040.25 B.4200	Diesel	3908	4	104.00	23
8040.25.000	Diesel	3908	4	104.00	24
8040.25.200	Diesel	3908	4	104.00	24
8040.25.220	Diesel	3908	4	104.00	24
8040.25.230	Diesel	3908	4	104.00	24
8040.25.4990	Diesel	3908	4	104.00	23
8040.25X.4000	Diesel	3908	4	104.00	23
8040.45.400	Diesel	3908	4	104.00	23
8040.45.5200 Euro 2	Diesel	3908	4	104.00	23



CCM

x



9

8040.45D.5100 Euro 2	Diesel	3908	4	104.00	23
8040.45X.4180	Diesel	3908	4	104.00	23
8041 L	Diesel	3666	4	103.00	21
8045.02	Diesel	3455	4	100.00	14
8045.04	Diesel	3666	4	103.00	20
8045.05	Diesel	3908	4	104.00	22
8045.06	Diesel	3613	4	100.00	15
8045.06.200	Diesel	3613	4	100.00	16
8045.06.208	Diesel	3613	4	100.00	16
8045.06.213	Diesel	3613	4	100.00	16
8045.06.214	Diesel	3613	4	100.00	16
8045.06.215	Diesel	3613	4	100.00	16
8045.06.225	Diesel	3613	4	100.00	16
8045.06.319	Diesel	3613	4	100.00	16
8045.06.326	Diesel	3613	4	100.00	16
8055.04	Diesel	4583	5	103.00	20
8060.02.000	Diesel	5184	6	100.00	14
8060.02.001	Diesel	5184	6	100.00	14
8060.02.003	Diesel	5184	6	100.00	14
8060.02.070	Diesel	5184	6	100.00	14
8060.04	Diesel	5499	6	103.00	20
8060.04.000	Diesel	5499	6	103.00	20
8060.04.055	Diesel	5499	6	103.00	20
8060.04.060	Diesel	5499	6	103.00	20
8060.04.070	Diesel	5499	6	103.00	20
8060.04.620	Diesel	5499	6	103.00	20
8060.04.621	Diesel	5499	6	103.00	20
8060.04.630	Diesel	5499	6	103.00	20
8060.04.639	Diesel	5499	6	103.00	20
8060.04.658	Diesel	5499	6	103.00	20
8060.04.660	Diesel	5499	6	103.00	20
8060.04.669	Diesel	5499	6	103.00	20
8060.04.670	Diesel	5499	6	103.00	20
8060.04.672	Diesel	5499	6	103.00	20
8060.04.675	Diesel	5499	6	103.00	20
8060.04.689	Diesel	5499	6	103.00	20
8060.05	Diesel	5861	6	104.00	22
8060.05.000	Diesel	5861	6	104.00	22
8060.05.200	Diesel	5861	6	104.00	22
8060.05.200	Diesel	5868	6	104.00	22
8060.05.246	Diesel	5861	6	104.00	22
8060.05.246	Diesel	5868	6	104.00	22
8060.05.270	Diesel	5861	6	104.00	22
8060.05.280	Diesel	5861	6	104.00	22
8060.05.285	Diesel	5861	6	104.00	22
8060.05.289	Diesel	5861	6	104.00	22
8060.24.601	Diesel	5499	6	103.00	21
8060.24.643	Diesel	5499	6	103.00	21
8060.24.652	Diesel	5499	6	103.00	21
8060.24.661	Diesel	5499	6	103.00	21
8060.24.662	Diesel	5499	6	103.00	21
8060.24.664	Diesel	5499	6	103.00	21
8060.24.670	Diesel	5499	6	103.00	21
8060.24.671	Diesel	5499	6	103.00	21
8060.24.673	Diesel	5499	6	103.00	21
8060.24.678	Diesel	5499	6	103.00	21
8060.25.600	Diesel	5861	6	104.00	24
8060.25.621	Diesel	5861	6	104.00	24
8060.25.630	Diesel	5861	6	104.00	24
8060.25.631	Diesel	5861	6	104.00	24

ENGINE INDEX

Motorverzeichnis • Index de moteur • Índice de Motor
 Indeks silnika • Модель двигателя • دليل المحرك

CCM

9

8060.25.641	Diesel	5861	6	104.00	24
8060.25.662	Diesel	5861	6	104.00	24
8060.25.663	Diesel	5861	6	104.00	24
8060.25.669	Diesel	5861	6	104.00	24
8060.25.670	Diesel	5861	6	104.00	24
8060.25.673	Diesel	5861	6	104.00	24
8060.25.678	Diesel	5861	6	104.00	24
8060.25.679	Diesel	5861	6	104.00	24
8060.25R.4200	Diesel	5861	6	104.00	23
8060.25R.4300	Diesel	5861	6	104.00	23
8060.25R.4280	Diesel	5861	6	104.00	23
8060.25V.4000	Diesel	5868	6	104.00	23
8060.25V.4080	Diesel	5861	6	104.00	23
8060.25V.4800	Diesel	5861	6	104.00	23
8060.45.4100	Diesel	5861	6	104.00	23
8060.45.4700	Diesel	5861	6	104.00	23
8060.45B.5100 Euro 2	Diesel	5861	6	104.00	23
8060.45R.5000	Diesel	5861	6	104.00	23
8060.45R.5001	Diesel	5861	6	104.00	23
8060.45R.5003	Diesel	5861	6	104.00	23
8060.45R.5050	Diesel	5861	6	104.00	23
8061 L	Diesel	5499	6	103.00	21
8061.05	Diesel	5861	6	104.00	22
8061.25	Diesel	5868	6	104.00	24
8062.24.070	Diesel	5499	6	103.00	21
8065.02.007	Diesel	5184	6	100.00	14
8065.02.200	Diesel	5184	6	100.00	14
8065.02.207	Diesel	5184	6	100.00	14
8065.02.217	Diesel	5184	6	100.00	14
8065.04	Diesel	5499	6	103.00	20
8065.04-H	Diesel	5499	6	103.00	20
8065.25	Diesel	5863	6	104.00	24
8065.25.080	Diesel	5863	6	104.00	24
8065.45	Diesel	5862	6	104.00	24
8065.E	Diesel	5861	6	104.00	22
8140.07.2585 Euro 1	Diesel	2499	4	93.00	4
8140.07.2700	Diesel	2499	4	93.00	4
8140.07.2701	Diesel	2499	4	93.00	4
8140.07.3700 Euro 1	Diesel	2499	4	93.00	4
8140.07.3710	Diesel	2499	4	93.00	4
8140.21	Diesel	2445	4	93.00	5
8140.21.200	Diesel	2445	4	93.00	5
8140.21.214 (Sofim)	Diesel	2445	4	93.00	5
8140.23.	Diesel	2798	4	94.40	9
8140.23.2585 (Sofim)	Diesel	2799	4	94.40	9
8140.23.3700 (Sofim)	Diesel	2799	4	94.40	9
8140.27.210, 8140.27.213	Diesel	2445	4	93.00	5
8140.27.2100	Diesel	2500	4	93.00	5
8140.27.218	Diesel	2499	4	93.00	5
8140.27.2582	Diesel	2499	4	93.00	5
8140.27.2700	Diesel	2499	4	93.00	5
8140.27.2720	Diesel	2499	4	93.00	5
8140.27.2811	Diesel	2499	4	93.00	5
8140.27R.2700	Diesel	2499	4	93.00	5
8140.27S.2700 (Sofim)	Diesel	2499	4	93.00	5
8140.27S.2801 (Sofim)	Diesel	2499	4	93.00	5
8140.27S.2885 (Sofim)	Diesel	2499	4	93.00	5
8140.27S.3700 Euro 1	Diesel	2499	4	93.00	6
8140.43 Euro 2	Diesel	2798	4	94.40	9
8140.43.2585 Euro 2 (Sofim)	Diesel	2798	4	94.40	9



CCM



9

8140.43.3700 (Sofim)	Diesel	2799	4	94.40	9
8140.43.3900 Euro 2	Diesel	2798	4	94.40	9
8140.43B Euro 3	Diesel	2798	4	94.40	10
8140.43B.4300 Euro 3	Diesel	2798	4	94.40	10
8140.43B.4305 Euro 3	Diesel	2798	4	94.40	10
8140.43B.4320 Euro 3	Diesel	2798	4	94.40	10
8140.43B.4325 Euro 3	Diesel	2798	4	94.40	10
8140.43B.4330 Euro 3	Diesel	2798	4	94.40	10
8140.43B.4335 Euro 3	Diesel	2798	4	94.40	10
8140.43C Euro 2	Diesel	2798	4	94.40	9
8140.43N Euro 3	Diesel	2798	4	94.40	10
8140.43N.4300 Euro 3	Diesel	2798	4	94.40	10
8140.43N.4320 Euro 3	Diesel	2798	4	94.40	10
8140.43N.4330 Euro 3	Diesel	2798	4	94.40	10
8140.43N.4400 Euro 3	Diesel	2798	4	94.40	10
8140.43N.4430 Euro 3	Diesel	2798	4	94.40	10
8140.43S Euro 3	Diesel	2798	4	94.40	10
8140.43S.4000 Euro 3	Diesel	2798	4	94.40	10
8140.43S.4020 Euro 3	Diesel	2798	4	94.40	10
8140.43S.4030 Euro 3	Diesel	2798	4	94.40	10
8140.43S.4140 Euro 3	Diesel	2798	4	94.40	10
8140.43S.4300 Euro 3	Diesel	2798	4	94.40	10
8140.43S.4320 Euro 3	Diesel	2798	4	94.40	10
8140.43S.4330 Euro 3	Diesel	2798	4	94.40	10
8140.43S.4400 Euro 3	Diesel	2798	4	94.40	10
8140.43S.4420 Euro 3	Diesel	2798	4	94.40	10
8140.43S.4430 Euro 3	Diesel	2798	4	94.40	10
8140.47 R	Diesel	2499	4	93.00	6
8140.47.2700 Euro 1	Diesel	2499	4	93.00	6
8140.47.2711 Euro 1	Diesel	2499	4	93.00	6
8140.47.2721 Euro 1	Diesel	2499	4	93.00	6
8140.47.2785 Euro 1	Diesel	2499	4	93.00	6
8140.47.3700	Diesel	2499	4	93.00	6
8140.47R.2210	Diesel	2499	4	93.00	6
8140.47R.2790	Diesel	2499	4	93.00	6
8140.47S Euro 1	Diesel	2499	4	93.00	6
8140.61.200	Diesel	2445	4	93.00	7
8140.61.300	Diesel	2445	4	93.00	7
8140.63. Euro 2	Diesel	2798	4	94.40	11
8140.63.4000 (Sofim)	Diesel	2798	4	94.40	11
8140.67, 8144.67	Diesel	2500	4	93.00	8
8140.67.2585 Euro 2	Diesel	2499	4	93.00	4
8140.67.2700	Diesel	2499	4	93.00	4
8140.67F. Euro 2	Diesel	2449	4	93.00	4
8140.67F.3700 Euro 2	Diesel	2449	4	93.00	4
8140.67F.3701 Euro 2	Diesel	2499	4	93.00	4
8140.67F.3710 Euro 2	Diesel	2499	4	93.00	4
8140.67F.3711 Euro 2	Diesel	2499	4	93.00	4
8140.67F.3713 Euro 2	Diesel	2499	4	93.00	4
8140.67F.3721 Euro 2	Diesel	2499	4	93.00	4
8140.97.2781	Diesel	2499	4	93.00	5
8140.97.2783	Diesel	2499	4	93.00	5
8142.61	Diesel	2445	4	93.00	7
8144.61.200	Diesel	2445	4	93.00	7
8144.67.220	Diesel	2499	4	93.00	8
8200.02	Diesel	9820	6	122.00	37
8200.02.220	Diesel	9820	6	122.00	37
8200.03	Diesel	10308	6	125.00	39
8200.12	Diesel	9820	6	122.00	37
8200.12.000	Diesel	9820	6	122.00	37

ENGINE INDEX

Motorverzeichnis • Index de moteur • Índice de Motor
Indeks silnika • Модель двигателя • دليل المحرك



CCM



9

8200.12.004	Diesel	9820	6	122.00	37
8200.13	Diesel	10308	6	125.00	39
8205.02	Diesel	9820	6	122.00	37
8210.02	Diesel	13798	6	137.00	48
8210.02.000	Diesel	13798	6	137.00	48
8210.02.020	Diesel	13798	6	137.00	48
8210.02.022	Diesel	13798	6	137.00	48
8210.02.032	Diesel	13798	6	137.00	48
8210.02.053	Diesel	13798	6	137.00	48
8210.02.067	Diesel	13798	6	137.00	48
8210.02.069	Diesel	13798	6	137.00	48
8210.02.081	Diesel	13798	6	137.00	48
8210.02.266	Diesel	13798	6	137.00	48
8210.02.267	Diesel	13798	6	137.00	48
8210.02.371	Diesel	13798	6	137.00	48
8210.02.373	Diesel	13798	6	137.00	48
8210.02.377	Diesel	13798	6	137.00	48
8210.02.385	Diesel	13798	6	137.00	48
8210.02.393	Diesel	13798	6	137.00	48
8210.02.405	Diesel	13798	6	137.00	48
8210.02.426	Diesel	13798	6	137.00	48
8210.02.440	Diesel	13798	6	137.00	48
8210.02.441	Diesel	13798	6	137.00	48
8210.02.731	Diesel	13798	6	137.00	48
8210.22	Diesel	13798	6	137.00	49
8210.22.069	Diesel	13798	6	137.00	49
8210.22.101	Diesel	13798	6	137.00	49
8210.22.105	Diesel	13798	6	137.00	49
8210.22.171	Diesel	13798	6	137.00	49
8210.22.175	Diesel	13798	6	137.00	49
8210.22.183	Diesel	13798	6	137.00	49
8210.22.210	Diesel	13798	6	137.00	49
8210.22.235	Diesel	13798	6	137.00	49
8210.22.236	Diesel	13798	6	137.00	49
8210.22.269	Diesel	13798	6	137.00	49
8210.22.317	Diesel	13798	6	137.00	49
8210.22.327	Diesel	13798	6	137.00	49
8210.22.373	Diesel	13798	6	137.00	49
8210.22.385	Diesel	13798	6	137.00	49
8210.22.406	Diesel	13798	6	137.00	49
8210.22.523	Diesel	13798	6	137.00	49
8210.22X.235	Diesel	13798	6	137.00	49
8210.42	Diesel	13798	6	137.00	50
8210.42.009	Diesel	13798	6	137.00	50
8210.42.101	Diesel	13798	6	137.00	50
8210.42.115	Diesel	13798	6	137.00	50
8210.42K Euro 1	Diesel	13798	6	137.00	50
8210.42L Euro 2	Diesel	13790	6	137.00	50
8211.02	Diesel	13798	6	137.00	48
8211.02.032	Diesel	13798	6	137.00	48
8211.22	Diesel	13798	6	137.00	49
8215.02	Diesel	13798	6	137.00	48
8217.32	Diesel	13798	6	137.00	49
8220.02.701	Diesel	9572	6	125.00	40
8220.02.834	Diesel	9572	6	125.00	40
8220.02.847	Diesel	9572	6	125.00	40
8220.02.856	Diesel	9572	6	125.00	40
8220.02.870	Diesel	9572	6	125.00	40
8220.12	Diesel	9572	6	125.00	40
8220.12.709	Diesel	9572	6	125.00	40



CCM

x



9

8220.22.002	Diesel	9572	6	125.00	41
8220.22.102	Diesel	9572	6	125.00	41
8220.22.104	Diesel	9572	6	125.00	41
8220.22.106	Diesel	9572	6	125.00	41
8220.22.708	Diesel	9570	6	125.00	41
8220.22.709	Diesel	9570	6	125.00	41
8220.32	Diesel	9572	6	125.00	41
8220.32.701	Diesel	9572	6	125.00	41
8220.32.721	Diesel	9570	6	125.00	41
8220.32.723	Diesel	9570	6	125.00	41
8260.02	Diesel	12880	6	145.00	51
8260.02.405	Diesel	12880	6	145.00	51
8261.02.002	Diesel	12880	6	145.00	51
8261.1.002	Diesel	12880	6	145.00	51
8280.01	Diesel	17174	V8	145.00	51
8280.01.000	Diesel	17174	V8	145.00	51
8280.02.000	Diesel	17174	V8	145.00	51
8280.02.024	Diesel	17174	V8	145.00	51
8280.02.082	Diesel	17174	V8	145.00	51
8280.02.109	Diesel	17174	V8	145.00	51
8280.02.125-135	Diesel	17174	V8	145.00	51
8280.02.265, 8280.02.273, 8280.02.279, 8280.02.410, 8280.02.412	Diesel	17174	V8	145.00	51
8280.02.269	Diesel	17174	V8	145.00	51
8280.02.274	Diesel	17174	V8	145.00	51
8280.02.275	Diesel	17174	V8	145.00	51
8280.02.289	Diesel	17174	V8	145.00	51
8280.02.405	Diesel	17174	V8	145.00	51
8280.22.	Diesel	17174	V8	145.00	51
8280.22.007	Diesel	17174	V8	145.00	51
8280.22.009	Diesel	17200	V8	145.00	51
8280.22.033	Diesel	17174	V8	145.00	51
8280.22.054	Diesel	17174	V8	145.00	51
8280.22.201	Diesel	17174	V8	145.00	51
8280.22.205	Diesel	17174	V8	145.00	51
8280.42.001	Diesel	17174	V8	145.00	51
8280.42.050	Diesel	17174	V8	145.00	51
8280.42S (TCA)	Diesel	17173	V8	145.00	51
8280.42S.342 Euro 2	Diesel	17174	V8	145.00	51
8280.42S.350	Diesel	17174	V8	145.00	51
8280.42S.352	Diesel	17174	V8	145.00	51
8280.42S.362	Diesel	17174	V8	145.00	51
8281.02	Diesel	17174	V8	145.00	51
8281.22.201	Diesel	17174	V8	145.00	51
8285.02	Diesel	17174	V8	145.00	51
8285.22	Diesel	17174	V8	145.00	51
8340.04.040	Diesel	4570	4	115.00	29
8340.04.200	Diesel	4570	4	115.00	29
8340.04.250	Diesel	4570	4	115.00	29
8340.04.300	Diesel	4570	4	115.00	29
8340.04.350	Diesel	4570	4	115.00	29
8340.04.362	Diesel	4570	4	115.00	29
8340.05	Diesel	5400	4	115.00	29
8340.05.200	Diesel	5401	4	115.00	29
8360.04	Diesel	6855	6	115.00	29
8360.05	Diesel	8100	6	115.00	29
8360.05.200	Diesel	8100	6	115.00	29
8360.05.254	Diesel	8100	6	115.00	29
8360.05.673	Diesel	8100	6	115.00	29
8360.05.B	Diesel	8100	6	115.00	29
8360.46	Diesel	7685	6	112.00	28

ENGINE INDEX

Motorverzeichnis • Index de moteur • Índice de Motor
 Indeks silnika • Модель двигателя • دليل المحرك

CCM

9

8360.46R.416 (TCA)	Diesel	7685	6	112.00	28
8361.04	Diesel	6850	6	115.00	29
8361.05	Diesel	8102	6	115.00	29
8361.25.510	Diesel	8101	6	115.00	30
8361.45.530	Diesel	8101	6	115.00	30
8365.05.500	Diesel	8101	6	115.00	29
8365.05.520	Diesel	8101	6	115.00	29
8365.05.530	Diesel	8101	6	115.00	29
8365.05.531	Diesel	8101	6	115.00	29
8365.05.555	Diesel	8101	6	115.00	29
8365.05.560	Diesel	8101	6	115.00	29
8365.05.570	Diesel	8101	6	115.00	29
8365.05.580	Diesel	8101	6	115.00	29
8365.05.590	Diesel	8101	6	115.00	29
8365.25	Diesel	8098	6	115.00	30
8460.21.002	Diesel	9500	6	120.00	35
8460.21.042, 8460.21.106, 8460.21.708, 8460.21.710	Diesel	9500	6	120.00	35
8460.21.102	Diesel	9500	6	120.00	35
8460.21.202	Diesel	9500	6	120.00	35
8460.21.206	Diesel	9500	6	120.00	35
8460.21.611	Diesel	9498	6	120.00	35
8460.21B.613, 8460.21B.615	Diesel	9500	6	120.00	35
8460.41 R	Diesel	9500	6	120.00	35
8460.41 S	Diesel	9500	6	120.00	35
8460.41 T	Diesel	9500	6	120.00	35
8460.41.102	Diesel	9500	6	120.00	35
8460.41.124	Diesel	9500	6	120.00	35
8460.41.160	Diesel	9500	6	120.00	35
8460.41C	Diesel	9500	6	120.00	35
8460.41C (TCA)	Diesel	9500	6	120.00	35
8460.41C.320	Diesel	9500	6	120.00	35
8460.41K	Diesel	9500	6	120.00	35
8460.41K. TCA Euro 1	Diesel	9500	6	120.00	35
8460.41K.406	Diesel	9500	6	120.00	35
8460.41K.410	Diesel	9500	6	120.00	35
8460.41L (TCA)	Diesel	9500	6	120.00	35
8460.41L.5020	Diesel	9500	6	120.00	35
8469 SG.10	CNG	9500		120.00	36
C 03	Diesel	4940	4	110.00	27
C 21, C20, C41, CO3, CO40	Diesel	4562	4	110.00	27
C02, C03/D, C055	Diesel	4397	4	108.00	26
C03, C100, C70	Diesel	4941	4	110.00	27
CN3	Diesel	3706	3	110.00	27
CO2 D	Diesel	4397	4	108.00	26
CO3-13OT	Diesel	5401	4	115.00	31
Compressor			2	82.00	1
CP 3	Diesel	7412	6	110.00	27
CP 3/100	Diesel	7412	6	110.00	27
CP 3/32.1.200	Diesel	7412	6	110.00	27
F1AE 0481 A Euro 3	Diesel	2287	4	88.00	3
F1AE 0481 B Euro 3	Diesel	2287	4	88.00	3
F1AE 0481 C Euro 3	Diesel	2287	4	88.00	3
F1AE 0481 FA Euro 4	Diesel	2287	4	88.00	3
F1AE 0481 GA Euro 4	Diesel	2287	4	88.00	3
F1AE 0481 HA Euro 4	Diesel	2287	4	88.00	3
F1AE 0481 M (HPI)	Diesel	2287	4	88.00	3
F1AE0481F Euro 4	Diesel	2287	4	88.00	3
F1AE0481G Euro 4	Diesel	2287	4	88.00	3
F1AE0481H Euro 4	Diesel	2287	4	88.00	3
F1AE0481R Euro 4	Diesel	2287	4	88.00	3



CCM



9

F1CE 0481 A	Diesel	2998	4	95.80	13
F1CE 0481 FA Euro 4	Diesel	2998	4	95.80	13
F1CE 0481 HA Euro 4	Diesel	2998	4	95.80	13
F1CE 0481 HC Euro 4	Diesel	2998	4	95.80	13
F1CE0441A	Diesel	2998	4	95.80	13
F1CE0481B Euro 3	Diesel	2998	4	95.80	13
F2BE 0681 A Euro 2 (Cursor 8-350)	Diesel	7790	6	115.00	32
F2BE 0681 B Euro 2 (Cursor 8-310)	Diesel	7790	6	115.00	32
F2BE 0681 C Euro 2 (Cursor 8-270 I)	Diesel	7790	6	115.00	32
F2BE 0681 D Euro 2 (Cursor 8-240)	Diesel	7790	6	115.00	32
F2BE 0681 E Euro 2 (Cursor 8-300)	Diesel	7790	6	115.00	32
F2BE 0681 F Euro 2 (Cursor 8-270 R)	Diesel	7790	6	115.00	32
F2BE0681DB Euro 2 (Cursor 8)	Diesel	7790	6	115.00	32
F2BE1682 G Euro 3	Diesel	7790	6	115.00	32
F2BE3681A Euro 4/5 (Cursor 8 E 36)	Diesel	7790	6	115.00	33
F2BE3681B Euro 4/5 (Cursor 8 E 33)	Diesel	7790	6	115.00	33
F2BE3681C Euro 4/5 (Cursor 8 E 31)	Diesel	7790	6	115.00	33
F2CE0681A (Cursor 9)	Diesel	8708	6	117.00	34
F2CE0682A (Cursor 9)	Diesel	8708	6	117.00	34
F2CE0683A (Cursor 9)	Diesel	8708	6	117.00	34
F2CE0684A (Cursor 9)	Diesel	8708	6	117.00	34
F3AE 0681 B Euro 3 (Cursor 10-400)	Diesel	10300	6	125.00	43
F3AE 0681 D Euro 2 (Cursor 10-430)	Diesel	10300	6	125.00	43
F3AE 0681 E Euro 2 (Cursor 10-390)	Diesel	10300	6	125.00	43
F3AE0681H Euro 3	Diesel	10300	6	125.00	43
F3AE9687 AE001 Euro 5 (Cursor 10)	Diesel	10300	6	125.00	44
F3B3681A Euro 4/5 (Cursor 13 E 56)	Diesel	12880	6	135.00	46
F3B3681B Euro 4/5 (Cursor 13 E 50)	Diesel	12880	6	135.00	46
F3B3681C Euro 4/5 (Cursor 13 E 45)	Diesel	12880	6	135.00	46
F3B3681D Euro 4/5 (Cursor 13 E 41)	Diesel	12880	6	135.00	46
F3B3681E Euro 4/5 (Cursor 13 E 48)	Diesel	12880	6	135.00	46
F3B3681G Euro 4/5 (Cursor 13 E 44)	Diesel	12880	6	135.00	46
F3BE 0681 A Euro 3 (Cursor 13-540)	Diesel	12880	6	135.00	47
F3BE 0681 B Euro 3 (Cursor 13-500)	Diesel	12880	6	135.00	47
F3BE 0681 C Euro 3 (Cursor 13-440)	Diesel	12880	6	135.00	47
F3BE 0681 D Euro 3	Diesel	12880	6	135.00	47
F3BE 0681 E Euro 3 (Cursor 13-480)	Diesel	12880	6	135.00	47
F3BE 0681 F Euro 3	Diesel	12880	6	135.00	47
F3BE 0681 G Euro 3 (Cursor 13-380)	Diesel	12880	6	135.00	47
F3BE3681A Euro 4/5	Diesel	12880	6	135.00	46
F3BE3681B Euro 4/5 (Cursor 13 E 50)	Diesel	12880	6	135.00	46
F3BE3681C Euro 4/5 (Cursor 13 E 45)	Diesel	12880	6	135.00	46
F3BE3681D Euro 4/5	Diesel	12880	6	135.00	46
F3BE3681E Euro 4/5	Diesel	12880	6	135.00	46
F3BE3681F Euro 4/5	Diesel	12880	6	135.00	46
F3BE3681G Euro 4/5	Diesel	12880	6	135.00	46
F4AE 0481 A Euro 3 (Tector E17)	Diesel	3920	4	102.00	18
F4AE 0481 C Euro 3 (Tector E15)	Diesel	3920	4	102.00	18
F4AE 0481 D Euro 3 (Tector E13)	Diesel	3920	4	102.00	18
F4AE 0681 A Euro 3 (Tector E28)	Diesel	5880	6	102.00	18
F4AE 0681 B Euro 3 (Tector E24)	Diesel	5880	6	102.00	18
F4AE 0681 D Euro 3 (Tector E21)	Diesel	5880	6	102.00	18
F4AE 0681 E Euro 3 (Tector E18)	Diesel	5880	6	102.00	18
F4AE0681C Euro 3 (Tector E24)	Diesel	5880	6	102.00	18
F4AE3481A Euro 4/5 (Tector E18)	Diesel	3920	4	102.00	19
F4AE3481B Euro 4/5 (Tector E18)	Diesel	3920	4	102.00	19
F4AE3481C Euro 4/5 (Tector E14)	Diesel	3920	4	102.00	19
F4AE3481D Euro 4/5 (Tector E16)	Diesel	3920	4	102.00	19
F4AE3681A Euro 4/5 (Tector E30)	Diesel	5880	6	102.00	19
F4AE3681B Euro 4/5 (Tector E22)	Diesel	5880	6	102.00	19

ENGINE INDEX

Motorverzeichnis • Index de moteur • Índice de Motor
Indeks silnika • Модель двигателя • دليل المحرك



CCM

x





9





F4AE3681C Euro 4/5 (Tector E22)	Diesel	5880	6	102.00	19
F4AE3681D Euro 4/5 (Tector E25)	Diesel	5880	6	102.00	19
F4AE3681E Euro 4/5 (Tector E28)	Diesel	5880	6	102.00	19
F4CE/GE9848 Euro 4	Diesel			104.00	25
F4GE0404A (N45 MNA-MSA)	Diesel	4485	4	104.00	25
F4GE0454A (N45 MNS-MSS)	Diesel	4485	4	104.00	25
F4GE0484C (N45 MNT-MST)	Diesel	4485	4	104.00	25
F4GE0484G (N45 MST)	Diesel	4485	4	104.00	25
F4GE0604A (N67 MNA-MSA)	Diesel	6728	6	104.00	25
F4GE0684C (N67 MNT-MST)	Diesel	6728	6	104.00	25
F6L 413 F	Diesel	9570	6	125.00	42
F8L 413 F	Diesel	12763	V8	125.00	42
F10L 413 F	Diesel	15953	V10	125.00	42





1

Compressor		2cyl.					FM25603
08-139900-00	STD	82.00	2.500		026 P	STD	
[R67390]	2.500			026 P	STD		
	4.000			232 P	STD		

2

615.000		4cyl.	2270cc	Diesel		FM4127
08-527800-00	STD	85.00	3.000		001 CR P	GOE12
08-527808-00	0.60mm		3.000		001 P	GOE12
[R46810]	3.000			023 P	GOE12	
	5.500			231 P	GOE12	



3

F1AE 0481 A Euro 3		4cyl.	2287cc	70kW (95PS)	Diesel	Turbo Intercooled	TD17144
F1AE 0481 B Euro 3		4cyl.	2287cc	85kW (116PS)	Diesel	Turbo Intercooled	TD17145
F1AE 0481 C Euro 3		4cyl.	2287cc	81kW (110PS)	Diesel	Turbo Intercooled	FM9055
F1AE 0481 FA Euro 4		4cyl.	2287cc	70kW (95PS)	Diesel	Turbo Intercooled	TD19231
F1AE 0481 GA Euro 4		4cyl.	2287cc	85kW (116PS)	Diesel	Turbo Intercooled	TD19232
F1AE 0481 HA Euro 4		4cyl.	2287cc	100kW (136PS)	Diesel	Turbo Intercooled	TD19233
F1AE 0481 M (HPI)		4cyl.	2287cc	100kW (136PS)	Diesel	Turbo Intercooled	TD19156
F1AE0481F Euro 4		4cyl.	2287cc	70kW (95PS)	Diesel	Turbo Intercooled	TD28231
F1AE0481G Euro 4		4cyl.	2287cc	85kW (116PS)	Diesel	Turbo Intercooled	TD28232
F1AE0481H Euro 4		4cyl.	2287cc	85kW (116PS)	Diesel	Turbo Intercooled	TD28233
F1AE0481R Euro 4		4cyl.	2287cc	85kW (116PS)	Diesel	Turbo Intercooled	TD28234
08-138000-00	STD	88.00	2.500		008 CK P	KV1	
08-138006-00	0.40mm		2.000		005 P	F12/F14	
08-138008-00	0.60mm		2.500		231 CR P	GOE13	
[R66800]							





4

8140.07.2585 Euro 1	4cyl.	2499cc	55kW (75PS)	Diesel		TD20437
8140.07.2700	4cyl.	2499cc	55kW (75PS)	Diesel		TD1700
8140.07.2701	4cyl.	2499cc	55kW (75PS)	Diesel		TD1701
8140.07.3700 Euro 1	4cyl.	2499cc	53kW (72PS)	Diesel		TD27364
8140.07.3710	4cyl.	2499cc	53kW (72PS)	Diesel		TD20418
8140.67.2585 Euro 2	4cyl.	2499cc	55-63kW (75-86PS)	Diesel		TD20427
8140.67.2700	4cyl.	2499cc	62kW (84PS)	Diesel		TD6810
8140.67F. Euro 2	4cyl.	2449cc	60kW (81PS)	Diesel		TD7226
8140.67F.3700 Euro 2	4cyl.	2449cc	60-63kW (82-86PS)	Diesel		TD20428
8140.67F.3701 Euro 2	4cyl.	2499cc	60kW (81PS)	Diesel		TD26292
8140.67F.3710 Euro 2	4cyl.	2499cc	60kW (81PS)	Diesel		TD26293
8140.67F.3711 Euro 2	4cyl.	2499cc	60kW (81PS)	Diesel		TD26294
8140.67F.3713 Euro 2	4cyl.	2499cc	60kW (81PS)	Diesel		TD26295
8140.67F.3721 Euro 2	4cyl.	2499cc	60kW (81PS)	Diesel		TD26296

08-425000-00	STD	93.00	3.000		008 CR P	KV1
08-425008-00	0.60mm		2.000		026 P	F12/F14
[R47250]			3.000		231 CR P	STD

5

8140.21	4cyl.	2445cc		Diesel Turbo		FM9103
8140.21.200	4cyl.	2445cc	68kW (92PS)	Diesel Turbo		TD1703
8140.21.214 (Sofim)	4cyl.	2445cc	77kW (105PS)	Diesel Turbo		TD1704
8140.27.210, 8140.27.213	4cyl.	2445cc	77kW (105PS)	Diesel Turbo		FM9131
8140.27.2100	4cyl.	2500cc	70kW (95PS)	Diesel Turbo		TD6800
8140.27.218	4cyl.	2499cc	76kW (103PS)	Diesel Turbo Intercooled		TD26268
8140.27.2582	4cyl.	2499cc	74-79kW (101-107PS)	Diesel Turbo		TD7260
8140.27.2700	4cyl.	2499cc	76kW (103PS)	Diesel Turbo		TD1706
8140.27.2720	4cyl.	2499cc	76kW (103PS)	Diesel Turbo		TD1707
8140.27.2811	4cyl.	2499cc	76kW (103PS)	Diesel Turbo		TD1708
8140.27R.2700	4cyl.	2499cc	70-67kW (95-92PS)	Diesel Turbo		TD20420
8140.27S.2700 (Sofim)	4cyl.	2499cc	76kW (103PS)	Diesel Turbo		TD20421
8140.27S.2801 (Sofim)	4cyl.	2499cc	76kW (103PS)	Diesel Turbo		TD20419
8140.27S.2885 (Sofim)	4cyl.	2499cc	76kW (103PS)	Diesel Turbo		TD20422
8140.97.2781	4cyl.	2499cc	68kW (92PS)	Diesel Turbo		TD1717
8140.97.2783	4cyl.	2499cc		Diesel Turbo		FM29100

08-245200-00	STD	93.00	3.000		008 CR P	KV1
08-245208-00	0.60mm		2.000		005 P	F12/F14
[R47080]			3.000		231 CR P	STD



6

8140.27S.3700 Euro 1	4cyl.	2499cc	77kW (105PS)	Diesel	Turbo Intercooled	TD20152
8140.47 R	4cyl.	2499cc	80kW (109PS)	Diesel	Turbo Intercooled	TD7234
8140.47.2700 Euro 1	4cyl.	2499cc	85kW (116PS)	Diesel	Turbo Intercooled	TD1711
8140.47.2711 Euro 1	4cyl.	2499cc	85kW (116PS)	Diesel	Turbo Intercooled	TD1712
8140.47.2721 Euro 1	4cyl.	2499cc	85kW (116PS)	Diesel	Turbo Intercooled	TD1713
8140.47.2785 Euro 1	4cyl.	2499cc	85kW (116PS)	Diesel	Turbo Intercooled	TD1715
8140.47.3700	4cyl.	2499cc	85kW (116PS)	Diesel	Turbo Intercooled	TD20477
8140.47R.2210	4cyl.	2499cc	80kW (109PS)	Diesel	Turbo Intercooled	TD6811
8140.47R.2790	4cyl.	2499cc	76kW (103PS)	Diesel	Turbo Intercooled	TD1716
8140.47S Euro 1	4cyl.	2499cc	85kW (116PS)	Diesel	Turbo Intercooled	TD20453

08-520200-00	STD	93.00	3.000		008 CR	KV1
[R49350]			2.000		005 IWU P	F12/F14
			3.000		231 CR P	STD

7

8140.61.200	4cyl.	2445cc	53kW (72PS)	Diesel		TD7225
8140.61.300	4cyl.	2445cc	53kW (72PS)	Diesel		TD20426
8142.61	4cyl.	2445cc	53kW (72PS)	Diesel		TD1053
8144.61.200	4cyl.	2445cc	53kW (72PS)	Diesel		TD20429

08-214400-10	STD	93.00	2.000		001 CR P	KV1
01/1978→05/1981			2.000		005 IF P	STD
[R60960]			4.000		231 CR P	STD
08-214500-10	STD	93.00	3.000		001 CR P	KV1
08-214508-10	0.60mm		2.000		005 IF P	STD
06/1981→			4.000		231 CR P	STD
[R47010]						

8

8140.67, 8144.67	4cyl.	2500cc	55kW (75PS)	Diesel		FM9170
8144.67.220	4cyl.	2499cc	55kW (75PS)	Diesel		TD6797

08-783300-00	STD	93.00	3.000		001 CR P	KV1
08-783308-00	0.60mm		2.000		026 P	STD
[R47100]			3.000		231 CR P	STD

9

8140.23.		4cyl.	2798cc	76kW (103PS)	Diesel	Turbo Intercooled	TD7229
8140.23.2585 (Sofim)		4cyl.	2799cc	78kW (106PS)	Diesel	Turbo Intercooled	TD16183
8140.23.3700 (Sofim)		4cyl.	2799cc	75-76kW (102-105PS)	Diesel	Turbo Intercooled	TD10387
8140.43 Euro 2		4cyl.	2798cc	90kW (122PS)	Diesel	Turbo Intercooled	TD7235
8140.43.2585 Euro 2 (Sofim)		4cyl.	2798cc	90-84kW (122-114PS)	Diesel	Turbo Intercooled	TD20423
8140.43.3700 (Sofim)		4cyl.	2799cc	84kW (114PS)	Diesel	Turbo Intercooled	TD20424
8140.43.3900 Euro 2		4cyl.	2798cc	90-84kW (122-114PS)	Diesel	Turbo Intercooled	TD20425
8140.43C Euro 2		4cyl.	2798cc	78kW (106PS)	Diesel	Turbo Intercooled	TD14449
08-122200-00	STD	94.40	2.500		008 CK P		KV1
08-122208-00	0.60mm		2.000		005 P		IKA
eng.2572280→			2.500		231 CR P		GOE12
[R60070]							
08-854700-00	STD	94.40	3.000		008 CR		GOE12
08-854708-00	0.60mm		2.000		005 IWU P		GOE12
→eng.2572279			3.000		231 CR		GOE12
[R49690]							

10

8140.43B Euro 3		4cyl.	2798cc	77kW (105PS)	Diesel	Turbo Intercooled	TD16514
8140.43B.4300 Euro 3		4cyl.	2798cc	77kW (105PS)	Diesel	Turbo Intercooled	TD25968
8140.43B.4305 Euro 3		4cyl.	2798cc	77kW (105PS)	Diesel	Turbo Intercooled	TD25966
8140.43B.4320 Euro 3		4cyl.	2798cc	77kW (105PS)	Diesel	Turbo Intercooled	TD25967
8140.43B.4325 Euro 3		4cyl.	2798cc	77kW (105PS)	Diesel	Turbo Intercooled	TD25969
8140.43B.4330 Euro 3		4cyl.	2798cc	77kW (105PS)	Diesel	Turbo Intercooled	TD25970
8140.43B.4335 Euro 3		4cyl.	2798cc	77kW (105PS)	Diesel	Turbo Intercooled	TD25971
8140.43N Euro 3		4cyl.	2798cc	107kW (146PS)	Diesel	Turbo Intercooled	TD16873
8140.43N.4300 Euro 3		4cyl.	2798cc	108kW (147PS)	Diesel	Turbo Intercooled	TD25984
8140.43N.4320 Euro 3		4cyl.	2798cc	108kW (147PS)	Diesel	Turbo Intercooled	TD25985
8140.43N.4330 Euro 3		4cyl.	2798cc	108kW (147PS)	Diesel	Turbo Intercooled	TD25986
8140.43N.4400 Euro 3		4cyl.	2798cc	108kW (147PS)	Diesel	Turbo Intercooled	TD25987
8140.43N.4430 Euro 3		4cyl.	2798cc	108kW (147PS)	Diesel	Turbo Intercooled	TD25988
8140.43S Euro 3		4cyl.	2798cc	92kW (125PS)	Diesel	Turbo Intercooled	TD16874
8140.43S.4000 Euro 3		4cyl.	2798cc	92kW (125PS)	Diesel	Turbo Intercooled	TD25995
8140.43S.4020 Euro 3		4cyl.	2798cc	92kW (125PS)	Diesel	Turbo Intercooled	TD25996
8140.43S.4030 Euro 3		4cyl.	2798cc	92kW (125PS)	Diesel	Turbo Intercooled	TD25997
8140.43S.4140 Euro 3		4cyl.	2798cc	92kW (125PS)	Diesel	Turbo Intercooled	TD25998
8140.43S.4300 Euro 3		4cyl.	2798cc	92kW (125PS)	Diesel	Turbo Intercooled	TD25999
8140.43S.4320 Euro 3		4cyl.	2798cc	92kW (125PS)	Diesel	Turbo Intercooled	TD26000
8140.43S.4330 Euro 3		4cyl.	2798cc	92kW (125PS)	Diesel	Turbo Intercooled	TD26001





8140.43S.4400 Euro 3		4cyl.	2798cc	92kW (125PS)	Diesel	Turbo Intercooled	TD26002
8140.43S.4420 Euro 3		4cyl.	2798cc	92kW (125PS)	Diesel	Turbo Intercooled	TD26003
8140.43S.4430 Euro 3		4cyl.	2798cc	92kW (125PS)	Diesel	Turbo Intercooled	TD26004
08-122200-00	STD	94.40	2.500		008 CK P		KV1
08-122208-00	0.60mm		2.000		005 P		IKA
[R60070]			2.500		231 CR P		GOE12

11

8140.63. Euro 2		4cyl.	2798cc	62kW (84PS)	Diesel	Turbo Intercooled	TD10389
8140.63.4000 (Sofim)		4cyl.	2798cc	63kW (86PS)	Diesel	Turbo Intercooled	TD20478
08-108200-00	STD	94.40	3.000		008 CR P		KV1
08-108208-00	0.60mm		2.000		026 P		STD
[R60060]			2.500		231 CR P		STD

12

213 H		6cyl.	4678cc		Diesel		FM9222
213.000		6cyl.	4678cc		Diesel		FM3471
230 A.000		4cyl.	2693cc		Diesel		FM2980
8025.01		2cyl.	1559cc		Diesel		FM569
803 A.062 (8030.01)		3cyl.	2339cc		Diesel		FM570
804A (8040.01)		4cyl.	3119cc		Diesel		FM4009
806 A (8060.01/.11)		6cyl.	4678cc		Diesel		FM572
08-207200-00	STD	95.00	2.500		001 IW CR P		KV1
08-207208-00	0.60mm		2.500		023 P		IKA
[R46770]			5.500		231 CR P		STD

13

F1CE 0481 A		4cyl.	2998cc	100kW (136PS)	Diesel	Turbo Intercooled	TD19195
F1CE 0481 FA Euro 4		4cyl.	2998cc	107kW (146PS)	Diesel	Turbo Intercooled	TD19224
F1CE 0481 HA Euro 4		4cyl.	2998cc	130kW (177PS)	Diesel	Turbo Intercooled	TD19225
F1CE 0481 HC Euro 4		4cyl.	2998cc	107kW (146PS)	Diesel	Turbo Intercooled	TD19230
F1CE0441A		4cyl.	2998cc	100kW (136PS)	Diesel	Turbo Intercooled	TD24071
F1CE0481B Euro 3		4cyl.	2998cc	122kW (166PS)	Diesel	Turbo Intercooled	TD22675
08-421600-00	STD	95.80	2.500		008 CK P		KV1
			2.000		005 P		F12/F14
			2.500		231 CR P		F12/F14



14

8025.02	2cyl.	1728cc		Diesel	FM573
8030.02	3cyl.	2592cc	46kW (63PS)	Diesel	TD6922
8030.02	3cyl.	2592cc	46kW (63PS)	Diesel	FM574
8035.02	3cyl.	2592cc	33-40kW (45-54PS)	Diesel	TD25194
8045.02	4cyl.	3455cc	44-50kW (60-68PS)	Diesel	TD25195
8060.02.000	6cyl.	5184cc	90kW (122PS)	Diesel	TD6852
8060.02.001	6cyl.	5184cc	90kW (122PS)	Diesel	TD10468
8060.02.003	6cyl.	5184cc	90kW (122PS)	Diesel	TD10469
8060.02.070	6cyl.	5184cc	90kW (122PS)	Diesel	TD6843
8065.02.007	6cyl.	5184cc	74kW (100PS)	Diesel	TD25315
8065.02.200	6cyl.	5184cc	70-74kW (95-101PS)	Diesel	TD25316
8065.02.207	6cyl.	5184cc	74kW (100PS)	Diesel	TD25317
8065.02.217	6cyl.	5184cc	74kW (100PS)	Diesel	TD25318

08-206800-00	STD	100.00	2.500		001 IW CR P	KV1
08-206808-00	0.60mm		2.500		023 P	STD
[R46830]			5.500		231 CR P	STD
08-206800-40	STD	100.00	2.500		001 CK P	KV1
08-206808-40	0.60mm		2.500		023 P	STD
[R46880]			5.500		231 CR P	STD

15

8035.06	3cyl.	2708cc	33-40kW (45-54PS)	Diesel	FM4008
8045.06	4cyl.	3613cc		Diesel	FM8778

08-106900-00	STD	100.00	2.500		001 IW CR P	KV1
			2.500		023 P	STD
			4.000		231 CR P	STD
08-781900-00	STD	100.00	2.500		001 MOL P	KV1
08-781908-00	0.60mm		2.500		026 P	IKA
[R47070]			4.000		231 CR P	STD



16

8035.06.200			3cyl.	2708cc	38kW (52PS)	Diesel	TD25535
8035.06.206			3cyl.	2708cc	38kW (52PS)	Diesel	TD25536
8035.06.208			3cyl.	2708cc	38-40kW (52-54PS)	Diesel	TD25537
8035.06.216			3cyl.	2708cc	38kW (52PS)	Diesel	TD25538
8035.06.220			3cyl.	2708cc	33kW (45PS)	Diesel	TD25539
8035.06.222			3cyl.	2708cc	33-38kW (45-52PS)	Diesel	TD25540
8035.06.223			3cyl.	2708cc	38kW (52PS)	Diesel	TD25541
8035.06.306			3cyl.	2708cc	38kW (52PS)	Diesel	TD25542
8035.06.307			3cyl.	2708cc	38kW (52PS)	Diesel	TD25543
8035.06.308			3cyl.	2708cc	38kW (52PS)	Diesel	TD25544
8035.06.309			3cyl.	2708cc	38kW (52PS)	Diesel	TD25545
8035.06.317			3cyl.	2708cc	38kW (52PS)	Diesel	TD25546
8035.06.320			3cyl.	2708cc	34kW (46PS)	Diesel	TD25547
8035.06.321			3cyl.	2708cc	34kW (46PS)	Diesel	TD25548
8035.06.322			3cyl.	2708cc	38kW (52PS)	Diesel	TD25549
8035.06.323			3cyl.	2708cc	33-38kW (45-52PS)	Diesel	TD25550
8045.06.200			4cyl.	3613cc	51kW (69PS)	Diesel	TD25521
8045.06.208			4cyl.	3613cc	51kW (69PS)	Diesel	TD25522
8045.06.213			4cyl.	3613cc	48-51kW (65-69PS)	Diesel	TD25523
8045.06.214			4cyl.	3613cc	73kW (99PS)	Diesel	TD25524
8045.06.215			4cyl.	3613cc	73kW (99PS)	Diesel	TD25525
8045.06.225			4cyl.	3613cc	48kW (65PS)	Diesel	TD25526
8045.06.319			4cyl.	3613cc	48kW (65PS)	Diesel	TD25527
8045.06.326			4cyl.	3613cc	48kW (65PS)	Diesel	TD25528
08-781900-00	STD	100.00		2.500		001 MOL P	KV1
08-781908-00	0.60mm			2.500		026 P	IKA
[R47070]				4.000		231 CR P	STD



17



8040.02		4cyl.	3456cc	60kW (81PS)		Diesel		TD6840
8040.02		4cyl.	3455cc			Diesel		FM575
8040.02.041		4cyl.	3456cc	56kW (76PS)		Diesel		TD6925
8040.02.267		4cyl.	3456cc	56kW (76PS)		Diesel		TD5606
8040.02.300		4cyl.	3455cc	56kW (76PS)		Diesel		TD5605
8040.02.360		4cyl.	3456cc	56kW (76PS)		Diesel		TD5944
8040.02.367		4cyl.	3456cc	56kW (76PS)		Diesel		TD5945
08-206800-00	STD	100.00	2.500		001 IW CR P		KV1	
08-206808-00	0.60mm							
[R46830]								
			2.500		023 P		STD	
			5.500		231 CR P		STD	
08-206800-40	STD	100.00	2.500		001 CK P		KV1	
08-206808-40	0.60mm							
[R46880]								
			2.500		023 P		STD	
			5.500		231 CR P		STD	
08-781900-00	STD	100.00	2.500		001 MOL P		KV1	
08-781908-00	0.60mm							
[R47070]								
			2.500		026 P		IKA	
			4.000		231 CR P		STD	

18



F4AE 0481 A Euro 3 (Tector E17)		4cyl.	3920cc	125kW (170PS)		Diesel	Turbo Intercooled	TD16294
F4AE 0481 C Euro 3 (Tector E15)		4cyl.	3920cc	110kW (150PS)		Diesel	Turbo Intercooled	TD16293
F4AE 0481 D Euro 3 (Tector E13)		4cyl.	3920cc	95kW (129PS)		Diesel	Turbo Intercooled	TD16292
F4AE 0681 A Euro 3 (Tector E28)		6cyl.	5880cc	202kW (275PS)		Diesel	Turbo Intercooled	TD16520
F4AE 0681 B Euro 3 (Tector E24)		6cyl.	5880cc	176kW (239PS)		Diesel	Turbo Intercooled	TD16519
F4AE 0681 D Euro 3 (Tector E21)		6cyl.	5880cc	154kW (210PS)		Diesel	Turbo Intercooled	TD16296
F4AE 0681 E Euro 3 (Tector E18)		6cyl.	5880cc	134kW (182PS)		Diesel	Turbo Intercooled	TD16295
F4AE0681C Euro 3 (Tector E24)		6cyl.	5880cc	154kW (210PS)		Diesel	Turbo Intercooled	TD24238
08-145000-00	STD	102.00	3.000		008 CK P		KV1	
08-145007-00	0.50mm							
08-145008-00	0.60mm							
[R66730]			2.390		005 IF P		GOE13	
			4.000		231 CR P		GOE13	



19

F4AE3481A Euro 4/5 (Tector E18)	4cyl.	3920cc	134kW (182PS)	Diesel	Turbo Intercooled	TD21097
F4AE3481B Euro 4/5 (Tector E18)	4cyl.	3920cc	130kW (177PS)	Diesel	Turbo Intercooled	TD21096
F4AE3481C Euro 4/5 (Tector E14)	4cyl.	3920cc	103kW (140PS)	Diesel	Turbo Intercooled	TD21092
F4AE3481D Euro 4/5 (Tector E16)	4cyl.	3920cc	118kW (160PS)	Diesel	Turbo Intercooled	TD21095
F4AE3681A Euro 4/5 (Tector E30)	6cyl.	5880cc	220kW (299PS)	Diesel	Turbo Intercooled	TD22585
F4AE3681B Euro 4/5 (Tector E22)	6cyl.	5880cc	160kW (218PS)	Diesel	Turbo Intercooled	TD21098
F4AE3681C Euro 4/5 (Tector E22)	6cyl.	5880cc	135kW (184PS)	Diesel	Turbo Intercooled	TD22602
F4AE3681D Euro 4/5 (Tector E25)	6cyl.	5880cc	185kW (252PS)	Diesel	Turbo Intercooled	TD21099
F4AE3681E Euro 4/5 (Tector E28)	6cyl.	5880cc	205kW (279PS)	Diesel	Turbo Intercooled	TD21100
08-427900-00	STD	102.00	3.000		008 CK P	KV1
			2.390		005 IF P	GOE12
			4.000		231 CR P	GOE12

20

8035.04			3cyl.	2748cc	Diesel	FM4007
8035.42			3cyl.	2748cc	Diesel	FM24007
8040.04.200			4cyl.	3666cc	63kW (86PS)	TD10397
8045.04			4cyl.	3666cc	Diesel	FM3483
8055.04			5cyl.	4583cc	Diesel	FM3484
8060.04			6cyl.	5499cc	96kW (131PS)	TD10457
8060.04.000			6cyl.	5499cc	99kW (135PS)	TD6853
8060.04.055			6cyl.	5499cc	96kW (131PS)	TD10420
8060.04.060			6cyl.	5499cc	96kW (131PS)	TD10417
8060.04.070			6cyl.	5499cc	99kW (135PS)	TD10413
8060.04.620			6cyl.	5499cc	99kW (135PS)	TD10408
8060.04.621			6cyl.	5499cc	99kW (135PS)	TD10409
8060.04.630			6cyl.	5499cc	99kW (135PS)	TD10470
8060.04.639			6cyl.	5499cc	99kW (135PS)	TD10463
8060.04.658			6cyl.	5499cc	99kW (135PS)	TD10390
8060.04.660			6cyl.	5499cc	96-99kW (131-135PS)	TD10421
8060.04.669			6cyl.	5499cc	99-102kW (135-139PS)	TD10460
8060.04.670			6cyl.	5499cc	99kW (135PS)	TD10449
8060.04.672			6cyl.	5499cc	73kW (99PS)	TD10450
8060.04.675			6cyl.	5499cc	99kW (135PS)	TD10464
8060.04.689			6cyl.	5499cc	99-102kW (135-139PS)	TD10462
8065.04			6cyl.	5499cc	Diesel	FM14933
8065.04-H			6cyl.	5499cc	Diesel	FM13486
08-782000-00	STD	103.00	2.500		001 MOL P	KV1
08-782008-00	0.60mm		2.500		026 P	IKA
[R47030]			4.000		231 CR P	STD



21

8041 L		4cyl.	3666cc		Diesel		FM13483
8060.24.601		6cyl.	5499cc	124kW (168PS)	Diesel	Turbo	TD10472
8060.24.643		6cyl.	5499cc	103kW (140PS)	Diesel	Turbo	TD7259
8060.24.652		6cyl.	5499cc	123kW (167PS)	Diesel	Turbo	TD7251
8060.24.661		6cyl.	5499cc	90kW (122PS)	Diesel	Turbo	TD6832
8060.24.662		6cyl.	5499cc	96kW (131PS)	Diesel	Turbo	TD5603
8060.24.664		6cyl.	5499cc	96kW (131PS)	Diesel	Turbo	TD5941
8060.24.670		6cyl.	5499cc	118kW (160PS)	Diesel	Turbo	TD10447
8060.24.671		6cyl.	5499cc	118kW (160PS)	Diesel	Turbo	TD10448
8060.24.673		6cyl.	5499cc	96kW (131PS)	Diesel	Turbo	TD5942
8060.24.678		6cyl.	5499cc	123kW (167PS)	Diesel	Turbo	TD10465
8061 L		6cyl.	5499cc		Diesel		FM23487
8062.24.070		6cyl.	5499cc	118kW (160PS)	Diesel	Turbo	TD10458
08-783900-00	STD	103.00	3.000		008 MOL P		KV1
[R47050]			2.500		026 P		IKA
			4.000		231 CR		GOE12

22

8035.05		3cyl.	2930cc		Diesel		FM4032
8040.05.200		4cyl.	3908cc	65kW (88PS)	Diesel		TD7265
8040.05.200		4cyl.	3908cc	65kW (88PS)	Diesel		TD10399
8040.05.203		4cyl.	3908cc	65kW (88PS)	Diesel		TD16721
8040.05.230		4cyl.	3908cc	65kW (88PS)	Diesel		TD7264
8040.05.230		4cyl.	3908cc	65kW (88PS)	Diesel		TD10398
8040.05.233		4cyl.	3908cc	65kW (88PS)	Diesel		TD16723
8040.05.235		4cyl.	3908cc	65kW (88PS)	Diesel		TD16724
8045.05		4cyl.	3908cc	67kW (90PS)	Diesel		FM5567
8060.05		6cyl.	5861cc	101kW (137PS)	Diesel		TD10424
8060.05.000		6cyl.	5861cc	79-102kW (108-139PS)	Diesel		TD7282
8060.05.200		6cyl.	5861cc	99-102kW (135-139PS)	Diesel		TD7299
8060.05.200		6cyl.	5868cc	99-102kW (135-139PS)	Diesel		TD10471
8060.05.246		6cyl.	5861cc	101kW (137PS)	Diesel		TD7262
8060.05.246		6cyl.	5868cc	101kW (137PS)	Diesel		TD10391
8060.05.270		6cyl.	5861cc	101-102kW (138-139PS)	Diesel		TD7278
8060.05.270		6cyl.	5861cc	101kW (137PS)	Diesel		TD10412
8060.05.280		6cyl.	5861cc	102kW (139PS)	Diesel		TD7281
8060.05.280		6cyl.	5861cc	101kW (137PS)	Diesel		TD10423
8060.05.285		6cyl.	5861cc	101kW (137PS)	Diesel		TD7274
8060.05.285		6cyl.	5861cc	101kW (137PS)	Diesel		TD10411
8060.05.289		6cyl.	5861cc	102kW (139PS)	Diesel		TD7293





8060.05.289		6cyl.	5861cc	101kW (137PS)	Diesel	TD10461
8061.05		6cyl.	5861cc	82kW (112PS)	Diesel	TD28429
8065.E		6cyl.	5861cc	82kW (112PS)	Diesel	TD28430
08-247800-00	STD	104.00	2.500		001 MOL P	KV1
08-247808-00	0.60mm		2.500		005 IF P	STD
[R47200]			4.000		231 CR P	STD
08-784700-00	STD	104.00	2.500		001 CR P	KV1
			2.500		023 P	STD
			4.000		231 CR P	STD

23

8040.05.4990		4cyl.	3908cc	80kW (109PS)	Diesel Turbo	TD16725
8040.25 B.4200		4cyl.	3908cc	75kW (102PS)	Diesel Turbo	TD10403
8040.25.4990		4cyl.	3908cc	85kW (116PS)	Diesel Turbo Intercooled	FM24132
8040.25X.4000		4cyl.	3908cc	85kW (116PS)	Diesel Turbo	TD10404
8040.45.400		4cyl.	3908cc	100kW (136PS)	Diesel Turbo Intercooled	TD10405
8040.45.5200 Euro 2		4cyl.	3908cc	100kW (136PS)	Diesel Turbo Intercooled	TD20439
8040.45D.5100 Euro 2		4cyl.	3908cc	100-85kW (136-116PS)	Diesel Turbo Intercooled	TD20440
8040.45X.4180		4cyl.	3908cc	100kW (136PS)	Diesel Turbo Intercooled	TD20441
8060.25R 4200		6cyl.	5861cc	105kW (143PS)	Diesel Turbo	TD10479
8060.25R 4300		6cyl.	5861cc	105kW (143PS)	Diesel Turbo Intercooled	TD20414
8060.25R.4280		6cyl.	5861cc	105kW (143PS)	Diesel Turbo	TD10475
8060.25V.4000		6cyl.	5868cc	130kW (177PS)	Diesel Turbo Intercooled	TD10454
8060.25V.4080		6cyl.	5861cc	130kW (177PS)	Diesel Turbo Intercooled	TD10476
8060.25V.4800		6cyl.	5861cc	130kW (177PS)	Diesel Turbo Intercooled	TD10481
8060.45.4100		6cyl.	5861cc	152kW (207PS)	Diesel Turbo	TD10497
8060.45.4700		6cyl.	5861cc	152kW (207PS)	Diesel Turbo	TD10913
8060.45B 5100 Euro 2		6cyl.	5861cc	152-130kW (207-177PS)	Diesel Turbo Intercooled	TD20415
8060.45R.5000		6cyl.	5861cc	105kW (143PS)	Diesel Turbo	TD16717
8060.45R.5001		6cyl.	5861cc	105kW (143PS)	Diesel Turbo	TD16718
8060.45R.5003		6cyl.	5861cc	105kW (143PS)	Diesel Turbo	TD16719
8060.45R.5050		6cyl.	5861cc	105kW (143PS)	Diesel Turbo	TD10911
08-103900-00	STD	104.00	3.500		008 MO P	KV1
08-103906-00	0.40mm		2.500		023 P	STD
08-103908-00	0.60mm		4.000		231 CR P	STD
08-103910-00	0.80mm					
[R48500]						



24

8040.25.000	4cyl.	3908cc	74-85kW (101-116PS)	Diesel Turbo	TD21461
8040.25.200	4cyl.	3908cc	85kW (116PS)	Diesel Turbo	TD7272
8040.25.200	4cyl.	3908cc	85kW (116PS)	Diesel Turbo	TD10407
8040.25.220	4cyl.	3908cc	85kW (116PS)	Diesel Turbo	TD7280
8040.25.230	4cyl.	3908cc	74kW (100PS)	Diesel Turbo	TD7271
8060.25.600	6cyl.	5861cc	130kW (177PS)	Diesel Turbo	TD7301
8060.25.621	6cyl.	5861cc	110kW (150PS)	Diesel Turbo	TD7243
8060.25.630	6cyl.	5861cc	100kW (136PS)	Diesel Turbo	TD5604
8060.25.631	6cyl.	5861cc	100kW (136PS)	Diesel Turbo	TD5943
8060.25.641	6cyl.	5861cc	103kW (140PS)	Diesel Turbo	TD7242
8060.25.662	6cyl.	5861cc	96kW (131PS)	Diesel Turbo	TD5599
8060.25.663	6cyl.	5861cc	88-96kW (118-131PS)	Diesel Turbo	TD5936
8060.25.669	6cyl.	5861cc	125kW (170PS)	Diesel Turbo	TD5613
8060.25.670	6cyl.	5861cc	125kW (170PS)	Diesel Turbo	TD5952
8060.25.673	6cyl.	5861cc	96kW (131PS)	Diesel Turbo	TD5938
8060.25.678	6cyl.	5861cc	130kW (177PS)	Diesel Turbo	TD5616
8060.25.679	6cyl.	5861cc	130kW (177PS)	Diesel Turbo	TD5955
8061.25	6cyl.	5868cc	114kW (155PS)	Diesel Turbo	FM24133
8065.25	6cyl.	5863cc	94-110kW (128-150PS)	Diesel Turbo	FM4018
8065.25.080	6cyl.	5863cc	105kW (143PS)	Diesel	TD25475
8065.45	6cyl.	5862cc		Diesel	FM8774

08-244500-00	STD	104.00	3.000		008 CR P	KV1
[R47110]			2.500		023 P	IKA
			4.000		231 CR P	STD

25

F4CE/GE9848 Euro 4					Diesel	FM23485
F4GE0404A (N45 MNA-MSA)	4cyl.	4485cc	60kW (81PS)	Diesel Turbo Intercooled	TD27631	
F4GE0454A (N45 MNS-MSS)	4cyl.	4485cc	74kW (100PS)	Diesel Turbo Intercooled	TD27632	
F4GE0484C (N45 MNT-MST)	4cyl.	4485cc	94kW (128PS)	Diesel Turbo Intercooled	TD27633	
F4GE0484G (N45 MST)	4cyl.	4485cc	82kW (111PS)	Diesel Turbo Intercooled	TD27634	
F4GE0604A (N67 MNA-MSA)	6cyl.	6728cc	81kW (110PS)	Diesel Turbo Intercooled	TD27630	
F4GE0684C (N67 MNT-MST)	6cyl.	6728cc	129kW (175PS)	Diesel Turbo Intercooled	TD27629	

08-432700-00	STD	104.00	3.000		008 GDC P	KV1
			2.390		005 IF P	GOE13
			4.000		231 CR P	STD



26

C02, C03/D, C055		4cyl.	4397cc		Diesel	FM21303
CO2 D		4cyl.	4397cc		Diesel	FM1303
08-528100-00	STD	108.00	2.500		001 CR P	GOE12
[R47500]			2.500		001 P	GOE12
			2.500		023 P	GOE12
			2.500		023 P	GOE12
			5.000		030 P	GOE12
			5.000		231 P	GOE12

27

C 03		4cyl.	4940cc	67kW (91PS)	Diesel	TD6844
C 21, C20, C41, CO3, CO40		4cyl.	4562cc		Diesel	FM1307
CO3, C100, C70		4cyl.	4941cc		Diesel	FM4029
CN3		3cyl.	3706cc		Diesel	FM4028
CP 3		6cyl.	7412cc	107kW (146PS)	Diesel	TD6861
CP 3/100		6cyl.	7412cc		Diesel	FM11310
CP 3/32.1.200		6cyl.	7412cc	107-110kW (145-150PS)	Diesel	TD6855
08-207500-00	STD	110.00	2.500		001 IF CR P	STD
[R47460]			2.500		001 P	STD
			2.500		023 P	STD
			5.000		231 CR P	STD

28

8360.46		6cyl.	7685cc	196kW (266PS)	Diesel Turbo	TD27452
8360.46R.416 (TCA)		6cyl.	7685cc	176kW (239PS)	Diesel Turbo Intercooled	TD10511
08-142900-00	STD	112.00	3.500		008 CK P	KV1
[R67730]			2.500		005 IWU CR P	F12/F14
			4.000		231 CR P	STD



29

8340.04.040	4cyl.	4570cc	73kW (99PS)	Diesel	TD10400
8340.04.200	4cyl.	4570cc	74kW (100PS)	Diesel	TD10392
8340.04.250	4cyl.	4570cc	74kW (100PS)	Diesel	TD10393
8340.04.300	4cyl.	4570cc	74kW (100PS)	Diesel	TD10394
8340.04.350	4cyl.	4570cc	74kW (100PS)	Diesel	TD10395
8340.04.362	4cyl.	4570cc	74kW (100PS)	Diesel	TD10396
8340.05	4cyl.	5400cc	63kW (86PS)	Diesel	TD6849
8340.05.200	4cyl.	5401cc	84kW (114PS)	Diesel	TD10410
8360.04	6cyl.	6855cc	106kW (145PS)	Diesel	FM3523
8360.05	6cyl.	8100cc	95-124kW (129-169PS)	Diesel	TD6854
8360.05.200	6cyl.	8100cc	124kW (168PS)	Diesel	TD10484
8360.05.254	6cyl.	8100cc	124kW (168PS)	Diesel	TD10488
8360.05.673	6cyl.	8100cc	118-121kW (160-165PS)	Diesel	TD10494
8360.05.B	6cyl.	8100cc	101-110kW (137-150PS)	Diesel	TD6856
8361.04	6cyl.	6850cc	106kW (145PS)	Diesel	FM4951
8361.05	6cyl.	8102cc	118kW (160PS)	Diesel	FM4952
8365.05.500	6cyl.	8101cc	114kW (155PS)	Diesel	TD25353
8365.05.520	6cyl.	8101cc	104kW (141PS)	Diesel	TD25354
8365.05.530	6cyl.	8101cc	99kW (135PS)	Diesel	TD25355
8365.05.531	6cyl.	8101cc	104kW (141PS)	Diesel	TD25356
8365.05.555	6cyl.	8101cc	96kW (131PS)	Diesel	TD25357
8365.05.560	6cyl.	8101cc	94kW (128PS)	Diesel	TD25358
8365.05.570	6cyl.	8101cc	94kW (128PS)	Diesel	TD25359
8365.05.580	6cyl.	8101cc	94kW (128PS)	Diesel	TD25360
8365.05.590	6cyl.	8101cc	94kW (128PS)	Diesel	TD25361

08-214900-10 [R47530]	STD	115.00	2.500		001 IF CR P	IKA
			2.500		005 P	STD
			4.000		231 CR P	STD
08-523000-00 [R47510]	STD	115.00	2.500		001 IF CR P	IKA
			2.500		001 IF P	GOE12
			4.000		231 CR P	GOE12

30

8361.25.510		6cyl.	8101cc		Diesel		FM19113
8361.45.530		6cyl.	8101cc		Diesel Turbo Intercooled		FM9113
8365.25		6cyl.	8098cc		Diesel		FM6419
08-245500-00	STD	115.00	3.000		008 CR P		IKA
[R47550]	2.500			005 P		STD	
	4.000			231 CR P		STD	
08-524700-00	STD	115.00	3.000		008 CR P		IKA
[R47520]	2.500			001 CR P		IKA	
	4.000			231 CR P		GOE12	

31

CO3-130T		4cyl.	5401cc		Diesel		FM4030
08-528000-00	STD	115.00	2.500		001 IF CR P		IKA
[R47490]	2.500			001 IF P		GOE12	
	5.000			231 P		GOE12	

32





F2BE 0681 A Euro 2 (Cursor 8-350)		6cyl.	7790cc	259kW (352PS)	Diesel Turbo Intercooled		TD10828
F2BE 0681 B Euro 2 (Cursor 8-310)		6cyl.	7790cc	228kW (310PS)	Diesel Turbo Intercooled		TD10829
F2BE 0681 C Euro 2 (Cursor 8-270 I)		6cyl.	7790cc	200kW (272PS)	Diesel Turbo Intercooled		TD10832
F2BE 0681 D Euro 2 (Cursor 8-240)		6cyl.	7790cc	180kW (245PS)	Diesel Turbo Intercooled		TD10833
F2BE 0681 E Euro 2 (Cursor 8-300)		6cyl.	7790cc	218kW (296PS)	Diesel Turbo Intercooled		TD10830
F2BE 0681 F Euro 2 (Cursor 8-270 R)		6cyl.	7790cc	200kW (272PS)	Diesel Turbo Intercooled		TD10831
F2BE0681DB Euro 2 (Cursor 8)		6cyl.	7790cc	180kW (245PS)	Diesel Turbo Intercooled		TD28229
F2BE1682 G Euro 3		6cyl.	7790cc	259-228kW (352-310PS)	Diesel Turbo Intercooled		TD20019
08-121800-00	STD	115.00	3.000		008 CR P		KV1
[R60120]	2.500			026 IFU CR P		F12/F14	
	4.000			231 CR P		GOE12	

33



F2BE3681A Euro 4/5 (Cursor 8 E 36)		6cyl.	7790cc	265kW (360PS)	Diesel Turbo Intercooled		TD20466
F2BE3681B Euro 4/5 (Cursor 8 E 33)		6cyl.	7790cc	243kW (330PS)	Diesel Turbo Intercooled		TD20465
F2BE3681C Euro 4/5 (Cursor 8 E 31)		6cyl.	7790cc	228kW (310PS)	Diesel Turbo Intercooled		TD20464
08-431100-00	STD	115.00	2.000		008 CK P		KV1
	1.500			026 IFU NT		F12/F14	
	4.000			231 CR		STD	



34

F2CE0681A (Cursor 9)	6cyl.	8708cc	294kW (400PS)	Diesel	Turbo Intercooled	TD25715
F2CE0682A (Cursor 9)	6cyl.	8708cc	294kW (400PS)	Diesel	Turbo Intercooled	TD25716
F2CE0683A (Cursor 9)	6cyl.	8708cc	294kW (400PS)	Diesel	Turbo Intercooled	TD25717
F2CE0684A (Cursor 9)	6cyl.	8708cc	294kW (400PS)	Diesel	Turbo Intercooled	TD25718
08-428800-00	STD	117.00	3.000	 008 GDC P		KV4
			2.500	 026 IF NT		F12/F14
			4.000	 231 CR P		GOE13
						

35

8460.21.002	6cyl.	9500cc	177kW (240PS)	Diesel	Turbo	TD10502
8460.21.042, 8460.21.106, 8460.21.708, 8460.21.710	6cyl.	9500cc	177kW (240PS)	Diesel	Turbo	FM4130
8460.21.102	6cyl.	9500cc	191kW (260PS)	Diesel	Turbo	TD10521
8460.21.202	6cyl.	9500cc	177kW (240PS)	Diesel	Turbo	TD10518
8460.21.206	6cyl.	9500cc	177kW (240PS)	Diesel	Turbo	TD10519
8460.21.611	6cyl.	9498cc	154kW (210PS)	Diesel	Turbo	TD20436
8460.21B.613, 8460.21B.615	6cyl.	9500cc	162kW (220PS)	Diesel		FM19114
8460.41 R	6cyl.	9500cc	214-276kW (290-375PS)	Diesel	Turbo Intercooled	TD7248
8460.41 S	6cyl.	9500cc	254kW (345PS)	Diesel		TD7249
8460.41 T	6cyl.	9500cc	185kW (252PS)	Diesel		TD24262
8460.41.102	6cyl.	9500cc	234kW (318PS)	Diesel	Turbo Intercooled	TD10548
8460.41.124	6cyl.	9500cc	234kW (318PS)	Diesel	Turbo Intercooled	TD10599
8460.41.160	6cyl.	9500cc	236kW (321PS)	Diesel	Turbo Intercooled	TD10547
8460.41C	6cyl.	9500cc	221kW (300PS)	Diesel	Turbo	TD10807
8460.41C (TCA)	6cyl.	9500cc	221kW (300PS)	Diesel	Turbo Intercooled	TD10595
8460.41C.320	6cyl.	9500cc	221kW (300PS)	Diesel	Turbo	TD10512
8460.41K	6cyl.	9500cc	254kW (345PS)	Diesel	Turbo	TD10808
8460.41K. TCA Euro 1	6cyl.	9500cc	254kW (345PS)	Diesel	Turbo	TD7342
8460.41K.406	6cyl.	9500cc	254kW (345PS)	Diesel	Turbo	TD10513
8460.41K.410	6cyl.	9500cc	254kW (345PS)	Diesel	Turbo	TD10709
8460.41L (TCA)	6cyl.	9500cc	276kW (375PS)	Diesel	Turbo	TD10573
8460.41L.5020	6cyl.	9500cc	276kW (375PS)	Diesel	Turbo	TD10514
08-785300-00	STD	120.00	3.500	 008 CR P		KV1
[R47230]			3.000	 005 IF CR P		STD
			5.000	 231 CR P		STD



36

8469 SG.10			9500cc	160kW (228PS)	CNG	Turbo Intercooled	FM600
08-451000-00	STD	120.00	3.500		008 CR P		KV1
			3.000		026 IFU P		F12/F14
			5.000		231 CR P		STD

37

8200.02			6cyl.	9820cc		Diesel	FM9108
8200.02.220			6cyl.	9820cc	147kW (200PS)	Diesel	TD6935
8200.12			6cyl.	9820cc		Diesel	FM9109
8200.12.000			6cyl.	9820cc	140kW (190PS)	Diesel	TD6906
8200.12.004			6cyl.	9820cc	140-147kW (190-200PS)	Diesel	TD6905
8205.02			6cyl.	9820cc		Diesel	FM3500
08-207700-00	STD	122.00	3.500		008 CR P		IKA
<i>[R46860]</i>			3.000		005 IF P		STD
			3.000		005 P		STD
			5.500		231 CR P		STD

38

203 H			6cyl.	10676cc		Diesel	FM4022
203.000			6cyl.	10676cc		Diesel	FM596
604.03/31/34/35/41			4cyl.	6872cc		Diesel	FM9168
08-527700-00	STD	125.00	3.500		001 CR P		GOE12
<i>[R46780]</i>			3.000		001 IF P		GOE12
			3.000		001 IF P		GOE12
			3.000		023 P		STD
			5.500		231 P		GOE12
			5.500		030 P		GOE12

39

8200.03			6cyl.	10308cc		Diesel	FM595
8200.13			6cyl.	10308cc		Diesel	FM9110
08-527900-00	STD	125.00	3.500		008 CR P		KV1
<i>[R46890]</i>			3.000		005 P		GOE12
			3.000		023		STD
			5.500		231 CR		GOE12



40

8220.02.701		6cyl.	9572cc	148kW (201PS)	Diesel		TD7252
8220.02.834		6cyl.	9572cc	148kW (201PS)	Diesel		TD7361
8220.02.847		6cyl.	9572cc	151kW (205PS)	Diesel		TD6866
8220.02.856		6cyl.	9572cc	151kW (205PS)	Diesel		TD6867
8220.02.870		6cyl.	9572cc	148kW (201PS)	Diesel		TD7327
8220.02.870		6cyl.	9572cc	148kW (201PS)	Diesel		TD10517
8220.12		6cyl.	9572cc	148kW (201PS)	Diesel		FM4020
8220.12.709		6cyl.	9572cc	149kW (203PS)	Diesel		TD7370
08-528200-00	STD	125.00	3.000		001 CR P		GOE12
[R47700]			3.000		026 P		GOE12
			5.500		231 CR		GOE12

41

8220.22.002		6cyl.	9572cc	177kW (240PS)	Diesel Turbo		TD10495
8220.22.102		6cyl.	9572cc	177kW (240PS)	Diesel Turbo		TD10496
8220.22.104		6cyl.	9572cc	177kW (240PS)	Diesel Turbo		TD5940
8220.22.106		6cyl.	9572cc	177kW (240PS)	Diesel Turbo		TD6258
8220.22.708		6cyl.	9570cc	177kW (240PS)	Diesel Turbo		TD5640
8220.22.709		6cyl.	9570cc	177kW (240PS)	Diesel Turbo		TD5981
8220.32		6cyl.	9572cc	177kW (240PS)	Diesel Turbo		FM9115
8220.32.701		6cyl.	9572cc	177kW (240PS)	Diesel Turbo		TD7379
8220.32.721		6cyl.	9570cc	177kW (240PS)	Diesel Turbo		TD7380
8220.32.723		6cyl.	9570cc	177kW (240PS)	Diesel Turbo		TD7373
08-781000-00	STD	125.00	4.000		008 CR P		KV1
[R47140]			3.000		005 P		STD
			3.000		005 P		STD
			4.000		231 CR P		STD

42

F10L 413 F		V10cyl.	15953cc	235kW (320PS)	Diesel Turbo		TD10527	
F6L 413 F		6cyl.	9570cc	141kW (192PS)	Diesel		TD10483	
F8L 413 F		V8cyl.	12763cc	162-212kW (220-288PS)	Diesel		TD10522	
08-440400-00	STD	125.00	3.000		008 MO		KV1	
08-440407-00	0.50mm			2.500		005 P		STD
08-440411-00	1.00mm			4.000		231 CR		STD



43

F3AE 0681 B Euro 3 (Cursor 10-400)		6cyl.	10300cc	294kW (400PS)	Diesel	Turbo Intercooled	TD16551
F3AE 0681 D Euro 2 (Cursor 10-430)		6cyl.	10300cc	316kW (430PS)	Diesel	Turbo Intercooled	TD14970
F3AE 0681 E Euro 2 (Cursor 10-390)		6cyl.	10300cc	287kW (390PS)	Diesel	Turbo Intercooled	TD14968
F3AE0681H Euro 3		6cyl.	10300cc	294kW (400PS)	Diesel	Turbo Intercooled	TD24541
08-121900-00	STD	125.00	3.500		008 CK P		KV1
[R67590]	3.000			026 IWU		F12/F14	
	4.000			231 CR P		GOE13	

44



F3AE9687 AE001 Euro 5 (Cursor 10)		6cyl.	10300cc	315kW (428PS)	Diesel	Turbo Intercooled	FM15707
08-434100-00	STD	125.00	2.500		008 CK P		KV1
			3.000		050 NT P		F12/F14
			4.000		231 CR P		GOE12

45



203 A/61		6cyl.	11548cc	130kW (177PS)	Diesel		TD7375
203 H 61		6cyl.	11548cc	132kW (180PS)	Diesel		TD7348
310 H/61		6cyl.	11548cc		Diesel		FM3512
08-420100-00	STD	130.00	4.000		008 CR P		KV1
08-420108-00	0.60mm		3.000		001 IF P		STD
[R46790]			3.000		023 P		STD
			5.500		231 P		STD
08-420200-00	STD		130.00	4.000		008 CR P	
08-420208-00	0.60mm	3.000			001 IF P		STD
[R46800]		3.000			023 P		STD
		5.500			231 P		STD
		5.500			030 P		STD



46

F3B3681A Euro 4/5 (Cursor 13 E 56)	6cyl.	12880cc	412kW (560PS)	Diesel	Turbo Intercooled	TD20481
F3B3681B Euro 4/5 (Cursor 13 E 50)	6cyl.	12880cc	368kW (500PS)	Diesel	Turbo Intercooled	TD20480
F3B3681C Euro 4/5 (Cursor 13 E 45)	6cyl.	12880cc	332kW (452PS)	Diesel	Turbo Intercooled	TD20474
F3B3681D Euro 4/5 (Cursor 13 E 41)	6cyl.	12880cc	301kW (409PS)	Diesel	Turbo Intercooled	TD20470
F3B3681E Euro 4/5 (Cursor 13 E 48)	6cyl.	12880cc	353kW (480PS)	Diesel	Turbo Intercooled	TD20479
F3B3681G Euro 4/5 (Cursor 13 E 44)	6cyl.	12880cc	324kW (440PS)	Diesel	Turbo Intercooled	TD20473
F3BE3681A Euro 4/5	6cyl.	12880cc	412kW (560PS)	Diesel	Turbo Intercooled	TD20645
F3BE3681B Euro 4/5 (Cursor 13 E 50)	6cyl.	12880cc	368kW (500PS)	Diesel	Turbo Intercooled	TD21089
F3BE3681C Euro 4/5 (Cursor 13 E 45)	6cyl.	12880cc	332kW (452PS)	Diesel	Turbo Intercooled	TD21057
F3BE3681D Euro 4/5	6cyl.	12880cc	302kW (410PS)	Diesel	Turbo Intercooled	TD20632
F3BE3681E Euro 4/5	6cyl.	12880cc	382kW (520PS)	Diesel	Turbo Intercooled	TD20644
F3BE3681F Euro 4/5	6cyl.	12880cc	353kW (480PS)	Diesel	Turbo Intercooled	TD20641
F3BE3681G Euro 4/5	6cyl.	12880cc	324kW (440PS)	Diesel	Turbo Intercooled	TD20633
08-428000-00	STD	135.00	3.000		008 CK P	KV1
			3.000		026 IWU CR P	F12/F14
			5.000		231 CR P	GOE12

47

F3BE 0681 A Euro 3 (Cursor 13-540)	6cyl.	12880cc	397kW (540PS)	Diesel	Turbo Intercooled	TD16505
F3BE 0681 B Euro 3 (Cursor 13-500)	6cyl.	12880cc	368kW (500PS)	Diesel	Turbo Intercooled	TD16550
F3BE 0681 C Euro 3 (Cursor 13-440)	6cyl.	12880cc	324kW (440PS)	Diesel	Turbo Intercooled	TD16507
F3BE 0681 D Euro 3	6cyl.	12880cc	330kW (449PS)	Diesel	Turbo Intercooled	TD20620
F3BE 0681 E Euro 3 (Cursor 13-480)	6cyl.	12880cc	353kW (480PS)	Diesel	Turbo Intercooled	TD16506
F3BE 0681 F Euro 3	6cyl.	12880cc	367kW (499PS)	Diesel	Turbo Intercooled	TD20622
F3BE 0681 G Euro 3 (Cursor 13-380)	6cyl.	12880cc	280kW (381PS)	Diesel	Turbo Intercooled	TD16591
08-122000-00	STD	135.00	4.000		008 CK P	KV1
08-122008-00	0.60mm		3.000		026 IWU CR P	F12/F14
[R67600]			5.000		231 CR P	GOE13



48





8210.02	6cyl.	13798cc	191kW (260PS)	Diesel	TD10598
8210.02.000	6cyl.	13798cc	191kW (260PS)	Diesel	TD6868
8210.02.020	6cyl.	13798cc	191kW (260PS)	Diesel	TD6864
8210.02.022	6cyl.	13798cc	191kW (260PS)	Diesel	TD6877
8210.02.032	6cyl.	13798cc	191kW (260PS)	Diesel	TD6923
8210.02.053	6cyl.	13798cc	191kW (260PS)	Diesel	TD6266
8210.02.067	6cyl.	13798cc	191kW (260PS)	Diesel	TD5622
8210.02.067	6cyl.	13798cc	191kW (260PS)	Diesel	TD10523
8210.02.069	6cyl.	13798cc	191kW (260PS)	Diesel	TD5959
8210.02.069	6cyl.	13798cc	191kW (260PS)	Diesel	TD10525
8210.02.081	6cyl.	13798cc	191kW (260PS)	Diesel	TD6865
8210.02.266	6cyl.	13798cc	191kW (260PS)	Diesel	TD5635
8210.02.267	6cyl.	13798cc	191kW (260PS)	Diesel	TD5976
8210.02.371	6cyl.	13798cc	191kW (260PS)	Diesel	TD5619
8210.02.371	6cyl.	13798cc	191kW (260PS)	Diesel	TD10507
8210.02.373	6cyl.	13798cc	191kW (260PS)	Diesel	TD5621
8210.02.373	6cyl.	13798cc	191kW (260PS)	Diesel	TD10508
8210.02.377	6cyl.	13798cc	191kW (260PS)	Diesel	TD5958
8210.02.377	6cyl.	13798cc	191kW (260PS)	Diesel	TD10509
8210.02.385	6cyl.	13798cc	191kW (260PS)	Diesel	TD6899
8210.02.393	6cyl.	13798cc	191kW (260PS)	Diesel	TD6259
8210.02.393	6cyl.	13798cc	191kW (260PS)	Diesel	TD10510
8210.02.405	6cyl.	13798cc	191kW (260PS)	Diesel	TD7254
8210.02.426	6cyl.	13798cc	191kW (260PS)	Diesel	TD7359
8210.02.440	6cyl.	13798cc	191kW (260PS)	Diesel	TD5617
8210.02.440	6cyl.	13798cc	191kW (260PS)	Diesel	TD10491
8210.02.441	6cyl.	13798cc	191kW (260PS)	Diesel	TD5956
8210.02.441	6cyl.	13798cc	191kW (260PS)	Diesel	TD10492
8210.02.731	6cyl.	13798cc	191kW (260PS)	Diesel	TD5973
8210.02.731	6cyl.	13798cc	191kW (260PS)	Diesel	TD10524
8211.02	6cyl.	13798cc		Diesel	FM10601
8211.02.032	6cyl.	13798cc	191kW (260PS)	Diesel	TD6376
8215.02	6cyl.	13798cc		Diesel	FM3514

08-207800-30	STD	137.00	4.000		008 CR P	KV1
[R46840]			3.000		005 P	STD
			3.000		026 P	STD
			5.500		231 CR P	STD





49

8210.22	6cyl.	13798cc	221-224kW (300-305PS)	Diesel	Turbo	FM4024
8210.22.069	6cyl.	13798cc	221-224kW (300-305PS)	Diesel	Turbo	TD6885
8210.22.101	6cyl.	13798cc	224kW (305PS)	Diesel	Turbo	TD6881
8210.22.105	6cyl.	13798cc	243kW (330PS)	Diesel	Turbo	TD10550
8210.22.171	6cyl.	13798cc	224kW (305PS)	Diesel	Turbo	TD10530
8210.22.175	6cyl.	13798cc	224kW (305PS)	Diesel	Turbo	TD5960
8210.22.183	6cyl.	13798cc	224kW (305PS)	Diesel	Turbo	TD7340
8210.22.210	6cyl.	13798cc	224kW (305PS)	Diesel	Turbo	TD11387
8210.22.235	6cyl.	13798cc	224kW (305PS)	Diesel	Turbo	TD7352
8210.22.236	6cyl.	13798cc	224kW (305PS)	Diesel	Turbo	TD11388
8210.22.269	6cyl.	13798cc	224kW (305PS)	Diesel	Turbo	TD5630
8210.22.317	6cyl.	13798cc	224kW (305PS)	Diesel	Turbo	TD6260
8210.22.327	6cyl.	13798cc	224kW (305PS)	Diesel	Turbo	TD10585
8210.22.373	6cyl.	13798cc	224kW (305PS)	Diesel	Turbo	TD6878
8210.22.385	6cyl.	13798cc	224kW (305PS)	Diesel	Turbo	TD6264
8210.22.406	6cyl.	13798cc	224kW (305PS)	Diesel	Turbo	TD7255
8210.22.523	6cyl.	13798cc	224kW (305PS)	Diesel	Turbo	TD11391
8210.22X.235	6cyl.	13798cc	224kW (305PS)	Diesel	Turbo	TD11407
8211.22	6cyl.	13798cc		Diesel	Turbo	FM24024
8217.32	6cyl.	13798cc		Diesel	Turbo	FM9116

08-207800-10 [R46870]	STD	137.00	4.000		008 CR P	KV1
			3.000		005 P	STD
			3.000		005 P	STD
			5.500		231 CR P	STD

50

8210.42	6cyl.	13798cc	346kW (471PS)	Diesel	Turbo Intercooled	TD10564
8210.42.009	6cyl.	13798cc	265kW (360PS)	Diesel	Turbo Intercooled	TD7356
8210.42.101	6cyl.	13798cc	265kW (360PS)	Diesel	Turbo Intercooled	TD7336
8210.42.115	6cyl.	13798cc	265kW (360PS)	Diesel	Turbo Intercooled	TD7341
8210.42K Euro 1	6cyl.	13798cc	272kW (370PS)	Diesel	Turbo Intercooled	TD10809
8210.42L Euro 2	6cyl.	13790cc	309kW (420PS)	Diesel	Turbo	TD7378

08-783000-00 [R47220]	STD	137.00	4.000		008 CR P	KV1
			3.000		005 CR P	IKA
			5.500		231 CR P	STD



51

8260.02	6cyl.	12880cc		Diesel	FM4023
8260.02.405	6cyl.	12880cc	191kW (260PS)	Diesel	TD7362
8261.02.002	6cyl.	12880cc	165kW (224PS)	Diesel	TD20430
8261.1.002	6cyl.	12880cc	165kW (224PS)	Diesel	FM14023
8280.01	V8cyl.	17174cc		Diesel	FM603
8280.01.000	V8cyl.	17174cc	246kW (335PS)	Diesel	TD6869
8280.02.000	V8cyl.	17174cc	259kW (352PS)	Diesel	TD6879
8280.02.024	V8cyl.	17174cc	259kW (352PS)	Diesel	TD6873
8280.02.082	V8cyl.	17174cc	259kW (352PS)	Diesel	TD6882
8280.02.109	V8cyl.	17174cc	259kW (352PS)	Diesel	TD10551
8280.02.125-135	V8cyl.	17174cc	259kW (352PS)	Diesel	TD5638
8280.02.265, 8280.02.273, 8280.02.279, 8280.02.410, 8280.02.412	V8cyl.	17174cc		Diesel	FM4026
8280.02.269	V8cyl.	17174cc	259kW (352PS)	Diesel	TD20431
8280.02.274	V8cyl.	17174cc	259kW (352PS)	Diesel	TD5639
8280.02.275	V8cyl.	17174cc	259kW (352PS)	Diesel	TD5980
8280.02.289	V8cyl.	17174cc	259kW (352PS)	Diesel	TD7354
8280.02.405	V8cyl.	17174cc	259kW (352PS)	Diesel	TD7360
8280.22.	V8cyl.	17174cc	280kW (381PS)	Diesel	TD10565
8280.22.007	V8cyl.	17174cc	280kW (381PS)	Diesel Turbo	TD10566
8280.22.009	V8cyl.	17200cc	280kW (381PS)	Diesel Turbo	TD10583
8280.22.033	V8cyl.	17174cc	280kW (381PS)	Diesel Turbo	TD10594
8280.22.054	V8cyl.	17174cc	280kW (381PS)	Diesel Turbo	TD10567
8280.22.201	V8cyl.	17174cc	309kW (420PS)	Diesel Turbo Intercooled	TD10569
8280.22.205	V8cyl.	17174cc	309kW (420PS)	Diesel Turbo Intercooled	TD10570
8280.42.001	V8cyl.	17174cc	350kW (476PS)	Diesel Turbo Intercooled	TD10572
8280.42.050	V8cyl.	17174cc	350kW (476PS)	Diesel Turbo Intercooled	TD10571
8280.42S (TCA)	V8cyl.	17173cc	378kW (514PS)	Diesel Turbo Intercooled	TD10577
8280.42S.342 Euro 2	V8cyl.	17174cc	378kW (514PS)	Diesel Turbo Intercooled	TD20432
8280.42S.350	V8cyl.	17174cc	375kW (510PS)	Diesel Turbo Intercooled	TD10516
8280.42S.352	V8cyl.	17174cc	378kW (514PS)	Diesel Turbo Intercooled	TD20433
8280.42S.362	V8cyl.	17174cc	378kW (514PS)	Diesel Turbo Intercooled	TD20434
8281.02	V8cyl.	17174cc		Diesel	FM14026
8281.22.201	V8cyl.	17174cc	309kW (420PS)	Diesel Turbo Intercooled	TD6378
8285.02	V8cyl.	17174cc		Diesel	FM9234
8285.22	V8cyl.	17174cc		Diesel Turbo	FM14027

08-782100-00	STD	145.00	4.000		008 CR P	KV1
[R47160]			3.000		005 IF CR P	IKA
			6.000		231 CR P	STD

MODEL INDEX

Modelverzeichnis • Index de modele • Índice de Modelo
Indeks modelu • Модель автомобиля • دليل الموديل



CCM

x



9

05/75→07/81	2.8 - 5.3 Double Six 5.3	V 12 (75-79)	Petrol	5343	V12	8
07/81→10/86	2.8 - 5.3 Double Six H.E. 5.3	V 12 (82-90)	Petrol	5343	V12	9
06/76→03/79	2.8 - 5.3 Sovereign 4.2	XK 4.2 (-79)	Petrol	4235	6	10
03/79→10/86	2.8 - 5.3 Sovereign 4.2	XK 4.2 (82-87)	Petrol	4235	6	10
01/65→12/71	E-Type 420	XK (4.2)	Petrol	4235	6	10
01/58→12/61	Mk9 3.8	XK (3.8)	Petrol	3781	6	7
01/64→12/66	Mk10	XK (4.2)	Petrol	4235	6	10
01/61→12/65	Mk10 3.8	XK (3.8)	Petrol	3781	6	7
01/59→12/68	MkIX 3.8	3.8	Petrol	3781	6	6
01/59→12/68	MkX 3.8	3.8	Petrol	3781	6	6
06/04→10/07	S-Type 2.7 D	AJD	Diesel	2720	V6	1
04/11→	XF 2.2 D	224DT	Diesel	2179	4	4
03/08→	XF 2.7 D	AJD	Diesel	2720	V6	1
03/09→	XF 3.0 D	306DT Euro 5	Diesel	2993	V6	3
03/09→	XF 3.0 D	AJV6D	Diesel	2993	V6	3
03/12→	XF 3.0 D AWD	306DT Euro 5	Diesel	2993	V6	3
03/12→	XF 3.0 D AWD	AJV6D	Diesel	2993	V6	3
09/12→	XF Sportbrake 2.2 D	224DT	Diesel	2179	4	4
09/12→	XF Sportbrake 3.0 D	306DT Euro 5	Diesel	2993	V6	3
09/12→	XF Sportbrake 3.0 D	AJV6D	Diesel	2993	V6	3
10/09→	XJ 3.0 V6 D	AJV6D	Diesel	2993	V6	3
10/05→03/09	XJ 6 2.7 D	AJD	Diesel	2720	V6	1
09/85→12/86	XJ 6 4.2	8L (85-87)	Petrol	4235	6	10
01/71→12/78	XJ 6 4.2	XK (4.2)	Petrol	4235	6	10
01/75→09/79	XJ 6 4.2	XK 4.2	Petrol	4235	6	10
09/79→12/87	XJ 6 4.2	XK 4.2	Petrol	4235	6	10
05/75→12/82	XJ 12 5.3	V 12 (75-79)	Petrol	5343	V12	8
01/86→12/89	XJ Coupe 5.3	V 12 (90-93)	Petrol	5343	V12	9
07/85→12/92	XJ Sovereign V12	V 12 (90-93)	Petrol	5343	V12	9
01/86→05/88	XJSC Convertible 5.3	V 12 (90-93)	Petrol	5343	V12	9
01/48→12/57	XK 120	XK (3.4)	Petrol	3442	6	2
01/48→12/57	XK 140	XK (3.4)	Petrol	3442	6	2
01/57→12/61	XK 150	XK (3.4)	Petrol	3442	6	2
01/59→12/68	XK 150 3.8	3.8	Petrol	3781	6	6
01/59→12/61	XK 150 3.8	XK (3.8)	Petrol	3781	6	7
01/58→12/61	XK 150 S-Type	XK (3.4)	Petrol	3442	6	2
10/05→11/09	X-Type 2.2 D	LJ46G	Diesel	2198	4	5
10/05→11/09	X-Type 2.2D	QJBA (Duratorq TDCI)	Diesel	2198	4	5
10/05→12/09	X-Type Estate 2.2 D	LJ46G	Diesel	2198	4	5
10/05→12/09	X-Type Estate 2.2D	QJBA (Duratorq TDCI)	Diesel	2198	4	5

Motorverzeichnis • Index de moteur • Índice de Motor
Indeks silnika • Модель двигателя • دليل المحرك

ENGINE INDEX



CCM

x



9

3.8	Petrol	3781	6	86.99	6
8L (85-87)	Petrol	4235	6	92.07	10
224DT	Diesel	2179	4	85.00	4
306DT Euro 5	Diesel	2993	V6	84.00	3
AJD	Diesel	2720	V6	81.00	1
AJV6D	Diesel	2993	V6	84.00	3
LJ46G	Diesel	2198	4	86.00	5
QJBA (Duratorq TDCI)	Diesel	2198	4	86.00	5
V 12 (75-79)	Petrol	5343	V12	90.00	8
V 12 (82-90)	Petrol	5343	V12	90.00	9
V 12 (90-93)	Petrol	5343	V12	90.00	9
XK (3.4)	Petrol	3442	6	82.99	2
XK (3.8)	Petrol	3781	6	86.99	7
XK (4.2)	Petrol	4235	6	92.07	10
XK 4.2	Petrol	4235	6	92.07	10
XK 4.2 (-79)	Petrol	4235	6	92.07	10
XK 4.2 (82-87)	Petrol	4235	6	92.07	10



S-Type 2.7 D		06/04→10/07	AJD		V6cyl. 2720cc	152kW (207PS)	TD25810	1
XF 2.7 D		03/08→						
XJ 6 2.7 D		10/05→03/09						
			Diesel	Turbo				

08-432400-00	STD	81.00	2.000		001 IF CK	KV1
			2.000		005 IFU	GOE13
			2.000		231	F12/F14

XK 120, XK 140		01/48→12/57	XK (3.4)		6cyl. 3442cc	FM895	2
XK 150		01/57→12/61					
XK 150 S-Type		01/58→12/61					

08-529907-00	.020	82.99	2.000		005 P	IKA		
			08-529909-00	.030	2.000		001 P	GOE12
			08-529911-00	.040	3.960		030 P	GOE12
					3.960		030 P	GOE12

XF 3.0 D		03/09→	306DT Euro 5		V6cyl. 2993cc	177-202kW (241-275PS)	TD27175	3
XF 3.0 D AWD		03/12→						
XF Sportbrake 3.0 D		09/12→						
			Diesel	Turbo				

XF 3.0 D		03/09→	AJV6D		V6cyl. 2993cc	155-202kW (211-275PS)	TD25809	
XF 3.0 D AWD		03/12→						
XF Sportbrake 3.0 D		09/12→						
XJ 3.0 V6 D		10/09→	Diesel					

08-439100-00	STD	84.00	2.000		001 IF CK P	KV1
			2.000		005 IFU P	F12/F14
			2.000		231 LKZ CR P	GOE13

XF 2.2 D		04/11→	224DT		4cyl. 2179cc	110-147kW (150-200PS)	TD26822	4
XF Sportbrake 2.2 D		09/12→						
			Diesel	Turbo				

08-436700-00	STD	85.00	2.500		008 GDC P	KV1
			2.000		005 IFU P	STD
			2.000		231 LKZ CK	GOE13



X-Type 2.2 D X-Type Estate 2.2 D	10/05→11/09 10/05→12/09	LJ46G	4cyl. 2198cc 107-114kW (146-155PS)	5
		Diesel	Turbo Intercooled	TD24454

X-Type 2.2D X-Type Estate 2.2D	10/05→11/09 10/05→12/09	QJBA (Duratorq TDCI)	4cyl. 2198cc 114kW (155PS)	
		Diesel	Turbo Intercooled	TD24400

08-427700-00	STD	86.00	2.000		001 IF CK P	KV1
08-427707-00	0.50mm		2.000		026 P	GOE13
			2.000		231 NT	ST

MkIX 3.8, MkX 3.8, XK 150 3.8	01/59→12/68	3.8	6cyl. 3781cc	6
				FM2524

08-522600-00	STD	86.99	1.970		001 CR P	
08-522607-00	.020		1.990		026 P	
[R32592K]			3.970		232 P	

Mk9 3.8 Mk10 3.8 XK 150 3.8	01/58→12/61 01/61→12/65 01/59→12/61	XK (3.8)	6cyl. 3781cc	7
				FM896

08-525500-00	STD	86.99	1.990		001 P	IKA
08-525507-00	.020		1.990		026 P	GOE12
08-525509-00	.030		3.973		232 P	GOE12
[R16586]						

XJ 12 5.3	05/75→12/82	V 12 (75-79)	V12cyl. 5343cc 211kW (287PS)	8
				TD1731

2.8 - 5.3 Double Six 5.3	05/75→07/81	V 12 (75-79)	V12cyl. 5343cc 211kW (287PS)	
				TD5221

08-523600-00	STD	90.00	1.600		001 IF CR P	KV1
[R26136]			2.000		026 P	GOE12
			4.000		231	GOE12



2.8 - 5.3 Double Six H.E. 5.3	07/81→10/86	V 12 (82-90)	V12cyl. 5343cc	217kW (295PS)	9
					TD816

XJ Sovereign V12	07/85→12/92	V 12 (90-93)	V12cyl.		
XJ Coupe 5.3	01/86→12/89		5343cc	197kW (268PS)	
XJSC Convertible 5.3	01/86→05/88				TD4583

08-526700-00	STD	90.00	1.600		001 CR P	KV1
[R40300]			2.000		026 P	GOE12
			3.950		231 P	GOE12

XJ 6 4.2	09/85→12/86	8L (85-87)	6cyl. 4235cc	133kW (181PS)	10
					TD5202

E-Type 420	01/65→12/71	XK (4.2)	6cyl.		
Mk10	01/64→12/66		4235cc	124kW (168PS)	
XJ 6 4.2	01/71→12/78				FM898

XJ 6 4.2	01/75→09/79	XK 4.2	6cyl. 4235cc	124kW (168PS)	
					TD1737

XJ 6 4.2	09/79→12/87	XK 4.2	6cyl. 4235cc	151kW (205PS)	
					TD5199

2.8 - 5.3 Sovereign 4.2	06/76→03/79	XK 4.2 (-79)	6cyl. 4235cc	124kW (168PS)	
					TD5219

2.8 - 5.3 Sovereign 4.2	03/79→10/86	XK 4.2 (82-87)	6cyl. 4235cc	151kW (205PS)	
					TD5220

08-524000-00	STD	92.07	1.990		001 CR P	KV1
08-524007-00	.020		1.990		026 P	GOE12
[R39520V1]			4.770		231 CR P	GOE12

Modelverzeichnis • Index de modele • Índice de Modelo
Indeks modelu • Модель автомобиля • دليل الموديل

MODEL INDEX



CCM

x



9

10/86→09/92	Cherokee 2.1 D 4x4	J8S 742	Diesel	2068	4	2
	Cherokee 2.1 D 4x4	J8S-890	Diesel	2068	4	3
04/84→08/95	Cherokee 2.1TD	J8S-890	Diesel	2068	4	3
01/00→	Cherokee 2.5 TD	RG	Diesel	2499	4	5
01/83→12/87	CJ5 - CJ8 2.0	J5R-800	Petrol	1995	4	4
01/83→12/87	CJ5 - CJ8 2.1 D	J8S-800	Diesel	2068	4	3
01/85→	CJ-7	829, J6R, ZEJ	Petrol	1995	4	4
01/85→	CJ-7 Laredo	829, J6R, ZEJ	Petrol	1995	4	4
10/86→09/90	Comanche 2.1 D	J8S-814	Diesel	2068	4	3
10/86→09/90	Comanche 2.1 D 4x4	J8S-814	Diesel	2068	4	3
12/10→	Compass 2.2 CRD 4x4	OM 651.925	Diesel	2143	4	1

Motorverzeichnis • Index de moteur • Índice de Motor
Indeks silnika • Модель двигателя • دليل المحرك

ENGINE INDEX



CCM

x



9

829, J6R, ZEJ	Petrol	1995	4	88.00	4
J5R-800	Petrol	1995	4	88.00	4
J8S 742	Diesel	2068	4	86.00	2
J8S-800	Diesel	2068	4	86.00	3
J8S-814	Diesel	2068	4	86.00	3
J8S-890	Diesel	2068	4	86.00	3
OM 651.925	Diesel	2143	4	83.00	1
RG	Diesel	2499	4	92.00	5



Compass 2.2 CRD 4x4		12/10→	OM 651.925				1
					4cyl.		
					2143cc	100-120kW (136-163PS)	
					Diesel	Turbo Intercooled	TD25244
08-433400-00	STD	83.00	2.000		001 GDC P		KV1
08-433405-00	0.25mm				005 IF P		F12/F14
08-433407-00	0.50mm		1.750			231 CR P	
			2.000				

Cherokee 2.1 D 4x4		10/86→09/92	J8S 742				2
					4cyl.		
					2068cc	59kW (80PS)	
					Diesel	Turbo	TD22464
08-335400-00	STD	86.00	2.500		008 P PS		KV1
[R66420]			2.500		023 P		STD
			4.000			231 CR P	

CJ5 - CJ8 2.1 D		01/83→12/87	J8S-800				3
					4cyl.		
					2068cc	44kW (60PS)	
					Diesel		TD1750



Comanche 2.1 D, Comanche 2.1 D 4x4		10/86→09/90	J8S-814				
					4cyl.		
					2068cc	63-65kW (86-88PS)	
					Diesel		TD1745

Cherokee 2.1 D 4x4		04/84→08/95	J8S-890				
Cherokee 2.1TD					4cyl.		
					2068cc	65kW (88PS)	
					Diesel	Turbo	TD1749
08-337100-00	STD	86.00	2.250		001 IF P PS		KV1
[R66340]			2.000		005 IFU P		F12/F14
			3.000			231 CR P	

CJ-7, CJ-7 Laredo		01/85→	829, J6R, ZEJ				4
					4cyl.		
					1995cc		
							FM319

CJ5 - CJ8 2.0		01/83→12/87	J5R-800				
					4cyl.		
					1995cc	61-63kW (85-86PS)	
							TD1747
08-334400-00	STD	88.00	1.750		001 IF MO P		IKA
[R66300]			2.000		026 P		STD
			4.000			712 CR	



Cherokee 2.5 TD		01/00→	RG		4cyl.	5
					2499cc	104kW (141PS)
					Diesel	Turbo Intercooled
						FM9078
08-134100-00	STD	92.00	2.500		008 CK P	KV1
<i>[R67370]</i>			1.500		026 P	IKA
			2.000		231	GOE13



1

MD11E-1		6cyl.	11100cc		Diesel Turbo	FM6422
SW680		6cyl.	11100cc		Diesel Turbo	FM6420
SWT11		6cyl.	11100cc		Diesel Turbo	FM6421
08-103700-00	STD	127.00	3.000		008 CK P	KV1
			3.000		005 NT	IKA
			4.000		231 CR P	STD



1

3164DL03		3cyl.	2696cc		Diesel		FM5568
4219 DL 01		4cyl.	3588cc	50kW (68PS)	Diesel		TD19035
4219 DL 03		4cyl.	3588cc	50kW (68PS)	Diesel		TD19033
6329 DL 03		6cyl.	5395cc	63kW (86PS)	Diesel		TD19034
08-181800-00	STD	102.00	3.170		008 IF MO P		KV1
			2.385		005 IFU P		STD
			5.000		231 CR P		STD

2

300 T		6cyl.	5878cc	130kW (177PS)	Diesel	Turbo Intercooled	FM23185
3179 T		3cyl.	2938cc	59kW (80PS)	Diesel	Turbo	FM13180
3239DL		3cyl.	2983cc		Diesel		FM6423
4039T		4cyl.	3918cc	82kW (111PS)	Diesel	Turbo	FM13182
4045 D, 4045 T		4cyl.	4525cc	55-89kW (75-121PS)	Diesel	Turbo	FM18848
4239 A		4cyl.	3918cc	87kW (118PS)	Diesel	Turbo Intercooled	FM18779
4239DL		4cyl.	3918cc		Diesel		FM8779
4239T		4cyl.	3918cc		Diesel	Turbo	FM8780
6059.T		6cyl.	5878cc	123kW (167PS)	Diesel	Turbo	TD19032
6068 D, 6068 T		6cyl.	6788cc	97-130kW (132-177PS)	Diesel		FM18849
6359A		6cyl.	5876cc	131kW (178PS)	Diesel	Turbo Intercooled	FM28781
6359DL		6cyl.	5876cc		Diesel		FM8781
08-181100-00	STD	106.50	3.150		008 MOL P		KV1
			2.385		005 IFU P		STD
			3.465		231 CR P		STD

MODEL INDEX

Modelverzeichnis • Index de modele • Índice de Modelo
Indeks modelu • Модель автомобиля • دليل الموديل



CCM

x



9

02/96→	Besta Box 2.2 D	R2	Diesel	2184	4	7
10/03→	Bongo Bus 2.7 D	J2	Diesel	2665	4	9
10/03→	Bongo MPV 2.7 D	J2	Diesel	2665	4	9
03/97→09/03	Bongo Platform/Chassis 2.7 D	J2	Diesel	2665	4	9
07/02→	Carens II 2.0 CRDi	D4EA Euro 3	Diesel	1991	4	5
05/07→	Carens III 2.0 CRDi 115	D4EA Euro 3	Diesel	1991	4	5
08/09→	Carens III 2.0 CRDi 135	D4EA Euro 3	Diesel	1991	4	5
09/06→	Carens III 2.0 CRDi 140	D4EA Euro 3	Diesel	1991	4	5
07/05→	Cerato 1.5 CRDi	D4FA Euro 3	Diesel	1493	4	1
07/04→	Cerato 1.6	G4ED Euro 4	Petrol	1599	4	3
04/04→	Cerato 2.0 CRDi	D4EA Euro 3	Diesel	1991	4	5
07/05→	Cerato Saloon 1.5 CRDi	D4FA Euro 3	Diesel	1493	4	1
04/04→	Cerato Saloon 1.6	G4ED Euro 4	Petrol	1599	4	3
04/04→	Cerato Saloon 2.0 CRDi	D4EA Euro 3	Diesel	1991	4	5
01/84→03/89	Jumbo Titan 3.5	SL	Diesel	3455	4	10
03/97→	K2700 2.7 D	J2	Diesel	2665	4	9
11/05→	Magentis 2.0 CRDi	D4EA Euro 3	Diesel	1991	4	5
10/97→	Pregio Box 2.7 D	J2	Diesel	2665	4	9
03/05→	Pride 1.4 LX	G4EE Euro 4	Petrol	1399	4	2
03/05→	Pride 1.5 CRDi LX	D4FA Euro 3	Diesel	1493	4	1
03/05→	Pride 1.6 CVT LX	G4ED Euro 4	Petrol	1599	4	3
01/84→03/89	P-WEL4 Series 3.5	SL	Diesel	3455	4	10
03/05→	Rio II 1.4 16V	G4EE Euro 4	Petrol	1399	4	2
03/05→	Rio II 1.5 CRDi	D4FA Euro 3	Diesel	1493	4	1
03/05→	Rio II 1.6 CVT	G4ED Euro 4	Petrol	1599	4	3
03/05→	Rio II Saloon 1.4 16V	G4EE Euro 4	Petrol	1399	4	2
03/05→	Rio II Saloon 1.5 CRDi	D4FA Euro 3	Diesel	1493	4	1
03/05→	Rio II Saloon 1.6 16V	G4ED Euro 4	Petrol	1599	4	3
01/92→	Sephia 1.5	NB-3 (BT-57)	Petrol	1498	4	4
08/02→	Sorento I 2.5 CRDi	D4CB Euro 4	Diesel	2497	4	8
02/05→	Sportage 2.0 CRDi	D4EA Euro 3	Diesel	1991	4	5
09/04→	Sportage 2.0 CRDi 4WD	D4EA Euro 3	Diesel	1991	4	5
04/94→08/99	Sportage 2.0 i 4WD	FE	Petrol	1998	4	6
	Trade 3.5	SL	Diesel	3455	4	10

ENGINE INDEX

Motorverzeichnis • Index de moteur • Índice de Motor
Indeks silnika • Модель двигателя • دليل المحرك



CCM

x



9

D4CB Euro 4	Diesel	2497	4	91.00	8
D4EA Euro 3	Diesel	1991	4	83.00	5
D4FA Euro 3	Diesel	1493	4	75.00	1
FE	Petrol	1998	4	86.00	6
G4ED Euro 4	Petrol	1599	4	76.50	3
G4EE Euro 4	Petrol	1399	4	75.50	2
J2	Diesel	2665	4	94.50	9
NB-3 (BT-57)	Petrol	1498	4	78.00	4
R2	Diesel	2184	4	86.00	7
SL	Diesel	3455	4	100.00	10



Cerato 1.5 CRDi, Cerato Saloon 1.5 CRDi		07/05→	D4FA Euro 3		1
Pride 1.5 CRDi LX, Rio II 1.5 CRDi, Rio II Saloon 1.5 CRDi		03/05→	4cyl. 1493cc 75kW (102PS)		
			Diesel Turbo Intercooled		TD18454

08-849000-00	STD	75.00	1.750		001 IF NT	ST
08-849007-00	0.50mm		1.750		005 IW CR P	STD
			3.000		231 NT	ST

Pride 1.4 LX, Rio II 1.4 16V, Rio II Saloon 1.4 16V		03/05→	G4EE Euro 4		2
			4cyl. 1399cc 71kW (96PS)		
					TD19959

08-849200-50	STD	75.50	1.200		001 IF CR	ST
08-849207-50	0.50mm		1.200		026 P	F12/F14
			2.000		712	ST

Cerato 1.6		07/04→	G4ED Euro 4		3
Cerato Saloon 1.6		04/04→	4cyl. 1599cc 77kW (105PS)		
Pride 1.6 CVVT LX, Rio II 1.6 CVVT, Rio II Saloon 1.6 16V		03/05→			TD18452

08-848300-50	STD	76.50	1.200		001 IF CR	ST
08-848307-50	0.50mm		1.200		026 P	GOE13
			2.000		712 NT	ST

Sephia 1.5		01/92→	NB-3 (BT-57)		4
			4cyl. 1498cc		
					FM9363

08-253200-00	STD	78.00	1.500		001 CR P	KV1
			1.500		026 P	STD
			3.000		712 CR	ST

Carens II 2.0 CRDi		07/02→	D4EA Euro 3		5
Carens III 2.0 CRDi 115		05/07→	4cyl. 1991cc 83kW (113PS)		
Carens III 2.0 CRDi 135		08/09→	Diesel Turbo Intercooled		
Carens III 2.0 CRDi 140		09/06→			
Cerato 2.0 CRDi, Cerato Saloon 2.0 CRDi		04/04→			
Magentis 2.0 CRDi		11/05→			
Sportage 2.0 CRDi		02/05→			
Sportage 2.0 CRDi 4WD		09/04→			TD18131

08-431900-00	STD	83.00	1.950		008 CK	ST
08-431907-00	0.50mm		2.000		005 CR P	STD
			3.000		231 NT	ST



Sportage 2.0 i 4WD		04/94→08/99	FE	4cyl. 1998cc 70kW (95PS)		6
				Diesel		TD9379

08-282700-10 [R41520]	STD	86.00	1.500		001 IF CR P	KV1
			1.500		026 P	STD
			4.000		712 CR	ST

Besta Box 2.2 D		02/96→	R2	4cyl. 2184cc 48kW (65PS)		7
				Diesel		TD11132

08-283600-00 08-283607-00 08-283611-00 [R42580]	STD 0.50mm 1.00mm	86.00	2.000		001 CR P	KV1
			2.000		005 IW P	STD
			4.000		231 CR P	STD

Sorento I 2.5 CRDi		08/02→	D4CB Euro 4	4cyl. 2497cc 103kW (140PS)		8
				Diesel Turbo Intercooled		TD19955

08-431700-00 08-431707-00	STD 0.50mm	91.00	2.500		007 CK P	KV4
			2.000		001 IW CR P	GOE13
			3.000		231 NT	ST

Bongo Bus 2.7 D, Bongo MPV 2.7 D Bongo Platform/Chassis 2.7 D K2700 2.7 D Pregio Box 2.7 D		10/03→ 03/97→09/03 03/97→ 10/97→	J2	4cyl. 2665cc 61kW (82PS)		9
				Diesel		TD22112

08-431800-00 08-431807-00	STD 0.50mm	94.50	2.000		001 CR P	KV1
			2.000		005 IW CR P	IKA
			3.000		231 CR P	STD

Jumbo Titan 3.5, P-WEL4 Series 3.5 Trade 3.5		01/84→03/89	SL	4cyl. 3455cc 66-77kW (90-105PS)		10
				Diesel		FM3814

08-111900-00 [R42630]	STD	100.00	2.500		001 CR P	KV1
			2.000		005 IW CR P	STD
			4.500		231 CR P	STD





1							
4D95		4cyl.	3260cc	Diesel			FM6489
08-253400-00	STD	95.00	2.000		001 CR P	KV1	
			2.000		005 P	STD	
			4.000		231 CR P	STD	

2							
GA-655-A		4cyl.		Diesel			FM8836
08-117700-00	STD	105.00	3.000		008 CR P	KV1	
			2.500		011 CR P	STD	
			2.500		231 CR P	STD	



1

2000, 2200, 2400, 2600		4cyl.	Diesel			FM9013
08-106100-00	STD	76.00	2.500		007 CR P	STD
			1.970		026 P	STD
			5.000		231 CR P	KV1

Modelverzeichnis • Index de modele • Índice de Modelo
Indeks modelu • Модель автомобиля • دليل الموديل

MODEL INDEX



CCM

x



9

01/95→	110 1.5	BA3 2111	Petrol	1499	4	3
01/95→	110 1.5	VAZ-2111	Petrol	1499	4	3
10/00→	110 1.5	VAZ-2111	Petrol	1499	4	3
01/95→	110 1.5 16V	VAZ-2112	Petrol	1499	4	3
08/96→	110 2.0 i	C 20 XE	Petrol	1998	4	7
01/96→	111 1.5	VAZ-2111	Petrol	1499	4	3
10/00→	111 1.5	VAZ-2111	Petrol	1499	4	3
01/95→	111 1.5 16V	VAZ-2112	Petrol	1499	4	3
10/00→	111 1.5 16V	VAZ-2112	Petrol	1499	4	3
01/95→	112 1.5	VAZ-2111	Petrol	1499	4	3
10/00→	112 1.5	VAZ-2111	Petrol	1499	4	3
01/95→	112 1.5 16V	VAZ-2112	Petrol	1499	4	3
10/00→	112 1.5 16V	VAZ-2112	Petrol	1499	4	3
09/73→08/84	1200	BA3 2101	Petrol	1198	4	1
09/73→06/85	1200 1500	BA3 2103	Petrol	1452	4	1
09/72→08/84	1200 1600	BA3 2106	Petrol	1570	4	2
01/81→12/82	1200-1500 Estate 1300	BA3 2105	Petrol	1294	4	2
01/70→06/86	1200-1600 1200 L/S	BA3 2101	Petrol	1198	4	1
05/78→01/87	1200-1600 1300	BA3 21011	Petrol	1285	4	1
08/74→08/84	1200-1600 1300	BA3 2105	Petrol	1294	4	2
09/72→08/84	1200-1600 1500	BA3 2103	Petrol	1452	4	1
11/75→10/86	1200-1600 1500 N/S	BA3 2103	Petrol	1452	4	1
03/79→10/86	1200-1600 1600 N/L	BA3 2106	Petrol	1570	4	2
10/84→08/97	2104	B03, BA37 21, BA37 2102, BA37 2103, BA37 2104, BA37 21043, BA37 2105, BA37 21053, BA37 2107	Petrol	1452	4	1
10/83→11/91	2107	B03, BA37 21, BA37 2102, BA37 2103, BA37 2104, BA37 21043, BA37 2105, BA37 21053, BA37 2107	Petrol	1452	4	1
10/11→	Granta 1.6	VAZ-21126	Petrol	1597	4	4
	Kalina 1.6 Sport	VAZ-21126	Petrol	1596	4	4
07/77→10/91	Niva 4x4	B03, BA37 21, BA37 2102, BA37 2103, BA37 2104, BA37 21043, BA37 2105, BA37 21053, BA37 2107	Petrol	1452	4	1
01/87→03/95	Niva 1600	BA3 2121	Petrol	1569	4	2
04/80→12/87	Niva 1600	BA3 2121	Petrol	1569	4	2
12/76→05/87	Niva 1600	BA3 2121	Petrol	1569	4	2
01/93→	Niva 1900 Diesel	XUD9A	Diesel	1905	4	5
01/99→	Niva 1900 Diesel	XUD9SD	Diesel	1905	4	6
09/81→	Nova 1200 Junior/L	BA3 2101	Petrol	1198	4	1
05/81→	Nova 1300 Spezial/L	BA3 2105	Petrol	1294	4	2
05/93→04/04	Nova 1500	BA3 2103 (KAT)	Petrol	1451	4	1
06/89→	Nova 1500 S	BA3 21083	Petrol	1499	4	3
03/85→	Nova 1500 Special	BA3 2103	Petrol	1452	4	1
01/88→10/01	Nova 1600	BA3 2106	Petrol	1570	4	2
10/86→04/98	Nova Estate 1.5 1500	BA3 2103	Petrol	1452	4	1
09/85→12/90	Nova Estate 1300	BA3 2105	Petrol	1294	4	2
09/85→02/93	Nova Estate 1500	BA3 2103	Petrol	1452	4	1
08/94→	Nova Estate 1500	BA3 2103 (KAT)	Petrol	1451	4	1
10/09→	Priora Estate 1.6	VAZ-21126	Petrol	1597	4	4
12/08→	Priora Hatchback 1.6	VAZ-21126	Petrol	1597	4	4
12/08→	Priora Saloon 1.6	VAZ-21126	Petrol	1597	4	4
04/96→	Samara 1.5	VAZ-2111	Petrol	1499	4	3
02/88→12/94	Samara 1100	BA3 21081	Petrol	1100	4	1
02/96→	Samara 1100	BA3 21081 (KAT)	Petrol	1099	4	1
01/86→12/94	Samara 1300	BA3 2108	Petrol	1288	4	1
01/88→	Samara 1300	BA3 2108	Petrol	1288	4	1
09/91→	Samara 1300	BA3 2108 (KAT)	Petrol	1288	4	1
01/88→	Samara 1500	BA3 21083	Petrol	1499	4	3
09/91→	Samara 1500	BA3 21083 (KAT)	Petrol	1500	4	3

MODEL INDEX

Modelverzeichnis • Index de modele • Índice de Modelo
Indeks modelu • Модель автомобиля • دليل المحرك



CCM

x



9

02/95→	Samara 1500	BA3 2111	Petrol	1499	4	3
01/00→	Samara Forma 1.5	VAZ-2111	Petrol	1499	4	3
08/03→	Samara Forma 1.5	VAZ-2111	Petrol	1499	4	3
07/91→	Samara Forma 1100	BA3 21081 (KAT)	Petrol	1099	4	1
05/89→07/97	Samara Forma 1300	BA3 2108	Petrol	1288	4	1
05/90→	Samara Forma 1300	BA3 2108	Petrol	1288	4	1
07/91→	Samara Forma 1300	BA3 2108	Petrol	1288	4	1
09/91→	Samara Forma 1500	BA3 21083	Petrol	1499	4	3
07/91→	Samara Forma 1500	BA3 21083 (KAT)	Petrol	1500	4	3
11/94→	Samara Forma 1500	BA3 2111	Petrol	1499	4	3
12/85→05/12	Toscana 1300	BA3 2105	Petrol	1294	4	2
09/83→02/93	Toscana 1500	BA3 2103	Petrol	1452	4	1

ENGINE INDEX

Motorverzeichnis • Index de moteur • Índice de Motor
Indeks silnika • Модель двигателя • دليل المحرك



CCM

x



9

B03, BA37 21, BA37 2102, BA37 2103, BA37 2104, BA37 21043, BA37 2105, BA37 21053, BA37 2107	Petrol	1452	4	76.00	1
BA3 2101	Petrol	1198	4	76.00	1
BA3 21011	Petrol	1285	4	76.00	1
BA3 2103	Petrol	1452	4	76.00	1
BA3 2103 (KAT)	Petrol	1451	4	76.00	1
BA3 2105	Petrol	1294	4	79.00	2
BA3 2106	Petrol	1570	4	79.00	2
BA3 2108	Petrol	1288	4	76.00	1
BA3 2108 (KAT)	Petrol	1288	4	76.00	1
BA3 21081	Petrol	1100	4	76.00	1
BA3 21081 (KAT)	Petrol	1099	4	76.00	1
BA3 21083	Petrol	1499	4	82.00	3
BA3 21083 (KAT)	Petrol	1500	4	82.00	3
BA3 2111	Petrol	1499	4	82.00	3
BA3 2121	Petrol	1569	4	79.00	2
C 20 XE	Petrol	1998	4	86.00	7
VAZ-2111	Petrol	1499	4	82.00	3
VAZ-2112	Petrol	1499	4	82.00	3
VAZ-21126	Petrol	1596	4	82.00	4
VAZ-21126	Petrol	1597	4	82.00	4
XUD9A	Diesel	1905	4	83.00	5
XUD9SD	Diesel	1905	4	83.00	6



2104 2107 Niva 4x4	10/84→08/97 10/83→11/91 07/77→10/91	B03, BA37 21, BA37 2102, BA37 2103, BA37 2104, BA37 21043, BA37 2105, BA37 21053, BA37 2107	4cyl. 1452cc	55kW (75PS)	1	FM919
1200 1200-1600 1200 L/S Nova 1200 Junior/L	09/73→08/84 01/70→06/86 09/81→	BA3 2101	4cyl. 1198cc	44kW (60PS)		TD5182
1200-1600 1300	05/78→01/87	BA3 21011	4cyl. 1285cc	48kW (65PS)		TD5189
1200 1500 1200-1600 1500 1200-1600 1500 N/S Nova 1500 Special Nova Estate 1.5 1500 Nova Estate 1500 Toscana 1500	09/73→06/85 09/72→08/84 11/75→10/86 03/85→ 10/86→04/98 09/85→02/93 09/83→02/93	BA3 2103	4cyl. 1452cc	54-55kW (73-75PS)		TD5181
Nova 1500 Nova Estate 1500	05/93→04/04 08/94→	BA3 2103 (KAT)	4cyl. 1451cc	49-55kW (67-75PS)		TD5389
Samara 1300 Samara Forma 1300	01/86→ 05/89→	BA3 2108	4cyl. 1288cc	45-48kW (61-65PS)		TD5186
Samara 1300	09/91→	BA3 2108 (KAT)	4cyl. 1288cc	44-45kW (60-62PS)		TD5387
Samara 1100	02/88→12/94	BA3 21081	4cyl. 1100cc	39kW (53PS)		TD5185
Samara 1100 Samara Forma 1100	02/96→ 07/91→	BA3 21081 (KAT)	4cyl. 1099cc	39-43kW (53-58PS)		TD5384

08-269700-00	STD	76.00	1.500		001 IF CR P	IKA	
08-269704-00	0.20mm						
08-269706-00	0.40mm		2.000			026 P	GOE13
08-269710-00	0.80mm		3.947			712 CR	ST
[R47260]							



1200-1500 Estate 1300	01/81→12/82	BA3 2105								2
1200-1600 1300	08/74→08/84		4cyl.							
Nova 1300 Spezial/L	05/81→		1294cc			48-51kW	(65-70PS)			
Nova Estate 1300	09/85→12/90									
Toscana 1300	12/85→05/12									TD5183

1200 1600	09/72→08/84	BA3 2106								
1200-1600 1600 N/L	03/79→10/86		4cyl.							
Nova 1600	01/88→10/01		1570cc			56-57kW	(76-77PS)			
										TD5190

Niva 1600	12/76→03/95	BA3 2121								
			4cyl.							
			1569cc			54-56kW	(73-76PS)			
										TD5184

08-269800-00	STD	79.00	1.500		001 IF CR P		IKA
08-269806-00	0.40mm				026 P		GOE13
08-269820-00	0.70mm				232 P		GOE13
[R47270]			3.947				

Nova 1500 S	06/89→	BA3 21083								3
Samara 1500	01/88→		4cyl.							
Samara Forma 1500	09/91→		1499cc			53kW	(72PS)			
										TD5188

Samara 1500	09/91→	BA3 21083 (KAT)								
Samara Forma 1500	07/91→		4cyl.							
			1500cc			50kW	(68PS)			
										TD5386

110 1.5	01/95→	BA3 2111								
Samara 1500	02/95→		4cyl.							
Samara Forma 1500	11/94→		1499cc			52kW	(71PS)			
										TD13353

110 1.5	01/95→	VAZ-2111								
111 1.5	01/96→		4cyl.							
112 1.5	01/95→		1499cc			56-57kW	(76-78PS)			
Samara 1.5	04/96→									
Samara Forma 1.5	01/00→									TD11748

110 1.5 16V, 111 1.5 16V, 112 1.5 16V	01/95→	VAZ-2112								
			4cyl.							
			1499cc			69-70kW	(94-95PS)			
										TD11749

08-269900-00	STD	82.00	1.500		001 IF CR P		IKA
08-269906-00	0.40mm				026 P		STD
08-269910-00	0.80mm				712 CR		ST
			3.947				



Granta 1.6	10/11→	VAZ-21126							4
Priora Estate 1.6	10/09→		4cyl.						
Priora Hatchback 1.6, Priora Saloon 1.6	12/08→		1597cc	72kW (98PS)					
TD22996									

Kalina 1.6 Sport		VAZ-21126							
			4cyl.						
			1596cc	72kW (98PS)					
FM15997									

08-425200-00	STD	82.00	1.200		001 NT		ST
			1.500		005 P		GOE13
			2.000		231 P		GOE13

Niva 1900 Diesel	01/93→	XUD9A							5
			4cyl.						
			1905cc	47-52kW (64-71PS)					
TD13350									

08-152000-00	STD	83.00	2.000		001 CR P		KV1	
08-152003-00	0.125mm							
08-152007-00	0.50mm		2.000		005 P		STD	
08-152010-00	0.80mm							
08-152011-00	1.00mm		3.000		231 CR P		STD	
<i>[R66390]</i>								

Niva 1900 Diesel	01/99→	XUD9SD							6
			4cyl.						
			1905cc	55kW (75PS)					
TD17345									

08-105500-00	STD	83.00	3.000		008 CK		KV1	
08-105507-00	0.50mm							
08-105510-00	0.80mm		2.000		005 IF NT		IKA	
01/1997→			3.000		231 CR P		STD	
<i>[R60140]</i>								

110 2.0 i	08/96→	C 20 XE							7
			4cyl.						
			1998cc	110kW (150PS)					
TD22868									

08-306800-00	STD	86.00	1.500		001 IF CR P		IKA	
08-306807-00	0.50mm							
08-306811-00	1.00mm		1.500		005 IF P		STD	
			3.000		712 CR		ST	
<i>[R43290]</i>								

MODEL INDEX

Modelverzeichnis • Index de modele • Índice de Modelo
Indeks modelu • Модель автомобиля • دليل الموديل



CCM

x



9

03/81→06/86	A 112 0.9 Junior	A112 A.000	Petrol	903	4	1
03/81→06/86	A 112 0.9 Junior	A112 A5.000	Petrol	903	4	1
03/81→06/86	A 112 0.9 Junior	A112 B2.000	Petrol	896	4	1
	A 112 1.0 Abarth	A 112 AB.2C.0	Petrol	1050	4	2
03/78→02/84	A 112 1.0 Abarth	A112 A2.000	Petrol	1050	4	2
03/84→12/86	A 112 1.0 LX	A112 B1.000	Petrol	965	4	2
01/72→12/75	Beta 1.6	132A.B.000-828	Petrol	1592	4	13
08/73→07/76	Beta 1400	828 A2.000	Petrol	1438	4	13
01/72→12/75	Beta 1600	132A.B.000-828	Petrol	1592	4	13
08/73→07/82	Beta 1600	828 B.000	Petrol	1585	V4	27
04/76→07/82	Beta 2000	828 B1.000	Petrol	1995	4	27
04/76→12/84	Beta Coupe 1600	828 B.000	Petrol	1585	V4	27
04/76→12/84	Beta Coupe 2000	828 B1.000	Petrol	1995	4	27
08/80→09/84	Beta H.P.E. 1600	828 B.000	Petrol	1585	V4	27
05/76→09/84	Beta H.P.E. 2000	828 B1.000	Petrol	1995	4	27
05/81→09/84	Beta H.P.E. 2000 i.e.	828 B4.000	Petrol	1995	4	27
05/76→08/82	Beta Spider 1600	828 B.000	Petrol	1585	V4	27
05/76→10/86	Beta Spider 2000	828 B1.000	Petrol	1995	4	27
01/96→07/99	Dedra 1.6 16V	182 A4.000	Petrol	1581	4	32
08/89→06/94	Dedra 1.6 i.e.	835 A1.000	Petrol	1581	4	34
08/89→03/93	Dedra 1.6 i.e.	835 A1.046	Petrol	1581	4	34
04/93→07/99	Dedra 1.6 i.e.	835 C1.000	Petrol	1581	4	34
03/96→07/99	Dedra 1.8 16V LE	182 A2.000	Petrol	1747	4	17
03/96→07/99	Dedra 1.8 GT 16V	183 A1.000	Petrol	1747	4	17
09/89→06/94	Dedra 1.8 i.e.	835 A2.000	Petrol	1756	4	28
04/89→07/99	Dedra 1.9 TDS	160 D1.000	Diesel	1929	4	25
04/89→07/99	Dedra 1.9 TDS	835 A4.000	Diesel	1929	4	25
04/89→07/99	Dedra 1.9 TDS	835 A4.046	Diesel	1929	4	25
07/94→07/99	Dedra 2.0 16V	836 A3.000	Petrol	1995	4	28
11/90→07/94	Dedra 2.0 HF Integrale	835 A7.046	Petrol	1995	4	27
09/89→07/92	Dedra 2.0 i.e.	835 A5.000	Petrol	1995	4	27
09/89→07/99	Dedra 2.0 i.e.	835 A5.046	Petrol	1995	4	27
05/90→07/94	Dedra 2.0 i.e. Turbo Integrale	835 A7.000	Petrol	1995	4	27
01/96→07/99	Dedra SW 1.6 16V	182 A4.000	Petrol	1581	4	32
03/96→07/99	Dedra SW 1.8 16V LE	182 A2.000	Petrol	1747	4	17
03/96→07/99	Dedra SW 1.8 GT 16V	183 A1.000	Petrol	1747	4	17
07/94→07/99	Dedra SW 1.9 TDS	160 D1.000	Diesel	1929	4	25
07/94→07/99	Dedra SW 1.9 TDS	835 A4.000	Diesel	1929	4	25
07/94→07/99	Dedra SW 2.0 16V	836 A3.000	Petrol	1995	4	28
07/94→07/99	Dedra SW 2.0 Integrale	836 A3.000	Petrol	1995	4	28
09/79→08/92	Delta I 1.3	831 A2.000	Petrol	1301	4	33
09/79→08/92	Delta I 1.3	831 B.000	Petrol	1299	4	33
09/79→12/92	Delta I 1.5	831 A1.000	Petrol	1498	4	33
09/79→12/92	Delta I 1.5	831 B1.000	Petrol	1498	4	33
05/87→08/92	Delta I 1.6 GT i.e.	149 C2.000	Petrol	1585	4	27
08/86→08/88	Delta I 1.6 GT i.e.	831 B7.000	Petrol	1585	4	27
10/86→12/89	Delta I 1.9 Turbo DS	831 D1.000	Diesel	1929	4	25
06/93→01/94	Delta I 2.0 16V HF Evo Integrale	831 E5.000	Petrol	1995	4	28
06/93→01/94	Delta I 2.0 16V HF Evo Integrale	831 E5.046	Petrol	1995	4	28
03/89→09/91	Delta I 2.0 16V HF Integrale	831 D5.000	Petrol	1995	4	27
11/86→08/88	Delta I 2.0 HF Integrale	831 B5.000	Petrol	1995	4	27
10/87→02/89	Delta I 2.0 HF Integrale	831 C5.000	Petrol	1995	4	27
10/94→08/99	Delta II 1.4 i.e.	160 A1.046	Petrol	1372	4	14
10/94→08/99	Delta II 1.4 i.e.	836 A4.000	Petrol	1372	4	14
03/96→08/99	Delta II 1.6 i.e.	182 A6.000	Petrol	1581	4	32
06/93→08/99	Delta II 1.6 i.e.	835 C1.000	Petrol	1581	4	34
01/96→08/99	Delta II 1.6 i.e. 16V	182 A4.000	Petrol	1581	4	32
06/93→08/99	Delta II 1.8 i.e.	835 C2.000	Petrol	1756	4	28
03/96→08/99	Delta II 1.8 i.e. 16V	182 A2.000	Petrol	1747	4	17
03/96→08/99	Delta II 1.8 i.e. 16V GT	183 A1.000	Petrol	1747	4	17

CCM
x

10/94→08/99	Delta II 1.9 TD	160 D1.000	Diesel	1929	4	25
10/94→08/99	Delta II 1.9 TD	835 A4.000	Diesel	1929	4	25
11/94→04/98	Delta II 2.0	836 A3.000	Petrol	1995	4	28
06/93→08/99	Delta II 2.0 16V	836 A3.000	Petrol	1995	4	28
07/96→08/99	Delta II 2.0 16V Turbo	175 A4.000	Petrol	1995	4	28
06/93→08/99	Delta II 2.0 16V Turbo	836 A2.000	Petrol	1995	4	28
09/08→	Delta III 1.4	198 A1.000	Petrol	1368	4	10
09/08→	Delta III 1.4	198 A4.000 (Jet 120 pk)	Petrol	1368	4	10
07/10→	Delta III 1.4 16V	198 A7.000	Petrol	1368	4	10
07/11→	Delta III 1.4 Bifuel	198 A4.000 (Jet 120 pk)	Petrol	1368	4	10
09/08→	Delta III 1.6	844 A3.000 (Multijet)	Diesel	1598	4	12
09/08→	Delta III 1.6 D Multijet	198 A2.000	Diesel	1598	4	12
09/08→	Delta III 2.0 D Multijet	198 A5.000	Diesel	1956	4	26
09/08→	Delta III 2.0 D Multijet	198 A8.000 (Multijet)	Diesel	1956	4	26
09/08→	Delta III 2.0 D Multijet	844 A2.000	Diesel	1956	4	26
02/95→10/01	Kappa 2.0 16V Turbo	838 A4.000	Petrol	1995	4	28
10/94→10/01	Kappa 2.0 20V	838 A1.000 Euro 2	Petrol	1998	5	18
07/96→10/01	Kappa 2.0 20V	838 A6.000 Euro 2	Petrol	1998	5	18
06/98→10/01	Kappa 2.0 20V Turbo	175 A3.000	Petrol	1998	5	16
06/98→10/01	Kappa 2.4 JTD	838 A8.000 Euro 2	Diesel	2387	5	21
08/94→10/01	Kappa 2.4 T.DS	838 A3.000	Diesel	2387	5	20
08/94→10/01	Kappa 2.4 T.DS	838 A7.000	Diesel	2387	5	20
08/94→10/01	Kappa 3.0 24V	838 B.000	Petrol	2959	V6	37
11/96→03/01	Kappa Coupe 2.0 16V Turbo	838 A4.000	Petrol	1995	4	28
07/96→03/01	Kappa Coupe 2.0 20V	838 A6.000 Euro 2	Petrol	1998	5	18
06/98→03/01	Kappa Coupe 2.0 20V Turbo	175 A3.000	Petrol	1998	5	16
11/96→03/01	Kappa Coupe 3.0 24V	838 B.000	Petrol	2959	V6	37
07/96→10/01	Kappa SW 2.0 16V Turbo	838 A4.000	Petrol	1995	4	28
07/96→10/01	Kappa SW 2.0 20V	838 A6.000 Euro 2	Petrol	1998	5	18
06/98→10/01	Kappa SW 2.0 20V Turbo	175 A3.000	Petrol	1998	5	16
06/98→10/01	Kappa SW 2.4 JTD	838 A8.000 Euro 2	Diesel	2387	5	21
07/96→10/01	Kappa SW 2.4 T.DS	838 A3.000	Diesel	2387	5	20
07/96→10/01	Kappa SW 2.4 T.DS	838 A7.000	Diesel	2387	5	20
07/96→10/01	Kappa SW 3.0 24V	838 B.000	Petrol	2959	V6	37
10/00→10/05	Lybra 1.6	182 B6.000	Petrol	1596	4	15
07/99→10/05	Lybra 1.6 16V	182 A4.000	Petrol	1581	4	32
07/99→10/05	Lybra 1.8 16V	839 A4.000	Petrol	1747	4	17
07/99→10/05	Lybra 1.8 16V	839 A7.000 Euro 3	Petrol	1747	4	22
05/01→10/05	Lybra 1.9 JTD	937 A2.000 Euro 3	Diesel	1910	4	19
07/99→09/00	Lybra 1.9 JTD	AR 32302	Diesel	1910	4	21
09/00→05/01	Lybra 1.9 JTD	AR 37101	Diesel	1910	4	24
07/99→09/00	Lybra 2.0 20V	182 B7.000 Euro 2	Petrol	1998	5	18
09/00→10/05	Lybra 2.0 20V	185 A8.000 Euro 3	Petrol	1998	5	17
07/99→02/01	Lybra 2.4 JTD	839 A5.000	Diesel	2387	5	21
09/00→05/02	Lybra 2.4 JTD	839 A6.000 Euro 3	Diesel	2387	5	19
05/02→10/05	Lybra 2.4 JTD	841C.000 Euro 3	Diesel	2387	5	19
07/99→02/01	Lybra 2.4 JTD	AR 32501	Diesel	2387	5	21
10/00→10/05	Lybra SW 1.6	182 B6.000	Petrol	1596	4	15
07/99→10/05	Lybra SW 1.6 16V	182 A4.000	Petrol	1581	4	32
07/99→10/05	Lybra SW 1.8 16V	839 A4.000	Petrol	1747	4	17
07/99→10/05	Lybra SW 1.8 16V	839 A7.000 Euro 3	Petrol	1747	4	22
05/01→10/05	Lybra SW 1.9 JTD	937 A2.000 Euro 3	Diesel	1910	4	19
07/99→09/00	Lybra SW 1.9 JTD	AR 32302	Diesel	1910	4	21
09/00→05/01	Lybra SW 1.9 JTD	AR 37101	Diesel	1910	4	24
07/99→09/00	Lybra SW 2.0 20V	182 B7.000 Euro 2	Petrol	1998	5	18
09/00→10/05	Lybra SW 2.0 20V	185 A8.000 Euro 3	Petrol	1998	5	17
10/99→09/00	Lybra SW 2.4 JTD	839 A5.000	Diesel	2387	5	21
09/00→10/05	Lybra SW 2.4 JTD	839 A6.000 Euro 3	Diesel	2387	5	19
05/02→10/05	Lybra SW 2.4 JTD	841C.000 Euro 3	Diesel	2387	5	19
10/99→09/00	Lybra SW 2.4 JTD	AR 32501	Diesel	2387	5	21

MODEL INDEX

Modelverzeichnis • Index de modele • Índice de Modelo
Indeks modelu • Модель автомобиля • دليل الموديل



CCM

x



9

10/04→	Musa 1.3 D Multijet	188 A9.000	Diesel	1248	4	3
09/06→	Musa 1.3 D Multijet	199 A3.000	Diesel	1248	4	4
03/09→	Musa 1.3 D Multijet	199 B1.000 Euro 5	Diesel	1248	4	5
10/07→	Musa 1.4	192 B2.000	Petrol	1368	4	9
09/05→	Musa 1.4	350 A1.000	Petrol	1368	4	11
10/04→	Musa 1.4	843 A 1.000	Petrol	1368	4	9
11/10→	Musa 1.4 LPG	350 A1.000	Petrol	1368	4	11
10/04→	Musa 1.9 D Multijet	188 B2.000	Diesel	1910	4	19
07/06→11/10	Phedra 2.0 D Multijet	RHR (DW10BTED4) Euro 4	Diesel	1997	4	29
09/02→11/10	Phedra 2.0 JTD	DW10ATED4 (RHW) Euro 3	Diesel	1997	4	29
09/02→11/10	Phedra 2.2 JTD	DW12ATED4 (4HW)	Diesel	2179	4	29
01/83→02/92	Prisma 1.3	831 A2.000	Petrol	1301	4	33
01/83→04/86	Prisma 1.5	831 A1.000	Petrol	1498	4	33
08/86→02/92	Prisma 1.5	831 B1.000	Petrol	1498	4	33
09/85→02/92	Prisma 1.5	831 B1.048	Petrol	1498	4	33
05/86→12/89	Prisma 1.6 i.e.	831 B7.000	Petrol	1585	4	27
05/87→12/89	Prisma 1.6 i.e. Super	149 C2.000	Petrol	1585	4	27
01/83→02/92	Prisma 1.9 Diesel	831 D.000	Diesel	1929	4	25
05/85→12/89	Prisma 1.9 Turbo Diesel	831 D1.000	Diesel	1929	4	25
04/86→12/89	Prisma 2.0 i.e. All-wheel Drive	831 B4.000	Petrol	1995	4	27
08/92→12/93	Thema 2000 16V	834 F1.000	Petrol	1995	4	28
12/88→06/90	Thema 2000 16V Turbo	834 C1.000	Petrol	1995	4	28
10/92→07/94	Thema 2000 16V Turbo	834 F2.000	Petrol	1995	4	28
09/88→05/92	Thema 2000 i.e.	834 B1.000	Petrol	1995	4	27
11/84→09/88	Thema 2000 i.e.	834 B.000	Petrol	1995	4	27
03/86→09/88	Thema 2000 i.e.	834 B.048	Petrol	1995	4	27
09/87→05/92	Thema 2000 i.e.	834 B.146	Petrol	1995	4	27
05/88→08/92	Thema 2000 i.e. 16V	834 B2.000	Petrol	1995	4	27
02/89→05/92	Thema 2000 i.e. 16V	834 B2.246	Petrol	1995	4	27
11/84→12/87	Thema 2000 i.e. Turbo	834 C.000	Petrol	1995	4	27
07/86→05/90	Thema 2000 i.e. Turbo	834 C.146	Petrol	1995	4	27
11/84→09/88	Thema 2500 Turbo D	8144.91 (Sofim)	Diesel	2445	4	35
05/88→07/92	Thema 2500 Turbo DS	8144. 97S	Diesel	2500	4	35
06/88→05/92	Thema 2500 Turbo DS	8144.97 (Sofim)	Diesel	2499	4	35
05/92→07/94	Thema 2500 Turbo DS	8144.97 Y (Sofim)	Diesel	2499	4	35
	Thema 2500 Turbo DS	8144.97.2200	Diesel	2499	4	35
08/92→07/94	Thema 3000 V6	834 F.000	Petrol	2959	6	36
05/92→07/94	Thema Sw 2000 16V	834 F1.000	Petrol	1995	4	28
05/89→08/92	Thema Sw 2000 i.e. 16V	834 B2.000	Petrol	1995	4	27
02/89→05/92	Thema Sw 2000 i.e. 16V	834 B2.246	Petrol	1995	4	27
12/88→06/90	Thema Sw 2000 i.e. 16V Turbo	834 C1.000	Petrol	1995	4	28
01/89→03/92	Thema Sw 2000 Turbo	834 C.146	Petrol	1995	4	27
11/92→07/94	Thema Sw 2000 Turbo 16V	834 F2.000	Petrol	1995	4	28
05/88→07/92	Thema Sw 2500 Turbo DS	8144. 97S	Diesel	2500	4	35
03/87→09/90	Thema Sw 2500 Turbo DS	8144.91 (Sofim)	Diesel	2445	4	35
06/88→05/92	Thema Sw 2500 Turbo DS	8144.97 (Sofim)	Diesel	2499	4	35
09/92→07/94	Thema Sw 2500 Turbo DS	8144.97 Y (Sofim)	Diesel	2499	4	35
	Thema Sw 2500 Turbo DS	8144.97.2200	Diesel	2499	4	35
09/92→07/94	Thema Sw 3000 V6	834 F.000	Petrol	2959	6	36
05/03→07/09	Thesis 2.4 JTD	841 G.000	Diesel	2387	5	23
09/03→07/09	Thesis 2.4 JTD	841 M.000	Diesel	2387	5	19
09/03→07/09	Thesis 2.4 JTD	841 N.000	Diesel	2387	5	19
07/02→07/09	Thesis 2.4 JTD	841C.000 Euro 3	Diesel	2387	5	19
05/80→01/87	Trevi 1600	828 B.000	Petrol	1585	V4	27
05/80→01/87	Trevi 2000 i.e.	828 B4.000	Petrol	1995	4	27
11/95→09/03	Y 1.1	176 B2.000 Euro 2 (Fire)	Petrol	1108	4	7
03/96→09/03	Y 1.2	188 A4.000 Euro 3 (Fire)	Petrol	1242	4	8
03/96→09/03	Y 1.2	840 A3.000 (Fire)	Petrol	1242	4	8
04/97→09/03	Y 1.2 16V	176 B9.000 (Fire)	Petrol	1242	4	8
10/00→09/03	Y 1.2 16V	188 A5.000 Euro 3 (Fire)	Petrol	1242	4	8

Modelverzeichnis • Index de modele • Índice de Modelo
Indeks modelu • Модель автомобиля • دليل المحرك

MODEL INDEX



CCM

x



9

10/96→09/03	Y 1.4 12V	840 A2.000	Petrol	1370	4	18
03/96→09/03	Y 1.4 12V	840 A4.000	Petrol	1371	4	18
03/85→02/90	Y10 1.0 Fire	156 A 2.000	Petrol	999	4	6
06/85→06/91	Y10 1.0 Fire	156 A 2.100	Petrol	999	4	6
10/87→02/92	Y10 1.0 Fire	156 A2.246	Petrol	999	4	6
12/87→02/90	Y10 1.0 Fire All-wheel Drive	156 A 2.000	Petrol	999	4	6
12/86→02/89	Y10 1.0 Fire All-wheel Drive	156 A 2.100	Petrol	999	4	6
12/87→02/92	Y10 1.0 Fire All-wheel Drive	156 A2.246	Petrol	999	4	6
01/95→12/95	Y10 1.1 Avenue	176 B2.000 Euro 2 (Fire)	Petrol	1108	4	7
01/95→12/95	Y10 1.1 Avenue All-wheel Drive	176 B2.000 Euro 2 (Fire)	Petrol	1108	4	7
08/89→06/92	Y10 1.1 i.e	156 C.000	Petrol	1108	4	6
08/89→06/92	Y10 1.1 i.e All-wheel Drive	156 C.000	Petrol	1108	4	6
07/89→09/95	Y10 1.1 i.e. Fire	156 C.046	Petrol	1108	4	6
09/92→12/95	Y10 1.1 i.e. Fire All-wheel Drive	156 C.046	Petrol	1108	4	6
08/10→	Ypsilon 1.2	169 A4.000	Petrol	1242	4	8
10/03→12/11	Ypsilon 1.2	188 A4.000 Euro 3 (Fire)	Petrol	1242	4	8
10/03→12/11	Ypsilon 1.2	188 A5.000 Euro 3 (Fire)	Petrol	1242	4	8
05/11→	Ypsilon 1.2 Bifuel	169 A4.000	Petrol	1242	4	8
09/06→12/11	Ypsilon 1.3 D Multijet	199 A2.000	Diesel	1248	4	3
09/06→12/11	Ypsilon 1.3 D Multijet	199 A3.000	Diesel	1248	4	4
10/03→12/11	Ypsilon 1.3 JTD	188 A9.000	Diesel	1248	4	3
05/11→	Ypsilon 1.3 Multijet	199 B1.000 Euro 5	Diesel	1248	4	5
02/06→12/11	Ypsilon 1.4	350 A1.000	Petrol	1368	4	11
10/03→12/11	Ypsilon 1.4 16V	843 A 1.000	Petrol	1368	4	9
11/10→12/11	Ypsilon 1.4 LPG	350 A1.000	Petrol	1368	4	11
05/98→07/00	Zeta 2.0 16V	RFV (XU10J4R)	Petrol	1998	4	31
09/99→09/02	Zeta 2.0 JTD	DW10ATED4 (RHW) Euro 3	Diesel	1997	4	29
05/95→09/02	Zeta 2.0 Turbo	RGX (XU10J2TE)	Petrol	1998	4	31
05/96→09/99	Zeta 2.1 TD	P 8 C (XUD11)	Diesel	2088	4	30

Motorverzeichnis • Index de moteur • Índice de Motor
Indeks silnika • Модель двигателя • دليل المحرك

ENGINE INDEX



CCM

x



9

132A.B.000-828	Petrol	1592	4	80.00	13
149 C2.000	Petrol	1585	4	84.00	27
156 A 2.000	Petrol	999	4	70.00	6
156 A 2.100	Petrol	999	4	70.00	6
156 A2.246	Petrol	999	4	70.00	6
156 C.000	Petrol	1108	4	70.00	6
156 C.046	Petrol	1108	4	70.00	6
160 A1.046	Petrol	1372	4	80.50	14
160 D1.000	Diesel	1929	4	82.60	25
169 A4.000	Petrol	1242	4	70.80	8
175 A3.000	Petrol	1998	5	82.00	16
175 A4.000	Petrol	1995	4	84.00	28
176 B2.000 Euro 2 (Fire)	Petrol	1108	4	70.00	7
176 B9.000 (Fire)	Petrol	1242	4	70.80	8
182 A2.000	Petrol	1747	4	82.00	17
182 A4.000	Petrol	1581	4	86.40	32
182 A6.000	Petrol	1581	4	86.40	32
182 B6.000	Petrol	1596	4	80.50	15

ENGINE INDEX

Motorverzeichnis • Index de moteur • Índice de Motor
Indeks silnika • Модель двигателя • دليل المحرك



CCM

x



9

182 B7.000 Euro 2	Petrol	1998	5	82.00	18
183 A1.000	Petrol	1747	4	82.00	17
185 A8.000 Euro 3	Petrol	1998	5	82.00	17
188 A4.000 Euro 3 (Fire)	Petrol	1242	4	70.80	8
188 A5.000 Euro 3 (Fire)	Petrol	1242	4	70.80	8
188 A9.000	Diesel	1248	4	69.60	3
188 B2.000	Diesel	1910	4	82.00	19
192 B2.000	Petrol	1368	4	72.00	9
198 A1.000	Petrol	1368	4	72.00	10
198 A2.000	Diesel	1598	4	79.50	12
198 A4.000 (Jet 120 pk)	Petrol	1368	4	72.00	10
198 A5.000	Diesel	1956	4	83.00	26
198 A7.000	Petrol	1368	4	72.00	10
198 A8.000 (Multijet)	Diesel	1956	4	83.00	26
199 A2.000	Diesel	1248	4	69.60	3
199 A3.000	Diesel	1248	4	69.60	4
199 B1.000 Euro 5	Diesel	1248	4	69.60	5
350 A1.000	Petrol	1368	4	72.00	11
828 A2.000	Petrol	1438	4	80.00	13
828 B.000	Petrol	1585	V4	84.00	27
828 B1.000	Petrol	1995	4	84.00	27
828 B4.000	Petrol	1995	4	84.00	27
831 A1.000	Petrol	1498	4	86.40	33
831 A2.000	Petrol	1301	4	86.40	33
831 B.000	Petrol	1299	4	86.40	33
831 B1.000	Petrol	1498	4	86.40	33
831 B1.048	Petrol	1498	4	86.40	33
831 B4.000	Petrol	1995	4	84.00	27
831 B5.000	Petrol	1995	4	84.00	27
831 B7.000	Petrol	1585	4	84.00	27
831 C5.000	Petrol	1995	4	84.00	27
831 D.000	Diesel	1929	4	82.60	25
831 D1.000	Diesel	1929	4	82.60	25
831 D5.000	Petrol	1995	4	84.00	27
831 E5.000	Petrol	1995	4	84.00	28
831 E5.046	Petrol	1995	4	84.00	28
834 B.000	Petrol	1995	4	84.00	27
834 B.048	Petrol	1995	4	84.00	27
834 B.146	Petrol	1995	4	84.00	27
834 B1.000	Petrol	1995	4	84.00	27
834 B2.000	Petrol	1995	4	84.00	27
834 B2.246	Petrol	1995	4	84.00	27
834 C.000	Petrol	1995	4	84.00	27
834 C.146	Petrol	1995	4	84.00	27
834 C1.000	Petrol	1995	4	84.00	28
834 F.000	Petrol	2959	6	93.00	36
834 F1.000	Petrol	1995	4	84.00	28
834 F2.000	Petrol	1995	4	84.00	28
835 A1.000	Petrol	1581	4	86.40	34
835 A1.046	Petrol	1581	4	86.40	34
835 A2.000	Petrol	1756	4	84.00	28
835 A4.000	Diesel	1929	4	82.60	25
835 A4.046	Diesel	1929	4	82.60	25
835 A5.000	Petrol	1995	4	84.00	27
835 A5.046	Petrol	1995	4	84.00	27
835 A7.000	Petrol	1995	4	84.00	27
835 A7.046	Petrol	1995	4	84.00	27
835 C1.000	Petrol	1581	4	86.40	34
835 C2.000	Petrol	1756	4	84.00	28
836 A2.000	Petrol	1995	4	84.00	28

Motorverzeichnis • Index de moteur • Índice de Motor
 Indeks silnika • Модель двигателя • دليل المحرك

ENGINE INDEX

CCM

9



836 A3.000	Petrol	1995	4	84.00	28
836 A4.000	Petrol	1372	4	80.50	14
838 A1.000 Euro 2	Petrol	1998	5	82.00	18
838 A3.000	Diesel	2387	5	82.00	20
838 A4.000	Petrol	1995	4	84.00	28
838 A6.000 Euro 2	Petrol	1998	5	82.00	18
838 A7.000	Diesel	2387	5	82.00	20
838 A8.000 Euro 2	Diesel	2387	5	82.00	21
838 B.000	Petrol	2959	V6	93.00	37
839 A4.000	Petrol	1747	4	82.00	17
839 A5.000	Diesel	2387	5	82.00	21
839 A6.000 Euro 3	Diesel	2387	5	82.00	19
839 A7.000 Euro 3	Petrol	1747	4	82.00	22
840 A2.000	Petrol	1370	4	82.00	18
840 A3.000 (Fire)	Petrol	1242	4	70.80	8
840 A4.000	Petrol	1371	4	82.00	18
841 G.000	Diesel	2387	5	82.00	23
841 M.000	Diesel	2387	5	82.00	19
841 N.000	Diesel	2387	5	82.00	19
841C.000 Euro 3	Diesel	2387	5	82.00	19
843 A 1.000	Petrol	1368	4	72.00	9
844 A2.000	Diesel	1956	4	83.00	26
844 A3.000 (Multijet)	Diesel	1598	4	79.50	12
937 A2.000 Euro 3	Diesel	1910	4	82.00	19
8144. 97S	Diesel	2500	4	93.00	35
8144.91 (Sofim)	Diesel	2445	4	93.00	35
8144.97 (Sofim)	Diesel	2499	4	93.00	35
8144.97 Y (Sofim)	Diesel	2499	4	93.00	35
8144.97.2200	Diesel	2499	4	93.00	35
A 112 AB.2C.0	Petrol	1050	4	67.20	2
A112 A.000	Petrol	903	4	65.00	1
A112 A2.000	Petrol	1050	4	67.20	2
A112 A5.000	Petrol	903	4	65.00	1
A112 B1.000	Petrol	965	4	67.20	2
A112 B2.000	Petrol	896	4	65.00	1
AR 32302	Diesel	1910	4	82.00	21
AR 32501	Diesel	2387	5	82.00	21
AR 37101	Diesel	1910	4	82.00	24
DW10ATED4 (RHW) Euro 3	Diesel	1997	4	85.00	29
DW12ATED4 (4HW)	Diesel	2179	4	85.00	29
P 8 C (XUD11)	Diesel	2088	4	85.00	30
RFV (XU10J4R)	Petrol	1998	4	86.00	31
RGX (XU10J2TE)	Petrol	1998	4	86.00	31
RHR (DW10BTED4) Euro 4	Diesel	1997	4	85.00	29



A 112 0.9 Junior	03/81→06/86	A112 A.000	4cyl. 903cc	29-32kW (40-44PS)	1
					TD1856

A 112 0.9 Junior	03/81→06/86	A112 A5.000	4cyl. 903cc	29-31kW (40-42PS)	1
					TD1803



A 112 0.9 Junior	03/81→06/86	A112 B2.000	4cyl. 896cc	29-32kW (40-44PS)	1
					TD4622

08-209800-00	STD	65.00	1.750		001 IF CR P	IKA
08-209806-00	0.40mm		2.000		026 P	STD
08-209808-00	0.60mm		3.947		231 P	STD
<i>[R46550]</i>						

A 112 1.0 Abarth		A 112 AB.2C.0	4cyl. 1050cc	51kW (69PS)	2
					TD22321



A 112 1.0 Abarth	03/78→02/84	A112 A2.000	4cyl. 1050cc	51kW (69PS)	2
					TD4621

A 112 1.0 LX	03/84→12/86	A112 B1.000	4cyl. 965cc	35kW (47PS)	2
					TD1824

08-782600-00	STD	67.20	1.500		001 IF CR P	IKA
08-782606-00	0.40mm		1.750		026 P	STD
08-782608-00	0.60mm		3.947		712 CR	ST

Musa 1.3 D Multijet	10/04→	188 A9.000	4cyl. 1248cc	51kW (69PS)	3
Ypsilon 1.3 JTD	10/03→12/11		Diesel	Turbo Intercooled	TD18314

Ypsilon 1.3 D Multijet	09/06→12/11	199 A2.000	4cyl. 1248cc	55kW (75PS)	3
					TD20272

08-137600-00	STD	69.60	2.000		001 CK P	KV1
08-137606-00	0.40mm		1.500		023 P	F12/F14
[R66830]			2.000		231 P	F12/F14



Musa 1.3 D Multijet		09/06→		199 A3.000		4
Ypsilon 1.3 D Multijet		09/06→12/11		4cyl. 1248cc 66kW (89PS)		
				Diesel Turbo Intercooled		TD20273
08-425600-00	STD	69.60	2.000		001 CK P	KV4
08-425606-00	0.40mm		1.500		005 NT	F12/F14
08-425608-00	0.60mm		2.000		231 CR P	GOE13



Musa 1.3 D Multijet		03/09→		199 B1.000 Euro 5		5
Ypsilon 1.3 Multijet		05/11→		4cyl. 1248cc 70kW (95PS)		
				Diesel Turbo Intercooled		TD24672
08-435700-00	STD	69.60	1.500		001 GDC P	KV4
08-435706-00	0.40mm		1.500		005 P	F12/F14
			2.000		231 LKZ CR P	GOE13

Y10 1.0 Fire		03/85→02/90		156 A 2.000		6
Y10 1.0 Fire All-wheel Drive		12/87→02/90		4cyl. 999cc 33kW (45PS)		
						TD4592
Y10 1.0 Fire		06/85→06/91		156 A 2.100		TD4593
Y10 1.0 Fire All-wheel Drive		12/86→02/89		4cyl. 999cc 32kW (44PS)		
Y10 1.0 Fire		10/87→02/92		156 A2.246		TD5423
Y10 1.0 Fire All-wheel Drive		12/87→02/92		4cyl. 999cc 32kW (44PS)		
Y10 1.1 i.e., Y10 1.1 i.e All-wheel Drive		08/89→06/92		156 C.000		TD1854
				4cyl. 1108cc 42kW (57PS)		
Y10 1.1 i.e. Fire		07/89→09/95		156 C.046		TD4597
Y10 1.1 i.e. Fire All-wheel Drive		09/92→12/95		4cyl. 1108cc 40-37kW (54-50PS)		
08-154200-00	STD	70.00	1.500		001 IF CR P	IKA
08-154206-00	0.40mm		1.500		005 IF P	STD
08-154208-00	0.60mm		3.000		712 CR	ST
<i>[R46910]</i>						



Y 1.1		11/95→09/03		176 B2.000 Euro 2 (Fire)		7
Y10 1.1 Avenue,		01/95→12/95		4cyl. 1108cc 40-55kW (54-75PS)		
Y10 1.1 Avenue All-wheel Drive						TD11847
08-142300-00	STD	70.00	1.200		001 CR P	KV1
08-142306-00	0.40mm		1.200		005 P	STD
08-142308-00	0.60mm		2.500		236 P	STD
<i>[R48480]</i>						



Ypsilon 1.2	08/10→	169 A4.000	4cyl.	1242cc	51kW (69PS)	8
Ypsilon 1.2 Bifuel	05/11→					
TD25192						
Y 1.2 16V	04/97→09/03	176 B9.000 (Fire)	4cyl.	1242cc	63kW (86PS)	8
TD11849						
Y 1.2	03/96→09/03	188 A4.000 Euro 3 (Fire)	4cyl.	1242cc	44kW (60PS)	8
Ypsilon 1.2	10/03→12/11					
TD15501						
Y 1.2 16V	10/00→09/03	188 A5.000 Euro 3 (Fire)	4cyl.	1242cc	59kW (80PS)	8
Ypsilon 1.2	10/03→12/11					
TD15500						
Y 1.2	03/96→09/03	840 A3.000 (Fire)	4cyl.	1242cc	44kW (60PS)	8
TD1839						

08-138400-00	STD	70.80	1.190		001 P NT	KV1
08-138406-00	0.40mm		1.200		005 P	STD
08-138408-00	0.60mm		2.500		231 P	GOE12
[R66670]						

Musa 1.4	10/07→	192 B2.000	4cyl.	1368cc	66kW (89PS)	9
TD20952						
Musa 1.4	10/04→	843 A 1.000	4cyl.	1368cc	70kW (95PS)	9
Ypsilon 1.4 16V	10/03→12/11					
TD17979						

08-433200-00	STD	72.00	1.000		001 IF NT	ST
08-433206-00	0.40mm		1.200		005 IF P	GOE13
			2.000		231 P	GOE13

Delta III 1.4	09/08→	198 A1.000	4cyl.	1368cc	110kW (150PS)	10
				Turbo Intercooled		
TD21041						
Delta III 1.4	09/08→	198 A4.000 (Jet 120 pk)	4cyl.	1368cc	88kW (120PS)	10
Delta III 1.4 Bifuel	07/11→			Turbo Intercooled		
TD21040						





Delta III 1.4 16V	07/10→	198 A7.000	4cyl. 1368cc 103kW (140PS) Turbo Intercooled	TD24650
--------------------------	--------	-------------------	--	----------------

08-438300-00	STD	72.00	1.200		021 GDC P	KV1
08-438306-00	0.40mm		1.200		026 P	GOE13
			2.000		231 LKZ CR P	GOE13

Musa 1.4	09/05→	350 A1.000	4cyl.	11
Musa 1.4 LPG	11/10→			
Ypsilon 1.4	02/06→12/11		1368cc 57-55kW (78-75PS)	
Ypsilon 1.4 LPG	11/10→12/11			TD20274

08-436800-00	STD	72.00	1.000		001 IF NT	ST
08-436806-00	0.40mm		1.200		026 P	GOE13
			2.000		231 LKZ CR P	KV1

Delta III 1.6 D Multijet	09/08→	198 A2.000	4cyl. 1598cc 88kW (120PS) Diesel Turbo Intercooled	12
				TD21042

Delta III 1.6	09/08→	844 A3.000 (Multijet)	4cyl. 1598cc 88kW (120PS) Diesel Turbo Intercooled	TD25652
----------------------	--------	------------------------------	--	----------------

08-429300-00	STD	79.50	2.000		001 GDC P	KV4
			1.750		026 P	F12/F14
			2.000		231 LKZ CR P	GOE13

Beta 1.6, Beta 1600	01/72→12/75	132A.B.000-828	4cyl. 1592cc	13
				FM932

Beta 1400	08/73→07/76	828 A2.000	4cyl. 1438cc 66kW (89PS)	TD1793
------------------	-------------	-------------------	------------------------------------	---------------

08-203100-00	STD	80.00	1.500		001 IF CR P	IKA
08-203104-00	0.20mm		2.000		026 P	STD
08-203106-00	0.40mm		3.947		232 P	STD
08-203108-00	0.60mm					
08-203110-00	0.80mm					
08-203111-00	1.00mm					
<i>[R47750]</i>						



Delta II 1.4 i.e.	10/94→08/99	160 A1.046	4cyl. 1372cc	51kW (69PS)	14
					TD4599

Delta II 1.4 i.e.	10/94→08/99	836 A4.000	4cyl. 1372cc	51kW (69PS)	14
					TD14568

08-783600-00	STD	80.50	1.500		001 IF CR P	IKA
08-783606-00	0.40mm		1.750		026 P	STD
08-783608-00	0.60mm		3.000		712 CR	ST
08-783610-00	0.80mm					
08-783611-00	1.00mm					
<i>[R46940]</i>						
08-786700-00	STD	80.50	1.200		001 CR	ST
			1.500		005 IWU P	STD
			3.000		231 P	STD

Lybra 1.6, Lybra SW 1.6	10/00→10/05	182 B6.000	4cyl. 1596cc	76kW (103PS)	15
					TD15632

08-124800-00	STD	80.50	1.200		001 P NT	KV1
08-124806-00	0.40mm		1.200		005 IWU P	KV1
08-124808-00	0.60mm		2.000		231 P	STD
<i>[R60590]</i>						

Kappa 2.0 20V Turbo	06/98→10/01	175 A3.000	5cyl. 1998cc	162kW (220PS)	16
Kappa Coupe 2.0 20V Turbo	06/98→03/01			Turbo Intercooled	
Kappa SW 2.0 20V Turbo	06/98→10/01				TD11550

08-529300-00	STD	82.00	1.200		001 NT	KV1
08-529306-00	0.40mm		1.500		005 IWU P	GOE12
			3.000		231 P	GOE12
<i>[R60130]</i>						

Dedra 1.8 16V LE, Dedra SW 1.8 16V LE	03/96→07/99	182 A2.000	4cyl. 1747cc	83kW (113PS)	17
Delta II 1.8 i.e. 16V	03/96→08/99				TD9473

Dedra 1.8 GT 16V, Dedra SW 1.8 GT 16V	03/96→07/99	183 A1.000	4cyl. 1747cc	96kW (131PS)	17
Delta II 1.8 i.e. 16V GT	03/96→08/99				TD9474

Lybra 2.0 20V, Lybra SW 2.0 20V	09/00→10/05	185 A8.000 Euro 3	5cyl. 1998cc	113kW (154PS)	17
					TD15630





Lybra 1.8 16V, Lybra SW 1.8 16V		07/99→10/05	839 A4.000	4cyl. 1747cc	96kW (131PS)	TD14468
08-118000-00	STD	82.00	1.190		001 NT	KV1
08-118006-00	0.40mm		1.200		005 IWU P	IKA
08-118008-00	0.60mm		2.000		231 P	STD
[R60000]						
Lybra 2.0 20V, Lybra SW 2.0 20V		07/99→09/00	182 B7.000 Euro 2	5cyl. 1998cc	113kW (154PS)	18 TD14389
Kappa 2.0 20V		10/94→10/01	838 A1.000 Euro 2	5cyl. 1998cc	108kW (147PS)	TD4616
Kappa 2.0 20V		07/96→10/01	838 A6.000 Euro 2	5cyl. 1998cc	113kW (154PS)	TD5436
Kappa Coupe 2.0 20V		07/96→03/01				
Kappa SW 2.0 20V		07/96→10/01				
Y 1.4 12V		10/96→09/03	840 A2.000	4cyl. 1370cc	58kW (79PS)	TD1858
Y 1.4 12V		03/96→09/03	840 A4.000	4cyl. 1371cc	58kW (79PS)	TD4596
08-787000-00	STD	82.00	1.500		001 CR P	KV1
08-787006-00	0.40mm		1.500		026 P	STD
[R48590]			3.000		712 CR	ST
Musa 1.9 D Multijet		10/04→	188 B2.000	4cyl. 1910cc	74kW (100PS)	19 TD18316
				Diesel	Turbo Intercooled	
Lybra 2.4 JTD		09/00→05/02	839 A6.000 Euro 3	5cyl. 2387cc	103kW (140PS)	TD15631
Lybra SW 2.4 JTD		09/00→10/05				
				Diesel	Turbo Intercooled	
Thesis 2.4 JTD		09/03→07/09	841 M.000	5cyl. 2387cc	120kW (163PS)	TD19057
				Diesel	Turbo Intercooled	
Thesis 2.4 JTD		09/03→07/09	841 N.000	5cyl. 2387cc	120kW (163PS)	TD19058
				Diesel	Turbo Intercooled	
Lybra 2.4 JTD, Lybra SW 2.4 JTD		05/02→10/05	841C.000 Euro 3	5cyl. 2387cc	110kW (150PS)	TD16472
Thesis 2.4 JTD		07/02→07/09				
				Diesel	Turbo Intercooled	





Lybra 1.9 JTD, Lybra SW 1.9 JTD		05/01→10/05	937 A2.000 Euro 3			
			4cyl.			
			1910cc 85kW (116PS)			
			Diesel	Turbo Intercooled		TD18313
			937 A5.000			
			4cyl.			
			1910cc 110kW (150PS)			
			Diesel	Turbo Intercooled		TD21086
08-124000-00	STD	82.00	2.000		001 CK P	KV1
08-124006-00	0.40mm		2.000		026 P	F12/F14
08-124008-00	0.60mm		2.000		231 CR P	GOE12
[R60580]						
Kappa 2.4 T.DS		08/94→10/01	838 A3.000			20
Kappa SW 2.4 T.DS		07/96→10/01	5cyl.			
			2387cc 91kW (124PS)			
			Diesel	Turbo Intercooled		TD4618
Kappa 2.4 T.DS		08/94→10/01	838 A7.000			
Kappa SW 2.4 T.DS		07/96→10/01	5cyl.			
			2387cc 91kW (124PS)			
			Diesel	Turbo Intercooled		TD5437
08-523100-00	STD	82.00	3.000		008 CK P	KV1
08-523108-00	0.60mm		2.000		005 IWU P	GOE12
			3.000		231 CR P	GOE12
[R49860]						
Kappa 2.4 JTD, Kappa SW 2.4 JTD		06/98→10/01	838 A8.000 Euro 2			21
			5cyl.			
			2387cc 100kW (136PS)			
			Diesel	Turbo Intercooled		TD11551
Lybra 2.4 JTD		07/99→02/01	839 A5.000			
Lybra SW 2.4 JTD		10/99→09/00	5cyl.			
			2387cc 99-96kW (135-131PS)			
			Diesel	Turbo Intercooled		TD17399
Lybra 1.9 JTD, Lybra SW 1.9 JTD		07/99→09/00	AR 32302			
			4cyl.			
			1910cc 77kW (105PS)			
			Diesel	Turbo Intercooled		TD17398
Lybra 2.4 JTD		07/99→02/01	AR 32501			
Lybra SW 2.4 JTD		10/99→09/00	5cyl.			
			2387cc 100-99kW (136-135PS)			
			Diesel	Turbo Intercooled		TD17400
08-108000-00	STD	82.00	3.000		008 CK P	KV1
08-108008-00	0.60mm		2.000		026 P	F12/F14
			3.000		231 CR P	GOE13
[R49870]						



Lybra 1.8 16V, Lybra SW 1.8 16V	07/99→10/05	839 A7.000 Euro 3	4cyl. 1747cc 96kW (131PS)	22
				TD15633

08-145400-00	STD	82.00	1.200		021 NT	ST
08-145406-00	0.40mm		1.200		005 IF P	KV1
[R67927]			2.000		231	GOE12

Thesis 2.4 JTD	05/03→07/09	841 G.000	5cyl. 2387cc 129kW (175PS)	23
				TD18317

08-146100-00	STD	82.00	2.000		001 CK P	KV1
08-146106-00	0.40mm		2.000		023 IWU P	F12/F14
08-146108-00	0.60mm		2.000		231 CK P	GOE12
[R67925]						

Lybra 1.9 JTD, Lybra SW 1.9 JTD	09/00→05/01	AR 37101	4cyl. 1910cc 85-80kW (116-109PS)	24
				TD17890

08-107900-00	STD	82.00	2.500		001 CR P	KV1
08-107908-00	0.60mm		2.000		026 P	F12/F14
→06/2000			2.000		231 CR P	GOE13
[R49850]						
08-124000-00	STD	82.00	2.000		001 CK P	KV1
08-124006-00	0.40mm		2.000		026 P	F12/F14
08-124008-00	0.60mm		2.000		231 CR P	GOE12
06/2000→						
[R60580]						

Dedra 1.9 TDS	04/89→07/99	160 D1.000	4cyl. 1929cc 66kW (89PS)	25
Dedra SW 1.9 TDS	07/94→07/99			
Delta II 1.9 TD	10/94→08/99			
				TD4610

Prisma 1.9 Diesel	01/83→02/92	831 D.000	4cyl. 1929cc 62kW (84PS)	
				TD1813

Delta I 1.9 Turbo DS	10/86→12/89	831 D1.000	4cyl. 1929cc 62kW (84PS)	
Prisma 1.9 Turbo Diesel	05/85→12/89			
				TD4607

Dedra 1.9 TDS	04/89→07/99	835 A4.000	4cyl. 1929cc 68kW (92PS)	
Dedra SW 1.9 TDS	07/94→07/99			
Delta II 1.9 TD	10/94→08/99			
				TD1846





Dedra 1.9 TDS		04/89→07/99	835 A4.046		4cyl. 1929cc 68kW (92PS)		
				Diesel	Turbo		TD5425
08-783800-00	STD	82.60	3.000		008 MOL P		KV1
08-783808-00	0.60mm		2.000		005 IFU P		F12/F14
[R47150]			3.000		231 CR P		STD
Delta III 2.0 D Multijet		09/08→	198 A5.000		4cyl. 1956cc 121kW (165PS)		26
				Diesel	Turbo Intercooled		TD21043
Delta III 2.0 D Multijet		09/08→	198 A8.000 (Multijet)		4cyl. 1956cc 121kW (165PS)		
				Diesel	Turbo Intercooled		TD25650
			198 A9.000 (Multijet)		4cyl. 1956cc 120kW (163PS)		
				Diesel	Turbo Intercooled		TD25651
Delta III 2.0 D Multijet		09/08→	844 A2.000		4cyl. 1956cc 120kW (163PS)		
				Diesel	Turbo Intercooled		TD24652
08-436500-00	STD	83.00	1.500		001 GDC P		KV4
08-436506-00	0.40mm		1.500		050 P		F12/F14
			2.000		231 LKZ CK P		GOE13
Delta I 1.6 GT i.e.		05/87→08/92	149 C2.000		4cyl. 1585cc 66kW (89PS)		27
Prisma 1.6 i.e. Super		05/87→12/89					TD5432
Beta 1600		08/73→07/82	828 B.000		V4cyl. 1585cc 74kW (100PS)		
Beta Coupe 1600		04/76→12/84					
Beta H.P.E. 1600		08/80→09/84					
Beta Spider 1600		05/76→08/82					
Trevi 1600		05/80→01/87					TD1796
Beta 2000		04/76→07/82	828 B1.000		4cyl. 1995cc 85kW (116PS)		
Beta Coupe 2000		04/76→12/84					
Beta H.P.E. 2000		05/76→09/84					
Beta Spider 2000		05/76→10/86					TD1797
Beta H.P.E. 2000 i.e.		05/81→09/84	828 B4.000		4cyl. 1995cc 90kW (122PS)		
Trevi 2000 i.e.		05/80→01/87					TD4602
Prisma 2.0 i.e. All-wheel Drive		04/86→12/89	831 B4.000		4cyl. 1995cc 85kW (116PS)		
							TD1812





Delta I 2.0 HF Integrale	11/86→08/88	831 B5.000	4cyl. 1995cc	121kW (165PS) Turbo Intercooled	TD1823
Delta I 1.6 GT i.e. Prisma 1.6 i.e.	08/86→08/88 05/86→12/89	831 B7.000	4cyl. 1585cc	80kW (109PS)	TD1817
Delta I 2.0 HF Integrale	10/87→02/89	831 C5.000	4cyl. 1995cc	133kW (181PS) Turbo Intercooled	TD1821
Delta I 2.0 16V HF Integrale	03/89→09/91	831 D5.000	4cyl. 1995cc	136kW (185PS) Turbo	TD1825
Thema 2000 i.e.	11/84→09/88	834 B.000	4cyl. 1995cc	77kW (105PS)	TD1833
Thema 2000 i.e.	03/86→09/88	834 B.048	4cyl. 1995cc	88kW (120PS)	TD1829
Thema 2000 i.e.	09/87→05/92	834 B.146	4cyl. 1995cc	88kW (120PS)	TD1818
Thema 2000 i.e.	09/88→05/92	834 B1.000	4cyl. 1995cc	88kW (120PS)	TD1830
Thema 2000 i.e. 16V Thema Sw 2000 i.e. 16V	05/88→08/92 05/89→08/92	834 B2.000	4cyl. 1995cc	110kW (150PS)	TD14549
Thema 2000 i.e. 16V, Thema Sw 2000 i.e. 16V	02/89→05/92	834 B2.246	4cyl. 1995cc	110kW (150PS)	TD1832
Thema 2000 i.e. Turbo	11/84→12/87	834 C.000	4cyl. 1995cc	121kW (165PS) Turbo Intercooled	TD1834
Thema 2000 i.e. Turbo Thema Sw 2000 Turbo	07/86→05/90 01/89→03/92	834 C.146	4cyl. 1995cc	121kW (165PS) Turbo Intercooled	TD1837
Dedra 2.0 i.e.	09/89→07/92	835 A5.000	4cyl. 1995cc	88kW (120PS)	TD14589
Dedra 2.0 i.e.	09/89→07/99	835 A5.046	4cyl. 1995cc	83kW (113PS)	TD1848





Dedra 2.0 i.e. Turbo Integrale		05/90→07/94	835 A7.000		4cyl. 1995cc 130kW (177PS) Turbo Intercooled	TD1849
Dedra 2.0 HF Integrale		11/90→07/94	835 A7.046		4cyl. 1995cc 130kW (177PS) Turbo Intercooled	TD1850
08-207600-00	STD	84.00	1.500		001 IF CR P	IKA
08-207604-00	0.20mm		2.000		026 P	STD
08-207606-00	0.40mm		3.947		712 CR	ST
08-207608-00	0.60mm					
<i>[R28906]</i>						
08-215300-10	STD	84.00	1.500		001 IF CR P	KV1
08-215306-10	0.40mm		2.000		026 P	STD
08-215308-10	0.60mm		3.947		232 P	STD
02/1988→						
<i>[R46970]</i>						
Delta II 2.0 16V Turbo		07/96→08/99	175 A4.000		4cyl. 1995cc 137kW (186PS) Turbo Intercooled	28 TD11827
Delta I 2.0 16V HF Evo Integrale		06/93→01/94	831 E5.000		4cyl. 1995cc 137kW (186PS) Turbo Intercooled	TD1827
Delta I 2.0 16V HF Evo Integrale		06/93→01/94	831 E5.046		4cyl. 1995cc 137kW (186PS) Turbo Intercooled	TD1826
Thema 2000 16V Turbo, Thema Sw 2000 i.e. 16V Turbo		12/88→06/90	834 C1.000		4cyl. 1995cc 136kW (185PS) Turbo Intercooled	TD1835
Thema 2000 16V Thema Sw 2000 16V		08/92→12/93 05/92→07/94	834 F1.000		4cyl. 1995cc 102kW (139PS)	TD1831
Thema 2000 16V Turbo Thema Sw 2000 Turbo 16V		10/92→07/94 11/92→07/94	834 F2.000		4cyl. 1995cc 136kW (185PS) Turbo Intercooled	TD1840
Dedra 1.8 i.e.		09/89→06/94	835 A2.000		4cyl. 1756cc 79kW (107PS)	TD1845
Delta II 1.8 i.e.		06/93→08/99	835 C2.000		4cyl. 1756cc 76kW (103PS)	TD4612
Delta II 2.0 16V Turbo		06/93→08/99	836 A2.000		4cyl. 1995cc 137kW (186PS) Turbo Intercooled	TD5435





Dedra 2.0 16V, Dedra SW 2.0 16V, Dedra SW 2.0 Integrale		07/94→07/99	836 A3.000				
Delta II 2.0		11/94→04/98		4cyl.	1995cc	102kW (139PS)	
Delta II 2.0 16V		06/93→08/99					TD4614
Kappa 2.0 16V Turbo		02/95→10/01	838 A4.000				
Kappa Coupe 2.0 16V Turbo		11/96→03/01		4cyl.	1995cc	150kW (204PS)	
Kappa SW 2.0 16V Turbo		07/96→10/01		Turbo Intercooled			TD4619
08-142400-00	STD	84.00	1.500		001 IF CK		KV1
08-142406-00	0.40mm		1.500		026 P		STD
[R60030]			3.000		231 P		STD
Phedra 2.0 JTD		09/02→11/10	DW10ATED4 (RHW) Euro 3				29
Zeta 2.0 JTD		09/99→09/02		4cyl.	1997cc	80kW (109PS)	
				Diesel	Turbo Intercooled		TD16735
Phedra 2.2 JTD		09/02→11/10	DW12ATED4 (4HW)				
				4cyl.	2179cc	94kW (128PS)	
				Diesel	Turbo Intercooled		TD16736
Phedra 2.0 D Multijet		07/06→11/10	RHR (DW10BTED4) Euro 4				
				4cyl.	1997cc	100kW (136PS)	
				Diesel	Turbo Intercooled		TD26955
08-114700-00	STD	85.00	3.500		008 CK P		KV1
08-114708-00	0.60mm		2.000		005 IFU P		STD
[R60410]			3.000		231 CR P		STD
Zeta 2.1 TD		05/96→09/99	P 8 C (XUD11)				30
				4cyl.	2088cc	80kW (109PS)	
				Diesel	Turbo Intercooled		TD1859
08-126600-00	STD	85.00	3.000		008 CK P		KV1
08-126608-00	0.60mm		2.000		005 IF NT		IKA
[R60670]			3.000		231 CR		STD
Zeta 2.0 16V		05/98→07/00	RFV (XU10J4R)				31
				4cyl.	1998cc	97kW (132PS)	
				Turbo			TD26959
Zeta 2.0 Turbo		05/95→09/02	RGX (XU10J2TE)				
				4cyl.	1998cc	108kW (147PS)	
				Turbo			TD26958
08-154600-00	STD	86.00	1.500		001 IF MO P		IKA
08-154605-00	0.25mm		1.750		026 P		STD
08-154608-00	0.60mm		3.000		712 CR		ST
[R60210]							



Dedra 1.6 16V, Dedra SW 1.6 16V	01/96→07/99	182 A4.000							
Delta II 1.6 i.e. 16V	01/96→08/99		4cyl.						32
Lybra 1.6 16V, Lybra SW 1.6 16V	07/99→10/05		1581cc	76kW (103PS)					
TD9476									

Delta II 1.6 i.e.	03/96→08/99	182 A6.000							
			4cyl.						
			1581cc	66kW (89PS)					
TD9475									

08-786800-00	STD	86.40	1.500		001 IW CR P		KV1
08-786806-00	0.40mm		1.500		005 IWU P		STD
[R60100]			3.000		712 CR		ST

Delta I 1.5	09/79→12/92	831 A1.000							
Prisma 1.5	01/83→04/86		4cyl.						33
			1498cc	63kW (86PS)					
TD1805									

Delta I 1.3	09/79→08/92	831 A2.000							
Prisma 1.3	01/83→02/92		4cyl.						
			1301cc	55kW (75PS)					
TD4605									

Delta I 1.3	09/79→08/92	831 B.000							
			4cyl.						
			1299cc	55kW (75PS)					
TD1809									

Delta I 1.5	09/79→12/92	831 B1.000							
Prisma 1.5	08/86→02/92		4cyl.						
			1498cc	59-63kW (80-86PS)					
TD1811									

Prisma 1.5	09/85→02/92	831 B1.048							
			4cyl.						
			1498cc	55kW (75PS)					
TD1810									

08-209700-00	STD	86.40	1.500		001 IF CR P		IKA
08-209706-00	0.40mm		2.000		026 P		STD
08-209708-00	0.60mm		3.947		712 CR		ST
[R47780]							

Dedra 1.6 i.e.	08/89→06/94	835 A1.000							
			4cyl.						34
			1581cc	55kW (75PS)					
TD1842									

Dedra 1.6 i.e.	08/89→03/93	835 A1.046							
			4cyl.						
			1581cc	55kW (75PS)					
TD1843									

Dedra 1.6 i.e.	04/93→07/99	835 C1.000							
Delta II 1.6 i.e.	06/93→08/99		4cyl.						
			1581cc	55kW (75PS)					
TD4611									

08-783700-00	STD	86.40	1.500		001 IF CR P		IKA
08-783706-00	0.40mm		1.750		026 P		STD
08-783711-00	1.00mm		3.000		712 CR		ST
[R46950]							



Thema 2500 Turbo DS, Thema Sw 2500 Turbo DS		05/88→07/92	8144. 97S	4cyl. 2500cc	77kW (105PS)	35
			Diesel	Turbo		TD1785
Thema 2500 Turbo D Thema Sw 2500 Turbo DS		11/84→09/88 03/87→09/90	8144.91 (Sofim)	4cyl. 2445cc	76kW (103PS)	
			Diesel	Turbo Intercooled		TD4600
Thema 2500 Turbo DS, Thema Sw 2500 Turbo DS		06/88→05/92	8144.97 (Sofim)	4cyl. 2499cc	85kW (116PS)	
			Diesel	Turbo Intercooled		TD4601
Thema 2500 Turbo DS Thema Sw 2500 Turbo DS		05/92→07/94 09/92→07/94	8144.97 Y (Sofim)	4cyl. 2499cc	85kW (116PS)	
			Diesel	Turbo Intercooled		TD1786
Thema 2500 Turbo DS, Thema Sw 2500 Turbo DS			8144.97.2200	4cyl. 2499cc	87-85kW (118-116PS)	
			Diesel	Turbo Intercooled		TD19036

08-245200-00	STD	93.00	3.000		008 CR P	KV1
08-245208-00	0.60mm		2.000		005 P	F12/F14
[R47080]			3.000		231 CR P	STD

Thema 3000 V6 Thema Sw 3000 V6		08/92→07/94 09/92→07/94	834 F.000	6cyl. 2959cc	126kW (171PS)	36
						TD1841

08-527500-00	STD	93.00	1.500		001 IF CR P	KV1
[R46500]			1.500		005 P	GOE12
			3.500		232 P	GOE12

Kappa 3.0 24V Kappa Coupe 3.0 24V Kappa SW 3.0 24V		08/94→10/01 11/96→03/01 07/96→10/01	838 B.000	V6cyl. 2959cc	150kW (204PS)	37
						TD4620

08-138800-00	STD	93.00	1.200		001 P NT	KV1
[R67340]			1.500		005 IWU P	GOE12
			3.500		232 P	GOE12

MODEL INDEX

Modelverzeichnis • Index de modele • Índice de Modelo
Indeks modelu • Модель автомобиля • دليل الموديل



CCM

x



9

01/58→12/85	88 Series II	2 1/4L	Petrol	2286	4	10
01/58→12/85	88 Series II	2.3L (3 Main Bearing Crankshaft)	Diesel	2286	4	11
01/58→12/85	88 Series IIA	2 1/4L	Petrol	2286	4	10
01/58→12/85	88 Series IIA	2.3L (3 Main Bearing Crankshaft)	Diesel	2286	4	11
09/61→12/71	88 Series IIA	2.3L (3 Main Bearing Crankshaft)	Diesel	2286	4	11
01/58→12/85	88 Series III	2 1/4L	Petrol	2286	4	10
01/58→12/85	88 Series III	2.3L (3 Main Bearing Crankshaft)	Diesel	2286	4	11
01/71→12/84	88 Series III	2.3L (3 Main Bearing Crankshaft)	Diesel	2286	4	11
09/63→12/86	88/109 2.3 4x4	11H	Petrol	2286	4	10
09/63→12/86	88/109 2.3 D 4x4	10 J (5 Main Bearing Crankshaft)	Diesel	2286	4	11
09/63→12/86	88/109 Hardtop 2.3 4x4	11H	Petrol	2286	4	10
09/63→12/86	88/109 Hardtop 2.3 D 4x4	10 J (5 Main Bearing Crankshaft)	Diesel	2286	4	11
01/84→12/85	90	2 1/4L	Petrol	2286	4	10
01/83→12/90	90	3.5L Carburettor	Petrol	3528	V8	8
01/58→12/85	90 Series II	2.3L (3 Main Bearing Crankshaft)	Diesel	2286	4	11
01/58→12/85	90 Series IIA	2.3L (3 Main Bearing Crankshaft)	Diesel	2286	4	11
01/58→12/85	90 Series III	2.3L (3 Main Bearing Crankshaft)	Diesel	2286	4	11
06/84→08/87	90/110 2.3 4x4	10 H	Petrol	2286	4	10
06/84→08/87	90/110 2.3 D 4x4	10 J (5 Main Bearing Crankshaft)	Diesel	2286	4	11
09/85→07/90	90/110 2.5 4x4	17H	Petrol	2495	4	10
10/85→07/90	90/110 2.5 4x4	17H	Petrol	2495	4	10
09/86→08/88	90/110 2.5 D 4x4	12J	Diesel	2495	4	13
09/86→07/90	90/110 2.5 TD 4x4	19J	Diesel	2495	4	15
01/58→12/85	109 Series II	2 1/4L	Petrol	2286	4	10
01/58→12/85	109 Series IIA	2 1/4L	Petrol	2286	4	10
09/61→12/71	109 Series IIA	2.3L (3 Main Bearing Crankshaft)	Diesel	2286	4	11
01/58→12/85	109 Series III	2 1/4L	Petrol	2286	4	10
01/81→12/85	109 Series III	3.5L Carburettor	Petrol	3528	V8	8
01/71→12/84	109 Series III	2.3L (3 Main Bearing Crankshaft)	Diesel	2286	4	11
01/83→08/86	110	2 1/4L	Petrol	2286	4	10
01/83→12/90	110	3.5L Carburettor	Petrol	3528	V8	8
05/07→	Defender Cabrio 2.4 Td4 4x4	244DT (Duratorq)	Diesel	2402	4	9
09/90→	Defender Cabrio 2.5 90 TDI 4x4	11 L (200Tdi)	Diesel	2495	4	12
09/90→	Defender Cabrio 2.5 90 TDI 4x4	16 L (300Tdi)	Diesel	2495	4	14
09/90→	Defender Cabrio 2.5 90 TDI 4x4	23 L (300Tdi)	Diesel	2495	4	14
09/90→09/01	Defender Cabrio 2.5 D 4x4	12J	Diesel	2495	4	13
06/98→	Defender Cabrio 2.5 Td5 4x4	14 P	Diesel	2495	5	7
06/98→	Defender Cabrio 2.5 Td5 4x4	TD5 (10P)	Diesel	2495	5	7
05/07→	Defender Pickup 2.4 Td4 4x4	244DT (Duratorq)	Diesel	2402	4	9
06/98→	Defender Pickup 2.5 Td5 4x4	TD5 (10P)	Diesel	2495	5	7
05/07→	Defender Station Wagon 2.4 Td4 4x4	244DT (Duratorq)	Diesel	2402	4	9
09/90→12/94	Defender Station Wagon 2.5 4x4	17H	Petrol	2495	4	10
09/90→12/98	Defender Station Wagon 2.5 90,110 TDI 4x4	11 L (200Tdi)	Diesel	2495	4	12
09/90→12/98	Defender Station Wagon 2.5 90,110 TDI 4x4	16 L (300Tdi)	Diesel	2495	4	14
09/90→12/98	Defender Station Wagon 2.5 90,110 TDI 4x4	23 L (300Tdi)	Diesel	2495	4	14
09/90→09/01	Defender Station Wagon 2.5 D 4x4	12J	Diesel	2495	4	13
06/98→	Defender Station Wagon 2.5 Td5 4x4	14 P	Diesel	2495	5	7
06/98→	Defender Station Wagon 2.5 Td5 4x4	TD5 (10P)	Diesel	2495	5	7
09/90→08/93	Defender Station Wagon 3.5 4x4	11 D	Petrol	3528	V8	8
09/90→12/98	Defender Station Wagon 3.5 4x4	22 D	Petrol	3528	V8	8
07/94→10/98	Discovery I 2.5 D 4x4	19 L (300Tdi)	Diesel	2495	4	14
10/89→10/98	Discovery I 2.5 TDI 4x4	12 L (200Tdi)	Diesel	2495	4	12
10/89→10/98	Discovery I 2.5 TDI 4x4	17 L (300Tdi)	Diesel	2495	4	14
10/89→10/98	Discovery I 2.5 TDI 4x4	19 L (300Tdi)	Diesel	2495	4	14
10/89→10/98	Discovery I 2.5 TDI 4x4	21 L (200Tdi)	Diesel	2495	4	12
10/89→06/94	Discovery I 3.5 4x4	22 D	Petrol	3528	V8	8
09/93→10/98	Discovery I 3.9 V8 4x4	35 D	Petrol	3950	V8	17
09/93→10/98	Discovery I 3.9 V8 4x4	36 D	Petrol	3950	V8	17
01/99→06/04	Discovery II 2.5 Td5 4x4	TD5 (10P)	Diesel	2495	5	7
07/04→09/09	Discovery III 2.7 TD 4x4	276DT Euro 4 (TDV6 2.7)	Diesel	2720	V6	4

Modelverzeichnis • Index de modele • Índice de Modelo
Indeks modelu • Модель автомобиля • دليل الموديل

MODEL INDEX



CCM

x



9

09/09→	Discovery IV 2.7 TD 4x4	276DT Euro 4 (TDV6 2.7)	Diesel	2720	V6	4
11/09→	Discovery IV 3.0 SDV6 4x4	30DDTX	Diesel	2993	V6	5
05/10→	Discovery IV 3.0 TD 4x4	30DDTX	Diesel	2993	V6	5
09/09→	Discovery IV 3.0 TD 4x4	30DDTX	Diesel	2993	V6	5
07/12→	Discovery IV 3.0 TD 4x4	306DT Euro 5 (TDV6 3.0)	Diesel	2993	V6	5
09/09→	Discovery IV 3.0 TD 4x4	306DT Euro 5 (TDV6 3.0)	Diesel	2993	V6	5
01/90→09/93	Discovery V8 i	3.5L EFI	Petrol	3528	V8	8
01/90→09/93	Discovery V8 iS	3.5L EFI	Petrol	3528	V8	8
11/00→10/06	Freelander 1.8 16V 4x4	18 K4F (K Series)	Petrol	1796	4	1
02/98→11/00	Freelander 1.8 i 16V 4x4	18 K4F (K Series)	Petrol	1796	4	1
11/00→10/06	Freelander 2.5 V6 4x4	25 K4F	Petrol	2497	V6	3
02/98→10/06	Freelander Soft Top 1.8 i 16V 4x4	18 K4F (K Series)	Petrol	1796	4	1
01/77→12/85	Range Rover	3.5L Carburettor	Petrol	3528	V8	8
09/94→	Range Rover 4.0 V8	V8	Petrol	3950	V8	18
09/94→	Range Rover 4.0 V8 SE	V8	Petrol	3950	V8	18
09/94→	Range Rover 4.6 V8 HSE	V8	Petrol	3950	V8	18
09/91→04/94	Range Rover I 2.5 TDi 4x4	14 L (200Tdi)	Diesel	2495	4	12
07/70→08/81	Range Rover I 3.5 4x4	11 D	Petrol	3528	V8	8
01/87→09/90	Range Rover I 3.5 4x4	31 D	Petrol	3528	V8	8
08/81→09/90	Range Rover I 3.5 Vogue 4x4	11 D	Petrol	3528	V8	8
10/85→09/90	Range Rover I 3.5 Vogue 4x4	24 D	Petrol	3528	V8	8
10/85→09/90	Range Rover I 3.5 Vogue 4x4	25 D	Petrol	3528	V8	8
11/88→07/94	Range Rover I 3.9 4x4 CAT	37 D	Petrol	3950	V8	17
11/88→07/94	Range Rover I 3.9 4x4 CAT	38 D	Petrol	3950	V8	17
11/88→07/94	Range Rover I 3.9 Vogue SEI 4x4	35 D	Petrol	3950	V8	17
11/88→07/94	Range Rover I 3.9 Vogue SEI 4x4	36 D	Petrol	3950	V8	17
09/92→07/94	Range Rover I 4.3 Vogue LSE 4x4	40 D	Petrol	4275	V8	17
08/94→03/02	Range Rover II 2.5 D 4x4	14 L (200Tdi)	Diesel	2495	4	12
07/94→03/02	Range Rover II 2.5 TD 4x4	25 6T (BMW M51D25)	Diesel	2497	6	2
07/94→03/02	Range Rover II 3.9 4x4	42 D	Petrol	3950	V8	18
07/94→03/02	Range Rover II 4.6 4x4	46 D	Petrol	4553	V8	18
08/12→	Range Rover IV 3.0 TD 4x4	306DT Euro 5 (TDV6 3.0)	Diesel	2993	V6	5
02/05→	Range Rover Sport 2.7 TDVM 4x4	276DT Euro 4 (TDV6 2.7)	Diesel	2720	V6	4
04/13→	Range Rover Sport 3.0 TD 4x4	30DDTX	Diesel	2993	V6	5
06/11→	Range Rover Sport 3.0 TD 4x4	30DDTX	Diesel	2993	V6	5
09/09→	Range Rover Sport 3.0 TD 4x4	30DDTX	Diesel	2993	V6	5
08/12→	Range Rover Sport 3.0 TD 4x4	306DT Euro 5 (TDV6 3.0)	Diesel	2993	V6	5
05/10→	Range Rover Sport 3.0 TD V6 4x4	30DDTX	Diesel	2993	V6	5
01/86→12/88	Range Rover V8	3.5L EFI	Petrol	3528	V8	8
01/85→12/89	Range Rover Vogue EFi	3.5L EFI	Petrol	3528	V8	8
01/88→10/89	Range Rover Vogue EFi	3.5L EFI	Petrol	3528	V8	8
01/88→10/89	Range Rover Vogue SE	3.5L EFI	Petrol	3528	V8	8
01/89→01/92	Range Rover Vogue TD	VM 492 HR, VM 492 HS	Diesel	2499	4	16
01/87→12/89	Range Rover Vogue TD	VM 492 HT	Diesel	2393	4	16

ENGINE INDEX

Motorverzeichnis • Index de moteur • Índice de Motor
Indeks silnika • Модель двигателя • دليل المحرك



CCM

x



9

2 1/4L	Petrol	2286	4	90.47	10
2.3L (3 Main Bearing Crankshaft)	Diesel	2286	4	90.47	11
3.5L Carburettor	Petrol	3528	V8	88.86	8
3.5L EFi	Petrol	3528	V8	88.86	8
10 H	Petrol	2286	4	90.47	10
10 J (5 Main Bearing Crankshaft)	Diesel	2286	4	90.47	11
11 D	Petrol	3528	V8	88.86	8
11 L (200Tdi)	Diesel	2495	4	90.47	12
11H	Petrol	2286	4	90.47	10
12 L (200Tdi)	Diesel	2495	4	90.47	12
12J	Diesel	2495	4	90.47	13
14 L (200Tdi)	Diesel	2495	4	90.47	12
14 P	Diesel	2495	5	84.45	7
16 L (300Tdi)	Diesel	2495	4	90.47	14
17 L (300Tdi)	Diesel	2495	4	90.47	14
17H	Petrol	2495	4	90.47	10
18 K4F (K Series)	Petrol	1796	4	80.00	1
19 L (300Tdi)	Diesel	2495	4	90.47	14
19J	Diesel	2495	4	90.47	15
21 L (200Tdi)	Diesel	2495	4	90.47	12
22 D	Petrol	3528	V8	88.86	8
23 L (300Tdi)	Diesel	2495	4	90.47	14
24 D	Petrol	3528	V8	88.86	8
25 6T (BMW M51D25)	Diesel	2497	6	80.00	2
25 D	Petrol	3528	V8	88.86	8
25 K4F	Petrol	2497	V6	80.00	3
30DDTX	Diesel	2993	V6	84.00	5
31 D	Petrol	3528	V8	88.86	8
35 D	Petrol	3950	V8	94.00	17
36 D	Petrol	3950	V8	94.00	17
37 D	Petrol	3950	V8	94.00	17
38 D	Petrol	3950	V8	94.00	17
40 D	Petrol	4275	V8	94.00	17
42 D	Petrol	3950	V8	94.00	18
46 D	Petrol	4553	V8	94.00	18
244DT (Duratorq)	Diesel	2402	4	89.90	9
276DT Euro 4 (TDV6 2.7)	Diesel	2720	V6	81.00	4
306DT Euro 5 (TDV6 3.0)	Diesel	2993	V6	84.00	5
M 47 R	Diesel	1950	4	84.00	6
M57D30 (TD6)	Diesel	2926	6	84.00	6
TD5 (10P)	Diesel	2495	5	84.45	7
V8	Petrol	3950	V8	94.00	18
VM 492 HR, VM 492 HS	Diesel	2499	4	92.00	16
VM 492 HT	Diesel	2393	4	92.00	16



Freelander 1.8 16V 4x4	11/00→10/06	18 K4F (K Series)	1
Freelander 1.8 i 16V 4x4	02/98→11/00	4cyl.	
Freelander Soft Top 1.8 i 16V 4x4	02/98→10/06	1796cc 85-88kW (116-120PS)	
TD20740			

08-522700-00 [R49540]	STD	80.00	1.000		001 CR	ST
			1.200		026 P	STD
			2.000		712 CR	ST

Range Rover II 2.5 TD 4x4	07/94→03/02	25 6T (BMW M51D25)	2
		6cyl. 2497cc 100kW (136PS)	
		Diesel Turbo Intercooled	TD22933

08-704500-00 08-704507-00 [R49900]	STD 0.50mm	80.00	3.000		008 CR P	KV1
			1.750		005 IFU P	IKA
			3.000		231 CR P	STD

Freelander 2.5 V6 4x4	11/00→10/06	25 K4F	3
		V6cyl. 2497cc 130-129kW (177-175PS)	
TD19716			

08-521600-00 [R49740]	STD	80.00	1.200		008 CR	STD
			1.500		026	STD
			2.500		712 CR	ST

Discovery III 2.7 TD 4x4	07/04→09/09	276DT Euro 4 (TDV6 2.7)	4
Discovery IV 2.7 TD 4x4	09/09→	V6cyl. 2720cc 140kW (190PS)	
Range Rover Sport 2.7 TDVM 4x4	02/05→	Diesel Turbo Intercooled	TD24908

08-432400-00	STD	81.00	2.000		001 IF CK	KV1
			2.000		005 IFU	GOE13
			2.000		231	F12/F14

Discovery IV 3.0 TD 4x4	09/09→	306DT Euro 5 (TDV6 3.0)	5
Range Rover IV 3.0 TD 4x4, Range Rover Sport 3.0 TD 4x4	08/12→	V6cyl. 2993cc 180kW (245PS)	
TD24909			

Discovery IV 3.0 SDV6 4x4	11/09→	30DDTX	TD25818
Discovery IV 3.0 TD 4x4, Range Rover Sport 3.0 TD 4x4 Range Rover Sport 3.0 TD V6 4x4	09/09→ 05/10→	V6cyl. 2993cc 155-200kW (211-272PS) Diesel Turbo	

08-439100-00	STD	84.00	2.000		001 IF CK P	KV1
			2.000		005 IFU P	F12/F14
			2.000		231 LKZ CR P	GOE13





				M 47 R				6
				4cyl.				
				1950cc		85kW (116PS)		
				Diesel		Turbo Intercooled		TD24392
				M57D30 (TD6)				
				6cyl.				
				2926cc		130-142kW (177-193PS)		
				Diesel		Turbo Intercooled		TD22322
08-114400-00	STD	84.00	3.000		008 CK P			KV1
08-114405-00	0.25mm		2.000		026 P			STD
[R60220]			3.000		231 CR P			STD
Defender Cabrio 2.5 Td5 4x4,		06/98→		14 P/15 P				7
Defender Station Wagon 2.5 Td5 4x4				5cyl.				
				2495cc		90kW (122PS)		
				Diesel		Turbo		TD25825
Defender Cabrio 2.5 Td5 4x4,		06/98→		TD5 (10P)				
Defender Pickup 2.5 Td5 4x4,				5cyl.				
Defender Station Wagon 2.5 Td5 4x4				2495cc		90-102kW (122-139PS)		
Discovery II 2.5 Td5 4x4		01/99→06/04		Diesel		Turbo		TD25823
08-119800-00	STD	84.45	3.000		008 IF PS			KV1
08-119807-00	0.50mm		2.000		026 P			F12/F14
[R49390]			3.000		231 CR			STD
08-140000-00	STD	84.45	3.000		007 P PS			KV1
08-140007-00	0.50mm		2.000		026 P			F12/F14
[R67720]			3.000		231 CR P			STD
Defender Station Wagon 3.5 4x4		09/90→08/93		11 D				8
Range Rover I 3.5 4x4		07/70→08/81		V8cyl.				
Range Rover I 3.5 Vogue 4x4		08/81→09/90		3528cc		93kW (126PS)		
								TD22941
Defender Station Wagon 3.5 4x4		09/90→12/98		22 D				
Discovery I 3.5 4x4		10/89→06/94		V8cyl.				
				3528cc		113kW (154PS)		
								TD22934
Range Rover I 3.5 Vogue 4x4		10/85→09/90		24 D				
				V8cyl.				
				3528cc		120kW (163PS)		
								TD22939
Range Rover I 3.5 Vogue 4x4		10/85→09/90		25 D				
				V8cyl.				
				3528cc		120kW (163PS)		
								TD22940
90		01/83→12/90		3.5L Carburettor				
109 Series III		01/81→12/85		V8cyl.				
110		01/83→12/90		3528cc				
Range Rover		01/77→12/85						FM2683
Discovery V8 i, Discovery V8 iS		01/90→09/93		3.5L EFi				
Range Rover V8		01/86→12/88		V8cyl.				
Range Rover Vogue EFi		01/85→12/89		3528cc				
Range Rover Vogue SE		01/88→10/89		Injection				FM5059





Range Rover I 3.5 4x4			01/87→09/90	31 D	V8cyl. 3528cc	107kW (146PS)	TD22942
08-520100-00	STD	88.86	1.588		001 CR P		KV1
08-520107-00	.020		1.588		005 IW P		GOE12
[R29296]			4.737		031 P		GOE12
Defender Cabrio 2.4 Td4 4x4, Defender Pickup 2.4 Td4 4x4, Defender Station Wagon 2.4 Td4 4x4			05/07→	244DT (Duratorq)	4cyl. 2402cc	90kW (122PS)	9 TD24907
				Diesel	Turbo Intercooled		
08-148100-00	STD	89.90	2.000		001 CK P		KV1
08-148105-00	0.25mm		2.000		026 P		KV1
08-148107-00	0.50mm		2.000		231 NT		ST
90/110 2.3 4x4			06/84→08/87	10 H	4cyl. 2286cc	52kW (71PS)	10 TD25821
88/109 2.3 4x4, 88/109 Hardtop 2.3 4x4			09/63→12/86	11H	4cyl. 2286cc	51-52kW (69-71PS)	TD25824
90/110 2.5 4x4 Defender Station Wagon 2.5 4x4			09/85→07/90 09/90→12/94	17H	4cyl. 2495cc	61kW (82PS)	TD19656
88 Series II, 88 Series IIA, 88 Series III 90 109 Series II, 109 Series IIA, 109 Series III 110			01/58→12/85 01/84→12/85 01/58→12/85 01/83→08/86	2 1/4L	4cyl. 2286cc	51-52kW (69-71PS)	FM944
08-263100-00	STD	90.47	1.790		001 IF CR P		STD
08-263107-00	.020		1.790		026 P		STD
[R11686V1]			4.747		236 P		STD



88/109 2.3 D 4x4, 88/ 109 Hardtop 2.3 D 4x4 90/110 2.3 D 4x4	09/63→12/86 06/84→08/87	10 J (5 Main Bearing Crankshaft) 4cyl. 2286cc 46-51kW (63-69PS) Diesel	11 TD25822
--	----------------------------	--	----------------------

88 Series II, 88 Series IIA, 88 Series III, 90 Series II, 90 Series IIA, 90 Series III 109 Series IIA 109 Series III	01/58→12/85 09/61→12/71 01/71→12/84	2.3L (3 Main Bearing Crankshaft) 4cyl. 2286cc Diesel	FM945
--	---	--	-------

08-265100-10 STD 08-265107-10 .020 08-265109-10 .030 08-265111-10 .040	90.47	2.385		001 CR P	KV1
		2.385		005 IF P	STD
		2.385		026 P	STD
		4.747		231 CR P	STD
		4.747		031 P	STD
08-526400-00 STD 08-526411-00 .040 eng.36615200A→ [R38540]		90.47	2.385		001 NT
	2.385			005 P	IKA
	2.385			005 P	IKA
	4.770			231 CR P	GOE12

Defender Cabrio 2.5 90 TDI 4x4 Defender Station Wagon 2.5 90, 110 TDI 4x4	09/90→ 09/90→12/98	11 L (200Tdi) 4cyl. 2495cc 83-79kW (113-107PS) Diesel Turbo Intercooled	12 TD20407
---	-----------------------	---	----------------------

Discovery I 2.5 TDI 4x4	10/89→10/98	12 L (200Tdi) 4cyl. 2495cc 83kW (113PS) Diesel Turbo Intercooled	TD20408
-------------------------	-------------	--	---------

Range Rover I 2.5 TDI 4x4 Range Rover II 2.5 D 4x4	09/91→04/94 08/94→03/02	14 L (200Tdi) 4cyl. 2495cc 83kW (113PS) Diesel Turbo Intercooled	TD19655
---	----------------------------	--	---------

Discovery I 2.5 TDI 4x4	10/89→10/98	21 L (200Tdi) 4cyl. 2495cc 83kW (113PS) Diesel Turbo Intercooled	TD20410
-------------------------	-------------	--	---------

08-524400-00 STD 08-524407-00 .020 [R45000]	90.47	2.500		008 CR P	KV1
		2.000		005 P	IKA
		3.000		231 CR P	GOE12

90/110 2.5 D 4x4 Defender Cabrio 2.5 D 4x4, Defender Station Wagon 2.5 D 4x4	09/86→08/88 09/90→09/01	12J 4cyl. 2495cc 51kW (69PS) Diesel Turbo	13 TD24370
--	----------------------------	---	----------------------

08-714400-00 STD 08-714407-00 .020 08-714411-00 .040 [R41710]	90.47	2.000		001 CR P	KV1
		2.000		005 P	STD
		4.000		231 CR P	STD



Defender Cabrio 2.5 90 TDI 4x4 Defender Station Wagon 2.5 90, 110 TDI 4x4	09/90→ 09/90→12/98	16 L (300Tdi) 4cyl. 2495cc 83kW (113PS) Diesel Turbo Intercooled	14
Discovery I 2.5 TDI 4x4	10/89→10/98	17 L (300Tdi) 4cyl. 2495cc 83kW (113PS) Diesel Turbo Intercooled	TD20411
Discovery I 2.5 D 4x4 Discovery I 2.5 TDI 4x4	07/94→10/98 10/89→10/98	19 L (300Tdi) 4cyl. 2495cc 90-83kW (122-113PS) Diesel Turbo Intercooled	TD20412 TD20409
Defender Cabrio 2.5 90 TDI 4x4 Defender Station Wagon 2.5 90, 110 TDI 4x4	09/90→ 09/90→12/98	23 L (300Tdi) 4cyl. 2495cc 86-83kW (117-113PS) Diesel Turbo Intercooled	TD20406

08-521800-20 STD	90.47	3.000		008	KV1
08-521807-20 .020				026	F12/F14
08-521811-20 .040		2.500		231 CR	GOE12
[R48730]		3.000			

90/110 2.5 TD 4x4	09/86→07/90	19J 4cyl. 2495cc 63kW (86PS) Diesel Turbo	15		
08-524200-00 STD	90.47	1.990		001 CR P	KV1
08-524207-00 .020				005 IFU P	IKA
08-524211-00 .040		1.950		231 CR P	GOE12
[R43170]		3.000			

Range Rover Vogue TD	01/89→01/92	VM 492 HR, VM 492 HS 4cyl. 2499cc Diesel Turbo	16		
Range Rover Vogue TD	01/87→12/89	VM 492 HT 4cyl. 2393cc Diesel Turbo	FM9171 FM4047		
08-110100-00 STD	92.00	2.500		008 CR P	KV1
[R47730]				026 P	STD
		2.000		231 CR P	STD
		4.000			



Discovery I 3.9 V8 4x4 Range Rover I 3.9 Vogue SEI 4x4	09/93→10/98 11/88→07/94	35 D	V8cyl. 3950cc	134kW (182PS)	17
					TD22930

Discovery I 3.9 V8 4x4 Range Rover I 3.9 Vogue SEI 4x4	09/93→10/98 11/88→07/94	36 D	V8cyl. 3950cc	134kW (182PS)	17
					TD22929

Range Rover I 3.9 4x4 CAT	11/88→07/94	37 D	V8cyl. 3950cc	127kW (173PS)	17
					TD22937

Range Rover I 3.9 4x4 CAT	11/88→07/94	38 D	V8cyl. 3950cc	127kW (173PS)	17
					TD22938

Range Rover I 4.3 Vogue LSE 4x4	09/92→07/94	40 D	V8cyl. 4275cc	149kW (203PS)	17
					TD22935

08-524500-00 [R45050]	STD	94.00	1.500		001 MO P	KV1
			1.500		005 IFU P	GOE12
			3.000		712 CR	ST

Range Rover II 3.9 4x4	07/94→03/02	42 D	V8cyl. 3950cc	140kW (190PS)	18
					TD22932

Range Rover II 4.6 4x4	07/94→03/02	46 D	V8cyl. 4553cc	165kW (224PS)	18
					TD22931

Range Rover 4.0 V8, Range Rover 4.0 V8 SE, Range Rover 4.6 V8 HSE	09/94→	V8	V8cyl. 3950cc Injection		18
					FM6884

08-521500-00 09/1994→ [R49500]	STD	94.00	1.200		001	GOE12
			1.500		005	GOE12
			3.000		712 CR	ST

Modelverzeichnis • Index de modele • Índice de Modelo
Indeks modelu • Модель автомобиля • دليل المحرك

MODEL INDEX



CCM

x



9

10/94→03/96	200 Box 1.9 D	XUD9	Diesel	1905	4	2
10/94→03/96	200 Pickup 1.9 D	XUD9	Diesel	1905	4	2
01/94→12/96	200 Series Van	XUD9B	Diesel	1905	4	2
04/89→03/96	400 Box 2.5 D	EN 55	Diesel	2498	4	6
04/89→03/96	400 Box 2.5 D	ET 70	Diesel	2496	4	7
04/89→03/96	400 Bus 2.5 D	EN 55	Diesel	2498	4	6
11/95→10/98	400 Bus 2.5 TD	ET 70	Diesel	2496	4	7
04/89→10/96	400 Platform/Chassis 2.5 D	EN 55	Diesel	2498	4	6
11/95→10/96	400 Platform/Chassis 2.5 TD	ET 70	Diesel	2496	4	7
04/96→09/97	Convoy Box 2.5 D	EN 55	Diesel	2498	4	6
04/96→09/97	Convoy Box 2.5 D	ET 70	Diesel	2496	4	7
10/98→04/09	Convoy Box 2.5 DI	EN 55	Diesel	2498	4	6
10/98→04/09	Convoy Box 2.5 TDI	ET 70	Diesel	2496	4	7
04/96→02/02	Convoy Bus 2.5 D	EN 55	Diesel	2498	4	6
04/96→02/02	Convoy Bus 2.5 D	ET 70	Diesel	2496	4	7
04/96→09/97	Convoy Platform/Chassis 2.5 D	EN 55	Diesel	2498	4	6
04/96→09/97	Convoy Platform/Chassis 2.5 D	ET 70	Diesel	2496	4	7
10/98→04/09	Convoy Platform/Chassis 2.5 DI	EN 55	Diesel	2498	4	6
10/98→04/09	Convoy Platform/Chassis 2.5 TDI	ET 70	Diesel	2496	4	7
02/05→12/08	Maxus Box 2.5 D	VM39C	Diesel	2499	4	5
02/05→12/08	Maxus Box 2.5 D	VM40C	Diesel	2499	4	5
02/05→12/09	Maxus Bus 2.5 D	VM39C	Diesel	2499	4	5
02/05→12/08	Maxus Bus 2.5 D	VM40C	Diesel	2499	4	5
02/05→	Maxus CDi	R 425	Diesel	2499	4	5
02/05→12/08	Maxus Platform/Chassis 2.5 D	VM39C	Diesel	2499	4	5
01/84→12/89	Sherpa 285	12J	Diesel	2494	4	4
01/84→12/89	Sherpa 310	12J	Diesel	2494	4	4
11/85→12/89	Sherpa 350	3.5L Carburettor	Petrol	3528	8	3
01/84→12/89	Sherpa 3500EA	12J	Diesel	2494	4	4
03/74→12/82	Sherpa Bus 1.8 D	KD18	Diesel	1798	4	1
01/85→12/89	Sherpa City	12J	Diesel	2494	4	4

Motorverzeichnis • Index de moteur • Índice de Motor
Indeks silnika • Модель двигателя • دليل المحرك

ENGINE INDEX



CCM

x



9

3.5L Carburettor	Petrol	3528	8	88.86	3
12J	Diesel	2494	4	90.47	4
EN 55	Diesel	2498	4	94.00	6
ET 70	Diesel	2496	4	94.00	7
KD18	Diesel	1798	4	80.25	1
R 425	Diesel	2499	4	92.00	5
VM39C	Diesel	2499	4	92.00	5
VM40C	Diesel	2499	4	92.00	5
XUD9	Diesel	1905	4	83.00	2
XUD9B	Diesel	1905	4	83.00	2



Sherpa Bus 1.8 D		03/74→12/82	KD18	4cyl. 1798cc 48kW (65PS)		1
			Diesel			TD16449
08-525900-00	STD	80.25	1.590		001 P	GOE12
08-525907-00	.020				005 P	GOE12
08-525909-00	.030		1.590		231 P	GOE12
08-525911-00	.040					
08-525914-00	.060		4.000			
<i>[R25566]</i>						

200 Box 1.9 D, 200 Pickup 1.9 D		10/94→03/96	XUD9	4cyl. 1905cc 47-48kW (64-65PS)		2
			Diesel			TD26905

200 Series Van		01/94→12/96	XUD9B	4cyl. 1905cc		
			Diesel			FM3219
08-152000-00	STD	83.00	2.000		001 CR P	KV1
08-152003-00	0.125mm				005 P	STD
08-152007-00	0.50mm		2.000		231 CR P	STD
08-152010-00	0.80mm					
08-152011-00	1.00mm		3.000			
<i>[R66390]</i>						

Sherpa 350		11/85→12/89	3.5L Carburettor	8cyl. 3528cc		3	
						FM2683	
08-520100-00	STD	88.86	1.588		001 CR P	KV1	
08-520107-00	.020				005 IW P	GOE12	
11/1985→12/1989			1.588			031 P	GOE12
<i>[R29296]</i>							

Sherpa 285, Sherpa 310, Sherpa 3500EA		01/84→12/89	12J	4cyl. 2494cc		4
Sherpa City		01/85→12/89				FM3610
			Diesel			
08-714400-00	STD	90.47	2.000		001 CR P	KV1
08-714407-00	.020				005 P	STD
08-714411-00	.040		2.000		231 CR P	STD
01/1984→12/1989			4.000			
<i>[R41710]</i>						









Maxus CDi		02/05→	R 425					5
				4cyl.	2499cc			
				Diesel				FM12303
Maxus Box 2.5 D		02/05→12/08	VM39C					
Maxus Bus 2.5 D		02/05→12/09		4cyl.	2499cc	70-88kW (95-120PS)		
Maxus Platform/Chassis 2.5 D		02/05→12/08						TD26107
Maxus Box 2.5 D, Maxus Bus 2.5 D		02/05→12/08	VM40C					
				4cyl.	2499cc	70kW (95PS)		
				Diesel				TD26108
08-423100-00 →01/2005	STD	92.00	2.500		008 CK P			KV1
			1.500		026 P			IKA
			2.000		231 NT			GOE12
08-429200-00 01/2005→	STD	92.00	2.500		008 IF GDC P			KV1
			1.500		050 P			KV1
			2.000		231 NT			GOE13

400 Box 2.5 D, 400 Bus 2.5 D		04/89→03/96	EN 55					6
400 Platform/Chassis 2.5 D		04/89→10/96		4cyl.	2498cc	53-56kW (72-76PS)		
Convoy Box 2.5 D		04/96→09/97						
Convoy Box 2.5 DI		10/98→04/09	Diesel					
Convoy Bus 2.5 D		04/96→02/02						
Convoy Platform/Chassis 2.5 D		04/96→09/97						
Convoy Platform/Chassis 2.5 DI		10/98→04/09						TD22927
08-318700-10	STD	94.00	2.000		001 CR P			KV1
08-318704-10	0.20mm							
08-318706-10	0.40mm		2.000		005 IF P			STD
08-318707-10	0.50mm							
08-318708-10	0.60mm		4.000		231 CR P			STD
08-318710-10	0.80mm							
08-318711-10	1.00mm							
<i>[R66140]</i>								

400 Box 2.5 D		04/89→03/96	ET 70					7
400 Bus 2.5 TD		11/95→10/98		4cyl.	2496cc	71-74kW (96-101PS)		
400 Platform/Chassis 2.5 TD		11/95→10/96						
Convoy Box 2.5 D		04/96→09/97	Diesel	Turbo Intercooled				
Convoy Box 2.5 TDI		10/98→04/09						
Convoy Bus 2.5 D		04/96→02/02						
Convoy Platform/Chassis 2.5 D		04/96→09/97						
Convoy Platform/Chassis 2.5 TDI		10/98→04/09						TD22928
08-320200-10	STD	94.00	3.000		008 MOL P			IKA
08-320204-10	0.20mm							
08-320206-10	0.40mm		2.000		005 P			IKA
08-320208-10	0.60mm							
08-320211-10	1.00mm		4.000		231 CR P			STD
<i>[R66000]</i>								



IS II 220d		10/05 →		2AD-FHV Euro 4		1
				4cyl.		
				2231cc 130kW (177PS)		
				Diesel Turbo Intercooled		TD18734
08-436300-00	STD	86.00	2.000		001 NT	ST
			1.500		026 P	ST
			2.000		231 NT	ST

HS 250h		07/09 →		2AZ-FXE		2
				4cyl.		
				2362cc 96-117kW (131-159PS)		
						TD23837
08-436400-00	STD	88.50	1.200		001 NT	ST
			1.200		026	ST
			2.000		712 NT	ST

Motorverzeichnis • Index de moteur • Índice de Motor
Indeks silnika • Модель двигателя • دليل المحرك

ENGINE INDEX



CCM

x



9

2.8T, 2.8TD	Diesel	2827	3	100.00	8
4.212	Diesel	3470	4	98.48	5
4/98 DT	Diesel	3770	4	98.00	1
4/98 NT	Diesel	3770	4	98.00	2
4/98 NV	Diesel	3771	4	98.00	3
4/98 NV	Diesel	3771	4	98.00	4
4/98 TT	Diesel	3770	4	98.00	1
4/98 TV	Diesel	3770	4	98.00	1
6.354.2	Diesel	5800	6	98.48	6
6.354.4	Diesel	5800	6	98.48	7
6/98 DT, 6/98 NT	Diesel	5650	6	98.00	2
6/98 DV	Diesel	5655	6	98.00	3
6/98 DV/NV	Diesel	5655	6	98.00	4
6/98 E	Diesel	5650	6	98.00	1
6/98 NV	Diesel	5655	6	98.00	3
6/98 TV	Diesel	5650	6	98.00	1
38T, 38TA	Diesel	3770	4	100.00	8
38TD	Diesel	3770	4	100.00	8
57J, 57JC, 57VD	Diesel	5655	6	100.00	8
411 / 420	Diesel	6540	V6	107.22	9
KT 191	Diesel	11627	6	130.00	11
O.400 P.P.Mk I/II	Diesel	6540	V6	107.22	10
O.400 P.P.Mk III (RH Engine only)	Diesel	6540	6	107.22	10
O.410	Diesel	6540	6	107.22	10
OEE	Diesel	3770	4	100.00	8
OEJ	Diesel	5655	6	100.00	8
TL 11	Diesel	11100	6	130.00	12



1

4/98 DT		4cyl.	3770cc		Diesel Turbo	FM3751
4/98 TT		4cyl.	3770cc		Diesel Turbo	FM6804
4/98 TV		4cyl.	3770cc		Diesel Turbo	FM3750
6/98 E		6cyl.	5650cc		Diesel	FM2794
6/98 TV		6cyl.	5650cc		Diesel Turbo	FM3748
08-703400-00	STD	98.00	2.385		001 CR P	STD
[R32990K]	2.385			005 P	STD	
	2.385			005 P	STD	
	6.335			231 CR P	STD	

2

4/98 NT		4cyl.	3770cc		Diesel Turbo	FM6803
6/98 DT, 6/98 NT		6cyl.	5650cc		Diesel	FM6806
08-525300-00	STD	98.00	2.385		001 CR P	GOE12
→eng.72631	2.385			005 P	GOE12	
[R40130]	2.385			005 P	GOE12	
	6.350			032 P	GOE12	
	4.763			036 P	GOE12	
08-703400-00	STD	98.00	2.385		001 CR P	STD
eng.72632→	2.385			005 P	STD	
[R32990K]	2.385			005 P	STD	
	6.335			231 CR P	STD	

3

4/98 NV		4cyl.	3771cc	46-55kW (63-75PS)	Diesel	TD7513
6/98 DV		6cyl.	5655cc	71-84kW (97-114PS)	Diesel	TD7488
6/98 NV		6cyl.	5655cc	71-86kW (97-117PS)	Diesel	TD7490
08-525300-00	STD	98.00	2.385		001 CR P	GOE12
→eng.35278	2.385			005 P	GOE12	
[R40130]	2.385			005 P	GOE12	
	6.350			032 P	GOE12	
	4.763			036 P	GOE12	
08-703400-00	STD	98.00	2.385		001 CR P	STD
eng.35279→	2.385			005 P	STD	
[R32990K]	2.385			005 P	STD	
	6.335			231 CR P	STD	



4

4/98 NV		4cyl.	3771cc	46-55kW (63-75PS)	Diesel	FM3749
6/98 DV/NV		6cyl.	5655cc	71-86kW (97-117PS)	Diesel	FM3747
08-526200-00	STD	98.00	3.000		008 CR P	KV1
[R34200K]	2.390			005 P	GOE12	
	4.770			231 CR P	GOE12	
08-703400-00	STD	98.00	2.385		001 CR P	STD
[R32990K]	2.385			005 P	STD	
	2.385			005 P	STD	
	6.335			231 CR P	STD	

5

4.212		4cyl.	3470cc	Diesel	FM1359	
08-322100-00	STD	98.48	2.385		001 CR P	IKA
[R34680K]	2.385			005 IW P	STD	
	2.385			001 P	STD	
	6.335			231 CR P	STD	

6

6.354.2		6cyl.	5800cc	Diesel	FM1364	
08-101000-00 ¹	STD	98.48	3.160		001 CR P	KV1
[R34690/3K]	2.385			001 IF P	STD	
	2.385			023 P	STD	
	6.335			231 P	STD	
	6.335			031 P	STD	

¹ For Cast Iron Bores only

¹ Nur für Gußeisenbohrungen

¹ Pour intérieur cylindre seulement

¹ Para diámetro internos de hierro fundido solamente



7

6.354.4		6cyl.	5800cc	Diesel		FM1367
08-315000-10 [R39140]	STD	98.48	2.385		001 IF CR P	STD
			2.385		001 IF P	STD
			2.385		023 P	STD
			6.335		231 P	STD
			6.335		031 P	STD
08-318900-10 08-318905-10 [R34740/2K]	STD 0.25mm	98.48	2.385		001 IF CR P	KV1
			2.385		005 IW P	STD
			4.747		231 CR P	STD
08-525200-00 08-525209-00 [R34770K]	STD .030	98.48	2.385		001 CR P	GOE12
			2.385		001 IW P	GOE12
			2.385		001 IW P	GOE12
			6.350		030 P	GOE12
			6.350		030 P	GOE12

8

2.8T, 2.8TD		3cyl.	2827cc	Diesel		FM1294
38T, 38TA		4cyl.	3770cc	Diesel		FM1295
38TD		4cyl.	3770cc	Diesel		FM6807
57J, 57JC, 57VD		6cyl.	5655cc	Diesel		FM1012
OEE		4cyl.	3770cc	Diesel		FM115
OEJ		6cyl.	5655cc	Diesel		FM116
08-291900-10 [R18130K]	STD	100.00	3.947		008 CR P	KV1
			2.385		001 IF P	STD
			2.385		023 P	STD
			6.335		231 CR P	STD
			6.335		031 P	STD

9

411 / 420		V6cyl.	6540cc	113kW (154PS)	Diesel Turbo	FM1022
08-523400-00 [R40350]	STD	107.22	3.175		008	F12/F14
			2.380		005 IF	F12/F14
			4.763		232 P	F12/F14



10

O.400 P.P.Mk I/II V6cyl. 6540cc Diesel FM1017

O.400 P.P.Mk III (RH Engine only) 6cyl. 6540cc Diesel FM1018

O.410 6cyl. 6540cc Diesel Turbo FM1020

Part No.	Std	Weight	Length	Material	Part No.	Material
08-525600-00	STD	107.22	3.360		008 P	IKA
[R21254]			3.360		008 P	IKA
			6.335		231 P	STD
			6.335		031 P	STD

11

KT 191 6cyl. 11627cc 256kW (348PS) Diesel Turbo Intercooled FM5278

Part No.	Std	Weight	Length	Material	Part No.	Material
08-174100-10	STD	130.00	3.160		008 CR P	IKA
[R46320]			3.160		005 CR P	STD
			3.160		005 CR P	STD
			6.335		231 CR P	STD

12

TL 11 6cyl. 11100cc Diesel Turbo FM1036

Part No.	Std	Weight	Length	Material	Part No.	Material
08-521000-00 ¹	STD	130.00	3.175		008	KV1
[R41550]			2.375		005	STD
			4.737		231	STD

¹ 6 degree Wedge Top Ring

¹ 6-Grad Keiloberring

¹ Segment trapézoïdal angle 6 de grés.

¹ Anillo superior en cuña de 6 grados

ENGINE INDEX

Motorverzeichnis • Index de moteur • Índice de Motor
Indeks silnika • Модель двигателя • دليل المحرك



CCM

x



9

HL4	Diesel	4184	4	108.00	4
HL6	Diesel	6277	6	108.00	4
HR2	Diesel	2090	2	108.00	4
HR3	Diesel	3140	3	108.00	4
HR4	Diesel	4180	4	108.00	4
HR6	Diesel	6270	6	108.00	4
HRS6	Diesel	6270	6	108.00	4
HRW2	Diesel	2090	2	108.00	4
HRW3	Diesel	3140	3	108.00	4
HRW4	Diesel	4180	4	108.00	4
HRW6	Diesel	6270	6	108.00	4
LT1	Diesel	409	1	82.55	1
LT2	Diesel	816	2	82.55	1
PH1	Diesel	659	1	87.32	2
PH1W	Diesel	659	1	87.32	2
PH2	Diesel	1318	2	87.32	2
PH2W	Diesel	1318	2	87.32	2
ST1	Diesel	630	1	95.25	3
ST2	Diesel	1270	2	95.25	3
ST3	Diesel	1900	3	95.25	3
TS1	Diesel	635	1	95.25	3
TS2	Diesel	1270	2	95.25	3
TS3	Diesel	1900	3	95.25	3



1

LT1		1cyl.	409cc		Diesel	FM956
LT2		2cyl.	816cc		Diesel	FM3883
08-526000-00	STD	82.55	2.420		008 CR P	IKA
[R28174]			1.980		005 P	GOE12
			3.970		231 CR P	GOE12
			3.970		030 P	GOE12

2

PH1		1cyl.	659cc		Diesel	FM2516	
PH1W		1cyl.	659cc		Diesel	FM3855	
PH2		2cyl.	1318cc		Diesel	FM3856	
PH2W		2cyl.	1318cc		Diesel	FM3857	
08-525000-00	STD	87.32	2.385		001 CR	GOE12	
08-525007-00	.020						
08-525011-00	.040		2.385		001	GOE12	
08-525014-00	.060		2.385		023	GOE12	
[R10290K]			4.763		032 P	GOE12	

3

ST1		1cyl.	630cc		Diesel	FM965	
ST2		2cyl.	1270cc		Diesel	FM5323	
ST3		3cyl.	1900cc		Diesel	FM5324	
TS1		1cyl.	635cc		Diesel	FM3398	
TS2		2cyl.	1270cc		Diesel	FM5325	
TS3		3cyl.	1900cc		Diesel	FM5326	
08-523800-00	STD	95.25	3.180		008 CR	KV1	
08-523807-00	.020						
08-523811-00	.040		2.390		005	GOE12	
[R26834]			2.390		005	GOE12	
			4.750		231 CR	GOE12	
		4.760		030	GOE12		



4

HL4	4cyl.	4184cc	Diesel	FM6888
HL6	6cyl.	6277cc	Diesel	FM6889
HR2	2cyl.	2090cc	Diesel	FM973
HR3	3cyl.	3140cc	Diesel	FM974
HR4	4cyl.	4180cc	Diesel	FM975
HR6	6cyl.	6270cc	Diesel	FM976
HRS6	6cyl.	6270cc	Diesel Supercharged	FM977
HRW2	2cyl.	2090cc	Diesel	FM10973
HRW3	3cyl.	3140cc	Diesel	FM10974
HRW4	4cyl.	4180cc	Diesel	FM10975
HRW6	6cyl.	6270cc	Diesel	FM10976

08-522100-00 STD
08-522107-00 .020

108.00

3.969



008 CR

3.175



005

[R25710K]

3.175



005

4.763



231 CR

4.763



030

Motorverzeichnis • Index de moteur • Índice de Motor
Indeks silnika • Модель двигателя • دليل المحرك

ENGINE INDEX



CCM

x



9

3LD510	Diesel	510	1	85.00	2
5LD825.2	Diesel	1649	2	100.00	4
5LD825.3	Diesel	2474	3	100.00	4
5LD825.4	Diesel	3299	4	100.00	4
530, 532, 533, 535, 537	Diesel	359	1	82.00	1
L14	Diesel	817	1	102.00	5
LDA75	Diesel	353	1	85.00	2
LDA96, LDA97	Diesel	638	1	95.00	3
LDA100	Diesel	707	1	100.00	4
LDA450, LDA451	Diesel	454	1	85.00	2
LDA510	Diesel	510	1	85.00	2
LDA672, LDAL672	Diesel	1346	2	95.00	3
LDA673, LDAL673	Diesel	2019	3	95.00	3
LDA674, LDAL674	Diesel	2962	4	95.00	3
LDA820	Diesel	817	1	102.00	5
LDA832, LDAL832	Diesel	1648	2	100.00	4
LDA834, LDAL834	Diesel	3296	4	100.00	4



							1
530, 532, 533, 535, 537		1cyl.	359cc		Diesel		FM9199
08-268300-00	STD	82.00	2.000		001 CR P		STD
08-268307-00	0.50mm		2.000		005 IF P		STD
08-268311-00	1.00mm		2.000		023 P		STD
			5.000		232 P		STD

							2
3LD510		1cyl.	510cc	9kW (12PS)	Diesel		TD17442
LDA450, LDA451		1cyl.	454cc		Diesel		FM4086
LDA510		1cyl.	510cc		Diesel		FM4087
LDA75		1cyl.	353cc		Diesel		FM4084
08-267400-00	STD	85.00	2.000		001 CR P		STD
08-267407-00	0.50mm		2.000		005 IF P		STD
08-267411-00	1.00mm		2.000		023 P		STD
[R47330]			4.000		231 CR P		STD

							3
LDA672, LDAL672		2cyl.	1346cc		Diesel		FM4094
LDA673, LDAL673		3cyl.	2019cc		Diesel		FM4095
LDA674, LDAL674		4cyl.	2962cc		Diesel		FM4096
LDA96, LDA97		1cyl.	638cc		Diesel		FM4089
08-267500-00	STD	95.00	3.000		001 CR P		STD
08-267507-00	0.50mm		3.000		005 IF P		STD
08-267511-00	1.00mm		3.000		023 P		STD
			5.000		231 CR P		STD





							4
5LD825.2		2cyl.	1649cc		Diesel		FM9137
5LD825.3		3cyl.	2474cc		Diesel		FM9138
5LD825.4		4cyl.	3299cc		Diesel		FM9139
LDA100		1cyl.	707cc		Diesel		FM4090
LDA832, LDAL832		2cyl.	1648cc		Diesel		FM4097
LDA834, LDAL834		4cyl.	3296cc		Diesel		FM4099
08-267600-00	STD	100.00	3.000		001 CR P		KV1
08-267607-00	0.50mm		2.500		005 IF P		STD
08-267611-00	1.00mm		2.500		026 P		STD
[R47310]			5.000		230 P		STD



5

L14 1cyl. **817cc** Diesel **FM14091**

LDA820 1cyl. **817cc** Diesel **FM4091**

08-267700-00	STD	102.00	3.000		001 CR P	STD
08-267707-00	0.50mm		2.500		005 IF P	STD
08-267711-00	1.00mm		2.500		026 P	STD
			5.000		231 CR P	STD



Elise S 1.8				1ZZ-FE				1
				4cyl.				
				1796cc		100kW (136PS)		
								TD20080

08-426700-00	STD	79.00	1.200		001 NT	ST
08-426707-00	0.50mm		1.200		005 P	STD
			3.000		712 NT	ST

Elise 1.8		11/00→08/05		18 K4F (K Series)				2
Elise 1.8 16V		08/95→11/00		4cyl.				
				1796cc		85-88kW (116-120PS)		
								TD18865

Elise 111 S		03/99→08/05		18 K4K (VVC) (K Series)				
				4cyl.				
				1796cc		107-118kW (146-160PS)		
								TD22926

08-522700-00	STD	80.00	1.000		001 CR	ST
<i>[R49540]</i>			1.200		026 P	STD
			2.000		712 CR	ST

Elise 1.6		04/10→		1ZR-FAE				3
				4cyl.				
				1598cc		100kW (136PS)		
								TD24847

Elise S 1.8		12/12→		2ZR-FE				
				4cyl.				
				1798cc		162kW (220PS)		
				Supercharged				TD26731

08-439300-00	STD	80.50	1.000		001 CR P	ST
			1.000		026	ST
			1.500		231 PVD	ST

2 Eleven 1.8		04/07→		2ZZ-GE				4
Elise 1.8 R		01/04→		4cyl.				
Exige 1.8 S		01/04→		1796cc		141-191kW (192-260PS)		
Exige 1.8 Cup 240, Exige 1.8 Cup 260		04/06→06/12						
Exige 1.8 GT3		08/06→06/12						TD17319

08-439500-00	STD	82.00	1.200		001 NT	ST
			1.200		026	ST
			3.000		712 CR	ST



TX 2.5 D	01/06→	R 425	4cyl.	1
			2499cc	75kW (102PS)
		Diesel		TD20239

08-423100-00	STD	92.00	2.500		008 CK P	KV1
			1.500		026 P	IKA
			2.000		231 NT	GOE12







Tractor MDI 1250	01/91→	225DI	2cyl. 1250cc	1
		Diesel		FM8632
Tractor MDI 1895/A	01/91→	350DI	3cyl. 1875cc	
		Diesel		FM6077
Commander 650	01/91→	585DI	4cyl. 2500cc	
		Diesel		FM6362

08-289200-00	STD	88.90	3.000		008 CR P	KV1
			2.500		005 P	STD
			4.000		231 CR P	STD



1

EM-1	1cyl.	692cc	Diesel	FM6429
EM-2	2cyl.	1384cc	Diesel	FM8783
EM-3	3cyl.	2076cc	Diesel	FM8784
EM-4	4cyl.	2768cc	Diesel	FM8785

08-275800-00	STD	92.00	3.000		001 IF CR P	STD
			3.000		001 IF P	STD
			3.000		005 P	STD
			4.500		030 P	STD
			4.500		030 P	STD

ENGINE INDEX

Motorverzeichnis • Index de moteur • Índice de Motor
Indeks silnika • Модель двигателя • دليل المحرك



CCM

x



9

D 0022	Diesel		2	100.00	1
D 0024	Diesel		4	100.00	1
D 0026 M1	Diesel	5880	6	100.00	1
D 0026 M2	Diesel	5880	6	100.00	1
D 0026 M6	Diesel	5890	6	100.00	1
D 0226 MC	Diesel	5687	6	102.00	2
D 0226 MCFO/170	Diesel	5687	6	102.00	2
D 0226 MK	Diesel	5687	6	102.00	2
D 0226 MKF	Diesel	5687	6	102.00	2
D 0226 MKF/170	Diesel	5687	6	102.00	2
D 0226 MKFA	Diesel	5687	6	102.00	2
D 0226 MKFO	Diesel	5687	6	102.00	2
D 0226 MKH	Diesel	5687	6	102.00	2
D 0226 ML	Diesel	5687	6	102.00	2
D 0226 MLE	Diesel	5687	6	102.00	2
D 0226 MT	Diesel	5687	6	102.00	2
D 0226 MTE Euro 3	Diesel	5687	6	102.00	2
D 0226 MTKE	Diesel	5687	6	102.00	2
D 0824 GF	Diesel	4580	4	108.00	3
D 0824 GF01	Diesel	4580	4	108.00	3
D 0824 GF02 Euro 1	Diesel	4580	4	108.00	3
D 0824 LF01 Euro 1	Diesel	4580	4	108.00	4
D 0824 LF02 Euro 2	Diesel	4580	4	108.00	4
D 0824 LF03 Euro 1	Diesel	4580	4	108.00	4
D 0824 LF04 Euro 1	Diesel	4580	4	108.00	4
D 0824 LF05 Euro 1	Diesel	4580	4	108.00	4
D 0824 LF06 Euro 1	Diesel	4580	4	108.00	4
D 0824 LF07 Euro 1	Diesel	4580	4	108.00	4
D 0824 LF08 Euro 1	Diesel	4580	4	108.00	4
D 0824 LF09 Euro 1	Diesel	4580	4	108.00	4
D 0824 LF10 Euro 1	Diesel	4580	4	108.00	4
D 0824 LFL01 Euro 1	Diesel	4580	4	108.00	4
D 0824 LFL02 Euro 2	Diesel	4580	4	108.00	4
D 0824 LFL04 Euro 2	Diesel	4580	4	108.00	4
D 0824 LFL05 Euro 1	Diesel	4580	4	108.00	4
D 0824 LFL06 Euro 2	Diesel	4580	4	108.00	4
D 0824 LFL07 Euro 2	Diesel	4580	4	108.00	4
D 0824 LFL08 Euro 2	Diesel	4580	4	108.00	4
D 0824 LFL09 Euro 1	Diesel	4580	4	108.00	4
D 0824 LFL10 Euro 2	Diesel	4580	4	108.00	4
D 0824 LOH01 Euro 1	Diesel	4580	4	108.00	4
D 0824 LOH02 Euro 1	Diesel	4580	4	108.00	4
D 0824 LOH03 Euro 1	Diesel	4580	4	108.00	4
D 0824 LOH04 Euro 1	Diesel	4580	4	108.00	4
D 0824 LOH05 Euro 2	Diesel	4580	4	108.00	4
D 0826 F01	Diesel	6871	6	108.00	3
D 0826 F02	Diesel	6871	6	108.00	3
D 0826 FG001	Diesel	6871	6	108.00	4
D 0826 FG002	Diesel	6871	6	108.00	4
D 0826 FO 01	Diesel	6871	6	108.00	3
D 0826 FO 02	Diesel	6871	6	108.00	3
D 0826 GF	Diesel	6871	6	108.00	3
D 0826 GF01 Euro 1	Diesel	6871	6	108.00	3
D 0826 GF02	Diesel	6871	6	108.00	3
D 0826 GF03	Diesel	6871	6	108.00	3
D 0826 GF04 Euro 1	Diesel	6871	6	108.00	3
D 0826 GFA	Diesel	6871	6	108.00	3
D 0826 GFA 03	Diesel	6871	6	108.00	3
D 0826 GFA 04 Euro 1	Diesel	6871	6	108.00	3
D 0826 LE 521	Diesel	6871	6	108.00	4



CCM

x



9

D 0826 LE 522 Euro 1	Diesel	6871	6	108.00	4
D 0826 LE 523 Euro 1	Diesel	6871	6	108.00	4
D 0826 LE 524 Euro 1	Diesel	6871	6	108.00	4
D 0826 LE 530 Euro 1	Diesel	6871	6	108.00	4
D 0826 LE 531 Euro 1	Diesel	6871	6	108.00	4
D 0826 LF/217/Silent	Diesel	6870	6	108.00	4
D 0826 LF01	Diesel	6871	6	108.00	4
D 0826 LF02 Euro 1	Diesel	6871	6	108.00	4
D 0826 LF04 Euro 1	Diesel	6871	6	108.00	4
D 0826 LF05	Diesel	6871	6	108.00	4
D 0826 LF06	Diesel	6871	6	108.00	4
D 0826 LF07 Euro 1	Diesel	6871	6	108.00	4
D 0826 LF08 Euro 1	Diesel	6871	6	108.00	4
D 0826 LF11 Euro 2	Diesel	6871	6	108.00	4
D 0826 LF12 Euro 2	Diesel	6871	6	108.00	4
D 0826 LF13 Euro 2	Diesel	6871	6	108.00	4
D 0826 LF15 Euro 2	Diesel	6871	6	108.00	4
D 0826 LF17 Euro 2	Diesel	6871	6	108.00	4
D 0826 LF18 Euro 2	Diesel	6871	6	108.00	4
D 0826 LFL Euro 1	Diesel	6871	6	108.00	4
D 0826 LFL02 Euro 1	Diesel	6871	6	108.00	4
D 0826 LFL03 Euro 1	Diesel	6871	6	108.00	4
D 0826 LFL05 Euro 1	Diesel	6871	6	108.00	4
D 0826 LFL06 Euro 1	Diesel	6871	6	108.00	4
D 0826 LFL07 Euro 1	Diesel	6871	6	108.00	4
D 0826 LFL08 Euro 1	Diesel	6871	6	108.00	4
D 0826 LFL09 Euro 2	Diesel	6871	6	108.00	4
D 0826 LFL10 Euro 1	Diesel	6871	6	108.00	4
D 0826 LOH04	Diesel	6871	6	108.00	4
D 0826 LOH05	Diesel	6871	6	108.00	4
D 0826 LOH06 Euro 1	Diesel	6871	6	108.00	4
D 0826 LOH07 Euro 1	Diesel	6871	6	108.00	4
D 0826 LOH15 Euro 2	Diesel	6871	6	108.00	4
D 0826 LOH17 Euro 2	Diesel	6871	6	108.00	4
D 0826 LOH18 Euro 2	Diesel	6871	6	108.00	4
D 0826 LUE51 Euro 1	Diesel	6870	B6	108.00	4
D 0826 LUH Euro 1	Diesel	6870	B6	108.00	4
D 0826 LUH01 Euro 1	Diesel	6871	6	108.00	4
D 0826 LUH02 Euro 1	Diesel	6871	6	108.00	4
D 0826 LUH03 Euro 1	Diesel	6871	6	108.00	4
D 0826 LUH04	Diesel	6871	6	108.00	4
D 0826 LUH05 Euro 1	Diesel	6871	6	108.00	4
D 0826 LUH06 Euro 1	Diesel	6871	6	108.00	4
D 0826 LUH08 Euro 2	Diesel	6871	6	108.00	4
D 0826 LUH09 Euro 2	Diesel	6871	6	108.00	4
D 0826 LUH10 Euro 1	Diesel	6871	6	108.00	4
D 0826 LUH11 Euro 2	Diesel	6871	6	108.00	4
D 0826 LUH12 Euro 1	Diesel	6870	6	108.00	4
D 0826 LUH13 Euro 2	Diesel	6871	6	108.00	4
D 0826 OH	Diesel	6871	6	108.00	4
D 0826 OH01	Diesel	6871	6	108.00	3
D 0826 OH02	Diesel	6871	6	108.00	3
D 0826 OH03 Euro 1	Diesel	6871	6	108.00	3
D 0834 LFL01 Euro 3	Diesel	4580	4	108.00	5
D 0834 LFL02 Euro 3	Diesel	4580	4	108.00	5
D 0834 LFL03 Euro 3	Diesel	4580	4	108.00	5
D 0834 LFL04 Euro 3	Diesel	4580	4	108.00	5
D 0834 LFL20 Euro 3	Diesel	4580	4	108.00	5
D 0834 LFL40 Euro 3	Diesel	4580	4	108.00	6
D 0834 LFL41 Euro 3	Diesel	4580	4	108.00	6

ENGINE INDEX

Motorverzeichnis • Index de moteur • Índice de Motor
Indeks silnika • Модель двигателя • دليل المحرك



CCM

x



9

D 0834 LFL42 Euro 3	Diesel	4580	4	108.00	6
D 0834 LFL50 Euro 4	Diesel	4580	4	108.00	6
D 0834 LFL51 Euro 4	Diesel	4580	4	108.00	6
D 0834 LFL52 Euro 4	Diesel	4580	4	108.00	6
D 0834 LFL53 Euro 4	Diesel	4580	4	108.00	6
D 0834 LFL54 Euro 4	Diesel	4580	4	108.00	6
D 0834 LFL55 Euro 4	Diesel	4580	4	108.00	6
D 0834 LFL60	Diesel	4580	4	108.00	6
D 0834 LFL61	Diesel	4580	4	108.00	6
D 0834 LFL62	Diesel	4580	4	108.00	6
D 0834 LFL63 Euro 5	Diesel	4580	4	108.00	6
D 0834 LFL64 Euro 5	Diesel	4580	4	108.00	6
D 0834 LFL65 Euro 5	Diesel	4580	4	108.00	6
D 0834 LOH 40 Euro 4	Diesel	4580	4	108.00	5
D 0834 LOH 60	Diesel	4580	4	108.00	6
D 0834 LOH 61 Euro 5	Diesel	4580	4	108.00	6
D 0834 LOH01 Euro 3	Diesel	4580	4	108.00	5
D 0834 LOH02 Euro 3	Diesel	4580	4	108.00	5
D 0834 LOH03 Euro 3	Diesel	4580	4	108.00	5
D 0834 LOH50 Euro 4	Diesel	4580	4	108.00	6
D 0834 LOH51 Euro 4	Diesel	4580	4	108.00	6
D 0834 LOH52 Euro 4	Diesel	4580	4	108.00	6
D 0834 LOH53 Euro 4	Diesel	4580	4	108.00	6
D 0836 HM3U	Diesel	7030	6	108.00	7
D 0836 HM4	Diesel	7030	6	108.00	7
D 0836 HM5U	Diesel	7030	6	108.00	7
D 0836 HM7	Diesel	7030	6	108.00	7
D 0836 HM70	Diesel	7030	6	108.00	7
D 0836 HM71	Diesel	7030	6	108.00	7
D 0836 HM7U	Diesel	7030	6	108.00	7
D 0836 HM8U	Diesel	7030	6	108.00	7
D 0836 HM9H	Diesel	7030	6	108.00	7
D 0836 HM9U	Diesel	7030	6	108.00	7
D 0836 HMN70	Diesel	7030	6	108.00	7
D 0836 LF01 Euro 2	Diesel	6871	6	108.00	5
D 0836 LF02 Euro 3	Diesel	6871	6	108.00	5
D 0836 LF03 Euro 3	Diesel	6871	6	108.00	5
D 0836 LF04 Euro 3	Diesel	6871	6	108.00	5
D 0836 LF05 Euro 3	Diesel	6871	6	108.00	5
D 0836 LF41 Euro 3	Diesel	6871	6	108.00	6
D 0836 LF44 Euro 3	Diesel	6871	6	108.00	6
D 0836 LFG50 Euro 4/5	Diesel	6871	6	108.00	6
D 0836 LFL 61	Diesel	6871	6	108.00	6
D 0836 LFL 62	Diesel	6871	6	108.00	6
D 0836 LFL 69 Euro 5	Diesel	6871	6	108.00	6
D 0836 LFL 70 Euro 5	Diesel	6871	6	108.00	6
D 0836 LFL 71 Euro 5	Diesel	6871	6	108.00	6
D 0836 LFL01 Euro 2/3	Diesel	6871	6	108.00	5
D 0836 LFL02 Euro 2/3	Diesel	6871	6	108.00	5
D 0836 LFL03 Euro 3	Diesel	6871	6	108.00	5
D 0836 LFL04 Euro 3	Diesel	6871	6	108.00	5
D 0836 LFL05 Euro 3	Diesel	6871	6	108.00	5
D 0836 LFL06 Euro 3	Diesel	6871	6	108.00	5
D 0836 LFL07 Euro 3	Diesel	6871	6	108.00	5
D 0836 LFL10 Euro 3	Diesel	6871	6	108.00	5
D 0836 LFL40 Euro 3	Diesel	6871	6	108.00	6
D 0836 LFL41 Euro 3	Diesel	6871	6	108.00	6
D 0836 LFL44 Euro 3	Diesel	6871	6	108.00	6
D 0836 LFL50 Euro 4	Diesel	6871	6	108.00	6
D 0836 LFL51 Euro 4	Diesel	6871	6	108.00	6



CCM



9

D 0836 LFL52 Euro 4	Diesel	6871	6	108.00	6
D 0836 LFL53 Euro 4	Diesel	6871	6	108.00	6
D 0836 LFL54 Euro 4	Diesel	6871	6	108.00	6
D 0836 LFL55 Euro 4	Diesel	6871	6	108.00	6
D 0836 LFL63 Euro 5	Diesel	6871	6	108.00	6
D 0836 LFL64 Euro 5	Diesel	6871	6	108.00	6
D 0836 LFL65 Euro 5	Diesel	6871	6	108.00	6
D 0836 LOH01 Euro 3	Diesel	6871	6	108.00	5
D 0836 LOH02 Euro 3	Diesel	6871	6	108.00	5
D 0836 LOH03 Euro 3	Diesel	6871	6	108.00	5
D 0836 LOH40 Euro 3	Diesel	6871	6	108.00	6
D 0836 LOH41 Euro 3	Diesel	6871	6	108.00	6
D 0836 LOH51 Euro 4	Diesel	6871	6	108.00	6
D 0836 LOH52 Euro 4	Diesel	6871	6	108.00	6
D 0836 LOH55 Euro 4	Diesel	6871	6	108.00	6
D 0836 LOH56 Euro 4	Diesel	6871	6	108.00	6
D 0836 LOH60	Diesel	6871	6	108.00	6
D 0836 LOH61	Diesel	6871	6	108.00	6
D 0836 LOH62 Euro 4	Diesel	6871	6	108.00	6
D 0836 LOH63	Diesel	6871	6	108.00	6
D 0836 LOH64 Euro 5	Diesel	6871	6	108.00	6
D 0836 LOH65 Euro 5	Diesel	6871	6	108.00	6
D 0836 LUH01 Euro 3	Diesel	6871	6	108.00	6
D 0836 LUH02 Euro 3	Diesel	6871	6	108.00	6
D 0836 LUH40 Euro 3	Diesel	6871	6	108.00	6
D 0836 LUH41 Euro 3	Diesel	6871	6	108.00	6
D 0836 M2	Diesel	7030	6	108.00	7
D 0836 M2A	Diesel	7030	6	108.00	7
D 0836 M2U	Diesel	7030	6	108.00	7
D 0836 M3H	Diesel	7030	6	108.00	7
D 0846 HM2	Diesel	7250	6	108.00	7
D 0846 HM42U	Diesel	7252	6	108.00	7
D 0846 HM81H	Diesel	7252	6	108.00	7
D 0846 HM82U	Diesel	7252	6	108.00	7
D 0846 HM91H	Diesel	7252	6	108.00	7
D 0846 HM91U	Diesel	7250	6	108.00	7
D 0846 HM95U	Diesel	7252	6	108.00	7
D 0846 HMN	Diesel	7252	6	108.00	7
D 0846 HMN2	Diesel	7252	6	108.00	7
D 0846 HMN80	Diesel	7252	6	108.00	7
D 0846 HMX-011	Diesel	7250	6	108.00	7
D 0846 HMXU-015	Diesel	7250	6	108.00	7
D 0846 HMY-011	Diesel	7250	6	108.00	7
D 0846 HMYH	Diesel	7252	6	108.00	7
D 0846 HMYN-014	Diesel	7252	6	108.00	7
D 1146	Diesel	8072	6	111.00	10
D 1246	Diesel		6	112.00	11
D 2066 LF Euro 2/3	Diesel	10518	6	120.00	12
D 2066 LF Euro 3	Diesel	10518	6	120.00	12
D 2066 LF01 Euro 4	Diesel	10520	6	120.00	12
D 2066 LF02 Euro 4	Diesel	10520	6	120.00	12
D 2066 LF03 Euro 4	Diesel	10520	6	120.00	12
D 2066 LF04 Euro 4	Diesel	10520	6	120.00	12
D 2066 LF06 Euro 3	Diesel	10520	6	120.00	12
D 2066 LF06 Euro 4	Diesel	10520	6	120.00	12
D 2066 LF07 Euro 3	Diesel	10518	6	120.00	12
D 2066 LF11 Euro 4	Diesel	10520	6	120.00	12
D 2066 LF12 Euro 4	Diesel	10520	6	120.00	12
D 2066 LF13 Euro 4	Diesel	10520	6	120.00	12
D 2066 LF14 Euro 4	Diesel	10520	6	120.00	12

ENGINE INDEX

Motorverzeichnis • Index de moteur • Índice de Motor
Indeks silnika • Модель двигателя • دليل المحرك



CCM



9

Engine Model	Fuel Type	CCM	x	Valve Train	Page
D 2066 LF17 Euro 5	Diesel	10518	6	120.00	13
D 2066 LF18 Euro 5	Diesel	10518	6	120.00	13
D 2066 LF19 Euro 5	Diesel	10518	6	120.00	13
D 2066 LF20 Euro 5	Diesel	10518	6	120.00	13
D 2066 LF21 Euro 5	Diesel	10518	6	120.00	13
D 2066 LF22 Euro 5	Diesel	10518	6	120.00	13
D 2066 LF23 Euro 5	Diesel	10518	6	120.00	13
D 2066 LF24 Euro 5	Diesel	10518	6	120.00	13
D 2066 LF25 Euro 5	Diesel	10518	6	120.00	13
D 2066 LF26 Euro 5	Diesel	10518	6	120.00	13
D 2066 LF27 Euro 5	Diesel	10518	6	120.00	13
D 2066 LF28 Euro 4	Diesel	10520	6	120.00	12
D 2066 LF29 Euro 4 (D20)	Diesel	10520	6	120.00	12
D 2066 LF31 Euro 4	Diesel	10520	6	120.00	12
D 2066 LF32 Euro 4	Diesel	10520	6	120.00	12
D 2066 LF33 Euro 4	Diesel	10520	6	120.00	12
D 2066 LF35 Euro 4	Diesel	10520	6	120.00	12
D 2066 LF36 Euro 4	Diesel	10520	6	120.00	12
D 2066 LF37 Euro 4	Diesel	10520	6	120.00	12
D 2066 LF38 Euro 4	Diesel	10520	6	120.00	12
D 2066 LF39 Euro 4	Diesel	10520	6	120.00	12
D 2066 LF40 Euro 5	Diesel	10518	6	120.00	13
D 2066 LF41 Euro 5	Diesel	10518	6	120.00	13
D 2066 LF42 Euro 5	Diesel	10518	6	120.00	13
D 2066 LF43 Euro 5	Diesel	10518	6	120.00	13
D 2066 LF44 Euro 5	Diesel	10518	6	120.00	13
D 2066 LF45 Euro 5	Diesel	10518	6	120.00	13
D 2066 LF46 Euro 5	Diesel	10518	6	120.00	13
D 2066 LF47 Euro 5	Diesel	10518	6	120.00	13
D 2066 LF48 Euro 3	Diesel	10518	6	120.00	12
D 2066 LF49 Euro 3	Diesel	10518	6	120.00	12
D 2066 LF50 Euro 3	Diesel	10518	6	120.00	12
D 2066 LF51 Euro 5	Diesel	10518	6	120.00	13
D 2066 LF52 Euro 5	Diesel	10518	6	120.00	13
D 2066 LF53 Euro 5	Diesel	10518	6	120.00	13
D 2066 LOH01 Euro 4	Diesel	10520	6	120.00	12
D 2066 LOH02 Euro 4	Diesel	10520	6	120.00	12
D 2066 LOH03 Euro 4	Diesel	10520	6	120.00	12
D 2066 LOH04 Euro 4	Diesel	10520	6	120.00	12
D 2066 LOH05 Euro 4	Diesel	10520	6	120.00	12
D 2066 LOH06 Euro 4	Diesel	10520	6	120.00	12
D 2066 LOH07 Euro 4	Diesel	10520	6	120.00	12
D 2066 LOH08 Euro 4	Diesel	10520	6	120.00	12
D 2066 LOH10 Euro 3	Diesel	10518	6	120.00	12
D 2066 LOH11 Euro 3	Diesel	10518	6	120.00	12
D 2066 LOH12 Euro 3	Diesel	10518	6	120.00	12
D 2066 LOH28 Euro 5	Diesel	10518	6	120.00	13
D 2066 LUH 32 Euro 5	Diesel	10518	6	120.00	13
D 2066 LUH 33 Euro 5	Diesel	10518	6	120.00	13
D 2066 LUH 34 Euro 5	Diesel	10518	6	120.00	13
D 2066 LUH07 Euro 3	Diesel	10520	6	120.00	12
D 2066 LUH08 Euro 3	Diesel	10520	6	120.00	12
D 2066 LUH09 Euro 3	Diesel	10520	6	120.00	12
D 2066 LUH11 Euro 4	Diesel	10520	6	120.00	12
D 2066 LUH12 Euro 4	Diesel	10520	6	120.00	12
D 2066 LUH13 Euro 4	Diesel	10520	6	120.00	12
D 2066 LUH14 Euro 4	Diesel	10520	6	120.00	12
D 2066 LUH15 Euro 4	Diesel	10520	6	120.00	12
D 2066 LUH21 Euro 4	Diesel	10520	6	120.00	12
D 2066 LUH22 Euro 4	Diesel	10520	6	120.00	12

CCM

x



9

D 2066 LUH23 Euro 4	Diesel	10520	6	120.00	12
D 2066 LUH24 Euro 4	Diesel	10520	6	120.00	12
D 2146	Diesel	9660	6	121.00	14
D 2156 HM 2	Diesel	10344	6	121.00	15
D 2156 HM3	Diesel	10344	6	121.00	15
D 2156 HM9	Diesel	10344	6	121.00	15
D 2156 HMN1	Diesel	10344	6	121.00	15
D 2156 HMN6	Diesel	10344	6	121.00	15
D 2156 HNY	Diesel	10344	6	121.00	15
D 2156 MGN	Diesel	10344	6	121.00	15
D 2156 MNY	Diesel	10344	6	121.00	15
D 2156 MTN1	Diesel	10344	6	121.00	15
D 2156 MTX	Diesel	10344	6	121.00	15
D 2156 MY	Diesel	10344	6	121.00	15
D 2156 MYN	Diesel	10344	6	121.00	15
D 2356, D 2366	Diesel	10690	6	123.00	16
D 2530 MF	Diesel	15945	V10	125.00	17
D 2530 MXF	Diesel	15945	V10	125.00	17
D 2538 M	Diesel	12763	V8	125.00	17
D 2538 ME	Diesel	12763	V8	125.00	17
D 2538 MF	Diesel	12763	V8	125.00	17
D 2540 MT	Diesel	17426	V10	125.00	18
D 2540 MTF	Diesel	17426	V10	125.00	18
D 2542 ME	Diesel	20911	V12	125.00	17
D 2542 MTE	Diesel	20911	V12	125.00	18
D 2548	Diesel	12756	V8	125.00	18
D 2555 M	Diesel	9200	5	125.00	19
D 2555 MF	Diesel	9200	5	125.00	19
D 2555 MX	Diesel	9200	5	125.00	19
D 2556 M	Diesel	11045	6	125.00	19
D 2556 MX	Diesel	11045	6	125.00	19
D 2556 MXF	Diesel	11045	6	125.00	19
D 2565 HM	Diesel	9510	5	125.00	19
D 2565 M	Diesel	9510	5	125.00	19
D 2565 M/168	Diesel	9510	5	125.00	19
D 2565 ME	Diesel	9510	5	125.00	19
D 2565 MF	Diesel	9510	5	125.00	19
D 2565 MF/168	Diesel	9510	5	125.00	19
D 2565 MFR	Diesel	9510	5	125.00	19
D 2565 MK	Diesel	9510	5	125.00	20
D 2565 MKUL	Diesel	9510	5	125.00	20
D 2565 MR	Diesel	9510	5	125.00	19
D 2565 MT	Diesel	9510	5	125.00	20
D 2565 MUE	Diesel	9510	5	125.00	19
D 2565 MUH	Diesel	9510	5	125.00	19
D 2565 MUL	Diesel	9510	5	125.00	19
D 2566 M	Diesel	11413	6	125.00	19
D 2566 ME	Diesel	11413	6	125.00	19
D 2566 MF	Diesel	11413	6	125.00	19
D 2566 MH	Diesel	11413	6	125.00	19
D 2566 MK	Diesel	11413	6	125.00	20
D 2566 MKF	Diesel	11413	6	125.00	20
D 2566 MKUH/320	Diesel	11413	6	125.00	20
D 2566 MKUL	Diesel	11413	6	125.00	20
D 2566 MLUH	Diesel	11413	6	125.00	20
D 2566 MLUM	Diesel	11413	6	125.00	20
D 2566 MT	Diesel	11413	6	125.00	20
D 2566 MTE	Diesel	11413	6	125.00	20
D 2566 MTF	Diesel	11413	6	125.00	20
D 2566 MTH	Diesel	11413	6	125.00	20

ENGINE INDEX

Motorverzeichnis • Index de moteur • Índice de Motor
Indeks silnika • Модель двигателя • دليل المحرك



CCM

x



9

D 2566 MTHO	Diesel	11413	6	125.00	20
D 2566 MTUH/280	Diesel	11413	6	125.00	20
D 2566 MUE	Diesel	11413	6	125.00	19
D 2566 MUH	Diesel	11413	6	125.00	19
D 2566 MUL	Diesel	11413	6	125.00	19
D 2566 MUM	Diesel	11413	6	125.00	19
D 2566 MXF	Diesel	11413	6	125.00	19
D 2566 UH	Diesel	11413	6	125.00	20
D 2676 LF01 Euro 4	Diesel	12418	6	126.00	21
D 2676 LF05 Euro 4	Diesel	12412	6	126.00	21
D 2676 LF13 Euro 5	Diesel	12412	6	126.00	21
D 2676 LF14 Euro 5	Diesel	12412	6	126.00	21
D 2676 LF15 Euro 5	Diesel	12412	6	126.00	21
D 2676 LF16 Euro 5	Diesel	12412	6	126.00	21
D 2676 LOH01 Euro 4	Diesel	12418	6	126.00	21
D 2676 LOH02 Euro 4	Diesel	12418	6	126.00	21
D 2676 LOH03 Euro 4	Diesel	12412	6	126.00	21
D 2676 LOH04 Euro 4	Diesel	12412	6	126.00	21
D 2676 LOH10 Euro 3	Diesel	12412	6	126.00	21
D 2840	Diesel		10	128.00	22
D 2840 LE	Diesel	18273	V10	128.00	23
D 2840 LF/460	Diesel	18273	V10	128.00	23
D 2840 LF04 Euro 1	Diesel	18273	V10	128.00	23
D 2840 LF06 Euro 1	Diesel	18273	V10	128.00	23
D 2840 LF20 Euro 2	Diesel	18273	V10	128.00	23
D 2840 LF21 Euro 2	Diesel	18273	V10	128.00	24
D 2840 LXF	Diesel	18273	V10	128.00	23
D 2840 ME	Diesel	18273	V10	128.00	25
D 2840 MF	Diesel	18273	V10	128.00	25
D 2840 MFG	Diesel	18273	V10	128.00	25
D 2840 MFR	Diesel	18273	V10	128.00	23
D 2840 MH	Diesel	18273	V10	128.00	25
D 2840 TL	Diesel	18273	V10	128.00	23
D 2842	Diesel		12	128.00	22
D 2842 LE 404	Diesel	21930	V12	128.00	22
D 2842 LE 602	Diesel	21930	V12	128.00	22
D 2842 LF10 Euro 3	Diesel	21927	V12	128.00	23
D 2842 LXE	Diesel	21927	V12	128.00	23
D 2842 LYE	Diesel	21927	V12	128.00	23
D 2842 LZE	Diesel	21927	V12	128.00	23
D 2842 ME	Diesel	21927	V12	128.00	25
D 2848	Diesel		8	128.00	22
D 2848 LXE	Diesel	14618	V8	128.00	23
D 2848 LYE	Diesel	14618	V8	128.00	23
D 2848 MH	Diesel	14618	V8	128.00	23
D 2865 LF/260	Diesel	9973	5	128.00	23
D 2865 LF02	Diesel	9973	5	128.00	23
D 2865 LF03	Diesel	9973	5	128.00	23
D 2865 LF05 Euro 1	Diesel	9973	5	128.00	23
D 2865 LF06 Euro 1	Diesel	9973	5	128.00	23
D 2865 LF21 Euro 2	Diesel	9973	5	128.00	23
D 2865 LF22 Euro 1	Diesel	9973	5	128.00	23
D 2865 LF23 Euro 1	Diesel	9973	5	128.00	23
D 2865 LF24 Euro 2	Diesel	9973	5	128.00	23
D 2865 LOH01 Euro 1	Diesel	9973	5	128.00	23
D 2865 LOH02 Euro 1	Diesel	9973	5	128.00	23
D 2865 LU01/Silent Euro 1	Diesel	9973	5	128.00	23
D 2865 LUH02 Euro 1	Diesel	9973	5	128.00	23
D 2865 LUH05 Euro 1	Diesel	9973	5	128.00	23
D 2865 LUH07 Euro 2	Diesel	9973	5	128.00	23



CCM



9

D 2865 LUH08 Euro 1	Diesel	9973	5	128.00	23
D 2865 LUH09 Euro 2	Diesel	9973	5	128.00	23
D 2866 F/240	Diesel	11967	6	128.00	23
D 2866 FR	Diesel	11967	6	128.00	23
D 2866 KF	Diesel	11967	6	128.00	23
D 2866 KFZ	Diesel	11967	6	128.00	23
D 2866 KOH/360	Diesel	11967	6	128.00	23
D 2866 KUH/360 Euro 1	Diesel	11967	6	128.00	23
D 2866 KUL	Diesel	11967	6	128.00	23
D 2866 LF/290	Diesel	11967	6	128.00	23
D 2866 LF03	Diesel	11967	6	128.00	23
D 2866 LF04	Diesel	11967	6	128.00	23
D 2866 LF05 Euro 1	Diesel	11967	6	128.00	23
D 2866 LF06	Diesel	11967	6	128.00	23
D 2866 LF09 Euro 1	Diesel	11967	6	128.00	23
D 2866 LF10 Euro 1	Diesel	11967	6	128.00	23
D 2866 LF14 Euro 2	Diesel	11967	6	128.00	23
D 2866 LF15 Euro 1	Diesel	11967	6	128.00	23
D 2866 LF16 Euro 2	Diesel	11967	6	128.00	23
D 2866 LF17 Euro 2	Diesel	11967	6	128.00	23
D 2866 LF20 Euro 2	Diesel	11967	6	128.00	23
D 2866 LF21 Euro 1	Diesel	11967	6	128.00	23
D 2866 LF22 Euro 1	Diesel	11967	6	128.00	23
D 2866 LF23 Euro 3	Diesel	11967	6	128.00	24
D 2866 LF24 Euro 3	Diesel	11967	6	128.00	24
D 2866 LF25 Euro 3	Diesel	11967	6	128.00	24
D 2866 LF26 Euro 3	Diesel	11967	6	128.00	24
D 2866 LF27 Euro 4	Diesel	11967	6	128.00	24
D 2866 LF28 Euro 3	Diesel	11967	6	128.00	24
D 2866 LF29 Euro 2	Diesel	11967	6	128.00	23
D 2866 LF30 Euro 2	Diesel	11967	6	128.00	23
D 2866 LF31	Diesel	11967	6	128.00	26
D 2866 LF32 Euro 2	Diesel	11967	6	128.00	23
D 2866 LF32 Euro 2	Diesel	11967	6	128.00	26
D 2866 LF34	Diesel	11967	6	128.00	23
D 2866 LF35	Diesel	11967	6	128.00	23
D 2866 LF36 Euro 2	Diesel	11967	6	128.00	23
D 2866 LF37 Euro 2	Diesel	11967	6	128.00	23
D 2866 LF39 Euro 2	Diesel	11967	6	128.00	26
D 2866 LF40 Euro 2	Diesel	11967	6	128.00	26
D 2866 LF41 Euro 2	Diesel	11967	6	128.00	26
D 2866 LF42 Euro 2	Diesel	11967	6	128.00	26
D 2866 LF43 Euro 2	Diesel	11967	6	128.00	26
D 2866 LFZ/290	Diesel	11967	6	128.00	23
D 2866 LOH	Diesel	11967	6	128.00	23
D 2866 LOH03	Diesel	11967	6	128.00	23
D 2866 LOH06 Euro 1	Diesel	11967	6	128.00	23
D 2866 LOH07	Diesel	11967	6	128.00	23
D 2866 LOH20 Euro 1	Diesel	11967	6	128.00	23
D 2866 LOH22 Euro 1	Diesel	11967	6	128.00	23
D 2866 LOH23 Euro 2	Diesel	11967	6	128.00	23
D 2866 LOH24 Euro 1	Diesel	11970	6	128.00	23
D 2866 LOH25 Euro 2	Diesel	11967	6	128.00	23
D 2866 LOH26 Euro 2	Diesel	11967	6	128.00	23
D 2866 LOH27 Euro 3	Diesel	11967	6	128.00	24
D 2866 LOH28 Euro 3	Diesel	11967	6	128.00	24
D 2866 LOH29 Euro 3	Diesel	11967	6	128.00	24
D 2866 LOH32 Euro 3	Diesel	11967	6	128.00	24
D 2866 LOH33 Euro 3	Diesel	11967	6	128.00	24
D 2866 LOH34 Euro 3	Diesel	11967	6	128.00	24

ENGINE INDEX

Motorverzeichnis • Index de moteur • Índice de Motor
 Indeks silnika • Модель двигателя • دليل المحرك

CCM
x

9

D 2866 LU 01	Diesel	11967	6	128.00	23
D 2866 LU 03 Euro 1	Diesel	11967	6	128.00	23
D 2866 LU/330	Diesel	11967	6	128.00	23
D 2866 LUH/330	Diesel	11967	6	128.00	23
D 2866 LUH20 Euro 2	Diesel	11967	6	128.00	26
D 2866 LUH21 Euro 2	Diesel	11967	6	128.00	23
D 2866 LUH22 Euro 2	Diesel	11967	6	128.00	23
D 2866 LUH23 Euro 3	Diesel	11967	6	128.00	24
D 2866 LUH24 Euro 3	Diesel	11967	6	128.00	24
D 2866 LUH25 Euro 3	Diesel	11967	6	128.00	24
D 2866 LUH26 Euro 2	Diesel	11967	6	128.00	23
D 2866 LUH26 Euro 2	Diesel	11967	6	128.00	26
D 2866 LUH30 Euro 3	Diesel	11967	6	128.00	24
D 2866 LUL/330	Diesel	11967	6	128.00	23
D 2866 LX	Diesel	11967	6	128.00	23
D 2866 LXF	Diesel	11967	6	128.00	23
D 2866 LXOH	Diesel	11967	6	128.00	23
D 2866 T	Diesel	11967	6	128.00	23
D 2866 TOH	Diesel	11967	6	128.00	23
D 2866 TOH/290	Diesel	11967	6	128.00	23
D 2866 TOH/310	Diesel	11967	6	128.00	23
D 2866 TUH	Diesel	11967	6	128.00	23
D 2866 TUH/290	Diesel	11967	6	128.00	23
D 2866 TUH01	Diesel	11967	6	128.00	23
D 2866 UH	Diesel	11967	6	128.00	23
D 2866 UM	Diesel	11967	6	128.00	23
D 2876 LF02 Euro 2	Diesel	12816	6	128.00	22
D 2876 LF03 Euro 3	Diesel	12816	6	128.00	24
D 2876 LF04 Euro 3	Diesel	12816	6	128.00	24
D 2876 LF05 Euro 3	Diesel	12816	6	128.00	24
D 2876 LF06	Diesel	12816	6	128.00	24
D 2876 LF07 Euro 2	Diesel	12816	6	128.00	24
D 2876 LF11 Euro 2	Diesel	12816	6	128.00	24
D 2876 LF12 Euro 3	Diesel	12816	6	128.00	24
D 2876 LF13 Euro 3	Diesel	12816	6	128.00	24
D 2876 LF25 Euro 3	Diesel	12816	6	128.00	24
D 2876 LOH / LUH01 Euro 2	Diesel	12816	6	128.00	22
D 2876 LOH02 Euro 3	Diesel	12816	6	128.00	24
D 2876 LOH03 Euro 3	Diesel	12816	6	128.00	24
D 2876 LOH20 Euro 3	Diesel	12816	6	128.00	24
D 2876 LOH21 Euro 3	Diesel	12816	6	128.00	24
E 0824 E 301		4580	4	108.00	8
E 0826 E 301		6596	6	108.00	8
E 0834 E 302		4580	4	108.00	8
E 0834 E 312		4580	4	108.00	8
E 0836 E 302		6871	6	108.00	8
E 0836 E 312		6871	6	108.00	8
E 0836 LE 202		6871	6	108.00	9
E 2842 LE 322		21927	V12	128.00	27
E 2866 DF01		11967	6	128.00	28
E 2866 DUH 04 Euro 3		11967	6	128.00	28
E 2866 DUH01		11967	6	128.00	28
E 2866 DUH03 Euro 3		11967	6	128.00	28
E 2866 LUH02 Euro 3		11967	6	128.00	28
E 2876 LUH 02		12816	6	128.00	28
E 2876 LUH 03		12816	6	128.00	28
E 2876 LUH 04		12816	6	128.00	28
G 2866 DOH02 Euro 3		11967	6	128.00	29
G 2866 DOH03 Euro 3		11967	6	128.00	29
G 2866 DUH		11961	6	128.00	29

Motorverzeichnis • Index de moteur • Índice de Motor
 Indeks silnika • Модель двигателя • دليل المحرك

ENGINE INDEX



CCM

x



9

G 2866 DUH04 Euro 3		11967	6	128.00	29
G 2866 DUH05 Euro 3		11967	6	128.00	29
G 2876 DUH01 Euro 3		12816	6	128.00	29
MV3A	Diesel		6	112.00	11



1

D 0022		2cyl.			Diesel		FM6159
D 0024		4cyl.			Diesel		FM6160
D 0026 M1		6cyl.	5880cc	84kW (114PS)	Diesel		TD7640
D 0026 M2		6cyl.	5880cc	88kW (120PS)	Diesel		TD7815
D 0026 M6		6cyl.	5890cc	92kW (125PS)	Diesel		TD7642
08-273400-10	STD	100.00	2.500		001 CR P		IKA
			2.500		001 IF P		STD
			2.500		023 P		STD
			5.000		231		STD

2



D 0226 MC		6cyl.	5687cc	125-154kW (170-209PS)	Diesel	Turbo Intercooled	TD23123
D 0226 MCFO/170		6cyl.	5687cc	125kW (170PS)	Diesel	Turbo Intercooled	TD7652
D 0226 MK		6cyl.	5687cc	125-154kW (170-209PS)	Diesel	Turbo Intercooled	TD19077
D 0226 MKF		6cyl.	5687cc	141kW (192PS)	Diesel	Turbo Intercooled	TD7685
D 0226 MKF/170		6cyl.	5687cc	125kW (170PS)	Diesel	Turbo Intercooled	TD7684
D 0226 MKFA		6cyl.	5687cc	125-154kW (170-209PS)	Diesel	Turbo Intercooled	TD19436
D 0226 MKFO		6cyl.	5687cc	100-125kW (136-170PS)	Diesel	Turbo Intercooled	TD23124
D 0226 MKH		6cyl.	5687cc	125-154kW (170-209PS)	Diesel	Turbo Intercooled	TD19078
D 0226 ML		6cyl.	5687cc	125-154kW (170-209PS)	Diesel	Turbo Intercooled	TD19437
D 0226 MLE		6cyl.	5687cc	125-154kW (170-209PS)	Diesel	Turbo Intercooled	TD19438
D 0226 MT		6cyl.	5687cc	110-135kW (150-184PS)	Diesel	Turbo	TD19439
D 0226 MTE Euro 3		6cyl.	5687cc	81-135kW (110-184PS)	Diesel	Turbo	TD19071
D 0226 MTKE		6cyl.	5687cc	81kW (110PS)	Diesel	Turbo	FM5418
08-283300-00	STD	102.00	3.000		008 CR P		IKA
[R66550]			2.500		026 P		STD
			4.000		231 CR P		STD

3

D 0824 GF		4cyl.	4580cc	75kW (102PS)	Diesel		TD5648
D 0824 GF01		4cyl.	4580cc	75kW (102PS)	Diesel		TD5988
D 0824 GF02 Euro 1		4cyl.	4580cc	75kW (102PS)	Diesel		TD7639
D 0826 F01		6cyl.	6871cc	110-114kW (150-155PS)	Diesel		TD7681
D 0826 F02		6cyl.	6871cc	110kW (150PS)	Diesel		TD7682
D 0826 FO 01		6cyl.	6871cc	114kW (155PS)	Diesel		TD23134
D 0826 FO 02		6cyl.	6871cc	110kW (150PS)	Diesel		TD23135
D 0826 GF		6cyl.	6871cc	110-114kW (150-155PS)	Diesel	Turbo	TD7647
D 0826 GF01 Euro 1		6cyl.	6871cc	110-114kW (150-155PS)	Diesel		TD7649
D 0826 GF02		6cyl.	6871cc	169kW (230PS)	Diesel		TD22328
D 0826 GF03		6cyl.	6871cc	110kW (150PS)	Diesel		TD7648
D 0826 GF04 Euro 1		6cyl.	6871cc	110-114kW (150-155PS)	Diesel		TD19440
D 0826 GFA		6cyl.	6871cc	114kW (155PS)	Diesel		TD23139





D 0826 GFA 03		6cyl.	6871cc	110kW (150PS)	Diesel	TD23142
D 0826 GFA 04 Euro 1		6cyl.	6871cc	107kW (146PS)	Diesel	TD23143
D 0826 OH01		6cyl.	6871cc	114kW (155PS)	Diesel	TD23157
D 0826 OH02		6cyl.	6871cc	110-114kW (150-155PS)	Diesel	TD7599
D 0826 OH03 Euro 1		6cyl.	6871cc	107kW (146PS)	Diesel	TD23158
08-285800-00	STD	108.00	2.500		001 CR P	IKA
[R66560]			2.500		005 P	STD
			4.000		231 CR P	STD

4

D 0824 LF01 Euro 1	4cyl.	4580cc	114kW (155PS)	Diesel	Turbo Intercooled	TD7680
D 0824 LF02 Euro 2	4cyl.	4580cc	118kW (160PS)	Diesel	Turbo Intercooled	TD7683
D 0824 LF03 Euro 1	4cyl.	4580cc	118kW (160PS)	Diesel	Turbo Intercooled	TD21278
D 0824 LF04 Euro 1	4cyl.	4580cc	118kW (160PS)	Diesel	Turbo Intercooled	TD21279
D 0824 LF05 Euro 1	4cyl.	4580cc	118kW (160PS)	Diesel	Turbo Intercooled	TD21280
D 0824 LF06 Euro 1	4cyl.	4580cc	118kW (160PS)	Diesel	Turbo Intercooled	TD21281
D 0824 LF07 Euro 1	4cyl.	4580cc	118kW (160PS)	Diesel	Turbo Intercooled	TD21282
D 0824 LF08 Euro 1	4cyl.	4580cc	118kW (160PS)	Diesel	Turbo Intercooled	TD21283
D 0824 LF09 Euro 1	4cyl.	4580cc	118kW (160PS)	Diesel	Turbo Intercooled	TD21284
D 0824 LF10 Euro 1	4cyl.	4580cc	118kW (160PS)	Diesel	Turbo Intercooled	TD21285
D 0824 LFL01 Euro 1	4cyl.	4580cc	114kW (155PS)	Diesel	Turbo Intercooled	TD7658
D 0824 LFL02 Euro 2	4cyl.	4580cc	118kW (160PS)	Diesel	Turbo Intercooled	TD7660
D 0824 LFL04 Euro 2	4cyl.	4580cc	81kW (110PS)	Diesel	Turbo Intercooled	TD7656
D 0824 LFL05 Euro 1	4cyl.	4580cc	114kW (155PS)	Diesel	Turbo Intercooled	TD7659
D 0824 LFL06 Euro 2	4cyl.	4580cc	114kW (155PS)	Diesel	Turbo Intercooled	TD7661
D 0824 LFL07 Euro 2	4cyl.	4580cc	104kW (141PS)	Diesel	Turbo Intercooled	TD7662
D 0824 LFL08 Euro 2	4cyl.	4580cc	83kW (113PS)	Diesel	Turbo Intercooled	TD16523
D 0824 LFL09 Euro 1	4cyl.	4580cc	114kW (155PS)	Diesel	Turbo Intercooled	TD9707
D 0824 LFL10 Euro 2	4cyl.	4580cc	92-162kW (125-220PS)	Diesel	Turbo Intercooled	TD21286
D 0824 LOH01 Euro 1	4cyl.	4580cc	114kW (155PS)	Diesel	Turbo Intercooled	TD7598
D 0824 LOH02 Euro 1	4cyl.	4580cc	114kW (155PS)	Diesel	Turbo Intercooled	TD21288
D 0824 LOH03 Euro 1	4cyl.	4580cc	114kW (155PS)	Diesel	Turbo Intercooled	TD21289
D 0824 LOH04 Euro 1	4cyl.	4580cc	114kW (155PS)	Diesel	Turbo Intercooled	TD21290
D 0824 LOH05 Euro 2	4cyl.	4580cc	114kW (155PS)	Diesel	Turbo Intercooled	TD20537
D 0826 FG001	6cyl.	6871cc	169kW (230PS)	Diesel		TD22324
D 0826 FG002	6cyl.	6871cc	169kW (230PS)	Diesel		TD22326
D 0826 LE 521	6cyl.	6871cc	140kW (190PS)	Diesel	Turbo Intercooled	TD22331
D 0826 LE 522 Euro 1	6cyl.	6871cc	154kW (210PS)	Diesel	Turbo Intercooled	TD23144
D 0826 LE 523 Euro 1	6cyl.	6871cc	169kW (230PS)	Diesel	Turbo Intercooled	TD23146
D 0826 LE 524 Euro 1	6cyl.	6871cc	125kW (170PS)	Diesel	Turbo Intercooled	TD23147
D 0826 LE 530 Euro 1	6cyl.	6871cc	147kW (200PS)	Diesel	Turbo Intercooled	TD23149
D 0826 LE 531 Euro 1	6cyl.	6871cc	191kW (260PS)	Diesel	Turbo Intercooled	TD23150
D 0826 LF/217/Silent	6cyl.	6870cc	160kW (218PS)	Diesel	Turbo Intercooled	TD7723
D 0826 LF01	6cyl.	6871cc	140kW (190PS)	Diesel	Turbo Intercooled	TD7686













D 0826 LF02 Euro 1	6cyl.	6871cc	169kW (230PS)	Diesel	Turbo Intercooled	TD7691
D 0826 LF04 Euro 1	6cyl.	6871cc	198kW (270PS)	Diesel	Turbo Intercooled	TD7695
D 0826 LF05	6cyl.	6871cc	140kW (190PS)	Diesel	Turbo Intercooled	TD7687
D 0826 LF06	6cyl.	6871cc	169kW (230PS)	Diesel	Turbo Intercooled	TD7692
D 0826 LF07 Euro 1	6cyl.	6871cc	140kW (190PS)	Diesel	Turbo Intercooled	TD7688
D 0826 LF08 Euro 1	6cyl.	6871cc	169kW (230PS)	Diesel	Turbo Intercooled	TD7693
D 0826 LF11 Euro 2	6cyl.	6871cc	162kW (220PS)	Diesel	Turbo Intercooled	TD7690
D 0826 LF12 Euro 2	6cyl.	6871cc	140kW (190PS)	Diesel	Turbo Intercooled	TD22337
D 0826 LF13 Euro 2	6cyl.	6871cc	191kW (260PS)	Diesel	Turbo Intercooled	TD7694
D 0826 LF15 Euro 2	6cyl.	6871cc	162kW (220PS)	Diesel	Turbo Intercooled	TD7726
D 0826 LF17 Euro 2	6cyl.	6871cc	191kW (260PS)	Diesel	Turbo Intercooled	TD7727
D 0826 LF18 Euro 2	6cyl.	6871cc	162kW (220PS)	Diesel	Turbo Intercooled	TD10227
D 0826 LFL Euro 1	6cyl.	6871cc	162kW (220PS)	Diesel	Turbo Intercooled	TD19443
D 0826 LFL02 Euro 1	6cyl.	6871cc	169kW (230PS)	Diesel	Turbo Intercooled	TD7664
D 0826 LFL03 Euro 1	6cyl.	6871cc	162kW (220PS)	Diesel	Turbo Intercooled	TD7663
D 0826 LFL05 Euro 1	6cyl.	6871cc	114kW (155PS)	Diesel	Turbo Intercooled	TD21291
D 0826 LFL06 Euro 1	6cyl.	6871cc	162kW (220PS)	Diesel	Turbo Intercooled	TD7665
D 0826 LFL07 Euro 1	6cyl.	6871cc	188kW (256PS)	Diesel	Turbo Intercooled	TD21292
D 0826 LFL08 Euro 1	6cyl.	6871cc	162kW (220PS)	Diesel	Turbo Intercooled	TD21293
D 0826 LFL09 Euro 2	6cyl.	6871cc	191kW (260PS)	Diesel	Turbo Intercooled	TD7725
D 0826 LFL10 Euro 1	6cyl.	6871cc	162kW (220PS)	Diesel	Turbo Intercooled	TD10207
D 0826 LOH04	6cyl.	6871cc	169kW (230PS)	Diesel	Turbo Intercooled	TD16466
D 0826 LOH05	6cyl.	6871cc	169kW (230PS)	Diesel	Turbo Intercooled	TD21295
D 0826 LOH06 Euro 1	6cyl.	6871cc	140kW (190PS)	Diesel	Turbo Intercooled	TD7587
D 0826 LOH07 Euro 1	6cyl.	6871cc	169kW (230PS)	Diesel	Turbo Intercooled	TD16246
D 0826 LOH15 Euro 2	6cyl.	6871cc	162kW (220PS)	Diesel	Turbo Intercooled	TD7588
D 0826 LOH17 Euro 2	6cyl.	6871cc	162kW (220PS)	Diesel	Turbo Intercooled	TD17419
D 0826 LOH18 Euro 2	6cyl.	6871cc	191kW (260PS)	Diesel	Turbo Intercooled	TD17420
D 0826 LUE51 Euro 1	B6cyl.	6870cc	132kW (180PS)	Diesel	Turbo Intercooled	TD19444
D 0826 LUH Euro 1	B6cyl.	6870cc	184kW (250PS)	Diesel	Turbo Intercooled	TD7583
D 0826 LUH01 Euro 1	6cyl.	6871cc	198kW (270PS)	Diesel	Turbo Intercooled	TD7596
D 0826 LUH02 Euro 1	6cyl.	6871cc	169-198kW (230-269PS)	Diesel	Turbo Intercooled	TD21301
D 0826 LUH03 Euro 1	6cyl.	6871cc	157kW (214PS)	Diesel	Turbo Intercooled	TD7584
D 0826 LUH04	6cyl.	6871cc	157-169kW (214-230PS)	Diesel	Turbo Intercooled	TD21302
D 0826 LUH05 Euro 1	6cyl.	6871cc	169kW (230PS)	Diesel	Turbo Intercooled	TD7585
D 0826 LUH06 Euro 1	6cyl.	6871cc	169-198kW (230-269PS)	Diesel	Turbo Intercooled	TD21303
D 0826 LUH08 Euro 2	6cyl.	6871cc	162-169kW (220-230PS)	Diesel	Turbo Intercooled	TD21304
D 0826 LUH09 Euro 2	6cyl.	6871cc	169-206kW (230-280PS)	Diesel	Turbo Intercooled	TD21305
D 0826 LUH10 Euro 1	6cyl.	6871cc	169-198kW (230-269PS)	Diesel	Turbo Intercooled	TD21306
D 0826 LUH11 Euro 2	6cyl.	6871cc	162kW (220PS)	Diesel	Turbo Intercooled	TD21307
D 0826 LUH12 Euro 1	6cyl.	6870cc	162kW (220PS)	Diesel	Turbo Intercooled	TD7586





D 0826 LUH13 Euro 2		6cyl.	6871cc	191kW (260PS)	Diesel	Turbo Intercooled	TD16248
D 0826 OH		6cyl.	6871cc	110kW (150PS)	Diesel		TD19445
08-285900-00	STD	108.00	3.000		008 CR P		IKA
[R45130]			2.500		005 P		STD
			4.000		231 CR P		STD

5

D 0834 LFL01 Euro 3		4cyl.	4580cc	103kW (140PS)	Diesel	Turbo Intercooled	TD17044
D 0834 LFL02 Euro 3		4cyl.	4580cc	103kW (140PS)	Diesel	Turbo Intercooled	TD6591
D 0834 LFL03 Euro 3		4cyl.	4580cc	132kW (180PS)	Diesel	Turbo Intercooled	TD16498
D 0834 LFL04 Euro 3		4cyl.	4580cc	110kW (150PS)	Diesel	Turbo Intercooled	TD18096
D 0834 LFL20 Euro 3		4cyl.	4580cc	125kW (170PS)	Diesel	Turbo Intercooled	TD16829
D 0834 LOH 40 Euro 4		4cyl.	4580cc	132kW (180PS)	Diesel	Turbo Intercooled	TD23680
D 0834 LOH01 Euro 3		4cyl.	4580cc	125kW (170PS)	Diesel	Turbo Intercooled	TD16748
D 0834 LOH02 Euro 3		4cyl.	4580cc	125kW (170PS)	Diesel	Turbo Intercooled	TD16749
D 0834 LOH03 Euro 3		4cyl.	4580cc	125kW (170PS)	Diesel	Turbo Intercooled	TD16750
D 0836 LF01 Euro 2		6cyl.	6871cc	206kW (280PS)	Diesel	Turbo Intercooled	TD14289
D 0836 LF02 Euro 3		6cyl.	6871cc	162kW (220PS)	Diesel	Turbo Intercooled	TD17045
D 0836 LF03 Euro 3		6cyl.	6871cc	206kW (280PS)	Diesel	Turbo Intercooled	TD16503
D 0836 LF04 Euro 3		6cyl.	6871cc	162kW (220PS)	Diesel	Turbo Intercooled	TD16500
D 0836 LF05 Euro 3		6cyl.	6871cc	180kW (245PS)	Diesel	Turbo Intercooled	TD16504
D 0836 LFL01 Euro 2/3		6cyl.	6871cc	206kW (280PS)	Diesel	Turbo Intercooled	TD16875
D 0836 LFL02 Euro 2/3		6cyl.	6871cc	162kW (220PS)	Diesel	Turbo Intercooled	TD16499
D 0836 LFL03 Euro 3		6cyl.	6871cc	206kW (280PS)	Diesel	Turbo Intercooled	TD16502
D 0836 LFL04 Euro 3		6cyl.	6871cc	162kW (220PS)	Diesel	Turbo Intercooled	TD17049
D 0836 LFL05 Euro 3		6cyl.	6871cc	180kW (245PS)	Diesel	Turbo Intercooled	TD16501
D 0836 LFL06 Euro 3		6cyl.	6871cc	162kW (220PS)	Diesel	Turbo Intercooled	TD23163
D 0836 LFL07 Euro 3		6cyl.	6871cc	162kW (220PS)	Diesel	Turbo Intercooled	TD16830
D 0836 LFL10 Euro 3		6cyl.	6871cc	162kW (220PS)	Diesel	Turbo Intercooled	TD16831
D 0836 LOH01 Euro 3		6cyl.	6871cc	206kW (280PS)	Diesel	Turbo Intercooled	TD16753
D 0836 LOH02 Euro 3		6cyl.	6871cc	206kW (280PS)	Diesel	Turbo Intercooled	TD16752
D 0836 LOH03 Euro 3		6cyl.	6871cc	162kW (220PS)	Diesel	Turbo Intercooled	TD16751
08-136500-00	STD	108.00	3.000		008 CK P		IKA
[R67932]			2.500		005 P		STD
			4.000		231 CR P		STD
08-136500-10	STD	108.00	3.000		008 CK P		IKA
01/2003→			2.500		005 P		STD
			3.000		231 CR P		GOE12





6

D 0834 LFL40 Euro 3	4cyl.	4580cc	110kW (150PS)	Diesel	Turbo Intercooled	TD18179
D 0834 LFL41 Euro 3	4cyl.	4580cc	132kW (180PS)	Diesel	Turbo Intercooled	TD18180
D 0834 LFL42 Euro 3	4cyl.	4580cc	151kW (205PS)	Diesel	Turbo Intercooled	TD18181
D 0834 LFL50 Euro 4	4cyl.	4580cc	110kW (150PS)	Diesel	Turbo Intercooled	TD18182
D 0834 LFL51 Euro 4	4cyl.	4580cc	132kW (180PS)	Diesel	Turbo Intercooled	TD18183
D 0834 LFL52 Euro 4	4cyl.	4580cc	151kW (205PS)	Diesel	Turbo Intercooled	TD18184
D 0834 LFL53 Euro 4	4cyl.	4580cc	110kW (150PS)	Diesel	Turbo Intercooled	TD22957
D 0834 LFL54 Euro 4	4cyl.	4580cc	132kW (180PS)	Diesel	Turbo Intercooled	TD22958
D 0834 LFL55 Euro 4	4cyl.	4580cc	151kW (205PS)	Diesel	Turbo Intercooled	TD22969
D 0834 LFL60	4cyl.	4580cc	110kW (150PS)	Diesel	Turbo Intercooled	TD22962
D 0834 LFL61	4cyl.	4580cc	132kW (180PS)	Diesel	Turbo Intercooled	TD22963
D 0834 LFL62	4cyl.	4580cc	162kW (220PS)	Diesel	Turbo Intercooled	TD22965
D 0834 LFL63 Euro 5	4cyl.	4580cc	110kW (150PS)	Diesel	Turbo Intercooled	TD22959
D 0834 LFL64 Euro 5	4cyl.	4580cc	132kW (180PS)	Diesel	Turbo Intercooled	TD22960
D 0834 LFL65 Euro 5	4cyl.	4580cc	162kW (220PS)	Diesel	Turbo Intercooled	TD22961
D 0834 LOH 60	4cyl.	4580cc	132kW (180PS)	Diesel	Turbo Intercooled	TD23669
D 0834 LOH 61 Euro 5	4cyl.	4580cc	132kW (180PS)	Diesel	Turbo Intercooled	TD23679
D 0834 LOH50 Euro 4	4cyl.	4580cc	132kW (180PS)	Diesel	Turbo Intercooled	TD19968
D 0834 LOH51 Euro 4	4cyl.	4580cc	151kW (205PS)	Diesel	Turbo Intercooled	TD19969
D 0834 LOH52 Euro 4	4cyl.	4580cc	132kW (180PS)	Diesel	Turbo Intercooled	TD23057
D 0834 LOH53 Euro 4	4cyl.	4580cc	151kW (205PS)	Diesel	Turbo Intercooled	TD23058
D 0836 LF41 Euro 3	6cyl.	6871cc	206kW (280PS)	Diesel	Turbo Intercooled	TD16827
D 0836 LF44 Euro 3	6cyl.	6871cc	240kW (326PS)	Diesel	Turbo Intercooled	TD16828
D 0836 LFG50 Euro 4/5	6cyl.	6871cc	240kW (326PS)	Diesel	Turbo Intercooled	TD20228
D 0836 LFL 61	6cyl.	6871cc	213kW (290PS)	Diesel	Turbo Intercooled	TD23686
D 0836 LFL 62	6cyl.	6871cc	250kW (340PS)	Diesel	Turbo Intercooled	TD23687
D 0836 LFL 69 Euro 5	6cyl.	6871cc	184kW (250PS)	Diesel	Turbo Intercooled	TD27708
D 0836 LFL 70 Euro 5	6cyl.	6871cc	213kW (290PS)	Diesel	Turbo Intercooled	TD27709
D 0836 LFL 71 Euro 5	6cyl.	6871cc	250kW (340PS)	Diesel	Turbo Intercooled	TD27710
D 0836 LFL40 Euro 3	6cyl.	6871cc	176kW (239PS)	Diesel	Turbo Intercooled	TD18185
D 0836 LFL41 Euro 3	6cyl.	6871cc	206kW (280PS)	Diesel	Turbo Intercooled	TD18703
D 0836 LFL44 Euro 3	6cyl.	6871cc	240kW (326PS)	Diesel	Turbo Intercooled	TD18704
D 0836 LFL50 Euro 4	6cyl.	6871cc	176kW (239PS)	Diesel	Turbo Intercooled	TD18186
D 0836 LFL51 Euro 4	6cyl.	6871cc	206kW (280PS)	Diesel	Turbo Intercooled	TD19114
D 0836 LFL52 Euro 4	6cyl.	6871cc	177kW (240PS)	Diesel	Turbo Intercooled	TD19113
D 0836 LFL53 Euro 4	6cyl.	6871cc	176kW (239PS)	Diesel	Turbo Intercooled	TD22970
D 0836 LFL54 Euro 4	6cyl.	6871cc	206kW (280PS)	Diesel	Turbo Intercooled	TD22971
D 0836 LFL55 Euro 4	6cyl.	6871cc	240kW (326PS)	Diesel	Turbo Intercooled	TD22972
D 0836 LFL63 Euro 5	6cyl.	6871cc	184kW (250PS)	Diesel	Turbo Intercooled	TD22967
D 0836 LFL64 Euro 5	6cyl.	6871cc	213kW (290PS)	Diesel	Turbo Intercooled	TD22984
D 0836 LFL65 Euro 5	6cyl.	6871cc	250kW (340PS)	Diesel	Turbo Intercooled	TD22995
D 0836 LOH40 Euro 3	6cyl.	6871cc	206kW (280PS)	Diesel	Turbo Intercooled	TD16754
D 0836 LOH41 Euro 3	6cyl.	6871cc	177kW (240PS)	Diesel	Turbo Intercooled	TD16755
D 0836 LOH51 Euro 4	6cyl.	6871cc	206kW (280PS)	Diesel	Turbo Intercooled	TD19971
D 0836 LOH52 Euro 4	6cyl.	6871cc	177kW (240PS)	Diesel	Turbo Intercooled	TD19970





D 0836 LOH55 Euro 4	6cyl.	6871cc	206kW (280PS)	Diesel	Turbo Intercooled	TD23060
D 0836 LOH56 Euro 4	6cyl.	6871cc	177kW (240PS)	Diesel	Turbo Intercooled	TD23059
D 0836 LOH60	6cyl.	6871cc	213kW (290PS)	Diesel	Turbo Intercooled	TD23671
D 0836 LOH61	6cyl.	6871cc	184kW (250PS)	Diesel	Turbo Intercooled	TD23670
D 0836 LOH62 Euro 4	6cyl.	6871cc	191kW (260PS)	Diesel	Turbo Intercooled	TD23164
D 0836 LOH63	6cyl.	6871cc	191kW (260PS)	Diesel	Turbo Intercooled	TD23962
D 0836 LOH64 Euro 5	6cyl.	6871cc	213kW (290PS)	Diesel	Turbo Intercooled	TD23682
D 0836 LOH65 Euro 5	6cyl.	6871cc	184kW (250PS)	Diesel	Turbo Intercooled	TD23681
D 0836 LUH01 Euro 3	6cyl.	6871cc	206kW (280PS)	Diesel	Turbo Intercooled	TD16756
D 0836 LUH02 Euro 3	6cyl.	6871cc	162kW (220PS)	Diesel	Turbo Intercooled	TD16757
D 0836 LUH40 Euro 3	6cyl.	6871cc	206kW (280PS)	Diesel	Turbo Intercooled	TD16758
D 0836 LUH41 Euro 3	6cyl.	6871cc	177kW (240PS)	Diesel	Turbo Intercooled	TD16759

08-136500-30	STD	108.00	3.000		008 CK P	KV1
			2.500		005 P	F12/F14
			3.000		231 CR P	G0E12

7

D 0836 HM3U	6cyl.	7030cc	110kW (150PS)	Diesel		TD7824
D 0836 HM4	6cyl.	7030cc	110-115kW (150-156PS)	Diesel		TD5652
D 0836 HM5U	6cyl.	7030cc	110kW (150PS)	Diesel		TD8761
D 0836 HM7	6cyl.	7030cc	114-117kW (156-160PS)	Diesel		TD5990
D 0836 HM70	6cyl.	7030cc	110-114kW (150-156PS)	Diesel		TD6268
D 0836 HM71	6cyl.	7030cc	114kW (155PS)	Diesel		TD7668
D 0836 HM7U	6cyl.	7030cc	117kW (159PS)	Diesel		TD7825
D 0836 HM8U	6cyl.	7030cc	117kW (159PS)	Diesel		TD8762
D 0836 HM9H	6cyl.	7030cc	117kW (159PS)	Diesel		TD7817
D 0836 HM9U	6cyl.	7030cc	117kW (159PS)	Diesel		TD7821
D 0836 HMN70	6cyl.	7030cc	114kW (155PS)	Diesel		TD7650
D 0836 M2	6cyl.	7030cc	99kW (135PS)	Diesel		TD7644
D 0836 M2A	6cyl.	7030cc	99kW (135PS)	Diesel		TD7819
D 0836 M2U	6cyl.	7030cc	99kW (135PS)	Diesel		TD7820
D 0836 M3H	6cyl.	7030cc	99kW (135PS)	Diesel		TD7816
D 0846 HM2	6cyl.	7250cc	117kW (159PS)	Diesel		TD7654
D 0846 HM42U	6cyl.	7252cc	117kW (159PS)	Diesel		TD8656
D 0846 HM81H	6cyl.	7252cc	117kW (159PS)	Diesel		TD8741
D 0846 HM82U	6cyl.	7252cc	117kW (159PS)	Diesel		TD8745
D 0846 HM91H	6cyl.	7252cc	117kW (159PS)	Diesel		TD7818
D 0846 HM91U	6cyl.	7250cc	117kW (159PS)	Diesel		TD7822
D 0846 HM95U	6cyl.	7252cc	117kW (159PS)	Diesel		TD7827
D 0846 HMN	6cyl.	7252cc	117kW (159PS)	Diesel		TD7651
D 0846 HMN2	6cyl.	7252cc	117kW (159PS)	Diesel		TD19037
D 0846 HMN80	6cyl.	7252cc	132kW (180PS)	Diesel		TD8779
D 0846 HMX-011	6cyl.	7250cc	117kW (159PS)	Diesel		TD8781
D 0846 HMXU-015	6cyl.	7250cc	117kW (159PS)	Diesel		TD7627





D 0846 HMY-011		6cyl.	7250cc	123kW (167PS)	Diesel	TD7707
D 0846 HMYH		6cyl.	7252cc	123kW (167PS)	Diesel	TD7168
D 0846 HMYN-014		6cyl.	7252cc	123kW (167PS)	Diesel	TD7702
08-274100-10 01/1967→	STD	108.00	3.000		001 CR P	IKA
			2.500		001 IF P	STD
			2.500		026 P	STD
08-275000-10 01/1963→	STD	108.00	5.000		231	STD
			2.500		001 CR P	IKA
			2.500		023 P	STD
08-280000-10 01/1973→	STD	108.00	5.000		231	STD
			2.500		001 CR P	IKA
			2.500		005 P	STD
			5.000		231 CR P	STD

8

E 0824 E 301		4cyl.	4580cc	47-58kW (64-79PS)		TD25680
E 0826 E 301		6cyl.	6596cc	70-88kW (95-120PS)		TD25681
E 0834 E 302		4cyl.	4580cc	54-62kW (73-84PS)		TD25700
E 0834 E 312		4cyl.	4580cc	37-53kW (50-72PS)		TD25699
E 0836 E 302		6cyl.	6871cc	75kW (102PS)		TD23749
E 0836 E 312		6cyl.	6871cc	56-64kW (76-87PS)		TD23748
08-429100-00	STD	108.00	2.500		001 CK P	KV4
			2.500		005 P	STD
			4.000		231 CR P	STD

9

E 0836 LE 202		6cyl.	6871cc	110kW (150PS)	Turbo Intercooled	TD23747
08-425900-00	STD	108.00	3.000		008 CK P	IKA
			2.500		005 CK P	GOE13
			3.000		231 CR P	GOE13
08-431600-00	STD	108.00	3.000		008 CK P	IKA
			2.500		005 CR P	STD
			4.000		031 CR P	KV1



10

D 1146		6cyl.	8072cc	98kW (133PS)	Diesel		FM5936
08-961700-00 01/1969→	STD	111.00	3.500		008 CR P		IKA
			3.000		005 P		STD
			4.000		231 CR P		STD

11

D 1246		6cyl.			Diesel		FM6161
MV3A		6cyl.			Diesel		FM6162
08-285500-00 08-285505-00	STD 0.25mm	112.00	2.500		001 CR P		IKA
			2.500		005 P		STD
			2.500		023 P		STD
			5.500		031 P		STD



12

D 2066 LF Euro 2/3		6cyl.	10518cc	265-307kW (360-430PS)	Diesel	Turbo Intercooled	FM16161
D 2066 LF Euro 3		6cyl.	10518cc		Diesel	Turbo Intercooled	FM46161
D 2066 LF01 Euro 4		6cyl.	10520cc	316kW (430PS)	Diesel	Turbo Intercooled	TD17370
D 2066 LF02 Euro 4		6cyl.	10520cc	287kW (390PS)	Diesel	Turbo Intercooled	TD17371
D 2066 LF03 Euro 4		6cyl.	10520cc	257kW (350PS)	Diesel	Turbo Intercooled	TD17372
D 2066 LF04 Euro 4		6cyl.	10520cc	228kW (310PS)	Diesel	Turbo Intercooled	TD17373
D 2066 LF06 Euro 3		6cyl.	10520cc	228-287kW (310-390PS)	Diesel	Turbo Intercooled	FM26161
D 2066 LF06 Euro 4		6cyl.	10520cc	294kW (400PS)	Diesel	Turbo Intercooled	TD19951
D 2066 LF07 Euro 3		6cyl.	10518cc	265kW (360PS)	Diesel	Turbo Intercooled	TD22899
D 2066 LF11 Euro 4		6cyl.	10520cc	316kW (430PS)	Diesel	Turbo Intercooled	TD18098
D 2066 LF12 Euro 4		6cyl.	10520cc	287kW (390PS)	Diesel	Turbo Intercooled	TD18097
D 2066 LF13 Euro 4		6cyl.	10520cc	257kW (350PS)	Diesel	Turbo Intercooled	TD19111
D 2066 LF14 Euro 4		6cyl.	10520cc	228kW (310PS)	Diesel	Turbo Intercooled	TD19109
D 2066 LF28 Euro 4		6cyl.	10520cc	235kW (320PS)	Diesel	Turbo Intercooled	TD20366
D 2066 LF29 Euro 4 (D20)		6cyl.	10520cc	265kW (360PS)	Diesel	Turbo Intercooled	TD25603
D 2066 LF31 Euro 4		6cyl.	10520cc	324kW (440PS)	Diesel	Turbo Intercooled	TD19094
D 2066 LF32 Euro 4		6cyl.	10520cc	294kW (400PS)	Diesel	Turbo Intercooled	TD19095
D 2066 LF33 Euro 4		6cyl.	10520cc	265kW (360PS)	Diesel	Turbo Intercooled	TD19096
D 2066 LF35 Euro 4		6cyl.	10520cc	235kW (320PS)	Diesel	Turbo Intercooled	TD19097
D 2066 LF36 Euro 4		6cyl.	10520cc	324kW (440PS)	Diesel	Turbo Intercooled	TD20368
D 2066 LF37 Euro 4		6cyl.	10520cc	294kW (400PS)	Diesel	Turbo Intercooled	TD20369
D 2066 LF38 Euro 4		6cyl.	10520cc	265kW (360PS)	Diesel	Turbo Intercooled	TD20370
D 2066 LF39 Euro 4		6cyl.	10520cc	235kW (320PS)	Diesel	Turbo Intercooled	TD20396
D 2066 LF48 Euro 3		6cyl.	10518cc	265kW (360PS)	Diesel	Turbo Intercooled	TD25598
D 2066 LF49 Euro 3		6cyl.	10518cc	294kW (400PS)	Diesel	Turbo Intercooled	TD25599
D 2066 LF50 Euro 3		6cyl.	10518cc	324kW (440PS)	Diesel	Turbo Intercooled	TD25600
D 2066 LOH01 Euro 4		6cyl.	10520cc	235kW (320PS)	Diesel	Turbo Intercooled	TD19972
D 2066 LOH02 Euro 4		6cyl.	10520cc	265kW (360PS)	Diesel	Turbo Intercooled	TD19973





D 2066 LOH03 Euro 4	6cyl.	10520cc	294kW (400PS)	Diesel	Turbo Intercooled	TD19974
D 2066 LOH04 Euro 4	6cyl.	10520cc	324kW (440PS)	Diesel	Turbo Intercooled	TD19975
D 2066 LOH05 Euro 4	6cyl.	10520cc	225kW (306PS)	Diesel	Turbo Intercooled	TD23061
D 2066 LOH06 Euro 4	6cyl.	10520cc	265kW (360PS)	Diesel	Turbo Intercooled	TD23062
D 2066 LOH07 Euro 4	6cyl.	10520cc	294kW (400PS)	Diesel	Turbo Intercooled	TD23063
D 2066 LOH08 Euro 4	6cyl.	10520cc	324kW (440PS)	Diesel	Turbo Intercooled	TD23064
D 2066 LOH10 Euro 3	6cyl.	10518cc	316kW (430PS)	Diesel	Turbo Intercooled	TD23073
D 2066 LOH11 Euro 3	6cyl.	10518cc	287kW (390PS)	Diesel	Turbo Intercooled	TD23072
D 2066 LOH12 Euro 3	6cyl.	10518cc	257kW (350PS)	Diesel	Turbo Intercooled	TD23070
D 2066 LUH07 Euro 3	6cyl.	10520cc	228kW (310PS)	Diesel	Turbo Intercooled	TD23074
D 2066 LUH08 Euro 3	6cyl.	10520cc	257kW (350PS)	Diesel	Turbo Intercooled	TD23075
D 2066 LUH09 Euro 3	6cyl.	10520cc	287kW (390PS)	Diesel	Turbo Intercooled	TD23076
D 2066 LUH11 Euro 4	6cyl.	10520cc	199kW (271PS)	Diesel	Turbo Intercooled	TD19976
D 2066 LUH12 Euro 4	6cyl.	10520cc	228kW (310PS)	Diesel	Turbo Intercooled	TD19977
D 2066 LUH13 Euro 4	6cyl.	10520cc	257kW (350PS)	Diesel	Turbo Intercooled	TD19978
D 2066 LUH14 Euro 4	6cyl.	10520cc	287kW (390PS)	Diesel	Turbo Intercooled	TD19979
D 2066 LUH15 Euro 4	6cyl.	10520cc	316kW (430PS)	Diesel	Turbo Intercooled	TD19980
D 2066 LUH21 Euro 4	6cyl.	10520cc	199kW (271PS)	Diesel	Turbo Intercooled	TD22860
D 2066 LUH22 Euro 4	6cyl.	10520cc	228kW (310PS)	Diesel	Turbo Intercooled	TD23065
D 2066 LUH23 Euro 4	6cyl.	10520cc	257kW (350PS)	Diesel	Turbo Intercooled	TD23066
D 2066 LUH24 Euro 4	6cyl.	10520cc	287kW (390PS)	Diesel	Turbo Intercooled	TD23067

08-423000-00	STD	120.00	3.500		008 CK P	KV1
			3.000		005 CR P	GOE12
			4.000		231 CR P	GOE12

13

D 2066 LF17 Euro 5	6cyl.	10518cc	324kW (440PS)	Diesel	Turbo Intercooled	TD23081
D 2066 LF18 Euro 5	6cyl.	10518cc	294kW (400PS)	Diesel	Turbo Intercooled	TD23083
D 2066 LF19 Euro 5	6cyl.	10518cc	265kW (360PS)	Diesel	Turbo Intercooled	TD23084
D 2066 LF20 Euro 5	6cyl.	10518cc	235kW (320PS)	Diesel	Turbo Intercooled	TD23085
D 2066 LF21 Euro 5	6cyl.	10518cc	321kW (437PS)	Diesel	Turbo Intercooled	TD20230
D 2066 LF22 Euro 5	6cyl.	10518cc	294kW (400PS)	Diesel	Turbo Intercooled	TD20229
D 2066 LF23 Euro 5	6cyl.	10518cc	324kW (440PS)	Diesel	Turbo Intercooled	TD19098
D 2066 LF24 Euro 5	6cyl.	10518cc	294kW (400PS)	Diesel	Turbo Intercooled	TD19099
D 2066 LF25 Euro 5	6cyl.	10518cc	324kW (440PS)	Diesel	Turbo Intercooled	TD20363
D 2066 LF26 Euro 5	6cyl.	10518cc	294kW (400PS)	Diesel	Turbo Intercooled	TD20364
D 2066 LF27 Euro 5	6cyl.	10518cc	265kW (360PS)	Diesel	Turbo Intercooled	TD20365
D 2066 LF40 Euro 5	6cyl.	10518cc	324kW (440PS)	Diesel	Turbo Intercooled	TD23119
D 2066 LF41 Euro 5	6cyl.	10518cc	294kW (400PS)	Diesel	Turbo Intercooled	TD23104
D 2066 LF42 Euro 5	6cyl.	10518cc	265kW (360PS)	Diesel	Turbo Intercooled	TD23094
D 2066 LF43 Euro 5	6cyl.	10518cc	235kW (320PS)	Diesel	Turbo Intercooled	TD23003
D 2066 LF44 Euro 5	6cyl.	10518cc	324kW (440PS)	Diesel	Turbo Intercooled	TD25456
D 2066 LF45 Euro 5	6cyl.	10518cc	294kW (400PS)	Diesel	Turbo Intercooled	TD25455
D 2066 LF46 Euro 5	6cyl.	10518cc	265kW (360PS)	Diesel	Turbo Intercooled	TD25454





D 2066 LF47 Euro 5		6cyl.	10518cc	235kW (320PS)	Diesel	Turbo Intercooled	TD25453
D 2066 LF51 Euro 5		6cyl.	10518cc	294kW (400PS)	Diesel	Turbo Intercooled	TD23436
D 2066 LF52 Euro 5		6cyl.	10518cc	265kW (360PS)	Diesel	Turbo Intercooled	TD23437
D 2066 LF53 Euro 5		6cyl.	10518cc	235kW (320PS)	Diesel	Turbo Intercooled	TD23438
D 2066 LOH28 Euro 5		6cyl.	10518cc	294kW (400PS)	Diesel	Turbo Intercooled	TD23396
D 2066 LUH 32 Euro 5		6cyl.	10518cc	235kW (320PS)	Diesel	Turbo Intercooled	TD23683
D 2066 LUH 33 Euro 5		6cyl.	10518cc	265kW (360PS)	Diesel	Turbo Intercooled	TD23684
D 2066 LUH 34 Euro 5		6cyl.	10518cc	294kW (400PS)	Diesel	Turbo Intercooled	TD23685
08-428600-00	STD	120.00	3.500		008 CK P		KV4
			3.000		005 CR P		GOE13
			4.000		231 CR P		GOE13

14

D 2146		6cyl.	9660cc	123kW (167PS)	Diesel	TD7666
08-274200-10	STD	121.00	3.500		001 CR P	IKA
			3.000		001 IF P	STD
			3.000		023 P	STD
			5.500		231 CR P	STD
08-274800-10	STD	121.00	3.500		008 CR P	IKA
[R45910]			3.000		005 IF P	STD
			3.000		023 P	STD
			5.500		231 CR P	STD

15

D 2156 HM 2		6cyl.	10344cc	141-173kW (192-235PS)	Diesel	TD23165	
D 2156 HM3		6cyl.	10344cc	158-169kW (215-230PS)	Diesel	TD7675	
D 2156 HM9		6cyl.	10344cc	158-169kW (215-230PS)	Diesel	TD7734	
D 2156 HMN1		6cyl.	10344cc	158kW (215PS)	Diesel	TD7700	
D 2156 HMN6		6cyl.	10344cc	172kW (234PS)	Diesel	TD8783	
D 2156 HNY		6cyl.	10344cc	141-169kW (192-230PS)	Diesel	TD19066	
D 2156 MGN		6cyl.	10344cc	141-169kW (192-230PS)	Diesel	TD19067	
D 2156 MNY		6cyl.	10344cc	141-169kW (192-230PS)	Diesel	TD19068	
D 2156 MTN1		6cyl.	10344cc	188kW (256PS)	Diesel	Turbo Intercooled	TD7715
D 2156 MTX		6cyl.	10344cc	188kW (256PS)	Diesel	Turbo	TD19116





D 2156 MY		6cyl.	10344cc	141-169kW (192-230PS)	Diesel	TD19069
D 2156 MYN		6cyl.	10344cc	141-169kW (192-230PS)	Diesel	TD19070
08-274800-10 [R45910]	STD	121.00	3.500		008 CR P	IKA
			3.000		005 IF P	STD
			3.000		023 P	STD
			5.500		231 CR P	STD

16

D 2356, D 2366		6cyl.	10690cc	169kW (230PS)	Diesel	FM6430
08-961600-00	STD	123.00	3.500		008 CR P	IKA
			3.000		005 P	STD
			4.000		231 CR P	STD

17

D 2530 MF		V10cyl.	15945cc	235kW (320PS)	Diesel	TD5650
D 2530 MXF		V10cyl.	15945cc	156-235kW (212-320PS)	Diesel	TD19038
D 2538 M		V8cyl.	12763cc	188kW (256PS)	Diesel	TD7743
D 2538 ME		V8cyl.	12763cc	188kW (256PS)	Diesel	TD19447
D 2538 MF		V8cyl.	12763cc	188kW (256PS)	Diesel	TD7737
D 2542 ME		V12cyl.	20911cc		Diesel	FM6603
08-279200-10	STD	125.00	3.000		001 MO P	IKA
			3.000		005 IF P	STD
			5.000		231 CR P	



18

D 2540 MT		V10cyl.	17426cc	287kW (390PS)	Diesel Turbo	TD19448
D 2540 MTF		V10cyl.	17426cc	324kW (440PS)	Diesel Turbo	TD7814
D 2542 MTE		V12cyl.	20911cc	283kW (385PS)	Diesel Turbo	TD19450
D 2548		V8cyl.	12756cc	235kW (320PS)	Diesel	FM5943
08-282400-10	STD	125.00	3.500		008 CR	IKA
			3.000		005 IF P	STD
			3.000		026 P	STD
			5.000		231 CR P	STD



19

D 2555 M	5cyl.	9200cc	123kW (167PS)	Diesel	TD7708
D 2555 MF	5cyl.	9200cc	123kW (167PS)	Diesel	TD7703
D 2555 MX	5cyl.	9200cc	141kW (192PS)	Diesel	TD7710
D 2556 M	6cyl.	11045cc	147kW (200PS)	Diesel	TD7730
D 2556 MX	6cyl.	11045cc	147-194kW (200-264PS)	Diesel	TD7733
D 2556 MXF	6cyl.	11045cc	172-177kW (232-240PS)	Diesel	TD7731
D 2565 HM	5cyl.	9510cc	92kW (125PS)	Diesel	TD19039
D 2565 M	5cyl.	9510cc	141kW (192PS)	Diesel	TD7711
D 2565 M/168	5cyl.	9510cc	123kW (167PS)	Diesel	TD7709
D 2565 ME	5cyl.	9510cc	84kW (114PS)	Diesel	TD19040
D 2565 MF	5cyl.	9510cc	141kW (192PS)	Diesel	TD7706
D 2565 MF/168	5cyl.	9510cc	123kW (168PS)	Diesel	TD7704
D 2565 MFR	5cyl.	9510cc	92kW (125PS)	Diesel	TD19041
D 2565 MR	5cyl.	9510cc	141kW (192PS)	Diesel	TD23168
D 2565 MUE	5cyl.	9510cc	141kW (192PS)	Diesel	TD23169
D 2565 MUH	5cyl.	9510cc	92kW (125PS)	Diesel	TD19042
D 2565 MUL	5cyl.	9510cc	141kW (192PS)	Diesel	TD7721
D 2566 M	6cyl.	11413cc	177kW (240PS)	Diesel	TD7735
D 2566 ME	6cyl.	11413cc	125kW (170PS)	Diesel	TD19451
D 2566 MF	6cyl.	11413cc	177kW (240PS)	Diesel	TD7732
D 2566 MH	6cyl.	11413cc	177kW (240PS)	Diesel	TD7414
D 2566 MUE	6cyl.	11413cc	125kW (170PS)	Diesel	TD19452
D 2566 MUH	6cyl.	11413cc	177kW (240PS)	Diesel Turbo	TD7407
D 2566 MUL	6cyl.	11413cc	177kW (240PS)	Diesel	TD7803
D 2566 MUM	6cyl.	11413cc	147-177kW (200-241PS)	Diesel	TD7440
D 2566 MXF	6cyl.	11413cc	125kW (170PS)	Diesel	TD19043

08-280200-00	STD	125.00	3.000		008 CR P	IKA
			3.000		005 IF P	STD
			5.000		231 CR P	STD



20



D 2565 MK	5cyl.	9510cc	169kW (230PS)	Diesel	Turbo	TD19117
D 2565 MKUL	5cyl.	9510cc	169kW (230PS)	Diesel	Turbo	TD19072
D 2565 MT	5cyl.	9510cc	169kW (230PS)	Diesel	Turbo	TD19073
D 2566 MK	6cyl.	11413cc	235kW (320PS)	Diesel	Turbo	TD7801
D 2566 MKF	6cyl.	11413cc	235kW (320PS)	Diesel	Turbo Intercooled	TD7758
D 2566 MKUH/320	6cyl.	11413cc	235kW (320PS)	Diesel	Turbo Intercooled	TD7633
D 2566 MKUL	6cyl.	11413cc	235kW (320PS)	Diesel	Turbo Intercooled	TD7804
D 2566 MLUH	6cyl.	11413cc	192kW (261PS)	Diesel	Turbo Intercooled	TD7632
D 2566 MLUM	6cyl.	11413cc	227kW (310PS)	Diesel	Turbo Intercooled	TD7625
D 2566 MT	6cyl.	11413cc	206kW (280PS)	Diesel	Turbo	TD7799
D 2566 MTE	6cyl.	11413cc	162kW (220PS)	Diesel	Turbo	TD19074
D 2566 MTF	6cyl.	11413cc	206kW (280PS)	Diesel	Turbo	TD7738
D 2566 MTH	6cyl.	11413cc	213kW (290PS)	Diesel	Turbo	TD7418
D 2566 MTHO	6cyl.	11413cc	206-235kW (280-320PS)	Diesel	Turbo	TD7744
D 2566 MTUH/280	6cyl.	11413cc	206kW (280PS)	Diesel	Turbo	TD7603
D 2566 UH	6cyl.	11413cc	155kW (211PS)	Diesel		TD7616
08-280400-10	STD	125.00	3.500		008 CR P	KV1
			3.000		026 P	STD
			5.000		231 CR P	STD

21

D 2676 LF01 Euro 4	6cyl.	12418cc	353kW (480PS)	Diesel		TD19100
D 2676 LF05 Euro 4	6cyl.	12412cc	353kW (480PS)	Diesel		TD20371
D 2676 LF13 Euro 5	6cyl.	12412cc	397kW (540PS)	Diesel	Turbo Intercooled	TD20372
D 2676 LF14 Euro 5	6cyl.	12412cc	353kW (480PS)	Diesel	Turbo Intercooled	TD20373
D 2676 LF15 Euro 5	6cyl.	12412cc	397kW (540PS)	Diesel	Turbo Intercooled	TD23087
D 2676 LF16 Euro 5	6cyl.	12412cc	353kW (480PS)	Diesel	Turbo Intercooled	TD23088
D 2676 LOH01 Euro 4	6cyl.	12418cc	338kW (460PS)	Diesel	Turbo Intercooled	TD19102
D 2676 LOH02 Euro 4	6cyl.	12418cc	353kW (480PS)	Diesel	Turbo Intercooled	TD19101
D 2676 LOH03 Euro 4	6cyl.	12412cc	338kW (460PS)	Diesel	Turbo Intercooled	TD23068
D 2676 LOH04 Euro 4	6cyl.	12412cc	353kW (480PS)	Diesel	Turbo Intercooled	TD23069
D 2676 LOH10 Euro 3	6cyl.	12412cc	338kW (460PS)	Diesel	Turbo Intercooled	TD23077
08-431000-00	STD	126.00	4.000		008 GDC P	KV4
			3.000		005 CR P	GOE13
			4.000		CR P	GOE13



22

D 2840			10cyl.			Diesel		FM9033
D 2842			12cyl.			Diesel		FM9034
D 2842 LE 404			V12cyl.	21930cc	956kW (1300PS)	Diesel	Turbo Intercooled	TD27702
D 2842 LE 602			V12cyl.	21930cc	588kW (800PS)	Diesel	Turbo Intercooled	TD25234
D 2848			8cyl.			Diesel		FM9035
D 2876 LF02 Euro 2			6cyl.	12816cc	338kW (460PS)	Diesel	Turbo Intercooled	TD7773
D 2876 LOH / LUH01 Euro 2			6cyl.	12816cc	338kW (460PS)	Diesel	Turbo Intercooled	TD16249
08-124500-00	STD	128.00	4.000		008 CK P			KV1
[R67933]			3.000		005 P			GOE12
			4.000		231 CR P			GOE12

23

D 2840 LE			V10cyl.	18273cc	346kW (471PS)	Diesel	Turbo Intercooled	TD19453
D 2840 LF/460			V10cyl.	18273cc	338kW (460PS)	Diesel	Turbo Intercooled	TD7795
D 2840 LF04 Euro 1			V10cyl.	18273cc	368kW (500PS)	Diesel	Turbo Intercooled	TD7797
D 2840 LF06 Euro 1			V10cyl.	18273cc	368kW (500PS)	Diesel	Turbo Intercooled	TD7798
D 2840 LF20 Euro 2			V10cyl.	18273cc	441kW (600PS)	Diesel	Turbo Intercooled	TD7774
D 2840 LXF			V10cyl.	18273cc	338kW (460PS)	Diesel	Turbo Intercooled	TD19455
D 2840 MFR			V10cyl.	18273cc	268-245kW (364-333PS)	Diesel		TD19456
D 2840 TL			V10cyl.	18273cc	603kW (820PS)	Diesel	Turbo Intercooled	FM5425
D 2842 LF10 Euro 3			V12cyl.	21927cc	735kW (1000PS)	Diesel	Turbo Intercooled	TD20177
D 2842 LXE			V12cyl.	21927cc	662kW (900PS)	Diesel	Turbo Intercooled	TD19121
D 2842 LYE			V12cyl.	21927cc	735kW (1000PS)	Diesel	Turbo Intercooled	TD19122
D 2842 LZE			V12cyl.	21927cc	735kW (1000PS)	Diesel	Turbo Intercooled	TD19123
D 2848 LXE			V8cyl.	14618cc	500kW (680PS)	Diesel	Turbo Intercooled	TD19118
D 2848 LYE			V8cyl.	14618cc	500kW (680PS)	Diesel	Turbo Intercooled	TD19119
D 2848 MH			V8cyl.	14618cc	206kW (280PS)	Diesel		TD19076
D 2865 LF/260			5cyl.	9973cc	191kW (260PS)	Diesel	Turbo Intercooled	TD7776
D 2865 LF02			5cyl.	9973cc	198kW (270PS)	Diesel	Turbo Intercooled	TD7696
D 2865 LF03			5cyl.	9973cc	235kW (320PS)	Diesel	Turbo Intercooled	TD7780
D 2865 LF05 Euro 1			5cyl.	9973cc	198kW (270PS)	Diesel	Turbo Intercooled	TD7777
D 2865 LF06 Euro 1			5cyl.	9973cc	235kW (320PS)	Diesel	Turbo Intercooled	TD7781
D 2865 LF21 Euro 2			5cyl.	9973cc	250kW (340PS)	Diesel	Turbo Intercooled	TD7769
D 2865 LF22 Euro 1			5cyl.	9973cc	198kW (270PS)	Diesel	Turbo Intercooled	TD7764
D 2865 LF23 Euro 1			5cyl.	9973cc	235kW (320PS)	Diesel	Turbo Intercooled	TD7767
D 2865 LF24 Euro 2			5cyl.	9973cc	213kW (290PS)	Diesel	Turbo Intercooled	TD7766
D 2865 LOH01 Euro 1			5cyl.	9973cc	198kW (270PS)	Diesel	Turbo Intercooled	TD9087
D 2865 LOH02 Euro 1			5cyl.	9973cc	235kW (320PS)	Diesel	Turbo Intercooled	TD7754
D 2865 LU01/Silent Euro 1			5cyl.	9973cc	198kW (270PS)	Diesel	Turbo Intercooled	TD7724
D 2865 LUH02 Euro 1			5cyl.	9973cc	198kW (270PS)	Diesel	Turbo Intercooled	TD7578
D 2865 LUH05 Euro 1			5cyl.	9973cc	198kW (270PS)	Diesel	Turbo Intercooled	TD7579
D 2865 LUH07 Euro 2			5cyl.	9973cc	228kW (310PS)	Diesel	Turbo Intercooled	TD7581
D 2865 LUH08 Euro 1			5cyl.	9973cc	235kW (320PS)	Diesel	Turbo Intercooled	TD7612





D 2865 LUH09 Euro 2	5cyl.	9973cc	191kW (260PS)	Diesel	Turbo Intercooled	TD7594
D 2866 F/240	6cyl.	11967cc	177kW (240PS)	Diesel		TD7775
D 2866 FR	6cyl.	11967cc	177kW (240PS)	Diesel		TD19127
D 2866 KF	6cyl.	11967cc	265kW (360PS)	Diesel	Turbo Intercooled	TD5651
D 2866 KFZ	6cyl.	11967cc	265kW (360PS)	Diesel	Turbo Intercooled	TD7761
D 2866 KOH/360	6cyl.	11967cc	265kW (360PS)	Diesel	Turbo Intercooled	TD16487
D 2866 KUH/360 Euro 1	6cyl.	11967cc	265kW (360PS)	Diesel	Turbo Intercooled	TD7591
D 2866 KUL	6cyl.	11967cc	265kW (360PS)	Diesel	Turbo Intercooled	TD7786
D 2866 LF/290	6cyl.	11967cc	213kW (290PS)	Diesel	Turbo Intercooled	TD7778
D 2866 LF03	6cyl.	11967cc	272kW (370PS)	Diesel	Turbo Intercooled	TD7787
D 2866 LF04	6cyl.	11967cc	220kW (299PS)	Diesel	Turbo Intercooled	TD7779
D 2866 LF05 Euro 1	6cyl.	11967cc	272kW (370PS)	Diesel	Turbo Intercooled	TD7788
D 2866 LF06	6cyl.	11967cc	309kW (420PS)	Diesel	Turbo Intercooled	TD7792
D 2866 LF09 Euro 1	6cyl.	11967cc	309kW (420PS)	Diesel	Turbo Intercooled	TD7793
D 2866 LF10 Euro 1	6cyl.	11967cc	309kW (420PS)	Diesel	Turbo Intercooled	TD7794
D 2866 LF14 Euro 2	6cyl.	11967cc	294-309kW (400-420PS)	Diesel	Turbo Intercooled	TD21308
D 2866 LF15 Euro 1	6cyl.	11967cc	272kW (370PS)	Diesel	Turbo Intercooled	TD7789
D 2866 LF16 Euro 2	6cyl.	11967cc	294kW (400PS)	Diesel	Turbo Intercooled	TD7791
D 2866 LF17 Euro 2	6cyl.	11967cc	260kW (354PS)	Diesel	Turbo Intercooled	TD21309
D 2866 LF20 Euro 2	6cyl.	11967cc	294kW (400PS)	Diesel	Turbo Intercooled	TD7771
D 2866 LF21 Euro 1	6cyl.	11967cc	272kW (370PS)	Diesel	Turbo Intercooled	TD7770
D 2866 LF22 Euro 1	6cyl.	11967cc	309kW (420PS)	Diesel	Turbo Intercooled	TD7772
D 2866 LF29 Euro 2	6cyl.	11967cc	294kW (400PS)	Diesel	Turbo Intercooled	TD21310
D 2866 LF30 Euro 2	6cyl.	11967cc	301kW (409PS)	Diesel	Turbo Intercooled	TD21311
D 2866 LF32 Euro 2	6cyl.	11967cc	301kW (409PS)	Diesel	Turbo Intercooled	TD15048
D 2866 LF34	6cyl.	11967cc	228kW (310PS)	Diesel	Turbo Intercooled	TD14308
D 2866 LF35	6cyl.	11967cc	265kW (360PS)	Diesel	Turbo Intercooled	TD14311
D 2866 LF36 Euro 2	6cyl.	11967cc	228kW (310PS)	Diesel	Turbo Intercooled	TD16202
D 2866 LF37 Euro 2	6cyl.	11967cc	265kW (360PS)	Diesel	Turbo Intercooled	TD16203
D 2866 LFZ/290	6cyl.	11967cc	213kW (290PS)	Diesel	Turbo Intercooled	TD7757
D 2866 LOH	6cyl.	11967cc	243-309kW (330-420PS)	Diesel	Turbo Intercooled	TD7750
D 2866 LOH03	6cyl.	11967cc	309kW (420PS)	Diesel	Turbo Intercooled	TD7808
D 2866 LOH06 Euro 1	6cyl.	11967cc	309kW (420PS)	Diesel	Turbo Intercooled	TD7755
D 2866 LOH07	6cyl.	11967cc	272kW (370PS)	Diesel	Turbo Intercooled	TD7602
D 2866 LOH20 Euro 1	6cyl.	11967cc	309kW (420PS)	Diesel	Turbo Intercooled	TD5647
D 2866 LOH22 Euro 1	6cyl.	11967cc	272kW (370PS)	Diesel	Turbo Intercooled	TD7420
D 2866 LOH23 Euro 2	6cyl.	11967cc	294kW (400PS)	Diesel	Turbo Intercooled	TD7592
D 2866 LOH24 Euro 1	6cyl.	11970cc	230kW (313PS)	Diesel	Turbo Intercooled	TD7752
D 2866 LOH25 Euro 2	6cyl.	11967cc	228kW (310PS)	Diesel	Turbo Intercooled	TD7753
D 2866 LOH26 Euro 2	6cyl.	11967cc	257kW (350PS)	Diesel	Turbo Intercooled	TD7590
D 2866 LU 01	6cyl.	11967cc	272kW (370PS)	Diesel	Turbo Intercooled	TD21312
D 2866 LU 03 Euro 1	6cyl.	11967cc	272kW (370PS)	Diesel	Turbo Intercooled	TD21313
D 2866 LU/330	6cyl.	11967cc	243kW (330PS)	Diesel	Turbo Intercooled	TD7809
D 2866 LUH/330	6cyl.	11967cc	243kW (330PS)	Diesel	Turbo Intercooled	TD7593
D 2866 LUH21 Euro 2	6cyl.	11967cc	257kW (350PS)	Diesel	Turbo Intercooled	TD11167





D 2866 LUH22 Euro 2	6cyl.	11967cc	191kW (260PS)	Diesel	Turbo Intercooled	TD11133
D 2866 LUH26 Euro 2	6cyl.	11967cc	228kW (310PS)	Diesel	Turbo Intercooled	TD19129
D 2866 LUL/330	6cyl.	11967cc	243kW (330PS)	Diesel	Turbo Intercooled	TD7783
D 2866 LX	6cyl.	11967cc	198kW (270PS)	Diesel	Turbo Intercooled	TD19128
D 2866 LXF	6cyl.	11967cc	198-274kW (269-372PS)	Diesel	Turbo Intercooled	TD7785
D 2866 LXOH	6cyl.	11967cc	265-274kW (360-373PS)	Diesel	Turbo Intercooled	TD6728
D 2866 T	6cyl.	11967cc	213kW (290PS)	Diesel	Turbo Intercooled	TD7580
D 2866 TOH	6cyl.	11967cc	229kW (313PS)	Diesel	Turbo Intercooled	TD7745
D 2866 TOH/290	6cyl.	11967cc	213kW (290PS)	Diesel	Turbo Intercooled	TD7746
D 2866 TOH/310	6cyl.	11967cc	229kW (313PS)	Diesel	Turbo Intercooled	TD7747
D 2866 TUH	6cyl.	11967cc	224-229kW (305-311PS)	Diesel	Turbo Intercooled	TD7186
D 2866 TUH/290	6cyl.	11967cc	213-224kW (290-305PS)	Diesel	Turbo Intercooled	TD7589
D 2866 TUH01	6cyl.	11967cc	222kW (302PS)	Diesel	Turbo Intercooled	TD7176
D 2866 UH	6cyl.	11967cc	177-186kW (241-253PS)	Diesel		TD7419
D 2866 UM	6cyl.	11967cc	152-177kW (206-241PS)	Diesel		TD7174

08-283100-00 <i>[R45170]</i>	STD	128.00	3.500		008 CR P	KV1
			3.000		005 P	STD
			5.000		231 CR P	STD
08-283100-30	STD	128.00	3.500		008 CR	KV1
			3.000		005	STD
			5.000		231 CR	STD

24

D 2840 LF21 Euro 2	V10cyl.	18273cc	441kW (600PS)	Diesel	Turbo Intercooled	TD18099
D 2866 LF23 Euro 3	6cyl.	11967cc	228kW (310PS)	Diesel	Turbo Intercooled	TD16521
D 2866 LF24 Euro 3	6cyl.	11967cc	265kW (360PS)	Diesel	Turbo Intercooled	TD16522
D 2866 LF25 Euro 3	6cyl.	11967cc	301kW (409PS)	Diesel	Turbo Intercooled	TD16467
D 2866 LF26 Euro 3	6cyl.	11967cc	228kW (310PS)	Diesel	Turbo Intercooled	TD16204
D 2866 LF27 Euro 4	6cyl.	11967cc	265kW (360PS)	Diesel	Turbo Intercooled	TD16205
D 2866 LF28 Euro 3	6cyl.	11967cc	301kW (409PS)	Diesel	Turbo Intercooled	TD15050
D 2866 LOH27 Euro 3	6cyl.	11967cc	228kW (310PS)	Diesel	Turbo Intercooled	TD16760
D 2866 LOH28 Euro 3	6cyl.	11967cc	265kW (360PS)	Diesel	Turbo Intercooled	TD16761
D 2866 LOH29 Euro 3	6cyl.	11967cc	301kW (409PS)	Diesel	Turbo Intercooled	TD16493
D 2866 LOH32 Euro 3	6cyl.	11967cc	228kW (310PS)	Diesel	Turbo Intercooled	TD16746
D 2866 LOH33 Euro 3	6cyl.	11967cc	265kW (360PS)	Diesel	Turbo Intercooled	TD16747
D 2866 LOH34 Euro 3	6cyl.	11967cc	301kW (409PS)	Diesel	Turbo Intercooled	TD16297
D 2866 LUH23 Euro 3	6cyl.	11967cc	191kW (260PS)	Diesel	Turbo Intercooled	TD16764
D 2866 LUH24 Euro 3	6cyl.	11967cc	228kW (310PS)	Diesel	Turbo Intercooled	TD16765
D 2866 LUH25 Euro 3	6cyl.	11967cc	265kW (360PS)	Diesel	Turbo Intercooled	TD16766
D 2866 LUH30 Euro 3	6cyl.	11967cc	301kW (409PS)	Diesel	Turbo Intercooled	TD16767
D 2876 LF03 Euro 3	6cyl.	12816cc	338kW (460PS)	Diesel	Turbo Intercooled	TD17050
D 2876 LF04 Euro 3	6cyl.	12816cc	338kW (460PS)	Diesel	Turbo Intercooled	TD15051
D 2876 LF05 Euro 3	6cyl.	12816cc	375kW (510PS)	Diesel	Turbo Intercooled	TD16206





D 2876 LF06	6cyl.	12816cc	338kW (460PS)	Diesel	Turbo Intercooled	TD14313
D 2876 LF07 Euro 2	6cyl.	12816cc	338kW (460PS)	Diesel	Turbo Intercooled	TD15049
D 2876 LF11 Euro 2	6cyl.	12816cc	338kW (460PS)	Diesel	Turbo Intercooled	TD20603
D 2876 LF12 Euro 3	6cyl.	12816cc	353kW (480PS)	Diesel	Turbo Intercooled	TD16825
D 2876 LF13 Euro 3	6cyl.	12816cc	390kW (530PS)	Diesel	Turbo Intercooled	TD16826
D 2876 LF25 Euro 3	6cyl.	12816cc	353kW (480PS)	Diesel	Turbo Intercooled	TD19115
D 2876 LOH02 Euro 3	6cyl.	12816cc	338kW (460PS)	Diesel	Turbo Intercooled	TD16509
D 2876 LOH03 Euro 3	6cyl.	12816cc	338kW (460PS)	Diesel	Turbo Intercooled	TD16298
D 2876 LOH20 Euro 3	6cyl.	12816cc	353kW (480PS)	Diesel	Turbo Intercooled	TD16762
D 2876 LOH21 Euro 3	6cyl.	12816cc	390kW (530PS)	Diesel	Turbo Intercooled	TD18041

08-143800-00	STD	128.00	4.000		008 CK P	KV1
			3.000		005 CR P	GOE12
			4.000		231 CR P	GOE12

25

D 2840 ME	V10cyl.	18273cc	244kW (332PS)	Diesel	TD19125
D 2840 MF	V10cyl.	18273cc	268kW (365PS)	Diesel	TD7811
D 2840 MFG	V10cyl.	18273cc	268kW (365PS)	Diesel	TD7812
D 2840 MH	V10cyl.	18273cc	244kW (332PS)	Diesel	TD19126
D 2842 ME	V12cyl.	21927cc	275kW (374PS)	Diesel	TD19120

08-282200-10	STD	128.00	3.500		008 CR P	KV1
			3.000		005 IF P	STD
			5.500		231 CR P	STD

26

D 2866 LF31	6cyl.	11967cc	301kW (409PS)	Diesel	TD14312	
D 2866 LF32 Euro 2	6cyl.	11967cc	228-301kW (310-410PS)	Diesel	Turbo Intercooled	FM117034
D 2866 LF39 Euro 2	6cyl.	11967cc	228-301kW (310-410PS)	Diesel	Turbo Intercooled	FM127034
D 2866 LF40 Euro 2	6cyl.	11967cc	301kW (409PS)	Diesel	Turbo Intercooled	TD23662
D 2866 LF41 Euro 2	6cyl.	11967cc	301kW (409PS)	Diesel	Turbo Intercooled	TD23005
D 2866 LF42 Euro 2	6cyl.	11967cc	228-301kW (310-410PS)	Diesel	Turbo Intercooled	FM157034
D 2866 LF43 Euro 2	6cyl.	11967cc	265kW (360PS)	Diesel	Turbo Intercooled	TD23004
D 2866 LUH20 Euro 2	6cyl.	11967cc	228kW (310PS)	Diesel	Turbo Intercooled	TD7582
D 2866 LUH26 Euro 2	6cyl.	11967cc	228kW (310PS)	Diesel	Turbo	TD11134

08-104300-00	STD	128.00	4.000		008 CK P	KV1
			3.000		005 P	STD
			4.000		231 CR P	STD
08-104300-20	STD	128.00	4.000		008 CK	KV1
			3.000		005	STD
			4.000		231 CR	STD



27

E 2842 LE 322			V12cyl.	21927cc	380-420kW (517-571PS)	Turbo Intercooled	TD27639
08-432800-00	STD	128.00	4.000		008 CK P		KV1
			3.000		005 CR P		GOE13
			4.000		231 CR		STD

28

E 2866 DF01			6cyl.	11967cc	170kW (231PS)		TD7763
E 2866 DUH 04 Euro 3			6cyl.	11967cc	180kW (245PS)		TD22859
E 2866 DUH01			6cyl.	11967cc	170kW (231PS)		TD7626
E 2866 DUH03 Euro 3			6cyl.	11967cc	180kW (245PS)		TD16768
E 2866 LUH02 Euro 3			6cyl.	11967cc	228kW (310PS)	Turbo Intercooled	TD16769
E 2876 LUH 02			6cyl.	12816cc	228kW (310PS)	Turbo Intercooled	TD19966
E 2876 LUH 03			6cyl.	12816cc	235kW (320PS)	Turbo Intercooled	TD23804
E 2876 LUH 04			6cyl.	12816cc	200kW (272PS)	Turbo Intercooled	TD25459
08-425800-00	STD	128.00	3.500		008 CK P		KV1
			3.000		005 CR P		GOE12
			5.000		231 CR P		STD
08-433800-00	STD	128.00	3.500		001 CK		KV1
			3.000		026		STD
			4.000		231 CR		STD

29

G 2866 DOH02 Euro 3			6cyl.	11967cc	180kW (245PS)		TD16775
G 2866 DOH03 Euro 3			6cyl.	11967cc	180kW (245PS)		TD16776
G 2866 DUH			6cyl.	11961cc			FM5942
G 2866 DUH04 Euro 3			6cyl.	11967cc	175kW (238PS)		TD16770
G 2866 DUH05 Euro 3			6cyl.	11967cc	175kW (238PS)		TD16771
G 2876 DUH01 Euro 3			6cyl.	12816cc	200kW (272PS)		TD19967
08-289400-00	STD	128.00	3.500		008 CR P		KV1
			3.000		026 P		STD
			5.000		231 CR P		STD



1

AC 60/903 (AC 60/903) 1cyl. FM9226

08-528600-00	STD	65.00	2.000		026 P	GOE12
08-528607-00	0.50mm		2.000		026 P	GOE12
[R48270]			4.000		032 P	GOE12

2

AC 63/200 - AC 66 (AC 63/200 - AC 66) 1cyl. FM9227

08-528700-00	STD	70.00	2.000		026 P	GOE12
08-528707-00	0.50mm		2.000		026 P	GOE12
[R48280]			4.000		232 P	GOE12

3

AC 74.300/500 (AC 74.300/500) 1cyl. FM9228

AC 75.400 - AC 79.300 (AC 75.400 - AC 79.300) 2cyl. FM9229

08-524800-00	STD	80.00	2.000		026 P	GOE12
08-524804-00	0.20mm		2.000		026 P	GOE12
08-524807-00	0.50mm		4.000		232 P	GOE12
08-524811-00	1.00mm		[R48290]			

4

ACX 32/20 (ACX 32/20) 2cyl. FM9263

08-529200-00	STD	82.00	1.500		026 P	GOE12
08-529204-00	0.20mm		1.500		026 P	GOE12
08-529207-00	0.50mm		3.000		232 P	GOE12
[R49630]						



Excavator	01/80→	IAMZ 236	6cyl. 11140cc	1
		Diesel		FM6431

Excavator	01/80→	IAMZ 238	8cyl. 14860cc	
		Diesel		FM8786

08-289000-00	STD	130.00	3.500		007 CR P	KV1
			3.500		007 P	STD
			3.500		026 P	STD
			6.500		231 CR P	STD
			6.500		030 P	STD
08-289100-00	STD	130.00	3.500		007 CR P	KV1
			3.500		007 P	STD
			3.500		026 P	STD
			6.500		231 CR P	STD

MODEL INDEX

Modelverzeichnis • Index de modele • Índice de Modelo
Indeks modelu • Модель автомобиля • دليل الموديل



CCM

x



9

02/03→	2 1.4	FXJA	Petrol	1388	4	4
04/03→	2 1.4 CD	F6JA	Diesel	1399	4	1
04/03→	2 1.4 CD	F6JB	Diesel	1399	4	1
02/04→06/09	3 1.4	FXJA	Petrol	1388	4	4
06/04→06/09	3 1.6 DI Turbo	Y601	Diesel	1560	4	3
06/09→	3 1.6 MZR CD	Y601	Diesel	1560	4	3
10/03→06/09	3 2.0	LF17	Petrol	1999	4	12
06/09→	3 2.0 MZR	LF17	Petrol	1999	4	12
06/04→	3 Saloon 1.6 DI Turbo	Y601	Diesel	1560	4	3
02/04→	3 Saloon 2.0	LF17	Petrol	1999	4	12
06/09→	3 Saloon 2.0 MZR	LF17	Petrol	1999	4	12
03/05→	5 2.0	LFF7	Petrol	1999	4	12
06/02→08/07	6 2.0	LF17	Petrol	1999	4	12
06/02→08/07	6 2.0	LF18	Petrol	1999	4	12
03/05→08/07	6 2.0	LFF7	Petrol	1999	4	12
08/07→	6 2.0 MZR	LF17	Petrol	1999	4	12
06/02→08/07	6 2.3	L3C1	Petrol	2261	4	12
02/08→	6 Estate 2.0 MZR	LF17	Petrol	1999	4	12
08/02→08/07	6 Hatchback 2.0	LF17	Petrol	1999	4	12
08/02→08/07	6 Hatchback 2.0	LF18	Petrol	1999	4	12
03/05→08/07	6 Hatchback 2.0	LFF7	Petrol	1999	4	12
08/07→	6 Hatchback 2.0 MZR	LF17	Petrol	1999	4	12
08/02→08/07	6 Hatchback 2.3	L3C1	Petrol	2261	4	12
08/02→08/07	6 Station Wagon 2.0	LF17	Petrol	1999	4	12
08/02→08/07	6 Station Wagon 2.0	LF18	Petrol	1999	4	12
03/05→08/07	6 Station Wagon 2.0	LFF7	Petrol	1999	4	12
08/02→08/07	6 Station Wagon 2.3	L3C1	Petrol	2261	4	12
11/02→08/07	6 Station Wagon 2.3 AWD	L3C1	Petrol	2261	4	12
	121 111 1.3	JJA (Endura E SEFI)	Petrol	1299	4	2
03/96→04/03	121 III 1.3	J4R	Petrol	1299	4	2
03/96→04/03	121 III 1.3	J4T	Petrol	1299	4	2
03/96→04/03	121 III 1.3	JJK	Petrol	1299	4	2
03/96→04/03	121 III 1.3	JJM	Petrol	1299	4	2
11/80→10/89	323 II 1.3	E3	Petrol	1296	4	5
11/80→09/86	323 II 1.5	E5	Petrol	1490	4	5
11/80→10/89	323 II Hatchback 1.3	E3	Petrol	1296	4	5
11/80→12/85	323 II Hatchback 1.5	E5	Petrol	1490	4	5
08/85→05/89	323 III 1.3	E3	Petrol	1296	4	5
08/85→05/89	323 III 1.5	E5	Petrol	1490	4	5
09/85→12/87	323 III Hatchback 1.3	E3	Petrol	1296	4	5
08/85→05/89	323 III Hatchback 1.5	E5	Petrol	1490	4	5
07/86→04/90	323 III Station Wagon 1.3	E3	Petrol	1296	4	5
05/86→05/89	323 III Station Wagon 1.5	E5	Petrol	1490	4	5
01/86→06/87	323 III Station Wagon 1.5 LX	E5	Petrol	1490	4	5
05/94→09/98	323 S V 1.6 TD	4EE1-T	Diesel	1686	4	6
05/79→05/82	626 I 2.0	MA	Petrol	1970	4	7
11/82→06/87	626 II 1.6	F6	Petrol	1587	4	8
03/83→09/87	626 II 2.0	FE	Petrol	1998	4	9
11/82→06/87	626 II 2.0 D	RF46	Diesel	1998	4	11
02/83→10/87	626 II Coupe 2.0	FE	Petrol	1998	4	9
03/83→09/87	626 II Hatchback 1.6	F6	Petrol	1587	4	8
03/83→09/87	626 II Hatchback 2.0	FE	Petrol	1998	4	9
03/84→06/87	626 II Hatchback 2.0 D	RF46	Diesel	1998	4	11
11/87→05/92	626 III 1.8	F8	Petrol	1789	4	9
	626 III 2.0 D	RF83	Diesel	1998	4	11
09/87→08/91	626 III Coupe 1.8	F8	Petrol	1789	4	9
09/87→10/90	626 III Coupe 2.0	FE	Petrol	1998	4	9
11/87→05/92	626 III Hatchback 1.8	F8	Petrol	1789	4	9
09/87→10/90	626 III Hatchback 2.0	FE	Petrol	1998	4	9
01/88→03/92	626 III Station Wagon 1.8	F8	Petrol	1789	4	9

Modelverzeichnis • Index de modele • Índice de Modelo
Indeks modelu • Модель автомобиля • دليل الموديل

MODEL INDEX



CCM

x



9

10/88→09/97	626 III Station Wagon 2.0	FE	Petrol	1998	4	9
10/92→04/97	626 IV 2.0 D GLX Complex	RF OHC	Diesel	1998	4	11
01/93→04/97	626 IV Hatchback 2.0 D GLX Complex	RF OHC	Diesel	1998	4	11
05/79→07/86	929 I 2.0	MA	Petrol	1970	4	7
03/84→07/87	929 II 2.0	FE	Petrol	1998	4	9
05/82→03/84	929 II 2.0	MA	Petrol	1970	4	7
10/84→07/87	929 II 2.0 i GLX	FE	Petrol	1998	4	9
03/84→07/87	929 II Coupe 2.0	FE	Petrol	1998	4	9
05/82→03/84	929 II Coupe 2.0	MA	Petrol	1970	4	7
01/83→12/87	929 II Estate 2.0	MA	Petrol	1970	4	7
06/87→12/88	929 III 2.0	FE	Petrol	1998	4	9
81/81→90/90	Bongo	S2	Diesel	2209	4	13
01/85→03/96	B-Serie 1.6	F6	Petrol	1587	4	8
02/77→01/82	B-Serie 1.8	VC	Petrol	1769	4	7
01/85→03/96	B-Serie 2.0	FE	Petrol	1998	4	9
03/85→10/89	B-Serie 2.2 D	R2	Diesel	2184	4	10
	B-Serie 2.2 D	S2	Diesel	2209	4	13
03/77→01/92	E2500 / Titan 2.5D	XA	Diesel	2522	4	13
01/84→07/06	E-Serie Box E2000	FE	Petrol	1998	4	9
02/97→08/02	E-Serie Box E2200 D	R2	Diesel	2184	4	10
02/97→05/03	E-Serie Box E2200 D 4WD	R2	Diesel	2184	4	10
01/84→02/88	E-SERIE Bus E2200 D 4WD	R2	Diesel	2184	4	10
04/97→07/99	E-SERIE Platform/Chassis E2200	R2	Diesel	2184	4	10
02/05→03/05	Premacy 2.0	LFF7	Petrol	1999	4	12
08/86→10/95	Spectron 2.0 D	RF46	Diesel	1998	4	11
08/86→10/95	Spectron 2.2 TD	R2	Diesel	2184	4	10
02/84→	Titan 3.2	SL	Diesel	3455	4	14

ENGINE INDEX

Motorverzeichnis • Index de moteur • Índice de Motor
Indeks silnika • Модель двигателя • دليل المحرك



CCM

x



9

4EE1-T	Diesel	1686	4	79.00	6
E3	Petrol	1296	4	77.00	5
E5	Petrol	1490	4	77.00	5
F6	Petrol	1587	4	81.00	8
F6JA	Diesel	1399	4	73.70	1
F6JB	Diesel	1399	4	73.70	1
F8	Petrol	1789	4	86.00	9
FE	Petrol	1998	4	86.00	9
FXJA	Petrol	1388	4	76.00	4
J4R	Petrol	1299	4	74.00	2
J4T	Petrol	1299	4	74.00	2
JJA (Endura E SEFI)	Petrol	1299	4	74.00	2
JJK	Petrol	1299	4	74.00	2
JJM	Petrol	1299	4	74.00	2
L3C1	Petrol	2261	4	87.50	12
LF17	Petrol	1999	4	87.50	12
LF18	Petrol	1999	4	87.50	12
LFF7	Petrol	1999	4	87.50	12
MA	Petrol	1970	4	80.00	7
R2	Diesel	2184	4	86.00	10
RF OHC	Diesel	1998	4	86.00	11
RF46	Diesel	1998	4	86.00	11
RF83	Diesel	1998	4	86.00	11
S2	Diesel	2209	4	88.90	13
SL	Diesel	3455	4	100.00	14
VC	Petrol	1769	4	80.00	7
XA	Diesel	2522	4	88.90	13
Y601	Diesel	1560	4	75.00	3



2 1.4 CD		04/03→	F6JA						1
				4cyl.	1399cc	50kW (68PS)			
			Diesel	Turbo					TD18693
2 1.4 CD		04/03→	F6JB						
				4cyl.	1399cc	50kW (68PS)			
			Diesel	Turbo					TD20951
08-135300-00	STD	73.70	2.500		008 CK P				KV1
08-135305-00	0.25mm		1.950		005 IFU P				GOE12
08-135307-00	0.50mm		2.500		231 CR P				GOE12
<i>[R66770]</i>									
121 III 1.3		03/96→04/03	J4R						2
				4cyl.	1299cc	44kW (60PS)			
									TD24680
121 III 1.3		03/96→04/03	J4T						
				4cyl.	1299cc	44kW (60PS)			
									TD24681
121 111 1.3			JJA (Endura E SEFI)						
				4cyl.	1299cc	37kW (50PS)			
									TD25845
121 III 1.3		03/96→04/03	JJK						
				4cyl.	1299cc	37kW (50PS)			
									TD24678
121 III 1.3		03/96→04/03	JJM						
				4cyl.	1299cc	37kW (50PS)			
									TD24679
08-785000-00	STD	74.00	1.500		001 IF CR P				IKA
08-785007-00	0.50mm		1.750		026 P				STD
08-785011-00	1.00mm		3.000		712 CR				ST
<i>[R43440]</i>									
3 1.6 DI Turbo		06/04→06/09	Y601						3
3 1.6 MZR CD		06/09→		4cyl.	1560cc	80-81kW (109-110PS)			
3 Saloon 1.6 DI Turbo		06/04→							
			Diesel	Turbo Intercooled					TD18512
08-424000-00	STD	75.00	3.000		008 CK P				KV1
08-424007-00	0.50mm		1.950		005 P				F12/F14
08-424008-00	0.60mm		2.500		231 LKZ CR P				GOE12



2 1.4	02/03→	FXJA							4
3 1.4	02/04→06/09		4cyl.						
			1388cc				59kW (80PS)		
TD18695									

08-426100-00	STD	76.00	1.200		001 NT		ST
08-426107-00	0.50mm		1.500		005 P		STD
			2.500		712 NT		ST

323 II 1.3, 323 II Hatchback 1.3	11/80→10/89	E3							5
323 III 1.3	08/85→05/89		4cyl.						
323 III Hatchback 1.3	09/85→12/87		1296cc				44-55kW (60-75PS)		
323 III Station Wagon 1.3	07/86→04/90								TD1955

323 II 1.5	11/80→09/86	E5							
323 II Hatchback 1.5	11/80→12/85		4cyl.						
323 III 1.5, 323 III Hatchback 1.5	08/85→05/89		1490cc				54-65kW (73-88PS)		
323 III Station Wagon 1.5	05/86→05/89								
323 III Station Wagon 1.5 LX	01/86→06/87								TD1956

08-283900-00	STD	77.00	1.500		001 IF CR P		IKA
01/1982→			2.000		026 P		STD
[R40510]			4.000		236 P		STD

323 S V 1.6 TD	05/94→09/98	4EE1-T							6
			4cyl.						
			1686cc				60-65kW (82-88PS)		
			Diesel				Turbo		TD9465

08-307600-00	STD	79.00	2.000		001 CR P		KV1
08-307607-00	0.50mm		1.500		005 CR P		STD
[R48400]			3.000		231 CR P		STD

626 I 2.0	05/79→05/82	MA							7
929 I 2.0	05/79→07/86		4cyl.						
929 II 2.0, 929 II Coupe 2.0	05/82→03/84		1970cc				66kW (89PS)		
929 II Estate 2.0	01/83→12/87								TD2019

B-Serie 1.8	02/77→01/82	VC							
			4cyl.						
			1769cc				61kW (82PS)		
									TD2052

08-283800-00	STD	80.00	1.200		001 IF CR P		IKA
[R35000]			1.500		026 P		STD
			4.000		236 P		STD



626 II 1.6	11/82→06/87	F6							8
626 II Hatchback 1.6	03/83→09/87		4cyl.						
B-Serie 1.6	01/85→03/96		1587cc				59-66kW (80-90PS)		
									TD1967

08-283700-00	STD	81.00	1.500		001 IF CR P		IKA
[R42030]			1.500		005 P		STD
			4.000		236 P		STD





626 III 1.8	11/87→05/92	F8				9
626 III Coupe 1.8	09/87→08/91		4cyl.			
626 III Hatchback 1.8	11/87→05/92		1789cc	65kW (88PS)		
626 III Station Wagon 1.8	01/88→03/92				TD1969	

626 II 2.0	03/83→09/87	FE				TD1976
626 II Coupe 2.0	02/83→10/87		4cyl.			
626 II Hatchback 2.0	03/83→09/87		1998cc	66-88kW (90-120PS)		
626 III Coupe 2.0, 626 III Hatchback 2.0	09/87→10/90					
626 III Station Wagon 2.0	10/88→09/97					
929 II 2.0	03/84→07/87					
929 II 2.0 i GLX	10/84→07/87					
929 II Coupe 2.0	03/84→07/87					
929 III 2.0	06/87→12/88					
B-Serie 2.0	01/85→03/96					
E-Serie Box E2000	01/84→07/06					

08-282700-10	STD	86.00	1.500		001 IF CR P	KV1
[R41520]			1.500		026 P	STD
			4.000		712 CR	ST



B-Serie 2.2 D	03/85→10/89	R2				10
E-Serie Box E2200 D	02/97→08/02		4cyl.			
E-Serie Box E2200 D 4WD	02/97→05/03		2184cc	52kW (71PS)		
E-SERIE Bus E2200 D 4WD	01/84→02/88	Diesel				
E-SERIE Platform/Chassis E2200	04/97→07/99					
Spectron 2.2 TD	08/86→10/95				TD2030	

08-283600-00	STD	86.00	2.000		001 CR P	KV1	
08-283607-00	0.50mm			2.000		005 IW P	STD
08-283611-00	1.00mm			4.000		231 CR P	STD
[R42580]							

626 IV 2.0 D GLX Complex	10/92→04/97	RF OHC				11
626 IV Hatchback 2.0 D GLX Complex	01/93→04/97		4cyl.			
			1998cc	55kW (75PS)		
		Diesel			TD2042	

626 II 2.0 D	11/82→06/87	RF46				TD2043
626 II Hatchback 2.0 D	03/84→06/87		4cyl.			
Spectron 2.0 D	08/86→10/95		1998cc	46-53kW (63-72PS)		
		Diesel			TD2043	

626 III 2.0 D		RF83				TD2044
			4cyl.			
			1998cc	55-60kW (75-82PS)		
		Diesel			TD2044	

08-253300-00	STD	86.00	2.000		001 IF CR P	STD	
				2.000		005 IW P	STD
				3.000		231 CR P	STD



6 2.3	06/02→08/07	L3C1				12
6 Hatchback 2.3, 6 Station Wagon 2.3	08/02→08/07		4cyl.			
6 Station Wagon 2.3 AWD	11/02→08/07		2261cc	122kW (166PS)		
TD18208						

3 2.0	10/03→06/09	LF17				
3 2.0 MZR	06/09→		4cyl.			
3 Saloon 2.0	02/04→		1999cc	104kW (141PS)		
3 Saloon 2.0 MZR	06/09→					
6 2.0	06/02→08/07					
6 2.0 MZR	08/07→					
6 Estate 2.0 MZR	02/08→					
6 Hatchback 2.0	08/02→08/07					
6 Hatchback 2.0 MZR	08/07→					
6 Station Wagon 2.0	08/02→08/07					TD18206

6 2.0	06/02→08/07	LF18				
6 Hatchback 2.0, 6 Station Wagon 2.0	08/02→08/07		4cyl.			
			1999cc	104kW (141PS)		
TD18207						

5 2.0	03/05→	LFF7				
6 2.0, 6 Hatchback 2.0,	03/05→08/07		4cyl.			
6 Station Wagon 2.0			1999cc	107kW (146PS)		
Premacy 2.0	02/05→03/05					TD19205

08-423400-00	STD	87.50	1.200		001 CR P	ST
08-423407-00	0.50mm		1.200		026 P	STD
			2.500		712 CR	ST

Bongo	81/81→90/90	S2				13
B-Serie 2.2 D			4cyl.			
			2209cc	51-52kW (70-71PS)		
TD7864						

E2500 / Titan 2.5D	03/77→01/92	XA				
			4cyl.			
			2522cc	52kW (71PS)		
TD7867						

08-284100-00	STD	88.90	2.385		001 CR P	KV1
			2.385		005 IF P	STD
			4.747		231 CR P	STD

Titan 3.2	02/84→	SL				14
			4cyl.			
			3455cc	66-77kW (90-105PS)		
TD7869						

08-111900-00	STD	100.00	2.500		001 CR P	KV1
<i>[R42630]</i>			2.000		005 IW CR P	STD
			4.500		231 CR P	STD

Modelverzeichnis • Index de modele • Índice de Modelo
Indeks modelu • Модель автомобиля • دليل الموديل

MODEL INDEX



CCM

x



9

01/68→01/77	/8 200	M 115.923	Petrol	1988	4	18
01/68→01/77	/8 200	M 115.926	Petrol	1988	4	18
01/68→01/77	/8 200 D	OM 615.913	Diesel	1988	4	23
01/68→01/77	/8 220 D	OM 615.912	Diesel	2197	4	23
08/73→12/76	/8 230.4	M 115.951	Petrol	2308	4	46
08/73→01/77	/8 240 D	OM 616.916	Diesel	2404	4	40
08/74→11/76	/8 240 D 3.0	OM 617.910	Diesel	2998	5	40
06/72→11/76	/8 250 2.8	M 130.923	Petrol	2750	6	17
06/72→11/76	/8 280	M 110.921	Petrol	2746	6	15
06/72→11/76	/8 280 E	M 110.981	Petrol	2746	6	15
06/72→11/76	/8 Coupe 250 C 2.8	M 130.923	Petrol	2750	6	17
06/72→02/77	/8 Coupe 280 C	M 110.921	Petrol	2746	6	15
06/72→01/77	/8 Coupe 280 CE	M 110.981	Petrol	2746	6	15
04/88→08/93	100 Box 2.0 D	OM 615.970 (OM 615)	Diesel	1988	4	22
09/93→04/96	100 Box 2.0 D	OM 615.970 (OM 615)	Diesel	1988	4	22
04/88→08/93	100 Bus 2.0 D	OM 615.963 (OM 615)	Diesel	1988	4	22
04/88→08/93	100 Bus 2.0 D	OM 615.964 (OM 615)	Diesel	1988	4	22
04/88→08/93	100 Bus 2.0 D	OM 615.965 (OM 615)	Diesel	1988	4	22
04/88→08/93	100 Bus 2.0 D	OM 615.970 (OM 615)	Diesel	1988	4	22
09/93→04/96	100 Bus 2.0 D	OM 615.970 (OM 615)	Diesel	1988	4	22
05/73→02/79	132 2.0 D	OM 615.961 (OM 615)	Diesel	1988	4	22
05/73→02/79	132 2.0 D	OM 615.969 (OM 615)	Diesel	1988	4	22
01/49→12/63	170 D	OM 636	Diesel	1767	4	2
07/53→02/58	170 S-D	OM 636.931	Diesel	1767	4	2
01/54→12/63	180 D	OM 636	Diesel	1767	4	2
10/82→10/84	190 2.0	M 102.921	Petrol	1997	4	32
01/86→05/90	190 2.0	M 102.924	Petrol	1997	4	32
09/84→05/90	190 2.0	M 102.924	Petrol	1997	4	32
09/87→09/88	190 2.3	M 102.985	Petrol	2299	4	47
10/82→09/88	190 2.3 E	M 102.985	Petrol	2299	4	47
10/82→09/88	190 2.6	M 103.942 (KAT)	Petrol	2599	6	7
08/83→08/89	190 D 2.0	OM 601.911	Diesel	1978	4	19
08/89→08/93	190 D 2.0	OM 601.911	Diesel	1978	4	19
04/85→08/93	190 D 2.5	OM 602.911	Diesel	2497	5	19
08/89→08/93	190 D 2.5	OM 602.911	Diesel	2497	5	19
04/90→08/93	190 E 1.8	M 102.910	Petrol	1797	4	32
04/92→08/93	190 E 1.8	M 102.919	Petrol	1797	4	32
02/85→12/86	190 E 2.0	M 102.961	Petrol	1997	4	32
10/82→06/93	190 E 2.0	M 102.961	Petrol	1997	4	32
01/85→08/93	190 E 2.0	M 102.962	Petrol	1997	4	32
02/85→12/86	190 E 2.0	M 102.962	Petrol	1997	4	32
10/82→06/93	190 E 2.0	M 102.962	Petrol	1997	4	32
09/86→08/91	190 E 2.3	M 102.985	Petrol	2299	4	47
10/86→08/93	190 E 2.3	M 102.985	Petrol	2299	4	47
04/84→01/87	190 E 2.3-16	M 102.983	Petrol	2299	4	48
09/85→08/88	190 E 2.3-16	M 102.983	Petrol	2299	4	48
09/85→12/87	190 E 2.3-16	M 102.983	Petrol	2299	4	48
09/88→08/93	190 E 2.5-16	M 102.990	Petrol	2499	4	48
03/89→08/93	190 E 2.5-16	M 102.991	Petrol	2499	4	48
09/86→08/93	190 E 2.6	M 103.942 (KAT)	Petrol	2599	6	7
09/86→12/89	190 E 2.6	M 103.942 (KAT)	Petrol	2599	6	7
02/88→08/93	190 Turbo-D 2.5	OM 602.961	Diesel	2497	5	21
05/85→	200 GE	M 102.964	Petrol	1997	4	32
04/92→09/95	230 G	M 102.958	Petrol	2299	4	47
04/82→08/93	230 GE	M 102.998	Petrol	2299	4	47
04/92→09/95	230 GE	M 102.998	Petrol	2299	4	47
09/78→	240 GD	OM 616.940 (OM 616)	Diesel	2399	4	38
12/79→08/90	300 GD	OM 617.933	Diesel	2998	5	38
11/85→12/87	300 SD Turbo	OM 603.961	Diesel	2996	6	21
08/90→10/95	300 SD Turbo	OM 617.951	Diesel	2998	5	38

MODEL INDEX

Modelverzeichnis • Index de modele • Índice de Modelo
Indeks modelu • Модель автомобиля • دليل المحرك



CCM

x



9

03/73→07/77	0309 D 2.2	OM 615.938 (OM 615)	Diesel	2197	4	23
03/90→06/91	350 D	OM 603A.970	Diesel	3449	6	34
05/73→02/79	2000 D	OM 615.966 (OM 615)	Diesel	1988	4	22
05/73→02/79	2000 D	OM 615.967 (OM 615)	Diesel	1988	4	22
05/73→02/79	2000 D	OM 615.968 (OM 615)	Diesel	1988	4	22
05/03→	Accelo 715 C	OM 612.966	Diesel	2685	5	26
07/97→08/04	A-Class A 140	M 166.940	Petrol	1397	4	3
01/01→08/04	A-Class A 140	M 166.960	Petrol	1598	4	3
09/04→06/12	A-Class A 150	M 266.920	Petrol	1498	4	8
07/97→08/04	A-Class A 160	M 166.960	Petrol	1598	4	3
04/09→06/12	A-Class A 160	M 266.920	Petrol	1498	4	8
09/04→06/12	A-Class A 160 CDI	OM 640.942	Diesel	1991	4	9
02/01→08/04	A-Class A 160 CDI	OM 668.940 (OM 668 DE17LA)	Diesel	1689	4	4
07/98→02/01	A-Class A 160 CDI	OM 668.941 (OM 668 DE17A)	Diesel	1689	4	4
09/04→06/12	A-Class A 170	M 266.940	Petrol	1699	4	8
07/98→02/01	A-Class A 170 CDI	OM 668.940 (OM 668 DE17LA)	Diesel	1689	4	4
02/01→08/04	A-Class A 170 CDI	OM 668.942	Diesel	1689	4	4
04/09→06/12	A-Class A 180	M 266.940	Petrol	1699	4	8
09/04→06/12	A-Class A 180 CDI	OM 640.940	Diesel	1991	4	9
09/04→06/12	A-Class A 200	M 266.960	Petrol	2034	4	8
09/04→06/12	A-Class A 200 CDI	OM 640.941	Diesel	1991	4	9
09/12→	A-Class A 220 CDI	OM 651.930	Diesel	2143	4	11
03/05→11/11	B-Class B 150	M 266.920	Petrol	1498	4	8
04/09→11/11	B-Class B 160	M 266.920	Petrol	1498	4	8
03/05→11/11	B-Class B 170	M 266.940	Petrol	1699	4	8
04/08→11/11	B-Class B 170 NGT	M 266.960	Petrol	2034	4	8
04/09→11/11	B-Class B 180	M 266.940	Petrol	1699	4	8
03/05→11/11	B-Class B 180 CDI	OM 640.940	Diesel	1991	4	9
04/08→11/11	B-Class B 180 NGT	M 266.960	Petrol	2034	4	8
03/05→11/11	B-Class B 200	M 266.960	Petrol	2034	4	8
03/05→11/11	B-Class B 200 CDI	OM 640.941	Diesel	1991	4	9
11/11→	B-Class B 220 CDI	OM 651.930	Diesel	2143	4	11
	Bus	M 121.922	Petrol	1897	4	13
06/93→	C 180	M 111	Petrol	1799	4	14
01/69→12/71	Cabriolet 280 SE 3.5	M 116.980	Petrol	3499	V8	43
04/92→06/93	Cabriolet 300 CE-24	M 104.980	Petrol	2960	6	31
08/97→05/00	C-Class C 43 AMG	M 113.944	Petrol	4266	V8	36
03/93→05/00	C-Class C 180	M 111.920	Petrol	1799	4	14
03/93→05/00	C-Class C 180	M 111.921	Petrol	1799	4	14
11/94→05/00	C-Class C 180	M 111.921	Petrol	1799	4	14
10/00→05/02	C-Class C 180	M 111.951	Petrol	1998	4	35
01/11→	C-Class C 180 CDI	OM 651.913	Diesel	2143	4	11
01/08→	C-Class C 180 Kompressor	M 271.910	Petrol	1597	4	5
05/02→02/07	C-Class C 180 Kompressor	M 271.946 (M271 SE18)	Petrol	1796	4	5
01/07→	C-Class C 180 Kompressor	M 271.952	Petrol	1796	4	5
01/94→05/00	C-Class C 200	M 111.941	Petrol	1998	4	35
01/94→05/00	C-Class C 200	M 111.945	Petrol	1998	4	35
03/98→05/00	C-Class C 200 CDI	OM 611.960	Diesel	2148	4	26
09/00→02/07	C-Class C 200 CDI	OM 611.962	Diesel	2148	4	26
01/07→	C-Class C 200 CDI	OM 646.811	Diesel	2148	4	27
01/07→	C-Class C 200 CDI	OM 646.812	Diesel	2148	4	27
02/01→02/07	C-Class C 200 CDI	OM 646.962	Diesel	2148	4	28
04/03→02/07	C-Class C 200 CDI	OM 646.962	Diesel	2148	4	28
01/11→	C-Class C 200 CDI	OM 651.913	Diesel	2143	4	11
07/03→02/07	C-Class C 200 CGI Kompressor	M 271.942 (M271 DE18)	Petrol	1796	4	6
03/93→05/00	C-Class C 200 D	OM 601.913	Diesel	1997	4	20
03/93→05/00	C-Class C 200 D	OM 601.915	Diesel	1997	4	20
10/96→05/00	C-Class C 200 D	OM 604.915	Diesel	1997	4	20
10/95→05/00	C-Class C 200 Kompressor	M 111.944	Petrol	1998	4	35
11/96→05/00	C-Class C 200 Kompressor	M 111.944	Petrol	1998	4	35



CCM

x



9

05/00→05/02	C-Class C 200 Kompressor	M 111.955	Petrol	1998	4	35
05/02→02/07	C-Class C 200 Kompressor	M 271.940 (M271 SE18)	Petrol	1796	4	5
01/07→	C-Class C 200 Kompressor	M 271.950	Petrol	1796	4	5
03/93→05/00	C-Class C 220	M 111.961	Petrol	2199	4	35
03/14→	C-Class C 220 BlueTEC	OM 651.921	Diesel	2143	4	11
12/13→	C-Class C 220 BlueTEC	OM 651.921	Diesel	2143	4	11
09/97→05/00	C-Class C 220 CDI	OM 611.960	Diesel	2148	4	26
05/00→02/07	C-Class C 220 CDI	OM 611.962	Diesel	2148	4	26
01/07→	C-Class C 220 CDI	OM 646.811	Diesel	2148	4	27
02/04→02/07	C-Class C 220 CDI	OM 646.963	Diesel	2148	4	28
01/07→	C-Class C 220 CDI	OM 651.911	Diesel	2143	4	11
12/08→	C-Class C 220 CDI	OM 651.911	Diesel	2143	4	11
02/13→	C-Class C 220 CDI 4-matic	OM 651.912	Diesel	2143	4	11
07/96→05/00	C-Class C 220 D	OM 604.910	Diesel	2155	4	34
08/93→05/00	C-Class C 220 D	OM 604.910	Diesel	2155	4	34
06/96→06/97	C-Class C 230	M 111.974	Petrol	2295	4	37
01/05→02/07	C-Class C 230	M 272.920	Petrol	2496	V6	25
01/07→	C-Class C 230	M 272.921	Petrol	2496	V6	25
07/07→	C-Class C 230 4-matic	M 272.911	Petrol	2496	V6	25
10/95→05/00	C-Class C 230 Kompressor	M 111.975	Petrol	2295	4	37
02/04→02/07	C-Class C 230 Kompressor	M 271.948 (M271 SE18)	Petrol	1796	4	5
06/97→05/00	C-Class C 240	M 112.910	Petrol	2398	V6	12
02/14→	C-Class C 250 BlueTEC	OM 651.921	Diesel	2143	4	11
08/08→	C-Class C 250 CDI	OM 651.911	Diesel	2143	4	11
01/11→	C-Class C 250 CDI 4-matic	OM 651.912	Diesel	2143	4	11
05/93→05/00	C-Class C 250 D	OM 605.910	Diesel	2497	5	20
10/95→05/00	C-Class C 250 Turbo-D	OM 605.960	Diesel	2497	5	21
12/00→02/07	C-Class C 270 CDI	OM 612.962	Diesel	2685	5	26
05/93→05/00	C-Class C 280	M 104.941	Petrol	2799	6	35
06/97→05/00	C-Class C 280	M 112.920	Petrol	2799	V6	36
01/05→02/07	C-Class C 280	M 272.940	Petrol	2996	V6	25
01/07→	C-Class C 280	M 272.947	Petrol	2996	V6	25
01/05→02/07	C-Class C 280 4-matic	M 272.941	Petrol	2996	V6	25
07/07→	C-Class C 280 4-matic	M 272.948	Petrol	2996	V6	25
07/09→	C-Class C 300	M 272.947	Petrol	2996	V6	25
07/07→	C-Class C 300 4-matic	M 272.948	Petrol	2996	V6	25
01/11→	C-Class C 300 CDI 4-matic	OM 642.832	Diesel	2987	V6	10
05/00→02/07	C-Class C 320	M 112.946	Petrol	3199	V6	36
01/05→02/07	C-Class C 320 CDI	OM 642.910	Diesel	2987	6	10
01/07→	C-Class C 320 CDI	OM 642.960	Diesel	2987	V6	10
07/07→	C-Class C 320 CDI 4-matic	OM 642.961	Diesel	2987	V6	10
10/09→	C-Class C 350 CDI	OM 642.830	Diesel	2987	V6	10
06/11→	C-Class C 350 CDI	OM 642.834	Diesel	2987	V6	10
07/09→	C-Class C 350 CDI	OM 642.960	Diesel	2987	V6	10
10/09→	C-Class C 350 CDI 4-matic	OM 642.832	Diesel	2987	V6	10
07/09→	C-Class C 350 CDI 4-matic	OM 642.961	Diesel	2987	V6	10
05/02→05/08	C-Class Coupe C 160 Kompressor	M 271.921	Petrol	1796	4	5
03/01→05/02	C-Class Coupe C 180	M 111.951	Petrol	1998	4	35
05/02→05/08	C-Class Coupe C 180 Kompressor	M 271.946 (M271 SE18)	Petrol	1796	4	5
03/03→05/08	C-Class Coupe C 200 CDI	OM 646.962	Diesel	2148	4	28
03/03→05/08	C-Class Coupe C 200 CGI Kompressor	M 271.942 (M271 DE18)	Petrol	1796	4	6
03/01→05/02	C-Class Coupe C 200 Kompressor	M 111.955	Petrol	1998	4	35
05/02→05/08	C-Class Coupe C 200 Kompressor	M 271.940 (M271 SE18)	Petrol	1796	4	5
05/02→05/08	C-Class Coupe C 220	M 271.940 (M271 SE18)	Petrol	1796	4	5
03/01→05/08	C-Class Coupe C 220 CDI	OM 611.962	Diesel	2148	4	26
02/04→05/08	C-Class Coupe C 220 CDI	OM 646.963	Diesel	2148	4	28
06/11→	C-Class Coupe C 220 CDI	OM 651.911	Diesel	2143	4	11
01/05→05/08	C-Class Coupe C 230	M 272.920	Petrol	2496	V6	25
03/01→05/02	C-Class Coupe C 230 Kompressor	M 111.981	Petrol	2295	4	37
05/02→05/08	C-Class Coupe C 230 Kompressor	M 271.948 (M271 SE18)	Petrol	1796	4	5

MODEL INDEX

Modelverzeichnis • Index de modele • Índice de Modelo
Indeks modelu • Модель автомобиля • دليل الموديل



CCM

x



9

06/11→	C-Class Coupe C 250 CDI	OM 651.911	Diesel	2143	4	11
09/02→05/08	C-Class Coupe C 320	M 112.946	Petrol	3199	V6	36
08/97→03/01	C-Class Estate C 43 AMG	M 113.944	Petrol	4266	V8	36
06/96→09/00	C-Class Estate C 180 T	M 111.920	Petrol	1799	4	14
06/96→09/00	C-Class Estate C 180 T	M 111.921	Petrol	1799	4	14
09/00→03/01	C-Class Estate C 180 T	M 111.952	Petrol	1998	4	35
06/96→03/01	C-Class Estate C 200 T	M 111.941	Petrol	1998	4	35
06/96→03/01	C-Class Estate C 200 T	M 111.945	Petrol	1998	4	35
03/98→03/01	C-Class Estate C 200 T CDI	OM 611.960	Diesel	2148	4	26
10/96→03/01	C-Class Estate C 200 T D	OM 604.915	Diesel	1997	4	20
11/96→03/01	C-Class Estate C 200 T Kompressor	M 111.944	Petrol	1998	4	35
09/00→03/01	C-Class Estate C 200 T Kompressor	M 111.956	Petrol	1998	4	35
09/97→03/01	C-Class Estate C 220 T CDI	OM 611.960	Diesel	2148	4	26
06/96→03/01	C-Class Estate C 220 T D	OM 604.910	Diesel	2155	4	34
06/96→09/98	C-Class Estate C 220 T D	OM 604.910	Diesel	2155	4	34
06/96→06/98	C-Class Estate C 230 T	M 111.974	Petrol	2295	4	37
06/97→09/00	C-Class Estate C 230 T Kompressor	M 111.975	Petrol	2295	4	37
06/97→09/00	C-Class Estate C 240 T	M 112.910	Petrol	2398	V6	12
06/96→03/01	C-Class Estate C 250 T Turbo-D	OM 605.960	Diesel	2497	5	21
06/97→03/01	C-Class Estate C 280 T	M 112.920	Petrol	2799	V6	36
03/01→05/02	C-Class T-Model C 180	M 111.951	Petrol	1998	4	35
01/11→	C-Class T-Model C 180 CDI	OM 651.913	Diesel	2143	4	11
01/08→	C-Class T-Model C 180 Kompressor	M 271.910	Petrol	1597	4	5
05/02→08/07	C-Class T-Model C 180 Kompressor	M 271.946 (M271 SE18)	Petrol	1796	4	5
08/07→	C-Class T-Model C 180 Kompressor	M 271.952	Petrol	1796	4	5
03/01→08/07	C-Class T-Model C 200 CDI	OM 611.962	Diesel	2148	4	26
08/07→	C-Class T-Model C 200 CDI	OM 646.811	Diesel	2148	4	27
03/01→08/07	C-Class T-Model C 200 CDI	OM 646.962	Diesel	2148	4	28
04/03→08/07	C-Class T-Model C 200 CDI	OM 646.962	Diesel	2148	4	28
08/10→	C-Class T-Model C 200 CDI	OM 651.913	Diesel	2143	4	11
07/03→08/07	C-Class T-Model C 200 CGI Kompressor	M 271.942 (M271 DE18)	Petrol	1796	4	6
03/01→05/02	C-Class T-Model C 200 Kompressor	M 111.955	Petrol	1998	4	35
05/02→08/07	C-Class T-Model C 200 Kompressor	M 271.940 (M271 SE18)	Petrol	1796	4	5
08/07→	C-Class T-Model C 200 Kompressor	M 271.950	Petrol	1796	4	5
03/01→08/07	C-Class T-Model C 220 CDI	OM 611.962	Diesel	2148	4	26
08/07→	C-Class T-Model C 220 CDI	OM 646.811	Diesel	2148	4	27
02/04→08/07	C-Class T-Model C 220 CDI	OM 646.963	Diesel	2148	4	28
12/08→	C-Class T-Model C 220 CDI	OM 651.911	Diesel	2143	4	11
02/13→	C-Class T-Model C 220 CDI 4-matic	OM 651.912	Diesel	2143	4	11
01/05→08/07	C-Class T-Model C 230	M 272.920	Petrol	2496	V6	25
08/07→	C-Class T-Model C 230	M 272.921	Petrol	2496	V6	25
02/04→08/07	C-Class T-Model C 230 Kompressor	M 271.948 (M271 SE18)	Petrol	1796	4	5
01/09→	C-Class T-Model C 250 CDI	OM 651.911	Diesel	2143	4	11
04/10→	C-Class T-Model C 250 CDI 4-matic	OM 651.912	Diesel	2143	4	11
03/01→08/07	C-Class T-Model C 270 CDI	OM 612.962	Diesel	2685	5	26
01/05→08/07	C-Class T-Model C 280	M 272.940	Petrol	2996	V6	25
08/07→	C-Class T-Model C 280	M 272.947	Petrol	2996	V6	25
01/05→08/07	C-Class T-Model C 280 4-matic	M 272.941	Petrol	2996	V6	25
08/07→	C-Class T-Model C 300	M 272.947	Petrol	2996	V6	25
03/01→08/07	C-Class T-Model C 320	M 112.946	Petrol	3199	V6	36
06/05→08/07	C-Class T-Model C 320 CDI	OM 642.910	Diesel	2987	6	10
08/07→	C-Class T-Model C 320 CDI	OM 642.960	Diesel	2987	V6	10
08/07→	C-Class T-Model C 320 CDI 4-matic	OM 642.961	Diesel	2987	V6	10
08/07→	C-Class T-Model C 350 CDI	OM 642.830	Diesel	2987	V6	10
10/09→	C-Class T-Model C 350 CDI	OM 642.830	Diesel	2987	V6	10
06/11→	C-Class T-Model C 350 CDI	OM 642.834	Diesel	2987	V6	10
10/09→	C-Class T-Model C 350 CDI 4-matic	OM 642.832	Diesel	2987	V6	10
01/13→	CLA Coupe CLA 220 CDI	OM 651.930	Diesel	2143	4	11
05/08→	CLC 200	M 271.957	Petrol	1796	4	5
02/09→06/11	CLC-Class CLC 160	M 271.911	Petrol	1597	4	5



CCM

x



9

05/08→06/11	CLC-Class CLC 180 Kompressor	M 271.946 (M271 SE18)	Petrol	1796	4	5
05/08→06/11	CLC-Class CLC 200 CDI	OM 646.962	Diesel	2148	4	28
05/08→06/11	CLC-Class CLC 200 Kompressor	M 271.955	Petrol	1796	4	5
05/08→06/11	CLC-Class CLC 220 CDI	OM 646.963	Diesel	2148	4	28
05/08→06/11	CLC-Class CLC 230	M 272.920	Petrol	2496	V6	25
10/98→07/02	CLK 5.4	M 113.984	Petrol	5439	V8	50
08/99→06/02	CLK 55 AMG	M 113.981	Petrol	5439	V8	50
08/99→06/02	CLK 55 AMG	M 113.984	Petrol	5439	V8	50
06/97→06/02	CLK 200	M 111.945	Petrol	1998	4	35
07/03→05/09	CLK 200 CGI	M 271.942 (M271 DE18)	Petrol	1796	4	6
06/97→06/00	CLK 200 Kompressor	M 111.944	Petrol	1998	4	35
06/00→06/02	CLK 200 Kompressor	M 111.956	Petrol	1998	4	35
09/02→05/09	CLK 200 Kompressor	M 271.940 (M271 SE18)	Petrol	1796	4	5
10/06→05/09	CLK 200 Kompressor	M 271.955	Petrol	1796	4	5
01/05→05/09	CLK 220 CDI	OM 646.966	Diesel	2148	4	27
06/97→06/00	CLK 230 Kompressor	M 111.973	Petrol	2295	4	37
06/97→06/00	CLK 230 Kompressor	M 111.975	Petrol	2295	4	37
06/00→06/02	CLK 230 Kompressor	M 111.982	Petrol	2295	4	37
10/02→05/09	CLK 270 CDI	OM 612.962	Diesel	2685	5	26
02/03→06/05	CLK 270 CDI	OM 612.967	Diesel	2685	5	26
10/02→05/09	CLK 270 CDI	OM 612.967	Diesel	2685	5	26
01/05→05/09	CLK 280	M 272.940	Petrol	2996	V6	25
06/97→06/02	CLK 320	M 112.940	Petrol	3199	V6	36
01/05→05/09	CLK 320 CDI	OM 642.910	Diesel	2987	6	10
07/98→06/02	CLK 430	M 113.943	Petrol	4266	V8	36
06/02→05/09	CLK 500	M 113.968	Petrol	4966	V8	50
01/00→03/02	CLK Convertible 55 AMG	M 113.981	Petrol	5439	V8	50
01/00→03/02	CLK Convertible 55 AMG	M 113.984	Petrol	5439	V8	50
03/98→03/02	CLK Convertible 200	M 111.941	Petrol	1998	4	35
03/98→03/02	CLK Convertible 200	M 111.945	Petrol	1998	4	35
03/98→06/00	CLK Convertible 200 Kompressor	M 111.944	Petrol	1998	4	35
06/00→03/02	CLK Convertible 200 Kompressor	M 111.956	Petrol	1998	4	35
03/98→06/00	CLK Convertible 230 Kompressor	M 111.973	Petrol	2295	4	37
03/98→06/00	CLK Convertible 230 Kompressor	M 111.975	Petrol	2295	4	37
06/00→03/02	CLK Convertible 230 Kompressor	M 111.982	Petrol	2295	4	37
03/98→03/02	CLK Convertible 320	M 112.940	Petrol	3199	V6	36
09/98→03/02	CLK Convertible 430	M 113.943	Petrol	4266	V8	36
07/03→03/10	CLK Convertible CLK 200 CGI	M 271.942 (M271 DE18)	Petrol	1796	4	6
02/03→03/10	CLK Convertible CLK 200 Kompressor	M 271.940 (M271 SE18)	Petrol	1796	4	5
10/06→03/10	CLK Convertible CLK 200 Kompressor	M 271.955	Petrol	1796	4	5
01/05→03/10	CLK Convertible CLK 280	M 272.940	Petrol	2996	V6	25
03/05→03/10	CLK Convertible CLK 320 CDI	OM 642.910	Diesel	2987	6	10
02/03→03/10	CLK Convertible CLK 500	M 113.968	Petrol	4966	V8	50
07/08→12/10	CLS 280	M 272.944	Petrol	2996	V6	25
04/09→12/10	CLS 300	M 272.944	Petrol	2996	V6	25
04/11→	CLS CLS 250 CDI	OM 651.924	Diesel	2143	4	11
07/08→12/10	CLS CLS 280	M 272.943	Petrol	2996	V6	25
04/09→12/10	CLS CLS 300	M 272.943	Petrol	2996	V6	25
01/05→12/10	CLS CLS 320 CDI	OM 642.920	Diesel	2987	V6	10
11/12→	CLS CLS 350 BlueTEC	OM 642.852	Diesel	2987	V6	10
11/12→	CLS CLS 350 BlueTEC 4-matic	OM 642.858	Diesel	2987	V6	10
01/11→	CLS CLS 350 CDI	OM 642.853	Diesel	2987	V6	10
04/09→12/10	CLS CLS 350 CDI	OM 642.920	Diesel	2987	V6	10
09/11→	CLS CLS 350 CDI 4-matic	OM 642.854 (OM 642 LS DE 30 LA)	Diesel	2987	V6	10
10/04→12/10	CLS CLS 500	M 113.967	Petrol	4966	V8	50
10/12→	CLS Shooting Brake CLS 250 CDI	OM 651.924	Diesel	2143	4	11
10/12→	CLS Shooting Brake CLS 350 CDI	OM 642.853	Diesel	2987	V6	10
10/12→	CLS Shooting Brake CLS 350 CDI 4-matic	OM 642.854 (OM 642 LS DE 30 LA)	Diesel	2987	V6	10
10/92→05/93	Coupe 220 CE	M 111.960	Petrol	2199	4	35
05/77→04/80	Coupe 230 C	M 115.954	Petrol	2308	4	46

MODEL INDEX

Modelverzeichnis • Index de modele • Índice de Modelo
Indeks modelu • Модель автомобиля • دليل الموديل



CCM



9

04/80→12/85	Coupe 230 CE	M 102.980	Petrol	2299	4	47
03/87→12/92	Coupe 230 CE	M 102.982	Petrol	2299	4	47
06/89→12/92	Coupe 230 CE	M 102.982	Petrol	2299	4	47
03/77→03/80	Coupe 280 C	M 110.923	Petrol	2746	6	15
03/77→11/85	Coupe 280 CE	M 110.988	Petrol	2746	6	15
09/77→08/79	Coupe 280 CE	M 110.988	Petrol	2746	6	15
01/67→12/71	Coupe 280 SE	M 130.980	Petrol	2750	6	17
01/67→12/71	Coupe 280 SE	M 130.984	Petrol	2778	6	17
01/69→12/71	Coupe 280 SE 3.5	M 116.980	Petrol	3499	V8	43
09/81→07/85	Coupe 300 C Turbo-D	OM 617.952	Diesel	2998	5	38
03/87→05/93	Coupe 300 CE	M 103.983	Petrol	2962	6	30
03/87→12/89	Coupe 300 CE	M 103.983	Petrol	2962	6	30
09/89→12/92	Coupe 300 CE-24	M 104.980	Petrol	2960	6	31
10/92→05/93	Coupe 320 CE	M 104.992	Petrol	3199	6	35
06/93→03/98	E-Class Convertible E 200	M 111.940	Petrol	1998	4	35
06/93→03/98	E-Class Convertible E 220	M 111.960	Petrol	2199	4	35
01/10→	E-Class Convertible E 220 CDI	OM 651.911	Diesel	2143	4	11
01/10→	E-Class Convertible E 250 CDI	OM 651.911	Diesel	2143	4	11
06/93→03/98	E-Class Convertible E 320	M 104.992	Petrol	3199	6	35
06/93→03/98	E-Class Convertible E 320	M 104.995	Petrol	3199	6	35
01/10→	E-Class Convertible E 350 CDI	OM 642.836	Diesel	2987	V6	10
06/93→06/97	E-Class Coupe E 200	M 111.940	Petrol	1998	4	35
06/93→06/97	E-Class Coupe E 220	M 111.960	Petrol	2199	4	35
01/10→	E-Class Coupe E 220 CDI	OM 651.911	Diesel	2143	4	11
01/09→	E-Class Coupe E 250 CDI	OM 651.911	Diesel	2143	4	11
06/93→06/97	E-Class Coupe E 320	M 104.992	Petrol	3199	6	35
01/09→	E-Class Coupe E 350 CDI	OM 642.836	Diesel	2987	V6	10
08/97→03/02	E-Class E 55 AMG	M 113.980	Petrol	5439	V8	50
03/01→03/02	E-Class E 55 AMG 4-matic	M 113.980	Petrol	5439	V8	50
06/93→06/95	E-Class E 200	M 111.940	Petrol	1998	4	35
06/95→08/00	E-Class E 200	M 111.942	Petrol	1998	4	35
06/98→03/02	E-Class E 200 CDI	OM 611.961	Diesel	2148	4	26
07/99→03/02	E-Class E 200 CDI	OM 611.961	Diesel	2148	4	26
04/06→12/08	E-Class E 200 CDI	OM 646.820	Diesel	2148	4	27
07/02→12/08	E-Class E 200 CDI	OM 646.951	Diesel	2148	4	28
01/09→	E-Class E 200 CDI	OM 651.925	Diesel	2143	4	11
11/02→12/08	E-Class E 200 CGI	M 271.946 (M271 SE18)	Petrol	1796	4	5
06/93→06/95	E-Class E 200 D	OM 601.912	Diesel	1978	4	19
01/96→03/02	E-Class E 200 D	OM 604.917	Diesel	1997	4	20
06/97→03/02	E-Class E 200 Kompressor	M 111.947	Petrol	1998	4	35
08/00→03/02	E-Class E 200 Kompressor	M 111.957	Petrol	1998	4	35
11/02→12/08	E-Class E 200 Kompressor	M 271.941 (M271 SE18)	Petrol	1796	4	5
04/06→12/08	E-Class E 200 Kompressor	M 271.956	Petrol	1796	4	5
03/04→12/08	E-Class E 200 NGT	M 271.941 (M271 SE18)	Petrol	1796	4	5
03/11→	E-Class E 200 NGT	M 271.958	Bi-fuel (Petrol/ Gas)	1796	4	5
06/93→06/95	E-Class E 220	M 111.960	Petrol	2199	4	35
06/98→07/99	E-Class E 220 CDI	OM 611.961	Diesel	2148	4	26
07/99→03/02	E-Class E 220 CDI	OM 611.961	Diesel	2148	4	26
03/03→12/08	E-Class E 220 CDI	OM 646.821	Diesel	2148	4	27
04/06→12/08	E-Class E 220 CDI	OM 646.821	Diesel	2148	4	27
03/02→12/08	E-Class E 220 CDI	OM 646.961	Diesel	2148	4	28
01/09→	E-Class E 220 CDI	OM 651.924	Diesel	2143	4	11
01/09→	E-Class E 220 CDI / BlueTEC	OM 651.924	Diesel	2143	4	11
05/96→03/02	E-Class E 220 D	OM 604.912	Diesel	2155	4	34
06/95→07/99	E-Class E 220 D	OM 604.912	Diesel	2155	4	34
06/95→06/97	E-Class E 230	M 111.970	Petrol	2295	4	37
09/07→12/08	E-Class E 230	M 272.922	Petrol	2496	V6	25
06/97→08/00	E-Class E 240	M 112.911	Petrol	2398	V6	12



CCM

x



9

01/09→	E-Class E 250 CDI	OM 651.924	Diesel	2143	4	11
08/08→12/08	E-Class E 250 CDI	OM 651.924	Diesel	2143	4	11
01/09→	E-Class E 250 CDI 4-matic	OM 651.924	Diesel	2143	4	11
07/93→06/95	E-Class E 250 D	OM 605.911	Diesel	2497	5	20
06/95→07/99	E-Class E 250 D	OM 605.912	Diesel	2497	5	20
06/93→06/95	E-Class E 250 Turbo-D	OM 602A.962	Diesel	2497	5	21
06/97→07/99	E-Class E 250 Turbo-D	OM 605.962	Diesel	2497	5	21
07/99→03/02	E-Class E 270 CDI	OM 612.961	Diesel	2688	5	26
03/02→12/08	E-Class E 270 CDI	OM 647.961	Diesel	2685	5	28
06/93→06/95	E-Class E 280	M 104.942	Petrol	2799	6	35
01/96→06/97	E-Class E 280	M 104.945	Petrol	2799	6	35
12/96→03/02	E-Class E 280	M 112.921	Petrol	2799	V6	36
03/05→12/08	E-Class E 280	M 272.943	Petrol	2996	V6	25
03/05→12/08	E-Class E 280	M 272.944	Petrol	2996	V6	25
12/96→03/02	E-Class E 280 4-matic	M 112.921	Petrol	2799	V6	36
01/06→12/08	E-Class E 280 4-matic	M 272.943	Petrol	2996	V6	25
01/06→12/08	E-Class E 280 4-matic	M 272.944	Petrol	2996	V6	25
03/05→12/08	E-Class E 280 CDI	OM 642.920	Diesel	2987	V6	10
05/04→12/08	E-Class E 280 CDI	OM 648.961	Diesel	3222	6	28
03/05→12/08	E-Class E 280 CDI 4-matic	OM 642.921	Diesel	2987	V6	10
03/96→07/99	E-Class E 290 Turbo-D	OM 602.982	Diesel	2874	5	34
01/09→	E-Class E 300	M 272.952	Petrol	2996	V6	25
06/93→06/95	E-Class E 300 4-matic	M 103.985	Petrol	2962	6	30
09/07→12/08	E-Class E 300 BlueTEC	OM 642.920	Diesel	2987	V6	10
03/11→	E-Class E 300 CDI	OM 642.850	Diesel	2987	V6	10
03/11→	E-Class E 300 CDI	OM 642.852	Diesel	2987	V6	10
07/93→06/95	E-Class E 300 D	OM 606.910	Diesel	2996	6	20
06/95→06/97	E-Class E 300 D	OM 606.912	Diesel	2996	6	20
12/11→	E-Class E 300 Hybrid /BlueTEC Hybrid	OM 651.924	Diesel	2143	4	11
06/93→06/95	E-Class E 300 Turbo-D	OM 603A.960	Diesel	2996	6	21
12/96→07/99	E-Class E 300 Turbo-D	OM 606.962	Diesel	2996	6	21
06/93→06/95	E-Class E 300 Turbo-D 4-matic	OM 603A.963	Diesel	2996	6	21
06/93→06/95	E-Class E 320	M 104.992	Petrol	3199	6	35
06/95→06/97	E-Class E 320	M 104.995	Petrol	3199	6	35
06/97→03/02	E-Class E 320	M 112.941	Petrol	3199	V6	36
03/02→12/08	E-Class E 320	M 112.949	Petrol	3199	V6	36
06/97→03/02	E-Class E 320 4-matic	M 112.941	Petrol	3199	V6	36
07/99→03/02	E-Class E 320 CDI	OM 613.961	Diesel	3226	6	26
03/05→12/08	E-Class E 320 CDI	OM 642.920	Diesel	2987	V6	10
11/02→12/08	E-Class E 320 CDI	OM 648.961	Diesel	3222	6	28
03/05→12/08	E-Class E 320 CDI 4-matic	OM 642.910	Diesel	2987	6	10
01/09→	E-Class E 350 BlueTEC	OM 642.850	Diesel	2987	V6	10
11/12→	E-Class E 350 BlueTEC	OM 642.852	Diesel	2987	V6	10
11/12→	E-Class E 350 BlueTEC 4-matic	OM 642.852	Diesel	2987	V6	10
11/12→	E-Class E 350 BlueTEC 4-matic	OM 642.858	Diesel	2987	V6	10
01/09→	E-Class E 350 CDI	OM 642.850	Diesel	2987	V6	10
03/11→	E-Class E 350 CDI	OM 642.852	Diesel	2987	V6	10
09/09→	E-Class E 350 CDI 4-matic	OM 642.856	Diesel	2987	V6	10
03/11→	E-Class E 350 CDI 4-matic	OM 642.858	Diesel	2987	V6	10
02/03→12/08	E-Class E 400 CDI	OM 628.961	Diesel	3996	V8	16
06/93→06/95	E-Class E 420	M 119.975	Petrol	4196	V8	45
01/96→06/97	E-Class E 420	M 119.985	Petrol	4196	V8	45
06/97→03/02	E-Class E 430	M 113.940	Petrol	4266	V8	36
05/99→03/02	E-Class E 430 4-matic	M 113.940	Petrol	4266	V8	36
03/02→12/08	E-Class E 500	M 113.967	Petrol	4966	V8	50
06/93→06/95	E-Class E 500	M 119.974	Petrol	4973	V8	49
10/03→12/08	E-Class E 500 4-matic	M 113.969	Petrol	4966	V8	50
08/97→03/03	E-Class Estate E 55 T AMG	M 113.980	Petrol	5439	V8	50
03/01→03/03	E-Class Estate E 55 T AMG 4-matic	M 113.980	Petrol	5439	V8	50
06/93→06/96	E-Class Estate E 200 T	M 111.940	Petrol	1998	4	35

MODEL INDEX

Modelverzeichnis • Index de modele • Índice de Modelo
Indeks modelu • Модель автомобиля • دليل المحرك



CCM

x



9

06/96→08/00	E-Class Estate E 200 T	M 111.942	Petrol	1998	4	35
06/97→03/03	E-Class Estate E 200 T Kompressor	M 111.947	Petrol	1998	4	35
08/00→03/03	E-Class Estate E 200 T Kompressor	M 111.957	Petrol	1998	4	35
06/93→06/96	E-Class Estate E 220 T	M 111.960	Petrol	2199	4	35
06/98→07/99	E-Class Estate E 220 T CDI	OM 611.961	Diesel	2148	4	26
07/99→03/03	E-Class Estate E 220 T CDI	OM 611.961	Diesel	2148	4	26
06/96→06/97	E-Class Estate E 230 T	M 111.970	Petrol	2295	4	37
06/97→03/03	E-Class Estate E 240 T	M 112.911	Petrol	2398	V6	12
06/93→06/96	E-Class Estate E 250 T D	OM 605.911	Diesel	2497	5	20
06/96→07/99	E-Class Estate E 250 T D	OM 605.912	Diesel	2497	5	20
06/97→07/99	E-Class Estate E 250 T Turbo-D	OM 605.962	Diesel	2497	5	21
06/93→06/96	E-Class Estate E 250 Turbo D	OM 602A.962	Diesel	2497	5	21
02/00→03/03	E-Class Estate E 270 T CDI	OM 612.961	Diesel	2688	5	26
07/99→03/03	E-Class Estate E 270 T CDI	OM 612.961	Diesel	2688	5	26
06/93→06/96	E-Class Estate E 280 T	M 104.942	Petrol	2799	6	35
12/96→03/03	E-Class Estate E 280 T	M 112.921	Petrol	2799	V6	36
12/96→03/03	E-Class Estate E 280 T 4-matic	M 112.921	Petrol	2799	V6	36
06/96→07/99	E-Class Estate E 290 T Turbo-D	OM 602.982	Diesel	2874	5	34
06/93→06/96	E-Class Estate E 300 T 4-matic	M 103.985	Petrol	2962	6	30
06/93→06/96	E-Class Estate E 300 T D	OM 606.910	Diesel	2996	6	20
06/93→06/96	E-Class Estate E 300 T Turbo-D	OM 603A.960	Diesel	2996	6	21
12/96→07/99	E-Class Estate E 300 T Turbo-D	OM 606.962	Diesel	2996	6	21
06/93→06/96	E-Class Estate E 300 T Turbo-D 4-matic	OM 603A.963	Diesel	2996	6	21
06/93→06/96	E-Class Estate E 300 TE-24 AMG	M 104.980	Petrol	2960	6	31
06/93→06/96	E-Class Estate E 320 T	M 104.992	Petrol	3199	6	35
12/96→03/03	E-Class Estate E 320 T	M 112.941	Petrol	3199	V6	36
12/96→03/03	E-Class Estate E 320 T 4-matic	M 112.941	Petrol	3199	V6	36
07/99→03/03	E-Class Estate E 320 T CDI	OM 613.961	Diesel	3226	6	26
06/96→06/97	E-Class Estate E 420 T	M 119.985	Petrol	4196	V8	45
06/97→03/03	E-Class Estate E 430 T	M 113.940	Petrol	4266	V8	36
05/99→03/03	E-Class Estate E 430 T 4-matic	M 113.940	Petrol	4266	V8	36
04/06→07/09	E-Class T-Model E 200 CDI	OM 646.821	Diesel	2148	4	27
11/09→	E-Class T-Model E 200 CDI	OM 651.925	Diesel	2143	4	11
04/06→07/09	E-Class T-Model E 200 Kompressor	M 271.956	Petrol	1796	4	5
03/03→07/09	E-Class T-Model E 200 T Kompressor	M 271.941 (M271 SE18)	Petrol	1796	4	5
03/03→07/09	E-Class T-Model E 220 CDI	OM 646.961	Diesel	2148	4	28
11/09→	E-Class T-Model E 220 CDI	OM 651.924	Diesel	2143	4	11
03/03→07/09	E-Class T-Model E 220 T CDI	OM 646.821	Diesel	2148	4	27
04/06→07/09	E-Class T-Model E 220 T CDI	OM 646.821	Diesel	2148	4	27
03/03→07/09	E-Class T-Model E 220 T CDI	OM 646.961	Diesel	2148	4	28
05/07→07/09	E-Class T-Model E 230 T	M 272.922	Petrol	2496	V6	25
11/09→	E-Class T-Model E 250 CDI	OM 651.924	Diesel	2143	4	11
07/10→	E-Class T-Model E 250 CDI 4-matic	OM 651.924	Diesel	2143	4	11
03/03→07/09	E-Class T-Model E 270 T CDI	OM 647.961	Diesel	2685	5	28
03/05→07/09	E-Class T-Model E 280 T	M 272.943	Petrol	2996	V6	25
03/05→07/09	E-Class T-Model E 280 T 4-matic	M 272.943	Petrol	2996	V6	25
03/05→07/09	E-Class T-Model E 280 T CDI	OM 642.920	Diesel	2987	V6	10
05/04→07/09	E-Class T-Model E 280 T CDI	OM 648.961	Diesel	3222	6	28
03/05→07/09	E-Class T-Model E 280 T CDI 4-matic	OM 642.921	Diesel	2987	V6	10
03/05→07/09	E-Class T-Model E 280 T	M 272.944	Petrol	2996	V6	25
03/05→07/09	E-Class T-Model E 280 T 4-matic	M 272.944	Petrol	2996	V6	25
11/09→	E-Class T-Model E 300	M 272.952	Petrol	2996	V6	25
03/11→	E-Class T-Model E 300 CDI	OM 642.850	Diesel	2987	V6	10
11/09→	E-Class T-Model E 300 CDI	OM 642.850	Diesel	2987	V6	10
12/11→	E-Class T-Model E 300 Hybrid	OM 651.924	Diesel	2143	4	11
03/03→07/09	E-Class T-Model E 320 T	M 112.949	Petrol	3199	V6	36
03/05→07/09	E-Class T-Model E 320 T CDI	OM 642.920	Diesel	2987	V6	10
03/03→07/09	E-Class T-Model E 320 T CDI	OM 648.961	Diesel	3222	6	28
03/05→07/09	E-Class T-Model E 320 T CDI 4-matic	OM 642.920	Diesel	2987	V6	10
11/09→	E-Class T-Model E 350 BlueTEC	OM 642.850	Diesel	2987	V6	10



CCM

x



9

11/12→	E-Class T-Model E 350 BlueTEC	OM 642.852	Diesel	2987	V6	10
11/12→	E-Class T-Model E 350 BlueTEC 4-matic	OM 642.858	Diesel	2987	V6	10
11/09→	E-Class T-Model E 350 CDI	OM 642.850	Diesel	2987	V6	10
07/11→	E-Class T-Model E 350 CDI	OM 642.852	Diesel	2987	V6	10
11/09→	E-Class T-Model E 350 CDI 4-matic	OM 642.856	Diesel	2987	V6	10
07/11→	E-Class T-Model E 350 CDI 4-matic	OM 642.858	Diesel	2987	V6	10
10/03→07/09	E-Class T-Model E 500 T	M 113.967	Petrol	4966	V8	50
10/03→07/09	E-Class T-Model E 500 T 4-matic	M 113.969	Petrol	4966	V8	50
01/90→07/93	G-Class 200 GE	M 102.965	Petrol	1996	4	32
02/80→07/87	G-Class 230 G	M 115.973	Petrol	2308	4	46
03/79→07/93	G-Class 230 G	M 115.973	Petrol	2308	4	46
02/93→	G-Class 230 GE	M 102.979	Petrol	2299	4	47
05/87→08/92	G-Class 230 GE	M 102.979	Petrol	2299	4	47
04/82→08/92	G-Class 230 GE	M 102.981	Petrol	2299	4	47
04/82→08/92	G-Class 230 GE	M 102.987	Petrol	2299	4	47
05/87→08/92	G-Class 230 GE	M 102.987	Petrol	2299	4	47
04/82→08/92	G-Class 230 GE	M 102.989	Petrol	2299	4	47
06/90→06/93	G-Class 230 GE	M 102.989	Petrol	2299	4	47
06/93→	G-Class 230 GE	M 102.996	Petrol	2299	4	47
06/93→	G-Class 230 GE	M 102.997	Petrol	2299	4	47
03/79→08/87	G-Class 240 GD	OM 616.936	Diesel	2399	4	38
03/79→08/87	G-Class 240 GD	OM 616.938	Diesel	2399	4	38
10/87→12/92	G-Class 250 GD	OM 602.930	Diesel	2497	5	19
12/88→08/92	G-Class 250 GD	OM 602.930	Diesel	2497	5	19
06/90→	G-Class 250 GD	OM 602.931	Diesel	2497	5	20
06/90→	G-Class 250 GD	OM 602.938	Diesel	2497	5	20
02/90→	G-Class 250 GD	OM 602.939	Diesel	2497	5	20
04/92→	G-Class 290 GD/G 290 D	OM 602.942	Diesel	2874	5	34
04/92→	G-Class 290 GD/G 290 D	OM 602.946	Diesel	2874	5	34
04/92→	G-Class 290 GD/G 290 D	OM 602.947	Diesel	2874	5	34
03/79→07/93	G-Class 300 GD	OM 603.912	Diesel	2996	6	19
09/89→	G-Class 300 GD	OM 603.931	Diesel	2996	6	20
12/79→12/91	G-Class 300 GD	OM 617.931	Diesel	2998	5	38
12/79→12/91	G-Class 300 GD	OM 617.932	Diesel	2998	5	38
06/90→	G-Class 300 GE	M 103.987	Petrol	2962	6	30
09/91→	G-Class 350 Turbo GD	OM 603A.972	Diesel	3449	6	34
01/90→07/93	G-Class Cabrio 200 GE	M 102.965	Petrol	1996	4	32
06/90→02/93	G-Class Cabrio 230 GE	M 102.989	Petrol	2299	4	47
12/90→09/97	G-Class Cabrio 300 GD	OM 603.931	Diesel	2996	6	20
09/89→09/97	G-Class Cabrio 300 GE	M 103.987	Petrol	2962	6	30
09/94→11/97	G-Class Cabrio 320 GE	M 104.996	Petrol	3199	6	35
09/91→09/97	G-Class Cabrio 350 G Turbo-D	OM 603A.972	Diesel	3449	6	34
09/96→	G-Class Cabrio G 300 TD	OM 606.964	Diesel	2996	6	21
11/97→	G-Class Cabrio G 320	M 112.945	Petrol	3199	V6	36
09/06→	G-Class Cabrio G 320 CDI	OM 642.970	Diesel	2987	V6	10
07/11→	G-Class Cabrio G 350 CDI	OM 642.886	Diesel	2987	V6	10
12/00→	G-Class Cabrio G 400 CDI	OM 628.962	Diesel	3996	V8	16
04/98→	G-Class Cabrio G 500	M 113.962	Petrol	4966	V8	50
01/03→	G-Class G 270 CDI	OM 612.966	Diesel	2685	5	26
04/09→	G-Class G 280 CDI	OM 642.884	Diesel	2987	V6	10
07/97→	G-Class G 290 TD	OM 602.983	Diesel	2874	5	34
04/10→	G-Class G 300 CDI	OM 642.884	Diesel	2987	V6	10
08/96→	G-Class G 300 TD	OM 606.964	Diesel	2996	6	21
09/94→12/97	G-Class G 320	M 104.996	Petrol	3199	6	35
07/97→	G-Class G 320	M 112.945	Petrol	3199	V6	36
09/06→	G-Class G 320 CDI	OM 642.970	Diesel	2987	V6	10
07/11→	G-Class G 350 CDI	OM 642.886	Diesel	2987	V6	10
12/00→	G-Class G 400 CDI	OM 628.962	Diesel	3996	V8	16
04/98→	G-Class G 500	M 113.962	Petrol	4966	V8	50
09/06→05/09	GL-Class GL 320 CDI	OM 642.940	Diesel	2987	V6	10

MODEL INDEX

Modelverzeichnis • Index de modele • Índice de Modelo
Indeks modelu • Модель автомобиля • دليل المحرك



CCM

x



9

10/10→	GL-Class GL 350 CDI	OM 642.822	Diesel	2987	V6	10
05/09→	GL-Class GL 350 CDI	OM 642.940	Diesel	2987	V6	10
12/09→	GL-Class GL 350 CDI BlueTEC	OM 642.820	Diesel	2987	V6	10
07/10→	GLK-Class 200 CDI	OM 651.913	Diesel	2143	4	11
07/10→	GLK-Class 200 CDI	OM 651.916	Diesel	2143	4	11
12/08→	GLK-Class 220 CDI	OM 651.916	Diesel	2143	4	11
12/08→	GLK-Class 220 CDI 4-matic	OM 651.912	Diesel	2143	4	11
09/09→	GLK-Class 250 CDI 4-matic	OM 651.912	Diesel	2143	4	11
06/08→06/09	GLK-Class 280 4-matic	M 272.948	Petrol	2996	V6	25
07/09→04/11	GLK-Class 300 4-matic	M 272.948	Petrol	2996	V6	25
06/08→	GLK-Class 320 CDI 4-matic	OM 642.961	Diesel	2987	V6	10
02/10→05/10	GLK-Class 350 CDI 4-matic	OM 642.832	Diesel	2987	V6	10
07/09→01/10	GLK-Class 350 CDI 4-matic	OM 642.832	Diesel	2987	V6	10
04/61→08/65	Heckflosse 190 C	M 121.924	Petrol	1898	4	13
07/65→02/68	Heckflosse 200	M 115.926	Petrol	1988	4	18
02/73→12/77	Henschel 2-T 206 D 2.2	OM 615.917	Diesel	2197	4	22
02/73→12/77	Henschel 2-T 206 D 2.2	OM 615.918 (OM 615)	Diesel	2197	4	22
02/73→12/77	Henschel 2-T 206 D 2.2	OM 615.937 (OM 615)	Diesel	2197	4	22
02/73→12/77	Henschel 2-T 206 D 2.2	OM 615.939 (OM 615)	Diesel	2197	4	22
11/92→05/93	Kombi Estate 200 E	M 102.922	Petrol	1997	4	32
11/80→11/85	Kombi Estate 200 T	M 102.920	Petrol	1997	4	32
01/86→05/90	Kombi Estate 200 T	M 102.922	Petrol	1997	4	32
09/85→08/89	Kombi Estate 200 T	M 102.922	Petrol	1997	4	32
11/80→11/85	Kombi Estate 200 T	M 102.939	Petrol	1997	4	32
09/85→08/91	Kombi Estate 200 T D	OM 601.912	Diesel	1978	4	19
09/88→08/91	Kombi Estate 200 T D	OM 601.912	Diesel	1978	4	19
09/88→12/89	Kombi Estate 200 TE	M 102.962	Petrol	1997	4	32
09/88→08/92	Kombi Estate 200 TE	M 102.963	Petrol	1997	4	32
10/92→06/93	Kombi Estate 200 TE	M 111.940	Petrol	1998	4	35
10/92→05/93	Kombi Estate 220 TE	M 111.960	Petrol	2199	4	35
09/77→03/80	Kombi Estate 230 T	M 115.954	Petrol	2308	4	46
04/80→11/85	Kombi Estate 230 TE	M 102.980	Petrol	2299	4	47
06/89→08/92	Kombi Estate 230 TE	M 102.982	Petrol	2299	4	47
09/85→08/92	Kombi Estate 230 TE	M 102.982	Petrol	2299	4	47
03/79→12/85	Kombi Estate 240 T D	OM 616.912	Diesel	2399/2404	4	39
09/77→02/79	Kombi Estate 240 T D	OM 616.912	Diesel	2399/2404	4	39
05/78→08/82	Kombi Estate 250 T	M 123.921	Petrol	2527	6	15
05/78→10/79	Kombi Estate 250 T	M 123.921	Petrol	2527	6	15
01/89→06/93	Kombi Estate 250 T D	OM 602.912	Diesel	2497	5	19
09/85→06/93	Kombi Estate 250 T D	OM 602.912	Diesel	2497	5	19
03/88→07/93	Kombi Estate 250 TD Turbo	OM 602A.962	Diesel	2497	5	21
09/85→12/89	Kombi Estate 260 TE FGST.	M 103.940	Petrol	2599	6	7
09/89→08/92	Kombi Estate 260 TE FGST.	M 103.940	Petrol	2599	6	7
10/92→06/93	Kombi Estate 280 TE	M 104.942	Petrol	2799	6	35
09/77→11/85	Kombi Estate 280 TE	M 110.988	Petrol	2746	6	15
01/89→06/93	Kombi Estate 300 T D	OM 603.912	Diesel	2996	6	19
09/86→06/93	Kombi Estate 300 T D	OM 603.912	Diesel	2996	6	19
03/79→11/85	Kombi Estate 300 T D	OM 617.912	Diesel	2998	5	39
09/77→10/85	Kombi Estate 300 T D	OM 617.912	Diesel	2998	5	39
01/89→06/93	Kombi Estate 300 T Turbo-D	OM 603A.960	Diesel	2996	6	21
09/86→01/89	Kombi Estate 300 T Turbo-D	OM 603A.960	Diesel	2996	6	21
09/86→01/89	Kombi Estate 300 T Turbo-D	OM 603A.963	Diesel	2996	6	21
10/80→11/85	Kombi Estate 300 T Turbo-D	OM 617.950	Diesel	2998	5	38
10/80→11/85	Kombi Estate 300 T Turbo-D	OM 617.952	Diesel	2998	5	38
01/89→06/93	Kombi Estate 300 T Turbo-D 4-matic	OM 603A.960	Diesel	2996	6	21
09/86→01/89	Kombi Estate 300 T Turbo-D 4-matic	OM 603A.963	Diesel	2996	6	21
06/92→05/93	Kombi Estate 300 TD T	OM 603A.960	Diesel	2996	6	21
01/86→08/92	Kombi Estate 300 TE	M 103.983	Petrol	2962	6	30
01/86→12/89	Kombi Estate 300 TE	M 103.983	Petrol	2962	6	30
09/86→12/89	Kombi Estate 300 TE 4-matic	M 103.983	Petrol	2962	6	30

Modelverzeichnis • Index de modele • Índice de Modelo
Indeks modelu • Модель автомобиля • دليل الموديل

MODEL INDEX



CCM



Year Range	Model Name	Internal Code	Fuel Type	CCM	Power (kW)	Performance
09/86→06/93	Kombi Estate 300 TE 4-matic	M 103.985	Petrol	2962	6	30
09/89→08/92	Kombi Estate 300 TE-24	M 104.980	Petrol	2960	6	31
10/92→06/93	Kombi Estate 320 TE	M 104.992	Petrol	3199	6	35
11/96→	MB 100 2.3	M 161.971	Petrol	2295	4	37
02/00→06/05	M-Class ML 55 AMG	M 113.981	Petrol	5439	V8	50
02/98→06/05	M-Class ML 230	M 111.977	Petrol	2295	4	37
06/11→	M-Class ML 250 CDI BlueTEC 4-matic	OM 651.960	Diesel	2143	4	11
12/99→06/05	M-Class ML 270 CDI	OM 612.963	Diesel	2685	5	26
07/05→07/09	M-Class ML 280 CDI 4-matic	OM 642.940	Diesel	2987	V6	10
02/10→	M-Class ML 300 CDI 4-matic	OM 642.820	Diesel	2987	V6	10
02/10→	M-Class ML 300 CDI 4-matic	OM 642.832	Diesel	2987	V6	10
07/09→	M-Class ML 300 CDI 4-matic	OM 642.940	Diesel	2987	V6	10
02/98→08/02	M-Class ML 320	M 112.942	Petrol	3199	V6	36
07/05→07/09	M-Class ML 320 CDI 4-matic	OM 642.940	Diesel	2987	V6	10
02/03→06/05	M-Class ML 350	M 112.970	Petrol	3724	V6	50
08/02→06/05	M-Class ML 350	M 112.970	Petrol	3724	V6	50
09/09→	M-Class ML 350 CDI 4-matic	OM 642.820	Diesel	2987	V6	10
02/10→	M-Class ML 350 CDI 4-matic	OM 642.832	Diesel	2987	V6	10
07/09→	M-Class ML 350 CDI 4-matic	OM 642.940	Diesel	2987	V6	10
09/01→06/05	M-Class ML 400 CDI	OM 628.963	Diesel	3996	V8	16
02/98→06/05	M-Class ML 430	M 113.942	Petrol	4266	V8	36
09/01→06/05	M-Class ML 500	M 113.964	Petrol	4966	V8	50
09/01→06/05	M-Class ML 500	M 113.965	Petrol	4966	V8	50
07/05→	M-Class ML 500 4-matic	M 113.964	Petrol	4966	V8	50
01/94→	O 100 City	OM 602.940	Diesel	2874	5	34
01/94→	O 100 City	OM 602.940 (OM 602)	Diesel	2874	5	34
01/68→02/89	O 309 O 309 B	M 102.943 (M 102)	Petrol	2299	4	47
01/68→12/74	O 309 O 309 D	OM 615.910 (OM 615)	Diesel	2197	4	23
01/75→12/88	O 309 O 309 D	OM 616.910 (OM 616)	Diesel	2399/2404	4	39
	O 405 O 405 GTZ	OM 602.990 (OM 602)	Diesel	2497	5	20
	O 405 O 405 GTZ	OM 602.991 (OM 602)	Diesel	2874	5	34
	O 405 O 405 GTZ	OM 602.994 (OM 602)	Diesel	2874	5	34
01/68→03/71	Pagode 280 SL	M 130.983	Petrol	2750	6	17
01/53→07/59	Ponton 180 D	OM 636.914 (OM 636)	Diesel	1767	4	2
01/53→07/59	Ponton 180 D	OM 636.930	Diesel	1767	4	2
06/59→12/61	Ponton 190 b	M 121.920	Petrol	1898	4	13
01/07→	R-Class R 280	M 272.945	Petrol	2996	V6	25
05/07→	R-Class R 280 4-matic	M 272.945	Petrol	2996	V6	25
05/06→	R-Class R 280 CDI	OM 642.870	Diesel	2987	V6	10
05/06→	R-Class R 280 CDI	OM 642.872	Diesel	2987	V6	10
05/06→	R-Class R 280 CDI	OM 642.950	Diesel	2987	V6	10
05/06→	R-Class R 280 CDI 4-matic	OM 642.950	Diesel	2987	V6	10
07/09→	R-Class R 300	M 272.945	Petrol	2996	V6	25
07/09→	R-Class R 300 CDI	OM 642.870	Diesel	2987	V6	10
07/09→	R-Class R 300 CDI	OM 642.872	Diesel	2987	V6	10
07/09→	R-Class R 300 CDI	OM 642.950	Diesel	2987	V6	10
07/09→	R-Class R 300 CDI 4-matic	OM 642.950	Diesel	2987	V6	10
01/06→	R-Class R 320 CDI 4-matic	OM 642.870	Diesel	2987	V6	10
01/06→	R-Class R 320 CDI 4-matic	OM 642.950	Diesel	2987	V6	10
01/06→	R-Class R 350 CDI 4-matic	OM 642.870	Diesel	2987	V6	10
08/10→	R-Class R 350 CDI 4-matic	OM 642.872	Diesel	2987	V6	10
01/06→	R-Class R 350 CDI 4-matic	OM 642.950	Diesel	2987	V6	10
07/09→	R-Class R 350 CDI 4-matic	OM 642.950	Diesel	2987	V6	10
01/06→	R-Class R 500 4-matic	M 113.971	Petrol	4966	V8	50
06/80→11/85	Saloon 200	M 102.920	Petrol	1997	4	32
01/86→05/90	Saloon 200	M 102.922	Petrol	1997	4	32
12/85→05/90	Saloon 200	M 102.922	Petrol	1997	4	32
06/80→11/85	Saloon 200	M 102.939	Petrol	1997	4	32
02/76→08/80	Saloon 200	M 115.938	Petrol	1988	4	18
02/76→08/80	Saloon 200	M 115.939	Petrol	1988	4	18

MODEL INDEX

Modelverzeichnis • Index de modele • Índice de Modelo
Indeks modelu • Модель автомобиля • دليل الموديل



CCM

x



9

08/89→06/93	Saloon 200 D	OM 601.912	Diesel	1978	4	19
12/84→08/89	Saloon 200 D	OM 601.912	Diesel	1978	4	19
03/79→11/85	Saloon 200 D	OM 615.940	Diesel	1988	4	22
07/76→02/79	Saloon 200 D	OM 615.940	Diesel	1988	4	22
11/92→05/93	Saloon 200 E	M 102.922	Petrol	1997	4	32
09/88→08/92	Saloon 200 E	M 102.963	Petrol	1997	4	32
09/88→12/89	Saloon 200 E	M 102.963	Petrol	1997	4	32
10/92→06/93	Saloon 200 E	M 111.940	Petrol	1998	4	35
01/76→02/79	Saloon 220 D	OM 615.941	Diesel	2197	4	22
01/77→03/79	Saloon 220 D	OM 615.941	Diesel	2197	4	22
10/92→06/93	Saloon 220 E	M 111.960	Petrol	2199	4	35
02/76→03/81	Saloon 230	M 115.954	Petrol	2308	4	46
04/80→12/85	Saloon 230 E	M 102.980	Petrol	2299	4	47
01/85→06/93	Saloon 230 E	M 102.982	Petrol	2299	4	47
06/89→06/93	Saloon 230 E	M 102.982	Petrol	2299	4	47
12/84→03/92	Saloon 230 E	M 102.982	Petrol	2299	4	47
02/76→02/79	Saloon 240 D	OM 616.912	Diesel	2399/2404	4	39
03/79→11/85	Saloon 240 D	OM 616.912	Diesel	2399/2404	4	39
02/76→10/79	Saloon 250	M 123.921	Petrol	2527	6	15
10/79→07/85	Saloon 250	M 123.921	Petrol	2527	6	15
01/89→06/93	Saloon 250 D	OM 602.912	Diesel	2497	5	19
04/85→06/93	Saloon 250 D	OM 602.912	Diesel	2497	5	19
09/88→06/93	Saloon 250 Turbo-D	OM 602A.962	Diesel	2497	5	21
09/85→08/92	Saloon 260 E	M 103.940	Petrol	2599	6	7
09/85→12/89	Saloon 260 E	M 103.940	Petrol	2599	6	7
12/86→12/89	Saloon 260 E 4-matic	M 103.940	Petrol	2599	6	7
09/86→08/92	Saloon 260 E 4-matic	M 103.943	Petrol	2599	6	7
02/76→08/81	Saloon 280	M 110.923	Petrol	2746	6	15
10/92→06/93	Saloon 280 E	M 104.942	Petrol	2799	6	35
02/76→11/85	Saloon 280 E	M 110.984	Petrol	2746	6	15
02/76→11/85	Saloon 280 E	M 110.988	Petrol	2746	6	15
08/76→08/81	Saloon 280 E	M 110.988	Petrol	2746	6	15
06/90→06/93	Saloon 300 D	OM 603.912	Diesel	2996	6	19
08/89→06/93	Saloon 300 D	OM 603.912	Diesel	2996	6	19
12/84→08/89	Saloon 300 D	OM 603.912	Diesel	2996	6	19
02/76→07/80	Saloon 300 D	OM 617.912	Diesel	2998	5	39
03/79→11/85	Saloon 300 D	OM 617.912	Diesel	2998	5	39
08/89→06/93	Saloon 300 D 4-matic	OM 603.913	Diesel	2996	6	19
09/86→08/92	Saloon 300 D 4-matic	OM 603.913	Diesel	2996	6	19
01/85→12/85	Saloon 300 E	M 103.980	Petrol	2962	6	30
06/85→08/92	Saloon 300 E	M 103.983	Petrol	2962	6	30
08/85→08/92	Saloon 300 E	M 103.983	Petrol	2962	6	30
09/86→02/92	Saloon 300 E 4-matic	M 103.983	Petrol	2962	6	30
09/86→06/93	Saloon 300 E 4-matic	M 103.985	Petrol	2962	6	30
09/88→08/92	Saloon 300 E-24	M 104.980	Petrol	2960	6	31
06/91→05/93	Saloon 300 TD SD	OM 603A.971	Diesel	3449	6	34
09/86→09/88	Saloon 300 Turbo-D	OM 603A.960	Diesel	2996	6	21
09/88→06/93	Saloon 300 Turbo-D	OM 603A.960	Diesel	2996	6	21
09/86→09/88	Saloon 300 Turbo-D	OM 603A.963	Diesel	2996	6	21
08/81→07/85	Saloon 300 Turbo-D	OM 617.952	Diesel	2998	5	38
09/86→09/88	Saloon 300 Turbo-D 4-matic	OM 603A.960	Diesel	2996	6	21
01/88→06/93	Saloon 300 Turbo-D 4-matic	OM 603A.963	Diesel	2996	6	21
09/86→09/88	Saloon 300 Turbo-D 4-matic	OM 603A.963	Diesel	2996	6	21
10/92→06/93	Saloon 320 E	M 104.992	Petrol	3199	6	35
10/92→06/93	Saloon 400 E 4.2	M 119.975	Petrol	4196	V8	45
01/91→06/93	Saloon 500 E	M 119.974	Petrol	4973	V8	49
08/80→08/84	S-Class 3.8	M 116.960	Petrol	3818	V8	41
08/72→07/75	S-Class 4.5	M 117.983	Petrol	4520	V8	43
09/85→06/91	S-Class 260 SE	M 103.941	Petrol	2599	6	7
08/72→07/80	S-Class 280 S	M 110.922	Petrol	2746	6	15

Modelverzeichnis • Index de modele • Índice de Modelo
Indeks modelu • Модель автомобиля • دليل الموديل

MODEL INDEX



CCM

x



12/79→07/85	S-Class 280 S	M 110.924	Petrol	2746	6	15
12/79→07/85	S-Class 280 S	M 110.926	Petrol	2746	6	15
10/67→07/72	S-Class 280 S	M 130.920	Petrol	2750	6	17
08/72→07/80	S-Class 280 SE,SEL	M 110.983	Petrol	2746	6	15
08/72→07/80	S-Class 280 SE,SEL	M 110.985	Petrol	2746	6	15
10/79→07/85	S-Class 280 SE,SEL	M 110.987	Petrol	2746	6	15
10/79→07/85	S-Class 280 SE,SEL	M 110.989	Petrol	2746	6	15
01/68→08/72	S-Class 280 SE,SEL	M 130.980	Petrol	2750	6	17
03/71→08/72	S-Class 280 SE,SEL 3.5	M 116.980	Petrol	3499	V8	43
01/93→10/98	S-Class 300 SE 2.8	M 104.944	Petrol	2799	6	35
01/86→06/91	S-Class 300 SE,SEL	M 103.981 (KAT)	Petrol	2962	6	30
09/85→12/89	S-Class 300 SE,SEL	M 103.981 (KAT)	Petrol	2962	6	30
03/91→10/98	S-Class 300 SE,SEL/S320	M 104.990	Petrol	3199	6	35
03/91→10/98	S-Class 300 SE,SEL/S320	M 104.994	Petrol	3199	6	35
01/68→08/72	S-Class 300 SEL	M 130.981	Petrol	2750	6	17
01/70→07/72	S-Class 300 SEL 3.5	M 116.981	Petrol	3499	V8	43
08/72→02/76	S-Class 350 SE,SEL	M 116.983	Petrol	3499	V8	43
03/76→03/80	S-Class 350 SE,SEL	M 116.985	Petrol	3499	V8	43
12/85→12/86	S-Class 380 SE,SEL	M 116.961	Petrol	3839	V8	24
12/79→08/85	S-Class 380 SE,SEL	M 116.963	Petrol	3839	V8	24
02/91→10/98	S-Class 400 SE,SEL/S420	M 119.971	Petrol	4196	V8	44
10/85→06/91	S-Class 420 SE,SEL	M 116.965	Petrol	4196	V8	42
10/85→12/87	S-Class 420 SE,SEL	M 116.965	Petrol	4196	V8	42
01/73→04/80	S-Class 450 SE,SEL	M 117.983	Petrol	4520	V8	43
01/73→04/80	S-Class 450 SE,SEL	M 117.986	Petrol	4520	V8	43
12/75→04/80	S-Class 450 SE,SEL	M 117.986	Petrol	4520	V8	43
12/79→08/85	S-Class 500 SE,SEL	M 117.961	Petrol	4973	V8	49
12/79→08/85	S-Class 500 SE,SEL	M 117.963	Petrol	4973	V8	49
02/91→10/98	S-Class 500 SE,SEL	M 119.970	Petrol	4973	V8	49
10/85→06/91	S-Class 560 SE,SEL	M 117.967	Petrol	5547	V8	49
08/87→06/91	S-Class 560 SE,SEL	M 117.968 (KAT)	Petrol	5547	V8	49
10/85→06/91	S-Class 560 SE,SEL	M 117.968 (KAT)	Petrol	5547	V8	49
10/85→12/87	S-Class 560 SE,SEL	M 117.968 (KAT)	Petrol	5547	V8	49
04/91→12/92	S-Class 600 SE,SEL	M 120.980	Petrol	5987	V12	33
10/81→07/85	S-Class Coupe 380 SEC	M 116.963	Petrol	3839	V8	24
10/85→06/91	S-Class Coupe 420 SEC	M 116.965	Petrol	4196	V8	42
10/85→12/87	S-Class Coupe 420 SEC	M 116.965	Petrol	4196	V8	42
08/80→08/85	S-Class Coupe 500 SEC	M 117.963	Petrol	4973	V8	49
10/81→08/85	S-Class Coupe 500 SEC	M 117.963	Petrol	4973	V8	49
10/85→06/91	S-Class Coupe 560 SEC	M 117.968 (KAT)	Petrol	5547	V8	49
10/85→12/87	S-Class Coupe 560 SEC	M 117.968 (KAT)	Petrol	5547	V8	49
10/85→12/89	S-Class Coupe 560 SEC	M 117.968 (KAT)	Petrol	5547	V8	49
03/99→03/06	S-Class Coupe CL 500	M 113.960	Petrol	4966	V8	50
10/94→02/99	S-Class Coupe SEC/CL 420	M 119.971	Petrol	4196	V8	44
10/94→02/99	S-Class Coupe SEC/CL 420	M 119.981	Petrol	4196	V8	45
10/92→02/99	S-Class Coupe SEC/CL 500	M 119.970	Petrol	4973	V8	49
09/92→02/99	S-Class Coupe SEC/CL 600	M 120.980	Petrol	5987	V12	33
01/11→	S-Class S 250 CDI	OM 651.961	Diesel	2143	4	11
02/93→10/98	S-Class S 280	M 104.944	Petrol	2799	6	35
10/98→08/05	S-Class S 280	M 112.922	Petrol	2799	V6	36
08/06→	S-Class S 280	M 272.946	Petrol	2996	V6	25
08/06→	S-Class S 300	M 272.946	Petrol	2996	V6	25
02/14→	S-Class S 300 BlueTEC Hybrid	OM 651.921	Diesel	2143	4	11
05/96→10/98	S-Class S 300 Turbo-D	OM 606.961	Diesel	2996	6	21
10/98→08/05	S-Class S 320	M 112.944	Petrol	3199	V6	36
08/99→09/02	S-Class S 320 CDI	OM 613.960	Diesel	3222	6	26
10/05→	S-Class S 320 CDI	OM 642.930	Diesel	2987	V6	10
09/02→08/05	S-Class S 320 CDI	OM 648.960	Diesel	3222	6	28
12/05→	S-Class S 320 CDI / S 350 CDI	OM 642.930	Diesel	2987	V6	10
10/06→	S-Class S 320 CDI 4-matic	OM 642.932	Diesel	2987	V6	10

MODEL INDEX

Modelverzeichnis • Index de modele • Índice de Modelo
Indeks modelu • Модель автомобиля • دليل المحرك



CCM



9

Year Range	Model Name	Engine Code	Fuel	CCM	Cylinders	Power (kW)
09/02→08/05	S-Class S 350	M 112.972	Petrol	3724	V6	50
06/03→08/05	S-Class S 350 4-matic	M 112.975	Petrol	3724	V6	50
04/11→	S-Class S 350 BlueTec	OM 642.862	Diesel	2987	V6	10
04/11→	S-Class S 350 BlueTEC 4-matic	OM 642.868	Diesel	2987	V6	10
05/11→	S-Class S 350 CDI	OM 642.930	Diesel	2987	V6	10
01/93→10/98	S-Class S 350 Turbo-D	OM 603A.971	Diesel	3449	6	34
06/00→08/05	S-Class S 400 CDI	OM 628.960	Diesel	3996	V8	16
06/03→08/05	S-Class S 400 CDI	OM 628.960	Diesel	3996	V8	16
01/93→10/98	S-Class S 420	M 119.971	Petrol	4196	V8	44
10/98→08/05	S-Class S 430	M 113.941	Petrol	4266	V8	36
10/98→08/05	S-Class S 500	M 113.960	Petrol	4966	V8	50
01/93→10/98	S-Class S 500	M 119.970	Petrol	4973	V8	49
01/93→10/98	S-Class S 500	M 119.980	Petrol	4973	V8	49
09/02→08/05	S-Class S 500 4-matic	M 113.966	Petrol	4966	V8	50
01/93→10/98	S-Class S 600	M 120.980	Petrol	5987	V12	33
01/71→02/73	Series 206 D 2.0	OM 615.915	Diesel	1988	4	22
12/76→07/77	Series 206 D 2.0	OM 615.943 (OM 615)	Diesel	1988	4	22
08/77→01/89	Series 207/307 D 2.0	OM 615.944 (OM 615)	Diesel	1988	4	22
03/73→12/80	Series 406 D 2.2	OM 615.938 (OM 615)	Diesel	2197	4	23
03/73→07/77	Series 407 D 2.2	OM 615.938 (OM 615)	Diesel	2197	4	23
01/72→	Series F 20	OM 615.936 (OM 615)	Diesel	2197	4	22
08/93→10/01	SL 280	M 104.943	Petrol	2799	6	35
05/98→10/01	SL 280	M 112.923	Petrol	2799	V6	36
05/98→10/01	SL 280	M 112.925	Petrol	2799	V6	36
03/08→01/12	SL 280	M 272.949	Petrol	2996	6	25
06/76→09/81	SL 280 SL	M 110.982	Petrol	2746	6	15
08/74→07/85	SL 280 SL	M 110.982	Petrol	2746	6	15
06/76→09/81	SL 280 SL	M 110.986	Petrol	2746	6	15
08/74→07/85	SL 280 SL	M 110.986	Petrol	2746	6	15
06/76→09/81	SL 280 SL	M 110.990	Petrol	2746	6	15
08/74→07/85	SL 280 SL	M 110.990	Petrol	2746	6	15
04/09→01/12	SL 300	M 272.949	Petrol	2996	6	25
09/85→08/89	SL 300 SL	M 103.982	Petrol	2962	6	30
03/89→08/93	SL 300 SL	M 103.984	Petrol	2962	6	30
03/89→07/93	SL 300 SL-24	M 104.981	Petrol	2960	6	31
09/93→10/01	SL 320	M 104.991	Petrol	3199	6	35
05/98→10/01	SL 320	M 112.943	Petrol	3199	V6	36
03/03→01/12	SL 350	M 112.973	Petrol	3724	V6	50
05/71→02/80	SL 350 SL	M 116.982	Petrol	3499	V8	43
05/71→02/80	SL 350 SL	M 116.984	Petrol	3499	V8	43
09/80→08/81	SL 380 SL	M 116.960	Petrol	3818	V8	41
09/80→08/85	SL 380 SL	M 116.962	Petrol	3839	V8	24
01/86→08/89	SL 420 SL	M 116.964	Petrol	4196	V8	42
09/75→10/80	SL 450 SL	M 117.982	Petrol	4520	V8	43
10/72→10/80	SL 450 SL	M 117.982	Petrol	4520	V8	43
05/98→10/01	SL 500	M 113.961	Petrol	4966	V8	50
10/01→01/12	SL 500	M 113.963	Petrol	4966	V8	50
09/92→10/01	SL 500	M 119.972	Petrol	4973	V8	49
09/92→10/01	SL 500	M 119.982	Petrol	4973	V8	49
01/86→08/89	SL 500 SL	M 117.960	Petrol	4973	V8	49
05/80→12/81	SL 500 SL	M 117.960	Petrol	4973	V8	49
05/80→12/85	SL 500 SL	M 117.960	Petrol	4973	V8	49
01/86→08/89	SL 500 SL	M 117.964	Petrol	4973	V8	49
09/89→08/92	SL 500 SL	M 119.960	Petrol	4973	V8	49
09/89→08/92	SL 500 SL	M 119.972	Petrol	4973	V8	49
07/92→10/01	SL 600	M 120.981	Petrol	5987	V12	33
07/92→10/01	SL 600	M 120.983	Petrol	5987	V12	33
02/92→08/94	SL 600 SL	M 120.980	Petrol	5987	V12	33
06/76→09/81	SL Coupe 280 SLC	M 110.982	Petrol	2746	6	15
08/74→09/81	SL Coupe 280 SLC	M 110.982	Petrol	2746	6	15

Modelverzeichnis • Index de modele • Índice de Modelo
Indeks modelu • Модель автомобиля • دليل الموديل

MODEL INDEX



CCM

x



06/76→09/81	SL Coupe 280 SLC	M 110.986	Petrol	2746	6	15
08/74→09/81	SL Coupe 280 SLC	M 110.986	Petrol	2746	6	15
06/76→09/81	SL Coupe 280 SLC	M 110.990	Petrol	2746	6	15
08/74→09/81	SL Coupe 280 SLC	M 110.990	Petrol	2746	6	15
01/72→02/76	SL Coupe 350 SLC	M 116.982	Petrol	3499	V8	43
03/76→02/80	SL Coupe 350 SLC	M 116.982	Petrol	3499	V8	43
01/72→02/76	SL Coupe 350 SLC	M 116.984	Petrol	3499	V8	43
03/76→02/80	SL Coupe 350 SLC	M 116.984	Petrol	3499	V8	43
07/80→08/81	SL Coupe 380 SLC	M 116.960	Petrol	3818	V8	41
08/81→08/84	SL Coupe 380 SLC	M 116.963	Petrol	3839	V8	24
01/73→11/75	SL Coupe 450 SLC	M 117.982	Petrol	4520	V8	43
09/75→08/79	SL Coupe 450 SLC	M 117.982	Petrol	4520	V8	43
06/78→02/80	SL Coupe 450 SLC 5.0	M 117.960	Petrol	4973	V8	49
09/96→03/00	SLK 200	M 111.946	Petrol	1998	4	35
10/96→03/00	SLK 200 Kompressor	M 111.943	Petrol	1998	4	35
03/00→04/04	SLK 200 Kompressor	M 111.958	Petrol	1998	4	35
03/04→02/11	SLK 200 Kompressor	M 271.944	Petrol	1795	4	5
01/08→02/11	SLK 200 Kompressor	M 271.954	Petrol	1796	4	5
09/96→03/00	SLK 230 Kompressor	M 111.973	Petrol	2295	4	37
03/00→04/04	SLK 230 Kompressor	M 111.983	Petrol	2295	4	37
01/12→	SLK 250 CDI	OM 651.980	Diesel	2143	4	11
01/05→02/11	SLK 280	M 272.942	Petrol	2996	V6	25
04/09→02/11	SLK 300	M 272.942	Petrol	2996	V6	25
03/00→04/04	SLK 320	M 112.947	Petrol	3199	V6	36
07/98→	Smart 600	M 160 E6AL B03	Petrol	599	3	1
07/98→	Smart 600	M 160 E6AL B04	Petrol	599	3	1
03/04→	Smart Forfour 1.5 CDI	OM 639.939 Euro 4	Diesel	1493	3	9
04/00→05/06	Sprinter 2-T Box 208 CDI	OM 611.987 Euro 3	Diesel	2148	4	26
02/95→04/00	Sprinter 2-T Box 208 D	OM 601.943 (OM 601)	Diesel	2299	4	34
10/96→04/00	Sprinter 2-T Box 208 D	OM 601.943 (OM 601)	Diesel	2299	4	34
01/97→04/00	Sprinter 2-T Box 210 D	OM 602.980 (OM 602 DE 29LA)	Diesel	2874	5	34
02/95→04/00	Sprinter 2-T Box 212 D	OM 602.980 (OM 602 DE 29LA)	Diesel	2874	5	34
02/95→05/06	Sprinter 2-T Box 214	M 111.979	Petrol	2295	4	37
02/95→05/06	Sprinter 2-T Box 214	M 111.984	Petrol	2295	4	37
04/00→05/06	Sprinter 2-T Box 214 NGT	M 111.984	Petrol	2295	4	37
04/00→05/06	Sprinter 2-T Box 216 CDI	OM 612.981	Diesel	2685	5	26
04/00→05/06	Sprinter 2-T Bus 208 CDI	OM 611.987 Euro 3	Diesel	2148	4	26
02/95→04/00	Sprinter 2-T Bus 208 D	OM 601.900 Euro 2 (OM 601 D23)	Diesel	2299	4	34
02/95→04/00	Sprinter 2-T Bus 208 D	OM 601.943 (OM 601)	Diesel	2299	4	34
03/97→04/00	Sprinter 2-T Bus 210 D	OM 602.980 (OM 602 DE 29LA)	Diesel	2874	5	34
03/97→04/00	Sprinter 2-T Bus 210 D	OM 602.986	Diesel	2874	5	34
02/95→04/00	Sprinter 2-T Bus 212 D	OM 602.980 (OM 602 DE 29LA)	Diesel	2874	5	34
02/95→05/06	Sprinter 2-T Bus 214	M 111.979	Petrol	2295	4	37
04/00→05/06	Sprinter 2-T Bus 214 NGT	M 111.984	Petrol	2295	4	37
04/00→05/06	Sprinter 2-T Bus 216 CDI	OM 612.981	Diesel	2685	5	26
04/00→05/06	Sprinter 2-t Platform/Chassis 208 CDI	OM 611.987 Euro 3	Diesel	2148	4	26
09/96→04/00	Sprinter 2-t Platform/Chassis 208 D	OM 601.900 Euro 2 (OM 601 D23)	Diesel	2299	4	34
01/95→04/00	Sprinter 2-t Platform/Chassis 208 D	OM 601.943 (OM 601)	Diesel	2299	4	34
09/96→04/00	Sprinter 2-t Platform/Chassis 208 D	OM 601.943 (OM 601)	Diesel	2299	4	34
01/97→04/00	Sprinter 2-t Platform/Chassis 210 D	OM 602.980 (OM 602 DE 29LA)	Diesel	2874	5	34
02/95→04/00	Sprinter 2-t Platform/Chassis 212 D	OM 602.980 (OM 602 DE 29LA)	Diesel	2874	5	34
02/95→05/06	Sprinter 2-t Platform/Chassis 214	M 111.979	Petrol	2295	4	37
04/00→05/06	Sprinter 2-t Platform/Chassis 216 CDI	OM 612.981	Diesel	2685	5	26
04/00→05/06	Sprinter 2T,3T,4T 413 CDI 4x4	OM 611.981 Euro 3	Diesel	2148	4	26
06/06→	Sprinter 3,5 Platform/Chassis 309 CDI	OM 646.984	Diesel	2148	4	27
03/09→	Sprinter 3,5 Platform/Chassis 310 CDI	OM 651.955	Diesel	2143	4	11
06/06→	Sprinter 3,5 Platform/Chassis 311 CDI	OM 646.985	Diesel	2148	4	29
02/08→	Sprinter 3,5 Platform/Chassis 311 CDI 4x4	OM 646.985	Diesel	2148	4	29
06/06→	Sprinter 3,5 Platform/Chassis 313 CDI	OM 646.986 Euro 4	Diesel	2148	4	29
06/06→	Sprinter 3,5 Platform/Chassis 313 CDI	OM 651.956	Diesel	2143	4	11

MODEL INDEX

Modelverzeichnis • Index de modele • Índice de Modelo
Indeks modelu • Модель автомобиля • دليل الموديل



CCM

x



9

06/06→	Sprinter 3,5 Platform/Chassis 315 CDI	OM 646.989	Diesel	2148	4	29
06/06→	Sprinter 3,5 Platform/Chassis 315 CDI	OM 646.990	Diesel	2148	4	27
02/08→	Sprinter 3,5 Platform/Chassis 315 CDI 4x4	OM 646.989	Diesel	2148	4	29
02/08→	Sprinter 3,5 Platform/Chassis 315 CDI 4x4	OM 646.990	Diesel	2148	4	27
09/08→	Sprinter 3,5 Platform/Chassis 316	M 271.951	Petrol	1796	4	5
03/09→	Sprinter 3,5 Platform/Chassis 316 CDI	OM 651.957	Diesel	2143	4	11
09/08→	Sprinter 3,5 Platform/Chassis 316 LGT	M 271.951	Petrol	1796	4	5
09/08→	Sprinter 3,5 Platform/Chassis 316 NGT	M 271.951	Petrol	1796	4	5
06/06→	Sprinter 3,5 Platform/Chassis 318 CDI	OM 642.896	Diesel	2987	V6	10
06/06→	Sprinter 3,5 Platform/Chassis 318 CDI	OM 642.992	Diesel	2987	V6	10
06/06→	Sprinter 3,5 Platform/Chassis 318 CDI	OM 642.993	Diesel	2987	V6	10
02/08→	Sprinter 3,5 Platform/Chassis 318 CDI 4x4	OM 642.896	Diesel	2987	V6	10
03/09→	Sprinter 3,5 Platform/Chassis 319 CDI / BlueTEC	OM 642.898	Diesel	2987	V6	10
05/11→	Sprinter 3,5 Platform/Chassis 319 CDI / BlueTEC 4x4	OM 642.898	Diesel	2987	V6	10
06/06→	Sprinter 3,5-t Box 309 CDI	OM 646.984	Diesel	2148	4	27
03/09→	Sprinter 3,5-t Box 310 CDI	OM 651.955	Diesel	2143	4	11
06/06→	Sprinter 3,5-t Box 311 CDI	OM 646.985	Diesel	2148	4	29
02/08→	Sprinter 3,5-t Box 311 CDI 4x4	OM 646.985	Diesel	2148	4	29
06/06→	Sprinter 3,5-t Box 313 CDI	OM 646.986 Euro 4	Diesel	2148	4	29
06/06→	Sprinter 3,5-t Box 315 CDI	OM 646.989	Diesel	2148	4	29
06/06→	Sprinter 3,5-t Box 315 CDI	OM 646.990	Diesel	2148	4	27
02/08→	Sprinter 3,5-t Box 315 CDI 4x4	OM 646.989	Diesel	2148	4	29
02/08→	Sprinter 3,5-t Box 315 CDI 4x4	OM 646.990	Diesel	2148	4	27
09/08→	Sprinter 3,5-t Box 316	M 271.951	Petrol	1796	4	5
09/08→	Sprinter 3,5-t Box 316 LGT	M 271.951	Petrol	1796	4	5
09/08→	Sprinter 3,5-t Box 316 NGT	M 271.951	Petrol	1796	4	5
03/09→	Sprinter 3,5-t Bus 310 CDI	OM 651.955	Diesel	2143	4	11
06/06→	Sprinter 3,5-t Bus 311 CDI	OM 646.985	Diesel	2148	4	29
02/08→	Sprinter 3,5-t Bus 311 CDI 4x4	OM 646.985	Diesel	2148	4	29
06/06→	Sprinter 3,5-t Bus 315 CDI	OM 646.989	Diesel	2148	4	29
06/06→	Sprinter 3,5-t Bus 315 CDI	OM 646.990	Diesel	2148	4	27
02/08→	Sprinter 3,5-t Bus 315 CDI 4x4	OM 646.989	Diesel	2148	4	29
02/08→	Sprinter 3,5-t Bus 315 CDI 4x4	OM 646.990	Diesel	2148	4	27
09/08→	Sprinter 3,5-t Bus 316	M 271.951	Petrol	1796	4	5
09/08→	Sprinter 3,5-t Bus 316 LGT	M 271.951	Petrol	1796	4	5
09/08→	Sprinter 3,5-t Bus 316 NGT	M 271.951	Petrol	1796	4	5
06/06→	Sprinter 3-T Box 209 CDI	OM 646.984	Diesel	2148	4	27
03/09→	Sprinter 3-T Box 210 CDI	OM 651.955	Diesel	2143	4	11
06/06→	Sprinter 3-T Box 211 CDI	OM 646.985	Diesel	2148	4	29
06/06→	Sprinter 3-T Box 213 CDI	OM 646.986 Euro 4	Diesel	2148	4	29
06/06→	Sprinter 3-T Box 215 CDI	OM 646.989	Diesel	2148	4	29
06/06→	Sprinter 3-T Box 215 CDI	OM 646.990	Diesel	2148	4	27
09/08→	Sprinter 3-T Box 216	M 271.951	Petrol	1796	4	5
04/00→05/06	Sprinter 3-T Box 308 CDI	OM 611.987 Euro 3	Diesel	2148	4	26
02/95→04/00	Sprinter 3-T Box 308 D 2.3	OM 601.900 Euro 2 (OM 601 D23)	Diesel	2299	4	34
02/95→04/00	Sprinter 3-T Box 308 D 2.3	OM 601.943 (OM 601)	Diesel	2299	4	34
02/95→04/00	Sprinter 3-T Box 310 D 2.9	OM 602.980 (OM 602 DE 29LA)	Diesel	2874	5	34
02/95→04/00	Sprinter 3-T Box 312 D 2.9	OM 602.980 (OM 602 DE 29LA)	Diesel	2874	5	34
05/97→08/02	Sprinter 3-T Box 312 D 2.9 4x4	OM 602.980 (OM 602 DE 29LA)	Diesel	2874	5	34
02/95→05/06	Sprinter 3-T Box 314	M 111.979	Petrol	2295	4	37
02/95→05/06	Sprinter 3-T Box 314	M 111.984	Petrol	2295	4	37
08/02→05/06	Sprinter 3-T Box 314 4x4	M 111.984	Petrol	2295	4	37
04/00→05/06	Sprinter 3-T Box 316 CDI	OM 612.981	Diesel	2685	5	26
08/02→05/06	Sprinter 3-T Box 316 CDI 4x4	OM 612.981	Diesel	2685	5	26
01/97→12/99	Sprinter 3-T Bus 2.9 TDi	OM 602.980 (OM 602 DE 29LA)	Diesel	2874	5	34
03/09→	Sprinter 3-T Bus 210 CDI	OM 651.955	Diesel	2143	4	11
06/06→	Sprinter 3-T Bus 211 CDI	OM 646.985	Diesel	2148	4	29
06/06→	Sprinter 3-T Bus 215 CDI	OM 646.989	Diesel	2148	4	29
06/06→	Sprinter 3-T Bus 215 CDI	OM 646.990	Diesel	2148	4	27



CCM

x



9

09/08→	Sprinter 3-T Bus 216	M 271.951	Petrol	1796	4	5
04/00→05/06	Sprinter 3-T Bus 308 CDI	OM 611.987 Euro 3	Diesel	2148	4	26
02/95→04/00	Sprinter 3-T Bus 308 D	OM 601.900 Euro 2 (OM 601 D23)	Diesel	2299	4	34
02/95→04/00	Sprinter 3-T Bus 308 D	OM 601.943 (OM 601)	Diesel	2299	4	34
05/97→08/02	Sprinter 3-T Bus 310 D 4x4	OM 602.980 (OM 602 DE 29LA)	Diesel	2874	5	34
02/95→04/00	Sprinter 3-T Bus 312 D 2.9	OM 602.980 (OM 602 DE 29LA)	Diesel	2874	5	34
05/97→08/02	Sprinter 3-T Bus 312 D 2.9 4x4	OM 602.980 (OM 602 DE 29LA)	Diesel	2874	5	34
02/95→05/06	Sprinter 3-T Bus 314	M 111.984	Petrol	2295	4	37
08/02→05/06	Sprinter 3-T Bus 314 4x4	M 111.984	Petrol	2295	4	37
04/00→05/06	Sprinter 3-T Bus 314 NGT	M 111.984	Petrol	2295	4	37
04/00→05/06	Sprinter 3-T Bus 316 CDI	OM 612.981	Diesel	2685	5	26
08/02→05/06	Sprinter 3-T Bus 316 CDI 4x4	OM 612.981	Diesel	2685	5	26
06/06→	Sprinter 3-t Platform/Chassis 209 CDI	OM 646.984	Diesel	2148	4	27
03/09→	Sprinter 3-t Platform/Chassis 210 CDI	OM 651.955	Diesel	2143	4	11
06/06→	Sprinter 3-t Platform/Chassis 211 CDI	OM 646.985	Diesel	2148	4	29
06/06→	Sprinter 3-t Platform/Chassis 213 CDI	OM 646.986 Euro 4	Diesel	2148	4	29
06/06→	Sprinter 3-t Platform/Chassis 215 CDI	OM 646.989	Diesel	2148	4	29
06/06→	Sprinter 3-t Platform/Chassis 215 CDI	OM 646.990	Diesel	2148	4	27
09/08→	Sprinter 3-t Platform/Chassis 216	M 271.951	Petrol	1796	4	5
04/00→05/06	Sprinter 3-t Platform/Chassis 308 CDI	OM 611.987 Euro 3	Diesel	2148	4	26
02/95→04/00	Sprinter 3-t Platform/Chassis 308 D 2.3	OM 601.900 Euro 2 (OM 601 D23)	Diesel	2299	4	34
02/95→04/00	Sprinter 3-t Platform/Chassis 308 D 2.3	OM 601.943 (OM 601)	Diesel	2299	4	34
11/96→04/00	Sprinter 3-t Platform/Chassis 308 D 2.3	OM 601.943 (OM 601)	Diesel	2299	4	34
01/97→04/00	Sprinter 3-t Platform/Chassis 310 D 2.9	OM 602.980 (OM 602 DE 29LA)	Diesel	2874	5	34
02/95→04/00	Sprinter 3-t Platform/Chassis 312 D 2.9	OM 602.980 (OM 602 DE 29LA)	Diesel	2874	5	34
02/95→05/06	Sprinter 3-t Platform/Chassis 314	M 111.984	Petrol	2295	4	37
08/02→05/06	Sprinter 3-t Platform/Chassis 314 4x4	M 111.984	Petrol	2295	4	37
04/00→05/06	Sprinter 3-t Platform/Chassis 316 CDI	OM 612.981	Diesel	2685	5	26
08/02→05/06	Sprinter 3-t Platform/Chassis 316 CDI 4x4	OM 612.981	Diesel	2685	5	26
06/09→	Sprinter 4,6-t Box 411 CDI	OM 646.985	Diesel	2148	4	29
06/06→	Sprinter 4,6-t Box 413 CDI	OM 646.986 Euro 4	Diesel	2148	4	29
06/09→	Sprinter 4,6-t Box 415 CDI	OM 646.989	Diesel	2148	4	29
06/09→	Sprinter 4,6-t Box 415 CDI	OM 646.990	Diesel	2148	4	27
06/09→	Sprinter 4,6-t Platform/Chassis 411 CDI	OM 646.985	Diesel	2148	4	29
06/06→	Sprinter 4,6-t Platform/Chassis 413 CDI	OM 646.986 Euro 4	Diesel	2148	4	29
06/06→	Sprinter 4,6-t Platform/Chassis 415 CDI	OM 646.989	Diesel	2148	4	29
06/06→	Sprinter 4,6-t Platform/Chassis 415 CDI	OM 646.990	Diesel	2148	4	27
04/00→05/06	Sprinter 4-T Box 408 CDI	OM 611.987 Euro 3	Diesel	2148	4	26
02/96→05/06	Sprinter 4-T Box 408 D	OM 601.943 (OM 601)	Diesel	2299	4	34
02/96→05/06	Sprinter 4-T Box 410 D	OM 602.980 (OM 602 DE 29LA)	Diesel	2874	5	34
05/97→05/06	Sprinter 4-T Box 410 D 4x4	OM 602.980 (OM 602 DE 29LA)	Diesel	2874	5	34
02/96→05/06	Sprinter 4-T Box 412 D	OM 602.980 (OM 602 DE 29LA)	Diesel	2874	5	34
05/97→05/06	Sprinter 4-T Box 412 D 4x4	OM 602.980 (OM 602 DE 29LA)	Diesel	2874	5	34
02/96→05/06	Sprinter 4-T Box 414	M 111.979	Petrol	2295	4	37
05/97→05/06	Sprinter 4-T Box 414 4x4	M 111.979	Petrol	2295	4	37
04/00→05/06	Sprinter 4-T Box 416 CDI	OM 612.981	Diesel	2685	5	26
04/00→05/06	Sprinter 4-T Box 416 CDI 4x4	OM 612.981	Diesel	2685	5	26
04/00→05/06	Sprinter 4-T Bus 408 CDI	OM 611.987 Euro 3	Diesel	2148	4	26
02/96→05/06	Sprinter 4-T Bus 414	M 111.979	Petrol	2295	4	37
04/00→05/06	Sprinter 4-T Bus 416 CDI	OM 612.981	Diesel	2685	5	26
04/00→05/06	Sprinter 4-t Platform/Chassis 408 CDI	OM 611.987 Euro 3	Diesel	2148	4	26
02/96→05/06	Sprinter 4-t Platform/Chassis 408 D	OM 601.943 (OM 601)	Diesel	2299	4	34
02/96→05/06	Sprinter 4-t Platform/Chassis 410 D	OM 602.980 (OM 602 DE 29LA)	Diesel	2874	5	34
05/97→05/06	Sprinter 4-t Platform/Chassis 410 D 4x4	OM 602.980 (OM 602 DE 29LA)	Diesel	2874	5	34
02/96→05/06	Sprinter 4-t Platform/Chassis 412 D	OM 602.980 (OM 602 DE 29LA)	Diesel	2874	5	34
05/97→05/06	Sprinter 4-t Platform/Chassis 412 D 4x4	OM 602.980 (OM 602 DE 29LA)	Diesel	2874	5	34
02/96→05/06	Sprinter 4-t Platform/Chassis 414	M 111.979	Petrol	2295	4	37
05/97→05/06	Sprinter 4-t Platform/Chassis 414 4x4	M 111.979	Petrol	2295	4	37
04/00→05/06	Sprinter 4-t Platform/Chassis 416 CDI	OM 612.981	Diesel	2685	5	26
04/00→05/06	Sprinter 4-t Platform/Chassis 416 CDI 4x4	OM 612.981	Diesel	2685	5	26

MODEL INDEX

Modelverzeichnis • Index de modele • Índice de Modelo
Indeks modelu • Модель автомобиля • دليل الموديل



CCM

x



9

06/06→	Sprinter 5-t Box 509 CDI	OM 646.984	Diesel	2148	4	27
03/09→	Sprinter 5-t Box 510 CDI	OM 651.955	Diesel	2143	4	11
06/06→	Sprinter 5-t Box 511 CDI	OM 646.985	Diesel	2148	4	29
06/06→	Sprinter 5-t Box 511 CDI 4x4	OM 646.985	Diesel	2148	4	29
06/06→	Sprinter 5-t Box 513 CDI	OM 646.986 Euro 4	Diesel	2148	4	29
06/06→	Sprinter 5-t Box 515 CDI	OM 646.989	Diesel	2148	4	29
06/06→	Sprinter 5-t Box 515 CDI	OM 646.990	Diesel	2148	4	27
06/06→	Sprinter 5-t Box 515 CDI 4x4	OM 646.989	Diesel	2148	4	29
06/06→	Sprinter 5-t Box 515 CDI 4x4	OM 646.990	Diesel	2148	4	27
06/06→	Sprinter 5-t Platform/Chassis 509 CDI	OM 646.984	Diesel	2148	4	27
03/09→	Sprinter 5-t Platform/Chassis 510 CDI	OM 651.955	Diesel	2143	4	11
06/06→	Sprinter 5-t Platform/Chassis 511 CDI	OM 646.985	Diesel	2148	4	29
06/06→	Sprinter 5-t Platform/Chassis 511 CDI 4x4	OM 646.985	Diesel	2148	4	29
06/06→	Sprinter 5-t Platform/Chassis 513 CDI	OM 646.986 Euro 4	Diesel	2148	4	29
05/11→	Sprinter 5-t Platform/Chassis 513 CDI 4x4	OM 651.955	Diesel	2143	4	11
06/06→	Sprinter 5-t Platform/Chassis 515 CDI	OM 646.989	Diesel	2148	4	29
06/06→	Sprinter 5-t Platform/Chassis 515 CDI	OM 646.990	Diesel	2148	4	27
06/06→	Sprinter 5-t Platform/Chassis 515 CDI 4x4	OM 646.989	Diesel	2148	4	29
06/06→	Sprinter 5-t Platform/Chassis 515 CDI 4x4	OM 646.990	Diesel	2148	4	27
09/08→	Sprinter 5-t Platform/Chassis 516	M 271.951	Petrol	1796	4	5
09/08→	Sprinter 5-t Platform/Chassis 516 NGT	M 271.951	Petrol	1796	4	5
04/01→05/06	Sprinter 5t Platform/Chassis 616 CDI	OM 612.981	Diesel	2685	5	26
04/00→	Sprinter CDI	OM 647.981	Diesel	2685	5	28
04/01→	Sprinter Dumptruck 616 CDI	OM 612.981	Diesel	2685	5	26
01/75→12/80	Steyr City Bus SC6 F 55	OM 615.942 (OM 615)	Diesel	1988	4	22
06/82→01/90	T1 Box 207 D 2.4	OM 616.937 (OM 616)	Diesel	2399	4	38
06/82→01/90	T1 Box 207 D 2.4	OM 616.939 (OM 616)	Diesel	2399	4	38
10/88→02/96	T1 Box 208 D 2.3	OM 601.940 (OM 601)	Diesel	2299	4	34
11/88→02/96	T1 Box 208 D 2.3	OM 601.940 (OM 601)	Diesel	2299	4	34
12/82→01/90	T1 Box 209 D 2.9	OM 617.913 (OM 617)	Diesel	2998	5	38
07/82→02/96	T1 Box 210 2.3	M 102.942	Petrol	2298	4	47
05/89→02/96	T1 Box 210 2.3	M 102.945	Petrol	2299	4	47
07/82→02/96	T1 Box 210 2.3	M 102.946	Petrol	2299	4	47
05/77→12/82	T1 Box 210 2.3	M 115.955	Petrol	2308	4	46
10/88→02/96	T1 Box 210 D 2.8	OM 602.940 (OM 602)	Diesel	2874	5	34
10/82→01/90	T1 Box 307 D 2.4	OM 616.937 (OM 616)	Diesel	2399	4	38
10/82→01/90	T1 Box 307 D 2.4	OM 616.939 (OM 616)	Diesel	2399	4	38
06/89→02/96	T1 Box 308 D 2.3	OM 601.940 (OM 601)	Diesel	2299	4	34
11/88→02/96	T1 Box 308 D 2.3	OM 601.940 (OM 601)	Diesel	2299	4	34
10/82→01/90	T1 Box 309 D 3.0	OM 617.913 (OM 617)	Diesel	2998	5	38
06/89→02/96	T1 Box 310 2.3	M 102.942	Petrol	2298	4	47
06/89→02/96	T1 Box 310 D 2.9	OM 602.940 (OM 602)	Diesel	2874	5	34
05/77→12/82	T1 Bus 207 D 2.4	OM 616.917 (OM 616)	Diesel	2399/2404	4	39
05/77→12/82	T1 Bus 207 D 2.4	OM 616.934 (OM 616)	Diesel	2399/2404	4	39
05/77→12/82	T1 Bus 208 2.3	M 115.955	Petrol	2308	4	46
05/77→12/82	T1 Bus 208 2.3	M 115.972	Petrol	2308	4	46
10/88→02/96	T1 Bus 208 D 2.3	OM 601.940 (OM 601)	Diesel	2299	4	34
12/82→01/90	T1 Bus 209 D 2.9	OM 617.913 (OM 617)	Diesel	2998	5	38
07/82→01/90	T1 Bus 210 2.3	M 102.942	Petrol	2298	4	47
05/89→02/96	T1 Bus 210 2.3	M 102.945	Petrol	2299	4	47
11/88→02/96	T1 Bus 210 D 2.8	OM 602.940 (OM 602)	Diesel	2874	5	34
05/90→02/96	T1 Bus 308 D 2.3	OM 601.940 (OM 601)	Diesel	2299	4	34
06/89→02/96	T1 Bus 308 D 2.3	OM 601.940 (OM 601)	Diesel	2299	4	34
06/89→02/96	T1 Bus 310 D 2.9	OM 602.940 (OM 602)	Diesel	2874	5	34
06/90→02/96	T1 Bus 310 D 2.9	OM 602.940 (OM 602)	Diesel	2874	5	34
04/77→12/82	T1 Platform/Chassis 207 D 2.4	OM 616.917 (OM 616)	Diesel	2399/2404	4	39
12/77→10/89	T1 Platform/Chassis 207 D 2.4	OM 616.937 (OM 616)	Diesel	2399	4	38
06/89→02/96	T1 Platform/Chassis 208 D 2.3	OM 601.940 (OM 601)	Diesel	2299	4	34
11/88→02/96	T1 Platform/Chassis 208 D 2.3	OM 601.940 (OM 601)	Diesel	2299	4	34
12/82→01/90	T1 Platform/Chassis 209 D 2.9	OM 617.913 (OM 617)	Diesel	2998	5	38

CCM

x

04/77→10/89	T1 Platform/Chassis 210 2.3	M 102.942	Petrol	2298	4	47
04/77→10/89	T1 Platform/Chassis 210 2.3	M 115.955	Petrol	2308	4	46
11/88→02/96	T1 Platform/Chassis 210 D 2.8	OM 602.940 (OM 602)	Diesel	2874	5	34
11/88→02/96	T1 Platform/Chassis 210 D 2.9	OM 602.940 (OM 602)	Diesel	2874	5	34
01/77→12/90	T1 Platform/Chassis 307 D 2.4	OM 616.917 (OM 616)	Diesel	2399/2404	4	39
04/77→01/83	T1 Platform/Chassis 307 D 2.4	OM 616.937 (OM 616)	Diesel	2399	4	38
06/82→01/90	T1 Platform/Chassis 307 D 2.4	OM 616.937 (OM 616)	Diesel	2399	4	38
06/82→01/90	T1 Platform/Chassis 307 D 2.4	OM 616.939 (OM 616)	Diesel	2399	4	38
06/89→02/96	T1 Platform/Chassis 308 D 2.3	OM 601.940 (OM 601)	Diesel	2299	4	34
10/82→01/90	T1 Platform/Chassis 309 D 3.0	OM 617.913 (OM 617)	Diesel	2998	5	38
01/82→12/94	T1 Platform/Chassis 310 2.3	M 102.942	Petrol	2298	4	47
06/89→02/96	T1 Platform/Chassis 310 D 2.9	OM 602.940 (OM 602)	Diesel	2874	5	34
07/81→01/89	T1/TN Box Body / Estate 407 D	OM 616.913 (OM 616)	Diesel	2399	4	38
07/81→01/89	T1/TN Box Body / Estate 407 D	OM 616.939 (OM 616)	Diesel	2399	4	38
11/88→06/95	T1/TN Box Body / Estate 408 D	OM 601.940 (OM 601)	Diesel	2299	4	34
04/82→01/89	T1/TN Box Body / Estate 409 D	OM 617.913 (OM 617)	Diesel	2998	5	38
08/82→06/95	T1/TN Box Body / Estate 410	M 102.942	Petrol	2298	4	47
08/82→06/95	T1/TN Box Body / Estate 410	M 102.945	Petrol	2299	4	47
11/88→06/95	T1/TN Box Body / Estate 410 D	OM 602.940 (OM 602)	Diesel	2874	5	34
07/81→01/89	T1/TN Platform/Chassis 407 D	OM 616.913 (OM 616)	Diesel	2399	4	38
07/81→01/89	T1/TN Platform/Chassis 407 D	OM 616.939 (OM 616)	Diesel	2399	4	38
11/88→06/95	T1/TN Platform/Chassis 408 D	OM 601.940 (OM 601)	Diesel	2299	4	34
04/82→01/89	T1/TN Platform/Chassis 409 D	OM 617.913 (OM 617)	Diesel	2998	5	38
08/82→06/95	T1/TN Platform/Chassis 410	M 102.942	Petrol	2298	4	47
08/82→06/95	T1/TN Platform/Chassis 410	M 102.945	Petrol	2299	4	47
11/88→06/95	T1/TN Platform/Chassis 410 D	OM 602.940 (OM 602)	Diesel	2874	5	34
01/72→12/80	T2/L Box Body / Estate L 405 D	OM 615 (OM 615)	Diesel	2197	4	22
01/68→12/74	T2/L Box Body / Estate L 406 DG	OM 615.910 (OM 615)	Diesel	2197	4	23
01/75→12/88	T2/L Box Body / Estate L 407 D	OM 616.910 (OM 616)	Diesel	2399/2404	4	39
08/82→12/88	T2/L Box Body / Estate L 410	M 102.943 (M 102)	Petrol	2299	4	47
08/82→09/83	T2/L Dumptruck LK 408 G, LK 409	M 102.943 (M 102)	Petrol	2299	4	47
01/72→12/80	T2/L Platform/Chassis L 405 D	OM 615 (OM 615)	Diesel	2197	4	22
01/68→12/74	T2/L Platform/Chassis L 406 DG	OM 615.910 (OM 615)	Diesel	2197	4	23
01/75→12/88	T2/L Platform/Chassis L 407 D	OM 616.910 (OM 616)	Diesel	2399/2404	4	39
01/75→12/88	T2/L Platform/Chassis L 407 D	OM 616.917 (OM 616)	Diesel	2399/2404	4	39
08/82→12/88	T2/L Platform/Chassis L 410	M 102.943 (M 102)	Petrol	2299	4	47
04/86→04/89	T2/LN1 Box Body / Estate 507 D	OM 616.914 (OM 616)	Diesel	2399	4	38
03/89→12/94	T2/LN1 Box Body / Estate 508 D	OM 601.941 (OM 601)	Diesel	2299	4	34
04/86→12/94	T2/LN1 Box Body / Estate 510	M 102.946	Petrol	2299	4	47
04/86→04/89	T2/LN1 Dumptruck 507 DK	OM 616.914 (OM 616)	Diesel	2399	4	38
03/89→12/94	T2/LN1 Dumptruck 508 D	OM 601.941 (OM 601)	Diesel	2299	4	34
04/86→04/89	T2/LN1 Platform/Chassis 507 D	OM 616.914 (OM 616)	Diesel	2399	4	38
04/86→12/94	T2/LN1 Platform/Chassis 510	M 102.946	Petrol	2299	4	47
	U 40, U 55	OM 615.916 (OM 615)	Diesel	2197	4	23
	U 40, U 55	OM 615.930 (OM 615)	Diesel	2197	4	23
01/68→12/71	U 40, U55	OM 615.914 (OM 615)	Diesel	2197	4	23
08/73→07/78	U 60	OM 616.933 (OM 616)	Diesel	2399/2404	4	39
10/69→12/76	U 404	OM 615.932 (OM 615)	Diesel	2197	4	23
08/73→07/78	U 600	OM 616.933 (OM 616)	Diesel	2399/2404	4	39
05/88→02/01	U 600	OM 616.944 (OM 616)	Diesel	2399	4	38
05/88→02/01	U 650	OM 616.944 (OM 616)	Diesel	2399	4	38
01/66→04/71	Unimog U 45	OM 615.911 (OM 615)	Diesel	2197	4	22
01/77→05/88	Unimog U 52, U 60, U 600,U 600L	OM 616.911 (OM 616)	Diesel	2399/2404	4	39
01/77→05/88	Unimog U 52, U 60, U 600,U 600L	OM 616.932 (OM 616)	Diesel	2399/2404	4	39
01/77→05/88	Unimog U 60T, U 600T	OM 616.911 (OM 616)	Diesel	2399/2404	4	39
01/77→05/88	Unimog U 60T, U 600T	OM 616.932 (OM 616)	Diesel	2399/2404	4	39
11/92→	Unimog U 90	OM 602.941 (OM 602)	Diesel	2874	5	34
07/96→	Unimog U 90	OM 602.981 Euro 2 (OM 602 D29 LA)	Diesel	2874	5	34
07/96→	Unimog U 90	OM 602.989 Euro 2 (OM 602 D29 LA)	Diesel	2874	5	34
11/92→	Unimog U 100L	OM 602.948 (OM 602)	Diesel	2874	5	34

MODEL INDEX

Modelverzeichnis • Index de modele • Índice de Modelo
Indeks modelu • Модель автомобиля • دليل الموديل



CCM

x



9

07/96→	Unimog U 100L	OM 602.981 Euro 2 (OM 602 D29 LA)	Diesel	2874	5	34
07/96→	Unimog U 100L	OM 602.989 Euro 2 (OM 602 D29 LA)	Diesel	2874	5	34
05/88→	Unimog U 600	OM 616.942 (OM 616)	Diesel	2399	4	38
05/88→	Unimog U 600	OM 616.943 (OM 616)	Diesel	2399	4	38
05/88→	Unimog U 650,U 650L	OM 616.942 (OM 616)	Diesel	2399	4	38
05/88→	Unimog U 650,U 650L	OM 616.943 (OM 616)	Diesel	2399	4	38
01/68→	Unimog U S 404	OM 615.911 (OM 615)	Diesel	2197	4	22
09/96→	Unimog UX 100H,UX 100M	OM 602.981 Euro 2 (OM 602 D29 LA)	Diesel	2874	5	34
09/96→	Unimog UX 100H,UX 100M	OM 602.989 Euro 2 (OM 602 D29 LA)	Diesel	2874	5	34
04/96→09/03	V 230	M 111.980	Petrol	2295	4	37
06/02→07/05	Vaneo 1.4	M 166.940	Petrol	1397	4	3
02/02→07/05	Vaneo 1.6	M 166.961	Petrol	1598	4	3
02/02→07/05	Vaneo 1.7 CDI	OM 668.914	Diesel	1689	4	4
09/96→	Vario Box Body / Estate 512 D	OM 602.984 (OM 602 LA)	Diesel	2874	5	34
09/96→	Vario Box Body / Estate 612 D	OM 602.984 (OM 602 LA)	Diesel	2874	5	34
09/96→	Vario Box Body / Estate 612 D	OM 602.985 (OM 602 LA)	Diesel	2874	5	34
09/96→	Vario Box Body / Estate 812 D	OM 602.984 (OM 602 LA)	Diesel	2874	5	34
09/96→	Vario Box Body / Estate 812 D	OM 602.985 (OM 602 LA)	Diesel	2874	5	34
09/96→	Vario Bus O 812	OM 602.984 (OM 602 LA)	Diesel	2874	5	34
09/96→	Vario Bus O 812	OM 602.985 (OM 602 LA)	Diesel	2874	5	34
09/96→	Vario Dumptruck 612 D	OM 602.984 (OM 602 LA)	Diesel	2874	5	34
09/96→	Vario Dumptruck 612 D	OM 602.985 (OM 602 LA)	Diesel	2874	5	34
09/96→	Vario Dumptruck 812 D	OM 602.984 (OM 602 LA)	Diesel	2874	5	34
09/96→	Vario Dumptruck 812 D	OM 602.985 (OM 602 LA)	Diesel	2874	5	34
09/96→	Vario Platform/Chassis 512 D	OM 602.984 (OM 602 LA)	Diesel	2874	5	34
09/96→	Vario Platform/Chassis 612 D	OM 602.984 (OM 602 LA)	Diesel	2874	5	34
09/96→	Vario Platform/Chassis 612 D	OM 602.985 (OM 602 LA)	Diesel	2874	5	34
09/96→	Vario Platform/Chassis 812 D	OM 602.984 (OM 602 LA)	Diesel	2874	5	34
09/96→	Vario Platform/Chassis 812 D	OM 602.985 (OM 602 LA)	Diesel	2874	5	34
02/97→07/03	V-Class V 200	M 111.948	Petrol	1998	4	35
02/97→07/03	V-Class V 200	M 111.950	Petrol	1998	4	35
03/99→07/03	V-Class V 200 CDI	OM 611.980 Euro 3 (OM 611 LA)	Diesel	2148	4	26
03/99→07/03	V-Class V 220 CDI	OM 611.980 Euro 3 (OM 611 LA)	Diesel	2148	4	26
10/96→07/03	V-Class V 230	M 111.978	Petrol	2295	4	37
09/96→07/03	V-Class V 230 TD	OM 601A.970 (OM 601 LA)	Diesel	2299	4	34
06/04→	Viano 3.7	M 112.976	Petrol	3724	V6	50
04/96→	Viano 230	M 111.980	Petrol	2295	4	37
08/05→	Viano CDI 2.0	OM 646.982 Euro 4	Diesel	2148	4	28
09/03→	Viano CDI 2.0	OM 646.982 Euro 4	Diesel	2148	4	28
07/10→	Viano CDI 2.0	OM 651.940	Diesel	2143	4	11
07/05→	Viano CDI 2.0 4-matic	OM 646.982 Euro 4	Diesel	2148	4	28
07/10→	Viano CDI 2.0 4-matic	OM 651.940	Diesel	2143	4	11
09/03→	Viano CDI 2.2	OM 646.982 Euro 4	Diesel	2148	4	28
07/10→	Viano CDI 2.2	OM 651.940	Diesel	2143	4	11
07/05→	Viano CDI 2.2 4-matic	OM 646.982 Euro 4	Diesel	2148	4	28
07/10→	Viano CDI 2.2 4-matic	OM 651.940	Diesel	2143	4	11
03/06→	Viano CDI 3.0	OM 642.990	Diesel	2987	V6	10
07/10→	Viano CDI 3.0	OM 642.990	Diesel	2987	V6	10
08/06→	Vito / Mixto Box 109 CDi	OM 646.981	Diesel	2148	4	29
09/03→	Vito / Mixto Box 109 CDI	OM 646.983	Diesel	2148	4	28
09/10→	Vito / Mixto Box 110 CDI	OM 651.940	Diesel	2143	4	11
09/03→	Vito / Mixto Box 111 CDI	OM 646.982 Euro 4	Diesel	2148	4	28
09/07→	Vito / Mixto Box 111 CDI	OM 646.982 Euro 4	Diesel	2148	4	28
09/07→	Vito / Mixto Box 111 CDI 4x4	OM 646.982 Euro 4	Diesel	2148	4	28
09/10→	Vito / Mixto Box 113 CDI	OM 651.940	Diesel	2143	4	11
09/10→	Vito / Mixto Box 113 CDI 4x4	OM 651.940	Diesel	2143	4	11
09/03→	Vito / Mixto Box 115 CDI	OM 646.982 Euro 4	Diesel	2148	4	28
07/06→	Vito / Mixto Box 115 CDI 4x4	OM 646.982 Euro 4	Diesel	2148	4	28
09/10→	Vito / Mixto Box 116 CDI	OM 651.940	Diesel	2143	4	11
09/10→	Vito / Mixto Box 116 CDI 4x4	OM 651.940	Diesel	2143	4	11



CCM

x



9

07/06→	Vito / Mixto Box 120 CDI	OM 642.990	Diesel	2987	V6	10
06/04→07/08	Vito / Mixto Box 123	M 112.976	Petrol	3724	V6	50
11/95→07/03	Vito 114	M 111.980	Petrol	2295	4	37
03/97→07/03	Vito Box 108 D 2.3	OM 601.942 (OM 601)	Diesel	2299	4	34
03/99→07/03	Vito Box 110 CDI 2.2	OM 611LA (75 KW CDI)	Diesel	2148	4	26
03/97→07/03	Vito Box 110 D 2.3	OM 601A.970 (OM 601 LA)	Diesel	2299	4	34
03/99→07/03	Vito Box 112 CDI 2.2	OM 611.980 Euro 3 (OM 611 LA)	Diesel	2148	4	26
03/97→07/03	Vito Box 113 2.0	M 111.948	Petrol	1998	4	35
03/97→07/03	Vito Box 113 2.0	M 111.950	Petrol	1998	4	35
03/97→07/03	Vito Box 114 2.3	M 111.978	Petrol	2295	4	37
02/96→07/03	Vito Bus 108 D 2.3	OM 601.942 (OM 601)	Diesel	2299	4	34
09/06→	Vito Bus 109 CDI	OM 646.980	Diesel	2148	4	29
09/03→	Vito Bus 109 CDI	OM 646.983	Diesel	2148	4	28
09/07→	Vito Bus 109 CDI 4x4	OM 646.981	Diesel	2148	4	29
09/10→	Vito Bus 110 CDI	OM 651.940	Diesel	2143	4	11
03/99→07/03	Vito Bus 110 CDI 2.2	OM 611LA (75 KW CDI)	Diesel	2148	4	26
02/96→07/03	Vito Bus 110 TD 2.3	OM 601A.970 (OM 601 LA)	Diesel	2299	4	34
09/03→	Vito Bus 111 CDI	OM 646.982 Euro 4	Diesel	2148	4	28
09/07→	Vito Bus 111 CDI	OM 646.982 Euro 4	Diesel	2148	4	28
09/07→	Vito Bus 111 CDI 4x4	OM 646.982 Euro 4	Diesel	2148	4	28
03/99→07/03	Vito Bus 112 CDI 2.2	OM 611.980 Euro 3 (OM 611 LA)	Diesel	2148	4	26
02/96→07/03	Vito Bus 113 2.0	M 111.948	Petrol	1998	4	35
02/96→07/03	Vito Bus 113 2.0	M 111.950	Petrol	1998	4	35
09/10→	Vito Bus 113 CDI	OM 651.940	Diesel	2143	4	11
09/10→	Vito Bus 113 CDI 4x4	OM 651.940	Diesel	2143	4	11
12/96→07/03	Vito Bus 114 2.3	M 111.978	Petrol	2295	4	37
09/03→	Vito Bus 115 CDI	OM 646.982 Euro 4	Diesel	2148	4	28
09/07→	Vito Bus 115 CDI 4x4	OM 646.982 Euro 4	Diesel	2148	4	28
09/10→	Vito Bus 116 CDI	OM 651.940	Diesel	2143	4	11
09/10→	Vito Bus 116 CDI 4x4	OM 651.940	Diesel	2143	4	11
07/06→	Vito Bus 120 CDI	OM 642.990	Diesel	2987	V6	10
06/04→	Vito Bus 123	M 112.976	Petrol	3724	V6	50

ENGINE INDEX

Motorverzeichnis • Index de moteur • Índice de Motor
Indeks silnika • Модель двигателя • دليل المحرك



CCM

x



9

M 102.910	Petrol	1797	4	89.00	32
M 102.919	Petrol	1797	4	89.00	32
M 102.920	Petrol	1997	4	89.00	32
M 102.921	Petrol	1997	4	89.00	32
M 102.922	Petrol	1997	4	89.00	32
M 102.924	Petrol	1997	4	89.00	32
M 102.939	Petrol	1997	4	89.00	32
M 102.942	Petrol	2298	4	95.50	47
M 102.943 (M 102)	Petrol	2299	4	95.50	47
M 102.945	Petrol	2299	4	95.50	47
M 102.946	Petrol	2299	4	95.50	47
M 102.958	Petrol	2299	4	95.50	47
M 102.961	Petrol	1997	4	89.00	32
M 102.962	Petrol	1997	4	89.00	32
M 102.963	Petrol	1997	4	89.00	32
M 102.964	Petrol	1997	4	89.00	32
M 102.965	Petrol	1996	4	89.00	32
M 102.979	Petrol	2299	4	95.50	47
M 102.980	Petrol	2299	4	95.50	47
M 102.981	Petrol	2299	4	95.50	47
M 102.982	Petrol	2299	4	95.50	47
M 102.983	Petrol	2299	4	95.50	48
M 102.985	Petrol	2299	4	95.50	47
M 102.987	Petrol	2299	4	95.50	47
M 102.989	Petrol	2299	4	95.50	47
M 102.990	Petrol	2499	4	95.50	48
M 102.991	Petrol	2499	4	95.50	48
M 102.996	Petrol	2299	4	95.50	47
M 102.997	Petrol	2299	4	95.50	47
M 102.998	Petrol	2299	4	95.50	47
M 103.940	Petrol	2599	6	82.90	7
M 103.941	Petrol	2599	6	82.90	7
M 103.942 (KAT)	Petrol	2599	6	82.90	7
M 103.943	Petrol	2599	6	82.90	7
M 103.980	Petrol	2962	6	88.50	30
M 103.981 (KAT)	Petrol	2962	6	88.50	30
M 103.982	Petrol	2962	6	88.50	30
M 103.983	Petrol	2962	6	88.50	30
M 103.984	Petrol	2962	6	88.50	30
M 103.985	Petrol	2962	6	88.50	30
M 103.987	Petrol	2962	6	88.50	30
M 104.941	Petrol	2799	6	89.90	35
M 104.942	Petrol	2799	6	89.90	35
M 104.943	Petrol	2799	6	89.90	35
M 104.944	Petrol	2799	6	89.90	35
M 104.945	Petrol	2799	6	89.90	35
M 104.980	Petrol	2960	6	88.50	31
M 104.981	Petrol	2960	6	88.50	31
M 104.990	Petrol	3199	6	89.90	35
M 104.991	Petrol	3199	6	89.90	35
M 104.992	Petrol	3199	6	89.90	35
M 104.994	Petrol	3199	6	89.90	35
M 104.995	Petrol	3199	6	89.90	35
M 104.996	Petrol	3199	6	89.90	35
M 110.921	Petrol	2746	6	86.00	15
M 110.922	Petrol	2746	6	86.00	15
M 110.923	Petrol	2746	6	86.00	15
M 110.924	Petrol	2746	6	86.00	15
M 110.926	Petrol	2746	6	86.00	15
M 110.981	Petrol	2746	6	86.00	15

Motorverzeichnis • Index de moteur • Índice de Motor
Indeks silnika • Модель двигателя • دليل المحرك

ENGINE INDEX



CCM

x



9

M 110.982	Petrol	2746	6	86.00	15
M 110.983	Petrol	2746	6	86.00	15
M 110.984	Petrol	2746	6	86.00	15
M 110.985	Petrol	2746	6	86.00	15
M 110.986	Petrol	2746	6	86.00	15
M 110.987	Petrol	2746	6	86.00	15
M 110.988	Petrol	2746	6	86.00	15
M 110.989	Petrol	2746	6	86.00	15
M 110.990	Petrol	2746	6	86.00	15
M 111	Petrol	1799	4	85.30	14
M 111.920	Petrol	1799	4	85.30	14
M 111.921	Petrol	1799	4	85.30	14
M 111.940	Petrol	1998	4	89.90	35
M 111.941	Petrol	1998	4	89.90	35
M 111.942	Petrol	1998	4	89.90	35
M 111.943	Petrol	1998	4	89.90	35
M 111.944	Petrol	1998	4	89.90	35
M 111.945	Petrol	1998	4	89.90	35
M 111.946	Petrol	1998	4	89.90	35
M 111.947	Petrol	1998	4	89.90	35
M 111.948	Petrol	1998	4	89.90	35
M 111.950	Petrol	1998	4	89.90	35
M 111.951	Petrol	1998	4	89.90	35
M 111.952	Petrol	1998	4	89.90	35
M 111.955	Petrol	1998	4	89.90	35
M 111.956	Petrol	1998	4	89.90	35
M 111.957	Petrol	1998	4	89.90	35
M 111.958	Petrol	1998	4	89.90	35
M 111.960	Petrol	2199	4	89.90	35
M 111.961	Petrol	2199	4	89.90	35
M 111.970	Petrol	2295	4	90.90	37
M 111.973	Petrol	2295	4	90.90	37
M 111.974	Petrol	2295	4	90.90	37
M 111.975	Petrol	2295	4	90.90	37
M 111.977	Petrol	2295	4	90.90	37
M 111.978	Petrol	2295	4	90.90	37
M 111.979	Petrol	2295	4	90.90	37
M 111.980	Petrol	2295	4	90.90	37
M 111.981	Petrol	2295	4	90.90	37
M 111.982	Petrol	2295	4	90.90	37
M 111.983	Petrol	2295	4	90.90	37
M 111.984	Petrol	2295	4	90.90	37
M 112.910	Petrol	2398	V6	83.20	12
M 112.911	Petrol	2398	V6	83.20	12
M 112.920	Petrol	2799	V6	89.90	36
M 112.921	Petrol	2799	V6	89.90	36
M 112.922	Petrol	2799	V6	89.90	36
M 112.923	Petrol	2799	V6	89.90	36
M 112.925	Petrol	2799	V6	89.90	36
M 112.940	Petrol	3199	V6	89.90	36
M 112.941	Petrol	3199	V6	89.90	36
M 112.942	Petrol	3199	V6	89.90	36
M 112.943	Petrol	3199	V6	89.90	36
M 112.944	Petrol	3199	V6	89.90	36
M 112.945	Petrol	3199	V6	89.90	36
M 112.946	Petrol	3199	V6	89.90	36
M 112.947	Petrol	3199	V6	89.90	36
M 112.949	Petrol	3199	V6	89.90	36
M 112.970	Petrol	3724	V6	97.00	50
M 112.972	Petrol	3724	V6	97.00	50

ENGINE INDEX

Motorverzeichnis • Index de moteur • Índice de Motor
Indeks silnika • Модель двигателя • دليل المحرك



CCM

x



9

M 112.973	Petrol	3724	V6	97.00	50
M 112.975	Petrol	3724	V6	97.00	50
M 112.976	Petrol	3724	V6	97.00	50
M 113.940	Petrol	4266	V8	89.90	36
M 113.941	Petrol	4266	V8	89.90	36
M 113.942	Petrol	4266	V8	89.90	36
M 113.943	Petrol	4266	V8	89.90	36
M 113.944	Petrol	4266	V8	89.90	36
M 113.960	Petrol	4966	V8	97.00	50
M 113.961	Petrol	4966	V8	97.00	50
M 113.962	Petrol	4966	V8	97.00	50
M 113.963	Petrol	4966	V8	97.00	50
M 113.964	Petrol	4966	V8	97.00	50
M 113.965	Petrol	4966	V8	97.00	50
M 113.966	Petrol	4966	V8	97.00	50
M 113.967	Petrol	4966	V8	97.00	50
M 113.968	Petrol	4966	V8	97.00	50
M 113.969	Petrol	4966	V8	97.00	50
M 113.971	Petrol	4966	V8	97.00	50
M 113.980	Petrol	5439	V8	97.00	50
M 113.981	Petrol	5439	V8	97.00	50
M 113.984	Petrol	5439	V8	97.00	50
M 115.923	Petrol	1988	4	87.00	18
M 115.926	Petrol	1988	4	87.00	18
M 115.938	Petrol	1988	4	87.00	18
M 115.939	Petrol	1988	4	87.00	18
M 115.951	Petrol	2308	4	93.75	46
M 115.954	Petrol	2308	4	93.75	46
M 115.955	Petrol	2308	4	93.75	46
M 115.972	Petrol	2308	4	93.75	46
M 115.973	Petrol	2308	4	93.75	46
M 116.960	Petrol	3818	V8	92.00	41
M 116.961	Petrol	3839	V8	88.00	24
M 116.962	Petrol	3839	V8	88.00	24
M 116.963	Petrol	3839	V8	88.00	24
M 116.964	Petrol	4196	V8	92.00	42
M 116.965	Petrol	4196	V8	92.00	42
M 116.980	Petrol	3499	V8	92.00	43
M 116.981	Petrol	3499	V8	92.00	43
M 116.982	Petrol	3499	V8	92.00	43
M 116.983	Petrol	3499	V8	92.00	43
M 116.984	Petrol	3499	V8	92.00	43
M 116.985	Petrol	3499	V8	92.00	43
M 117.960	Petrol	4973	V8	96.50	49
M 117.961	Petrol	4973	V8	96.50	49
M 117.963	Petrol	4973	V8	96.50	49
M 117.964	Petrol	4973	V8	96.50	49
M 117.967	Petrol	5547	V8	96.50	49
M 117.968 (KAT)	Petrol	5547	V8	96.50	49
M 117.982	Petrol	4520	V8	92.00	43
M 117.983	Petrol	4520	V8	92.00	43
M 117.986	Petrol	4520	V8	92.00	43
M 119.960	Petrol	4973	V8	96.50	49
M 119.970	Petrol	4973	V8	96.50	49
M 119.971	Petrol	4196	V8	92.00	44
M 119.972	Petrol	4973	V8	96.50	49
M 119.974	Petrol	4973	V8	96.50	49
M 119.975	Petrol	4196	V8	92.00	45
M 119.980	Petrol	4973	V8	96.50	49
M 119.981	Petrol	4196	V8	92.00	45

Motorverzeichnis • Index de moteur • Índice de Motor
Indeks silnika • Модель двигателя • دليل المحرك

ENGINE INDEX



CCM

x



9

M 119.982	Petrol	4973	V8	96.50	49
M 119.985	Petrol	4196	V8	92.00	45
M 120.980	Petrol	5987	V12	89.00	33
M 120.981	Petrol	5987	V12	89.00	33
M 120.983	Petrol	5987	V12	89.00	33
M 121.920	Petrol	1898	4	85.00	13
M 121.922	Petrol	1897	4	85.00	13
M 121.924	Petrol	1898	4	85.00	13
M 123.921	Petrol	2527	6	86.00	15
M 130.920	Petrol	2750	6	86.50	17
M 130.923	Petrol	2750	6	86.50	17
M 130.980	Petrol	2750	6	86.50	17
M 130.981	Petrol	2750	6	86.50	17
M 130.983	Petrol	2750	6	86.50	17
M 130.984	Petrol	2778	6	86.50	17
M 160 E6AL B03	Petrol	599	3	63.50	1
M 160 E6AL B04	Petrol	599	3	63.50	1
M 161.971	Petrol	2295	4	90.90	37
M 166.940	Petrol	1397	4	80.00	3
M 166.960	Petrol	1598	4	80.00	3
M 166.961	Petrol	1598	4	80.00	3
M 266.920	Petrol	1498	4	83.00	8
M 266.940	Petrol	1699	4	83.00	8
M 266.960	Petrol	2034	4	83.00	8
M 271.910	Petrol	1597	4	82.00	5
M 271.911	Petrol	1597	4	82.00	5
M 271.921	Petrol	1796	4	82.00	5
M 271.940 (M271 SE18)	Petrol	1796	4	82.00	5
M 271.941 (M271 SE18)	Petrol	1796	4	82.00	5
M 271.942 (M271 DE18)	Petrol	1796	4	82.00	6
M 271.944	Petrol	1795	4	82.00	5
M 271.946 (M271 SE18)	Petrol	1796	4	82.00	5
M 271.948 (M271 SE18)	Petrol	1796	4	82.00	5
M 271.950	Petrol	1796	4	82.00	5
M 271.951	Petrol	1796	4	82.00	5
M 271.952	Petrol	1796	4	82.00	5
M 271.954	Petrol	1796	4	82.00	5
M 271.955	Petrol	1796	4	82.00	5
M 271.956	Petrol	1796	4	82.00	5
M 271.957	Petrol	1796	4	82.00	5
M 271.958	Bi-fuel (Petrol/ Gas)	1796	4	82.00	5
M 272.911	Petrol	2496	V6	88.00	25
M 272.920	Petrol	2496	V6	88.00	25
M 272.921	Petrol	2496	V6	88.00	25
M 272.922	Petrol	2496	V6	88.00	25
M 272.940	Petrol	2996	V6	88.00	25
M 272.941	Petrol	2996	V6	88.00	25
M 272.942	Petrol	2996	V6	88.00	25
M 272.943	Petrol	2996	V6	88.00	25
M 272.944	Petrol	2996	V6	88.00	25
M 272.945	Petrol	2996	V6	88.00	25
M 272.946	Petrol	2996	V6	88.00	25
M 272.947	Petrol	2996	V6	88.00	25
M 272.948	Petrol	2996	V6	88.00	25
M 272.949	Petrol	2996	6	88.00	25
M 272.952	Petrol	2996	V6	88.00	25
OM 601.900 Euro 2 (OM 601 D23)	Diesel	2299	4	89.00	34
OM 601.911	Diesel	1978	4	87.00	19

ENGINE INDEX

Motorverzeichnis • Index de moteur • Índice de Motor
Indeks silnika • Модель двигателя • دليل المحرك



CCM



9

OM 601.912	Diesel	1978	4	87.00	19
OM 601.913	Diesel	1997	4	87.00	20
OM 601.915	Diesel	1997	4	87.00	20
OM 601.940 (OM 601)	Diesel	2299	4	89.00	34
OM 601.941 (OM 601)	Diesel	2299	4	89.00	34
OM 601.942 (OM 601)	Diesel	2299	4	89.00	34
OM 601.943 (OM 601)	Diesel	2299	4	89.00	34
OM 601A.970 (OM 601 LA)	Diesel	2299	4	89.00	34
OM 602.911	Diesel	2497	5	87.00	19
OM 602.912	Diesel	2497	5	87.00	19
OM 602.930	Diesel	2497	5	87.00	19
OM 602.931	Diesel	2497	5	87.00	20
OM 602.938	Diesel	2497	5	87.00	20
OM 602.939	Diesel	2497	5	87.00	20
OM 602.940	Diesel	2874	5	89.00	34
OM 602.940 (OM 602)	Diesel	2874	5	89.00	34
OM 602.941 (OM 602)	Diesel	2874	5	89.00	34
OM 602.942	Diesel	2874	5	89.00	34
OM 602.946	Diesel	2874	5	89.00	34
OM 602.947	Diesel	2874	5	89.00	34
OM 602.948 (OM 602)	Diesel	2874	5	89.00	34
OM 602.961	Diesel	2497	5	87.00	21
OM 602.980 (OM 602 DE 29LA)	Diesel	2874	5	89.00	34
OM 602.981 Euro 2 (OM 602 D29 LA)	Diesel	2874	5	89.00	34
OM 602.982	Diesel	2874	5	89.00	34
OM 602.983	Diesel	2874	5	89.00	34
OM 602.984 (OM 602 LA)	Diesel	2874	5	89.00	34
OM 602.985 (OM 602 LA)	Diesel	2874	5	89.00	34
OM 602.986	Diesel	2874	5	89.00	34
OM 602.989 Euro 2 (OM 602 D29 LA)	Diesel	2874	5	89.00	34
OM 602.990 (OM 602)	Diesel	2497	5	87.00	20
OM 602.991 (OM 602)	Diesel	2874	5	89.00	34
OM 602.994 (OM 602)	Diesel	2874	5	89.00	34
OM 602A.962	Diesel	2497	5	87.00	21
OM 603.912	Diesel	2996	6	87.00	19
OM 603.913	Diesel	2996	6	87.00	19
OM 603.931	Diesel	2996	6	87.00	20
OM 603.961	Diesel	2996	6	87.00	21
OM 603A.960	Diesel	2996	6	87.00	21
OM 603A.963	Diesel	2996	6	87.00	21
OM 603A.970	Diesel	3449	6	89.00	34
OM 603A.971	Diesel	3449	6	89.00	34
OM 603A.972	Diesel	3449	6	89.00	34
OM 604.910	Diesel	2155	4	89.00	34
OM 604.912	Diesel	2155	4	89.00	34
OM 604.915	Diesel	1997	4	87.00	20
OM 604.917	Diesel	1997	4	87.00	20
OM 605.910	Diesel	2497	5	87.00	20
OM 605.911	Diesel	2497	5	87.00	20
OM 605.912	Diesel	2497	5	87.00	20
OM 605.960	Diesel	2497	5	87.00	21
OM 605.962	Diesel	2497	5	87.00	21
OM 606.910	Diesel	2996	6	87.00	20
OM 606.912	Diesel	2996	6	87.00	20
OM 606.961	Diesel	2996	6	87.00	21
OM 606.962	Diesel	2996	6	87.00	21
OM 606.964	Diesel	2996	6	87.00	21
OM 611.960	Diesel	2148	4	88.00	26
OM 611.961	Diesel	2148	4	88.00	26
OM 611.962	Diesel	2148	4	88.00	26



CCM

x



9

OM 611.980 Euro 3 (OM 611 LA)	Diesel	2148	4	88.00	26
OM 611.981 Euro 3	Diesel	2148	4	88.00	26
OM 611.987 Euro 3	Diesel	2148	4	88.00	26
OM 611LA (75 KW CDI)	Diesel	2148	4	88.00	26
OM 612.961	Diesel	2688	5	88.00	26
OM 612.962	Diesel	2685	5	88.00	26
OM 612.963	Diesel	2685	5	88.00	26
OM 612.966	Diesel	2685	5	88.00	26
OM 612.967	Diesel	2685	5	88.00	26
OM 612.981	Diesel	2685	5	88.00	26
OM 613.960	Diesel	3222	6	88.00	26
OM 613.961	Diesel	3226	6	88.00	26
OM 615 (OM 615)	Diesel	2197	4	87.00	22
OM 615.910 (OM 615)	Diesel	2197	4	87.00	23
OM 615.911 (OM 615)	Diesel	2197	4	87.00	22
OM 615.912	Diesel	2197	4	87.00	23
OM 615.913	Diesel	1988	4	87.00	23
OM 615.914 (OM 615)	Diesel	2197	4	87.00	23
OM 615.915	Diesel	1988	4	87.00	22
OM 615.916 (OM 615)	Diesel	2197	4	87.00	23
OM 615.917	Diesel	2197	4	87.00	22
OM 615.918 (OM 615)	Diesel	2197	4	87.00	22
OM 615.930 (OM 615)	Diesel	2197	4	87.00	23
OM 615.932 (OM 615)	Diesel	2197	4	87.00	23
OM 615.936 (OM 615)	Diesel	2197	4	87.00	22
OM 615.937 (OM 615)	Diesel	2197	4	87.00	22
OM 615.938 (OM 615)	Diesel	2197	4	87.00	23
OM 615.939 (OM 615)	Diesel	2197	4	87.00	22
OM 615.940	Diesel	1988	4	87.00	22
OM 615.941	Diesel	2197	4	87.00	22
OM 615.942 (OM 615)	Diesel	1988	4	87.00	22
OM 615.943 (OM 615)	Diesel	1988	4	87.00	22
OM 615.944 (OM 615)	Diesel	1988	4	87.00	22
OM 615.961 (OM 615)	Diesel	1988	4	87.00	22
OM 615.963 (OM 615)	Diesel	1988	4	87.00	22
OM 615.964 (OM 615)	Diesel	1988	4	87.00	22
OM 615.965 (OM 615)	Diesel	1988	4	87.00	22
OM 615.966 (OM 615)	Diesel	1988	4	87.00	22
OM 615.967 (OM 615)	Diesel	1988	4	87.00	22
OM 615.968 (OM 615)	Diesel	1988	4	87.00	22
OM 615.969 (OM 615)	Diesel	1988	4	87.00	22
OM 615.970 (OM 615)	Diesel	1988	4	87.00	22
OM 616.910 (OM 616)	Diesel	2399/2404	4	90.90	39
OM 616.910 (OM 616)	Diesel	2399/2404	4	91.00	39
OM 616.911 (OM 616)	Diesel	2399/2404	4	90.90	39
OM 616.911 (OM 616)	Diesel	2399/2404	4	91.00	39
OM 616.912	Diesel	2399/2404	4	90.90	39
OM 616.912	Diesel	2399/2404	4	91.00	39
OM 616.913 (OM 616)	Diesel	2399	4	90.90	38
OM 616.914 (OM 616)	Diesel	2399	4	90.90	38
OM 616.916	Diesel	2404	4	91.00	40
OM 616.917 (OM 616)	Diesel	2399/2404	4	90.90	39
OM 616.917 (OM 616)	Diesel	2399/2404	4	91.00	39
OM 616.932 (OM 616)	Diesel	2399/2404	4	90.90	39
OM 616.932 (OM 616)	Diesel	2399/2404	4	91.00	39
OM 616.933 (OM 616)	Diesel	2399/2404	4	90.90	39
OM 616.933 (OM 616)	Diesel	2399/2404	4	91.00	39
OM 616.934 (OM 616)	Diesel	2399/2404	4	90.90	39
OM 616.934 (OM 616)	Diesel	2399/2404	4	91.00	39
OM 616.936	Diesel	2399	4	90.90	38

ENGINE INDEX

Motorverzeichnis • Index de moteur • Índice de Motor
Indeks silnika • Модель двигателя • دليل المحرك



CCM



9

OM 616.937 (OM 616)	Diesel	2399	4	90.90	38
OM 616.938	Diesel	2399	4	90.90	38
OM 616.939 (OM 616)	Diesel	2399	4	90.90	38
OM 616.940 (OM 616)	Diesel	2399	4	90.90	38
OM 616.942 (OM 616)	Diesel	2399	4	90.90	38
OM 616.943 (OM 616)	Diesel	2399	4	90.90	38
OM 616.944 (OM 616)	Diesel	2399	4	90.90	38
OM 617.910	Diesel	2998	5	91.00	40
OM 617.912	Diesel	2998	5	90.90	39
OM 617.912	Diesel	2998	5	91.00	39
OM 617.913 (OM 617)	Diesel	2998	5	90.90	38
OM 617.931	Diesel	2998	5	90.90	38
OM 617.932	Diesel	2998	5	90.90	38
OM 617.933	Diesel	2998	5	90.90	38
OM 617.950	Diesel	2998	5	90.90	38
OM 617.951	Diesel	2998	5	90.90	38
OM 617.952	Diesel	2998	5	90.90	38
OM 628.960	Diesel	3996	V8	86.00	16
OM 628.961	Diesel	3996	V8	86.00	16
OM 628.962	Diesel	3996	V8	86.00	16
OM 628.963	Diesel	3996	V8	86.00	16
OM 636	Diesel	1767	4	75.00	2
OM 636.914 (OM 636)	Diesel	1767	4	75.00	2
OM 636.930	Diesel	1767	4	75.00	2
OM 636.931	Diesel	1767	4	75.00	2
OM 639.939 Euro 4	Diesel	1493	3	83.00	9
OM 640.940	Diesel	1991	4	83.00	9
OM 640.941	Diesel	1991	4	83.00	9
OM 640.942	Diesel	1991	4	83.00	9
OM 642.820	Diesel	2987	V6	83.00	10
OM 642.822	Diesel	2987	V6	83.00	10
OM 642.830	Diesel	2987	V6	83.00	10
OM 642.832	Diesel	2987	V6	83.00	10
OM 642.834	Diesel	2987	V6	83.00	10
OM 642.836	Diesel	2987	V6	83.00	10
OM 642.850	Diesel	2987	V6	83.00	10
OM 642.852	Diesel	2987	V6	83.00	10
OM 642.853	Diesel	2987	V6	83.00	10
OM 642.854 (OM 642 LS DE 30 LA)	Diesel	2987	V6	83.00	10
OM 642.856	Diesel	2987	V6	83.00	10
OM 642.858	Diesel	2987	V6	83.00	10
OM 642.862	Diesel	2987	V6	83.00	10
OM 642.868	Diesel	2987	V6	83.00	10
OM 642.870	Diesel	2987	V6	83.00	10
OM 642.872	Diesel	2987	V6	83.00	10
OM 642.884	Diesel	2987	V6	83.00	10
OM 642.886	Diesel	2987	V6	83.00	10
OM 642.896	Diesel	2987	V6	83.00	10
OM 642.898	Diesel	2987	V6	83.00	10
OM 642.910	Diesel	2987	6	83.00	10
OM 642.920	Diesel	2987	V6	83.00	10
OM 642.921	Diesel	2987	V6	83.00	10
OM 642.930	Diesel	2987	V6	83.00	10
OM 642.932	Diesel	2987	V6	83.00	10
OM 642.940	Diesel	2987	V6	83.00	10
OM 642.950	Diesel	2987	V6	83.00	10
OM 642.960	Diesel	2987	V6	83.00	10
OM 642.961	Diesel	2987	V6	83.00	10
OM 642.970	Diesel	2987	V6	83.00	10
OM 642.990	Diesel	2987	V6	83.00	10

Motorverzeichnis • Index de moteur • Índice de Motor
Indeks silnika • Модель двигателя • دليل المحرك

ENGINE INDEX



CCM



9

Part Number	Engine Type	CCM	Cylinders	Power (kW)	Power (hp)
OM 642.992	Diesel	2987	V6	83.00	10
OM 642.993	Diesel	2987	V6	83.00	10
OM 646.811	Diesel	2148	4	88.00	27
OM 646.812	Diesel	2148	4	88.00	27
OM 646.820	Diesel	2148	4	88.00	27
OM 646.821	Diesel	2148	4	88.00	27
OM 646.951	Diesel	2148	4	88.00	28
OM 646.961	Diesel	2148	4	88.00	28
OM 646.962	Diesel	2148	4	88.00	28
OM 646.963	Diesel	2148	4	88.00	28
OM 646.966	Diesel	2148	4	88.00	27
OM 646.980	Diesel	2148	4	88.00	29
OM 646.981	Diesel	2148	4	88.00	29
OM 646.982 Euro 4	Diesel	2148	4	88.00	28
OM 646.983	Diesel	2148	4	88.00	28
OM 646.984	Diesel	2148	4	88.00	27
OM 646.985	Diesel	2148	4	88.00	29
OM 646.986 Euro 4	Diesel	2148	4	88.00	29
OM 646.989	Diesel	2148	4	88.00	29
OM 646.990	Diesel	2148	4	88.00	27
OM 647.961	Diesel	2685	5	88.00	28
OM 647.981	Diesel	2685	5	88.00	28
OM 648.960	Diesel	3222	6	88.00	28
OM 648.961	Diesel	3222	6	88.00	28
OM 651.911	Diesel	2143	4	83.00	11
OM 651.912	Diesel	2143	4	83.00	11
OM 651.913	Diesel	2143	4	83.00	11
OM 651.916	Diesel	2143	4	83.00	11
OM 651.921	Diesel	2143	4	83.00	11
OM 651.924	Diesel	2143	4	83.00	11
OM 651.925	Diesel	2143	4	83.00	11
OM 651.930	Diesel	2143	4	83.00	11
OM 651.940	Diesel	2143	4	83.00	11
OM 651.955	Diesel	2143	4	83.00	11
OM 651.956	Diesel	2143	4	83.00	11
OM 651.957	Diesel	2143	4	83.00	11
OM 651.960	Diesel	2143	4	83.00	11
OM 651.961	Diesel	2143	4	83.00	11
OM 651.980	Diesel	2143	4	83.00	11
OM 668.914	Diesel	1689	4	80.00	4
OM 668.940 (OM 668 DE17LA)	Diesel	1689	4	80.00	4
OM 668.941 (OM 668 DE17A)	Diesel	1689	4	80.00	4
OM 668.942	Diesel	1689	4	80.00	4



Smart 600		07/98 →	M 160 E6AL B03		1	
			3cyl.			
			599cc		40kW (54PS)	
			Turbo Intercooled		TD9520	
Smart 600		07/98 →	M 160 E6AL B04		2	
			3cyl.			
			599cc		33kW (45PS)	
			Injection		TD16490	
08-136700-00	STD	63.50	1.200		001 CR	ST
08-136705-00	0.25mm		1.500		005 P	GOE12
08-136707-00	0.50mm		2.500		712 CR	ST
[R66860]						
170 D		01/49 → 12/63	OM 636		2	
180 D		01/54 → 12/63	4cyl.			
			1767cc		34kW (46PS)	
			Diesel		FM1112	
Ponton 180 D			OM 636.914 (OM 636)			
			4cyl.			
			1767cc		25kW (34PS)	
			Diesel		TD7969	
Ponton 180 D		01/53 → 07/59	OM 636.930			
			4cyl.			
			1767cc		32kW (44PS)	
			Diesel		TD2279	
170 S-D		07/53 → 02/58	OM 636.931			
			4cyl.			
			1767cc		29kW (39PS)	
			Diesel		TD9968	
08-163500-00	STD	75.00	2.000		001 IF CR P	STD
08-163511-00	1.00mm		2.000		001 IF P	STD
			2.000		001 IF P	STD
			5.000		231 P	STD
			5.000		030 P	STD
A-Class A 140		07/97 → 08/04	M 166.940		3	
Vaneo 1.4		06/02 → 07/05	4cyl.			
			1397cc		60kW (81PS)	
					TD9445	
A-Class A 140		01/01 → 08/04	M 166.960			
A-Class A 160		07/97 → 08/04	4cyl.			
			1598cc		75kW (102PS)	
					TD9446	
Vaneo 1.6		02/02 → 07/05	M 166.961			
			4cyl.			
			1598cc		60-75kW (82-102PS)	
					TD18174	
08-101200-00	STD	80.00	1.200		005 NT	ST
			1.750		026 CR P	KV1
			3.000		712 CR	ST



Vaneo 1.7 CDI		02/02→07/05	OM 668.914	4cyl. 1689cc	55-67kW (75-91PS)	4
			Diesel			TD18173
A-Class A 160 CDI		02/01→08/04	OM 668.940 (OM 668 DE17LA)	4cyl. 1689cc	60-70kW (82-95PS)	
A-Class A 170 CDI		07/98→02/01				TD10647
A-Class A 160 CDI		07/98→02/01	OM 668.941 (OM 668 DE17A)	4cyl. 1689cc	44-55kW (60-75PS)	
			Diesel	Turbo Intercooled		TD10648
A-Class A 170 CDI		02/01→08/04	OM 668.942	4cyl. 1689cc	60-70kW (82-95PS)	
			Diesel	Turbo Intercooled		TD17001
08-105400-00	STD	80.00	2.000		001 IF CK P	KV1
			2.000		005 IFU P	IKA
			3.000		231 CR P	GOE13
C-Class C 180 Kompressor, C-Class T-Model C 180 Kompressor		01/08→	M 271.910	4cyl. 1597cc	105-115kW (143-156PS)	5
				Supercharged		TD23992
CLC-Class CLC 160		02/09→06/11	M 271.911	4cyl. 1597cc	95kW (129PS)	
						TD23993
C-Class Coupe C 160 Kompressor		05/02→05/08	M 271.921	4cyl. 1796cc	90kW (122PS)	
				Supercharged		TD18424
C-Class C 200 Kompressor		05/02→02/07	M 271.940 (M271 SE18)	4cyl. 1796cc	120kW (163PS)	
C-Class Coupe C 200 Kompressor,		05/02→05/08				
C-Class Coupe C 220						
C-Class T-Model C 200 Kompressor		05/02→08/07				
CLK 200 Kompressor		09/02→05/09				
CLK Convertible CLK 200 Kompressor		02/03→03/10				TD16883
E-Class E 200 Kompressor		11/02→12/08	M 271.941 (M271 SE18)	4cyl. 1796cc	120kW (163PS)	
E-Class E 200 NGT		03/04→12/08				
E-Class T-Model E 200 T Kompressor		03/03→07/09				TD17329
SLK 200 Kompressor		03/04→02/11	M 271.944	4cyl. 1795cc	120kW (163PS)	
				Supercharged		TD17432
C-Class C 180 Kompressor		05/02→02/07	M 271.946 (M271 SE18)	4cyl. 1796cc	105-125kW (143-170PS)	
C-Class Coupe C 180 Kompressor		05/02→05/08				
C-Class T-Model C 180 Kompressor		05/02→08/07				
CLC-Class CLC 180 Kompressor		05/08→06/11				
E-Class E 200 CGI		11/02→12/08				TD17433
C-Class C 230 Kompressor		02/04→02/07	M 271.948 (M271 SE18)	4cyl. 1796cc	141kW (192PS)	
C-Class Coupe C 230 Kompressor		05/02→05/08				
C-Class T-Model C 230 Kompressor		02/04→08/07				TD17434





C-Class C 200 Kompressor	01/07→	M 271.950			
C-Class T-Model C 200 Kompressor	08/07→		4cyl.	1796cc	120kW (163PS)
TD20359					
Sprinter 3, 5 Platform/Chassis 316,	09/08→	M 271.951			
Sprinter 3, 5 Platform/Chassis 316 LGT,			4cyl.	1796cc	115kW (156PS)
Sprinter 3, 5 Platform/Chassis 316 NGT,					
Sprinter 3, 5-t Box 316, Sprinter 3,					
5-t Box 316 LGT, Sprinter 3,					
5-t Box 316 NGT, Sprinter 3, 5-t Bus 316,					
Sprinter 3, 5-t Bus 316 LGT, Sprinter 3,					
5-t Bus 316 NGT, Sprinter 3-T Box 216,					
Sprinter 3-T Bus 216,					
Sprinter 3-t Platform/Chassis 216,					
Sprinter 5-t Platform/Chassis 516,					
Sprinter 5-t Platform/Chassis 516 NGT					
TD23995					
C-Class C 180 Kompressor	01/07→	M 271.952			
C-Class T-Model C 180 Kompressor	08/07→		4cyl.	1796cc	115kW (156PS)
TD20358					
SLK 200 Kompressor	01/08→02/11	M 271.954			
			4cyl.	1796cc	135kW (184PS)
TD21027					
CLC-Class CLC 200 Kompressor	05/08→06/11	M 271.955			
CLK 200 Kompressor	10/06→05/09		4cyl.	1796cc	135kW (184PS)
CLK Convertible CLK 200 Kompressor	10/06→03/10				Supercharged
TD20858					
E-Class E 200 Kompressor	04/06→12/08	M 271.956			
E-Class T-Model E 200 Kompressor	04/06→07/09		4cyl.	1796cc	135kW (184PS)
TD22141					
CLC 200	05/08→	M 271.957			
			4cyl.	1796cc	120-135kW (163-184PS)
TD23994					
E-Class E 200 NGT	03/11→	M 271.958			
			4cyl.	1796cc	120-135kW (163-184PS)
TD25260					

08-427600-10 ⓘ STD	82.00	1.200		001 NT	ST
		1.500		005 P	GOE13
		2.500		712 NT	ST
ⓘ For Mahle OE piston		ⓘ Für OE-Kolben von Mahle		ⓘ Pour les pistones d'origine Mahle	
TD25260					

C-Class C 200 CGI Kompressor	07/03→02/07	M 271.942 (M271 DE18)			
C-Class Coupe C 200 CGI Kompressor	03/03→05/08		4cyl.	1796cc	125kW (170PS)
C-Class T-Model C 200 CGI Kompressor	07/03→08/07				Supercharged
CLK 200 CGI	07/03→05/09				
CLK Convertible CLK 200 CGI	07/03→03/10				
TD16392					

6

08-427600-00 ⓘ STD	82.00	1.200		005 NT	ST
		1.500		005 P	GOE13
		2.500		712 NT	ST
ⓘ For Nüral OE piston		ⓘ Für OE-Kolben von Nüral		ⓘ Pour les pistones d'origine Nüral	
TD16392					



Kombi Estate 260 TE FGST., Saloon 260 E Saloon 260 E 4-matic	09/85→08/92 12/86→12/89	M 103.940	6cyl. 2599cc	117kW (159PS)	7	TD9435
S-Class 260 SE	09/85→06/91	M 103.941	6cyl. 2599cc	117kW (159PS)		TD2096
190 2.6 190 E 2.6	10/82→09/88 09/86→08/93	M 103.942 (KAT)	6cyl. 2599cc	117kW (159PS)		TD2097
Saloon 260 E 4-matic	09/86→08/92	M 103.943	6cyl. 2599cc	118kW (160PS)		TD2098

08-183100-00	STD	82.90	1.500		001 IW CK P	KV1
08-183107-00	0.50mm				026 P	F12/F14
08-183111-00	1.00mm		1.750		231 CR P	STD
			3.000			

A-Class A 150 A-Class A 160 B-Class B 150 B-Class B 160	09/04→06/12 04/09→06/12 03/05→11/11 04/09→11/11	M 266.920	4cyl. 1498cc	70kW (95PS)	8	TD18148
A-Class A 170 A-Class A 180 B-Class B 170 B-Class B 180	09/04→06/12 04/09→06/12 03/05→11/11 04/09→11/11	M 266.940	4cyl. 1699cc	85kW (116PS)		TD18149
A-Class A 200 B-Class B 170 NGT, B-Class B 180 NGT B-Class B 200	09/04→06/12 04/08→11/11 03/05→11/11	M 266.960	4cyl. 2034cc	100kW (136PS)		TD18150

08-437100-00	STD	83.00	1.200		001 NT	ST
			1.750		026 P	GOE13
			2.000		712 NT	ST

Smart Forfour 1.5 CDI	03/04→	OM 639.939 Euro 4	3cyl. 1493cc	50-70kW (58-95PS)	9	TD23799
A-Class A 180 CDI B-Class B 180 CDI	09/04→06/12 03/05→11/11	OM 640.940	4cyl. 1991cc	80kW (109PS)		TD18151
A-Class A 200 CDI B-Class B 200 CDI	09/04→06/12 03/05→11/11	OM 640.941	4cyl. 1991cc	103kW (140PS)		TD18152





A-Class A 160 CDI		09/04→06/12	OM 640.942		4cyl. 1991cc	60kW (81PS)	
			Diesel				TD18153
08-427500-00	STD	83.00	2.000		001 IF CK		KV4
08-427507-00	0.50mm		2.000		005 IFU P		F12/F14
			2.000		231 LKZ CR P		GOE13
GL-Class GL 350 CDI BlueTEC		12/09→	OM 642.820		V6cyl. 2987cc	155kW (211PS)	10
M-Class ML 300 CDI 4-matic		02/10→					
M-Class ML 350 CDI 4-matic		09/09→	Diesel		Turbo Intercooled		TD23810
GL-Class GL 350 CDI		10/10→	OM 642.822		V6cyl. 2987cc	165kW (224PS)	
			Diesel		Turbo Intercooled		TD19207
C-Class C 350 CDI		10/09→	OM 642.830		V6cyl. 2987cc	170kW (231PS)	
C-Class T-Model C 350 CDI		08/07→					
			Diesel		Turbo Intercooled		TD23772
C-Class C 300 CDI 4-matic		01/11→	OM 642.832		V6cyl. 2987cc	155-170kW (211-231PS)	
C-Class C 350 CDI 4-matic,		10/09→					
C-Class T-Model C 350 CDI 4-matic							
GLK-Class 350 CDI 4-matic		07/09→05/10	Diesel		Turbo Intercooled		
M-Class ML 300 CDI 4-matic,		02/10→					
M-Class ML 350 CDI 4-matic							TD23751
C-Class C 350 CDI,		06/11→	OM 642.834		V6cyl. 2987cc	195kW (265PS)	
C-Class T-Model C 350 CDI							
			Diesel		Turbo Intercooled		TD26036
E-Class Convertible E 350 CDI		01/10→	OM 642.836		V6cyl. 2987cc	170kW (231PS)	
E-Class Coupe E 350 CDI		01/09→					
			Diesel		Turbo Intercooled		TD23723
E-Class E 300 CDI		03/11→	OM 642.850		V6cyl. 2987cc	155-170kW (211-231PS)	
E-Class E 350 BlueTEC, E-Class E 350 CDI		01/09→					
E-Class T-Model E 300 CDI,		11/09→					
E-Class T-Model E 350 BlueTEC,			Diesel		Turbo Intercooled		
E-Class T-Model E 350 CDI							TD23781
CLS CLS 350 BlueTEC		11/12→	OM 642.852		V6cyl. 2987cc	170kW (231PS)	
E-Class E 300 CDI		03/11→					
E-Class E 350 BlueTEC,		11/12→					
E-Class E 350 BlueTEC 4-matic			Diesel		Turbo Intercooled		
E-Class E 350 CDI		03/11→					
E-Class T-Model E 350 BlueTEC		11/12→					
E-Class T-Model E 350 CDI		07/11→					TD23792
CLS CLS 350 CDI		01/11→	OM 642.853		V6cyl. 2987cc	195kW (265PS)	
CLS Shooting Brake CLS 350 CDI		10/12→					
			Diesel		Turbo Intercooled		TD26065
CLS CLS 350 CDI 4-matic		09/11→	OM 642.854 (OM 642 LS DE 30 LA)		V6cyl. 2987cc	195kW (265PS)	
CLS Shooting Brake CLS 350 CDI 4-matic		10/12→					
			Diesel		Turbo Intercooled		TD26045





E-Class E 350 CDI 4-matic	09/09→	OM 642.856			
E-Class T-Model E 350 CDI 4-matic	11/09→		V6cyl.	2987cc	170kW (231PS)
		Diesel		Turbo Intercooled	TD23790
CLS CLS 350 BlueTEC 4-matic,	11/12→	OM 642.858			
E-Class E 350 BlueTEC 4-matic			V6cyl.	2987cc	170kW (231PS)
E-Class E 350 CDI 4-matic	03/11→				
E-Class T-Model E 350 BlueTEC 4-matic	11/12→	Diesel		Turbo Intercooled	
E-Class T-Model E 350 CDI 4-matic	07/11→				TD23791
S-Class S 350 BlueTec	04/11→	OM 642.862			
			V6cyl.	2987cc	190kW (258PS)
		Diesel		Turbo Intercooled	TD26082
S-Class S 350 BlueTEC 4-matic	04/11→	OM 642.868			
			V6cyl.	2987cc	190kW (258PS)
		Diesel		Turbo Intercooled	TD25099
R-Class R 280 CDI	05/06→	OM 642.870			
R-Class R 300 CDI	07/09→		V6cyl.	2987cc	155kW (211PS)
R-Class R 320 CDI 4-matic,	01/06→				
R-Class R 350 CDI 4-matic		Diesel		Turbo Intercooled	TD24810
R-Class R 280 CDI	05/06→	OM 642.872			
R-Class R 300 CDI	07/09→		V6cyl.	2987cc	195kW (265PS)
R-Class R 350 CDI 4-matic	08/10→				
		Diesel		Turbo Intercooled	TD25098
G-Class G 280 CDI	04/09→	OM 642.884			
G-Class G 300 CDI	04/10→		V6cyl.	2987cc	135kW (184PS)
		Diesel		Turbo Intercooled	TD25842
G-Class G 350 CDI,	07/11→	OM 642.886			
G-Class Cabrio G 350 CDI			V6cyl.	2987cc	155kW (211PS)
		Diesel		Turbo/Intercooled Direct Injection	TD28072
Sprinter 3, 5 Platform/Chassis 318 CDI	06/06→	OM 642.896			
Sprinter 3, 5 Platform/ Chassis 318 CDI 4x4	02/08→		V6cyl.	2987cc	155kW (211PS)
		Diesel		Turbo Intercooled	TD25841
Sprinter 3, 5 Platform/Chassis 319 CDI / BlueTEC	03/09→	OM 642.898			
Sprinter 3, 5 Platform/Chassis 319 CDI / BlueTEC 4x4	05/11→		V6cyl.	2987cc	150kW (204PS)
		Diesel		Turbo Intercooled	TD25843
C-Class C 320 CDI	01/05→02/07	OM 642.910			
C-Class T-Model C 320 CDI	06/05→08/07		6cyl.	2987cc	165kW (224PS)
CLK 320 CDI	01/05→05/09				
CLK Convertible CLK 320 CDI	03/05→03/10	Diesel		Turbo Intercooled	
E-Class E 320 CDI 4-matic	03/05→12/08				TD18416
CLS CLS 320 CDI	01/05→12/10	OM 642.920			
CLS CLS 350 CDI	04/09→12/10		V6cyl.	2987cc	140-165kW (190-224PS)
E-Class E 280 CDI	03/05→12/08				
E-Class E 300 BlueTEC	09/07→12/08	Diesel		Turbo Intercooled	
E-Class E 320 CDI	03/05→12/08				
E-Class T-Model E 280 T CDI,	03/05→07/09				
E-Class T-Model E 320 T CDI,					
E-Class T-Model E 320 T CDI 4-matic					TD18431





E-Class E 280 CDI 4-matic E-Class T-Model E 280 T CDI 4-matic	03/05→12/08 03/05→07/09	OM 642.921	V6cyl. 2987cc 140kW (190PS)	Diesel Turbo Intercooled	TD18428
S-Class S 320 CDI S-Class S 320 CDI / S 350 CDI S-Class S 350 CDI	10/05→ 12/05→ 05/11→	OM 642.930	V6cyl. 2987cc 173kW (235PS)	Diesel Turbo Intercooled	TD19213
S-Class S 320 CDI 4-matic	10/06→	OM 642.932	V6cyl. 2987cc 173kW (235PS)	Diesel Turbo Intercooled	TD23761
GL-Class GL 320 CDI GL-Class GL 350 CDI M-Class ML 280 CDI 4-matic M-Class ML 300 CDI 4-matic M-Class ML 320 CDI 4-matic M-Class ML 350 CDI 4-matic	09/06→05/09 05/09→ 07/05→07/09 07/09→ 07/05→07/09 07/09→	OM 642.940	V6cyl. 2987cc 140-165kW (190-224PS)	Diesel Turbo Intercooled	TD18197
R-Class R 280 CDI, R-Class R 280 CDI 4-matic R-Class R 300 CDI, R-Class R 300 CDI 4-matic R-Class R 320 CDI 4-matic, R-Class R 350 CDI 4-matic	05/06→ 07/09→ 01/06→	OM 642.950	V6cyl. 2987cc 140kW (190PS)	Diesel Turbo Intercooled	TD19206
C-Class C 320 CDI C-Class C 350 CDI C-Class T-Model C 320 CDI	01/07→ 07/09→ 08/07→	OM 642.960	V6cyl. 2987cc 165kW (224PS)	Diesel Turbo Intercooled	TD20361
C-Class C 320 CDI 4-matic C-Class C 350 CDI 4-matic C-Class T-Model C 320 CDI 4-matic GLK-Class 320 CDI 4-matic	07/07→ 07/09→ 08/07→ 06/08→	OM 642.961	V6cyl. 2987cc 165kW (224PS)	Diesel Turbo Intercooled	TD20986
G-Class G 320 CDI, G-Class Cabrio G 320 CDI	09/06→	OM 642.970	V6cyl. 2987cc 165kW (224PS)	Diesel Turbo Intercooled	TD20729
Viano CDI 3.0 Vito / Mixto Box 120 CDI, Vito Bus 120 CDI	03/06→ 07/06→	OM 642.990	V6cyl. 2987cc 150kW (204PS)	Diesel Turbo Intercooled	TD22148
Sprinter 3, 5 Platform/Chassis 318 CDI	06/06→	OM 642.992	V6cyl. 2987cc 135kW (184PS)	Diesel Turbo Intercooled	TD22149
Sprinter 3, 5 Platform/Chassis 318 CDI	06/06→	OM 642.993	V6cyl. 2987cc 135kW (184PS)	Diesel Turbo Intercooled	TD25661

08-427400-00	STD	83.00	2.000		008 IF CK P	KV1
08-427407-00	0.50mm		2.000		005 IFU P	F12/F14
			2.000		231 LKZ CR P	GOE13



C-Class C 220 CDI	01/07→	OM 651.911			11
C-Class C 250 CDI	08/08→		4cyl.		
C-Class Coupe C 220 CDI,	06/11→		2143cc	125-150kW (170-204PS)	
C-Class Coupe C 250 CDI		Diesel	Turbo Intercooled		
C-Class T-Model C 220 CDI	12/08→				
C-Class T-Model C 250 CDI	01/09→				
E-Class Convertible E 220 CDI,	01/10→				
E-Class Convertible E 250 CDI,					
E-Class Coupe E 220 CDI					
E-Class Coupe E 250 CDI	01/09→				
C-Class C 220 CDI 4-matic	02/13→	OM 651.912			TD23754
C-Class C 250 CDI 4-matic	01/11→		4cyl.		
C-Class T-Model C 220 CDI 4-matic	02/13→		2143cc	120-150kW (163-204PS)	
C-Class T-Model C 250 CDI 4-matic	04/10→	Diesel	Turbo Intercooled		
GLK-Class 220 CDI 4-matic	12/08→				
GLK-Class 250 CDI 4-matic	09/09→				
C-Class C 180 CDI, C-Class C 200 CDI,	01/11→	OM 651.913			TD24407
C-Class T-Model C 180 CDI			4cyl.		
C-Class T-Model C 200 CDI	08/10→		2143cc	100-105kW (136-143PS)	
GLK-Class 200 CDI	07/10→	Diesel	Turbo Intercooled		
GLK-Class 200 CDI	07/10→	OM 651.916			TD23755
GLK-Class 220 CDI	12/08→		4cyl.		
			2143cc	120-125kW (163-170PS)	
		Diesel	Turbo Intercooled		
C-Class C 220 BlueTEC	12/13→	OM 651.921			TD28575
C-Class C 250 BlueTEC,	02/14→		4cyl.		
S-Class S 300 BlueTEC Hybrid			2143cc	120-150kW (163-204PS)	
		Diesel	Turbo Intercooled		
CLS CLS 250 CDI	04/11→	OM 651.924			TD23782
CLS Shooting Brake CLS 250 CDI	10/12→		4cyl.		
E-Class E 220 CDI, E-Class E 220 CDI /	01/09→		2143cc	120-150kW (163-204PS)	
BlueTEC		Diesel	Turbo Intercooled		
E-Class E 250 CDI	08/08→				
E-Class E 250 CDI 4-matic	01/09→				
E-Class E 300 Hybrid /BlueTEC Hybrid	12/11→				
E-Class T-Model E 220 CDI,	11/09→				
E-Class T-Model E 250 CDI					
E-Class T-Model E 250 CDI 4-matic	07/10→				
E-Class T-Model E 300 Hybrid	12/11→				
E-Class E 200 CDI	01/09→	OM 651.925			TD23783
E-Class T-Model E 200 CDI	11/09→		4cyl.		
			2143cc	100kW (136PS)	
		Diesel	Turbo Intercooled		
A-Class A 220 CDI	09/12→	OM 651.930			TD26817
B-Class B 220 CDI	11/11→		4cyl.		
CLA Coupe CLA 220 CDI	01/13→		2143cc	125kW (170PS)	
		Diesel	Turbo Intercooled		
Viano CDI 2.0, Viano CDI 2.0 4-matic,	07/10→	OM 651.940			TD25280
Viano CDI 2.2, Viano CDI 2.2 4-matic			4cyl.		
Vito / Mixto Box 110 CDI, Vito /	09/10→		2143cc	100-120kW (136-163PS)	
Mixto Box 113 CDI, Vito /		Diesel	Turbo Intercooled		
Mixto Box 113 CDI 4x4, Vito /					
Mixto Box 116 CDI, Vito /					
Mixto Box 116 CDI 4x4, Vito Bus 110 CDI,					
Vito Bus 113 CDI, Vito Bus 113 CDI 4x4,					
Vito Bus 116 CDI, Vito Bus 116 CDI 4x4					





Sprinter 3, 5 Platform/Chassis 310 CDI, Sprinter 3, 5-t Box 310 CDI, Sprinter 3, 5-t Bus 310 CDI, Sprinter 3-T Box 210 CDI, Sprinter 3-T Bus 210 CDI, Sprinter 3-t Platform/Chassis 210 CDI, Sprinter 5-t Box 510 CDI, Sprinter 5-t Platform/Chassis 510 CDI Sprinter 5-t Platform/ Chassis 513 CDI 4x4	03/09 → 05/11 →	OM 651.955 Diesel	4cyl. 2143cc 70kW (95PS) Turbo Intercooled	TD24545
--	--	--	--	---------

Sprinter 3, 5 Platform/Chassis 313 CDI	06/06 →	OM 651.956 Diesel	4cyl. 2143cc 95kW (129PS) Turbo Intercooled	TD25279
--	---------	--	---	---------

Sprinter 3, 5 Platform/Chassis 316 CDI	06/06 →	OM 651.957 Diesel	4cyl. 2143cc 120kW (163PS) Turbo Intercooled	TD24544
--	---------	--	--	---------

M-Class ML 250 CDI BlueTEC 4-matic	06/11 →	OM 651.960 Diesel	4cyl. 2143cc 150kW (204PS) Turbo Intercooled	TD26549
------------------------------------	---------	--	--	---------

S-Class S 250 CDI	01/11 →	OM 651.961 Diesel	4cyl. 2143cc 150kW (204PS) Turbo Intercooled	TD25277
-------------------	---------	--	--	---------

SLK 250 CDI	01/12 →	OM 651.980 Diesel	4cyl. 2143cc 150kW (204PS) Turbo Intercooled	TD26369
-------------	---------	--	--	---------







08-433400-00	STD	83.00	2.000		001 GDC P	KV1	
08-433405-00	0.25mm			1.750		005 IF P	F12/F14
08-433407-00	0.50mm			2.000		231 CR P	GOE13

C-Class C 240	06/97 → 05/00	M 112.910	V6cyl. 2398cc 125kW (170PS)	12	TD9420
C-Class Estate C 240 T	06/97 → 09/00				

E-Class E 240	06/97 → 08/00	M 112.911	V6cyl. 2398cc 125kW (170PS)	TD9887
E-Class Estate E 240 T	06/97 → 03/03			

08-421700-00	STD	83.20	1.500		001 NT	ST	
				1.750		026 P	GOE13
				3.000		712 NT	ST



Ponton 190 b		06/59→12/61	M 121.920						13
				4cyl.	1898cc	59kW (80PS)			TD9957
Bus			M 121.922						
				4cyl.	1897cc	48kW (65PS)			TD17787
Heckflosse 190 C		04/61→08/65	M 121.924						
				4cyl.	1898cc	59kW (80PS)			TD9947
08-163600-00	STD	85.00	2.000		001 IF CR P				IKA
			2.500		005 IF P				STD
			3.000		023 P				STD
			5.000		231 P				STD
C 180		06/93→	M 111						14
				4cyl.	1799cc	90kW (122PS)			FM6169
C-Class C 180		03/93→05/00	M 111.920						
C-Class Estate C 180 T		06/96→09/00		4cyl.	1799cc	90kW (122PS)			TD2131
C-Class C 180		03/93→05/00	M 111.921						
C-Class Estate C 180 T		06/96→09/00		4cyl.	1799cc	90kW (122PS)			TD5235
08-287900-00	STD	85.30	1.500		001 CR P				KV1
			1.750		026 P				STD
			3.000		231 CR P				STD
/8 280		06/72→11/76	M 110.921						15
/8 Coupe 280 C		06/72→02/77		6cyl.	2746cc	115kW (156PS)			TD2115
S-Class 280 S		08/72→07/80	M 110.922						
				6cyl.	2746cc	115kW (156PS)			TD2116
Coupe 280 C		03/77→03/80	M 110.923						
Saloon 280		02/76→08/81		6cyl.	2746cc	115kW (156PS)			TD2117
S-Class 280 S		12/79→07/85	M 110.924						
				6cyl.	2746cc	115kW (156PS)			TD2118
S-Class 280 S		12/79→07/85	M 110.926						
				6cyl.	2746cc	115kW (156PS)			TD2119





/8 280 E /8 Coupe 280 CE	06/72→11/76 06/72→01/77	M 110.981	6cyl. 2746cc	136kW (185PS)	TD2120
SL 280 SL SL Coupe 280 SLC	08/74→07/85 08/74→09/81	M 110.982	6cyl. 2746cc	136kW (185PS)	TD2121
S-Class 280 SE, SEL	08/72→07/80	M 110.983	6cyl. 2746cc	136kW (185PS)	TD2122
Saloon 280 E	02/76→11/85	M 110.984	6cyl. 2746cc	136kW (185PS)	TD4659
S-Class 280 SE, SEL	08/72→07/80	M 110.985	6cyl. 2746cc	136kW (185PS)	TD2124
SL 280 SL SL Coupe 280 SLC	08/74→07/85 08/74→09/81	M 110.986	6cyl. 2746cc	136kW (185PS)	TD2125
S-Class 280 SE, SEL	10/79→07/85	M 110.987	6cyl. 2746cc	136kW (185PS)	TD2126
Coupe 280 CE Kombi Estate 280 TE Saloon 280 E	03/77→11/85 09/77→11/85 02/76→11/85	M 110.988	6cyl. 2746cc	136kW (185PS)	TD2127
S-Class 280 SE, SEL	10/79→07/85	M 110.989	6cyl. 2746cc	136kW (185PS)	TD2128
SL 280 SL SL Coupe 280 SLC	08/74→07/85 08/74→09/81	M 110.990	6cyl. 2746cc	136kW (185PS)	TD2129
Kombi Estate 250 T Saloon 250	05/78→08/82 02/76→07/85	M 123.921	6cyl. 2527cc	95-103kW (129-140PS)	TD2194

08-176600-00	STD	86.00	1.750		001 IF MOL P	KV1
08-176607-00	0.50mm		2.500		023 P	STD
08-176611-00	1.00mm		4.000		231 CR P	STD



S-Class S 400 CDI	06/00→08/05	OM 628.960	V8cyl. 3996cc 184-191kW (250-260PS)	16
		Diesel	Turbo Intercooled	TD15462
E-Class E 400 CDI	02/03→12/08	OM 628.961	V8cyl. 3996cc 191kW (260PS)	
		Diesel	Turbo Intercooled	TD17545
G-Class G 400 CDI, G-Class Cabrio G 400 CDI	12/00→	OM 628.962	V8cyl. 3996cc 184kW (250PS)	
		Diesel	Turbo Intercooled	TD15459
M-Class ML 400 CDI	09/01→06/05	OM 628.963	V8cyl. 3996cc 184kW (250PS)	
		Diesel	Turbo Intercooled	TD17010

08-136300-00	STD	86.00	2.500		001 IF CK P	
			2.000		005 IFU P	F12/F14
			3.000		231 CR P	GOE13

S-Class 280 S	10/67→07/72	M 130.920	6cyl. 2750cc 103kW (140PS)	17
				TD2195
/8 250 2.8, /8 Coupe 250 C 2.8	06/72→11/76	M 130.923	6cyl. 2750cc 96kW (131PS)	
				TD2196
Coupe 280 SE S-Class 280 SE, SEL	01/67→12/71 01/68→08/72	M 130.980	6cyl. 2750cc 118kW (160PS)	
				TD2197
S-Class 300 SEL	01/68→08/72	M 130.981	6cyl. 2750cc 118kW (160PS)	
				TD4673
Pagode 280 SL	01/68→03/71	M 130.983	6cyl. 2750cc 125kW (170PS)	
				TD2200
Coupe 280 SE	01/67→12/71	M 130.984	6cyl. 2778cc 118kW (160PS)	
				TD9989

08-181500-10	STD	86.50	2.000		001 IF MOL P	KV1
			2.500		026 MO P	IKA
			4.000		231 MOL P	STD



/8 200	01/68 → 01/77	M 115.923	4cyl. 1988cc	62-70kW (85-95PS)	18	TD2141
/8 200 Heckflosse 200	01/68 → 01/77 07/65 → 02/68	M 115.926	4cyl. 1988cc	62-70kW (85-95PS)		TD2143
Saloon 200	02/76 → 08/80	M 115.938	4cyl. 1988cc	62-70kW (84-95PS)		TD2147
Saloon 200	02/76 → 08/80	M 115.939	4cyl. 1988cc	62-70kW (84-95PS)		TD2148

08-175500-00	STD	87.00	1.500		001 IF MO P	KV1
08-175507-00	0.50mm		2.500		023 P	STD
08-175511-00	1.00mm		4.000		231 CR P	STD
08-181600-10 ¹	STD	87.00	1.750		001 IF MOL P	KV1
08-181607-10	0.50mm		2.500		026 P	F12/F14
08-181611-10	1.00mm		4.000		231 CR P	STD

¹ For Nüral OE piston

¹ Für OE-Kolben von Nüral

¹ Pour les pistones d'origine Nüral

¹ Para pistones originales Nüral

190 D 2.0	08/83 → 08/93	OM 601.911	4cyl. 1978cc	53-55kW (72-75PS)	19	TD2206
E-Class E 200 D Kombi Estate 200 T D Saloon 200 D	06/93 → 06/95 09/85 → 08/91 12/84 → 06/93	OM 601.912	4cyl. 1978cc	53-55kW (72-75PS)		TD2207
190 D 2.5	04/85 → 08/93	OM 602.911	5cyl. 2497cc	66-69kW (90-94PS)		TD2211
Kombi Estate 250 T D Saloon 250 D	09/85 → 06/93 04/85 → 06/93	OM 602.912	5cyl. 2497cc	66-69kW (90-94PS)		TD2212
G-Class 250 GD	10/87 → 12/92	OM 602.930	5cyl. 2497cc	62-69kW (84-94PS)		TD2213
G-Class 300 GD Kombi Estate 300 T D Saloon 300 D	03/79 → 07/93 09/86 → 06/93 12/84 → 06/93	OM 603.912	6cyl. 2996cc	80-83kW (109-113PS)		TD2218





Saloon 300 D 4-matic		09/86→06/93	OM 603.913	6cyl. 2996cc	80-83kW (109-113PS)	
			Diesel			TD2219
08-183200-00	STD	87.00	2.000		001 CR P	KV1
08-183207-00 →07/1989	0.50mm		2.000		005 IF P	F12/F14
[R42350]			3.000		231 CR P	STD
08-743600-00	STD	87.00	2.500		001 CR P	KV1
08-743607-00 08/1989→	0.50mm		2.000		005 IF P	F12/F14
[R48040]			3.000		231 CR P	STD
C-Class C 200 D		03/93→05/00	OM 601.913	4cyl. 1997cc	55kW (75PS)	20
			Diesel			TD2208
C-Class C 200 D			OM 601.915	4cyl. 1997cc	55kW (75PS)	TD5237
			Diesel			
G-Class 250 GD		06/90→	OM 602.931	5cyl. 2497cc	69kW (93PS)	TD2214
			Diesel			
G-Class 250 GD			OM 602.938	5cyl. 2497cc	68kW (92PS)	TD17816
			Diesel			
G-Class 250 GD		02/90→	OM 602.939	5cyl. 2497cc	68kW (92PS)	TD9422
			Diesel			
O 405 O 405 GTZ			OM 602.990 (OM 602)	5cyl. 2497cc	63kW (86PS)	TD17819
			Diesel			
G-Class 300 GD G-Class Cabrio 300 GD		09/89→ 12/90→09/97	OM 603.931	6cyl. 2996cc	80-83kW (109-113PS)	TD2220
			Diesel			
C-Class C 200 D C-Class Estate C 200 T D		10/96→05/00 10/96→03/01	OM 604.915	4cyl. 1997cc	65kW (88PS)	TD4677
			Diesel			
E-Class E 200 D		01/96→03/02	OM 604.917	4cyl. 1997cc	65kW (88PS)	TD9424
			Diesel			
C-Class C 250 D		05/93→05/00	OM 605.910	5cyl. 2497cc	83kW (113PS)	TD2228
			Diesel			





E-Class E 250 D	07/93→06/95	OM 605.911	5cyl.	2497cc	83kW (113PS)				
E-Class Estate E 250 T D	06/93→06/96					Diesel			TD2229
E-Class E 250 D	06/95→07/99	OM 605.912	5cyl.	2497cc	83kW (113PS)				
E-Class Estate E 250 T D	06/96→07/99					Diesel			TD4678
E-Class E 300 D	07/93→06/95	OM 606.910	6cyl.	2996cc	130kW (177PS)				
E-Class Estate E 300 T D	06/93→06/96					Diesel			TD2230
E-Class E 300 D	06/95→06/97	OM 606.912	6cyl.	2996cc	100kW (136PS)				
						Diesel			TD4680
08-743600-00	STD	87.00	2.500		001 CR P				KV1
08-743607-00	0.50mm		2.000		005 IF P				F12/F14
[R48040]			3.000		231 CR P				STD
190 Turbo-D 2.5	02/88→08/93	OM 602.961	5cyl.	2497cc	90-93kW (122-126PS)				21
						Diesel	Turbo		TD2216
E-Class E 250 Turbo-D	06/93→06/95	OM 602A.962	5cyl.	2497cc	93kW (126PS)				
E-Class Estate E 250 Turbo D	06/93→06/96					Diesel	Turbo		TD2217
Kombi Estate 250 TD Turbo	03/88→07/93								
Saloon 250 Turbo-D	09/88→06/93								
300 SD Turbo	11/85→12/87	OM 603.961	6cyl.	2996cc	107-110kW (143-148PS)				
						Diesel	Turbo		TD2222
E-Class E 300 Turbo-D	06/93→06/95	OM 603A.960	6cyl.	2996cc	105-108kW (143-147PS)				
E-Class Estate E 300 T Turbo-D	06/93→06/96					Diesel	Turbo		TD2221
Kombi Estate 300 T Turbo-D	09/86→06/93								
Kombi Estate 300 T Turbo-D 4-matic	01/89→06/93								
Kombi Estate 300 TD T	06/92→05/93								
Saloon 300 Turbo-D	09/86→06/93								
Saloon 300 Turbo-D 4-matic	09/86→09/88								TD2221
E-Class E 300 Turbo-D 4-matic	06/93→06/95	OM 603A.963	6cyl.	2996cc	105-108kW (143-147PS)				
E-Class Estate E 300 T Turbo-D 4-matic	06/93→06/96					Diesel	Turbo		TD2223
Kombi Estate 300 T Turbo-D,	09/86→01/89								
Kombi Estate 300 T Turbo-D 4-matic									
Saloon 300 Turbo-D	09/86→09/88								
Saloon 300 Turbo-D 4-matic	09/86→06/93								TD2223
C-Class C 250 Turbo-D	10/95→05/00	OM 605.960	5cyl.	2497cc	110kW (150PS)				
C-Class Estate C 250 T Turbo-D	06/96→03/01					Diesel	Turbo Intercooled		TD4679
E-Class E 250 Turbo-D,	06/97→07/99	OM 605.962	5cyl.	2497cc	110kW (150PS)				
E-Class Estate E 250 T Turbo-D						Diesel	Turbo Intercooled		TD9892





S-Class S 300 Turbo-D		05/96→10/98	OM 606.961	6cyl. 2996cc	130kW (177PS)	Diesel	Turbo Intercooled	TD5238
E-Class E 300 Turbo-D, E-Class Estate E 300 T Turbo-D		12/96→07/99	OM 606.962	6cyl. 2996cc	130kW (177PS)	Diesel	Turbo Intercooled	TD9416
G-Class G 300 TD G-Class Cabrio G 300 TD		08/96→ 09/96→	OM 606.964	6cyl. 2996cc	130kW (177PS)	Diesel	Turbo Intercooled	TD9425
08-183300-00	STD	87.00	2.500		001 P PS			KV1
08-183307-00	0.50mm		2.000		005 IF P PS			KV1
[R66590]			3.000		231 CR P			STD
T2/L Box Body / Estate L 405 D, T2/ L Platform/Chassis L 405 D		01/72→12/80	OM 615 (OM 615)	4cyl. 2197cc	40-44kW (55-60PS)	Diesel		22 TD2231
Unimog U 45 Unimog U S 404		01/66→04/71 01/68→	OM 615.911 (OM 615)	4cyl. 2197cc	33kW (45PS)	Diesel		TD7970
Series 206 D 2.0		01/71→02/73	OM 615.915	4cyl. 1988cc	40-44kW (54-60PS)	Diesel		TD17732
Henschel 2-T 206 D 2.2		02/73→12/77	OM 615.917	4cyl. 2197cc	44kW (60PS)	Diesel		TD5683
Henschel 2-T 206 D 2.2		02/73→12/77	OM 615.918 (OM 615)	4cyl. 2197cc	40kW (55PS)	Diesel		TD22824
Series F 20 (Hanomag)		01/72→	OM 615.936 (OM 615)	4cyl. 2197cc	37kW (50PS)	Diesel		TD20151
Henschel 2-T 206 D 2.2		02/73→12/77	OM 615.937 (OM 615)	4cyl. 2197cc	44kW (60PS)	Diesel		TD2236
Henschel 2-T 206 D 2.2		02/73→12/77	OM 615.939 (OM 615)	4cyl. 2197cc	44kW (60PS)	Diesel		TD2237
Saloon 200 D		07/76→11/85	OM 615.940	4cyl. 1988cc	40-44kW (55-60PS)	Diesel		TD2238





Saloon 220 D	01/76→03/79	OM 615.941 4cyl. 2197cc	44-49kW (60-67PS)	Diesel	TD2239
Steyr City Bus SC6 F 55	01/75→12/80	OM 615.942 (OM 615) 4cyl. 1988cc	40kW (54PS)	Diesel	TD22827
Series 206 D 2.0	12/76→07/77	OM 615.943 (OM 615) 4cyl. 1988cc	40kW (54PS)	Diesel	TD2240
Series 207/307 D 2.0	08/77→01/89	OM 615.944 (OM 615) 4cyl. 1988cc	40kW (54PS)	Diesel	TD2241
132 2.0 D	05/73→02/79	OM 615.961 (OM 615) 4cyl. 1988cc	44kW (60PS)	Diesel	TD22829
100 Bus 2.0 D	04/88→08/93	OM 615.963 (OM 615) 4cyl. 1988cc	43kW (58PS)	Diesel	TD2242
100 Bus 2.0 D	04/88→08/93	OM 615.964 (OM 615) 4cyl. 1988cc	40kW (54PS)	Diesel	TD22830
100 Bus 2.0 D	04/88→08/93	OM 615.965 (OM 615) 4cyl. 1988cc	40kW (54PS)	Diesel	TD22831
2000 D	05/73→02/79	OM 615.966 (OM 615) 4cyl. 1988cc	40kW (54PS)	Diesel	TD22832
2000 D	05/73→02/79	OM 615.967 (OM 615) 4cyl. 1988cc	40kW (54PS)	Diesel	TD22833
2000 D	05/73→02/79	OM 615.968 (OM 615) 4cyl. 1988cc	40kW (54PS)	Diesel	TD22834
132 2.0 D	05/73→02/79	OM 615.969 (OM 615) 4cyl. 1988cc	40kW (54PS)	Diesel	TD22835
100 Box 2.0 D, 100 Bus 2.0 D	04/88→04/96	OM 615.970 (OM 615) 4cyl. 1988cc	43-46kW (58-62PS)	Diesel	TD2243

08-170700-10	STD	87.00	2.000		001 IF CR P	KV1
08-170707-10	0.50mm					
08-170711-10	1.00mm					
[R66580]			4.000		231 CR P	STD



O 309 O 309 D, T2/L Box Body / Estate L 406 DG, T2/L Platform/ Chassis L 406 DG	01/68→12/74	OM 615.910 (OM 615) 4cyl. 2197cc 44kW (60PS) Diesel	23	TD2232
/8 220 D	01/68→01/77	OM 615.912 4cyl. 2197cc 44kW (60PS) Diesel	TD2233	
/8 200 D	01/68→01/77	OM 615.913 4cyl. 1988cc 40kW (54PS) Diesel	TD2234	
U 40, U55	01/68→12/71	OM 615.914 (OM 615) 4cyl. 2197cc 40kW (54PS) Diesel	TD7972	
U 40, U 55		OM 615.916 (OM 615) 4cyl. 2197cc 40kW (55PS) Diesel	TD22823	
U 40, U 55		OM 615.930 (OM 615) 4cyl. 2197cc 38kW (52PS) Diesel	TD22825	
U 404	10/69→12/76	OM 615.932 (OM 615) 4cyl. 2197cc 44kW (60PS) Diesel	TD7989	
0309 D 2.2 Series 406 D 2.2 Series 407 D 2.2	03/73→07/77 03/73→12/80 03/73→07/77	OM 615.938 (OM 615) 4cyl. 2197cc 44kW (60PS) Diesel	TD22826	

08-170600-10	STD	87.00	3.000		001 IW MOL P	KV1
08-170607-10	0.50mm		2.000		001 IF P	F12/F14
08-170611-10 10/1967→08/1973	1.00mm		4.000		231 CR P	STD
08-170700-10	STD	87.00	2.000		001 IF CR P	KV1
08-170707-10	0.50mm		2.000		001 IF P	F12/F14
08-170711-10 09/1973→12/1985	1.00mm		4.000		231 CR P	STD
[R66580]						

S-Class 380 SE, SEL	12/85→12/86	M 116.961 V8cyl. 3839cc 120-160kW (163-218PS)	24	TD2159
SL 380 SL	09/80→08/85	M 116.962 V8cyl. 3839cc 150kW (204PS)	TD2160	





S-Class 380 SE, SEL		12/79→08/85	M 116.963				
S-Class Coupe 380 SEC		10/81→07/85		V8cyl.			
SL Coupe 380 SLC		08/81→08/84		3839cc	150kW (204PS)		
TD4669							
08-182900-00	STD	88.00	1.500		001 IW CR P		KV1
08-182907-00	0.50mm		2.000		026 CR P		F12/F14
			3.500		231 CR P		STD
<hr/>							
C-Class C 230 4-matic		07/07→	M 272.911				25
				V6cyl.			
				2496cc	150kW (204PS)		
TD22142							
C-Class C 230		01/05→02/07	M 272.920				
C-Class Coupe C 230		01/05→05/08		V6cyl.			
C-Class T-Model C 230		01/05→08/07		2496cc	150kW (204PS)		
CLC-Class CLC 230		05/08→06/11					TD18425
C-Class C 230		01/07→	M 272.921				
C-Class T-Model C 230		08/07→		V6cyl.			
				2496cc	150kW (204PS)		
TD20357							
E-Class E 230		09/07→12/08	M 272.922				
E-Class T-Model E 230 T		05/07→07/09		V6cyl.			
				2496cc	150kW (204PS)		
TD22143							
C-Class C 280		01/05→02/07	M 272.940				
C-Class T-Model C 280		01/05→08/07		V6cyl.			
CLK 280		01/05→05/09		2996cc	170kW (231PS)		
CLK Convertible CLK 280		01/05→03/10					TD18420
C-Class C 280 4-matic		01/05→02/07	M 272.941				
C-Class T-Model C 280 4-matic		01/05→08/07		V6cyl.			
				2996cc	170kW (231PS)		
TD18423							
SLK 280		01/05→02/11	M 272.942				
SLK 300		04/09→02/11		V6cyl.			
				2996cc	170kW (231PS)		
TD18427							
CLS CLS 280		07/08→12/10	M 272.943				
CLS CLS 300		04/09→12/10		V6cyl.			
E-Class E 280		03/05→12/08		2996cc	170kW (231PS)		
E-Class E 280 4-matic		01/06→12/08					
E-Class T-Model E 280 T,		03/05→07/09					
E-Class T-Model E 280 T 4-matic							TD18430
CLS 280		07/08→12/10	M 272.944				
CLS 300		04/09→12/10		V6cyl.			
E-Class E 280		03/05→12/08		2996cc	170kW (231PS)		
E-Class E 280 4-matic		01/06→12/08					
E-Class T-Model E 280 T,		03/05→07/09					
E-Class T-Model E 280 T 4-matic							TD23758
R-Class R 280		01/07→	M 272.945				
R-Class R 280 4-matic		05/07→		V6cyl.			
R-Class R 300		07/09→		2996cc	170kW (231PS)		
TD20570							





S-Class S 280, S-Class S 300	08/06→	M 272.946	V6cyl. 2996cc	170kW (231PS)	TD26966	
C-Class C 280 C-Class C 300 C-Class T-Model C 280, C-Class T-Model C 300	01/07→ 07/09→ 08/07→	M 272.947	V6cyl. 2996cc	170kW (231PS)	TD20356	
C-Class C 280 4-matic, C-Class C 300 4-matic GLK-Class 280 4-matic GLK-Class 300 4-matic	07/07→ 06/08→06/09 07/09→04/11	M 272.948	V6cyl. 2996cc	170kW (231PS)	TD22968	
SL 280 SL 300	03/08→01/12 04/09→01/12	M 272.949	6cyl. 2996cc	170kW (231PS)	TD20863	
E-Class E 300 E-Class T-Model E 300	01/09→ 11/09→	M 272.952	V6cyl. 2996cc	170kW (231PS)	TD25212	
08-440900-00	STD	88.00	1.500 1.750 2.500	 	001 NT 026 P 712 NT	ST GOE13 ST
C-Class C 200 CDI C-Class C 220 CDI C-Class Estate C 200 T CDI C-Class Estate C 220 T CDI	03/98→05/00 09/97→05/00 03/98→03/01 09/97→03/01	OM 611.960	4cyl. 2148cc	85-115kW (116-156PS)	TD9529	
E-Class E 200 CDI, E-Class E 220 CDI E-Class Estate E 220 T CDI	06/98→03/02 06/98→03/03	OM 611.961	4cyl. 2148cc	75-105kW (102-143PS)	TD17005	
C-Class C 200 CDI C-Class C 220 CDI C-Class Coupe C 220 CDI C-Class T-Model C 200 CDI, C-Class T-Model C 220 CDI	09/00→02/07 05/00→02/07 03/01→05/08 03/01→08/07	OM 611.962	4cyl. 2148cc	85-105kW (116-143PS)	TD15449	
V-Class V 200 CDI, V-Class V 220 CDI, Vito Box 112 CDI 2.2, Vito Bus 112 CDI 2.2	03/99→07/03	OM 611.980 Euro 3 (OM 611 LA)	4cyl. 2148cc	85-115kW (116-156PS)	TD14350	
Sprinter 2T, 3T, 4T 413 CDI 4x4	04/00→05/06	OM 611.981 Euro 3	4cyl. 2148cc	80-95kW (109-129PS)	TD17729	
Sprinter 2-T Box 208 CDI, Sprinter 2-T Bus 208 CDI, Sprinter 2-t Platform/Chassis 208 CDI, Sprinter 3-T Box 308 CDI, Sprinter 3-T Bus 308 CDI, Sprinter 3-t Platform/Chassis 308 CDI, Sprinter 4-T Box 408 CDI, Sprinter 4-T Bus 408 CDI, Sprinter 4-t Platform/Chassis 408 CDI	04/00→05/06	OM 611.987 Euro 3	4cyl. 2148cc	60kW (81PS)	TD17730	

26





Vito Box 110 CDI 2.2, Vito Bus 110 CDI 2.2	03/99→07/03	OM 611LA (75 KW CDI) 4cyl. 2148cc 75-110kW (102-150PS)	Diesel	TD14349
E-Class E 270 CDI E-Class Estate E 270 T CDI	07/99→03/02 07/99→03/03	OM 612.961 5cyl. 2688cc 125kW (170PS)	Diesel Turbo Intercooled	TD15455
C-Class C 270 CDI C-Class T-Model C 270 CDI CLK 270 CDI	12/00→02/07 03/01→08/07 10/02→05/09	OM 612.962 5cyl. 2685cc 125kW (170PS)	Diesel Turbo Intercooled	TD15451
M-Class ML 270 CDI	12/99→06/05	OM 612.963 5cyl. 2685cc 120kW (163PS)	Diesel Turbo Intercooled	TD17009
Accelo 715 C G-Class G 270 CDI	05/03→ 01/03→	OM 612.966 5cyl. 2685cc 115kW (156PS)	Diesel Turbo Intercooled	TD16895
CLK 270 CDI	10/02→05/09	OM 612.967 5cyl. 2685cc 125kW (170PS)	Diesel Turbo Intercooled	TD17323
Sprinter 2-T Box 216 CDI, Sprinter 2-T Bus 216 CDI, Sprinter 2-t Platform/Chassis 216 CDI, Sprinter 3-T Box 316 CDI Sprinter 3-T Box 316 CDI 4x4 Sprinter 3-T Bus 316 CDI Sprinter 3-T Bus 316 CDI 4x4 Sprinter 3-t Platform/Chassis 316 CDI Sprinter 3-t Platform/ Chassis 316 CDI 4x4 Sprinter 4-T Box 416 CDI, Sprinter 4-T Box 416 CDI 4x4, Sprinter 4-T Bus 416 CDI, Sprinter 4-t Platform/Chassis 416 CDI, Sprinter 4-t Platform/ Chassis 416 CDI 4x4 Sprinter 5t Platform/Chassis 616 CDI Sprinter Dumptruck 616 CDI	04/00→05/06 08/02→05/06 04/00→05/06 08/02→05/06 04/00→05/06 08/02→05/06 04/00→05/06 04/01→05/06 04/01→	OM 612.981 5cyl. 2685cc 110-115kW (150-156PS)	Diesel Turbo Intercooled	TD17731
S-Class S 320 CDI	08/99→09/02	OM 613.960 6cyl. 3222cc 145kW (197PS)	Diesel Turbo Intercooled	TD15461
E-Class E 320 CDI E-Class Estate E 320 T CDI	07/99→03/02 07/99→03/03	OM 613.961 6cyl. 3226cc 145kW (197PS)	Diesel Turbo Intercooled	TD15454

08-117900-00	STD	88.00	2.500		001 IF CK P	KV1
08-117907-00	0.50mm		2.000		005 IF P	IKA
[R60400]			3.000		231 CR P	STD



C-Class C 200 CDI, C-Class C 220 CDI C-Class T-Model C 200 CDI, C-Class T-Model C 220 CDI	01/07→ 08/07→	OM 646.811	4cyl. 2148cc 125-100kW (170-136PS)	27
		Diesel	Turbo Intercooled	TD20360
C-Class C 200 CDI	01/07→	OM 646.812	4cyl. 2148cc 100kW (136PS)	
		Diesel	Turbo Intercooled	TD22694
E-Class E 200 CDI	04/06→12/08	OM 646.820	4cyl. 2148cc 100kW (136PS)	
		Diesel		TD20362
E-Class E 220 CDI E-Class T-Model E 200 CDI E-Class T-Model E 220 T CDI	03/03→12/08 04/06→07/09 03/03→07/09	OM 646.821	4cyl. 2148cc 100kW (136PS)	
		Diesel	Turbo Intercooled	TD20334
CLK 220 CDI	01/05→05/09	OM 646.966	4cyl. 2148cc 110kW (150PS)	
		Diesel	Turbo Intercooled	TD22844
Sprinter 3, 5 Platform/Chassis 309 CDI, Sprinter 3, 5-t Box 309 CDI, Sprinter 3-T Box 209 CDI, Sprinter 3-t Platform/Chassis 209 CDI, Sprinter 5-t Box 509 CDI, Sprinter 5-t Platform/Chassis 509 CDI	06/06→	OM 646.984	4cyl. 2148cc 65kW (88PS)	
		Diesel	Turbo Intercooled	TD22140
Sprinter 3, 5 Platform/Chassis 315 CDI Sprinter 3, 5 Platform/ Chassis 315 CDI 4x4 Sprinter 3, 5-t Box 315 CDI Sprinter 3, 5-t Box 315 CDI 4x4 Sprinter 3, 5-t Bus 315 CDI Sprinter 3, 5-t Bus 315 CDI 4x4 Sprinter 3-T Box 215 CDI, Sprinter 3-T Bus 215 CDI, Sprinter 3-t Platform/Chassis 215 CDI Sprinter 4, 6-t Box 415 CDI Sprinter 4, 6-t Platform/Chassis 415 CDI, Sprinter 5-t Box 515 CDI, Sprinter 5-t Box 515 CDI 4x4, Sprinter 5-t Platform/Chassis 515 CDI, Sprinter 5-t Platform/ Chassis 515 CDI 4x4	06/06→ 02/08→ 06/06→ 02/08→ 06/06→ 02/08→ 06/06→	OM 646.990	4cyl. 2148cc 110kW (150PS)	
		Diesel	Turbo Intercooled	TD23618

08-136400-10	STD	88.00	2.500		001 IF GDC P	KV1
			2.000		005 IFU CR P	KV1
			3.000		231 CR P	GOE13







E-Class E 200 CDI	07/02→12/08	OM 646.951	4cyl.							28
			2148cc	75-90kW (102-122PS)						
		Diesel	Turbo Intercooled							TD18129
E-Class E 220 CDI	03/02→12/08	OM 646.961	4cyl.							
E-Class T-Model E 220 CDI,	03/03→07/09		2148cc	110kW (150PS)						
E-Class T-Model E 220 T CDI		Diesel	Turbo Intercooled							TD17007
C-Class C 200 CDI	02/01→02/07	OM 646.962	4cyl.							
C-Class Coupe C 200 CDI	03/03→05/08		2148cc	75-90kW (102-122PS)						
C-Class T-Model C 200 CDI	03/01→08/07	Diesel	Turbo Intercooled							TD17542
CLC-Class CLC 200 CDI	05/08→06/11									
C-Class C 220 CDI	02/04→02/07	OM 646.963	4cyl.							
C-Class Coupe C 220 CDI	02/04→05/08		2148cc	110kW (150PS)						
C-Class T-Model C 220 CDI	02/04→08/07	Diesel	Turbo Intercooled							TD17543
CLC-Class CLC 220 CDI	05/08→06/11									
Viano CDI 2.0	09/03→	OM 646.982 Euro 4	4cyl.							
Viano CDI 2.0 4-matic	07/05→		2148cc	80-110kW (109-150PS)						
Viano CDI 2.2	09/03→	Diesel	Turbo Intercooled							
Viano CDI 2.2 4-matic	07/05→									
Vito / Mixto Box 111 CDI	09/03→									
Vito / Mixto Box 111 CDI 4x4	09/07→									
Vito / Mixto Box 115 CDI	09/03→									
Vito / Mixto Box 115 CDI 4x4	07/06→									
Vito Bus 111 CDI	09/03→									
Vito Bus 111 CDI 4x4	09/07→									
Vito Bus 115 CDI	09/03→									
Vito Bus 115 CDI 4x4	09/07→									TD18289
Vito / Mixto Box 109 CDI,	09/03→	OM 646.983	4cyl.							
Vito Bus 109 CDI			2148cc	65kW (88PS)						
		Diesel	Turbo Intercooled							TD20921
E-Class E 270 CDI	03/02→12/08	OM 647.961	5cyl.							
E-Class T-Model E 270 T CDI	03/03→07/09		2685cc	130kW (177PS)						
		Diesel	Turbo Intercooled							TD17008
Sprinter CDI	04/00→	OM 647.981	5cyl.							
			2685cc	60-130kW (82-177PS)						
		Diesel	Turbo Intercooled							TD21142
S-Class S 320 CDI	09/02→08/05	OM 648.960	6cyl.							
			3222cc	150kW (204PS)						
		Diesel	Turbo Intercooled							TD17187
E-Class E 280 CDI	05/04→12/08	OM 648.961	6cyl.							
E-Class E 320 CDI	11/02→12/08		3222cc	130-150kW (177-204PS)						
E-Class T-Model E 280 T CDI	05/04→07/09	Diesel	Turbo Intercooled							
E-Class T-Model E 320 T CDI	03/03→07/09									TD17328

08-136400-00	STD	88.00	2.500		001 IF CK P	KV1
08-136407-00	0.50mm		2.000		005 IFU P	F12/F14
[R67934]			3.000		231 CR P	STD



Vito Bus 109 CDI	09/06→	OM 646.980	4cyl. 2148cc 70kW (95PS)	29
		Diesel	Turbo Intercooled	TD24573
Vito / Mixto Box 109 CDi	08/06→	OM 646.981	4cyl. 2148cc 70kW (95PS)	
Vito Bus 109 CDI 4x4	09/07→			TD20984
Sprinter 3, 5 Platform/Chassis 311 CDI	06/06→	OM 646.985	4cyl. 2148cc 80kW (109PS)	
Sprinter 3, 5 Platform/ Chassis 311 CDI 4x4	02/08→			
Sprinter 3, 5-t Box 311 CDI	06/06→	Diesel	Turbo Intercooled	
Sprinter 3, 5-t Box 311 CDI 4x4	02/08→			
Sprinter 3, 5-t Bus 311 CDI	06/06→			
Sprinter 3, 5-t Bus 311 CDI 4x4	02/08→			
Sprinter 3-T Box 211 CDI, Sprinter 3-T Bus 211 CDI, Sprinter 3-t Platform/Chassis 211 CDI	06/06→			
Sprinter 4, 6-t Box 411 CDI, Sprinter 4, 6-t Platform/Chassis 411 CDI	06/09→			
Sprinter 5-t Box 511 CDI, Sprinter 5-t Box 511 CDI 4x4, Sprinter 5-t Platform/Chassis 511 CDI, Sprinter 5-t Platform/ Chassis 511 CDI 4x4	06/06→			TD20730
Sprinter 3, 5 Platform/Chassis 313 CDI, Sprinter 3, 5-t Box 313 CDI, Sprinter 3-T Box 213 CDI, Sprinter 3-t Platform/Chassis 213 CDI, Sprinter 4, 6-t Box 413 CDI, Sprinter 4, 6-t Platform/Chassis 413 CDI, Sprinter 5-t Box 513 CDI, Sprinter 5-t Platform/Chassis 513 CDI	06/06→	OM 646.986 Euro 4	4cyl. 2148cc 95-110kW (129-150PS)	
		Diesel	Turbo Intercooled	TD23620
Sprinter 3, 5 Platform/Chassis 315 CDI	06/06→	OM 646.989	4cyl. 2148cc 110kW (150PS)	
Sprinter 3, 5 Platform/ Chassis 315 CDI 4x4	02/08→			
Sprinter 3, 5-t Box 315 CDI	06/06→	Diesel	Turbo Intercooled	
Sprinter 3, 5-t Box 315 CDI 4x4	02/08→			
Sprinter 3, 5-t Bus 315 CDI	06/06→			
Sprinter 3, 5-t Bus 315 CDI 4x4	02/08→			
Sprinter 3-T Box 215 CDI, Sprinter 3-T Bus 215 CDI, Sprinter 3-t Platform/Chassis 215 CDI	06/06→			
Sprinter 4, 6-t Box 415 CDI	06/09→			
Sprinter 4, 6-t Platform/Chassis 415 CDI, Sprinter 5-t Box 515 CDI, Sprinter 5-t Box 515 CDI 4x4, Sprinter 5-t Platform/Chassis 515 CDI, Sprinter 5-t Platform/ Chassis 515 CDI 4x4	06/06→			TD26257

08-428700-00	STD	88.00	2.500		001 GDC P	KV4
08-428707-00	0.50mm		2.000		005 IF CR P	KV1
			2.000		231 LKZ CR P	KV1
						



Saloon 300 E	01/85→12/85	M 103.980	6cyl. 2962cc	132-140kW (180-190PS)	30	TD2099
S-Class 300 SE, SEL	09/85→06/91	M 103.981 (KAT)	6cyl. 2962cc	132-140kW (180-190PS)		TD9436
SL 300 SL	09/85→08/89	M 103.982	6cyl. 2962cc	132-140kW (180-190PS)		TD9444
Coupe 300 CE	03/87→05/93	M 103.983	6cyl. 2962cc	132-140kW (180-190PS)		TD9437
Kombi Estate 300 TE	01/86→08/92					
Kombi Estate 300 TE 4-matic	09/86→12/89					
Saloon 300 E	06/85→08/92					
Saloon 300 E 4-matic	09/86→02/92					
SL 300 SL	03/89→08/93	M 103.984	6cyl. 2962cc	132-140kW (180-190PS)		TD2103
E-Class E 300 4-matic	06/93→06/95	M 103.985	6cyl. 2962cc	132-140kW (180-190PS)		TD2104
E-Class Estate E 300 T 4-matic	06/93→06/96					
Kombi Estate 300 TE 4-matic,	09/86→06/93					
Saloon 300 E 4-matic						
G-Class 300 GE	06/90→	M 103.987	6cyl. 2962cc	132-140kW (180-190PS)		TD2105
G-Class Cabrio 300 GE	09/89→09/97					

08-183000-00	STD	88.50	1.500		001 IW CK P	KV1
08-183007-00	0.50mm		1.750		026 P	F12/F14
			3.000		231 CR P	STD

Cabriolet 300 CE-24	04/92→06/93	M 104.980	6cyl. 2960cc	162-170kW (220-231PS)	31	TD2110
Coupe 300 CE-24	09/89→12/92					
E-Class Estate E 300 TE-24 AMG	06/93→06/96					
Kombi Estate 300 TE-24	09/89→08/92					
Saloon 300 E-24	09/88→08/92					
SL 300 SL-24	03/89→07/93	M 104.981	6cyl. 2960cc	162-170kW (220-231PS)		TD2111

08-287700-00	STD	88.50	1.500		001 IF NT	ST
			1.750		026 P	STD
			3.000		231 CR P	STD



190 E 1.8	04/90→08/93	M 102.910	4cyl. 1797cc	77-80kW (105-109PS)	32 TD2061
190 E 1.8 (201)	04/92→08/93	M 102.919	4cyl. 1797cc	77kW (105PS)	TD2062
Kombi Estate 200 T Saloon 200	11/80→11/85 06/80→11/85	M 102.920	4cyl. 1997cc	66-77kW (90-105PS)	TD2063
190 2.0	10/82→10/84	M 102.921	4cyl. 1997cc	66-77kW (90-105PS)	TD2064
Kombi Estate 200 E Kombi Estate 200 T Saloon 200 Saloon 200 E	11/92→05/93 09/85→05/90 12/85→05/90 11/92→05/93	M 102.922	4cyl. 1997cc	62-93kW (84-126PS)	TD2065
190 2.0	09/84→05/90	M 102.924	4cyl. 1997cc	62-93kW (84-126PS)	TD4653
Kombi Estate 200 T Saloon 200	11/80→11/85 06/80→11/85	M 102.939	4cyl. 1997cc	62-93kW (84-126PS)	TD2069
190 E 2.0	10/82→06/93	M 102.961	4cyl. 1997cc	62-93kW (84-126PS)	TD5050
190 E 2.0 Kombi Estate 200 TE	10/82→08/93 09/88→12/89	M 102.962	4cyl. 1997cc	62-93kW (84-126PS)	TD4655
Kombi Estate 200 TE, Saloon 200 E	09/88→08/92	M 102.963	4cyl. 1997cc	62-93kW (84-126PS)	TD2078
200 GE (Italy) 460	05/85→	M 102.964	4cyl. 1997cc	80kW (109PS)	TD17723
G-Class 200 GE, G-Class Cabrio 200 GE	01/90→07/93	M 102.965	4cyl. 1996cc	80kW (109PS)	TD2080



08-179500-00	STD	89.00	1.750		001 IF CR P	KV1
08-179505-00	0.25mm		2.000		026 P	STD
08-179507-00	0.50mm		3.500		231 CR P	STD
08-179511-00	1.00mm					
01/1989→						
08-181400-10	STD	89.00	1.750		001 IF MOL P	KV1
08-181407-10	0.50mm		2.000		026 P	F12/F14
→12/1988			3.500		231 CR P	STD
[R48050]						



S-Class 600 SE, SEL	04/91→12/92	M 120.980					33
S-Class S 600	01/93→10/98		V12cyl.				
S-Class Coupe SEC/CL 600	09/92→02/99		5987cc	290-300kW (394-408PS)			
SL 600 SL	02/92→08/94						TD2192

SL 600	07/92→10/01	M 120.981					
			V12cyl.				
			5987cc	280-290kW (381-394PS)			
							TD2193

SL 600	07/92→10/01	M 120.983					
			V12cyl.				
			5987cc	290kW (394PS)			
							TD11496

08-287400-00	STD	89.00	1.500		001 IF NT	ST
			2.000		005 IF CR P	F12/F14
			3.000		231 CR P	STD

Sprinter 2-T Bus 208 D, Sprinter 2-t Platform/Chassis 208 D, Sprinter 3-T Box 308 D 2.3, Sprinter 3-T Bus 308 D, Sprinter 3-t Platform/Chassis 308 D 2.3				OM 601.900 Euro 2 (OM 601 D23)			34
				4cyl.			
			2299cc	62kW (84PS)			
			Diesel				TD16185

T1 Box 208 D 2.3	10/88→02/96			OM 601.940 (OM 601)			
T1 Box 308 D 2.3	11/88→02/96			4cyl.			
T1 Bus 208 D 2.3	10/88→02/96		2299cc	58-60kW (79-82PS)			
T1 Bus 308 D 2.3	06/89→02/96		Diesel				
T1 Platform/Chassis 208 D 2.3	11/88→02/96						
T1 Platform/Chassis 308 D 2.3	06/89→02/96						
T1/TN Box Body / Estate 408 D, T1/ TN Platform/Chassis 408 D	11/88→06/95						TD2210

T2/LN1 Box Body / Estate 508 D, T2/ LN1 Dumptruck 508 D	03/89→12/94			OM 601.941 (OM 601)			
				4cyl.			
			2299cc	58-60kW (79-82PS)			
			Diesel				TD8041

Vito Box 108 D 2.3	03/97→07/03			OM 601.942 (OM 601)			
Vito Bus 108 D 2.3	02/96→07/03			4cyl.			
			2299cc	58kW (79PS)			
			Diesel				TD5398

Sprinter 2-T Box 208 D, Sprinter 2-T Bus 208 D	02/95→04/00			OM 601.943 (OM 601)			
Sprinter 2-t Platform/Chassis 208 D	01/95→04/00			4cyl.			
Sprinter 3-T Box 308 D 2.3, Sprinter 3-T Bus 308 D, Sprinter 3-t Platform/Chassis 308 D 2.3	02/95→04/00			2299cc	58kW (79PS)		
Sprinter 4-T Box 408 D, Sprinter 4-t Platform/Chassis 408 D	02/96→05/06			Diesel			TD5400

V-Class V 230 TD	09/96→07/03			OM 601A.970 (OM 601 LA)			
Vito Box 110 D 2.3	03/97→07/03			4cyl.			
Vito Bus 110 TD 2.3	02/96→07/03		2299cc	72kW (98PS)			
			Diesel	Turbo Intercooled			TD4674

O 100 City	01/94→			OM 602.940			
				5cyl.			
			2874cc	70kW (95PS)			
			Diesel				TD3613





O 100 City	01/94→	OM 602.940 (OM 602)		
T1 Box 210 D 2.8	10/88→02/96	5cyl.		
T1 Box 310 D 2.9	06/89→02/96	2874cc	70-72kW (9598PS)	
T1 Bus 210 D 2.8	11/88→02/96	Diesel		
T1 Bus 310 D 2.9	06/89→02/96			
T1 Platform/Chassis 210 D 2.8,	11/88→02/96			
T1 Platform/Chassis 210 D 2.9				
T1 Platform/Chassis 310 D 2.9	06/89→02/96			
T1/TN Box Body / Estate 410 D, T1/ TN Platform/Chassis 410 D	11/88→06/95			TD2215
Unimog U 90	11/92→	OM 602.941 (OM 602)		
		5cyl.		
		2874cc	65-70kW (88-95PS)	
		Diesel		TD8013
G-Class 290 GD/G 290 D	04/92→	OM 602.942		
		5cyl.		
		2874cc	70-72kW (95-98PS)	
		Diesel		TD2054
G-Class 290 GD/G 290 D		OM 602.946		
		5cyl.		
		2874cc	70kW (95PS)	
		Diesel		TD17817
G-Class 290 GD/G 290 D		OM 602.947		
		5cyl.		
		2874cc	72kW (98PS)	
		Diesel		TD17818
Unimog U 100L	11/92→	OM 602.948 (OM 602)		
		5cyl.		
		2874cc	71kW (96PS)	
		Diesel		TD8014
Sprinter 2-T Box 210 D	01/97→04/00	OM 602.980 (OM 602 DE 29LA)		
Sprinter 2-T Box 212 D	02/95→04/00	5cyl.		
Sprinter 2-T Bus 210 D	03/97→04/00	2874cc	75-90kW (102-122PS)	
Sprinter 2-T Bus 212 D	02/95→04/00	Diesel	Turbo Intercooled	
Sprinter 2-t Platform/Chassis 210 D	01/97→04/00			
Sprinter 2-t Platform/Chassis 212 D,	02/95→04/00			
Sprinter 3-T Box 310 D 2.9,				
Sprinter 3-T Box 312 D 2.9				
Sprinter 3-T Box 312 D 2.9 4x4	05/97→08/02			
Sprinter 3-T Bus 2.9 TDi	01/97→12/99			
Sprinter 3-T Bus 310 D 4x4	05/97→08/02			
Sprinter 3-T Bus 312 D 2.9	02/95→04/00			
Sprinter 3-T Bus 312 D 2.9 4x4	05/97→08/02			
Sprinter 3-t Platform/Chassis 310 D 2.9	01/97→04/00			
Sprinter 3-t Platform/Chassis 312 D 2.9	02/95→04/00			
Sprinter 4-T Box 410 D	02/96→05/06			
Sprinter 4-T Box 410 D 4x4	05/97→05/06			
Sprinter 4-T Box 412 D	02/96→05/06			
Sprinter 4-T Box 412 D 4x4	05/97→05/06			
Sprinter 4-t Platform/Chassis 410 D	02/96→05/06			
Sprinter 4-t Platform/Chassis 410 D 4x4	05/97→05/06			
Sprinter 4-t Platform/Chassis 412 D	02/96→05/06			
Sprinter 4-t Platform/Chassis 412 D 4x4	05/97→05/06			TD8032
Unimog U 100L, Unimog U 90	07/96→	OM 602.981 Euro 2 (OM 602 D29 LA)		
Unimog UX 100H, UX 100M	09/96→	5cyl.		
		2874cc	85-90kW (116-122PS)	
		Diesel	Turbo Intercooled	TD14670





E-Class E 290 Turbo-D E-Class Estate E 290 T Turbo-D	03/96→07/99 06/96→07/99	OM 602.982 5cyl. 2874cc 95kW (129PS) Diesel Turbo Intercooled	TD4675
G-Class G 290 TD	07/97→	OM 602.983 5cyl. 2874cc 88kW (120PS) Diesel Turbo Intercooled	TD12910
Vario Box Body / Estate 512 D, Vario Box Body / Estate 612 D, Vario Box Body / Estate 812 D, Vario Bus O 812, Vario Dumptruck 612 D, Vario Dumptruck 812 D, Vario Platform/ Chassis 812 D, Vario Platform/ Chassis 512 D, Vario Platform/ Chassis 612 D	09/96→	OM 602.984 (OM 602 LA) 5cyl. 2874cc 90kW (122PS) Diesel Turbo Intercooled	TD5682
Vario Box Body / Estate 612 D, Vario Box Body / Estate 812 D, Vario Bus O 812, Vario Dumptruck 612 D, Vario Dumptruck 812 D, Vario Platform/ Chassis 812 D, Vario Platform/ Chassis 612 D	09/96→	OM 602.985 (OM 602 LA) 5cyl. 2874cc 90kW (122PS) Diesel Turbo Intercooled	TD6020
Sprinter 2-T Bus 210 D		OM 602.986 5cyl. 2874cc 75-90kW (102-122PS) Diesel Turbo	TD9459
Unimog U 100L, Unimog U 90 Unimog UX 100H, UX 100M	07/96→ 09/96→	OM 602.989 Euro 2 (OM 602 D29 LA) 5cyl. 2874cc 85-90kW (116-122PS) Diesel Turbo Intercooled	TD14672
O 405 O 405 GTZ		OM 602.991 (OM 602) 5cyl. 2874cc 70kW (95PS) Diesel	TD17820
O 405 O 405 GTZ		OM 602.994 (OM 602) 5cyl. 2874cc 72kW (98PS) Diesel	TD17822
350 D	03/90→06/91	OM 603A.970 6cyl. 3449cc 100kW (136PS) Diesel Turbo	TD2224
Saloon 300 TD SD S-Class S 350 Turbo-D	06/91→05/93 01/93→10/98	OM 603A.971 6cyl. 3449cc 110kW (150PS) Diesel Turbo	TD2225
G-Class 350 Turbo GD G-Class Cabrio 350 G Turbo-D	09/91→ 09/91→09/97	OM 603A.972 6cyl. 3449cc 100kW (136PS) Diesel Turbo	TD2226
C-Class C 220 D C-Class Estate C 220 T D	08/93→05/00 06/96→03/01	OM 604.910 4cyl. 2155cc 55-70kW (75-95PS) Diesel	TD2227





E-Class E 220 D		06/95→03/02	OM 604.912	4cyl. 2155cc	55-70kW (75-95PS)		
			Diesel				TD4676
08-743100-00	STD	89.00	2.500		001 IF CR P		KV1
08-743107-00	0.50mm		2.000		005 IF P		STD
08-743120-00	0.70mm		3.000		231 CR P		GOE12
<i>[R45080]</i>							
C-Class C 280		05/93→05/00	M 104.941	6cyl. 2799cc	142kW (193PS)		35 TD2106
E-Class E 280		06/93→06/95	M 104.942	6cyl. 2799cc	142-145kW (193-197PS)		TD2107
E-Class Estate E 280 T		06/93→06/96					
Kombi Estate 280 TE, Saloon 280 E		10/92→06/93					
SL 280		08/93→10/01	M 104.943	6cyl. 2799cc	142-150kW (193-204PS)		TD2108
S-Class 300 SE 2.8		01/93→10/98	M 104.944	6cyl. 2799cc	142-145kW (193-197PS)		TD2109
S-Class S 280		02/93→10/98					
E-Class E 280		01/96→06/97	M 104.945	6cyl. 2799cc	142kW (193PS)		TD9423
S-Class 300 SE, SEL/S320		03/91→10/98	M 104.990	6cyl. 3199cc	170kW (231PS)		TD2112
SL 320		09/93→10/01	M 104.991	6cyl. 3199cc	170kW (231PS)		TD2113
Coupe 320 CE		10/92→05/93	M 104.992	6cyl. 3199cc	162kW (220PS)		TD2114
E-Class E 320		06/93→06/95					
E-Class Convertible E 320		06/93→03/98					
E-Class Coupe E 320		06/93→06/97					
E-Class Estate E 320 T		06/93→06/96					
Kombi Estate 320 TE, Saloon 320 E		10/92→06/93					
S-Class 300 SE, SEL/S320		03/91→10/98	M 104.994	6cyl. 3199cc	170kW (231PS)		TD11250
E-Class E 320		06/95→06/97	M 104.995	6cyl. 3199cc	162kW (220PS)		TD4658
E-Class Convertible E 320		06/93→03/98					
G-Class G 320		09/94→12/97	M 104.996	6cyl. 3199cc	155kW (211PS)		TD11251
G-Class Cabrio 320 GE		09/94→11/97					





E-Class E 200	06/93→06/95	M 111.940			
E-Class Convertible E 200	06/93→03/98		4cyl.		
E-Class Coupe E 200	06/93→06/97		1998cc	100kW (136PS)	
E-Class Estate E 200 T	06/93→06/96				
Kombi Estate 200 TE, Saloon 200 E	10/92→06/93				TD2132
C-Class C 200	01/94→05/00	M 111.941			
C-Class Estate C 200 T	06/96→03/01		4cyl.		
CLK Convertible 200	03/98→03/02		1998cc	100kW (136PS)	
					TD2133
E-Class E 200	06/95→08/00	M 111.942			
E-Class Estate E 200 T	06/96→08/00		4cyl.		
			1998cc	100kW (136PS)	
					TD4660
SLK 200 Kompressor	10/96→03/00	M 111.943			
			4cyl.		
			1998cc	132-141kW (180-192PS)	
			Supercharged		
					TD4661
C-Class C 200 Kompressor	10/95→05/00	M 111.944			
C-Class Estate C 200 T Kompressor	11/96→03/01		4cyl.		
CLK 200 Kompressor	06/97→06/00		1998cc	132-141kW (180-192PS)	
CLK Convertible 200 Kompressor	03/98→06/00		Supercharged		
					TD4662
C-Class C 200	01/94→05/00	M 111.945			
C-Class Estate C 200 T	06/96→03/01		4cyl.		
CLK 200	06/97→06/02		1998cc	100kW (136PS)	
CLK Convertible 200	03/98→03/02				
					TD5236
SLK 200	09/96→03/00	M 111.946			
			4cyl.		
			1998cc	100kW (136PS)	
					TD4663
E-Class E 200 Kompressor	06/97→03/02	M 111.947			
E-Class Estate E 200 T Kompressor	06/97→03/03		4cyl.		
			1998cc	137kW (186PS)	
			Supercharged		
					TD9419
V-Class V 200	02/97→07/03	M 111.948			
Vito Box 113 2.0	03/97→07/03		4cyl.		
Vito Bus 113 2.0	02/96→07/03		1998cc	95kW (129PS)	
					TD5399
V-Class V 200	02/97→07/03	M 111.950			
Vito Box 113 2.0	03/97→07/03		4cyl.		
Vito Bus 113 2.0	02/96→07/03		1998cc	95kW (129PS)	
					TD22702
C-Class C 180	10/00→05/02	M 111.951			
C-Class Coupe C 180,	03/01→05/02		4cyl.		
C-Class T-Model C 180			1998cc	95kW (129PS)	
					TD17002
C-Class Estate C 180 T	09/00→03/01	M 111.952			
			4cyl.		
			1998cc	95kW (129PS)	
					TD17003
C-Class C 200 Kompressor	05/00→05/02	M 111.955			
C-Class Coupe C 200 Kompressor,	03/01→05/02		4cyl.		
C-Class T-Model C 200 Kompressor			1998cc	120kW (163PS)	
			Supercharged		
					TD14751
C-Class Estate C 200 T Kompressor	09/00→03/01	M 111.956			
CLK 200 Kompressor	06/00→06/02		4cyl.		
CLK Convertible 200 Kompressor	06/00→03/02		1998cc	120kW (163PS)	
			Supercharged		
					TD16488





E-Class E 200 Kompressor		08/00→03/02	M 111.957				
E-Class Estate E 200 T Kompressor		08/00→03/03		4cyl.	1998cc	120kW (163PS)	
						Supercharged	TD15456
SLK 200 Kompressor		03/00→04/04	M 111.958				
				4cyl.	1998cc	120kW (163PS)	
						Supercharged	TD14749
Coupe 220 CE		10/92→05/93	M 111.960				
E-Class E 220		06/93→06/95		4cyl.			
E-Class Convertible E 220		06/93→03/98			2199cc	110kW (150PS)	
E-Class Coupe E 220		06/93→06/97					
E-Class Estate E 220 T		06/93→06/96					
Kombi Estate 220 TE		10/92→05/93					
Saloon 220 E		10/92→06/93					TD2134
C-Class C 220		03/93→05/00	M 111.961				
				4cyl.	2199cc	110kW (150PS)	
							TD2135
08-287500-00	STD	89.90	1.500		001 IF NT		ST
08-287505-00	0.25mm		1.750		026 P		STD
08-287507-00	0.50mm		3.000		231 CR P		STD
[R66600]							
C-Class C 280		06/97→05/00	M 112.920				
C-Class Estate C 280 T		06/97→03/01		V6cyl.	2799cc	145-150kW (197-204PS)	36
							TD9421
E-Class E 280, E-Class E 280 4-matic		12/96→03/02	M 112.921				
E-Class Estate E 280 T,		12/96→03/03		V6cyl.	2799cc	150kW (204PS)	
E-Class Estate E 280 T 4-matic							TD9417
S-Class S 280		10/98→08/05	M 112.922				
				V6cyl.	2799cc	150kW (204PS)	
							TD11490
SL 280		05/98→10/01	M 112.923				
				V6cyl.	2799cc	150kW (204PS)	
							TD10888
SL 280		05/98→10/01	M 112.925				
				V6cyl.	2799cc	150kW (204PS)	
							TD15463
CLK 320		06/97→06/02	M 112.940				
CLK Convertible 320		03/98→03/02		V6cyl.	3199cc	160-162kW (218-220PS)	
							TD9407
E-Class E 320, E-Class E 320 4-matic		06/97→03/02	M 112.941				
E-Class Estate E 320 T,		12/96→03/03		V6cyl.	3199cc	165kW (224PS)	
E-Class Estate E 320 T 4-matic							TD9418
M-Class ML 320		02/98→08/02	M 112.942				
				V6cyl.	3199cc	160kW (218PS)	
							TD9898





SL 320	05/98→10/01	M 112.943	V6cyl. 3199cc	165kW (224PS)	TD11494
S-Class S 320	10/98→08/05	M 112.944	V6cyl. 3199cc	165kW (224PS)	TD11491
G-Class G 320 G-Class Cabrio G 320	07/97→ 11/97→	M 112.945	V6cyl. 3199cc	158kW (215PS)	TD9888
C-Class C 320 C-Class Coupe C 320 C-Class T-Model C 320	05/00→02/07 09/02→05/08 03/01→08/07	M 112.946	V6cyl. 3199cc	160kW (218PS)	TD15452
SLK 320	03/00→04/04	M 112.947	V6cyl. 3199cc	160kW (218PS)	TD14773
E-Class E 320 E-Class T-Model E 320 T	03/02→12/08 03/03→07/09	M 112.949	V6cyl. 3199cc	165kW (224PS)	TD16894
E-Class E 430 E-Class E 430 4-matic E-Class Estate E 430 T E-Class Estate E 430 T 4-matic	06/97→03/02 05/99→03/02 06/97→03/03 05/99→03/03	M 113.940	V8cyl. 4266cc	205kW (279PS)	TD9889
S-Class S 430	10/98→08/05	M 113.941	V8cyl. 4266cc	205kW (279PS)	TD11492
M-Class ML 430	02/98→06/05	M 113.942	V8cyl. 4266cc	199kW (271PS)	TD10949
CLK 430 CLK Convertible 430	07/98→06/02 09/98→03/02	M 113.943	V8cyl. 4266cc	205kW (279PS)	TD10947
C-Class C 43 AMG C-Class Estate C 43 AMG	08/97→05/00 08/97→03/01	M 113.944	V8cyl. 4266cc	225kW (306PS)	TD11489

08-119000-00	STD	89.90	1.500		001 NT	ST
08-119005-00	0.25mm		1.750		026 P	GOE13
08-119007-00	0.50mm		3.000		712 CR	ST
[R67936]						



E-Class E 230 E-Class Estate E 230 T	06/95→06/97 06/96→06/97	M 111.970	4cyl. 2295cc	110kW (150PS)	37 TD4664
CLK 230 Kompressor CLK Convertible 230 Kompressor SLK 230 Kompressor	06/97→06/00 03/98→06/00 09/96→03/00	M 111.973	4cyl. 2295cc Supercharged	142kW (193PS)	TD4665
C-Class C 230 C-Class Estate C 230 T	06/96→06/97 06/96→06/98	M 111.974	4cyl. 2295cc	110kW (150PS)	TD4666
C-Class C 230 Kompressor C-Class Estate C 230 T Kompressor CLK 230 Kompressor CLK Convertible 230 Kompressor	10/95→05/00 06/97→09/00 06/97→06/00 03/98→06/00	M 111.975	4cyl. 2295cc Supercharged	142kW (193PS)	TD4667
M-Class ML 230	02/98→06/05	M 111.977	4cyl. 2295cc	110kW (150PS)	TD10948
V-Class V 230 Vito Box 114 2.3 Vito Bus 114 2.3	10/96→07/03 03/97→07/03 12/96→07/03	M 111.978	4cyl. 2295cc	105kW (143PS)	TD4668
Sprinter 2-T Box 214, Sprinter 2-T Bus 214, Sprinter 2-t Platform/Chassis 214, Sprinter 3-T Box 314 Sprinter 4-T Box 414 Sprinter 4-T Box 414 4x4 Sprinter 4-T Bus 414, Sprinter 4-t Platform/Chassis 414 Sprinter 4-t Platform/Chassis 414 4x4	02/95→05/06 02/96→05/06 05/97→05/06 02/96→05/06 05/97→05/06	M 111.979	4cyl. 2295cc	105kW (143PS)	TD5241
V 230 Viano 230 Vito 114	04/96→09/03 04/96→ 11/95→07/03	M 111.980	4cyl. 2295cc	105kW (143PS)	TD22703
C-Class Coupe C 230 Kompressor	03/01→05/02	M 111.981	4cyl. 2295cc	145kW (197PS)	TD17177
CLK 230 Kompressor CLK Convertible 230 Kompressor	06/00→06/02 06/00→03/02	M 111.982	4cyl. 2295cc Supercharged	142kW (193PS)	TD16884
SLK 230 Kompressor	03/00→04/04	M 111.983	4cyl. 2295cc Supercharged	145kW (197PS)	TD14750
Sprinter 2-T Box 214 Sprinter 2-T Box 214 NGT, Sprinter 2-T Bus 214 NGT Sprinter 3-T Box 314 Sprinter 3-T Box 314 4x4 Sprinter 3-T Bus 314 Sprinter 3-T Bus 314 4x4 Sprinter 3-T Bus 314 NGT Sprinter 3-t Platform/Chassis 314 Sprinter 3-t Platform/Chassis 314 4x4	02/95→05/06 04/00→05/06 02/95→05/06 08/02→05/06 02/95→05/06 08/02→05/06 04/00→05/06 02/95→05/06 08/02→05/06	M 111.984	4cyl. 2295cc	92-105kW (125-143PS)	TD17850







MB 100 2.3			11/96→		M 161.971	4cyl. 2295cc	105-110kW (143-150PS)	TD23184
08-109100-00	STD	90.90	1.500		001 IF NT			ST
08-109107-00	0.50mm		1.750		026			STD
[R66610]			3.000		231 NT			ST
T1/TN Box Body / Estate 407 D, T1/ TN Platform/Chassis 407 D			07/81→01/89		OM 616.913 (OM 616)	4cyl. 2399cc	53kW (72PS)	38 TD2247
T2/LN1 Box Body / Estate 507 D, T2/ LN1 Dumptruck 507 DK, T2/LN1 Platform/ Chassis 507 D			04/86→04/89		OM 616.914 (OM 616)	4cyl. 2399cc	53kW (72PS)	TD8040
G-Class 240 GD			03/79→08/87		OM 616.936	4cyl. 2399cc	53kW (72PS)	TD2251
T1 Box 207 D 2.4			06/82→01/90		OM 616.937 (OM 616)	4cyl. 2399cc	53kW (72PS)	TD2252
T1 Box 307 D 2.4			10/82→01/90					
T1 Platform/Chassis 207 D 2.4			12/77→10/89					
T1 Platform/Chassis 307 D 2.4			04/77→01/90		Diesel			
G-Class 240 GD					OM 616.938	4cyl. 2399cc	53kW (72PS)	TD17733
T1 Box 207 D 2.4			06/82→01/90		OM 616.939 (OM 616)	4cyl. 2399cc	53kW (72PS)	TD2253
T1 Box 307 D 2.4			10/82→01/90					
T1 Platform/Chassis 307 D 2.4			06/82→01/90					
T1/TN Box Body / Estate 407 D, T1/ TN Platform/Chassis 407 D			07/81→01/89		Diesel			
240 GD			09/78→		OM 616.940 (OM 616)	4cyl. 2399cc	53kW (72PS)	TD22836
Unimog U 600, Unimog U 650, U 650L			05/88→		OM 616.942 (OM 616)	4cyl. 2399cc	38kW (52PS)	TD7991
Unimog U 600, Unimog U 650, U 650L			05/88→		OM 616.943 (OM 616)	4cyl. 2399cc	44kW (60PS)	TD7992
U 600, U 650			05/88→02/01		OM 616.944 (OM 616)	4cyl. 2399cc	44kW (60PS)	TD16937





T1 Box 209 D 2.9	12/82→01/90	OM 617.913 (OM 617)				
T1 Box 309 D 3.0	10/82→01/90	5cyl.				
T1 Bus 209 D 2.9, T1 Platform/ Chassis 209 D 2.9	12/82→01/90	2998cc	65kW (88PS)	Diesel		
T1 Platform/Chassis 309 D 3.0	10/82→01/90					
T1/TN Box Body / Estate 409 D, T1/ TN Platform/Chassis 409 D	04/82→01/89					TD2261
G-Class 300 GD	12/79→12/91	OM 617.931				
		5cyl.				
		2998cc	65kW (88PS)	Diesel		TD2262
G-Class 300 GD		OM 617.932				
		5cyl.				
		2998cc	65kW (88PS)	Diesel		TD17743
300 GD	12/79→08/90	OM 617.933				
		5cyl.				
		2998cc	65kW (88PS)	Diesel		TD26550
Kombi Estate 300 T Turbo-D		OM 617.950				
		5cyl.				
		2998cc	85-92kW (116-125PS)	Diesel Turbo		TD2263
300 SD Turbo	08/90→10/85	OM 617.951				
		5cyl.				
		2998cc	92kW (125PS)	Diesel Turbo		TD2264
Coupe 300 C Turbo-D	09/81→07/85	OM 617.952				
Kombi Estate 300 T Turbo-D	10/80→11/85	5cyl.				
Saloon 300 Turbo-D	08/81→07/85	2998cc	92kW (125PS)	Diesel		TD2265
08-176700-00	STD	90.90	3.000		001 IF MOL P	KV1
08-176707-00	0.50mm				023 P	STD
08-176708-00	0.60mm		2.000			
08-176711-00	1.00mm				231 CR P	STD
08/1978→			4.000			
[R41220]						
O 309 O 309 D, T2/L Box Body / Estate L 407 D, T2/L Platform/ Chassis L 407 D	01/75→12/88	OM 616.910 (OM 616)				
		4cyl.				
		2399/2404cc	48kW (65PS)	Diesel		TD2245
Unimog U 52, U 60, U 600, U 600L, Unimog U 60T, U 600T	01/77→05/88	OM 616.911 (OM 616)				
		4cyl.				
		2399/2404cc	38kW (52PS)	Diesel		TD5675
Kombi Estate 240 T D	09/77→12/85	OM 616.912				
Saloon 240 D	02/76→11/85	4cyl.				
		2399/2404cc	46-53kW (63-72PS)	Diesel		TD9432
T1 Bus 207 D 2.4	05/77→12/82	OM 616.917 (OM 616)				
T1 Platform/Chassis 207 D 2.4	04/77→12/82	4cyl.				
T1 Platform/Chassis 307 D 2.4	01/77→12/90	2399/2404cc	48kW (65PS)	Diesel		TD2249
T2/L Platform/Chassis L 407 D	01/75→12/88					

39





Unimog U 52, U 60, U 600, U 600L, Unimog U 60T, U 600T		01/77→05/88	OM 616.932 (OM 616) 4cyl. 2399/2404cc 44kW (60PS)		Diesel	TD6015
U 60, U 600		08/73→07/78	OM 616.933 (OM 616) 4cyl. 2399/2404cc 44kW (60PS)		Diesel	TD16998
T1 Bus 207 D 2.4		05/77→12/82	OM 616.934 (OM 616) 4cyl. 2399/2404cc 48kW (65PS)		Diesel	TD2250
Kombi Estate 300 T D Saloon 300 D		09/77→11/85 02/76→11/85	OM 617.912 5cyl. 2998cc 59-65kW (80-88PS)		Diesel	TD2260
08-173800-00	STD	91.00	3.000		001 IF MO P	KV1
08-173805-00	0.25mm		2.000		023 P	STD
08-173807-00	0.50mm		4.000		231 CR P	STD
08-173811-00 →07/1978	1.00mm					
[R34070]						
08-176700-00	STD	90.90	3.000		001 IF MOL P	KV1
08-176707-00	0.50mm		2.000		023 P	STD
08-176708-00	0.60mm		4.000		231 CR P	STD
08-176711-00 08/1978→	1.00mm					
[R41220]						
/8 240 D		08/73→01/77	OM 616.916 4cyl. 2404cc 48kW (65PS)		Diesel	40 TD2248
/8 240 D 3.0		08/74→11/76	OM 617.910 5cyl. 2998cc 59kW (80PS)		Diesel	TD2259
08-173800-00	STD	91.00	3.000		001 IF MO P	KV1
08-173805-00	0.25mm		2.000		023 P	STD
08-173807-00	0.50mm		4.000		231 CR P	STD
08-173811-00 →07/1978	1.00mm					
[R34070]						
S-Class 3.8 SL 380 SL SL Coupe 380 SLC		08/80→08/84 09/80→08/81 07/80→08/81	M 116.960 V8cyl. 3818cc 160kW (218PS)		Diesel	41 TD2158
08-182800-00	STD	92.00	1.750		001 IW CR P	KV1
→08/1981			2.000		026 P	F12/F14
			3.500		231 CR P	STD



SL 420 SL			01/86→08/89	M 116.964	V8cyl. 4196cc	150-160kW (204-218PS)	42
							TD2162
S-Class 420 SE, SEL, S-Class Coupe 420 SEC			10/85→06/91	M 116.965	V8cyl. 4196cc	150-170kW (204-231PS)	TD2163
08-741100-00	STD	92.00	1.500		001 IW CR P		KV1
09/1985→08/1991			2.000		026 CR P		KV1
			3.500		231 CR P		STD
Cabriolet 280 SE 3.5, Coupe 280 SE 3.5			01/69→12/71	M 116.980	V8cyl. 3499cc	147kW (200PS)	43
S-Class 280 SE, SEL 3.5			03/71→08/72				TD2164
S-Class 300 SEL 3.5			01/70→07/72	M 116.981	V8cyl. 3499cc	147kW (200PS)	TD2165
SL 350 SL			05/71→02/80	M 116.982	V8cyl. 3499cc	143-147kW (194-200PS)	TD2166
SL Coupe 350 SLC			01/72→02/80				
S-Class 350 SE, SEL			08/72→02/76	M 116.983	V8cyl. 3499cc	147kW (200PS)	TD2167
SL 350 SL			05/71→02/80	M 116.984	V8cyl. 3499cc	143-147kW (194-200PS)	TD2168
SL Coupe 350 SLC			01/72→02/80				
S-Class 350 SE, SEL			03/76→03/80	M 116.985	V8cyl. 3499cc	143-152kW (195-205PS)	TD2169
SL 450 SL			10/72→10/80	M 117.982	V8cyl. 4520cc	143-165kW (195-225PS)	TD4671
SL Coupe 450 SLC			01/73→08/79				
S-Class 4.5			08/72→07/75	M 117.983	V8cyl. 4520cc	143-165kW (195-225PS)	TD2182
S-Class 450 SE, SEL			01/73→04/80				
S-Class 450 SE, SEL			01/73→04/80	M 117.986	V8cyl. 4520cc	143-165kW (195-225PS)	TD2185
08-178500-10	STD	92.00	1.750		001 IW MOL P		KV1
→08/1979			2.500		026 MO P		STD
			4.000		231 CR P		STD



S-Class 400 SE, SEL/S420	02/91→10/98	M 119.971							44
S-Class S 420	01/93→10/98		V8cyl.						
S-Class Coupe SEC/CL 420	10/94→02/99		4196cc	205kW (279PS)					
									TD2188

08-124200-00 STD 08/1991→10/1992	92.00	1.500		001 IW CR P	KV1
				026 CR P	IKA
				231 CR P	KV1
08-287800-00 STD 10/1992→	92.00	1.500		001 IW CR P	KV1
				026 P	F12/F14
				231 CR	ST
08-741100-00 STD 08/1991→10/1992	92.00	1.500		001 IW CR P	KV1
				026 CR P	KV1
				231 CR P	STD

E-Class E 420	06/93→06/95	M 119.975							45
Saloon 400 E 4.2	10/92→06/93		V8cyl.						
			4196cc	205kW (279PS)					
									TD2191

S-Class Coupe SEC/CL 420	10/94→02/99	M 119.981							
			V8cyl.						
			4196cc	205kW (279PS)					
									TD19046

E-Class E 420	01/96→06/97	M 119.985							
E-Class Estate E 420 T	06/96→06/97		V8cyl.						
			4196cc	205kW (279PS)					
									TD4672

08-287800-00 STD	92.00	1.500		001 IW CR P	KV1
				026 P	F12/F14
				231 CR	ST

/8 230.4	08/73→12/76	M 115.951							46
			4cyl.						
			2308cc	81kW (110PS)					
									TD2149



Coupe 230 C	05/77→04/80	M 115.954							
Kombi Estate 230 T	09/77→03/80		4cyl.						
Saloon 230	02/76→03/81		2308cc	80kW (109PS)					
									TD2151

T1 Box 210 2.3, T1 Bus 208 2.3	05/77→12/82	M 115.955							
T1 Platform/Chassis 210 2.3	04/77→10/89		4cyl.						
			2308cc	62-63kW (84-86PS)					
									TD2152

T1 Bus 208 2.3	05/77→12/82	M 115.972							
			4cyl.						
			2308cc	62-63kW (84-86PS)					
									TD2154





G-Class 230 G		03/79→07/93	M 115.973	4cyl. 2308cc	66-75kW (90-102PS)	TD2155
08-178900-10	STD	93.75	1.750		001 IF MOL P	KV1
08-178906-10	0.40mm		2.500		026 MO P	IKA
08-178910-10	0.80mm		4.000		231 CR P	STD
08-178911-10	1.00mm					
T1 Box 210 2.3		07/82→02/96	M 102.942			47
T1 Box 310 2.3		06/89→02/96		4cyl.		
T1 Bus 210 2.3		07/82→01/90		2298cc	70kW (95PS)	
T1 Platform/Chassis 210 2.3		04/77→10/89				
T1 Platform/Chassis 310 2.3		01/82→12/94				
T1/TN Box Body / Estate 410, T1/ TN Platform/Chassis 410		08/82→06/95				
						TD2070
O 309 O 309 B		01/68→02/89	M 102.943 (M 102)			
T2/L Box Body / Estate L 410		08/82→12/88		4cyl.		
T2/L Dumptruck LK 408 G, LK 409		08/82→09/83		2299cc	70kW (95PS)	
T2/L Platform/Chassis L 410		08/82→12/88				TD2071
T1 Box 210 2.3, T1 Bus 210 2.3		05/89→02/96	M 102.945			
T1/TN Box Body / Estate 410, T1/ TN Platform/Chassis 410		08/82→06/95		4cyl.		
				2299cc	77kW (105PS)	TD2072
T1 Box 210 2.3		07/82→02/96	M 102.946			
T2/LN1 Box Body / Estate 510, T2/ LN1 Platform/Chassis 510		04/86→12/94		4cyl.		
				2299cc	70kW (95PS)	TD5397
230 G		04/92→09/95	M 102.958			
				4cyl.		
				2299cc	79kW (107PS)	TD17756
G-Class 230 GE		05/87→	M 102.979			
				4cyl.		
				2299cc	90kW (122PS)	TD2081
Coupe 230 CE		04/80→12/85	M 102.980			
Kombi Estate 230 TE		04/80→11/85		4cyl.		
Saloon 230 E		04/80→12/85		2299cc	100kW (136PS)	TD2082
G-Class 230 GE		04/82→08/92	M 102.981			
				4cyl.		
				2299cc	92kW (125PS)	TD2083
Coupe 230 CE		03/87→12/92	M 102.982			
Kombi Estate 230 TE		09/85→08/92		4cyl.		
Saloon 230 E		12/84→06/93		2299cc	97-100kW (132-136PS)	TD4656
190 2.3		09/87→09/88	M 102.985			
190 2.3 E		10/82→09/88		4cyl.		
190 E 2.3		09/86→08/93		2299cc	92-100kW (125-136PS)	TD4657
G-Class 230 GE		04/82→08/92	M 102.987			
				4cyl.		
				2299cc	90-92kW (122-125PS)	TD2089





G-Class 230 GE			04/82→06/93	M 102.989			
G-Class Cabrio 230 GE			06/90→02/93		4cyl. 2299cc	93kW (126PS)	TD2091
G-Class 230 GE			06/93→	M 102.996			
					4cyl. 2299cc	92kW (125PS)	TD11249
G-Class 230 GE			06/93→	M 102.997			
					4cyl. 2299cc	92kW (125PS)	TD17724
230 GE (460)			04/82→08/93	M 102.998			
230 GE (461)			04/92→09/95		4cyl. 2299cc	92kW (125PS)	TD17725
08-179700-00	STD	95.50	1.750		001 IF MOL P		KV1
08-179707-00	0.50mm		2.000		026 P		STD
08-179711-00	1.00mm		3.500		231 CR P		STD
→08/1989							
08-289700-00	STD	95.50	1.750		001 IF CK P		KV1
08/1989→			2.000		026 P		F12/F14
			3.500		231 CR P		KV1
190 E 2.3-16			04/84→08/88	M 102.983			48
					4cyl. 2299cc	92kW (125PS)	TD2086
190 E 2.5-16			09/88→08/93	M 102.990			
					4cyl. 2499cc	143kW (195PS)	TD2092
190 E 2.5-16			03/89→08/93	M 102.991			
					4cyl. 2499cc	143kW (195PS)	TD2093
08-182400-10	STD	95.50	1.500		005 IW P PS		KV1
			1.750		026 P		F12/F14
			3.500		231 CR P		KV1



SL 500 SL SL Coupe 450 SLC 5.0	05/80→08/89 06/78→02/80	M 117.960	V8cyl. 4973cc	138-195kW (187-265PS)	49 TD2170
S-Class 500 SE, SEL	12/79→08/85	M 117.961	V8cyl. 4973cc	138-195kW (187-265PS)	TD2172
S-Class 500 SE, SEL S-Class Coupe 500 SEC	12/79→08/85 08/80→08/85	M 117.963	V8cyl. 4973cc	138-195kW (187-265PS)	TD2174
SL 500 SL	01/86→08/89	M 117.964	V8cyl. 4973cc	138-195kW (187-265PS)	TD2175
S-Class 560 SE, SEL		M 117.967	V8cyl. 5547cc	178kW (242PS)	TD2177
S-Class 560 SE, SEL, S-Class Coupe 560 SEC	10/85→06/91	M 117.968 (KAT)	V8cyl. 5547cc	178-220kW (242-300PS)	TD2178
SL 500 SL	09/89→08/92	M 119.960	V8cyl. 4973cc	235-240kW (320-326PS)	TD2186
S-Class 500 SE, SEL S-Class S 500 S-Class Coupe SEC/CL 500	02/91→10/98 01/93→10/98 10/92→02/99	M 119.970	V8cyl. 4973cc	235kW (320PS)	TD2187
SL 500 SL 500 SL	09/92→10/01 09/89→08/92	M 119.972	V8cyl. 4973cc	235-240kW (320-326PS)	TD2189
E-Class E 500 Saloon 500 E	06/93→06/95 01/91→06/93	M 119.974	V8cyl. 4973cc	235-240kW (320-326PS)	TD2190
S-Class S 500	01/93→10/98	M 119.980	V8cyl. 4973cc	235kW (320PS)	TD19044
SL 500	09/92→10/01	M 119.982	V8cyl. 4973cc	235kW (320PS)	TD20346

08-182700-00	STD	96.50	1.750		001 IF CR P	KV1
08-182707-00	0.50mm		2.000		005 IW CR P	KV1
08-182711-00	1.00mm		3.500		231 CR P	STD



M-Class ML 350	08/02→06/05	M 112.970	V6cyl. 3724cc	173-180kW (235-245PS)	50 TD17532
S-Class S 350	09/02→08/05	M 112.972	V6cyl. 3724cc	180kW (245PS)	TD17189
SL 350	03/03→01/12	M 112.973	V6cyl. 3724cc	180kW (245PS)	TD17537
S-Class S 350 4-matic	06/03→08/05	M 112.975	V6cyl. 3724cc	180kW (245PS)	TD17190
Viano 3.7 Vito / Mixto Box 123 Vito Bus 123	06/04→ 06/04→07/08 06/04→	M 112.976	V6cyl. 3724cc	170kW (231PS)	TD18426
S-Class S 500 S-Class Coupe CL 500	10/98→08/05 03/99→03/06	M 113.960	V8cyl. 4966cc	220kW (299PS)	TD11493
SL 500	05/98→10/01	M 113.961	V8cyl. 4966cc	220kW (299PS)	TD11495
G-Class G 500, G-Class Cabrio G 500	04/98→	M 113.962	V8cyl. 4966cc	220kW (299PS)	TD12027
SL 500	10/01→01/12	M 113.963	V8cyl. 4966cc	220kW (299PS)	TD16886
M-Class ML 500 M-Class ML 500 4-matic	09/01→06/05 07/05→	M 113.964	V8cyl. 4966cc	220kW (299PS)	TD17011
M-Class ML 500	09/01→06/05	M 113.965	V8cyl. 4966cc	215kW (292PS)	TD17308
S-Class S 500 4-matic	09/02→08/05	M 113.966	V8cyl. 4966cc	225kW (306PS)	TD17191
CLS CLS 500 E-Class E 500 E-Class T-Model E 500 T	10/04→12/10 03/02→12/08 10/03→07/09	M 113.967	V8cyl. 4966cc	220kW (299PS)	TD17006
CLK 500 CLK Convertible CLK 500	06/02→05/09 02/03→03/10	M 113.968	V8cyl. 4966cc	220kW (299PS)	TD16887





E-Class E 500 4-matic	10/03→12/08	M 113.969	V8cyl.	4966cc	225kW (306PS)	TD17332
E-Class T-Model E 500 T 4-matic	10/03→07/09					
R-Class R 500 4-matic	01/06→	M 113.971	V8cyl.	4966cc	225kW (306PS)	TD18972
E-Class E 55 AMG	08/97→03/02	M 113.980	V8cyl.	5439cc	260kW (354PS)	TD9890
E-Class E 55 AMG 4-matic	03/01→03/02					
E-Class Estate E 55 T AMG	08/97→03/03					
E-Class Estate E 55 T AMG 4-matic	03/01→03/03					
CLK 55 AMG	08/99→06/02	M 113.981	V8cyl.	5439cc	255kW (347PS)	TD14889
CLK Convertible 55 AMG	01/00→03/02					
M-Class ML 55 AMG	02/00→06/05					
CLK 5.4	10/98→07/02	M 113.984	V8cyl.	5439cc	255kW (347PS)	TD15457
CLK 55 AMG	08/99→06/02					
CLK Convertible 55 AMG	01/00→03/02					

08-106300-00	STD	97.00	1.200		001 NT	ST
			1.500		026 P	GOE13
			2.000		712 CR	ST

ENGINE INDEX

Motorverzeichnis • Index de moteur • Índice de Motor
Indeks silnika • Модель двигателя • دليل المحرك



CCM

x



9

OM 314 A	Diesel	3782	4	97.00	2
OM 314.910 - 964	Diesel	3782	4	97.00	3
OM 346.910 (OM 346)	Diesel	10809	6	128.00	14
OM 346.911 (OM 346 H)	Diesel	10809	6	128.00	14
OM 346.912 (OM 346)	Diesel	10809	6	128.00	14
OM 346.913 (OM 346)	Diesel	10809	6	128.00	14
OM 346.914 (OM 346)	Diesel	10809	6	128.00	14
OM 346.915 (OM 346)	Diesel	10809	6	128.00	14
OM 346.916 (OM 346)	Diesel	10809	6	128.00	14
OM 346.917 (OM 346)	Diesel	10809	6	128.00	14
OM 346.918 (OM 346 H)	Diesel	10809	6	128.00	14
OM 346.941 (OM 346)	Diesel	10809	6	128.00	14
OM 346.942 (OM 346)	Diesel	10809	6	128.00	14
OM 346.943 (OM 346)	Diesel	10809	6	128.00	14
OM 346.944 (OM 346)	Diesel	10809	6	128.00	14
OM 346.945 (OM 346)	Diesel	10809	6	128.00	14
OM 346.946 (OM 346)	Diesel	10809	6	128.00	14
OM 346.952 (OM 346)	Diesel	10809	6	128.00	14
OM 346.953 (OM 346)	Diesel	10809	6	128.00	14
OM 352/353.902 - 999, OM 367.910	Diesel	5673	6	97.00	3
OM 352A / 353A	Diesel	5673	6	97.00	2
OM 355.910 (OM 355)	Diesel	11581	6	128.00	14
OM 355.911 (OM 355)	Diesel	11581	6	128.00	14
OM 355.912 (OM 355)	Diesel	11581	6	128.00	14
OM 355.913 (OM 355)	Diesel	11581	6	128.00	14
OM 355.914 (OM 355)	Diesel	11581	6	128.00	14
OM 355.915 (OM 355)	Diesel	11581	6	128.00	14
OM 355.916	Diesel	11581	6	128.00	14
OM 355.918 (OM 355)	Diesel	11581	6	128.00	14
OM 355.960 (OM 355)	Diesel	11581	6	128.00	14
OM 355.961 (OM 355 H)	Diesel	11581	6	128.00	14
OM 355.962 (OM 355)	Diesel	11581	6	128.00	14
OM 355.963 (OM 355)	Diesel	11581	6	128.00	14
OM 355.964 (OM 355)	Diesel	11581	6	128.00	14
OM 355.966 (OM 355)	Diesel	11581	6	128.00	14
OM 355.967 (OM 355)	Diesel	11581	6	128.00	14
OM 355.968 (OM 355)	Diesel	11581	6	128.00	14
OM 355.969 (OM 355 A)	Diesel	11581	6	128.00	14
OM 355.970 (OM 355)	Diesel	11581	6	128.00	14
OM 355.972 (OM 355 H)	Diesel	11581	6	128.00	14
OM 355.973 (OM 355 H)	Diesel	11581	6	128.00	14
OM 355.974 (OM 355)	Diesel	11581	6	128.00	14
OM 355.975 (OM 355)	Diesel	11600	6	128.00	14
OM 355.976 (OM 355)	Diesel	11581	6	128.00	14
OM 355.977 (OM 355 A)	Diesel	11581	6	128.00	14
OM 355.978 (OM 355)	Diesel	11581	6	128.00	14
OM 355.979 (OM 355)	Diesel	11581	6	128.00	14
OM 355.980 (OM 355)	Diesel	11581	6	128.00	14
OM 355.981 (OM 355)	Diesel	11581	6	128.00	14
OM 355.982 (OM 355)	Diesel	11581	6	128.00	14
OM 355.983 (OM 355)	Diesel	11581	6	128.00	14
OM 355.984 (OM 355)	Diesel	11581	6	128.00	14
OM 356.901 Euro 1 (OM 366)	Diesel	5958	6	97.50	4
OM 356.902 Euro 1 (OM 366)	Diesel	5958	6	97.50	4
OM 356.903 Euro 1 (OM 366)	Diesel	5958	6	97.50	4
OM 356.904 Euro 1 (OM 366)	Diesel	5958	6	97.50	4
OM 356.905 Euro 1 (OM 366)	Diesel	5958	6	97.50	4
OM 356.906 Euro 1 (OM 366)	Diesel	5958	6	97.50	4
OM 356.907 Euro 1 (OM 366)	Diesel	5958	6	97.50	4
OM 356.908 Euro 1 (OM 366)	Diesel	5958	6	97.50	4

Motorverzeichnis • Index de moteur • Índice de Motor
Indeks silnika • Модель двигателя • دليل المحرك

ENGINE INDEX



CCM

x



9

OM 356.909 Euro 1 (OM 366)	Diesel	5958	6	97.50	4
OM 356.910 Euro 1 (OM 366)	Diesel	5958	6	97.50	4
OM 356.911 Euro 1 (OM 366)	Diesel	5958	6	97.50	4
OM 356.913 Euro 1 (OM 366)	Diesel	5958	6	97.50	4
OM 356.914 Euro 1 (OM 366)	Diesel	5958	6	97.50	4
OM 356.915 Euro 1 (OM 366)	Diesel	5958	6	97.50	4
OM 356.916 Euro 1 (OM 366)	Diesel	5958	6	97.50	4
OM 360.911 (OM 360 H)	Diesel	8720	6	115.00	10
OM 360.914 (OM 360)	Diesel	8720	6	115.00	10
OM 360.915 (OM 360)	Diesel	8720	6	115.00	10
OM 360.916 (OM 360)	Diesel	8720	6	115.00	10
OM 360.917 (OM 360)	Diesel	8720	6	115.00	10
OM 360.918 (OM 360)	Diesel	8720	6	115.00	10
OM 360.931 (OM 360)	Diesel	8720	6	115.00	10
OM 360.933 (OM 360)	Diesel	8720	6	115.00	10
OM 360.936 (OM 360)	Diesel	8725	6	115.00	10
OM 360.937 (OM 360)	Diesel	8725	6	115.00	10
OM 360.939 (OM 360)	Diesel	8720	6	115.00	10
OM 360.940 (OM 360)	Diesel	8725	6	115.00	10
OM 360.941 (OM 360)	Diesel	8725	6	115.00	10
OM 360.942 (OM 360)	Diesel	8725	6	115.00	10
OM 360.943 (OM 360)	Diesel	8725	6	115.00	10
OM 360.944 (OM 360)	Diesel	8725	6	115.00	10
OM 360.946 (OM 360)	Diesel	8725	6	115.00	10
OM 360.948 (OM 360)	Diesel	8725	6	115.00	10
OM 360.949 (OM 360)	Diesel	8725	6	115.00	10
OM 360.980 (OM 360)	Diesel	8720	6	115.00	10
OM 360.981 (OM 360)	Diesel	8720	6	115.00	10
OM 360.984 (OM 360 A)	Diesel	8720	6	115.00	10
OM 360.985 (OM 360 A)	Diesel	8720	6	115.00	10
OM 360.986 (OM 360 A)	Diesel	8720	6	115.00	10
OM 362 LA	Diesel	5675	6	97.00	2
OM 364	Diesel	3972	4	97.50	5
OM 364 A / LA Euro 1	Diesel	3972	4	97.50	5
OM 364 LA Euro 2 (OM 354)	Diesel	3972	4	97.50	5
OM 364.918 (OM 364)	Diesel	3970	4	97.50	4
OM 364.919 (OM 364)	Diesel	3972	4	97.50	4
OM 364.920 (OM 364)	Diesel	3972	4	97.50	4
OM 364.921 Euro 1 (OM 364)	Diesel	3972	4	97.50	4
OM 366 A / Euro1 (OM 356)	Diesel	5958	6	97.50	5
OM 366 Euro 1	Diesel	5958	6	97.50	5
OM 366 LA / Euro1 Euro 1 (OM 356/357)	Diesel	5958	6	97.50	5
OM 401 A	Diesel	9600	V6	125.00	11
OM 401 LA Euro 1	Diesel	9572	V6	125.00	12
OM 401.905 (OM 401)	Diesel	9570	V6	125.00	13
OM 401.906 (OM 401)	Diesel	9570	V6	125.00	13
OM 401.907 (OM 401)	Diesel	9572	V6	125.00	13
OM 401.908 (OM 401)	Diesel	9572	V6	125.00	13
OM 401.909 (OM 401)	Diesel	9570	V6	125.00	13
OM 401.912 (OM 401)	Diesel	9572	V6	125.00	13
OM 401.913 (OM 401)	Diesel	9570	V6	125.00	13
OM 401.914 (OM 401)	Diesel	9570	V6	125.00	13
OM 401.915 (OM 401)	Diesel	9570	V6	125.00	13
OM 401.916 (OM 401)	Diesel	9570	V6	125.00	13
OM 401.917 (OM 401 A)	Diesel	9570	V6	125.00	13
OM 401.918 (OM 401)	Diesel	9570	V6	125.00	13
OM 401.919 (OM 401)	Diesel	9570	V6	125.00	13
OM 401.921 (OM 401)	Diesel	9570	V6	125.00	13
OM 401.922 (OM 401)	Diesel	9570	V6	125.00	13
OM 401.923 (OM 401)	Diesel	9570	V6	125.00	13

ENGINE INDEX

Motorverzeichnis • Index de moteur • Índice de Motor
Indeks silnika • Модель двигателя • دليل المحرك



CCM



9

OM 401.925 (OM 401)	Diesel	9570	V6	125.00	13
OM 401.926 (OM 401)	Diesel	9570	V6	125.00	13
OM 401.927 (OM 401)	Diesel	9570	V6	125.00	13
OM 401.928 (OM 401)	Diesel	9570	V6	125.00	13
OM 401.970 (OM 401 LA)	Diesel	9600	V6	125.00	12
OM 401.972 (OM 401 LA)	Diesel	9572	V6	125.00	12
OM 401.973 (OM 401 LA)	Diesel	9572	V6	125.00	12
OM 401.974 Euro 1 (OM 401 LA)	Diesel	9572	V6	125.00	12
OM 401.975 Euro 1 (OM 401 LA)	Diesel	9572	V6	125.00	12
OM 401.977 Euro 1 (OM 401 LA)	Diesel	9572	V6	125.00	12
OM 401.978 Euro 1 (OM 401 LA)	Diesel	9572	V6	125.00	12
OM 401.979 Euro 1 (OM 401 LA)	Diesel	9572	V6	125.00	12
OM 401.980 Euro 1 (OM 401 LA)	Diesel	9572	V6	125.00	12
OM 401.981 Euro 1 (OM 401 LA)	Diesel	9572	V6	125.00	12
OM 401.982 Euro 1 (OM 401 LA)	Diesel	9572	V6	125.00	12
OM 401.984 (OM 401 LA)	Diesel	9572	V6	125.00	12
OM 401.985 (OM 401 LA)	Diesel	9600	V6	125.00	12
OM 401.986 (OM 401 LA)	Diesel	9572	V6	125.00	12
OM 401.987 (OM 401 LA)	Diesel	9572	V6	125.00	12
OM 401.989 (OM 401 LA)	Diesel	9572	V6	125.00	12
OM 401.990 (OM 401 LA)	Diesel	9572	V6	125.00	12
OM 401.991 (OM 401 LA)	Diesel	9600	V6	125.00	12
OM 401.992 (OM 401 LA)	Diesel	9572	V6	125.00	12
OM 401.993 (OM 401 LA)	Diesel	9572	V6	125.00	12
OM 401.994 (OM 401 LA)	Diesel	9600	V6	125.00	12
OM 402 LA Euro 1	Diesel	12763	V8	125.00	12
OM 402.905 (OM 402)	Diesel	12800	V8	125.00	13
OM 402.906 (OM 402)	Diesel	12800	V8	125.00	13
OM 402.907 (OM 402)	Diesel	12800	V8	125.00	13
OM 402.910 (OM 402)	Diesel	12800	V8	125.00	13
OM 402.912 (OM 402)	Diesel	12800	V8	125.00	13
OM 402.913 (OM 402)	Diesel	12760	V8	125.00	13
OM 402.914 (OM 402)	Diesel	12800	V8	125.00	13
OM 402.916 (OM 402)	Diesel	12800	V8	125.00	13
OM 402.917 (OM 402)	Diesel	12760	V8	125.00	13
OM 402.919 (OM 402)	Diesel	12800	V8	125.00	13
OM 402.921 (OM 402)	Diesel	12760	V8	125.00	13
OM 402.923 (OM 402)	Diesel	12800	V8	125.00	13
OM 402.924 (OM 402)	Diesel	12800	V8	125.00	13
OM 402.925 (OM 402)	Diesel	12760	V8	125.00	13
OM 402.926 (OM 402)	Diesel	12800	V8	125.00	13
OM 402.927 (OM 402)	Diesel	12800	V8	125.00	13
OM 402.928 (OM 402)	Diesel	12800	V8	125.00	13
OM 402.970 Euro 1 (OM 402 LA)	Diesel	12763	V8	125.00	12
OM 402.971 Euro 1 (OM 402 LA)	Diesel	12763	V8	125.00	12
OM 402.972 (OM 402 LA)	Diesel	12763	V8	125.00	12
OM 402.973 Euro 1 (OM 402 LA)	Diesel	12763	V8	125.00	12
OM 402.974 Euro 1 (OM 402 LA)	Diesel	12760	V8	125.00	12
OM 402.975 Euro 1 (OM 402 LA)	Diesel	12763	V8	125.00	12
OM 402.977 Euro 1 (OM 402 LA)	Diesel	12763	V8	125.00	12
OM 402.978 Euro 1 (OM 402 LA)	Diesel	12763	V8	125.00	12
OM 402.982 Euro 1 (OM 402 LA)	Diesel	12763	V8	125.00	12
OM 402.983 Euro 1 (OM 402 LA)	Diesel	12763	V8	125.00	12
OM 402.984 Euro 1 (OM 402 LA)	Diesel	12763	V8	125.00	12
OM 402.985 Euro 1 (OM 402 LA)	Diesel	12763	V8	125.00	12
OM 402.986 Euro 1 (OM 402 LA)	Diesel	12763	V8	125.00	12
OM 402.987 Euro 1 (OM 402 LA)	Diesel	12763	V8	125.00	12
OM 402.989 Euro 1 (OM 402 LA)	Diesel	12763	V8	125.00	12
OM 402.990 Euro 1 (OM 402 LA)	Diesel	12763	V8	125.00	12
OM 402.996 Euro 1 (OM 402 LA)	Diesel	12763	V8	125.00	12

Motorverzeichnis • Index de moteur • Índice de Motor
Indeks silnika • Модель двигателя • دليل المحرك

ENGINE INDEX



CCM

x



9

OM 403.915 (OM 403)	Diesel	15900	V10	125.00	13
OM 403.916 (OM 403)	Diesel	15900	V10	125.00	13
OM 403.917 (OM 403)	Diesel	15950	V10	125.00	13
OM 403.918 (OM 403)	Diesel	15900	V10	125.00	13
OM 403.919 (OM 403)	Diesel	15950	V10	125.00	13
OM 403.930 (OM 403)	Diesel	15950	V10	125.00	13
OM 403.931 (OM 403)	Diesel	15900	V10	125.00	13
OM 403.932 (OM 403)	Diesel	15900	V10	125.00	13
OM 403.934 (OM 403)	Diesel	15950	V10	125.00	13
OM 403.935 (OM 403)	Diesel	15900	V10	125.00	13
OM 404	Diesel	20911	V12	125.00	13
OM 404 A	Diesel	20911	V12	125.00	11
OM 407 / H	Diesel	11413	6	125.00	13
OM 407 A	Diesel	11413	6	125.00	11
OM 407 HA	Diesel	11413	6	125.00	11
OM 407.905 (OM 407 H)	Diesel	11000	6	125.00	13
OM 407.907 (OM 407 H)	Diesel	11045	6	125.00	13
OM 407.908 (OM 407 H)	Diesel	11000	6	125.00	13
OM 407.909 (OM 407 H)	Diesel	11000	6	125.00	13
OM 407.910 (OM 407 H)	Diesel	11000	6	125.00	13
OM 407.911 (OM 407 H)	Diesel	11000	6	125.00	13
OM 407.913 (OM 407 H)	Diesel	11400	6	125.00	13
OM 407.914 (OM 407 H)	Diesel	11400	6	125.00	13
OM 407.915 (OM 407 H)	Diesel	11400	6	125.00	13
OM 407.916 (OM 407 H)	Diesel	11400	6	125.00	13
OM 407.917 (OM 407 H)	Diesel	11400	6	125.00	13
OM 407.918 (OM 407 H)	Diesel	11400	6	125.00	13
OM 407.919 (OM 407 H)	Diesel	11400	6	125.00	13
OM 407.920 (OM 407 H)	Diesel	11412	6	125.00	13
OM 407.955	Diesel	11413	6	125.00	11
OM 409	Diesel	9204	5	125.00	13
OM 409.906 (OM 409)	Diesel	9204	5	125.00	13
OM 409.907 (OM 409)	Diesel	9204	5	125.00	13
OM 409.908 (OM 409)	Diesel	9204	5	125.00	13
OM 421 A	Diesel	10964	V6	128.00	15
OM 421 LA	Diesel	10964	V6	128.00	15
OM 421.905 (OM 421)	Diesel	10964	V6	128.00	16
OM 421.906 (OM 421)	Diesel	10900	V6	128.00	16
OM 421.907 (OM 421)	Diesel	10964	V6	128.00	16
OM 421.908 (OM 421)	Diesel	10964	V6	128.00	16
OM 421.909 (OM 421)	Diesel	10964	V6	128.00	16
OM 421.910 (OM 421)	Diesel	10964	V6	128.00	16
OM 422 A	Diesel	14618	V8	128.00	15
OM 422 LA	Diesel	14618	V8	128.00	15
OM 422.905 (OM 422)	Diesel	14618	V8	128.00	16
OM 422.906 (OM 422)	Diesel	14618	V8	128.00	16
OM 422.907 (OM 422)	Diesel	14618	V8	128.00	16
OM 422.908 (OM 422)	Diesel	14600	V8	128.00	16
OM 422.909 (OM 422)	Diesel	14618	V8	128.00	16
OM 422.910 (OM 422)	Diesel	14618	V8	128.00	16
OM 422.911 (OM 422)	Diesel	14618	V8	128.00	16
OM 422.912 (OM 422)	Diesel	14618	V8	128.00	16
OM 422.913 (OM 422)	Diesel	14618	V8	128.00	16
OM 422.914 (OM 422)	Diesel	14600	V8	128.00	16
OM 422.915 (OM 422)	Diesel	14618	V8	128.00	16
OM 422.916 (OM 422)	Diesel	14618	V8	128.00	16
OM 422.917 (OM 422)	Diesel	14618	V8	128.00	16
OM 422.918 (OM 422)	Diesel	14618	V8	128.00	16
OM 422.919 (OM 422)	Diesel	14618	V8	128.00	16
OM 422.920 (OM 422)	Diesel	14618	V8	128.00	16

ENGINE INDEX

Motorverzeichnis • Index de moteur • Índice de Motor
Indeks silnika • Модель двигателя • دليل المحرك



CCM



9

OM 422.921 (OM 422)	Diesel	14618	V8	128.00	16
OM 422.922 (OM 422)	Diesel	14618	V8	128.00	16
OM 422.923 (OM 422)	Diesel	14618	V8	128.00	16
OM 423 A	Diesel	18273	V10	128.00	15
OM 423 LA	Diesel	18273	V10	128.00	15
OM 423.905 (OM 423)	Diesel	18300	V10	128.00	16
OM 423.906 (OM 423)	Diesel	18273	V10	128.00	16
OM 423.907 (OM 423)	Diesel	18273	V10	128.00	16
OM 423.908 (OM 423)	Diesel	18300	V10	128.00	16
OM 423.909 (OM 423)	Diesel	18273	V10	128.00	16
OM 424 A	Diesel	21927	V12	128.00	15
OM 424 LA	Diesel	21927	V12	128.00	15
OM 424.900 (OM 424)	Diesel	21930	V12	128.00	16
OM 427	Diesel	11967	6	128.00	15
OM 427 A	Diesel	11967	6	128.00	15
OM 427 H	Diesel	11967	6	128.00	15
OM 427 HA	Diesel	11967	6	128.00	15
OM 427 LA	Diesel	11967	6	128.00	15
OM 440.905 Euro 1 (OM 442)	Diesel	15080	V8	130.00	22
OM 440.906 Euro 1 (OM 442)	Diesel	15080	V8	130.00	22
OM 440.907 Euro 1 (OM 442)	Diesel	15080	V8	130.00	22
OM 440.908 Euro 1 (OM 442)	Diesel	15080	V8	130.00	22
OM 440.909 (OM 442)	Diesel	15080	V8	130.00	22
OM 440.910 Euro 1 (OM 442)	Diesel	15080	V8	130.00	22
OM 440.911 Euro 1 (OM 442)	Diesel	15080	V8	130.00	22
OM 440.912 Euro 1 (OM 442)	Diesel	15080	V8	130.00	22
OM 441	Diesel	10964	6	128.00	17
OM 441 / Euro 1	Diesel	11309	6	130.00	22
OM 441 A	Diesel	10964	V6	128.00	15
OM 441 LA / Euro 1	Diesel	10964	V6	128.00	15
OM 441 LA Euro 2	Diesel	10964	V6	128.00	15
OM 441.905 (OM 441)	Diesel	10964	V6	130.00	22
OM 441.906 (OM 441)	Diesel	10964	V6	130.00	22
OM 441.907 (OM 441)	Diesel	10964	V6	130.00	22
OM 441.908 (OM 441)	Diesel	10964	V6	130.00	22
OM 441.909 (OM 441)	Diesel	10964	V6	130.00	22
OM 441.911 (OM 441)	Diesel	10964	V6	130.00	22
OM 441.912 (OM 441)	Diesel	11309	V6	130.00	22
OM 441.913 (OM 441)	Diesel	10964	V6	130.00	22
OM 441.914 (OM 441)	Diesel	11309	V6	130.00	22
OM 441.915 (OM 441)	Diesel	10964	V6	130.00	22
OM 441.916 (OM 441)	Diesel	11309	V6	130.00	22
OM 441.917 (OM 441)	Diesel	10964	V6	130.00	22
OM 441.918 (OM 441)	Diesel	11309	V6	130.00	22
OM 441.919 (OM 441)	Diesel	11309	V6	130.00	22
OM 441.920 (OM 441)	Diesel	11309	V6	130.00	22
OM 441.921 (OM 441)	Diesel	11300	V6	130.00	22
OM 441.922 Euro 1 (OM 441)	Diesel	11300	V6	130.00	22
OM 441.923 (OM 441)	Diesel	10964	V6	130.00	22
OM 441.924 (OM 441)	Diesel	11309	V6	130.00	22
OM 441.925 (OM 441)	Diesel	10964	V6	130.00	22
OM 441.926 (OM 441)	Diesel	10964	V6	130.00	22
OM 441.927 (OM 441)	Diesel	10964	V6	130.00	22
OM 441.932 (OM 441)	Diesel	11309	V6	130.00	22
OM 441.933 Euro 1 (OM 441)	Diesel	11309	V6	130.00	22
OM 442	Diesel	15080	V8	130.00	23
OM 442 A	Diesel	14618	V8	128.00	15
OM 442 A Euro 1	Diesel	14618	V8	128.00	15
OM 442 Euro 1	Diesel	15080	V8	130.00	22
OM 442 LA / Euro 1	Diesel	14618	V8	128.00	15

Motorverzeichnis • Index de moteur • Índice de Motor
Indeks silnika • Модель двигателя • دليل المحرك

ENGINE INDEX



CCM

x



9

OM 442 LA Euro 2	Diesel	14618	V8	128.00	15
OM 442.905 (OM 442)	Diesel	15080	V8	130.00	22
OM 442.906 (OM 442)	Diesel	15080	V8	130.00	22
OM 442.907 (OM 442)	Diesel	15080	V8	130.00	22
OM 442.908 (OM 442)	Diesel	15080	V8	130.00	22
OM 442.909 (OM 442)	Diesel	15080	V8	130.00	22
OM 442.910 (OM 442)	Diesel	15080	V8	130.00	22
OM 442.911 (OM 442)	Diesel	15080	V8	130.00	22
OM 442.913 (OM 442)	Diesel	15080	V8	130.00	22
OM 442.914 (OM 442)	Diesel	15080	V8	130.00	22
OM 442.915 (OM 442)	Diesel	15078	V8	130.00	22
OM 442.916 (OM 442)	Diesel	15078	V8	130.00	22
OM 442.917 (OM 442)	Diesel	15080	V8	130.00	22
OM 442.918 (OM 442)	Diesel	15080	V8	130.00	22
OM 442.919 (OM 442)	Diesel	15080	V8	130.00	22
OM 442.920 (OM 442)	Diesel	15080	V8	130.00	22
OM 442.921 (OM 442)	Diesel	15080	V8	130.00	22
OM 442.922 (OM 442)	Diesel	15080	V8	130.00	22
OM 442.923 (OM 442)	Diesel	15080	V8	130.00	22
OM 442.924 (OM 442)	Diesel	15080	V8	130.00	22
OM 442.925 (OM 442)	Diesel	15080	V8	130.00	22
OM 442.926 (OM 442)	Diesel	15080	V8	130.00	22
OM 442.927 (OM 442)	Diesel	15078	V8	130.00	22
OM 442.928 (OM 442)	Diesel	15078	V8	130.00	22
OM 442.929 (OM 442)	Diesel	15080	V8	130.00	22
OM 442.930 (OM 442)	Diesel	15100	V8	130.00	22
OM 442.931 (OM 442)	Diesel	15100	V8	130.00	22
OM 442.932 (OM 442)	Diesel	15080	V8	130.00	22
OM 442.933 (OM 442)	Diesel	15080	V8	130.00	22
OM 442.934 (OM 442)	Diesel	15080	V8	130.00	22
OM 442.935 (OM 442)	Diesel	15080	V8	130.00	22
OM 442.939 (OM 442)	Diesel	15080	V8	130.00	22
OM 443	Diesel	18848	V10	130.00	23
OM 443 A	Diesel	18273	V10	128.00	15
OM 443 LA	Diesel	18270	V10	128.00	15
OM 443.905 (OM 443)	Diesel	18848	V10	130.00	22
OM 444	Diesel	22618	V12	130.00	24
OM 444 A	Diesel	21927	V12	128.00	15
OM 444 LA	Diesel	21927	V12	128.00	15
OM 447	Diesel	11967	6	128.00	15
OM 447 A	Diesel	11967	6	128.00	15
OM 447 H	Diesel	11967	6	128.00	15
OM 447 HA / Euro 1	Diesel	11967	6	128.00	15
OM 447 HLA Euro 1	Diesel	11967	6	128.00	15
OM 447 HLA Euro 2	Diesel	11970	6	128.00	15
OM 447 LA	Diesel	11967	6	128.00	15
OM 449 A	Diesel	9975	5	128.00	15
OM 449 LA	Diesel	9975	5	128.00	15
OM 457.910 Euro 5 (OM 457 LA)	Diesel	11967	6	128.00	18
OM 457.914 Euro 3 (OM 457 LA)	Diesel	11967	6	128.00	19
OM 457.915 Euro 3 (OM 457 LA)	Diesel	11967	6	128.00	19
OM 457.916 Euro 3 (OM 457 LA)	Diesel	11967	6	128.00	19
OM 457.917 (OM 457 LA)	Diesel	11967	6	128.00	20
OM 457.918 Euro 3 (OM 457 LA)	Diesel	11967	6	128.00	19
OM 457.919 Euro 3 (OM 457 LA)	Diesel	11967	6	128.00	19
OM 457.920 Euro 3 (OM 457 LA)	Diesel	11967	6	128.00	19
OM 457.922 Euro 3 (OM 457 LA)	Diesel	11967	6	128.00	19
OM 457.923 Euro 3 (OM 457 LA)	Diesel	11967	6	128.00	19
OM 457.924 Euro 3 (OM 457 LA)	Diesel	11967	6	128.00	19
OM 457.925 Euro 3 (OM 457 LA)	Diesel	11967	6	128.00	19

ENGINE INDEX

Motorverzeichnis • Index de moteur • Índice de Motor
Indeks silnika • Модель двигателя • دليل المحرك



CCM



9

OM 457.926 Euro 3 (OM 457 LA)	Diesel	11967	6	128.00	19
OM 457.927 Euro 3 (OM 457 LA)	Diesel	11967	6	128.00	19
OM 457.928 Euro 3 (OM 457 LA)	Diesel	11967	6	128.00	19
OM 457.929 Euro 3 (OM 457 LA)	Diesel	11967	6	128.00	19
OM 457.931 Euro 3 (OM 457 LA)	Diesel	11967	6	128.00	19
OM 457.932 Euro 3 (OM 457 LA)	Diesel	11967	6	128.00	19
OM 457.933 Euro 2 (OM 457 HLA)	Diesel	11967	6	128.00	20
OM 457.934 Euro 2 (OM 457 HLA)	Diesel	11967	6	128.00	20
OM 457.935 Euro 2 (OM 457 HLA)	Diesel	11967	6	128.00	20
OM 457.937 Euro 2 (OM 457 LA)	Diesel	11967	6	128.00	20
OM 457.938 Euro 2 (OM 457 HLA)	Diesel	11967	6	128.00	20
OM 457.939 Euro 2 (OM 457 LA)	Diesel	11967	6	128.00	20
OM 457.940 Euro 2 (OM 457 LA)	Diesel	11967	6	128.00	20
OM 457.941 Euro 2 (OM 457 HLA)	Diesel	11967	6	128.00	20
OM 457.942 Euro 2 (OM 457 HLA)	Diesel	11967	6	128.00	20
OM 457.943 Euro 2 (OM 457 LA)	Diesel	11967	6	128.00	20
OM 457.944 Euro 2 (OM 457 LA)	Diesel	11967	6	128.00	20
OM 457.945 Euro 2 (OM 457 LA)	Diesel	11967	6	128.00	20
OM 457.946 Euro 2 (OM 457 LA)	Diesel	11967	6	128.00	20
OM 457.947 Euro 2 (OM 457 LA)	Diesel	11967	6	128.00	20
OM 457.948 Euro 3 (OM 457 LA)	Diesel	11967	6	128.00	19
OM 457.949 Euro 2 (OM 457 LA)	Diesel	11967	6	128.00	20
OM 457.950 Euro 4 (OM 457 HLA)	Diesel	11967	6	128.00	18
OM 457.951 Euro 4 (OM 457 LA)	Diesel	11967	6	128.00	18
OM 457.952 Euro 4 (OM 457 HLA)	Diesel	11967	6	128.00	18
OM 457.953 Euro 4 (OM 457 LA)	Diesel	11967	6	128.00	18
OM 457.954 Euro 4 (OM 457 HLA)	Diesel	11967	6	128.00	18
OM 457.955 Euro 3 (OM 457 LA)	Diesel	11967	6	128.00	19
OM 457.956 Euro 3 (OM 457 LA)	Diesel	11967	6	128.00	19
OM 457.957 Euro 3 (OM 457 LA)	Diesel	11967	6	128.00	19
OM 457.958 (OM 457 LA)	Diesel	11967	6	128.00	20
OM 457.959 Euro 4 (OM 457 HLA)	Diesel	11967	6	128.00	18
OM 457.960 Euro 2 (OM 457 LA)	Diesel	11967	6	128.00	20
OM 457.961 Euro 3 (OM 457 LA)	Diesel	11967	6	128.00	19
OM 457.962 Euro 3 (OM 457 LA)	Diesel	11967	6	128.00	19
OM 457.964 Euro 4 (OM 457 HLA)	Diesel	11967	6	128.00	18
OM 457.965 Euro 4 (OM 457 HLA)	Diesel	11967	6	128.00	18
OM 457.966 Euro 4 (OM 457 HLA)	Diesel	11967	6	128.00	18
OM 457.973 Euro 4 (OM 457 HLA)	Diesel	11967	6	128.00	18
OM 457.980 Euro 2 (OM 457 LA)	Diesel	11967	6	128.00	18
OM 457.981 Euro 3 (OM 457 LA)	Diesel	11967	6	128.00	18
OM 458.980 Euro 3 (OM 457 LA)	Diesel	11967	6	128.00	19
OM 460 HLA	Diesel	12820	6	128.00	21
OM 460.950 Euro 3 (OM 460 HLA)	Diesel	12816	6	128.00	21
OM 460.951 Euro 3 (OM 460 HLA)	Diesel	12816	6	128.00	21
OM 471.900 (OM 471 LA)	Diesel	12800	6	132.00	29
OM 471.909 Euro 5 (OM 471 LA)	Diesel	12809	6	132.00	29
OM 521.940 Euro 2 (OM 501 LA)	Diesel	11946	V6	130.00	25
OM 521.950 Euro 2 (OM 501 LA)	Diesel	11946	V6	130.00	25
OM 522 LA Euro 2	Diesel	15928	V8	130.00	26
OM 522.940 Euro 2 (OM 502 LA)	Diesel	15928	V8	130.00	25
OM 522.941 Euro 2 (OM 502 LA)	Diesel	15928	V8	130.00	25
OM 522.942 Euro 2 (OM 502 LA)	Diesel	15928	V8	130.00	25
OM 522.943 Euro 2 (OM 502 LA)	Diesel	15928	V8	130.00	25
OM 522.950 Euro 2 (OM 502 LA)	Diesel	15928	V8	130.00	25
OM 541.920 Euro 2 (OM 501 LA)	Diesel	11946	V6	130.00	25
OM 541.921 Euro 2 (OM 501 LA)	Diesel	11946	V6	130.00	25
OM 541.922 Euro 2 (OM 501 LA)	Diesel	11946	V6	130.00	25
OM 541.923 Euro 2 (OM 501 LA)	Diesel	11946	V6	130.00	25
OM 541.924 Euro 2 (OM 501 LA)	Diesel	11946	V6	130.00	25

Motorverzeichnis • Index de moteur • Índice de Motor
Indeks silnika • Модель двигателя • دليل المحرك

ENGINE INDEX



CCM



9

OM 541.925 Euro 2 (OM 501 LA)	Diesel	11946	V6	130.00	25
OM 541.926 Euro 2 (OM 501 LA)	Diesel	11946	V6	130.00	25
OM 541.927 Euro 2 (OM 501 LA)	Diesel	11946	V6	130.00	25
OM 541.928 Euro 2 (OM 501 LA)	Diesel	11946	V6	130.00	25
OM 541.942 Euro 3 (OM 501 LA)	Diesel	11946	V6	130.00	27
OM 541.943 Euro 3 (OM 501 LA)	Diesel	11946	V6	130.00	27
OM 541.944 Euro 3 (OM 501 LA)	Diesel	11946	V6	130.00	27
OM 541.945 Euro 3 (OM 501 LA)	Diesel	11946	V6	130.00	27
OM 541.946 Euro 3 (OM 501 LA)	Diesel	11946	V6	130.00	27
OM 541.947 Euro 3 (OM 501 LA)	Diesel	11946	V6	130.00	27
OM 541.948 Euro 3 (OM 501 LA)	Diesel	11946	V6	130.00	27
OM 541.949 Euro 3 (OM 501 LA)	Diesel	11946	V6	130.00	27
OM 541.950 Euro 3 (OM 501 LA)	Diesel	11946	V6	130.00	27
OM 541.970 Euro 4 (OM 501 LA)	Diesel	11946	V6	130.00	28
OM 541.972 Euro 4 (OM 501 LA)	Diesel	11946	V6	130.00	28
OM 541.973 Euro 4 (OM 501 LA)	Diesel	11946	V6	130.00	28
OM 541.974 Euro 4 (OM 501 LA)	Diesel	11946	V6	130.00	28
OM 541.975 Euro 4 (OM 501 LA)	Diesel	11946	V6	130.00	28
OM 541.976 Euro 4 (OM 501 LA)	Diesel	11946	V6	130.00	28
OM 541.977 Euro 4 (OM 501 LA)	Diesel	11946	V6	130.00	28
OM 541.978 Euro 3 (OM 501 LA)	Diesel	11946	V6	130.00	27
OM 541.980 Euro 3 (OM 501 LA)	Diesel	11946	V6	130.00	27
OM 541.981 Euro 3 (OM 501 LA)	Diesel	11946	V6	130.00	27
OM 542.925 Euro 2 (OM 502 LA)	Diesel	15928	V8	130.00	25
OM 542.940 Euro 3 (OM 502 LA)	Diesel	15928	V8	130.00	27
OM 542.941 Euro 3 (OM 502 LA)	Diesel	15928	V8	130.00	27
OM 542.942 Euro 3 (OM 502 LA)	Diesel	15928	V8	130.00	27
OM 542.943 Euro 3 (OM 502 LA)	Diesel	15928	V8	130.00	27
OM 542.944 Euro 3 (OM 502 LA)	Diesel	15928	V8	130.00	27
OM 542.945 Euro 3 (OM 502 LA)	Diesel	15928	V8	130.00	27
OM 542.948 Euro 3 (OM 502 LA)	Diesel	15928	V8	130.00	27
OM 542.956 Euro 3 (OM 502 LA)	Diesel	15928	V8	130.00	27
OM 542.957 Euro 3 (OM 502 LA)	Diesel	15928	V8	130.00	27
OM 542.960 Euro 5	Diesel	15928	V8	130.00	28
OM 542.961 Euro 5	Diesel	15928	V8	130.00	28
OM 542.962 Euro 5 (OM 502 LA)	Diesel	15928	V8	130.00	28
OM 542.963 Euro 5 (OM 502 LA)	Diesel	15928	V8	130.00	28
OM 542.964 Euro 5	Diesel	15928	V8	130.00	28
OM 904 LA Euro 2	Diesel	4249	4	102.00	6
OM 904 LA Euro 3/4	Diesel	4249	4	102.00	7
OM 906 LA Euro 2	Diesel	6374	6	102.00	6
OM 906 LA Euro 3/4	Diesel	6374	6	102.00	7
OM 924 LA Euro 3/4	Diesel	4801	4	106.00	8
OM 924.911 Euro 2 (OM 924 LA)	Diesel	4801	4	106.00	9
OM 926 LA Euro 3/4	Diesel	7201	6	106.00	8
OM 926.911 Euro 2 (OM 926 LA)	Diesel	7201	6	106.00	9
OM 926.912 Euro 2 (OM 926 LA)	Diesel	7201	6	106.00	9
OM 926.914 Euro 2 (OM 926 LA)	Diesel	7201	6	106.00	9
OM 941.910 Euro 2 (OM 501 LA)	Diesel	11946	V6	130.00	25
OM 941.920 Euro 2 (OM 501 LA)	Diesel	11946	V6	130.00	25
OM 941.921 Euro 2 (OM 501 LA)	Diesel	11946	V6	130.00	25
OM 941.929 Euro 2 (OM 501 LA)	Diesel	11946	V6	130.00	25
OM 941.930 Euro 2 (OM 501 LA)	Diesel	11946	V6	130.00	25
OM 941.940 Euro 2 (OM 501 LA)	Diesel	11946	V6	130.00	25
OM 941.960 Euro 2 (OM 501 LA)	Diesel	11946	V6	130.00	25
OM 941.970 Euro 2 (OM 501 LA)	Diesel	11946	V6	130.00	25
OM 941.980 Euro 2 (OM 501 LA)	Diesel	11946	V6	130.00	25
OM 941.981 Euro 2 (OM 501 LA)	Diesel	11946	V6	130.00	25
OM 941.990 Euro 2 (OM 501 LA)	Diesel	11946	V6	130.00	25
OM 942.900 Euro 2 (OM 502 LA)	Diesel	15928	V8	130.00	25

ENGINE INDEX

Motorverzeichnis • Index de moteur • Índice de Motor
Indeks silnika • Модель двигателя • دليل المحرك



CCM

x



9

OM 942.910 Euro 2 (OM 502 LA)	Diesel	15928	V8	130.00	25
OM 942.911 Euro 2 (OM 502 LA)	Diesel	15928	V8	130.00	25
OM 942.912 Euro 2 (OM 502 LA)	Diesel	15928	V8	130.00	25
OM 942.925 Euro 2 (OM 502 LA)	Diesel	15928	V8	130.00	25
OM 942.930 Euro 2 (OM 502 LA)	Diesel	15928	V8	130.00	25
OM 942.960 Euro 2 (OM 502 LA)	Diesel	15928	V8	130.00	25
OM 942.967 Euro 2 (OM 502 LA)	Diesel	15928	V8	130.00	25
OM 942.970 Euro 2 (OM 502 LA)	Diesel	15928	V8	130.00	25
OM 942.980 Euro 2 (OM 502 LA)	Diesel	15928	V8	130.00	25
OM 942.990 Euro 2 (OM 502 LA)	Diesel	15928	V8	130.00	25
OM360 / OM360 H	Diesel	8725	6	115.00	10
OM457/904/906 Compressor (MB OM457/904/906, DAF 825/1160)			1	85.00	1



1

OM457/904/906 Compressor 1cyl.
(MB OM457/904/906, DAF 825/1160)

FM15572

08-741200-00	STD	85.00	2.000		026 P	STD	
08-741204-00	0.20mm						
08-741205-00	0.25mm			2.000		026 P	STD
08-741207-00	0.50mm			4.000		032 P	STD

[R67810]

2

OM 314 A 4cyl. 3782cc 63kW (86PS) Diesel Turbo FM4239

OM 352A / 353A 6cyl. 5673cc 92-124kW (125-168PS) Diesel Turbo FM1150

OM 362 LA 6cyl. 5675cc 141kW (192PS) Diesel Turbo Intercooled FM4243

08-174300-10 ¹	STD	97.00	3.000		008 CR P	KV1	
08-174305-10	0.25mm						
08-174307-10	0.50mm			3.000		005 P	STD
08-174309-10	0.75mm						
08-174311-10	1.00mm			3.000		026 P	STD
08-174314-10	1.50mm			5.500		231 CR P	STD
			5.500		036 P	STD	
08-174300-70 ¹	STD	97.00	3.000		008 CR	KV1	
08-174305-70	0.25mm						
08-174307-70	0.50mm			3.000		005	STD
08-174311-70	1.00mm			3.000		026	STD
				5.500		231 CR	STD
				5.500		036	STD
08-178200-00	STD	97.00	2.500		008 MOL P	KV1	
08-178207-00	0.50mm						
08-178211-00	1.00mm			2.500		005 IW MO P	STD
			4.000		231 CR P	STD	

[R35990]

[R45980]

¹ For 5 ring piston

¹ Für den Kolben mit 5 Ringen

¹ Pour le piston de 5 anneaux

¹ Para el pistón de 5 anillos



3

OM 314.910 - 964		4cyl.	3782cc	34-63kW (47-85PS)	Diesel	FM1148	
OM 352/353.902 - 999, OM 367.910		6cyl.	5673cc	52-96kW (70-131PS)	Diesel	FM1149	
08-174300-10 ¹	STD	97.00	3.000		008 CR P	KV1	
08-174305-10	0.25mm		3.000		005 P	STD	
08-174307-10	0.50mm		3.000		026 P	STD	
08-174309-10	0.75mm		5.500		231 CR P	STD	
08-174311-10	1.00mm		5.500		036 P	STD	
08-174314-10	1.50mm						
[R35990]							
08-174300-70 ¹	STD	97.00	3.000		008 CR	KV1	
08-174305-70	0.25mm		3.000		005	STD	
08-174307-70	0.50mm		3.000		026	STD	
08-174311-70	1.00mm		5.500		231 CR	STD	
			5.500		036	STD	
08-178800-00	STD	97.00	3.000		008 CR P	KV1	
08-178807-00	0.50mm		3.000		005 IF P	STD	
08-178811-00	1.00mm		3.000		026 P	STD	
[R45970]				5.500		231 CR P	STD

¹ For 5 ring piston

¹ Für den Kolben mit 5 Ringen

¹ Pour le piston de 5 anneaux

¹ Para el pistón de 5 anillos

4

OM 356.901 Euro 1 (OM 366)	6cyl.	5958cc	95kW (129PS)	Diesel	TD5704
OM 356.902 Euro 1 (OM 366)	6cyl.	5958cc	95kW (129PS)	Diesel	TD8064
OM 356.903 Euro 1 (OM 366)	6cyl.	5958cc	95kW (129PS)	Diesel	TD8093
OM 356.904 Euro 1 (OM 366)	6cyl.	5958cc	95kW (129PS)	Diesel	TD8098
OM 356.905 Euro 1 (OM 366)	6cyl.	5958cc	95kW (129PS)	Diesel	TD8062
OM 356.906 Euro 1 (OM 366)	6cyl.	5958cc	95kW (129PS)	Diesel	TD8067
OM 356.907 Euro 1 (OM 366)	6cyl.	5958cc	95kW (129PS)	Diesel	TD8099
OM 356.908 Euro 1 (OM 366)	6cyl.	5958cc	95kW (129PS)	Diesel	TD8134
OM 356.909 Euro 1 (OM 366)	6cyl.	5958cc	95kW (129PS)	Diesel	TD8133
OM 356.910 Euro 1 (OM 366)	6cyl.	5958cc	95kW (129PS)	Diesel	TD8132
OM 356.911 Euro 1 (OM 366)	6cyl.	5958cc	95kW (129PS)	Diesel	TD6039
OM 356.913 Euro 1 (OM 366)	6cyl.	5958cc	100kW (136PS)	Diesel	TD16810
OM 356.914 Euro 1 (OM 366)	6cyl.	5958cc	75kW (102PS)	Diesel	TD7994
OM 356.915 Euro 1 (OM 366)	6cyl.	5958cc	97kW (132PS)	Diesel	TD16811
OM 356.916 Euro 1 (OM 366)	6cyl.	5958cc	97kW (132PS)	Diesel	TD17096
OM 364.918 (OM 364)	4cyl.	3970cc	63kW (86PS)	Diesel	TD8053
OM 364.919 (OM 364)	4cyl.	3972cc	63kW (86PS)	Diesel	TD5692





OM 364.920 (OM 364)		4cyl.	3972cc	63kW (86PS)	Diesel	TD8082
OM 364.921 Euro 1 (OM 364)		4cyl.	3972cc	63kW (86PS)	Diesel	TD6029
08-288800-00	STD	97.50	2.500		001 MOL P	KV1
08-288807-00	0.50mm		2.500		005 IWU CR P	STD
<i>[R66620]</i>			4.000		231 CR P	STD

5

OM 364		4cyl.	3972cc	55-66kW (68-89PS)	Diesel	FM6709
OM 364 A / LA Euro 1		4cyl.	3972cc	85-100kW (115-136PS)	Diesel Turbo Intercooled	FM6710
OM 364 LA Euro 2 (OM 354)		4cyl.	3972cc	77-103kW (105-140PS)	Diesel Turbo Intercooled	FM6901
OM 366 A / Euro1 (OM 356)		6cyl.	5958cc	100-129kW (136-175PS)	Diesel Turbo	FM6818
OM 366 Euro 1		6cyl.	5958cc	74-100kW (100-136PS)	Diesel	FM6711
OM 366 LA / Euro1 Euro 1 (OM 356/357)		6cyl.	5958cc	125-177kW (170-240PS)	Diesel Turbo Intercooled	FM6820
08-740000-00	STD	97.50	2.500		008 MOL P	KV1
08-740007-00	0.50mm		2.500		005 IWU CR P	STD
04/1984 →			4.000		231 CR P	STD
<i>[R43600]</i>						

6

OM 904 LA Euro 2		4cyl.	4249cc	75-142kW (102-193PS)	Diesel Turbo Intercooled	FM5646
OM 906 LA Euro 2		6cyl.	6374cc	142-228kW (193-310PS)	Diesel Turbo Intercooled	FM5647
08-289300-00	STD	102.00	3.000		008 CK P	KV1
<i>[R60360]</i>			2.500		005 IWU CR P	STD
			4.000		231 CR P	STD
08-289300-30	STD	102.00	3.000		008 CK	KV4
			2.500		005 IWU CR	GOE13
			4.000		231 CR	GOE12



7

OM 904 LA Euro 3/4		4cyl.	4249cc	95-130kW (129-177PS)	Diesel	Turbo Intercooled	FM15646
OM 906 LA Euro 3/4		6cyl.	6374cc	170-210kW (231-286PS)	Diesel	Turbo Intercooled	FM15647
08-146300-00	STD	102.00	3.000		008 GDC P		KV1
			2.500		005 IWU CR P		STD
			4.000		231 CR P		STD
08-146300-10	STD	102.00	3.000		008 GDC P		KV4
			2.500		005 IWU CR P		GOE13
			4.000		231 LKZ CK P		GOE13
OE: A906 030 0224		OE: A906 030 0224		OE: A906 030 0224		OE: A906 030 0224	

8

OM 924 LA Euro 3/4		4cyl.	4801cc	160kW (218PS)	Diesel	Turbo Intercooled	FM148
OM 926 LA Euro 3/4		6cyl.	7201cc	240kW (326PS)	Diesel	Turbo Intercooled	FM149
08-146400-00	STD	106.00	3.000		008 GDC P		KV1
			2.500		005 IWU CR P		STD
			4.000		231 CR P		STD
<i>[R67970]</i>							

9

OM 924.911 Euro 2 (OM 924 LA)		4cyl.	4801cc	160kW (218PS)	Diesel	Turbo Intercooled	TD19182
OM 926.911 Euro 2 (OM 926 LA)		6cyl.	7201cc	240kW (326PS)	Diesel	Turbo Intercooled	TD19155
OM 926.912 Euro 2 (OM 926 LA)		6cyl.	7201cc	240kW (326PS)	Diesel	Turbo Intercooled	TD19159
OM 926.914 Euro 2 (OM 926 LA)		6cyl.	7201cc	240kW (326PS)	Diesel	Turbo Intercooled	TD19161
08-127700-00	STD	106.00	3.000		008 CK P		KV1
			2.500		005 IWU CR P		STD
			4.000		231 CR P		STD

10

OM 360.911 (OM 360 H)		6cyl.	8720cc	125kW (170PS)	Diesel	TD7902
OM 360.914 (OM 360)		6cyl.	8720cc	141kW (192PS)	Diesel	TD5658
OM 360.915 (OM 360)		6cyl.	8720cc	141kW (192PS)	Diesel	TD5996
OM 360.916 (OM 360)		6cyl.	8720cc	125kW (170PS)	Diesel	TD5659
OM 360.917 (OM 360)		6cyl.	8720cc	125kW (170PS)	Diesel	TD5997
OM 360.918 (OM 360)		6cyl.	8720cc	125kW (170PS)	Diesel	TD7894
OM 360.931 (OM 360)		6cyl.	8720cc	141kW (192PS)	Diesel	TD6269
OM 360.933 (OM 360)		6cyl.	8720cc	125kW (170PS)	Diesel	TD6270





OM 360.936 (OM 360)		6cyl.	8725cc	125kW (170PS)	Diesel	TD16688
OM 360.937 (OM 360)		6cyl.	8725cc	127kW (173PS)	Diesel	TD16689
OM 360.939 (OM 360)		6cyl.	8720cc	125kW (170PS)	Diesel	TD8195
OM 360.940 (OM 360)		6cyl.	8725cc	127kW (173PS)	Diesel	TD16691
OM 360.941 (OM 360)		6cyl.	8725cc	141kW (192PS)	Diesel	TD16698
OM 360.942 (OM 360)		6cyl.	8725cc	127kW (173PS)	Diesel	TD16692
OM 360.943 (OM 360)		6cyl.	8725cc	127kW (173PS)	Diesel	TD16693
OM 360.944 (OM 360)		6cyl.	8725cc	127kW (173PS)	Diesel	TD16694
OM 360.946 (OM 360)		6cyl.	8725cc	127kW (173PS)	Diesel	TD16695
OM 360.948 (OM 360)		6cyl.	8725cc	125kW (170PS)	Diesel	TD16696
OM 360.949 (OM 360)		6cyl.	8725cc	125kW (170PS)	Diesel	TD16697
OM 360.980 (OM 360)		6cyl.	8720cc	141kW (192PS)	Diesel	TD17020
OM 360.981 (OM 360)		6cyl.	8720cc	141kW (192PS)	Diesel	TD17021
OM 360.984 (OM 360 A)		6cyl.	8720cc	154kW (210PS)	Diesel Turbo	TD17022
OM 360.985 (OM 360 A)		6cyl.	8720cc	141kW (192PS)	Diesel Turbo	TD17024
OM 360.986 (OM 360 A)		6cyl.	8720cc	154kW (210PS)	Diesel Turbo	TD17023
OM360 / OM360 H		6cyl.	8725cc	125kW (170PS)	Diesel	FM1153
08-171600-10	STD	115.00	3.500		008 MOL	ST
08-171607-10	0.50mm		3.000		001 IF MO P	IKA
08-171611-10	1.00mm		5.500		231 CR P	STD
08-171614-10	1.50mm					
08-176400-10	STD	115.00	3.500		008 MOL P	KV1
08-176407-10	0.50mm		3.000		001 IF MO P	IKA
08-176411-10	1.00mm		5.500		231 CR P	STD
08-176414-10	1.50mm					
08-176400-30	STD	115.00	3.500		008 CR	KV1
08-176407-30	0.50mm		3.000		026	F12/F14
08-176411-30	1.00mm		5.500		231 CR	STD
08-176414-30	1.50mm					

11

OM 401 A		V6cyl.	9600cc	188kW (256PS)	Diesel Turbo	FM4252
OM 404 A		V12cyl.	20911cc	386kW (525PS)	Diesel Turbo	FM4262
OM 407 A		6cyl.	11413cc	206kW (280PS)	Diesel Turbo	FM7056
OM 407 HA		6cyl.	11413cc	206kW (280PS)	Diesel Turbo	FM7057
OM 407.955		6cyl.	11413cc	206kW (280PS)	Diesel Turbo	TD6007
08-181000-00	STD	125.00	3.000		008 MOL	ST
			3.000		005 MO P	IKA
			3.000		026 MO P	IKA
			4.000		231 CR P	STD



12

OM 401 LA Euro 1	V6cyl.	9572cc	180-230kW (245-313PS)	Diesel	Turbo Intercooled	FM6646
OM 401.970 (OM 401 LA)	V6cyl.	9600cc	213kW (290PS)	Diesel	Turbo Intercooled	TD7938
OM 401.972 (OM 401 LA)	V6cyl.	9572cc	230kW (313PS)	Diesel	Turbo Intercooled	TD5777
OM 401.973 (OM 401 LA)	V6cyl.	9572cc	200kW (272PS)	Diesel	Turbo Intercooled	TD5733
OM 401.974 Euro 1 (OM 401 LA)	V6cyl.	9572cc	200kW (272PS)	Diesel	Turbo Intercooled	TD7939
OM 401.975 Euro 1 (OM 401 LA)	V6cyl.	9572cc	180kW (245PS)	Diesel	Turbo Intercooled	TD5751
OM 401.977 Euro 1 (OM 401 LA)	V6cyl.	9572cc	200kW (272PS)	Diesel	Turbo Intercooled	TD5801
OM 401.978 Euro 1 (OM 401 LA)	V6cyl.	9572cc	200kW (272PS)	Diesel	Turbo Intercooled	TD6065
OM 401.979 Euro 1 (OM 401 LA)	V6cyl.	9572cc	230kW (313PS)	Diesel	Turbo Intercooled	TD5780
OM 401.980 Euro 1 (OM 401 LA)	V6cyl.	9572cc	200kW (272PS)	Diesel	Turbo Intercooled	TD6293
OM 401.981 Euro 1 (OM 401 LA)	V6cyl.	9572cc	230kW (313PS)	Diesel	Turbo Intercooled	TD6162
OM 401.982 Euro 1 (OM 401 LA)	V6cyl.	9572cc	230kW (313PS)	Diesel	Turbo Intercooled	TD17103
OM 401.984 (OM 401 LA)	V6cyl.	9572cc	180kW (245PS)	Diesel	Turbo Intercooled	TD8127
OM 401.985 (OM 401 LA)	V6cyl.	9600cc	200kW (272PS)	Diesel	Turbo Intercooled	TD5753
OM 401.986 (OM 401 LA)	V6cyl.	9572cc	230kW (313PS)	Diesel	Turbo Intercooled	TD8199
OM 401.987 (OM 401 LA)	V6cyl.	9572cc	230kW (313PS)	Diesel	Turbo Intercooled	TD6163
OM 401.989 (OM 401 LA)	V6cyl.	9572cc	200kW (272PS)	Diesel	Turbo Intercooled	TD6068
OM 401.990 (OM 401 LA)	V6cyl.	9572cc	180kW (245PS)	Diesel	Turbo Intercooled	TD16950
OM 401.991 (OM 401 LA)	V6cyl.	9600cc	200kW (272PS)	Diesel	Turbo Intercooled	TD6086
OM 401.992 (OM 401 LA)	V6cyl.	9572cc	200kW (272PS)	Diesel	Turbo Intercooled	TD17113
OM 401.993 (OM 401 LA)	V6cyl.	9572cc	230kW (313PS)	Diesel	Turbo Intercooled	TD6113
OM 401.994 (OM 401 LA)	V6cyl.	9600cc	180kW (245PS)	Diesel	Turbo Intercooled	TD6084
OM 402 LA Euro 1	V8cyl.	12763cc	280-295kW (381-401PS)	Diesel	Turbo Intercooled	FM6647
OM 402.970 Euro 1 (OM 402 LA)	V8cyl.	12763cc	280kW (381PS)	Diesel	Turbo Intercooled	TD7940
OM 402.971 Euro 1 (OM 402 LA)	V8cyl.	12763cc	280kW (381PS)	Diesel	Turbo Intercooled	TD5783
OM 402.972 (OM 402 LA)	V8cyl.	12763cc	280kW (381PS)	Diesel	Turbo Intercooled	TD5784
OM 402.973 Euro 1 (OM 402 LA)	V8cyl.	12763cc	280kW (381PS)	Diesel	Turbo Intercooled	TD5832
OM 402.974 Euro 1 (OM 402 LA)	V8cyl.	12760cc	280-295kW (381-401PS)	Diesel	Turbo Intercooled	TD17807
OM 402.975 Euro 1 (OM 402 LA)	V8cyl.	12763cc	280kW (381PS)	Diesel	Turbo Intercooled	TD5818
OM 402.977 Euro 1 (OM 402 LA)	V8cyl.	12763cc	280kW (381PS)	Diesel	Turbo Intercooled	TD5826
OM 402.978 Euro 1 (OM 402 LA)	V8cyl.	12763cc	280kW (381PS)	Diesel	Turbo Intercooled	TD5786
OM 402.982 Euro 1 (OM 402 LA)	V8cyl.	12763cc	280kW (381PS)	Diesel	Turbo Intercooled	TD5830
OM 402.983 Euro 1 (OM 402 LA)	V8cyl.	12763cc	280kW (381PS)	Diesel	Turbo Intercooled	TD6182
OM 402.984 Euro 1 (OM 402 LA)	V8cyl.	12763cc	280kW (381PS)	Diesel	Turbo Intercooled	TD11268
OM 402.985 Euro 1 (OM 402 LA)	V8cyl.	12763cc	280kW (381PS)	Diesel	Turbo Intercooled	TD5806
OM 402.986 Euro 1 (OM 402 LA)	V8cyl.	12763cc	280kW (381PS)	Diesel	Turbo Intercooled	TD6151
OM 402.987 Euro 1 (OM 402 LA)	V8cyl.	12763cc	280kW (381PS)	Diesel	Turbo Intercooled	TD6178
OM 402.989 Euro 1 (OM 402 LA)	V8cyl.	12763cc	280kW (381PS)	Diesel	Turbo Intercooled	TD5807





OM 402.990 Euro 1 (OM 402 LA)		V8cyl.	12763cc	280kW (381PS)	Diesel	Turbo Intercooled	TD6153
OM 402.996 Euro 1 (OM 402 LA)		V8cyl.	12763cc	280kW (381PS)	Diesel	Turbo Intercooled	TD6121
08-176000-00	STD	125.00	3.000		008 MOL		ST
[R60340]			3.000		026 MO P		IKA
			4.000		231 CR P		STD
08-176000-20	STD	125.00	3.000		008 MOL		ST
			3.000		005 IWU CR		IKA
			4.000		231 CR		STD

13

OM 401.905 (OM 401)	V6cyl.	9570cc	141kW (192PS)	Diesel		TD5730
OM 401.906 (OM 401)	V6cyl.	9570cc	141kW (192PS)	Diesel		TD6062
OM 401.907 (OM 401)	V6cyl.	9572cc	141kW (192PS)	Diesel		TD16942
OM 401.908 (OM 401)	V6cyl.	9572cc	141kW (192PS)	Diesel		TD16943
OM 401.909 (OM 401)	V6cyl.	9570cc	141kW (192PS)	Diesel		TD5767
OM 401.912 (OM 401)	V6cyl.	9572cc	141kW (192PS)	Diesel		TD7895
OM 401.913 (OM 401)	V6cyl.	9570cc	141kW (192PS)	Diesel		TD16944
OM 401.914 (OM 401)	V6cyl.	9570cc	141kW (192PS)	Diesel		TD5729
OM 401.915 (OM 401)	V6cyl.	9570cc	141kW (192PS)	Diesel		TD6061
OM 401.916 (OM 401)	V6cyl.	9570cc	141kW (192PS)	Diesel		TD6099
OM 401.917 (OM 401 A)	V6cyl.	9570cc	188kW (256PS)	Diesel	Turbo	TD16949
OM 401.918 (OM 401)	V6cyl.	9570cc	141kW (192PS)	Diesel		TD8118
OM 401.919 (OM 401)	V6cyl.	9570cc	141kW (192PS)	Diesel		TD9596
OM 401.921 (OM 401)	V6cyl.	9570cc	141kW (192PS)	Diesel		TD16945
OM 401.922 (OM 401)	V6cyl.	9570cc	141kW (192PS)	Diesel		TD16946
OM 401.923 (OM 401)	V6cyl.	9570cc	141kW (192PS)	Diesel		TD6081
OM 401.925 (OM 401)	V6cyl.	9570cc	141kW (192PS)	Diesel		TD8229
OM 401.926 (OM 401)	V6cyl.	9570cc	141kW (192PS)	Diesel		TD9597
OM 401.927 (OM 401)	V6cyl.	9570cc	141kW (192PS)	Diesel		TD9598
OM 401.928 (OM 401)	V6cyl.	9570cc	141kW (192PS)	Diesel		TD16948
OM 402.905 (OM 402)	V8cyl.	12800cc	188kW (256PS)	Diesel		TD8179
OM 402.906 (OM 402)	V8cyl.	12800cc	188kW (256PS)	Diesel		TD5814
OM 402.907 (OM 402)	V8cyl.	12800cc	188kW (256PS)	Diesel		TD7896
OM 402.910 (OM 402)	V8cyl.	12800cc	176kW (239PS)	Diesel		TD5752
OM 402.912 (OM 402)	V8cyl.	12800cc	188kW (256PS)	Diesel		TD5758
OM 402.913 (OM 402)	V8cyl.	12760cc	177kW (240PS)	Diesel		TD17803
OM 402.914 (OM 402)	V8cyl.	12800cc	176kW (239PS)	Diesel		TD8230
OM 402.916 (OM 402)	V8cyl.	12800cc	188kW (256PS)	Diesel		TD5798
OM 402.917 (OM 402)	V8cyl.	12760cc	177kW (240PS)	Diesel		TD17804
OM 402.919 (OM 402)	V8cyl.	12800cc	176kW (239PS)	Diesel		TD8154
OM 402.921 (OM 402)	V8cyl.	12760cc	177kW (240PS)	Diesel		TD17805
OM 402.923 (OM 402)	V8cyl.	12800cc	176kW (239PS)	Diesel		TD8183





OM 402.924 (OM 402)	V8cyl.	12800cc	188kW (256PS)	Diesel	TD6291
OM 402.925 (OM 402)	V8cyl.	12760cc	188kW (256PS)	Diesel	TD17806
OM 402.926 (OM 402)	V8cyl.	12800cc	188kW (256PS)	Diesel	TD6296
OM 402.927 (OM 402)	V8cyl.	12800cc	176kW (239PS)	Diesel	TD9606
OM 402.928 (OM 402)	V8cyl.	12800cc	176kW (239PS)	Diesel	TD9607
OM 403.915 (OM 403)	V10cyl.	15900cc	236kW (321PS)	Diesel	TD8180
OM 403.916 (OM 403)	V10cyl.	15900cc	236kW (321PS)	Diesel	TD5816
OM 403.917 (OM 403)	V10cyl.	15950cc	236kW (321PS)	Diesel	TD16953
OM 403.918 (OM 403)	V10cyl.	15900cc	235kW (320PS)	Diesel	TD7897
OM 403.919 (OM 403)	V10cyl.	15950cc	236kW (321PS)	Diesel	TD16954
OM 403.930 (OM 403)	V10cyl.	15950cc	236kW (321PS)	Diesel	TD16955
OM 403.931 (OM 403)	V10cyl.	15900cc	235kW (320PS)	Diesel	TD5759
OM 403.932 (OM 403)	V10cyl.	15900cc	235kW (320PS)	Diesel	TD6133
OM 403.934 (OM 403)	V10cyl.	15950cc	236kW (321PS)	Diesel	TD16957
OM 403.935 (OM 403)	V10cyl.	15900cc	236kW (321PS)	Diesel	TD6299
OM 404	V12cyl.	20911cc	184-236kW (250-320PS)	Diesel	FM3816
OM 407 / H	6cyl.	11413cc	177kW (240PS)	Diesel	FM7055
OM 407.905 (OM 407 H)	6cyl.	11000cc	132kW (180PS)	Diesel	TD5664
OM 407.907 (OM 407 H)	6cyl.	11045cc	155kW (211PS)	Diesel	TD10767
OM 407.908 (OM 407 H)	6cyl.	11000cc	132kW (180PS)	Diesel	TD6002
OM 407.909 (OM 407 H)	6cyl.	11000cc	155kW (211PS)	Diesel	TD5665
OM 407.910 (OM 407 H)	6cyl.	11000cc	155kW (211PS)	Diesel	TD6003
OM 407.911 (OM 407 H)	6cyl.	11000cc	155kW (211PS)	Diesel	TD6273
OM 407.913 (OM 407 H)	6cyl.	11400cc	147kW (200PS)	Diesel	TD5666
OM 407.914 (OM 407 H)	6cyl.	11400cc	147kW (200PS)	Diesel	TD6004
OM 407.915 (OM 407 H)	6cyl.	11400cc	147kW (200PS)	Diesel	TD6274
OM 407.916 (OM 407 H)	6cyl.	11400cc	177kW (240PS)	Diesel	TD5667
OM 407.917 (OM 407 H)	6cyl.	11400cc	177kW (240PS)	Diesel	TD6005
OM 407.918 (OM 407 H)	6cyl.	11400cc	177kW (240PS)	Diesel	TD6275
OM 407.919 (OM 407 H)	6cyl.	11400cc	177kW (240PS)	Diesel	TD6006
OM 407.920 (OM 407 H)	6cyl.	11412cc	177kW (240PS)	Diesel	TD17808
OM 409	5cyl.	9204cc	137-141kW (185-192PS)	Diesel	FM6360
OM 409.906 (OM 409)	5cyl.	9204cc	135kW (184PS)	Diesel	TD18812





OM 409.907 (OM 409)		5cyl.	9204cc	135kW (184PS)	Diesel	TD18813
OM 409.908 (OM 409)		5cyl.	9204cc	135kW (184PS)	Diesel	TD18814
08-172700-00	STD	125.00	3.000		008 MOL	ST
			3.000		026 MO P	IKA
			6.000		231 CR P	STD
08-176800-10	STD	125.00	3.000		008 CR P	KV1
[R34120]			3.000		005 P	STD
			6.000		231 CR P	STD
08-176800-20	STD	125.00	3.000		008 CR	KV1
08-176807-20	0.50mm		3.000		005	STD
			6.000		231 CR	STD

14

OM 346.910 (OM 346)	6cyl.	10809cc	155kW (211PS)	Diesel	TD16592
OM 346.911 (OM 346 H)	6cyl.	10809cc	155kW (211PS)	Diesel	TD7913
OM 346.912 (OM 346)	6cyl.	10809cc	155kW (211PS)	Diesel	TD8178
OM 346.913 (OM 346)	6cyl.	10809cc	155kW (211PS)	Diesel	TD16593
OM 346.914 (OM 346)	6cyl.	10809cc	136kW (185PS)	Diesel	TD16595
OM 346.915 (OM 346)	6cyl.	10809cc	136kW (185PS)	Diesel	TD16596
OM 346.916 (OM 346)	6cyl.	10809cc	136kW (185PS)	Diesel	TD8160
OM 346.917 (OM 346)	6cyl.	10809cc	155kW (211PS)	Diesel	TD16597
OM 346.918 (OM 346 H)	6cyl.	10809cc	132kW (180PS)	Diesel	TD7914
OM 346.941 (OM 346)	6cyl.	10809cc	155kW (211PS)	Diesel	TD16598
OM 346.942 (OM 346)	6cyl.	10809cc	155kW (211PS)	Diesel	TD16599
OM 346.943 (OM 346)	6cyl.	10809cc	136kW (185PS)	Diesel	TD16601
OM 346.944 (OM 346)	6cyl.	10809cc	136kW (185PS)	Diesel	TD16602
OM 346.945 (OM 346)	6cyl.	10809cc	136kW (185PS)	Diesel	TD16603
OM 346.946 (OM 346)	6cyl.	10809cc	136kW (185PS)	Diesel	TD16604
OM 346.952 (OM 346)	6cyl.	10809cc	141kW (192PS)	Diesel	TD16605
OM 346.953 (OM 346)	6cyl.	10809cc	136kW (185PS)	Diesel	TD16940
OM 355.910 (OM 355)	6cyl.	11581cc	169kW (230PS)	Diesel	TD16668
OM 355.911 (OM 355)	6cyl.	11581cc	169kW (230PS)	Diesel	TD16669
OM 355.912 (OM 355)	6cyl.	11581cc	169kW (230PS)	Diesel	TD16670
OM 355.913 (OM 355)	6cyl.	11581cc	169kW (230PS)	Diesel	TD16671
OM 355.914 (OM 355)	6cyl.	11581cc	169kW (230PS)	Diesel	TD16672
OM 355.915 (OM 355)	6cyl.	11581cc	169kW (230PS)	Diesel	TD7892
OM 355.916	6cyl.	11581cc	169kW (230PS)	Diesel	TD22746
OM 355.918 (OM 355)	6cyl.	11581cc	169kW (230PS)	Diesel	TD16673
OM 355.960 (OM 355)	6cyl.	11581cc	176kW (239PS)	Diesel	TD5813
OM 355.961 (OM 355 H)	6cyl.	11581cc	155kW (211PS)	Diesel	TD16675











OM 355.962 (OM 355)	6cyl.	11581cc	177kW (240PS)	Diesel	TD16676
OM 355.963 (OM 355)	6cyl.	11581cc	176kW (239PS)	Diesel	TD5812
OM 355.964 (OM 355)	6cyl.	11581cc	177kW (240PS)	Diesel	TD16677
OM 355.966 (OM 355)	6cyl.	11581cc	155kW (211PS)	Diesel	TD16678
OM 355.967 (OM 355)	6cyl.	11581cc	177kW (240PS)	Diesel	TD7893
OM 355.968 (OM 355)	6cyl.	11581cc	191kW (260PS)	Diesel	TD23185
OM 355.969 (OM 355 A)	6cyl.	11581cc	206kW (280PS)	Diesel Turbo	TD8212
OM 355.970 (OM 355)	6cyl.	11581cc	191kW (260PS)	Diesel	TD16679
OM 355.972 (OM 355 H)	6cyl.	11581cc	136kW (185PS)	Diesel	TD16680
OM 355.973 (OM 355 H)	6cyl.	11581cc	177kW (240PS)	Diesel	TD16681
OM 355.974 (OM 355)	6cyl.	11581cc	177kW (240PS)	Diesel	TD16682
OM 355.975 (OM 355)	6cyl.	11600cc	176kW (239PS)	Diesel	TD6160
OM 355.976 (OM 355)	6cyl.	11581cc	176kW (239PS)	Diesel	TD6159
OM 355.977 (OM 355 A)	6cyl.	11581cc	205kW (279PS)	Diesel Turbo	TD16683
OM 355.978 (OM 355)	6cyl.	11581cc	177kW (240PS)	Diesel	TD16684
OM 355.979 (OM 355)	6cyl.	11581cc	177kW (240PS)	Diesel	TD16685
OM 355.980 (OM 355)	6cyl.	11581cc	177kW (240PS)	Diesel	TD16686
OM 355.981 (OM 355)	6cyl.	11581cc	184kW (250PS)	Diesel	TD16687
OM 355.982 (OM 355)	6cyl.	11581cc	184kW (250PS)	Diesel	TD16674
OM 355.983 (OM 355)	6cyl.	11581cc	177kW (240PS)	Diesel	TD5811
OM 355.984 (OM 355)	6cyl.	11581cc	177kW (240PS)	Diesel	TD6158

08-171200-10	STD	128.00	3.500		008 MOL	ST		
			3.500		001 IF MO P	IKA		
			3.500		023 MO P	STD		
			6.500		231 CR P	STD		
08-176900-10	STD	128.00	3.500		008 MOL P	KV1		
			08-176907-10	0.50mm	3.500		005 IF P	STD
			08-176911-10	1.00mm	3.500		026 P	STD
			08-176914-10	1.50mm	3.500		026 P	STD
[R46000]			6.500		231 CR P	STD		
			08-176900-80	STD	3.500		008 MOL	KV1
			08-176907-80	0.50mm	3.500		005 IF	STD
			08-176911-80	1.00mm	3.500		026	STD
			6.500		231 CR	STD		



15

OM 421 A	V6cyl.	10964cc	184kW (250PS)	Diesel	Turbo	FM7012
OM 421 LA	V6cyl.	10964cc		Diesel	Turbo Intercooled	FM6712
OM 422 A	V8cyl.	14618cc	243kW (330PS)	Diesel	Turbo	FM7013
OM 422 LA	V8cyl.	14618cc	276kW (375PS)	Diesel	Turbo Intercooled	FM7014
OM 423 A	V10cyl.	18273cc	270-301kW (367-409PS)	Diesel	Turbo	FM7015
OM 423 LA	V10cyl.	18273cc	368kW (500PS)	Diesel	Turbo Intercooled	FM7016
OM 424 A	V12cyl.	21927cc	390-404kW (530-550PS)	Diesel	Turbo	FM7017
OM 424 LA	V12cyl.	21927cc	404-452kW (549-615PS)	Diesel	Turbo Intercooled	FM7018
OM 427	6cyl.	11967cc	206kW (280PS)	Diesel		FM7063
OM 427 A	6cyl.	11967cc	206kW (280PS)	Diesel	Turbo	FM7065
OM 427 H	6cyl.	11967cc	150-170kW (204-240PS)	Diesel		FM7064
OM 427 HA	6cyl.	11967cc	206kW (280PS)	Diesel	Turbo	FM7066
OM 427 LA	6cyl.	11967cc		Diesel	Turbo Intercooled	FM6707
OM 441 A	V6cyl.	10964cc	200kW (272PS)	Diesel	Turbo	FM6529
OM 441 LA / Euro 1	V6cyl.	10964cc	250kW (340PS)	Diesel	Turbo Intercooled	FM6648
OM 441 LA Euro 2	V6cyl.	10964cc	180-250kW (245-340PS)	Diesel	Turbo Intercooled	FM6936
OM 442 A	V8cyl.	14618cc	269kW (366PS)	Diesel	Turbo	FM7006
OM 442 A Euro 1	V8cyl.	14618cc	250kW (340PS)	Diesel	Turbo	FM7008
OM 442 LA / Euro 1	V8cyl.	14618cc	320-362kW (435-492PS)	Diesel	Turbo Intercooled	FM7009
OM 442 LA Euro 2	V8cyl.	14618cc	320-390kW (435-530PS)	Diesel	Turbo Intercooled	FM6937
OM 443 A	V10cyl.	18273cc	331kW (450PS)	Diesel	Turbo	FM6639
OM 443 LA	V10cyl.	18270cc	401kW (545PS)	Diesel	Turbo Intercooled	FM6640
OM 444 A	V12cyl.	21927cc	390kW (530PS)	Diesel	Turbo	FM7078
OM 444 LA	V12cyl.	21927cc	478-610kW (530-830PS)	Diesel	Turbo Intercooled	FM6642
OM 447	6cyl.	11967cc	147kW (200PS)	Diesel		FM7067
OM 447 A	6cyl.	11967cc	206kW (280PS)	Diesel	Turbo	FM7004
OM 447 H	6cyl.	11967cc	150-184kW (204-250PS)	Diesel		FM7005
OM 447 HA / Euro 1	6cyl.	11967cc	184-220kW (250-300PS)	Diesel	Turbo	FM7007
OM 447 HLA Euro 1	6cyl.	11967cc	220kW (299PS)	Diesel	Turbo Intercooled	FM6706
OM 447 HLA Euro 2	6cyl.	11970cc	157kW (214PS)	Diesel	Turbo Intercooled	FM5644
OM 447 LA	6cyl.	11967cc		Diesel	Turbo Intercooled	FM6705
OM 449 A	5cyl.	9975cc		Diesel	Turbo	FM6168
OM 449 LA	5cyl.	9975cc		Diesel	Turbo Intercooled	FM5652

08-179300-10	STD	128.00	3.000		008 MOL	ST
[R45100]			3.000		005 IWU CR P	IKA
			4.000		231 CR P	STD
08-179300-20	STD	128.00	3.000		008 MOL	ST
			3.000		005 IWU CR	IKA
			4.000		231 CR	STD



16

OM 421.905 (OM 421)	V6cyl.	10964cc	159kW (216PS)	Diesel	TD5799
OM 421.906 (OM 421)	V6cyl.	10900cc	159kW (216PS)	Diesel	TD8120
OM 421.907 (OM 421)	V6cyl.	10964cc	159kW (216PS)	Diesel	TD6139
OM 421.908 (OM 421)	V6cyl.	10964cc	159kW (216PS)	Diesel	TD7898
OM 421.909 (OM 421)	V6cyl.	10964cc	159kW (216PS)	Diesel	TD17056
OM 421.910 (OM 421)	V6cyl.	10964cc	159kW (216PS)	Diesel	TD16958
OM 422.905 (OM 422)	V8cyl.	14618cc	206kW (280PS)	Diesel	TD5760
OM 422.906 (OM 422)	V8cyl.	14618cc	206kW (280PS)	Diesel	TD6093
OM 422.907 (OM 422)	V8cyl.	14618cc	206kW (280PS)	Diesel	TD5805
OM 422.908 (OM 422)	V8cyl.	14600cc	206kW (280PS)	Diesel	TD7900
OM 422.909 (OM 422)	V8cyl.	14618cc	184kW (250PS)	Diesel	TD8157
OM 422.910 (OM 422)	V8cyl.	14618cc	206kW (280PS)	Diesel	TD6132
OM 422.911 (OM 422)	V8cyl.	14618cc	206kW (280PS)	Diesel	TD6140
OM 422.912 (OM 422)	V8cyl.	14618cc	184kW (250PS)	Diesel	TD8231
OM 422.913 (OM 422)	V8cyl.	14618cc	206kW (280PS)	Diesel	TD6149
OM 422.914 (OM 422)	V8cyl.	14600cc	206kW (280PS)	Diesel	TD5828
OM 422.915 (OM 422)	V8cyl.	14618cc	184kW (250PS)	Diesel	TD16959
OM 422.916 (OM 422)	V8cyl.	14618cc	206kW (280PS)	Diesel	TD17111
OM 422.917 (OM 422)	V8cyl.	14618cc	206kW (280PS)	Diesel	TD11029
OM 422.918 (ÔM 422)	V8cyl.	14618cc	206kW (280PS)	Diesel	TD16960
OM 422.919 (ÔM 422)	V8cyl.	14618cc	206kW (280PS)	Diesel	TD5821
OM 422.920 (OM 422)	V8cyl.	14618cc	184kW (250PS)	Diesel	TD8249
OM 422.921 (OM 422)	V8cyl.	14618cc	206kW (280PS)	Diesel	TD6173
OM 422.922 (ÔM 422)	V8cyl.	14618cc	206kW (280PS)	Diesel	TD16961
OM 422.923 (ÔM 422)	V8cyl.	14618cc	206kW (280PS)	Diesel	TD16962
OM 423.905 (OM 423)	V10cyl.	18300cc	261kW (355PS)	Diesel	TD5762
OM 423.906 (OM 423)	V10cyl.	18273cc	261kW (355PS)	Diesel	TD6126
OM 423.907 (OM 423)	V10cyl.	18273cc	261kW (355PS)	Diesel	TD6289
OM 423.908 (OM 423)	V10cyl.	18300cc	261kW (355PS)	Diesel	TD6096
OM 423.909 (OM 423)	V10cyl.	18273cc	261kW (355PS)	Diesel	TD16963
OM 424.900 (OM 424)	V12cyl.	21930cc	309kW (420PS)	Diesel	TD18815

08-178300-00	STD	128.00	3.000		008 MOL	ST
			3.000		026 MO P	IKA
			4.000		231 CR P	STD
08-181700-00	STD	128.00	3.000		008 MOL P	KV1
			3.000		026 MO P	IKA
			4.000		231 CR P	STD
[R45410]						
08-181700-20	STD	128.00	3.000		008 MOL	KV1
			3.000		026 MO	IKA
			4.000		231 CR	STD



17

OM 441		6cyl.	10964cc	Diesel		FM16702
08-742300-00 →eng.512443	STD	128.00	3.000		008 MOL P	KV1
			3.000		005 IWU CR P	IKA
			4.000		231 CR P	STD
08-742300-20 →eng.512443	STD	128.00	3.000		008 MOL	KV1
			3.000		005 IWU CR	IKA
			4.000		231 CR	STD

18

OM 457.910 Euro 5 (OM 457 LA)	6cyl.	11967cc	260-315kW (354-428PS)	Diesel	Turbo Intercooled	TD25467
OM 457.950 Euro 4 (OM 457 HLA)	6cyl.	11967cc	260-220kW (354-299PS)	Diesel	Turbo Intercooled	TD20337
OM 457.951 Euro 4 (OM 457 LA)	6cyl.	11967cc	260kW (354PS)	Diesel	Turbo Intercooled	TD23250
OM 457.952 Euro 4 (OM 457 HLA)	6cyl.	11967cc	300-220kW (408-299PS)	Diesel	Turbo Intercooled	TD20338
OM 457.953 Euro 4 (OM 457 LA)	6cyl.	11967cc	260-315kW (354-428PS)	Diesel	Turbo Intercooled	TD23251
OM 457.954 Euro 4 (OM 457 HLA)	6cyl.	11967cc	260-220kW (354-299PS)	Diesel	Turbo Intercooled	TD20339
OM 457.959 Euro 4 (OM 457 HLA)	6cyl.	11967cc	260-220kW (354-299PS)	Diesel	Turbo Intercooled	TD20341
OM 457.964 Euro 4 (OM 457 HLA)	6cyl.	11967cc	220-260kW (299-408PS)	Diesel	Turbo Intercooled	TD23247
OM 457.965 Euro 4 (OM 457 HLA)	6cyl.	11967cc	220-300kW (299-408PS)	Diesel	Turbo Intercooled	TD23248
OM 457.966 Euro 4 (OM 457 HLA)	6cyl.	11967cc	220-260kW (299-354PS)	Diesel	Turbo Intercooled	TD23249
OM 457.973 Euro 4 (OM 457 HLA)	6cyl.	11967cc	220-260kW (299-354PS)	Diesel	Turbo Intercooled	TD27003
OM 457.980 Euro 2 (OM 457 LA)	6cyl.	11967cc	260-315kW (354-428PS)	Diesel	Turbo Intercooled	TD25446
OM 457.981 Euro 3 (OM 457 LA)	6cyl.	11967cc	260-315kW (354-428PS)	Diesel	Turbo Intercooled	TD25447
08-427000-00 [R67937]	STD	128.00	3.000		008 IF GDC	ST
			3.000		005 IWU CR	GOE13
			4.000		231 LKZ GDC P	STD

19

OM 457.914 Euro 3 (OM 457 LA)	6cyl.	11967cc	250kW (340PS)	Diesel	Turbo Intercooled	TD20335
OM 457.915 Euro 3 (OM 457 LA)	6cyl.	11967cc	265kW (360PS)	Diesel	Turbo Intercooled	TD20303
OM 457.916 Euro 3 (OM 457 LA)	6cyl.	11967cc	265kW (360PS)	Diesel	Turbo Intercooled	TD20304
OM 457.918 Euro 3 (OM 457 LA)	6cyl.	11967cc	260kW (354PS)	Diesel	Turbo Intercooled	TD20305
OM 457.919 Euro 3 (OM 457 LA)	6cyl.	11967cc	315kW (428PS)	Diesel	Turbo Intercooled	TD20306
OM 457.920 Euro 3 (OM 457 LA)	6cyl.	11967cc	280kW (381PS)	Diesel	Turbo Intercooled	TD20307
OM 457.922 Euro 3 (OM 457 LA)	6cyl.	11967cc	320kW (435PS)	Diesel	Turbo Intercooled	TD20308
OM 457.923 Euro 3 (OM 457 LA)	6cyl.	11967cc	280kW (381PS)	Diesel	Turbo Intercooled	TD20309
OM 457.924 Euro 3 (OM 457 LA)	6cyl.	11967cc	280kW (381PS)	Diesel	Turbo Intercooled	TD20310
OM 457.925 Euro 3 (OM 457 LA)	6cyl.	11967cc	265kW (360PS)	Diesel	Turbo Intercooled	TD20311
OM 457.926 Euro 3 (OM 457 LA)	6cyl.	11967cc	265kW (360PS)	Diesel	Turbo Intercooled	TD20312
OM 457.927 Euro 3 (OM 457 LA)	6cyl.	11967cc	295kW (401PS)	Diesel	Turbo Intercooled	TD20336





OM 457.928 Euro 3 (OM 457 LA)	6cyl.	11967cc	280kW (381PS)	Diesel	Turbo Intercooled	TD20313
OM 457.929 Euro 3 (OM 457 LA)	6cyl.	11967cc	265kW (360PS)	Diesel	Turbo Intercooled	TD20314
OM 457.931 Euro 3 (OM 457 LA)	6cyl.	11967cc	280kW (381PS)	Diesel	Turbo Intercooled	TD20315
OM 457.932 Euro 3 (OM 457 LA)	6cyl.	11967cc	265kW (360PS)	Diesel	Turbo Intercooled	TD20316
OM 457.948 Euro 3 (OM 457 LA)	6cyl.	11967cc	315-260kW (428-354PS)	Diesel	Turbo Intercooled	TD20227
OM 457.955 Euro 3 (OM 457 LA)	6cyl.	11967cc	315-260kW (428-354PS)	Diesel	Turbo Intercooled	TD20323
OM 457.956 Euro 3 (OM 457 LA)	6cyl.	11967cc	315-260kW (428-354PS)	Diesel	Turbo Intercooled	TD20282
OM 457.957 Euro 3 (OM 457 LA)	6cyl.	11967cc	315-260kW (428-354PS)	Diesel	Turbo Intercooled	TD20283
OM 457.961 Euro 3 (OM 457 LA)	6cyl.	11967cc	260-355kW (354-483PS)	Diesel	Turbo Intercooled	TD23252
OM 457.962 Euro 3 (OM 457 LA)	6cyl.	11967cc	260-315kW (354-428PS)	Diesel	Turbo Intercooled	TD23253
OM 458.980 Euro 3 (OM 457 LA)	6cyl.	11967cc	335kW (456PS)	Diesel	Turbo Intercooled	TD17670

08-141800-00	STD	128.00	3.000		008 IF CK	ST
[R67937]			3.000		005 IWU CR	GOE13
			4.000		231 CK	GOE13





20

OM 457.917 (OM 457 LA)	6cyl.	11967cc	315-260kW (428-354PS)	Diesel	Turbo Intercooled	TD20324
OM 457.933 Euro 2 (OM 457 HLA)	6cyl.	11967cc	260kW (354PS)	Diesel	Turbo Intercooled	TD17662
OM 457.934 Euro 2 (OM 457 HLA)	6cyl.	11967cc	220kW (299PS)	Diesel	Turbo Intercooled	TD17473
OM 457.935 Euro 2 (OM 457 HLA)	6cyl.	11967cc	185kW (252PS)	Diesel	Turbo Intercooled	TD17502
OM 457.937 Euro 2 (OM 457 LA)	6cyl.	11967cc	260-315kW (354-428PS)	Diesel	Turbo Intercooled	TD16489
OM 457.938 Euro 2 (OM 457 HLA)	6cyl.	11967cc	300kW (408PS)	Diesel	Turbo Intercooled	TD17645
OM 457.939 Euro 2 (OM 457 LA)	6cyl.	11967cc	260kW (354PS)	Diesel	Turbo Intercooled	TD20317
OM 457.940 Euro 2 (OM 457 LA)	6cyl.	11967cc	260kW (354PS)	Diesel	Turbo Intercooled	TD17654
OM 457.941 Euro 2 (OM 457 HLA)	6cyl.	11967cc	185-300kW (252-408PS)	Diesel	Turbo Intercooled	TD17641
OM 457.942 Euro 2 (OM 457 HLA)	6cyl.	11967cc	185-260kW (252-354PS)	Diesel	Turbo Intercooled	TD17448
OM 457.943 Euro 2 (OM 457 LA)	6cyl.	11967cc	185kW (252PS)	Diesel	Turbo Intercooled	TD17666
OM 457.944 Euro 2 (OM 457 LA)	6cyl.	11967cc	260-310kW (354-422PS)	Diesel	Turbo Intercooled	TD17644
OM 457.945 Euro 2 (OM 457 LA)	6cyl.	11967cc	260kW (354PS)	Diesel	Turbo Intercooled	TD20318
OM 457.946 Euro 2 (OM 457 LA)	6cyl.	11967cc	220kW (299PS)	Diesel	Turbo Intercooled	TD20319
OM 457.947 Euro 2 (OM 457 LA)	6cyl.	11967cc	315-260kW (428-354PS)	Diesel	Turbo Intercooled	TD20320
OM 457.949 Euro 2 (OM 457 LA)	6cyl.	11967cc	220kW (299PS)	Diesel	Turbo Intercooled	TD20321
OM 457.958 (OM 457 LA)	6cyl.	11967cc	315-230kW (428-313PS)	Diesel	Turbo Intercooled	TD20340
OM 457.960 Euro 2 (OM 457 LA)	6cyl.	11967cc	315-260kW (428-354PS)	Diesel	Turbo Intercooled	TD20322

08-115800-00	STD	128.00	3.000		008 CK	ST
			3.000		005 IWU CR P	IKA
			4.000		231 CR P	STD



21

OM 460 HLA		6cyl.	12820cc	295-335kW (396-456PS)	Diesel	FM94255
OM 460.950 Euro 3 (OM 460 HLA)		6cyl.	12816cc	315-350kW (428-476PS)	Diesel Turbo Intercooled	TD22811
OM 460.951 Euro 3 (OM 460 HLA)		6cyl.	12816cc	315-360kW (428-490PS)	Diesel Turbo Intercooled	TD23254
08-420000-00	STD	128.00	4.000	 008 IW GDC P		KV1
			3.000	 005 IW CR P		GOE13
			4.000	 231 LKZ CK P		GOE13
				 		

22

OM 440.905 Euro 1 (OM 442)	V8cyl.	15080cc	191kW (260PS)	Diesel	TD17116
OM 440.906 Euro 1 (OM 442)	V8cyl.	15080cc	206kW (280PS)	Diesel	TD17117
OM 440.907 Euro 1 (OM 442)	V8cyl.	15080cc	195kW (265PS)	Diesel	TD16966
OM 440.908 Euro 1 (OM 442)	V8cyl.	15080cc	206kW (280PS)	Diesel	TD17118
OM 440.909 (OM 442)	V8cyl.	15080cc	195kW (265PS)	Diesel	TD8192
OM 440.910 Euro 1 (OM 442)	V8cyl.	15080cc	218kW (296PS)	Diesel	TD17119
OM 440.911 Euro 1 (OM 442)	V8cyl.	15080cc	218kW (296PS)	Diesel	TD17120
OM 440.912 Euro 1 (OM 442)	V8cyl.	15080cc	218kW (296PS)	Diesel	TD17121
OM 441 / Euro 1	6cyl.	11309cc	151kW (205PS)	Diesel	FM17010
OM 441.905 (OM 441)	V6cyl.	10964cc	165kW (224PS)	Diesel	TD5731
OM 441.906 (OM 441)	V6cyl.	10964cc	150kW (204PS)	Diesel	TD8184
OM 441.907 (OM 441)	V6cyl.	10964cc	150kW (204PS)	Diesel	TD8185
OM 441.908 (OM 441)	V6cyl.	10964cc	160-165kW (218-224PS)	Diesel	TD5660
OM 441.909 (OM 441)	V6cyl.	10964cc	160-165kW (218-224PS)	Diesel	TD5998
OM 441.911 (OM 441)	V6cyl.	10964cc	160-165kW (218-224PS)	Diesel	TD6271
OM 441.912 (OM 441)	V6cyl.	11309cc	165kW (224PS)	Diesel	TD6142
OM 441.913 (OM 441)	V6cyl.	10964cc	165kW (224PS)	Diesel	TD6063
OM 441.914 (OM 441)	V6cyl.	11309cc	165kW (224PS)	Diesel	TD6101
OM 441.915 (OM 441)	V6cyl.	10964cc	165kW (224PS)	Diesel	TD8121
OM 441.916 (OM 441)	V6cyl.	11309cc	153kW (208PS)	Diesel	TD5768
OM 441.917 (OM 441)	V6cyl.	10964cc	160kW (218PS)	Diesel	TD8122
OM 441.918 (OM 441)	V6cyl.	11309cc	165kW (224PS)	Diesel	TD10968
OM 441.919 (OM 441)	V6cyl.	11309cc	153kW (208PS)	Diesel	TD16972
OM 441.920 (OM 441)	V6cyl.	11309cc	153kW (208PS)	Diesel	TD6100
OM 441.921 (OM 441)	V6cyl.	11300cc	165kW (224PS)	Diesel	TD7941
OM 441.922 Euro 1 (OM 441)	V6cyl.	11300cc	151kW (205PS)	Diesel	TD7942
OM 441.923 (OM 441)	V6cyl.	10964cc	160kW (218PS)	Diesel	TD5732
OM 441.924 (OM 441)	V6cyl.	11309cc	160kW (218PS)	Diesel	TD6143
OM 441.925 (OM 441)	V6cyl.	10964cc	160kW (218PS)	Diesel	TD6064
OM 441.926 (OM 441)	V6cyl.	10964cc	160kW (218PS)	Diesel	TD8119
OM 441.927 (OM 441)	V6cyl.	10964cc	153kW (208PS)	Diesel	TD8123
OM 441.932 (OM 441)	V6cyl.	11309cc	151kW (205PS)	Diesel	TD8190
OM 441.933 Euro 1 (OM 441)	V6cyl.	11309cc	151kW (205PS)	Diesel	TD8191
OM 442 Euro 1	V8cyl.	15080cc	195kW (265PS)	Diesel	FM17011





OM 442.905 (OM 442)	V8cyl.	15080cc	191kW (260PS)	Diesel	TD8186
OM 442.906 (OM 442)	V8cyl.	15080cc	218kW (296PS)	Diesel	TD5769
OM 442.907 (OM 442)	V8cyl.	15080cc	213kW (290PS)	Diesel	TD5771
OM 442.908 (OM 442)	V8cyl.	15080cc	210kW (286PS)	Diesel	TD5790
OM 442.909 (OM 442)	V8cyl.	15080cc	210kW (286PS)	Diesel	TD5791
OM 442.910 (OM 442)	V8cyl.	15080cc	213-218kW (290-296PS)	Diesel	TD5662
OM 442.911 (OM 442)	V8cyl.	15080cc	218kW (296PS)	Diesel	TD10971
OM 442.913 (OM 442)	V8cyl.	15080cc	213kW (290PS)	Diesel	TD17130
OM 442.914 (OM 442)	V8cyl.	15080cc	195kW (265PS)	Diesel	TD5734
OM 442.915 (OM 442)	V8cyl.	15078cc	218kW (296PS)	Diesel	TD5822
OM 442.916 (OM 442)	V8cyl.	15078cc	218kW (296PS)	Diesel	TD6174
OM 442.917 (OM 442)	V8cyl.	15080cc	218kW (296PS)	Diesel	TD6297
OM 442.918 (OM 442)	V8cyl.	15080cc	213-218kW (290-296PS)	Diesel	TD6000
OM 442.919 (OM 442)	V8cyl.	15080cc	213-218kW (290-296PS)	Diesel	TD6272
OM 442.920 (OM 442)	V8cyl.	15080cc	195kW (265PS)	Diesel	TD5735
OM 442.921 (OM 442)	V8cyl.	15080cc	195kW (265PS)	Diesel	TD6144
OM 442.922 (OM 442)	V8cyl.	15080cc	195kW (265PS)	Diesel	TD5770
OM 442.923 (OM 442)	V8cyl.	15080cc	210kW (286PS)	Diesel	TD6127
OM 442.924 (OM 442)	V8cyl.	15080cc	210kW (286PS)	Diesel	TD6128
OM 442.925 (OM 442)	V8cyl.	15080cc	213kW (290PS)	Diesel	TD5815
OM 442.926 (OM 442)	V8cyl.	15080cc	213kW (290PS)	Diesel	TD5792
OM 442.927 (OM 442)	V8cyl.	15078cc	213kW (290PS)	Diesel	TD5823
OM 442.928 (OM 442)	V8cyl.	15078cc	213kW (290PS)	Diesel	TD6175
OM 442.929 (OM 442)	V8cyl.	15080cc	213kW (290PS)	Diesel	TD6129
OM 442.930 (OM 442)	V8cyl.	15100cc	213kW (290PS)	Diesel	TD7944
OM 442.931 (OM 442)	V8cyl.	15100cc	195kW (265PS)	Diesel	TD7945
OM 442.932 (OM 442)	V8cyl.	15080cc	195kW (265PS)	Diesel	TD6066
OM 442.933 (OM 442)	V8cyl.	15080cc	195kW (265PS)	Diesel	TD6067
OM 442.934 (OM 442)	V8cyl.	15080cc	195kW (265PS)	Diesel	TD6324
OM 442.935 (OM 442)	V8cyl.	15080cc	195kW (265PS)	Diesel	TD6102
OM 442.939 (OM 442)	V8cyl.	15080cc	213-218kW (290-296PS)	Diesel	TD6319
OM 443.905 (OM 443)	V10cyl.	18848cc	271kW (369PS)	Diesel	TD16981

08-743200-00 eng.512444 → [R45160]	STD	130.00	3.000		001 MOL P	KV1
			3.000		005 IWU CR P	IKA
			4.000		231 CR P	STD



23

OM 442		V8cyl.	15080cc	191-218kW (260-296PS)	Diesel	FM7011
OM 443		V10cyl.	18848cc	265kW (360PS)	Diesel	FM6638
08-742300-00 →eng.512443	STD	130.00	3.000		008 MOL P	KV1
			3.000		005 IWU CR P	IKA
			4.000		231 CR P	STD
08-742300-20 →eng.512443	STD	130.00	3.000		008 MOL	KV1
			3.000		005 IWU CR	IKA
			4.000		231 CR	STD

24

OM 444		V12cyl.	22618cc		Diesel	FM6641
08-742300-00 eng.512444→	STD	130.00	3.000		008 MOL P	KV1
			3.000		005 IWU CR P	IKA
			4.000		231 CR P	STD
08-742300-20 →eng.512443	STD	130.00	3.000		008 MOL	KV1
			3.000		005 IWU CR	IKA
			4.000		231 CR	STD

25

OM 521.940 Euro 2 (OM 501 LA)	V6cyl.	11946cc	315kW (428PS)	Diesel	Turbo Intercooled	TD16791
OM 521.950 Euro 2 (OM 501 LA)	V6cyl.	11946cc	260kW (354PS)	Diesel	Turbo Intercooled	TD17671
OM 522.940 Euro 2 (OM 502 LA)	V8cyl.	15928cc	420kW (571PS)	Diesel	Turbo Intercooled	TD16800
OM 522.941 Euro 2 (OM 502 LA)	V8cyl.	15928cc	413kW (562PS)	Diesel	Turbo Intercooled	TD17672
OM 522.942 Euro 2 (OM 502 LA)	V8cyl.	15928cc	362kW (492PS)	Diesel	Turbo Intercooled	TD17673
OM 522.943 Euro 2 (OM 502 LA)	V8cyl.	15928cc	362kW (492PS)	Diesel	Turbo Intercooled	TD17674
OM 522.950 Euro 2 (OM 502 LA)	V8cyl.	15928cc	530kW (721PS)	Diesel	Turbo Intercooled	TD22822
OM 541.920 Euro 2 (OM 501 LA)	V6cyl.	11946cc	230kW (313PS)	Diesel	Turbo Intercooled	TD7872
OM 541.921 Euro 2 (OM 501 LA)	V6cyl.	11946cc	315kW (428PS)	Diesel	Turbo Intercooled	TD9673
OM 541.922 Euro 2 (OM 501 LA)	V6cyl.	11946cc	260kW (354PS)	Diesel	Turbo Intercooled	TD7873
OM 541.923 Euro 2 (OM 501 LA)	V6cyl.	11946cc	290kW (394PS)	Diesel	Turbo Intercooled	TD7874
OM 541.924 Euro 2 (OM 501 LA)	V6cyl.	11946cc	290kW (394PS)	Diesel	Turbo Intercooled	TD7880
OM 541.925 Euro 2 (OM 501 LA)	V6cyl.	11946cc	315kW (428PS)	Diesel	Turbo Intercooled	TD7875
OM 541.926 Euro 2 (OM 501 LA)	V6cyl.	11946cc	230kW (313PS)	Diesel	Turbo Intercooled	TD7879
OM 541.927 Euro 2 (OM 501 LA)	V6cyl.	11946cc	260kW (354PS)	Diesel	Turbo Intercooled	TD9679
OM 541.928 Euro 2 (OM 501 LA)	V6cyl.	11946cc	315kW (428PS)	Diesel	Turbo Intercooled	TD17679
OM 542.925 Euro 2 (OM 502 LA)	V8cyl.	15928cc	350kW (476PS)	Diesel	Turbo Intercooled	TD9683
OM 941.910 Euro 2 (OM 501 LA)	V6cyl.	11946cc	230kW (313PS)	Diesel	Turbo Intercooled	TD17693
OM 941.920 Euro 2 (OM 501 LA)	V6cyl.	11946cc	260kW (354PS)	Diesel	Turbo Intercooled	TD16793
OM 941.921 Euro 2 (OM 501 LA)	V6cyl.	11946cc	260kW (354PS)	Diesel	Turbo Intercooled	TD17694





OM 941.929 Euro 2 (OM 501 LA)	V6cyl.	11946cc	290kW (394PS)	Diesel	Turbo Intercooled	TD16794
OM 941.930 Euro 2 (OM 501 LA)	V6cyl.	11946cc	300kW (408PS)	Diesel	Turbo Intercooled	TD16795
OM 941.940 Euro 2 (OM 501 LA)	V6cyl.	11946cc	300kW (428PS)	Diesel	Turbo Intercooled	TD16796
OM 941.960 Euro 2 (OM 501 LA)	V6cyl.	11946cc	230kW (313PS)	Diesel	Turbo Intercooled	TD16797
OM 941.970 Euro 2 (OM 501 LA)	V6cyl.	11946cc	260kW (354PS)	Diesel	Turbo Intercooled	TD16798
OM 941.980 Euro 2 (OM 501 LA)	V6cyl.	11946cc	290kW (394PS)	Diesel	Turbo Intercooled	TD17695
OM 941.981 Euro 2 (OM 501 LA)	V6cyl.	11946cc	290-315kW (394-428PS)	Diesel	Turbo Intercooled	TD17696
OM 941.990 Euro 2 (OM 501 LA)	V6cyl.	11946cc	315kW (428PS)	Diesel	Turbo Intercooled	TD16799
OM 942.900 Euro 2 (OM 502 LA)	V8cyl.	15928cc	350kW (470PS)	Diesel	Turbo Intercooled	TD17697
OM 942.910 Euro 2 (OM 502 LA)	V8cyl.	15928cc	350kW (470PS)	Diesel	Turbo Intercooled	TD17698
OM 942.911 Euro 2 (OM 502 LA)	V8cyl.	15928cc	350kW (470PS)	Diesel	Turbo Intercooled	TD16801
OM 942.912 Euro 2 (OM 502 LA)	V8cyl.	15928cc	350kW (470PS)	Diesel	Turbo Intercooled	TD17699
OM 942.925 Euro 2 (OM 502 LA)	V8cyl.	15928cc	400kW (544PS)	Diesel	Turbo Intercooled	TD17700
OM 942.930 Euro 2 (OM 502 LA)	V8cyl.	15928cc	420kW (571PS)	Diesel	Turbo Intercooled	TD16802
OM 942.960 Euro 2 (OM 502 LA)	V8cyl.	15928cc	350kW (470PS)	Diesel	Turbo Intercooled	TD17701
OM 942.967 Euro 2 (OM 502 LA)	V8cyl.	15928cc	370-380kW (503-517PS)	Diesel	Turbo Intercooled	TD17702
OM 942.970 Euro 2 (OM 502 LA)	V8cyl.	15928cc	390kW (530PS)	Diesel	Turbo Intercooled	TD17703
OM 942.980 Euro 2 (OM 502 LA)	V8cyl.	15928cc	420kW (571PS)	Diesel	Turbo Intercooled	TD16803
OM 942.990 Euro 2 (OM 502 LA)	V8cyl.	15928cc	330-448kW (570-609PS)	Diesel	Turbo Intercooled	TD17704

08-137100-00 ¹ STD	130.00	3.000		008 CK	ST
		3.000		005 IWU CR P	GOE13
		4.000		231 CK P	GOE13
08-289600-00 ² STD [R60350]	130.00	3.000		008 CK	ST
		3.000		005 IWU CR P	IKA
		4.000		231 CR P	STD

¹ OE 541 030 0224

¹ OE 541 030 0224

¹ OE 541 030 0224

¹ OE 541 030 0224

² OE 541 030 0024

² OE 541 030 0024

² OE 541 030 0024







² OE 541 030 0024

OM 522 LA Euro 2	V8cyl.	15928cc	362-420kW (496-570PS)	Diesel	Turbo Intercooled	FM15588
08-145900-00 STD	130.00	3.000		008 CK	ST	
		3.000		005 CR P	IKA	
		4.000		231 CR P	STD	

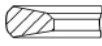

27

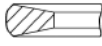
OM 541.942 Euro 3 (OM 501 LA)	V6cyl.	11946cc	260-265kW (354-360PS)	Diesel	Turbo Intercooled	TD16899
OM 541.943 Euro 3 (OM 501 LA)	V6cyl.	11946cc	260-265kW (354-360PS)	Diesel	Turbo Intercooled	TD16900
OM 541.944 Euro 3 (OM 501 LA)	V6cyl.	11946cc	290-335kW (394-456PS)	Diesel	Turbo Intercooled	TD16901
OM 541.945 Euro 3 (OM 501 LA)	V6cyl.	11946cc	290-300kW (394-408PS)	Diesel	Turbo Intercooled	TD16902
OM 541.946 Euro 3 (OM 501 LA)	V6cyl.	11946cc	315-320kW (428-435PS)	Diesel	Turbo Intercooled	TD16903
OM 541.947 Euro 3 (OM 501 LA)	V6cyl.	11946cc	315-320kW (428-435PS)	Diesel	Turbo Intercooled	TD16904
OM 541.948 Euro 3 (OM 501 LA)	V6cyl.	11946cc	335kW (456PS)	Diesel	Turbo Intercooled	TD16913
OM 541.949 Euro 3 (OM 501 LA)	V6cyl.	11946cc	335kW (456PS)	Diesel	Turbo Intercooled	TD16914
OM 541.950 Euro 3 (OM 501 LA)	V6cyl.	11946cc	260-300kW (354-408PS)	Diesel	Turbo Intercooled	TD17682
OM 541.978 Euro 3 (OM 501 LA)	V6cyl.	11946cc	350kW (476PS)	Diesel	Turbo Intercooled	TD21007
OM 541.980 Euro 3 (OM 501 LA)	V6cyl.	11946cc	335kW (456PS)	Diesel	Turbo Intercooled	TD21000
OM 541.981 Euro 3 (OM 501 LA)	V6cyl.	11946cc	335kW (456PS)	Diesel	Turbo Intercooled	TD21003
OM 542.940 Euro 3 (OM 502 LA)	V8cyl.	15928cc	350kW (476PS)	Diesel	Turbo Intercooled	TD16908
OM 542.940 Euro 3 (OM 502 LA)	V8cyl.	15928cc	370-375kW (503-510PS)	Diesel	Turbo Intercooled	TD16909
OM 542.941 Euro 3 (OM 502 LA)	V8cyl.	15928cc	350kW (476PS)	Diesel	Turbo Intercooled	TD16910
OM 542.941 Euro 3 (OM 502 LA)	V8cyl.	15928cc	370kW (503PS)	Diesel	Turbo Intercooled	TD16911
OM 542.942 Euro 3 (OM 502 LA)	V8cyl.	15928cc	390-395kW (530-537PS)	Diesel	Turbo Intercooled	TD16906
OM 542.943 Euro 3 (OM 502 LA)	V8cyl.	15928cc	390-395kW (530-537PS)	Diesel	Turbo Intercooled	TD16907
OM 542.944 Euro 3 (OM 502 LA)	V8cyl.	15928cc	420-425kW (571-578PS)	Diesel	Turbo Intercooled	TD16912
OM 542.945 Euro 3 (OM 502 LA)	V8cyl.	15928cc	420-425kW (571-578PS)	Diesel	Turbo Intercooled	TD17689
OM 542.948 Euro 3 (OM 502 LA)	V8cyl.	15928cc	320-370kW (435-503PS)	Diesel	Turbo Intercooled	TD17655
OM 542.956 Euro 3 (OM 502 LA)	V8cyl.	15928cc	448kW (609PS)	Diesel	Turbo Intercooled	TD17691
OM 542.957 Euro 3 (OM 502 LA)	V8cyl.	15928cc	448kW (609PS)	Diesel	Turbo Intercooled	TD17692

08-136000-00 ① STD [R67938]	130.00	3.000		008 IF CK	ST
		3.000		005 IWU CR P	GOE13
		4.000		231 LKZ CK P	GOE13
					
08-137100-00 ② STD	130.00	3.000		008 CK	ST
		3.000		005 IWU CR P	GOE13
		4.000		231 CK P	GOE13

① OE 541 030 0424

① OE 541 030 0424

① OE 541 030 0424

① OE 541 030 0424

② OE 541 030 0224

② OE 541 030 0224

② OE 541 030 0224

② OE 541 030 0224



28

OM 541.970 Euro 4 (OM 501 LA)	V6cyl.	11946cc	235kW (320PS)	Diesel	Turbo Intercooled	TD19250
OM 541.972 Euro 4 (OM 501 LA)	V6cyl.	11946cc	265kW (360PS)	Diesel	Turbo Intercooled	TD19251
OM 541.973 Euro 4 (OM 501 LA)	V6cyl.	11946cc	265kW (360PS)	Diesel	Turbo Intercooled	TD21022
OM 541.974 Euro 4 (OM 501 LA)	V6cyl.	11946cc	300kW (408PS)	Diesel	Turbo Intercooled	TD18997
OM 541.975 Euro 4 (OM 501 LA)	V6cyl.	11946cc	300kW (408PS)	Diesel	Turbo Intercooled	TD21023
OM 541.976 Euro 4 (OM 501 LA)	V6cyl.	11946cc	320kW (435PS)	Diesel	Turbo Intercooled	TD19000
OM 541.977 Euro 4 (OM 501 LA)	V6cyl.	11946cc	320kW (435PS)	Diesel	Turbo Intercooled	TD21024
OM 542.960 Euro 5	V8cyl.	15928cc	375kW (510PS)	Diesel	Turbo Intercooled	TD19999
OM 542.961 Euro 5	V8cyl.	15928cc	375kW (510PS)	Diesel	Turbo Intercooled	TD21026
OM 542.962 Euro 5 (OM 502 LA)	V8cyl.	15928cc	405kW (551PS)	Diesel	Turbo Intercooled	TD18840
OM 542.963 Euro 5 (OM 502 LA)	V8cyl.	15928cc	405kW (551PS)	Diesel	Turbo Intercooled	TD21025
OM 542.964 Euro 5	V8cyl.	15928cc	440kW (598PS)	Diesel	Turbo Intercooled	TD20000

08-420900-00 STD	130.00	3.000		008 IF GDC	ST
		3.000		005 IWU CR P	GOE12
		4.000		231 LKZ GDC P	KV1
OE 541 030 0624	OE 541 030 0624		OE 541 030 0624	OE 541 030 0624	

29

OM 471.900 (OM 471 LA)	6cyl.	12800cc	310kW (422PS)	Diesel	Turbo Intercooled	TD25519
OM 471.909 Euro 5 (OM 471 LA)	6cyl.	12809cc	310-375kW (422-510PS)	Diesel	Turbo Intercooled	TD28082

08-440600-00 STD	132.00	3.500		008 GDC NT	ST
		2.500		005 IWU CR P	KV4
		3.500		231 LKZ GDC P	KV1

Modelverzeichnis • Index de modele • Índice de Modelo
Indeks modelu • Модель автомобиля • دليل المحرك

MODEL INDEX



CCM



03/03→05/05	Express Box 1.4	14 K4F	Petrol	1396	4	5
03/03→05/05	Express Box 1.8	18 K4F (K Series)	Petrol	1796	4	6
03/03→05/05	Express Box 160	18 K4K (VVC)	Petrol	1796	4	6
01/82→12/87	MG Metro 1300	A+ Series	Petrol	1275	4	3
03/02→	MG TF 120	18 K4F (K Series)	Petrol	1796	4	6
03/02→	MG TF 135	18 K4F (K Series)	Petrol	1796	4	6
03/02→	MG TF 160	18 K4K (VVC)	Petrol	1796	4	6
06/01→04/05	MG ZR 105	14 K4F	Petrol	1396	4	5
06/01→04/05	MG ZR 120	18 K4F (K Series)	Petrol	1796	4	6
06/01→04/05	MG ZR 160	18 K4K (VVC)	Petrol	1796	4	6
07/01→04/05	MG ZS 120	18 K4F (K Series)	Petrol	1796	4	6
07/01→04/05	MG ZS 180	25 K4F	Petrol	2497	V6	7
07/01→10/05	MG ZS Hatchback 120	18 K4F (K Series)	Petrol	1796	4	6
07/01→10/05	MG ZS Hatchback 180	25 K4F	Petrol	2497	V6	7
01/03→07/05	MG ZT 1.8 16V	18 K4F (K Series)	Petrol	1796	4	6
06/01→07/05	MG ZT 160	25 K4F	Petrol	2497	V6	7
01/03→07/05	MG ZT 180	25 K4F	Petrol	2497	V6	7
06/01→07/05	MG ZT 190	25 K4F	Petrol	2497	V6	7
01/03→07/05	MG ZT- T 1.8 16V	18 K4F (K Series)	Petrol	1796	4	6
10/01→07/05	MG ZT- T 160	25 K4F	Petrol	2497	V6	7
01/03→07/05	MG ZT- T 180	25 K4F	Petrol	2497	V6	7
10/01→07/05	MG ZT- T 190	25 K4F	Petrol	2497	V6	7
01/68→12/70	MGC	C Series	Petrol	2912	6	8
01/68→12/70	MGC GT	C Series	Petrol	2912	6	8
10/01→03/02	MGF 1.8 i VVC	18 K4K (VVC)	Petrol	1796	4	6
03/95→03/02	MGF 1.8 i 16V	18 K4F (K Series)	Petrol	1796	4	6
03/95→03/02	MGF 1.8 i VVC	18 K4K (VVC)	Petrol	1796	4	6
01/61→12/66	Midget Mk I	A Series	Petrol	948	4	1
01/61→12/66	Midget Mk II	A Series	Petrol	948	4	1
01/67→12/73	Midget Mk II	A Series	Petrol	1275	4	2
01/67→12/73	Midget Mk III	A Series (1275cc Overbored To 1380cc)	Petrol	1380	4	4
01/68→12/72	Mk II 1300	A Series	Petrol	1275	4	2

Motorverzeichnis • Index de moteur • Índice de Motor
Indeks silnika • Модель двигателя • دليل المحرك

ENGINE INDEX



CCM



14 K4F	Petrol	1396	4	75.00	5
18 K4F (K Series)	Petrol	1796	4	80.00	6
18 K4K (VVC)	Petrol	1796	4	80.00	6
25 K4F	Petrol	2497	V6	80.00	7
A Series	Petrol	1275	4	70.62	2
A Series	Petrol	948	4	62.92	1
A Series (1275cc Overbored To 1380cc)	Petrol	1380	4	73.50	4
A+ Series	Petrol	1275	4	70.62	3
C Series	Petrol	2912	6	83.32	8



Midget Mk I, Midget Mk II	01/61→12/66	A Series	4cyl. 948cc	1
				FM73

08-529700-00	STD	62.92	1.780		001 P	GOE12
<i>[R8576]</i>			1.780		005 P	GOE12
			1.780		005 P	GOE12
			3.175		030 P	GOE12

Midget Mk II Mk II 1300	01/67→12/73 01/68→12/72	A Series	4cyl. 1275cc	2
				FM1176

08-106700-00	STD	70.62	1.600		001 CR P	STD
<i>[R21576V1]</i>			1.600		001 IF P	STD
			1.600		023 P	STD
			3.950		231 CR P	STD
08-521700-00	STD	70.62	1.488		001 P	IKA
08-521707-00	.020		1.488		026 P	STD
08-521711-00	.040		4.000		231 P	STD
08-521714-00	.060					
<i>[R35960]</i>						
08-524100-00	STD	70.62	1.500		001 NT	KV1
08-524107-00	.020		1.500		026 P	GOE12
08-524111-00	.040		3.000		231 P	GOE12
08-524114-00	.060					
<i>[R41570]</i>						

MG Metro 1300	01/82→12/87	A+ Series	4cyl. 1275cc	3
				FM2934

08-524100-00	STD	70.62	1.500		001 NT	KV1
08-524107-00	.020		1.500		026 P	GOE12
08-524111-00	.040		3.000		231 P	GOE12
08-524114-00	.060					
<i>[R41570]</i>						

Midget Mk III	01/67→12/73	A Series (1275cc Overbored To 1380cc)	4cyl. 1380cc	4
				FM1180

08-526600-00	STD	73.50	1.500		001 CR P	IKA
<i>[R39390]</i>			1.500		026 P	IKA
			4.000		232 CR P	GOE12



Express Box 1.4 MG ZR 105	03/03→05/05 06/01→04/05	14 K4F	4cyl. 1396cc	76kW (103PS)	5
					TD18866

08-520500-00	STD	75.00	1.000		001	ST
<i>[R49650]</i>			1.200		026	F12/F14
			2.000		712 NT	ST

Express Box 1.8 MG TF 120, MG TF 135 MG ZR 120 MG ZS 120 MG ZS Hatchback 120 MG ZT 1.8 16V, MG ZT- T 1.8 16V MGF 1.8 i 16V	03/03→05/05 03/02→ 06/01→04/05 07/01→04/05 07/01→10/05 01/03→07/05 03/95→03/02	18 K4F (K Series)	4cyl. 1796cc	88kW (120PS)	6
					TD18234

Express Box 160 MG TF 160 MG ZR 160 MGF 1,8 i VVC MGF 1.8 i VVC	03/03→05/05 03/02→ 06/01→04/05 10/01→03/02 03/95→03/02	18 K4K (VVC)	4cyl. 1796cc	118kW (160PS)	
					TD18235

08-522700-00	STD	80.00	1.000		001 CR	ST
<i>[R49540]</i>			1.200		026 P	STD
			2.000		712 CR	ST

MG ZS 180 MG ZS Hatchback 180 MG ZT 160 MG ZT 180 MG ZT 190 MG ZT- T 160 MG ZT- T 180 MG ZT- T 190	07/01→04/05 07/01→10/05 06/01→07/05 01/03→07/05 06/01→07/05 10/01→07/05 01/03→07/05 10/01→07/05	25 K4F	V6cyl. 2497cc	118-140kW (160-190PS)	7
					TD18236

08-521600-00	STD	80.00	1.200		008 CR	STD
<i>[R49740]</i>			1.500		026	STD
			2.500		712 CR	ST

MGC, MGC GT	01/68→12/70	C Series	6cyl. 2912cc		8
					FM1186

08-530100-00	STD	83.32	1.984		005 P	STD
08-530107-00	.020		1.984		005 P	STD
08-530109-00	.030		1.984		005 P	STD
			4.740		231	STD
			4.762		031 P	STD



Mini One D	06/03→09/06	1ND	4cyl. 1364cc 55kW (75PS)	1
		Diesel	Turbo Intercooled	TD18565

Mini One D	06/03→09/06	1ND-TV	4cyl. 1364cc 55-65kW (75-88PS)	TD22098
		Diesel	Turbo Intercooled	

08-898400-00	STD	73.00	1.500		001 NT	ST
08-898407-00	0.50mm		1.500		005 CR	STD
			3.000		231 NT	ST

Mini Cooper D	03/07→	9HZ (DV6TED4)	4cyl. 1560cc 80kW (109PS)	2
Mini One D	06/09→07/10			
Mini Clubman Cooper D	10/07→			
		Diesel	Turbo Intercooled	TD20982

08-424000-00	STD	75.00	3.000		008 CK P	KV1
08-424007-00	0.50mm		1.950		005 P	F12/F14
08-424008-00	0.60mm		2.500		231 LKZ CR P	GOE12

Mini Cooper, Mini One	06/01→09/06	W10B16A	4cyl. 1598cc 66-85kW (90-116PS)	3
MINI Convertible Cooper,	07/04→11/07			
MINI Convertible One				
				TD18563

08-433500-00	STD	77.00	1.200		001 NT	ST
08-433505-00	0.25mm		1.200		026 P	STD
08-433507-00	0.50mm		2.500		712 CR	ST



CCM

x



9

01/78→	Bus 11.15	6 D 22 A	Diesel	11149	6	15
10/78→	Canter	4D30	Diesel	3297	4	12
10/89→	Canter 3.9 TD	4D34-T	Diesel	3907	4	14
10/89→	Canter 3.9 TD	4D34-TL	Diesel	3907	4	14
07/86→	Canter 60	4D31T	Diesel	3298	4	13
08/96→	Canter 60	4D34-1ATA Euro 2	Diesel	3908	4	14
10/97→	Canter 75	4D34-1ATA Euro 2	Diesel	3908	4	14
	Canter FE7-136	4D34-1ATA Euro 2	Diesel	3908	4	14
	Canter FE155F4	4D34-1ATA Euro 2	Diesel	3908	4	14
09/92→09/96	Canter Platform/Chassis 2.5 D	4 D 56 (8V)	Diesel	2477	4	9
06/06→	Canter Platform/Chassis 3.9	4D34-1ATA Euro 2	Diesel	3908	4	14
10/96→07/01	Canter Platform/Chassis 3.9 TDI	4D34-1ATA Euro 2	Diesel	3908	4	14
01/77→06/81	Celeste 1.6 ST	4G32	Petrol	1597	4	2
01/78→	Cement Tanker 11.15	6 D 22 A	Diesel	11149	6	15
09/84→04/88	Colt II 1.5 GLX	4 G 15	Petrol	1468	4	1
09/85→04/88	Colt II 1.5 GLX	G15B	Petrol	1468	4	1
02/84→04/88	Colt II 1.6 Turbo ECi	4 G 32 T/C	Petrol	1597	4	2
02/84→04/88	Colt II 1.8 GL Diesel	4 D 65	Diesel	1796	4	4
04/88→05/92	Colt III 1.8 Diesel GLX	4 D 65	Diesel	1796	4	4
08/04→	Colt VI 1.5 DI-D	OM 639.939 Euro 4	Diesel	1493	3	7
01/78→	Concrete Mixer 11.15	6 D 22 A	Diesel	11149	6	15
10/82→12/86	Cordia 1.6 GSL	4G32	Petrol	1597	4	2
01/78→	Crane Truck 11.15	6 D 22 A	Diesel	11149	6	15
11/11→	Delica 1.6	HR16DE	Petrol	1598	4	3
01/78→	Dump Truck 11.15	6 D 22 A	Diesel	11149	6	15
01/78→	Forklift 11.15 40T	6 D 22 A	Diesel	11149	6	15
01/77→08/80	Galant I 1.6	4G32	Petrol	1597	4	2
01/79→08/80	Galant I Station Wagon 1.6 GL	4G32	Petrol	1597	4	2
09/80→05/84	Galant II 1.6 GLX	4G32	Petrol	1597	4	2
09/80→05/84	Galant II 2.3 Turbo-D	4 D 55 T	Diesel	2346	4	10
09/80→05/84	Galant II Station Wagon 1.6 GLX	4G32	Petrol	1597	4	2
07/83→05/84	Galant II Station Wagon 2.3 Turbo-D	4 D 55 T	Diesel	2346	4	10
06/84→04/90	Galant III 1.6 GLX	4G32	Petrol	1597	4	2
06/84→04/90	Galant III 1.8 Turbo-D	4 D 65 T	Diesel	1796	4	5
11/88→10/92	Galant IV 1.8 Turbo-D	4 D 65 T	Diesel	1796	4	5
01/88→10/92	Galant IV Saloon 1.6	4G32	Petrol	1597	4	2
01/88→10/92	Galant IV Saloon 1.8 D	4 D 65	Diesel	1796	4	4
12/87→10/92	Galant IV Saloon 1.8 Turbo-D	4 D 65 T	Diesel	1796	4	5
	Industrial	MG500	Diesel	9955	6	16
03/80→10/96	L 200 1.6	4G32	Petrol	1597	4	2
01/83→10/86	L 200 2.3 D 4WD	4 D 55	Diesel	2347	4	9
11/86→12/07	L 200 2.5 D	4 D 56 (8V)	Diesel	2477	4	9
12/87→05/93	L 200 2.5 D 4WD	4 D 56 (8V)	Diesel	2477	4	9
11/05→	L 200 2.5 DiD	4 D 56 HP	Diesel	2477	4	11
08/07→	L 200 2.5 DI-D	4 D 56 HP	Diesel	2477	4	11
11/05→	L 200 2.5 DI-D 4WD	4 D 56 HP	Diesel	2477	4	11
08/01→11/05	L 200 2.5 TD	4 D 56 T	Diesel	2476	4	10
11/92→12/07	L 200 2.5 TD 4WD	4 D 56 T	Diesel	2476	4	10
06/96→12/07	L 200 2.5 TD 4WD	4 D 56 TD	Diesel	2477	4	10
10/86→10/96	L 200 Platform/Chassis 2.5 D	4 D 56 (8V)	Diesel	2477	4	9
12/86→10/96	L 200 Platform/Chassis 2.5 D 4WD	4 D 56 (8V)	Diesel	2477	4	9
04/10→	L 200 Platform/Chassis 2.5 DI-D 4WD	4 D 56 HP	Diesel	2477	4	11
09/90→10/96	L 200 Platform/Chassis 2.5 TD	4 D 56 T	Diesel	2476	4	10
02/80→05/94	L 300 Box 1.6	4G32	Petrol	1597	4	2
09/83→10/86	L 300 Box 2.3 D	4 D 55	Diesel	2347	4	9
11/86→02/06	L 300 Box 2.5 D	4 D 56 (8V)	Diesel	2477	4	9
02/87→08/97	L 300 Box 2.5 TD	4 D 56 T	Diesel	2476	4	10
11/91→05/03	L 300 Box 2.5 TD 4WD	4 D 56 T	Diesel	2476	4	10
05/80→	L 300 Bus 1.6	4G32	Petrol	1597	4	2
04/83→10/86	L 300 Bus 2.3 D	4 D 55	Diesel	2347	4	9

MODEL INDEX

Modelverzeichnis • Index de modele • Índice de Modelo
Indeks modelu • Модель автомобиля • دليل الموديل



CCM

x



9

11/86→	L 300 Bus 2.5 D	4 D 56 (8V)	Diesel	2477	4	9
02/87→05/03	L 300 Bus 2.5 TD	4 D 56 T	Diesel	2476	4	10
09/94→	L 300 Bus 2.5 TD	4 D 56 TD	Diesel	2477	4	10
11/88→	L 300 Bus 2.5 TD 4WD	4 D 56 T	Diesel	2476	4	10
04/83→04/94	L 300 Platform/Chassis 1.6	4G32	Petrol	1597	4	2
11/86→04/94	L 300 Platform/Chassis 2.5 D	4 D 56 (8V)	Diesel	2477	4	9
11/94→04/00	L 300 Platform/Chassis 2.5 TD	4 D 56 T	Diesel	2476	4	10
05/95→05/00	L 400 / Space Gear Bus 2.5 TD 4WD	4 D 56 TD	Diesel	2477	4	10
05/95→05/00	L 400 / Space Gear Bus 2.5 TD	4 D 56 TD	Diesel	2477	4	10
05/95→06/05	L 400 / Space Gear Bus 2500 TD	4 D 56 T	Diesel	2476	4	10
06/96→10/02	L 400 Box 1.6	4G32	Petrol	1597	4	2
09/96→06/05	L 400 Box 2500 TD	4 D 56 T	Diesel	2476	4	10
09/96→06/05	L 400 Box 2500 TD 4WD	4 D 56 T	Diesel	2476	4	10
09/08→	Lancer Estate 1.6 4WD	HR16DE	Petrol	1598	4	3
11/83→04/88	Lancer III 1.5 GLX	4 G 15	Petrol	1468	4	1
06/85→04/88	Lancer III 1.5 GLX	G15B	Petrol	1468	4	1
01/84→04/88	Lancer III 1.8 Diesel	4 D 65	Diesel	1796	4	4
09/85→12/87	Lancer III Station Wagon 1.5	4 G 15	Petrol	1468	4	1
09/85→08/89	Lancer III Station Wagon 1.5	G15B	Petrol	1468	4	1
09/85→06/92	Lancer III Station Wagon 1.8 D	4 D 65	Diesel	1796	4	4
10/86→10/88	Lancer III Station Wagon 1.8 D 4WD	4 D 65	Diesel	1796	4	4
04/88→05/92	Lancer IV 1.8 D	4 D 65	Diesel	1796	4	4
04/88→05/92	Lancer IV Saloon 1.8 GLX Diesel	4 D 65	Diesel	1796	4	4
01/08→	Lancer Saloon 2.0 DI-D	BKD	Diesel	1968	4	6
06/08→	Lancer SPORTBACK 2.0 DI-D	BKD	Diesel	1968	4	6
10/83→06/90	Mirage Hatchback 1.5	G15B	Petrol	1468	4	1
05/88→06/90	Mirage Hatchback 1.5 E	G15B	Petrol	1468	4	1
10/83→01/88	Mirage Hatchback 1.8 D	4 D 65	Diesel	1796	4	4
10/83→11/91	Mirage Saloon 1.5	G15B	Petrol	1468	4	1
05/88→11/91	Mirage Saloon 1.5 4WD	G15B	Petrol	1468	4	1
05/88→11/91	Mirage Saloon 1.8 D	4 D 65	Diesel	1796	4	4
05/88→11/91	Mirage Saloon 1.8 D 4WD	4 D 65	Diesel	1796	4	4
12/91→08/95	Mirage Saloon 1.8 TD	4 D 65 T	Diesel	1796	4	5
12/91→08/95	Mirage Saloon 1.8 TD 4WD	4 D 65 T	Diesel	1796	4	5
08/07→	Outlander II 2.2 DI-D 4WD	4HK	Diesel	2179	4	8
08/07→	Outlander II 2.2 DI-D 4WD	4HN	Diesel	2179	4	8
08/07→	Outlander II 2.2 Di-D 4WD	HTH	Diesel	2179	4	8
07/02→	Pajero CLASSIC 2.5 TD	4 D 56 T	Diesel	2476	4	10
10/84→09/86	Pajero I 2.3 D	4 D 55	Diesel	2347	4	9
11/89→12/91	Pajero I 2.5 TD	4 D 56 T	Diesel	2476	4	10
10/86→05/91	Pajero I 2.5 TD 4WD	4 D 56 T	Diesel	2476	4	10
12/82→04/86	Pajero I Canvas Top 2.3 TD	4 D 55 T	Diesel	2346	4	10
05/86→11/90	Pajero I Canvas Top 2.5 TD	4 D 56 T	Diesel	2476	4	10
12/90→10/99	Pajero II 2.5 TD 4WD	4 D 56 TD	Diesel	2477	4	10
03/91→08/99	Pajero II 2.5 TDiC	4 D 56 T	Diesel	2476	4	10
12/90→04/00	Pajero II Canvas Top 2.5 TD 4WD	4 D 56 TD	Diesel	2477	4	10
03/91→08/99	Pajero II Canvas Top 2.5 TDiC	4 D 56 T	Diesel	2476	4	10
04/00→12/06	Pajero III 2.5 TDi	4 D 56 T	Diesel	2476	4	10
04/00→12/06	Pajero III Canvas Top 2.5 TDi	4 D 56 T	Diesel	2476	4	10
11/98→	Pajero SPORT 2.5 TD	4 D 56 T	Diesel	2476	4	10
11/97→10/98	Pajero SPORT 2.5 TD 4WD	4 D 56 T	Diesel	2476	4	10
07/08→	Pajero SPORT II 2.5 DI-D	4 D 56 HP	Diesel	2477	4	11
07/08→	Pajero SPORT II 2.5 DI-D 4WD	4 D 56 HP	Diesel	2477	4	11
09/08→	Pajero SPORT II 2.5 TD	4 D 56 T	Diesel	2476	4	10
12/99→01/08	Pajero SPORT VAN 2.5 TD	4 D 56 T	Diesel	2476	4	10
10/89→	Rosa 3.9 TD	4D34-T	Diesel	3907	4	14
10/89→	Rosa 3.9 TD	4D34-TL	Diesel	3907	4	14
12/83→	Rosa Bus	4D31	Diesel	3298	4	12
04/78→07/80	Sapporo I 1.6 SL, GL	4G32	Petrol	1597	4	2
08/80→09/84	Sapporo II 1.6 GLX	4G32	Petrol	1597	4	2

Modelverzeichnis • Index de modele • Índice de Modelo
Indeks modelu • Модель автомобиля • دليل المركب

MODEL INDEX



CCM

x



9

10/77→09/85	Sigma 1.6	4G32	Petrol	1597	4	2
06/86→10/98	Space Wagon 1.8 TD	4 D 65 T	Diesel	1796	4	5
01/78→	Tank Truck 11.15	6 D 22 A	Diesel	11149	6	15
01/78→	Tractor 11.15	6 D 22 A	Diesel	11149	6	15
09/82→10/87	Tredia GLS 1.6	4G32	Petrol	1597	4	2
01/78→	Truck 11.15	6 D 22 A	Diesel	11149	6	15
08/79→	Truck 11.15	6 D 22 T	Diesel	11149	6	15

Motorverzeichnis • Index de moteur • Índice de Motor
Indeks silnika • Модель двигателя • دليل المحرك

ENGINE INDEX



CCM

x



9

4 D 55	Diesel	2347	4	91.10	9
4 D 55 T	Diesel	2346	4	91.10	10
4 D 56 (8V)	Diesel	2477	4	91.10	9
4 D 56 HP	Diesel	2477	4	91.10	11
4 D 56 T	Diesel	2476	4	91.10	10
4 D 56 TD	Diesel	2477	4	91.10	10
4 D 65	Diesel	1796	4	80.60	4
4 D 65 T	Diesel	1796	4	80.60	5
4 G 15	Petrol	1468	4	75.50	1
4 G 32 T/C	Petrol	1597	4	76.90	2
4D30	Diesel	3297	4	100.00	12
4D31	Diesel	3298	4	100.00	12
4D31T	Diesel	3298	4	100.00	13
4D34-1ATA Euro 2	Diesel	3908	4	104.00	14
4D34-T	Diesel	3907	4	104.00	14
4D34-TL	Diesel	3907	4	104.00	14
4G32	Petrol	1597	4	76.90	2
4HK	Diesel	2179	4	85.00	8
4HN	Diesel	2179	4	85.00	8
6 D 22 A	Diesel	11149	6	130.00	15
6 D 22 T	Diesel	11149	6	130.00	15
BKD	Diesel	1968	4	81.00	6
G15B	Petrol	1468	4	75.50	1
HR16DE	Petrol	1598	4	78.00	3
HTH	Diesel	2179	4	85.00	8
MG500	Diesel	9955	6	130.00	16
OM 639.939 Euro 4	Diesel	1493	3	83.00	7



Colt II 1.5 GLX	09/84→04/88	4 G 15							1
Lancer III 1.5 GLX	11/83→04/88		4cyl.						
Lancer III Station Wagon 1.5	09/85→12/87		1468cc	55kW (75PS)					
TD2307									

Colt II 1.5 GLX	09/85→04/88	G15B							
Lancer III 1.5 GLX	06/85→04/88		4cyl.						
Lancer III Station Wagon 1.5	09/85→08/89		1468cc	51-57kW (70-78PS)					
Mirage Hatchback 1.5	10/83→06/90								
Mirage Hatchback 1.5 E	05/88→06/90								
Mirage Saloon 1.5	10/83→11/91								
Mirage Saloon 1.5 4WD	05/88→11/91								TD2358

08-286700-00	STD	75.50	1.500		001 CR P			IKA
<i>[R42150]</i>			1.500		005 P			STD
			4.000		236 P			STD

Colt II 1.6 Turbo ECi	02/84→04/88	4 G 32 T/C							2
			4cyl.						
			1597cc	92kW (125PS)	Turbo				
TD5309									

Celeste 1.6 ST	01/77→06/81	4G32							
Cordia 1.6 GSL	10/82→12/86		4cyl.						
Galant I 1.6	01/77→08/80		1597cc	48-55kW (65-75PS)					
Galant I Station Wagon 1.6 GL	01/79→08/80								
Galant II 1.6 GLX,	09/80→05/84								
Galant II Station Wagon 1.6 GLX									
Galant III 1.6 GLX	06/84→04/90								
Galant IV Saloon 1.6	01/88→10/92								
L 200 1.6	03/80→10/96								
L 300 Box 1.6	02/80→05/94								
L 300 Bus 1.6	05/80→								
L 300 Platform/Chassis 1.6	04/83→04/94								
L 400 Box 1.6	06/96→10/02								
Sapporo I 1.6 SL, GL	04/78→07/80								
Sapporo II 1.6 GLX	08/80→09/84								
Sigma 1.6	10/77→09/85								
Tredia GLS 1.6	09/82→10/87								TD5325

08-285400-00	STD	76.90	2.000		001 CR P			STD
<i>[R27416K]</i>			2.000		026 P			STD
			4.000		712 CR			ST

Delica 1.6	11/11→	HR16DE							3
Lancer Estate 1.6 4WD	09/08→		4cyl.						
			1598cc	80kW (109PS)					
TD26598									

08-440100-00	STD	78.00	1.200		001 CR			ST
			1.200		005 P			STD
			2.000		712 CR			ST



Colt II 1.8 GL Diesel	02/84→04/88	4 D 65				4
Colt III 1.8 Diesel GLX	04/88→05/92		4cyl.			
Galant IV Saloon 1.8 D	01/88→10/92		1796cc	43-44kW (58-60PS)		
Lancer III 1.8 Diesel	01/84→04/88	Diesel				
Lancer III Station Wagon 1.8 D	09/85→06/92					
Lancer III Station Wagon 1.8 D 4WD	10/86→10/88					
Lancer IV 1.8 D,	04/88→05/92					
Lancer IV Saloon 1.8 GLX Diesel						
Mirage Hatchback 1.8 D	10/83→01/88					
Mirage Saloon 1.8 D,	05/88→11/91					
Mirage Saloon 1.8 D 4WD						

TD2300

08-287000-00	STD	80.60	2.000		007 IFU CR P	KV1
			2.000		005 CR P	STD
			4.000		231 CR P	STD

Galant III 1.8 Turbo-D	06/84→04/90	4 D 65 T				5
Galant IV 1.8 Turbo-D	11/88→10/92		4cyl.			
Galant IV Saloon 1.8 Turbo-D	12/87→10/92		1796cc	55-60kW (75-82PS)		
Mirage Saloon 1.8 TD,	12/91→08/95	Diesel	Turbo			
Mirage Saloon 1.8 TD 4WD						
Space Wagon 1.8 TD	06/86→10/98					

TD2296

08-287200-00	STD	80.60	2.000		007 MO P	KV1
[R45300]			2.000		011 CR P	STD
			4.000		231 CR P	STD

Lancer Saloon 2.0 DI-D	01/08→	BKD				6
Lancer SPORTBACK 2.0 DI-D	06/08→		4cyl.			
			1968cc	103kW (140PS)		

TD22162

08-139500-00	STD	81.00	1.750		001 CK P	
08-139507-00	0.50mm		2.000		005 IFU P	F12/F14
			3.000		231 CR P	STD

Colt VI 1.5 DI-D	08/04→	OM 639.939 Euro 4				7
			3cyl.			
			1493cc	50-70kW (58-95PS)		

TD27273

08-427500-00	STD	83.00	2.000		001 IF CK	KV4
08-427507-00	0.50mm		2.000		005 IFU P	F12/F14
			2.000		231 LKZ CR P	GOE13





Outlander II 2.2 DI-D 4WD	08/07→	4HK	4cyl. 2179cc 115kW (156PS)	8
		Diesel	Turbo Intercooled	TD24800
Outlander II 2.2 DI-D 4WD	08/07→	4HN	4cyl. 2179cc 115kW (156PS)	
		Diesel	Turbo Intercooled	TD24440
Outlander II 2.2 Di-D 4WD	08/07→	HTH	4cyl. 2179cc 115kW (156PS)	
		Diesel	Turbo Intercooled	TD25159

08-436700-00 STD	85.00	2.500		008 GDC P	KV1
		2.000		005 IFU P	STD
		2.000		231 LKZ CK	GOE13

L 200 2.3 D 4WD	01/83→10/86	4 D 55	4cyl. 2347cc 48-62kW (65-84PS)	9
L 300 Box 2.3 D	09/83→10/86			
L 300 Bus 2.3 D	04/83→10/86			
Pajero I 2.3 D	10/84→09/86	Diesel		TD5331
Canter Platform/Chassis 2.5 D	09/92→09/96	4 D 56 (8V)	4cyl. 2477cc 51-55kW (69-75PS)	
L 200 2.5 D	11/86→12/07			
L 200 2.5 D 4WD	12/87→05/93			
L 200 Platform/Chassis 2.5 D	10/86→10/96	Diesel		
L 200 Platform/Chassis 2.5 D 4WD	12/86→10/96			
L 300 Box 2.5 D	11/86→02/06			
L 300 Bus 2.5 D	11/86→			
L 300 Platform/Chassis 2.5 D	11/86→04/94			TD2293

08-288000-00 STD 01/1986→12/1994 [R43660]	91.10	2.500		001 MO P	KV1
		2.000		005 CR P	STD
		4.000		231 CR P	STD
08-288000-10 STD 08-288007-10 0.50mm	91.10	2.500		001 CK P	KV1
		2.000		005 CR	STD
		4.000		231 CR	STD
08-521200-00 STD 08-521207-00 0.50mm 01/1994→ [R44110]	91.10	2.000		001	KV1
		2.000		005 CR	STD
		4.000		231 CR	STD



Galant II 2.3 Turbo-D	09/80→05/84	4 D 55 T			10
Galant II Station Wagon 2.3 Turbo-D	07/83→05/84		4cyl.		
Pajero I Canvas Top 2.3 TD	12/82→04/86		2346cc	49kW (67PS)	
		Diesel	Turbo		TD2292

L 200 2.5 TD	08/01→11/05	4 D 56 T		
L 200 2.5 TD 4WD	11/92→12/07		4cyl.	
L 200 Platform/Chassis 2.5 TD	09/90→10/96		2476cc	63kW (86PS)
L 300 Box 2.5 TD	02/87→08/97	Diesel	Turbo	
L 300 Box 2.5 TD 4WD	11/91→05/03			
L 300 Bus 2.5 TD	02/87→05/03			
L 300 Bus 2.5 TD 4WD	11/88→			
L 300 Platform/Chassis 2.5 TD	11/94→04/00			
L 400 / Space Gear Bus 2500 TD	05/95→06/05			
L 400 Box 2500 TD, L 400 Box 2500 TD 4WD	09/96→06/05			
Pajero CLASSIC 2.5 TD	07/02→			
Pajero I 2.5 TD	11/89→12/91			
Pajero I 2.5 TD 4WD	10/86→05/91			
Pajero I Canvas Top 2.5 TD	05/86→11/90			
Pajero II 2.5 TDiC,	03/91→08/99			
Pajero II Canvas Top 2.5 TDiC				
Pajero III 2.5 TDi,	04/00→12/06			
Pajero III Canvas Top 2.5 TDi				
Pajero SPORT 2.5 TD	11/98→			
Pajero SPORT 2.5 TD 4WD	11/97→10/98			
Pajero SPORT II 2.5 TD	09/08→			
Pajero SPORT VAN 2.5 TD	12/99→01/08			TD4682

L 200 2.5 TD 4WD	06/96→12/07	4 D 56 TD		
L 300 Bus 2.5 TD	09/94→		4cyl.	
L 400 / Space Gear Bus 2.5 TD,	05/95→05/00		2477cc	73kW (99PS)
L 400 / Space Gear Bus 2.5 TD 4WD		Diesel	Turbo Intercooled	
Pajero II 2.5 TD 4WD	12/90→10/99			
Pajero II Canvas Top 2.5 TD 4WD	12/90→04/00			TD2294

08-287100-00	STD	91.10	2.500		007 IFU MO P	KV1	
08-287107-00	0.50mm			2.000		011 IFU CR P	STD
[R42640]				4.000		231 CR P	STD

L 200 2.5 DiD	11/05→	4 D 56 HP			11
L 200 2.5 DI-D	08/07→		4cyl.		
L 200 2.5 DI-D 4WD	11/05→		2477cc	100-131kW (136-178PS)	
L 200 Platform/Chassis 2.5 DI-D 4WD	04/10→	Diesel	Turbo Intercooled		
Pajero SPORT II 2.5 DI-D,	07/08→				
Pajero SPORT II 2.5 DI-D 4WD					TD24055

08-873400-00	STD	91.10	2.554		007 NT	ST	
08-873407-00	0.50mm			2.054		007 CR	KV1
				4.000		231 NT	ST



Canter	10/78→	4D30	4cyl. 3297cc	64kW (87PS)	12
		Diesel			TD8268

Rosa Bus	12/83→	4D31	4cyl. 3298cc	71kW (96PS)	13
		Diesel			TD8293

08-288200-00 01/1985→ [R42660]	STD	100.00	3.000		007 CR P	KV1
			2.000		005 P	STD
			5.000		231 CR P	STD

Canter 60	07/86→	4D31T	4cyl. 3298cc	86kW (117PS)	13
		Diesel	Turbo		TD8269

08-520400-00 [R45310]	STD	100.00	3.000		007 CR P	KV1
			2.000		005 P	STD
			4.000		231 CR P	GOE13

Canter 60	08/96→	4D34-1ATA Euro 2	4cyl. 3908cc	100kW (136PS)	14
Canter 75	10/97→				
Canter FE155F4, Canter FE7-136					
Canter Platform/Chassis 3.9	06/06→	Diesel	Turbo Intercooled		
Canter Platform/Chassis 3.9 TDi	10/96→07/01				TD16262

Canter 3.9 TD, Rosa 3.9 TD	10/89→	4D34-T	4cyl. 3907cc	90kW (122PS)	14
		Diesel	Turbo Intercooled		TD20188

Canter 3.9 TD, Rosa 3.9 TD	10/89→	4D34-TL	4cyl. 3907cc	86kW (117PS)	14
		Diesel	Turbo Intercooled		TD20189

08-288300-00 08-288307-00	STD 0.50mm	104.00	3.000		008 CR P	KV1
			2.000		005 IW CR P	IKA
			4.000		231 CR P	STD



Bus 11.15, Cement Tanker 11.15, Concrete Mixer 11.15, Crane Truck 11.15, Dump Truck 11.15, Forklift 11.15 40T, Tank Truck 11.15, Tractor 11.15, Truck 11.15	01/78→	6 D 22 A	6cyl. 11149cc	15
		Diesel		FM3815

Truck 11.15	08/79→	6 D 22 T	6cyl. 11149cc	
		Diesel	Turbo	FM9517

08-111600-00	STD	130.00	3.300		008 CR P	KV1
			3.000		005 IW CR	KV1
			6.000		231 CR P	STD
08-112300-00	STD	130.00	3.500		008 CR P	KV1
			3.000		005 IW CR P	STD
			4.000		231 CR P	STD

Industrial		MG500	6cyl. 9955cc	16
		Diesel		FM9036

08-111100-00	STD	130.00	3.500		008 CR P	KV1
			3.000		005 IW CR P	STD
			6.000		231 CR P	STD



2141 1.6				1.6L		4cyl. 1600cc		1
FM6448								

08-269800-00	STD	79.00	1.500		001 IF CR P	IKA
08-269806-00	0.40mm					
08-269820-00	0.70mm		2.000		026 P	GOE13
[R47270]			3.947		232 P	GOE13

2126		01/87→		1.5L		4cyl. 1478cc 59kW (80PS)		2
FM6449								

08-269900-00	STD	82.00	1.500		001 IF CR P	IKA	
08-269906-00	0.40mm						
08-269910-00	0.80mm		2.000		026 P	STD	
			3.947		712 CR	ST	
08-277000-00	STD	82.00	2.000		001 IF CR P	STD	
				2.500		023 P	STD
				5.000		031 P	STD

2141 Aleko, Aleko 2141		01/95→		1.7L		4cyl. 1700cc		3
FM6451								

08-288900-00	STD	85.00	1.500		001 CR P	KV1	
				2.000		026 P	STD
				3.000		231 CR P	STD

CCM
x

9

AKD 112, AKD12	Diesel		1/2/3/4	98.00	3
AKD 112-1	Diesel	905	1	98.00	3
AKD 112-2	Diesel	1810	2	98.00	3
AKD 112-3	Diesel	2715	3	98.00	3
AKD 112-4	Diesel	3620	4	98.00	3
AKD110.5Z	Diesel	1335	2	90.00	1
AKD1105-Z/D/V/S	Diesel	2977	4	95.00	2
D 208-2	Diesel	1490	2	95.00	2
D 225-2	Diesel	1700	2	95.00	2
D 225-3	Diesel	2550	3	95.00	2
D 226-2	Diesel	2080	2	105.00	6
D 226-3	Diesel	3120	3	105.00	6
D 226-4	Diesel	4160	4	105.00	6
D 226-6	Diesel	6234	6	105.00	6
D 227-6	Diesel	5654	6	100.00	4
D 229-3	Diesel	2942	3	102.00	5
D 229-4	Diesel	3920	4	102.00	5
D 234-12	Diesel	21607	V12	128.00	9
D 234-6	Diesel	10804	V6	128.00	9
D 234-8	Diesel	14405	V8	128.00	9
D 308-2	Diesel	1490	2	95.00	2
D 308-3	Diesel	2235	3	95.00	2
D 308-4	Diesel	2980	4	95.00	2
D 308-6	Diesel	4470	6	95.00	2
D 325-2	Diesel	1700	2	95.00	2
D 325-3	Diesel	2551	3	95.00	2
D 325-4	Diesel	3400	4	95.00	2
D 325-6	Diesel	5100	6	95.00	2
D 327-2	Diesel	1885	2	100.00	4
D 327-3	Diesel	2827	3	100.00	4
D 327-4	Diesel	3768	4	100.00	4
D 327-6	Diesel	5654	6	100.00	4
D202-2	Diesel	1488	2	95.00	2
D225-Z/D/V/S	Diesel	1700	2	95.00	2
D308-2/3/4/6	Diesel	1500	2	95.00	2
D325-Z/D/V/S	Diesel	2550	3	95.00	2
KD 10.5 D 2.0L	Diesel	2000	3	90.00	1
KD 110.5	Diesel	2670	4	90.00	1
KD 110.5 S 4.0L	Diesel	4000	6	90.00	1
KD110.5 D	Diesel	2000	3	90.00	1
TBD 234	Diesel	28809	V16	128.00	9
TBD234-12	Diesel	21607	12	128.00	9
TBD234-6	Diesel	10804	6	128.00	9
TBD234-8	Diesel	14405	8	128.00	9
TD 226-3	Diesel	3120	3	105.00	7
TD 226-4	Diesel	4160	4	105.00	7
TD 226-6	Diesel	6234	6	105.00	7
TD 229-6	Diesel	5883	6	102.00	5
TD 232	Diesel			120.00	8
TKD 1105	Diesel	1116	3	95.00	2
TKD1105-2	Diesel	2977	4	95.00	2



1

AKD110.5Z	2cyl.	1335cc		Diesel	FM13583	
KD 10.5 D 2.0L	3cyl.	2000cc		Diesel	FM8991	
KD 110.5	4cyl.	2670cc	17-37kW (24-51PS)	Diesel	FM6611	
KD 110.5 S 4.0L	6cyl.	4000cc		Diesel	FM8992	
KD110.5 D	3cyl.	2000cc		Diesel	FM18991	
08-278200-00	STD	90.00	2.500		001 IF CR P	STD
			2.500		001 IF P	STD
			2.500		023 P	STD
			5.000		231	STD

2

AKD1105-Z/D/V/S	4cyl.	2977cc		Diesel	FM3064	
D 208-2	2cyl.	1490cc	23kW (31PS)	Diesel	TD18053	
D 225-2	2cyl.	1700cc	13-24kW (18-33PS)	Diesel	TD18057	
D 225-3	3cyl.	2550cc	37kW (50PS)	Diesel	TD18058	
D 308-2	2cyl.	1490cc	23kW (31PS)	Diesel	TD18092	
D 308-3	3cyl.	2235cc	34kW (46PS)	Diesel	TD18093	
D 308-4	4cyl.	2980cc	44kW (60PS)	Diesel	TD18094	
D 308-6	6cyl.	4470cc	68kW (92PS)	Diesel	TD18095	
D 325-2	2cyl.	1700cc	21-25kW (29-34PS)	Diesel	TD18104	
D 325-3	3cyl.	2551cc	31-35kW (42-48PS)	Diesel	TD18105	
D 325-4	4cyl.	3400cc	43-51kW (58-69PS)	Diesel	TD18106	
D 325-6	6cyl.	5100cc	63-75kW (86-102PS)	Diesel	TD18107	
D202-2	2cyl.	1488cc		Diesel	FM6005	
D225-Z/D/V/S	2cyl.	1700cc		Diesel	FM2629	
D308-2/3/4/6	2cyl.	1500cc		Diesel	FM2626	
D325-Z/D/V/S	3cyl.	2550cc		Diesel	FM2630	
TKD 1105	3cyl.	1116cc		Diesel	FM6174	
TKD1105-2	4cyl.	2977cc		Diesel	FM23064	
08-278000-00	STD	95.00	3.000		007 CR P	STD
			3.000		001 IF P	STD
			3.000		023 P	STD
			5.000		231 CR P	STD



3

AKD 112, AKD12			1/2/3/4cyl.		Diesel	FM1264
AKD 112-1			1cyl. 905cc	8kW (11PS)	Diesel	TD18116
AKD 112-2			2cyl. 1810cc	16kW (22PS)	Diesel	TD18117
AKD 112-3			3cyl. 2715cc	24kW (33PS)	Diesel	TD18118
AKD 112-4			4cyl. 3620cc	32kW (44PS)	Diesel	TD18119
08-273800-00	STD	98.00	3.000		001 P	STD
			3.000		005 P	STD
			3.000		005 P	STD
			5.000		231 P	STD
			5.000		030 P	STD

4

D 227-6			6cyl. 5654cc	71-91kW (97-124PS)	Diesel	TD18075
D 327-2			2cyl. 1885cc	24-27kW (33-37PS)	Diesel	TD18108
D 327-3			3cyl. 2827cc	31-48kW (42-65PS)	Diesel	TD18109
D 327-4			4cyl. 3768cc	45-55kW (61-75PS)	Diesel	TD18110
D 327-6			6cyl. 5654cc	68-82kW (92-112PS)	Diesel	TD18111
08-279400-00	STD	100.00	3.000		008 IW CR P	IKA
			2.000		005 IF	STD
			2.000		026	STD
			4.000		231 CR P	STD

5

D 229-3			3cyl. 2942cc	47kW (64PS)	Diesel	TD6348
D 229-4			4cyl. 3920cc	65kW (88PS)	Diesel	TD6350
TD 229-6			6cyl. 5883cc	106kW (144PS)	Diesel Turbo	TD6704
08-281500-00	STD	102.00	3.000		008 CR P	IKA
08-281511-00	1.00mm		2.500		005 P	STD
			4.000		231 CR P	STD



6

D 226-2		2cyl.	2080cc	27-30kW (37-41PS)	Diesel	TD18060
D 226-3		3cyl.	3120cc	40-44kW (55-60PS)	Diesel	TD18061
D 226-4		4cyl.	4160cc	55-64kW (75-87PS)	Diesel	TD6993
D 226-6		6cyl.	6234cc	74-96kW (101-131PS)	Diesel	TD18062
08-278100-00 01/1969→	STD	105.00	3.000		007 CR P	STD
			2.000		001 IF P	STD
			2.000		023 P	STD
			4.000		231 CR P	STD
08-279600-00	STD	105.00	3.000		008 CR P	IKA
			2.000		005 IF	STD
			2.000		026	STD
			4.000		231 CR P	STD

7

TD 226-3		3cyl.	3120cc	84kW (114PS)	Diesel Turbo	TD18067
TD 226-4		4cyl.	4160cc	68-74kW (93-100PS)	Diesel Turbo	TD18069
TD 226-6		6cyl.	6234cc	107-125kW (146-170PS)	Diesel Turbo	TD18070
08-279600-00 01/1971→12/1977	STD	105.00	3.000		008 CR P	IKA
			2.000		005 IF	STD
			2.000		026	STD
			4.000		231 CR P	STD

8

TD 232					Diesel Turbo	FM9016
08-280500-00	STD	120.00	3.500		008 CR	STD
			3.000		001 IF	STD
			3.000		023	STD
			5.000		232	STD



9

D 234-12	V12cyl.	21607cc	380-720kW (517-979PS)	Diesel	FM6020
D 234-6	V6cyl.	10804cc		Diesel	FM6017
D 234-8	V8cyl.	14405cc		Diesel	FM6018
TBD 234	V16cyl.	28809cc		Diesel	FM6186
TBD234-12	12cyl.	21607cc		Diesel	FM16020
TBD234-6	6cyl.	10804cc		Diesel	FM16017
TBD234-8	8cyl.	14405cc		Diesel	FM16018

08-285600-00	STD	128.00	3.500		008 CR P	IKA
			3.000		005 P	STD
			4.000		231 CR P	STD

ENGINE INDEX

Motorverzeichnis • Index de moteur • Índice de Motor
Indeks silnika • Модель двигателя • دليل المحرك



CCM

x



9

604.030, 604.031, 604.034, 604.035, 604.041	Diesel	6872	4	125.00	19
614.010	Diesel	1134	2	85.00	1
615.000	Diesel	2270	4	85.00	1
8025.01	Diesel	1559	2	95.00	3
8025.02	Diesel	1728	2	100.00	4
8035.01 / 8035.01.265	Diesel	2338	3	95.00	3
8035.02	Diesel	2592	3	100.00	4
8035.04	Diesel	2748	3	103.00	7
8035.04, 8035.42	Diesel	2748	3	103.00	7
8035.05	Diesel	2930	3	104.00	9
8035.06	Diesel	2708	3	100.00	5
8045.01	Diesel	3119	4	95.00	3
8045.02	Diesel	3455	4	100.00	4
8045.04	Diesel	3666	4	103.00	7
8045.05	Diesel	3908	4	104.00	9
8045.06	Diesel	3613	4	100.00	5
8045.25	Diesel	3908	4	104.00	10
8045.42	Diesel	3455	4	100.00	6
8055.04	Diesel	4583	5	103.00	7
8055.05	Diesel	4882	5	104.00	9
8061 L, 8061L	Diesel	5499	6	103.00	8
8061.05	Diesel	5419	6	104.00	9
8065.02	Diesel	5184	6	100.00	4
8065.04	Diesel	5499	6	103.00	7
8065.05	Diesel	5861	6	104.00	9
8065.06	Diesel	5420	6	100.00	5
8065.24	Diesel	5499	6	103.00	8
8065.25	Diesel	5863	6	104.00	10
8140.21.200 (Sofim)	Diesel	2445	4	93.00	2
8210.02	Diesel	13798	6	137.00	20
8215.22, 8215.22.520	Diesel	13798	6	137.00	21
8365.05.500	Diesel	8102	6	115.00	15
8365.05.590	Diesel	8102	6	115.00	15
8365.25.500, 8365.25.500/502	Diesel	8102	6	115.00	16
8365.25.501, 8365.25.501/503/533, 8365.25.503	Diesel	8102	6	115.00	16
8365.25.590	Diesel	8102	6	115.00	15
8460.21, 8460.21.002, 8460.21.042, 8460.21.102, 8460.21.106, 8460.21.708, 8460.21.710	Diesel	9500	6	120.00	18
C03	Diesel	4941	4	110.00	12
C03/20/21/41	Diesel	4562	4	110.00	12
CN3	Diesel	3706	3	110.00	12
CO3-13OT	Diesel	5401	4	115.00	17
CO3D-130	Diesel	4940	4	110.00	12
CO130, CO20/60, CO2D, CO3D	Diesel	4397	4	108.00	11
CP 3/100	Diesel	7412	6	110.00	12
Genesis (5640)	Diesel	4400	4	111.77	13
Genesis (6640)	Diesel	5000	4	111.77	13
Genesis (7740)	Diesel	5000	4	111.77	14
Genesis (7840)	Diesel	6600	6	111.77	13
Genesis (8240,8340)	Diesel	7500	6	111.77	13



1

614.010		2cyl.	1134cc		Diesel	FM4129
615.000		4cyl.	2270cc		Diesel	FM4127
08-527800-00	STD	85.00	3.000		001 CR P	GOE12
08-527808-00	0.60mm		3.000		001 P	GOE12
<i>[R46810]</i>			3.000		023 P	GOE12
			5.500		231 P	GOE12

2

8140.21.200 (Sofim)		4cyl.	2445cc	68kW (92PS)	Diesel Turbo	FM9240
08-245200-00	STD	93.00	3.000		008 CR P	KV1
<i>[R47080]</i>			2.000		005 P	F12/F14
			3.000		231 CR P	STD

3

8025.01		2cyl.	1559cc		Diesel	FM569
8035.01 / 8035.01.265		3cyl.	2338cc		Diesel	FM4006
8045.01		4cyl.	3119cc		Diesel	FM571
08-207200-00	STD	95.00	2.500		001 IW CR P	KV1
08-207208-00	0.60mm		2.500		023 P	IKA
<i>[R46770]</i>			5.500		231 CR P	STD

4

8025.02		2cyl.	1728cc		Diesel	FM573
8035.02		3cyl.	2592cc	33-40kW (45-54PS)	Diesel	FM3475
8045.02		4cyl.	3455cc	44-50kW (60-68PS)	Diesel	FM3476
8065.02		6cyl.	5184cc		Diesel	FM3477
08-206800-00	STD	100.00	2.500		001 IW CR P	KV1
08-206808-00	0.60mm		2.500		023 P	STD
<i>[R46830]</i>			5.500		231 CR P	STD
08-206800-40	STD	100.00	2.500		001 CK P	KV1
08-206808-40	0.60mm		2.500		023 P	STD
<i>[R46880]</i>			5.500		231 CR P	STD
08-781900-00	STD	100.00	2.500		001 MOL P	KV1
08-781908-00	0.60mm		2.500		026 P	IKA
<i>[R47070]</i>			4.000		231 CR P	STD



5

8035.06		3cyl.	2708cc	33-40kW (45-54PS)	Diesel	FM4008
8045.06		4cyl.	3613cc		Diesel	FM4013
8065.06		6cyl.	5420cc		Diesel	FM4017
08-106900-00	STD	100.00	2.500		001 IW CR P	KV1
			2.500		023 P	STD
			4.000		231 CR P	STD
08-781900-00	STD	100.00	2.500		001 MOL P	KV1
08-781908-00	0.60mm		2.500		026 P	IKA
01/1970→			4.000		231 CR P	STD
[R47070]						

6

8045.42		4cyl.	3455cc		Diesel	FM13476
08-206800-00	STD	100.00	2.500		001 IW CR P	KV1
08-206808-00	0.60mm		2.500		023 P	STD
[R46830]			5.500		231 CR P	STD
08-206800-40	STD	100.00	2.500		001 CK P	KV1
08-206808-40	0.60mm		2.500		023 P	STD
[R46880]			5.500		231 CR P	STD

7

8035.04		3cyl.	2748cc		Diesel	FM4007
8035.04, 8035.42		3cyl.	2748cc		Diesel	FM6416
8045.04		4cyl.	3666cc		Diesel	FM3483
8055.04		5cyl.	4583cc		Diesel	FM3484
8065.04		6cyl.	5499cc		Diesel	FM3486
08-782000-00	STD	103.00	2.500		001 MOL P	KV1
08-782008-00	0.60mm		2.500		026 P	IKA
[R47030]			4.000		231 CR P	STD

8

8061 L, 8061L		6cyl.	5499cc		Diesel	FM23487
8065.24		6cyl.	5499cc		Diesel Turbo	FM3487
08-783900-00	STD	103.00	3.000		008 MOL P	KV1
[R47050]			2.500		026 P	IKA
			4.000		231 CR	GOE12



9

8035.05			3cyl.	2930cc		Diesel		FM4032
8045.05			4cyl.	3908cc		Diesel		FM4012
8055.05			5cyl.	4882cc		Diesel		FM4014
8061.05			6cyl.	5419cc		Diesel		FM13485
8065.05			6cyl.	5861cc		Diesel		FM4016
08-247800-00	STD	104.00		2.500		001 MOL P		KV1
08-247808-00	0.60mm			2.500		005 IF P		STD
[R47200]				4.000		231 CR P		STD

10

8045.25			4cyl.	3908cc		Diesel Turbo		FM9242
8065.25			6cyl.	5863cc	94-110kW (128-150PS)	Diesel Turbo		FM4018
08-244500-00	STD	104.00		3.000		008 CR P		KV1
[R47110]				2.500		023 P		IKA
				4.000		231 CR P		STD

11

CO130, CO20/60, CO2D, CO3D			4cyl.	4397cc		Diesel		FM11303
08-528100-00	STD	108.00		2.500		001 CR P		GOE12
[R47500]				2.500		001 P		GOE12
				2.500		023 P		GOE12
				2.500		023 P		GOE12
				5.000		030 P		GOE12
				5.000		231 P		GOE12

12

C03			4cyl.	4941cc		Diesel		FM14029
C03/20/21/41			4cyl.	4562cc		Diesel		FM11307
CN3			3cyl.	3706cc		Diesel		FM4028
CO3D-130			4cyl.	4940cc		Diesel		FM9111
CP 3/100			6cyl.	7412cc		Diesel		FM11310
08-207500-00	STD	110.00		2.500		001 IF CR P		STD
[R47460]				2.500		001 P		STD
				2.500		023 P		STD
				5.000		231 CR P		STD



13

Genesis (5640)		4cyl.	4400cc	Diesel		FM6763
Genesis (6640)		4cyl.	5000cc	Diesel		FM6765
Genesis (7840)		6cyl.	6600cc	Diesel		FM6764
Genesis (8240,8340)		6cyl.	7500cc	Diesel		FM6766
08-521300-00	STD	111.77	2.381		008 CR	STD
08-521307-00	.020		2.381		005 IF	STD
11/1991→			4.762		231 CR	STD
[R48450]						

14

Genesis (7740)		4cyl.	5000cc	Diesel Turbo		FM6767
08-521400-00	STD	111.77	3.000		008 CR	STD
08-521407-00	.020		2.381		005 IF	STD
11/1991→			4.762		231 CR	STD
[R48460]						

15

8365.05.500		6cyl.	8102cc	Diesel		FM3494
8365.05.590		6cyl.	8102cc	Diesel		FM13494
8365.25.590		6cyl.	8102cc	Diesel Turbo		FM19107
08-214900-10	STD	115.00	2.500		001 IF CR P	IKA
[R47530]			2.500		005 P	STD
			4.000		231 CR P	STD
08-523000-00	STD	115.00	2.500		001 IF CR P	IKA
[R47510]			2.500		001 IF P	GOE12
			4.000		231 CR P	GOE12

16

8365.25.500, 8365.25.500/502		6cyl.	8102cc	Diesel Turbo		FM9107
8365.25.501, 8365.25.501/503/533, 8365.25.503		6cyl.	8102cc	Diesel Turbo		FM29107
08-245500-00	STD	115.00	3.000		008 CR P	IKA
[R47550]			2.500		005 P	STD
			4.000		231 CR P	STD
08-524700-00	STD	115.00	3.000		008 CR P	IKA
[R47520]			2.500		001 CR P	IKA
			4.000		231 CR P	GOE12



17

CO3-130T		4cyl.	5401cc	Diesel			FM4030
08-528000-00	STD	115.00	2.500		001 IF CR P	IKA	
[R47490]	2.500			001 IF P	GOE12		
	5.000			231 P	GOE12		

18

8460.21, 8460.21.002, 8460.21.042, 8460.21.102, 8460.21.106, 8460.21.708, 8460.21.710		6cyl.	9500cc	Diesel Turbo			FM4130
08-785300-00	STD	120.00	3.500		008 CR P	KV1	
[R47230]	3.000			005 IF CR P	STD		
	5.000			231 CR P	STD		

19





604.030, 604.031, 604.034, 604.035, 604.041		4cyl.	6872cc	Diesel			FM9168
08-527700-00	STD	125.00	3.500		001 CR P	GOE12	
[R46780]	3.000			001 IF P	GOE12		
	3.000			001 IF P	GOE12		
	3.000			023 P	STD		
	5.500			231 P	GOE12		
	5.500			030 P	GOE12		

20

8210.02		6cyl.	13798cc	Diesel			FM10601
08-207800-10	STD	137.00	4.000		008 CR P	KV1	
[R46870]	3.000			005 P	STD		
	3.000			005 P	STD		
	5.500			231 CR P	STD		
08-207800-30	STD	137.00	4.000		008 CR P	KV1	
[R46840]	3.000			005 P	STD		
	3.000			026 P	STD		
	5.500			231 CR P	STD		



21

8215.22, 8215.22.520		6cyl.	13798cc		Diesel	Turbo	FM9116
08-207800-10	STD	137.00	4.000		008 CR P		KV1
[R46870]	3.000			005 P		STD	
	3.000			005 P		STD	
	5.500			231 CR P		STD	

CCM
x

03/90→10/94	100 NX 1.6	GA16DS	Petrol	1597	4	7
09/93→10/94	100 NX 1.6 SR	GA16DE	Petrol	1597	4	7
10/81→08/88	AD Van 1.3	E13S	Petrol	1269	4	6
10/81→08/88	AD Van 1.5	E15S	Petrol	1488	4	6
10/84→	AD Van 1.7 D	CD17	Diesel	1680	4	14
10/94→04/99	AD Van 2.0 D	CD20	Diesel	1974	4	19
05/99→08/04	AD Wagon 1.6	GA16DE	Petrol	1597	4	7
10/90→04/99	AD Wagon 1.6	GA16DS	Petrol	1597	4	7
10/90→08/04	AD Wagon 1.7 D	CD17	Diesel	1680	4	14
05/99→08/04	AD Wagon 1.8	QG18DE	Petrol	1769	4	16
03/06→	Almera Classic 1.6 16V	QG16DE	Petrol	1597	4	9
07/95→07/00	Almera I 1.6	GA16DE	Petrol	1597	4	7
09/95→07/00	Almera I 1.6 SLX	GA16DE	Petrol	1597	4	7
07/95→05/00	Almera I 1.8	QG18DE	Petrol	1769	4	16
11/95→07/00	Almera I 2.0 D	CD20	Diesel	1974	4	19
07/95→03/00	Almera I Hatchback 1.6	GA16DE	Petrol	1597	4	7
09/95→03/00	Almera I Hatchback 1.6 SR, SLX	GA16DE	Petrol	1597	4	7
11/95→03/00	Almera I Hatchback 2.0 D	CD20	Diesel	1974	4	19
01/03→	Almera II 1.5 dCi	K9K 722 Euro 3	Diesel	1461	4	8
07/00→02/03	Almera II 1.6	GA16DE	Petrol	1597	4	7
07/00→02/03	Almera II 1.6	QG16DE	Petrol	1597	4	9
07/00→	Almera II 1.8	QG18DE	Petrol	1769	4	16
09/03→	Almera II 2.2 dCi	YD22DDT	Diesel	2184	4	23
09/03→	Almera II 2.2 dCi	YD22DDTi	Diesel	2184	4	23
07/00→	Almera II 2.2 Di	YD22DDT	Diesel	2184	4	23
01/03→	Almera II Hatchback 1.5 dCi	K9K 722 Euro 3	Diesel	1461	4	8
07/00→02/03	Almera II Hatchback 1.6	GA16DE	Petrol	1597	4	7
01/00→	Almera II Hatchback 1.8	QG18DE	Petrol	1769	4	16
09/03→	Almera II Hatchback 2.2 dCi	YD22DDT	Diesel	2184	4	23
09/03→	Almera II Hatchback 2.2 dCi	YD22DDTi	Diesel	2184	4	23
03/00→	Almera II Hatchback 2.2 Di	YD22DDT	Diesel	2184	4	23
08/00→	Almera Tino 1.8	QG18DE	Petrol	1769	4	16
09/03→	Almera Tino 2.2 dCi	YD22DDT	Diesel	2184	4	23
09/03→	Almera Tino 2.2 dCi	YD22DDTi	Diesel	2184	4	23
08/00→	Almera Tino 2.2 Di	YD22DDTi	Diesel	2184	4	23
08/01→	Altima 2.5	QR25DE	Petrol	2488	4	27
10/06→	Altima 2.5 Hybrid	QR25DE	Petrol	2488	4	27
10/06→	Altima Coupe 2.5 Hybrid	QR25DE	Petrol	2488	4	27
10/93→10/97	Atlas 2.5 D	TD25	Diesel	2494	4	31
11/97→	Avenir 1.6	QG16DE	Petrol	1597	4	9
11/97→	Avenir 1.8	QG18DE	Petrol	1769	4	16
09/01→	Avenir 2.0	QR20DE	Petrol	1998	4	26
09/01→	Avenir 2.0 4x4	QR20DE	Petrol	1998	4	26
06/02→08/03	Bassara 2.5	QR25DE	Petrol	2488	4	27
11/99→08/03	Bassara 2.5 DCi	YD25DDTi	Diesel	2488	4	29
12/82→07/92	BE 1.0	MA10S	Petrol	988	4	1
04/72→11/79	Bluebird 1.8	L18	Petrol	1770	4	20
05/81→03/85	Bluebird 2.0	L20B	Petrol	1952	4	20
01/80→03/97	Bluebird 2.0 D	LD20	Diesel	1952	4	21
01/60→12/65	Bluebird 1200	E1	Petrol	1189	4	4
01/58→12/69	Bluebird 1300	J	Petrol	1299	4	4
01/72→12/81	Bluebird 1800	G18	Petrol	1817	4	20
03/86→12/90	Bluebird Hatchback 2.0 D	LD20	Diesel	1952	4	21
04/84→12/90	Bluebird Station Wagon 2.0 D	LD20	Diesel	1952	4	21
08/00→08/05	Bluebird SYLPHY 1.6	QG16DE	Petrol	1597	4	9
08/02→08/05	Bluebird SYLPHY 1.8	QG18DE	Petrol	1769	4	16
08/00→07/02	Bluebird SYLPHY 1.8 4x4	QG18DE	Petrol	1769	4	16
01/80→05/84	Bluebird Traveller 2.0 D	LD20	Diesel	1952	4	21
11/87→11/94	Bobby Box 2.0 DX	LD20	Diesel	1952	4	21
11/87→11/94	Bobby Bus 2.0 DLX	LD20	Diesel	1952	4	21

MODEL INDEX

Modelverzeichnis • Index de modele • Índice de Modelo
 Indeks modelu • Модель автомобиля • دليل الموديل

CCM
x

9

01/70→12/80	Bus 10300	PD6	Diesel	10308	6	36
12/81→06/92	Cabstar 2.3	SD23	Diesel	2289	4	28
02/83→12/90	Cabstar 2.5	SD25	Diesel	2488	4	28
10/82→06/92	Cabstar 2.5	TD25	Diesel	2494	4	31
02/83→12/90	Cabstar 2.7	TD27	Diesel	2663	4	34
09/06→03/09	Cabstar 35.13	YD25DDTi	Diesel	2488	4	29
10/06→	Cabstar 45.13	YD25DDTi	Diesel	2488	4	29
10/06→	Cabstar 45.15	ZD30	Diesel	2953	4	35
10/98→10/06	Cabstar E 90.32	TD27T	Diesel	2663	4	34
01/92→	Cabstar Flat Bed 3000 Long Wood Flat Bed	BD30	Diesel	2953	4	34
01/89→12/00	Cabstar Platform/Chassis 2.5 D	TD25	Diesel	2494	4	31
10/06→09/11	Cabstar Platform/Chassis 2.5 dCi	YD25DDTi	Diesel	2488	4	29
01/70→	Cabstar/Cedric/Homer	J15	Petrol	1483	4	12
01/63→12/77	Cedric	SD20	Diesel	1991	4	17
05/84→08/87	Cedric 2.3 D	SD23	Diesel	2289	4	28
01/66→12/69	Cedric 2000	J20	Petrol	1973	6	4
01/63→12/77	Cedric 2000	SD20	Diesel	1991	4	17
09/70→09/78	Cherry 1.0	A10	Petrol	988	4	4
08/78→07/81	Cherry II Coupe 1.0	A10	Petrol	988	4	4
08/78→07/81	Cherry II Coupe 1.2	A12	Diesel	1171	4	4
08/81→09/82	Cherry II Coupe 1.3	E13	Petrol	1270	4	6
08/80→02/81	Cherry II Coupe 1.4	A14	Diesel	1397	4	5
08/81→05/82	Cherry II Coupe 1.5	E15	Petrol	1488	4	6
08/78→07/81	Cherry II Hatchback 1.2	A12	Diesel	1171	4	4
08/81→09/82	Cherry II Hatchback 1.3	E13	Petrol	1270	4	6
08/78→07/81	Cherry II Hatchback 1.4	A14	Diesel	1397	4	5
08/81→12/82	Cherry II Hatchback 1.5	E15	Petrol	1488	4	6
08/78→07/81	Cherry II Traveller 1.0	A10	Petrol	988	4	4
08/81→05/82	Cherry II Traveller 1.0	E10	Petrol	988	4	4
10/78→07/81	Cherry II Traveller 1.2	A12	Diesel	1171	4	4
09/81→12/83	Cherry II Traveller 1.3	E13	Petrol	1270	4	6
08/81→03/82	Cherry II Traveller 1.5	E15	Petrol	1488	4	6
05/82→05/86	Cherry III 1.0	E10	Petrol	988	4	4
05/82→10/86	Cherry III 1.3	E13	Petrol	1270	4	6
11/83→10/86	Cherry III 1.5	E15S	Petrol	1488	4	6
10/82→12/86	Cherry III 1.7 D	CD17	Diesel	1680	4	14
03/10→	Cube 1.6 16V	HR 16 DE	Petrol	1598	4	11
12/74→06/78	Datsun 100 A 1.0	A10	Petrol	988	4	4
12/75→08/80	Datsun 100 A Estate F-II 1.0	A10	Petrol	988	4	4
12/75→08/80	Datsun 100 A F-II 1.0	A10	Petrol	988	4	4
12/75→07/80	Datsun 120 A F-II 1.2	A12	Diesel	1171	4	4
09/74→07/80	Datsun 120 Y 1.2	A12	Diesel	1171	4	4
04/62→07/80	Datsun 120 Y Coupe 1.2	A12	Diesel	1171	4	4
12/75→08/80	Datsun 120 Y Coupe A F-II 1.2	A12	Diesel	1171	4	4
02/79→06/83	Datsun 140 Y Estate 1.4	A14	Diesel	1397	4	5
11/10→	Elgrand 2.5	QR25DE	Petrol	2488	4	27
11/10→	Elgrand 2.5 AWD	QR25DE	Petrol	2488	4	27
04/03→12/10	Elgrand 3.0 D	ZD30	Diesel	2953	4	35
10/98→04/04	Expert 1.8	QG18DE	Petrol	1769	4	16
01/73→12/78	Fire Engine 10300	PD6	Diesel	10308	6	36
01/63→12/67	Homer	SD20	Diesel	1991	4	17
01/63→12/67	Homer 2000	SD20	Diesel	1991	4	17
05/92→10/95	Homy Box 2.5 TD	TD25	Diesel	2494	4	31
10/93→10/97	Homy Box 3.2 D	SD33	Diesel	3246	6	17
10/93→10/97	Homy Platform/Chassis 3.2 D	SD33	Diesel	3246	6	17
05/92→10/95	Homy Platform/Chassis 2.5 TD	TD25	Diesel	2494	4	31
07/02→	Interstar Box dCi 90	G9T 722	Diesel	2188	4	24
11/03→	Interstar Box dCi 100	G9U 720 Euro 3	Diesel	2463	4	25
07/02→	Interstar Box dCi 120	G9U 720 Euro 3	Diesel	2463	4	25
11/03→	Interstar Box dCi 140	ZD30	Diesel	2953	4	35

CCM
x

9

07/02→	Interstar Bus dCi 90	G9T 722	Diesel	2188	4	24
11/03→	Interstar Bus dCi 100	G9U 720 Euro 3	Diesel	2463	4	25
07/02→	Interstar Bus dCi 120	G9U 720 Euro 3	Diesel	2463	4	25
11/03→	Interstar Bus dCi 140	ZD30	Diesel	2953	4	35
02/04→	Interstar Platform/Chassis dCi 100	G9U 720 Euro 3	Diesel	2463	4	25
08/03→	Interstar Platform/Chassis dCi 120	G9U 720 Euro 3	Diesel	2463	4	25
11/03→	Interstar Platform/Chassis dCi 140	ZD30	Diesel	2953	4	35
06/10→	Juke 1.6	HR 16 DE	Petrol	1598	4	11
01/63→12/67	Junior 2000 Wagon	SD20	Diesel	1991	4	17
01/63→12/67	KRSE20 2000	SD20	Diesel	1991	4	17
08/03→	Kubistar 1.2	D7F 764	Petrol	1149	4	3
04/06→	Kubistar 1.2 16V	D4F 712	Petrol	1149	4	2
08/03→	Kubistar 1.5 dCi	K9K 704 Euro 3	Diesel	1461	4	8
08/03→	Kubistar 1.5 dCi	K9K 710	Diesel	1461	4	8
08/03→	Kubistar 1.5 dCi	K9K 714	Diesel	1461	4	8
08/03→	Kubistar 1.5 dCi	K9K 722 Euro 3	Diesel	1461	4	8
04/06→	Kubistar 1.5 dCi 70	K9K 700	Diesel	1461	4	8
08/03→	Kubistar 1.6 16V	K4M 752	Petrol	1598	4	13
08/03→	Kubistar Box 1.2	D7F 764	Petrol	1149	4	3
04/06→	Kubistar Box 1.2 16V	D4F 712	Petrol	1149	4	2
08/03→	Kubistar Box 1.5 dCi	K9K 704 Euro 3	Diesel	1461	4	8
08/05→	Kubistar Box 1.5 dCi	K9K 710	Diesel	1461	4	8
08/05→	Kubistar Box 1.5 dCi	K9K 714	Diesel	1461	4	8
08/03→	Kubistar Box 1.5 dCi	K9K 722 Euro 3	Diesel	1461	4	8
08/03→	Kubistar Box 1.6 16V	K4M 752	Petrol	1598	4	13
03/07→	Latio Saloon 1.6	HR 16 DE	Petrol	1598	4	11
01/79→12/83	Laurel	SD20	Diesel	1991	4	17
04/81→10/84	Laurel 2.0 D	LD20	Diesel	1952	4	21
01/79→12/83	Laurel 200D	SD20	Diesel	1991	4	17
02/07→	Livina /Grand Livina 1.6	HR 16 DE	Petrol	1598	4	11
10/92→01/00	Lucino Hatchback 1.6	GA16DE	Petrol	1597	4	7
09/91→10/92	Lucino Hatchback 1.6	GA16DS	Petrol	1597	4	7
11/95→01/00	Lucino Saloon 1.6	GA16DE	Petrol	1597	4	7
11/97→01/00	Lucino Saloon 2.0 D	CD20	Diesel	1974	4	19
08/05→	Micra C+C 1.6 160 SR	HR 16 DE	Petrol	1598	4	11
	Micra I 1.0	MA10	Petrol	988	4	1
12/82→12/89	Micra I 1.0	MA10S	Petrol	988	4	1
01/92→04/93	Micra II 1.0	MA10S	Petrol	988	4	1
02/98→02/03	Micra II 1.5 D	TD15 (TUD5)	Diesel	1527	4	10
01/03→06/10	Micra III 1.5 dCi	K9K 704 Euro 3	Diesel	1461	4	8
09/03→06/10	Micra III 1.5 dCi	K9K 722 Euro 3	Diesel	1461	4	8
05/05→06/10	Micra III 160 SR	HR 16 DE	Petrol	1598	4	11
07/05→	Navara 2.5 dCi	YD25DDTi	Diesel	2488	4	29
07/05→	Navara 2.5 dCi 4WD	YD25DDTi	Diesel	2488	4	29
06/92→02/97	Navara 2.7 D 4x4	TD27	Diesel	2663	4	34
08/08→	Navara Platform/Chassis 2.5 dCi 4WD	YD25DDTi	Diesel	2488	4	29
03/06→	Note 1.5 dCi	K9K 700	Diesel	1461	4	8
03/06→	Note 1.6	HR 16 DE	Petrol	1598	4	11
04/08→	NP300 2.5 dCi	YD25DDTi	Diesel	2488	4	29
04/08→	NP300 2.5 dCi 4x4	YD25DDTi	Diesel	2488	4	29
02/10→	NV200 Box 1.6 16V	HR 16 DE	Petrol	1598	4	11
07/10→	NV200 Evalia 1.6 16V	HR 16 DE	Petrol	1598	4	11
11/11→	NV400 Box 2.3 dCi	M9T 670 Euro 5	Diesel	2298	4	22
11/11→	NV400 Box 2.3 dCi	M9T 672 Euro 5	Diesel	2298	4	22
11/11→	NV400 Box 2.3 dCi	M9T 676 Euro 4	Diesel	2298	4	22
11/11→	NV400 Box 2.3 dCi	M9T 678	Diesel	2298	4	22
11/11→	NV400 Box 2.3 dCi	M9T 680	Diesel	2298	4	22
11/11→	NV400 Box 2.3 dCi [RWD]	M9T 686 Euro 5	Diesel	2298	4	22
11/11→	NV400 Box 2.3 dCi [RWD]	M9T 690 Euro 5	Diesel	2298	4	22
11/11→	NV400 Box 2.3 dCi [RWD]	M9T 692 Euro 4	Diesel	2298	4	22

MODEL INDEX

Modelverzeichnis • Index de modele • Índice de Modelo
 Indeks modelu • Модель автомобиля • دليل الموديل

CCM
x

9

11/11→	NV400 Box 2.3 dCi [RWD]	M9T 694 Euro 4	Diesel	2298	4	22
11/11→	NV400 Box 2.3 dCi [RWD]	M9T 696 Euro 4	Diesel	2298	4	22
11/11→	NV400 Box 2.3 dCi [RWD]	M9T 698 Euro 5	Diesel	2298	4	22
11/11→	NV400 Bus 2.3 dCi	M9T 670 Euro 5	Diesel	2298	4	22
11/11→	NV400 Bus 2.3 dCi	M9T 672 Euro 5	Diesel	2298	4	22
11/11→	NV400 Bus 2.3 dCi	M9T 676 Euro 4	Diesel	2298	4	22
11/11→	NV400 Bus 2.3 dCi	M9T 678	Diesel	2298	4	22
11/11→	NV400 Bus 2.3 dCi	M9T 680	Diesel	2298	4	22
11/11→	NV400 Platform/Chassis 2.3 dCi [RWD]	M9T 686 Euro 5	Diesel	2298	4	22
11/11→	NV400 Platform/Chassis 2.3 dCi [RWD]	M9T 690 Euro 5	Diesel	2298	4	22
11/11→	NV400 Platform/Chassis 2.3 dCi [RWD]	M9T 692 Euro 4	Diesel	2298	4	22
11/11→	NV400 Platform/Chassis 2.3 dCi [RWD]	M9T 694 Euro 4	Diesel	2298	4	22
11/11→	NV400 Platform/Chassis 2.3 dCi [RWD]	M9T 696 Euro 4	Diesel	2298	4	22
11/11→	NV400 Platform/Chassis 2.3 dCi [RWD]	M9T 698 Euro 5	Diesel	2298	4	22
11/11→	NV400 Platform/Chassis 2.3 dCi	M9T 670 Euro 5	Diesel	2298	4	22
11/11→	NV400 Platform/Chassis 2.3 dCi	M9T 672 Euro 5	Diesel	2298	4	22
11/11→	NV400 Platform/Chassis 2.3 dCi	M9T 676 Euro 4	Diesel	2298	4	22
11/11→	NV400 Platform/Chassis 2.3 dCi	M9T 678	Diesel	2298	4	22
11/11→	NV400 Platform/Chassis 2.3 dCi	M9T 680	Diesel	2298	4	22
01/05→	Pathfinder 2.5 dCi	YD25DDTi	Diesel	2488	4	29
03/05→	Pathfinder 2.5 dCi 4WD	YD25DDTi	Diesel	2488	4	29
01/80→12/87	Patrol 160	4.165	Diesel	2710	4	30
01/80→12/87	Patrol 260	4.165	Diesel	2710	4	30
	Patrol GR I 4.2 D	TD42	Diesel	4169	6	34
05/98→06/01	Patrol GR II Wagon 2.7 TD	TD27T	Diesel	2663	4	34
05/98→06/01	Patrol GR II Wagon 3.2 D	SD33	Diesel	3246	6	17
10/84→02/89	Patrol Hardtop 2.8 D	A428	Diesel	2820	4	32
12/83→02/89	Patrol Hardtop 2.8 D 4X4	A428	Diesel	2820	4	32
11/79→08/88	Patrol Hardtop 3.2 D	SD33	Diesel	3246	6	17
08/88→06/90	Patrol Hardtop 3.2 D	SD33T	Diesel	3246	6	17
07/83→08/88	Patrol Hardtop 3.2 TD	SD33T	Diesel	3246	6	17
06/80→12/87	Patrol Platform/Chassis 3.3 D 4x4	SD33	Diesel	3246	6	17
01/84→12/87	Patrol Platform/Chassis 3.3 TD 4x4	SD33T	Diesel	3246	6	17
	Patrol Station Wagon 2.8 D 4X4	A428	Diesel	2820	4	32
11/79→08/88	Patrol Station Wagon 3.2 D	SD33	Diesel	3246	6	17
08/88→06/90	Patrol Station Wagon 3.2 D	SD33T	Diesel	3246	6	17
07/83→08/88	Patrol Station Wagon 3.2 TD	SD33T	Diesel	3246	6	17
12/80→05/84	Pick Up 1.6	J16	Petrol	1567	4	12
01/83→03/86	Pick Up 1.8	L18	Petrol	1770	4	20
01/82→01/84	Pick Up 2.2 D	SD22	Diesel	2164	4	17
04/83→08/88	Pick Up 2.3 D	SD23	Diesel	2289	4	28
09/85→08/87	Pick Up 2.3 D 4WD	SD23	Diesel	2289	4	28
09/87→	Pick Up 2.5 D	TD25	Diesel	2494	4	31
04/83→08/91	Pick Up 2.5 D 4WD	SD25	Diesel	2488	4	28
08/87→	Pick Up 2.5 D 4WD	TD25	Diesel	2494	4	31
03/02→	Pick Up 2.5 Di	YD25DDTi	Diesel	2488	4	29
03/02→	Pick Up 2.5 Di 4WD	YD25DDTi	Diesel	2488	4	29
02/98→	Pick Up 2.7 D	TD27	Diesel	2663	4	34
08/87→02/98	Pick Up 2.7 D 4WD	TD27	Diesel	2663	4	34
09/87→10/01	Pick Up 2.7 TD	TD27T	Diesel	2663	4	34
09/87→10/01	Pick Up 2.7 TD 4WD	TD27T	Diesel	2663	4	34
11/01→	Pick Up 3.0 TD	ZD30	Diesel	2953	4	35
11/01→	Pick Up 3.0 TD 4WD	ZD30	Diesel	2953	4	35
01/72→	Pick-Up 1300	J13	Petrol	1299	4	4
01/84→12/87	Prairie 1.5 S	E15S	Petrol	1488	4	6
09/02→	Primastar Box dCi 100	F9Q 760	Diesel	1870	4	15
09/08→	Primastar Box dCi 115	G9U 720 Euro 3	Diesel	2463	4	25
09/06→	Primastar Box dCi 120	M9R 780 Euro 4	Diesel	1995	4	18
07/03→	Primastar Box dCi 140	G9U 730 Euro 3	Diesel	2463	4	25
03/01→	Primastar Bus dCi 100	F9Q 760	Diesel	1870	4	15

CCM
x

9

09/08→	Primastar Bus dCi 115	G9U 720 Euro 3	Diesel	2463	4	25
09/06→	Primastar Bus dCi 120	M9R 780 Euro 4	Diesel	1995	4	18
07/03→	Primastar Bus dCi 140	G9U 730 Euro 3	Diesel	2463	4	25
06/93→01/96	Primera 1.6	GA16DE	Petrol	1597	4	7
06/90→01/96	Primera 1.6	GA16DS	Petrol	1597	4	7
01/02→	Primera 1.6	QG16DE	Petrol	1597	4	9
09/96→12/01	Primera 1.6 16V	GA16DE	Petrol	1597	4	7
06/96→12/01	Primera 1.6 16V	QG16DE	Petrol	1597	4	9
03/02→	Primera 1.8	QG18DE	Petrol	1769	4	16
08/99→12/01	Primera 1.8 16V	QG18DE	Petrol	1769	4	16
03/02→	Primera 2.0	QR20DE	Petrol	1998	4	26
01/91→01/96	Primera 2.0 D	CD20	Diesel	1974	4	19
04/03→	Primera 2.2 dCi	YD22DDT	Diesel	2184	4	23
03/02→	Primera 2.2 Di	YD22DDT	Diesel	2184	4	23
01/02→	Primera 2.5	QR25DE	Petrol	2488	4	27
01/02→	Primera Estate 1.6 Visia	QG16DE	Petrol	1597	4	9
03/02→	Primera Estate 1.8	QG18DE	Petrol	1769	4	16
03/02→	Primera Estate 2.0	QR20DE	Petrol	1998	4	26
04/03→	Primera Estate 2.2 dCi	YD22DDT	Diesel	2184	4	23
03/02→	Primera Estate 2.2 Di	YD22DDT	Diesel	2184	4	23
06/93→01/96	Primera Hatchback 1.6	GA16DE	Petrol	1597	4	7
06/90→01/96	Primera Hatchback 1.6	GA16DS	Petrol	1597	4	7
07/02→	Primera Hatchback 1.6	QG16DE	Petrol	1597	4	9
09/96→07/02	Primera Hatchback 1.6 16V	GA16DE	Petrol	1597	4	7
09/00→07/02	Primera Hatchback 1.6 16V	QG16DE	Petrol	1597	4	9
07/02→	Primera Hatchback 1.8	QG18DE	Petrol	1769	4	16
08/99→07/02	Primera Hatchback 1.8 16V	QG18DE	Petrol	1769	4	16
07/02→	Primera Hatchback 2.0	QR20DE	Petrol	1998	4	26
01/91→01/96	Primera Hatchback 2.0 D	CD20	Diesel	1974	4	19
04/03→	Primera Hatchback 2.2 dCi	YD22DDT	Diesel	2184	4	23
07/02→	Primera Hatchback 2.2 Di	YD22DDT	Diesel	2184	4	23
01/02→	Primera Hatchback 2.5	QR25DE	Petrol	2488	4	27
04/98→12/01	Primera Traveller 1.6 16V	GA16DE	Petrol	1597	4	7
04/98→12/01	Primera Traveller 1.6 16V	QG16DE	Petrol	1597	4	9
03/94→03/98	Primera Traveller 1.6 i	GA16DE	Petrol	1597	4	7
07/90→03/98	Primera Traveller 1.6 i	GA16DS	Petrol	1597	4	7
08/99→12/01	Primera Traveller 1.8 16V	QG18DE	Petrol	1769	4	16
07/90→12/95	Primera Traveller 2.0 D	CD20	Diesel	1974	4	19
01/63→12/67	Q140 2000	SD20	Diesel	1991	4	17
02/07→	Qashqai / Qashqai +2 1.6	HR 16 DE	Petrol	1598	4	11
02/07→	Qashqai / Qashqai +2 2.0 dCi	M9R	Diesel	1995	4	18
02/07→	Qashqai / Qashqai +2 2.0 dCi All-wheel Drive	M9R	Diesel	1995	4	18
01/00→08/06	Sentra 1.8	QG18DE	Petrol	1769	4	16
06/02→08/06	Sentra 2.5	QR25DE	Petrol	2488	4	27
10/94→08/00	Serena 1.6	GA16DE	Petrol	1597	4	7
02/93→09/01	Serena 1.6 16V	GA16DE	Petrol	1597	4	7
11/92→09/01	Serena 2.0 D	LD20	Diesel	1952	4	21
02/06→	Serena 2.5	QR25DE	Petrol	2488	4	27
02/06→	Serena 2.5 4x4	QR25DE	Petrol	2488	4	27
06/99→	Serena 2.5 DCi SGX	YD25DDTi	Diesel	2488	4	29
06/99→	Serena 2.5 DCi SGX 4x4	YD25DDTi	Diesel	2488	4	29
08/81→07/84	Skyline 2.0 D	LD20	Diesel	1952	4	21
08/81→07/84	Skyline Estate 2.0 D	LD20	Diesel	1952	4	21
07/73→02/82	Sunny 1.2	A12	Diesel	1171	4	4
01/70→02/82	Sunny 1.4	A14	Diesel	1397	4	5
06/79→02/82	Sunny 1.5	A15	Petrol	1488	4	5
10/92→03/00	Sunny Box 1.6 i 16V	GA16DE	Petrol	1597	4	7
11/92→04/96	Sunny Box 1.6 L	GA16DE	Petrol	1597	4	7
11/90→03/00	Sunny Box 1.7 D	CD17	Diesel	1680	4	14
04/00→09/03	Sunny Coupe 1.8	QG18DE	Petrol	1769	4	16

MODEL INDEX

Modelverzeichnis • Index de modele • Índice de Modelo
Indeks modelu • Модель автомобиля • دليل الموديل



CCM

x



9

04/00→09/03	Sunny Hatchback 1.8	QG18DE	Petrol	1769	4	16
03/82→09/87	Sunny I 1.3	E13	Petrol	1270	4	6
03/82→05/86	Sunny I 1.5	E15	Petrol	1488	4	6
03/82→10/86	Sunny I 1.5	E15S	Petrol	1488	4	6
03/82→10/86	Sunny I 1.7 D	CD17	Diesel	1680	4	14
04/82→09/86	Sunny I Coupe 1.3	E13	Petrol	1270	4	6
03/82→10/86	Sunny I Coupe 1.5	E15S	Petrol	1488	4	6
08/82→08/90	Sunny I Traveller 1.3	E13	Petrol	1270	4	6
03/82→10/86	Sunny I Traveller 1.5	E15S	Petrol	1488	4	6
03/82→10/86	Sunny I Traveller 1.7 D	CD17	Diesel	1680	4	14
07/86→10/91	Sunny II 1.3	E13S	Petrol	1269	4	6
06/86→10/88	Sunny II 1.5	E15S	Petrol	1488	4	6
02/87→10/88	Sunny II 1.6	GA16DE	Petrol	1597	4	7
06/86→05/89	Sunny II 1.7 D	CD17	Diesel	1680	4	14
06/86→10/88	Sunny II Coupe 1.5	E15S	Petrol	1488	4	6
06/86→10/88	Sunny II Hatchback 1.3	E13S	Petrol	1269	4	6
06/86→10/88	Sunny II Hatchback 1.5	E15S	Petrol	1488	4	6
02/87→10/88	Sunny II Hatchback 1.6	GA16DE	Petrol	1597	4	7
06/86→01/91	Sunny II Hatchback 1.7 D	CD17	Diesel	1680	4	14
06/86→10/88	Sunny II Traveller 1.5	E15S	Petrol	1488	4	6
01/86→06/91	Sunny II Traveller 1.7 D	CD17	Diesel	1680	4	14
08/90→10/94	Sunny III 1.6	GA16DE	Petrol	1597	4	7
10/90→05/95	Sunny III 1.6 i	GA16DE	Petrol	1597	4	7
10/90→05/95	Sunny III 1.6 i	GA16DS	Petrol	1597	4	7
10/92→05/95	Sunny III 1.6 i 16V	GA16DE	Petrol	1597	4	7
10/90→05/95	Sunny III 1.6 i 16V 4WD	GA16DS	Petrol	1597	4	7
10/90→05/95	Sunny III 2.0 D	CD20	Diesel	1974	4	19
10/90→05/95	Sunny III Hatchback 1.6 i	GA16DE	Petrol	1597	4	7
10/90→05/95	Sunny III Hatchback 1.6 i	GA16DS	Petrol	1597	4	7
10/92→05/95	Sunny III Hatchback 1.6 i 16V	GA16DE	Petrol	1597	4	7
10/92→05/95	Sunny III Hatchback 1.6 i 16V 4x4	GA16DE	Petrol	1597	4	7
10/90→05/95	Sunny III Hatchback 2.0 D	CD20	Diesel	1974	4	19
10/90→05/95	Sunny III Liftback 1.6 i	GA16DE	Petrol	1597	4	7
10/90→05/95	Sunny III Liftback 1.6 i	GA16DS	Petrol	1597	4	7
10/92→05/95	Sunny III Liftback 1.6 i 16V	GA16DE	Petrol	1597	4	7
10/90→05/95	Sunny III Liftback 2.0 D	CD20	Diesel	1974	4	19
07/95→03/00	Sunny III Traveller 1.6	GA16DE	Petrol	1597	4	7
11/90→05/95	Sunny III Traveller 1.6 16V 4x4	GA16DS	Petrol	1597	4	7
06/91→03/00	Sunny III Traveller 1.6 i	GA16DE	Petrol	1597	4	7
06/91→03/00	Sunny III Traveller 1.6 i	GA16DS	Petrol	1597	4	7
10/92→03/00	Sunny III Traveller 1.6 i 16V 4x4	GA16DE	Petrol	1597	4	7
06/91→03/00	Sunny III Traveller 2.0 D	CD20	Diesel	1974	4	19
04/00→09/03	Sunny Saloon 1.8	QG18DE	Petrol	1769	4	16
06/79→02/82	Sunny Traveller 1.4	A14	Diesel	1397	4	5
06/79→02/82	Sunny Traveller 1.5	A15	Petrol	1488	4	5
08/12→	Sylphy 1.6	HR 16 DE	Petrol	1598	4	11
10/03→06/08	Teana I 2.0	QR20DE	Petrol	1998	4	26
02/89→02/96	Terrano I 2.7 TD 4WD	TD27T	Diesel	2663	4	34
02/93→01/02	Terrano II 2.7 TD 4WD	TD27T	Diesel	2663	4	34
05/02→	Terrano II 3.0 Di 4WD	ZD30	Diesel	2953	4	35
04/03→	Terrano Van 3.0 Di 4WD	ZD30	Diesel	2953	4	35
09/07→	Tiida Hatchback 1.5 dCi	K9K 728	Diesel	1461	4	8
09/07→	Tiida Hatchback 1.6	HR 16 DE	Petrol	1598	4	11
09/07→	Tiida Saloon 1.6	HR 16 DE	Petrol	1598	4	11
01/69→12/73	Tractor 10300	PD6	Diesel	10308	6	36
11/86→10/98	Trade Box 2.0 D	LD20	Diesel	1952	4	21
11/86→10/98	Trade Platform/Chassis 2.0 D	LD20	Diesel	1952	4	21
11/98→09/04	Trade Platform/Chassis 2.7 TD	TD27T	Diesel	2663	4	34
12/86→06/94	Trade Platform/Chassis 2.8 D	A428II	Diesel	2820	4	33
01/69→12/88	Truck 10300	PD6	Diesel	10308	6	36

Modelverzeichnis • Index de modele • Índice de Modelo
Indeks modelu • Модель автомобиля • دليل الموديل

MODEL INDEX



CCM

x



9

02/92→09/94	Urvan Box 2.0 D	LD20	Diesel	1952	4	21
07/81→11/82	Urvan Box 2.2 D	SD22	Diesel	2164	4	17
11/82→05/87	Urvan Box 2.3 D	SD23	Diesel	2289	4	28
12/88→05/97	Urvan Box 2.5 D	TD25	Diesel	2494	4	31
02/92→04/97	Urvan Box 3.2 D	SD33	Diesel	3246	6	17
02/92→04/97	Urvan Box 3.2 TD	SD33T	Diesel	3246	6	17
04/85→11/88	Urvan Bus 2.3 D	SD23	Diesel	2289	4	28
05/89→10/96	Urvan Bus 2.5 D	TD25	Diesel	2494	4	31
03/87→09/93	Urvan Bus 2.7 D	TD27	Diesel	2663	4	34
02/92→04/97	Urvan Bus 3.2 TD	SD33T	Diesel	3246	6	17
11/82→06/87	Vanette Box 2.0 D	LD20	Diesel	1952	4	21
	Vanette Box 2.0 D	LD20IIL	Diesel	1952	4	21
01/83→12/87	Vanette Bus 1.5	A15	Petrol	1488	4	5
01/86→12/95	Vanette Bus 2.0 D	LD20	Diesel	1952	4	21
01/95→	Vanette Cargo Box 1.6 i	GA16DE	Petrol	1597	4	7
01/95→	Vanette Cargo Box 2.0 D	LD20	Diesel	1952	4	21
01/96→	Vanette Cargo Bus 1.6 i	GA16DE	Petrol	1597	4	7
01/96→	Vanette Cargo Bus 2.0 D	LD20	Diesel	1952	4	21
01/63→12/67	VRE20 2000	SD20	Diesel	1991	4	17
07/01→	X-Trail 2.0	QR20DE	Petrol	1998	4	26
07/01→	X-Trail 2.0 4x4	QR20DE	Petrol	1998	4	26
06/07→	X-Trail 2.0 dCi	M9R	Diesel	1995	4	18
06/07→	X-Trail 2.0 dCi	M9R 760	Diesel	1995	4	18
06/07→	X-Trail 2.0 dCi FWD	M9R	Diesel	1995	4	18
12/03→	X-Trail 2.2 dCi	YD22DDTi	Diesel	2184	4	23
12/03→	X-Trail 2.2 dCi 4x4	YD22DDTi	Diesel	2184	4	23
06/01→09/03	X-Trail 2.2 DCi FWD	YD22DDTi	Diesel	2184	4	23
07/01→	X-Trail 2.2 Di 4x4	YD22ETI	Diesel	2184	4	23
06/07→	X-Trail 2.5	QR25DE	Petrol	2488	4	27
09/02→	X-Trail 2.5 4x4	QR25DE	Petrol	2488	4	27

ENGINE INDEX

Motorverzeichnis • Index de moteur • Índice de Motor
Indeks silnika • Модель двигателя • دليل المحرك



CCM



9

4.165	Diesel	2710	4	92.00	30
A10	Petrol	988	4	73.00	4
A12	Diesel	1171	4	73.00	4
A14	Diesel	1397	4	76.00	5
A15	Petrol	1488	4	76.00	5
A428	Diesel	2820	4	94.00	32
A428II	Diesel	2820	4	94.00	33
BD30	Diesel	2953	4	96.00	34
CD17	Diesel	1680	4	80.00	14
CD20	Diesel	1974	4	84.50	19
D4F 712	Petrol	1149	4	69.00	2
D7F 764	Petrol	1149	4	69.00	3
E1	Petrol	1189	4	73.00	4
E10	Petrol	988	4	73.00	4
E13	Petrol	1270	4	76.00	6
E13S	Petrol	1269	4	76.00	6
E15	Petrol	1488	4	76.00	6
E15S	Petrol	1488	4	76.00	6
F9Q 760	Diesel	1870	4	80.00	15
G9T 722	Diesel	2188	4	87.00	24
G9U 720 Euro 3	Diesel	2463	4	89.00	25
G9U 730 Euro 3	Diesel	2463	4	89.00	25
G18	Petrol	1817	4	85.00	20
GA16DE	Petrol	1597	4	76.00	7
GA16DS	Petrol	1597	4	76.00	7
HR 16 DE	Petrol	1598	4	78.00	11
J	Petrol	1299	4	73.00	4
J13	Petrol	1299	4	73.00	4
J15	Petrol	1483	4	78.00	12
J16	Petrol	1567	4	78.00	12
J20	Petrol	1973	6	73.00	4
K4M 752	Petrol	1598	4	79.50	13
K9K 700	Diesel	1461	4	76.00	8
K9K 704 Euro 3	Diesel	1461	4	76.00	8
K9K 710	Diesel	1461	4	76.00	8
K9K 714	Diesel	1461	4	76.00	8
K9K 722 Euro 3	Diesel	1461	4	76.00	8
K9K 728	Diesel	1461	4	76.00	8
L18	Petrol	1770	4	85.00	20
L20B	Petrol	1952	4	85.00	20
LD20	Diesel	1952	4	85.00	21
LD20IIL	Diesel	1952	4	85.00	21
M9R	Diesel	1995	4	84.00	18
M9R 760	Diesel	1995	4	84.00	18
M9R 780 Euro 4	Diesel	1995	4	84.00	18
M9T 670 Euro 5	Diesel	2298	4	85.00	22
M9T 672 Euro 5	Diesel	2298	4	85.00	22
M9T 676 Euro 4	Diesel	2298	4	85.00	22
M9T 678	Diesel	2298	4	85.00	22
M9T 680	Diesel	2298	4	85.00	22
M9T 686 Euro 5	Diesel	2298	4	85.00	22
M9T 690 Euro 5	Diesel	2298	4	85.00	22
M9T 692 Euro 4	Diesel	2298	4	85.00	22
M9T 694 Euro 4	Diesel	2298	4	85.00	22
M9T 696 Euro 4	Diesel	2298	4	85.00	22
M9T 698 Euro 5	Diesel	2298	4	85.00	22
MA10	Petrol	988	4	68.00	1
MA10S	Petrol	988	4	68.00	1
PD6	Diesel	10308	6	125.00	36
QG16DE	Petrol	1597	4	76.00	9

Motorverzeichnis • Index de moteur • Índice de Motor
Indeks silnika • Модель двигателя • دليل المحرك

ENGINE INDEX



CCM

x



9

QG18DE	Petrol	1769	4	80.00	16
QR20DE	Petrol	1998	4	89.00	26
QR25DE	Petrol	2488	4	89.00	27
SD20	Diesel	1991	4	83.00	17
SD22	Diesel	2164	4	83.00	17
SD23	Diesel	2289	4	89.00	28
SD25	Diesel	2488	4	89.00	28
SD33	Diesel	3246	6	83.00	17
SD33T	Diesel	3246	6	83.00	17
TD15 (TUD5)	Diesel	1527	4	77.00	10
TD25	Diesel	2494	4	92.90	31
TD27	Diesel	2663	4	96.00	34
TD27T	Diesel	2663	4	96.00	34
TD42	Diesel	4169	6	96.00	34
YD22DDT	Diesel	2184	4	86.00	23
YD22DDTi	Diesel	2184	4	86.00	23
YD22ETi	Diesel	2184	4	86.00	23
YD25DDTi	Diesel	2488	4	89.00	29
ZD30	Diesel	2953	4	96.00	35



Micra I 1.0				MA10				1
					4cyl.			
					988cc		38kW (52PS)	
								TD2492

BE 1.0	12/82→07/92			MA10S				
Micra I 1.0	12/82→12/89				4cyl.			
Micra II 1.0	01/92→04/93				988cc		37-40kW (50-54PS)	
								TD2493

08-294700-00	STD	68.00	1.500		001 IF CR P		IKA
08-294707-00	0.50mm		1.500		005 P		STD
<i>[R41870]</i>			2.800		236 P		STD

Kubistar 1.2 16V, Kubistar Box 1.2 16V	04/06→			D4F 712				2
					4cyl.			
					1149cc		55kW (75PS)	
								TD18984

08-450000-00	STD	69.00	1.200		001 NT		ST
08-450007-00	0.50mm		1.500		005 IFU P		STD
			2.500		712 CR		ST

Kubistar 1.2, Kubistar Box 1.2	08/03→			D7F 764				3
					4cyl.			
					1149cc		44kW (60PS)	
								TD22375

08-104100-00	STD	69.00	1.500		001 IF CR P		KV1
08-104105-00	0.25mm		1.500		005 IFU P		STD
08-104107-00	0.50mm		2.500		231 CR P		STD
<i>[R60510]</i>							

Cherry 1.0	09/70→09/78			A10				4
Cherry II Coupe 1.0,	08/78→07/81				4cyl.			
Cherry II Traveller 1.0					988cc		33kW (45PS)	
Datsun 100 A 1.0	12/74→06/78							
Datsun 100 A F-II 1.0,	12/75→08/80							
Datsun 100 A Estate F-II 1.0								TD11047

Cherry II Coupe 1.2,	08/78→07/81			A12				
Cherry II Hatchback 1.2					4cyl.			
Cherry II Traveller 1.2	10/78→07/81				1171cc		38kW (52PS)	
Datsun 120 A F-II 1.2	12/75→07/80							
Datsun 120 Y 1.2	09/74→07/80							
Datsun 120 Y Coupe 1.2	04/62→07/80							
Datsun 120 Y Coupe A F-II 1.2	12/75→08/80							
Sunny 1.2	07/73→02/82							TD2383

Bluebird 1200	01/60→12/65			E1				
					4cyl.			
					1189cc			
								FM393

Cherry II Traveller 1.0	08/81→05/82			E10				
Cherry III 1.0	05/82→05/86				4cyl.			
					988cc		37kW (50PS)	
								TD2424





Bluebird 1300		01/58→12/69	J		4cyl. 1299cc		FM394
Pick-Up 1300		01/72→	J13		4cyl. 1299cc	46-50kW (63-68PS)	TD2454
Cedric 2000		01/66→12/69	J20		6cyl. 1973cc		FM395
08-291400-00	STD	73.00	2.000		001 CR P		STD
			2.000		026 P		STD
			3.947		236 P		STD
Cherry II Coupe 1.4		08/80→02/81	A14				5
Cherry II Hatchback 1.4		08/78→07/81			4cyl. 1397cc	48-49kW (65-67PS)	
Datsun 140 Y Estate 1.4		02/79→06/83					
Sunny 1.4		01/70→02/82					
Sunny Traveller 1.4		06/79→02/82					
Sunny 1.5, Sunny Traveller 1.5		06/79→02/82	A15				5
Vanette Bus 1.5		01/83→12/87			4cyl. 1488cc	51kW (69PS)	
08-294900-00	STD	76.00	1.200		001 CR P		IKA
			2.000		026 P		STD
			4.000		236 P		STD
Cherry II Coupe 1.3, Cherry II Hatchback 1.3		08/81→09/82	E13				6
Cherry II Traveller 1.3		09/81→12/83			4cyl. 1270cc	44kW (60PS)	
Cherry III 1.3		05/82→10/86					
Sunny I 1.3		03/82→09/87					
Sunny I Coupe 1.3		04/82→09/86					
Sunny I Traveller 1.3		08/82→08/90					
AD Van 1.3		10/81→08/88	E13S				6
Sunny II 1.3		07/86→10/91			4cyl. 1269cc	44kW (60PS)	
Sunny II Hatchback 1.3		06/86→10/88					
Cherry II Coupe 1.5		08/81→05/82	E15				6
Cherry II Hatchback 1.5		08/81→12/82			4cyl. 1488cc	51kW (69PS)	
Cherry II Traveller 1.5		08/81→03/82					
Sunny I 1.5		03/82→05/86					





AD Van 1.5	10/81→08/88	E15S		
Cherry III 1.5	11/83→10/86		4cyl.	
Prairie 1.5 S	01/84→12/87		1488cc	52-55kW (71-75PS)
Sunny I 1.5, Sunny I Coupe 1.5, Sunny I Traveller 1.5	03/82→10/86			
Sunny II 1.5, Sunny II Coupe 1.5, Sunny II Hatchback 1.5, Sunny II Traveller 1.5	06/86→10/88			TD2429

08-294400-00	STD	76.00	1.500		001 CR P	KV1
[R40390]			1.500		026 P	STD
			4.000		236 P	STD

100 NX 1.6 SR	09/93→10/94	GA16DE			7
AD Wagon 1.6	05/99→08/04		4cyl.		
Almera I 1.6	07/95→07/00		1597cc	66-75kW (90-102PS)	
Almera I 1.6 SLX	09/95→07/00				
Almera I Hatchback 1.6	07/95→03/00				
Almera I Hatchback 1.6 SR, SLX	09/95→03/00				
Almera II 1.6, Almera II Hatchback 1.6	07/00→02/03				
Lucino Hatchback 1.6	10/92→01/00				
Lucino Saloon 1.6	11/95→01/00				
Primera 1.6	06/93→01/96				
Primera 1.6 16V	09/96→12/01				
Primera Hatchback 1.6	06/93→01/96				
Primera Hatchback 1.6 16V	09/96→07/02				
Primera Traveller 1.6 16V	04/98→12/01				
Primera Traveller 1.6 i	03/94→03/98				
Serena 1.6	10/94→08/00				
Serena 1.6 16V	02/93→09/01				
Sunny Box 1.6 i 16V	10/92→03/00				
Sunny Box 1.6 L	11/92→04/96				
Sunny II 1.6, Sunny II Hatchback 1.6	02/87→10/88				
Sunny III 1.6	08/90→10/94				
Sunny III 1.6 i	10/90→05/95				
Sunny III 1.6 i 16V	10/92→05/95				
Sunny III Hatchback 1.6 i	10/90→05/95				
Sunny III Hatchback 1.6 i 16V, Sunny III Hatchback 1.6 i 16V 4x4	10/92→05/95				
Sunny III Liftback 1.6 i	10/90→05/95				
Sunny III Liftback 1.6 i 16V	10/92→05/95				
Sunny III Traveller 1.6	07/95→03/00				
Sunny III Traveller 1.6 i	06/91→03/00				
Sunny III Traveller 1.6 i 16V 4x4	10/92→03/00				
Vanette Cargo Box 1.6 i	01/95→				
Vanette Cargo Bus 1.6 i	01/96→				TD4705





100 NX 1.6	03/90→10/94	GA16DS			
AD Wagon 1.6	10/90→04/99		4cyl.		
Lucino Hatchback 1.6	09/91→10/92		1597cc	64kW (87PS)	
Primera 1.6, Primera Hatchback 1.6	06/90→01/96				
Primera Traveller 1.6 i	07/90→03/98				
Sunny III 1.6 i, Sunny III 1.6 i 16V 4WD,	10/90→05/95				
Sunny III Hatchback 1.6 i,					
Sunny III Liftback 1.6 i					
Sunny III Traveller 1.6 16V 4x4	11/90→05/95				
Sunny III Traveller 1.6 i	06/91→03/00				TD4706

08-527000-00	STD	76.00	1.500		001 P NT	ST
[R45040]			1.500		005 P	GOE12
			3.000		712 CR	ST

Kubistar 1.5 dCi 70	04/06→	K9K 700				8
Note 1.5 dCi	03/06→		4cyl.			
			1461cc	48-50kW (65-68PS)		
			Diesel	Turbo Intercooled		TD21368

		K9K 702				
			4cyl.			
			1461cc	60kW (81PS)		
			Diesel			TD23878

Kubistar 1.5 dCi, Kubistar Box 1.5 dCi	08/03→	K9K 704 Euro 3				
Micra III 1.5 dCi	01/03→06/10		4cyl.			
			1461cc	48kW (65PS)		
			Diesel	Turbo		TD17660

Kubistar 1.5 dCi	08/03→	K9K 710				
Kubistar Box 1.5 dCi	08/05→		4cyl.			
			1461cc	42-45kW (57-61PS)		
			Diesel	Turbo Intercooled		TD26066

Kubistar 1.5 dCi	08/03→	K9K 714				
Kubistar Box 1.5 dCi	08/05→		4cyl.			
			1461cc	42-45kW (57-61PS)		
			Diesel	Turbo Intercooled		TD26067

Almera II 1.5 dCi,	01/03→	K9K 722 Euro 3				
Almera II Hatchback 1.5 dCi			4cyl.			
Kubistar 1.5 dCi, Kubistar Box 1.5 dCi	08/03→		1461cc	60kW (81PS)		
Micra III 1.5 dCi	09/03→06/10	Diesel	Turbo Intercooled			TD20971

Tiida Hatchback 1.5 dCi	09/07→	K9K 728				
			4cyl.			
			1461cc	74-78kW (101-106PS)		
			Diesel	Turbo Intercooled		TD24669

08-123400-00	STD	76.00	2.000		001 IF CK P	KV1
08-123407-00	0.50mm		2.000		005 IFU P	GOE13
[R60620]			2.500		231 NT	GOE13



Almera Classic 1.6 16V	03/06→	QG16DE							
Almera II 1.6	07/00→02/03		4cyl.						9
Avenir 1.6	11/97→		1597cc	78-80kW (106-109PS)					
Bluebird SYLPHY 1.6	08/00→08/05								
Primera 1.6	01/02→								
Primera 1.6 16V	06/96→12/01								
Primera Estate 1.6 Visia	01/02→								
Primera Hatchback 1.6	07/02→								
Primera Hatchback 1.6 16V	09/00→07/02								
Primera Traveller 1.6 16V	04/98→12/01								TD16317

08-439400-00	STD	76.00	1.200		001 CR P		ST
			1.200		005 P		STD
			2.500		712 CR		ST

Micra II 1.5 D	02/98→02/03	TD15 (TUD5)							10
			4cyl.						
			1527cc	42kW (57PS)					
			Diesel						TD16316

08-325800-00	STD	77.00	2.000		001 CK P		KV1
08-325806-00	0.40mm		1.750		005 P		STD
[R49960]			3.000		231 CR P		STD

Cube 1.6 16V	03/10→	HR 16 DE							11
Juke 1.6	06/10→		4cyl.						
Latio Saloon 1.6	03/07→		1598cc	81kW (110PS)					
Livina /Grand Livina 1.6	02/07→								
Micra C+C 1.6 160 SR	08/05→								
Micra III 160 SR	05/05→06/10								
Note 1.6	03/06→								
NV200 Box 1.6 16V	02/10→								
NV200 Evalia 1.6 16V	07/10→								
Qashqai / Qashqai +2 1.6	02/07→								
Sylphy 1.6	08/12→								
Tiida Hatchback 1.6, Tiida Saloon 1.6	09/07→								TD18677

08-440100-00	STD	78.00	1.200		001 CR		ST
			1.200		005 P		STD
			2.000		712 CR		ST

Cabstar/Cedric/Homer	01/70→	J15							12
			4cyl.						
			1483cc	57kW (77PS)					
									TD2455

Pick Up 1.6	12/80→05/84	J16							
			4cyl.						
			1567cc	51kW (69PS)					
									TD2456

08-293400-00	STD	78.00	2.000		001 CR P		STD
[R40400]			2.000		026 P		STD
			4.000		712 CR		ST



Kubistar 1.6 16V, Kubistar Box 1.6 16V		08/03→	K4M 752		4cyl.		13
					1598cc	70kW (95PS)	
							TD21398

08-104200-00	STD	79.50	1.500		001 IF CR P	KV1
08-104207-00	0.50mm		1.500		026 P	STD
[R60240]			2.500		712 CR	ST

AD Van 1.7 D		10/84→	CD17		4cyl.		14
AD Wagon 1.7 D		10/90→08/04			1680cc	40kW (54PS)	
Cherry III 1.7 D		10/82→12/86					
Sunny Box 1.7 D		11/90→03/00		Diesel			
Sunny I 1.7 D, Sunny I Traveller 1.7 D		03/82→10/86					
Sunny II 1.7 D		06/86→05/89					
Sunny II Hatchback 1.7 D		06/86→01/91					
Sunny II Traveller 1.7 D		01/86→06/91					TD2419

08-294800-00	STD	80.00	1.750		001 CR P	KV1
[R42700]			2.000		005 P	STD
			3.000		232 P	STD

Primastar Box dCi 100		09/02→	F9Q 760		4cyl.		15
Primastar Bus dCi 100		03/01→			1870cc	74kW (100PS)	
					Diesel Turbo		TD20980

08-113700-00	STD	80.00	2.500		001 IF CK P	KV1
			2.000		005 IFU P	IKA
			3.000		231 CR P	STD

AD Wagon 1.8		05/99→08/04	QG18DE		4cyl.		16
Almera I 1.8		07/95→05/00			1769cc	84-93kW (114-126PS)	
Almera II 1.8		07/00→					
Almera II Hatchback 1.8		01/00→					
Almera Tino 1.8		08/00→					
Avenir 1.8		11/97→					
Bluebird SYLPHY 1.8		08/02→08/05					
Bluebird SYLPHY 1.8 4x4		08/00→07/02					
Expert 1.8		10/98→04/04					
Primera 1.8		03/02→					
Primera 1.8 16V		08/99→12/01					
Primera Estate 1.8		03/02→					
Primera Hatchback 1.8		07/02→					
Primera Hatchback 1.8 16V		08/99→07/02					
Primera Traveller 1.8 16V		08/99→12/01					
Sentra 1.8		01/00→08/06					
Sunny Coupe 1.8, Sunny Hatchback 1.8, Sunny Saloon 1.8		04/00→09/03					TD11487

08-435800-00	STD	80.00	1.200		001 CR	ST
08-435807-00	0.50mm		1.200		026 P	ST
			2.500		712 CR	ST



Cedric, Cedric 2000	01/63→12/77	SD20				17
Homer, Homer 2000, Junior 2000 Wagon, KRSE20 2000	01/63→12/67		4cyl.	1991cc		
Laurel, Laurel 200D	01/79→12/83	Diesel				
Q140 2000, VRE20 2000	01/63→12/67				FM1271	
Pick Up 2.2 D	01/82→01/84	SD22				TD2512
Urvan Box 2.2 D	07/81→11/82		4cyl.	2164cc	47kW (64PS)	
		Diesel				
Homy Box 3.2 D, Homy Platform/Chassis 3.2 D	10/93→10/97	SD33				TD2515
Patrol GR II Wagon 3.2 D	05/98→06/01		6cyl.	3246cc	70kW (85PS)	
Patrol Hardtop 3.2 D	11/79→08/88	Diesel				
Patrol Platform/Chassis 3.3 D 4x4	06/80→12/87					
Patrol Station Wagon 3.2 D	11/79→08/88					
Urvan Box 3.2 D	02/92→04/97					
Patrol Hardtop 3.2 D	08/88→06/90	SD33T				TD2516
Patrol Hardtop 3.2 TD	07/83→08/88		6cyl.	3246cc	81-88kW (110-120PS)	
Patrol Platform/Chassis 3.3 TD 4x4	01/84→12/87					
Patrol Station Wagon 3.2 D	08/88→06/90	Diesel	Turbo			
Patrol Station Wagon 3.2 TD	07/83→08/88					
Urvan Box 3.2 TD, Urvan Bus 3.2 TD	02/92→04/97					

08-292800-00	STD	83.00	2.500		001 IF CR P	KV1
[R39150]			2.000		005 IF	STD
			2.000		005 IF	STD
			4.500		231 CR P	STD
			4.500		031	STD

Qashqai / Qashqai +2 2.0 dCi, Qashqai / Qashqai +2 2.0 dCi All-wheel Drive	02/07→	M9R				18
X-Trail 2.0 dCi, X-Trail 2.0 dCi FWD	06/07→		4cyl.	1995cc	110kW (150PS)	
		Diesel			TD22892	
X-Trail 2.0 dCi	06/07→	M9R 760				TD20981
			4cyl.	1995cc	127kW (173PS)	
		Diesel				
Primastar Box dCi 120, Primastar Bus dCi 120	09/06→	M9R 780 Euro 4				TD20890
			4cyl.	1995cc	66-84kW (90-114PS)	
		Diesel	Turbo Intercooled			

08-422000-00	STD	84.00	2.500		007 MOL P	KV1
08-422007-00	0.50mm		2.000		005 IFU MOL P	GOE12
			2.000		231 CR P	GOE12



AD Van 2.0 D	10/94→04/99	CD20						19
Almera I 2.0 D	11/95→07/00		4cyl.					
Almera I Hatchback 2.0 D	11/95→03/00		1974cc	55kW (75PS)				
Lucino Saloon 2.0 D	11/97→01/00	Diesel						
Primera 2.0 D, Primera Hatchback 2.0 D	01/91→01/96							
Primera Traveller 2.0 D	07/90→12/95							
Sunny III 2.0 D,	10/90→05/95							
Sunny III Hatchback 2.0 D,								
Sunny III Liftback 2.0 D								
Sunny III Traveller 2.0 D	06/91→03/00						TD4698	

08-106800-00	STD	84.50	2.000		001 IF CR P		KV1	
08-106807-00	0.50mm					005 IW CR P		IKA
[R60250]				3.000		231 CR P		STD

Bluebird 1800	01/72→12/81	G18						20
			4cyl.	1817cc	81kW (110PS)			
								TD2439

Bluebird 1.8	04/72→11/79	L18						20
Pick Up 1.8	01/83→03/86		4cyl.	1770cc	59-65kW (80-88PS)			
								TD2466

Bluebird 2.0	05/81→03/85	L20B						20
			4cyl.	1952cc	81kW (110PS)			
								TD2471

08-293500-10	STD	85.00	2.000		001 IF CR P		STD	
				2.000		026 P		STD
				4.000		712 CR		ST

Bluebird 2.0 D	01/80→03/97	LD20						21
Bluebird Hatchback 2.0 D	03/86→12/90		4cyl.					
Bluebird Station Wagon 2.0 D	04/84→12/90		1952cc	43-49kW (58-67PS)				
Bluebird Traveller 2.0 D	01/80→05/84	Diesel						
Bobby Box 2.0 DX, Bobby Bus 2.0 DLX	11/87→11/94							
Laurel 2.0 D	04/81→10/84							
Serena 2.0 D	11/92→09/01							
Skyline 2.0 D, Skyline Estate 2.0 D	08/81→07/84							
Trade Box 2.0 D, Trade Platform/	11/86→10/98							
Chassis 2.0 D								
Urvan Box 2.0 D	02/92→09/94							
Vanette Box 2.0 D	11/82→06/87							
Vanette Bus 2.0 D	01/86→12/95							
Vanette Cargo Box 2.0 D	01/95→							
Vanette Cargo Bus 2.0 D	01/96→						TD2482	

Vanette Box 2.0 D		LD20IIL						21
			4cyl.	1952cc	47-49kW (64-67PS)			
			Diesel					TD2488

08-295400-00	STD	85.00	2.000		001 IF CR P		KV1	
[R42720]				2.000		005 IF P		STD
				4.000		231 CR P		STD



NV400 Box 2.3 dCi, NV400 Bus 2.3 dCi, NV400 Platform/Chassis 2.3 dCi	11/11→	M9T 670 Euro 5 4cyl. 2298cc 74-92kW (101-125PS) Diesel Turbo Intercooled	22	TD26543
NV400 Box 2.3 dCi, NV400 Bus 2.3 dCi, NV400 Platform/Chassis 2.3 dCi	11/11→	M9T 672 Euro 5 4cyl. 2298cc 74-92kW (101-125PS) Diesel Turbo Intercooled		TD26768
NV400 Box 2.3 dCi, NV400 Bus 2.3 dCi, NV400 Platform/Chassis 2.3 dCi	11/11→	M9T 676 Euro 4 4cyl. 2298cc 74-92kW (101-125PS) Diesel Turbo Intercooled		TD26769
NV400 Box 2.3 dCi, NV400 Bus 2.3 dCi, NV400 Platform/Chassis 2.3 dCi	11/11→	M9T 678 4cyl. 2298cc 107kW (146PS) Diesel Turbo Intercooled		TD26770
NV400 Box 2.3 dCi, NV400 Bus 2.3 dCi, NV400 Platform/Chassis 2.3 dCi	11/11→	M9T 680 4cyl. 2298cc 107kW (146PS) Diesel Turbo Intercooled		TD26771
NV400 Box 2.3 dCi [RWD], NV400 Platform/ Chassis 2.3 dCi [RWD]	11/11→	M9T 686 Euro 5 4cyl. 2298cc 92kW (125PS) Diesel Turbo Intercooled		TD26772
NV400 Box 2.3 dCi [RWD], NV400 Platform/ Chassis 2.3 dCi [RWD]	11/11→	M9T 690 Euro 5 4cyl. 2298cc 74-92kW (101-125PS) Diesel Turbo Intercooled		TD26544
NV400 Box 2.3 dCi [RWD], NV400 Platform/ Chassis 2.3 dCi [RWD]	11/11→	M9T 692 Euro 4 4cyl. 2298cc 92kW (125PS) Diesel Turbo Intercooled		TD26773
NV400 Box 2.3 dCi [RWD], NV400 Platform/ Chassis 2.3 dCi [RWD]	11/11→	M9T 694 Euro 4 4cyl. 2298cc 107kW (146PS) Diesel Turbo Intercooled		TD26774
NV400 Box 2.3 dCi [RWD], NV400 Platform/ Chassis 2.3 dCi [RWD]	11/11→	M9T 696 Euro 4 4cyl. 2298cc 92-107kW (125-146PS) Diesel Turbo Intercooled		TD26775
NV400 Box 2.3 dCi [RWD], NV400 Platform/ Chassis 2.3 dCi [RWD]	11/11→	M9T 698 Euro 5 4cyl. 2298cc 92-107kW (125-146PS) Diesel Turbo Intercooled		TD26776

08-435200-00	STD	85.00	2.500		007 GDC P	KV1
08-435207-00	0.50mm		2.000		005 IF MO P	GOE13
			2.000		231 CR P	GOE13



Almera II 2.2 dCi				09/03→	YD22DDT		23
Almera II 2.2 Di				07/00→		4cyl.	
Almera II Hatchback 2.2 dCi				09/03→		2184cc 81-102kW (110-139PS)	
Almera II Hatchback 2.2 Di				03/00→	Diesel	Turbo Intercooled	
Almera Tino 2.2 dCi				09/03→			
Primera 2.2 dCi				04/03→			
Primera 2.2 Di				03/02→			
Primera Estate 2.2 dCi				04/03→			
Primera Estate 2.2 Di				03/02→			
Primera Hatchback 2.2 dCi				04/03→			
Primera Hatchback 2.2 Di				07/02→		TD16314	
Almera II 2.2 dCi,				09/03→	YD22DDTi		24
Almera II Hatchback 2.2 dCi,						4cyl.	
Almera Tino 2.2 dCi						2184cc 84-100kW (114-136PS)	
Almera Tino 2.2 Di				08/00→	Diesel	Turbo Intercooled	
X-Trail 2.2 dCi, X-Trail 2.2 dCi 4x4				12/03→			
X-Trail 2.2 DCi FWD				06/01→09/03		TD16229	
X-Trail 2.2 Di 4x4				07/01→	YD22ETI		25
						4cyl. 2184cc 84kW (114PS)	
					Diesel	Turbo Intercooled	TD16320
08-440300-00	STD	86.00	2.000		007 NT	ST	
			2.000		005 IW P	STD	
			3.000		231 NT	ST	
08-440300-10	STD	86.00	1.750		007 NT	ST	
			1.500		005 IF CR P	STD	
			3.000		231 NT	ST	
Interstar Box dCi 90,				07/02→	G9T 722		24
Interstar Bus dCi 90						4cyl. 2188cc 66kW (89PS)	
					Diesel	Turbo Intercooled	TD19379
08-127400-00	STD	87.00	3.000		007 P PS	KV1	
08-127407-00	0.50mm		1.750		005 IFU P	IKA	
[R66780]			2.500		236 P	IKA	
Interstar Box dCi 100				11/03→	G9U 720 Euro 3		25
Interstar Box dCi 120				07/02→		4cyl.	
Interstar Bus dCi 100				11/03→		2463cc 84kW (114PS)	
Interstar Bus dCi 120				07/02→	Diesel	Turbo Intercooled	
Interstar Platform/Chassis dCi 100				02/04→			
Interstar Platform/Chassis dCi 120				08/03→			
Primastar Box dCi 115,				09/08→			
Primastar Bus dCi 115						TD21010	





Primastar Box dCi 140, Primastar Bus dCi 140		07/03→	G9U 730 Euro 3		4cyl. 2463cc 99kW (135PS)		
				Diesel	Turbo Intercooled		TD18702
08-137500-10	STD	89.00	2.500		001 IF MO P		KV1
08-137507-10	0.50mm		1.750		005 IFU P		F12/F14
			2.500		231 CR P		GOE12
Avenir 2.0, Avenir 2.0 4x4		09/01→	QR20DE		4cyl.		26
Primera 2.0, Primera Estate 2.0		03/02→			1998cc 103-110kW (140-150PS)		
Primera Hatchback 2.0		07/02→					
Teana I 2.0		10/03→06/08					
X-Trail 2.0, X-Trail 2.0 4x4		07/01→				TD16319	
08-435900-00	STD	89.00	1.200		001 CR		ST
08-435907-00	0.50mm		1.200		026 P		STD
			2.500		712 CR		ST
Altima 2.5		08/01→	QR25DE		4cyl.		27
Altima 2.5 Hybrid,		10/06→			2488cc 121kW (165PS)		
Altima Coupe 2.5 Hybrid							
Bassara 2.5		06/02→08/03					
Elgrand 2.5, Elgrand 2.5 AWD		11/10→					
Primera 2.5, Primera Hatchback 2.5		01/02→					
Sentra 2.5		06/02→08/06					
Serena 2.5, Serena 2.5 4x4		02/06→					
X-Trail 2.5		06/07→					
X-Trail 2.5 4x4		09/02→				TD17652	
08-436000-00	STD	89.00	1.200		001 IF CR		ST
08-436007-00	0.50mm		1.200		026 P		STD
			2.500		712 CR		ST
Cabstar 2.3		12/81→06/92	SD23		4cyl.		28
Cedric 2.3 D		05/84→08/87			2289cc 50-51kW (68-69PS)		
Pick Up 2.3 D		04/83→08/88					
Pick Up 2.3 D 4WD		09/85→08/87			Diesel		
Urvan Box 2.3 D		11/82→05/87					
Urvan Bus 2.3 D		04/85→11/88				TD2513	
Cabstar 2.5		02/83→12/90	SD25		4cyl.		TD2514
Pick Up 2.5 D 4WD		04/83→08/91			2488cc 53-55kW (72-75PS)		
					Diesel		
08-294500-00	STD	89.00	2.500		001 CR P		KV1
[R42730]			2.000		005 P		STD
			4.500		231 CR P		STD



Bassara 2.5 DCi	11/99→08/03	YD25DDTi	29
Cabstar 35.13	09/06→03/09	4cyl.	
Cabstar 45.13	10/06→	2488cc 98-110kW (133-150PS)	
Cabstar Platform/Chassis 2.5 dCi	10/06→09/11	Diesel Turbo Intercooled	
Navara 2.5 dCi, Navara 2.5 dCi 4WD	07/05→		
Navara Platform/Chassis 2.5 dCi 4WD	08/08→		
NP300 2.5 dCi, NP300 2.5 dCi 4x4	04/08→		
Pathfinder 2.5 dCi	01/05→		
Pathfinder 2.5 dCi 4WD	03/05→		
Pick Up 2.5 Di, Pick Up 2.5 Di 4WD	03/02→		
Serena 2.5 DCi SGX,	06/99→		
Serena 2.5 DCi SGX 4x4			

08-436100-00	STD	89.00	2.000		007 NT	ST
08-436107-00	0.50mm		2.000		026 IW P	STD
			3.000		231 NT	ST

Patrol 160, Patrol 260	01/80→12/87	4.165	30
		4cyl.	
		2710cc	
		Diesel	FM1358

08-399600-10	STD	92.00	2.000		001 IF CR P	KV1
			2.500		005 IF	STD
			4.000		231 CR P	STD

Atlas 2.5 D	10/93→10/97	TD25	31
Cabstar 2, 5	10/82→06/92	4cyl.	
Cabstar Platform/Chassis 2.5 D	01/89→12/00	2494cc 55-61kW (75-83PS)	
Homy Box 2.5 TD, Homy Platform/Chassis 2.5 TD	05/92→10/95	Diesel	
Pick Up 2.5 D	09/87→		
Pick Up 2.5 D 4WD	08/87→		
Urvan Box 2.5 D	12/88→05/97		
Urvan Bus 2.5 D	05/89→10/96		

08-521100-00	STD	92.90	2.500		001 CR	STD
<i>[R43820]</i>			2.000		005 IW CR	STD
			4.000		231 CR	STD

Patrol Hardtop 2.8 D	10/84→02/89	A428	32
Patrol Hardtop 2.8 D 4X4	12/83→02/89	4cyl.	
Patrol Station Wagon 2.8 D 4X4		2820cc 56kW (76PS)	
		Diesel	TD2392

08-295100-00	STD	94.00	2.500		001 IW CR P	IKA
			2.500		005 IF P	STD
			4.000		231 CR P	STD



Trade Platform/Chassis 2.8 D		12/86→06/94	A428II				33	
				4cyl.	2820cc	57kW (77PS)		
				Diesel			TD2393	
08-295200-00	STD	94.00	3.000		001 IF CR P		KV1	
			2.500		005 P		STD	
			3.000		231 CR P		STD	
Cabstar Flat Bed 3000 Long Wood Flat Bed, Cabstar Flat Bed 3000 Wood Flat Bed JYH40		01/92→	BD30				34	
				4cyl.	2953cc	63kW (86PS)		
				Diesel			FM9697	
Cabstar 2.7		02/83→12/90	TD27					
Navara 2.7 D 4x4		06/92→02/97		4cyl.	2663cc	58-73kW (79-99PS)		
Pick Up 2.7 D		02/98→						
Pick Up 2.7 D 4WD		08/87→02/98	Diesel					
Urvan Bus 2.7 D		03/87→09/93					TD2532	
Cabstar E 90.32		10/98→10/06	TD27T					
Patrol GR II Wagon 2.7 TD		05/98→06/01		4cyl.	2663cc	66-74kW (90-101PS)		
Pick Up 2.7 TD, Pick Up 2.7 TD 4WD		09/87→10/01						
Terrano I 2.7 TD 4WD		02/89→02/96	Diesel	Turbo				
Terrano II 2.7 TD 4WD		02/93→01/02						
Trade Platform/Chassis 2.7 TD		11/98→09/04					TD2533	
Patrol GR I 4.2 D			TD42					
				6cyl.	4169cc	92kW (125PS)		
				Diesel			TD2535	
08-111200-00	STD	96.00	2.500		001 CR P		KV1	
			[R43810]	2.000		005 IW CR P		IKA
			4.000		231 CR P		STD	
Cabstar 45.15		10/06→	ZD30				35	
Elgrand 3.0 D		04/03→12/10		4cyl.	2953cc	110kW (150PS)		
Interstar Box dCi 140, Interstar Bus dCi 140, Interstar Platform/Chassis dCi 140		11/03→						
Pick Up 3.0 TD, Pick Up 3.0 TD 4WD		11/01→	Diesel					
Terrano II 3.0 Di 4WD		05/02→						
Terrano Van 3.0 Di 4WD		04/03→					TD19371	
08-436200-00	STD	96.00	2.000		001 NT		ST	
				1.200		026 IF CR		STD
				2.000		231 NT		ST
Bus 10300		01/70→12/80	PD6				36	
Fire Engine 10300		01/73→12/78		6cyl.	10308cc			
Tractor 10300		01/69→12/73						
Truck 10300		01/69→12/88	Diesel				FM1278	
08-520700-00	STD	125.00	5.000		001 CR		KV1	
			[R32330/2K]	3.500		005 IW CR		STD
			5.000		231 CR		STD	



1

2.8T, 2.8TD		3cyl.	2827cc	Diesel		FM1294
38T, 38TA		4cyl.	3770cc	Diesel		FM1295
08-291900-10	STD	100.00	3.947		008 CR P	KV1
<i>[R18130K]</i>			2.385		001 IF P	STD
			2.385		023 P	STD
			6.335		231 CR P	STD
			6.335		031 P	STD

MODEL INDEX

Modelverzeichnis • Index de modele • Índice de Modelo
Indeks modelu • Модель автомобиля • دليل الموديل



CCM

x



9

08/03→12/07	Agila 1.0	Z 10 XEP	Petrol	998	3	10
09/00→12/07	Agila 1.0 12V	Z 10 XE	Petrol	973	3	9
09/00→12/07	Agila 1.2 16V	Z 12 XE	Petrol	1199	4	9
07/04→12/07	Agila 1.2 16V Twinport	Z 12 XEP	Petrol	1229	4	10
08/03→12/07	Agila 1.3 CDTI	Z 13 DT Euro 4	Diesel	1248	4	2
04/08→	Agila 1.3 CDTI	Z 13 DTJ	Diesel	1248	4	3
03/98→	Arena	F8Q-676, F8Q-714, F8Q-730, F8Q-732	Diesel	1870	4	27
03/98→08/01	Arena Box 1.9 D	F8Q 600	Diesel	1870	4	27
03/98→08/01	Arena Box 1.9 D	F8Q 606	Diesel	1870	4	27
03/98→08/01	Arena Box 2.5 D	S8U 758	Diesel	2499	4	58
03/98→08/01	Arena Box 2.5 D	S8U 780	Diesel	2499	4	58
03/98→08/01	Arena Combi 1.9 D	F8Q 600	Diesel	1870	4	27
03/98→08/01	Arena Combi 1.9 D	F8Q 606	Diesel	1870	4	27
03/98→08/01	Arena Combi 2.5 D	S8U 758	Diesel	2499	4	58
03/98→08/01	Arena Combi 2.5 D	S8U 780	Diesel	2499	4	58
04/72→08/75	Ascona A 1.2 S	12 S	Petrol	1196	4	17
10/70→08/75	Ascona A 1.6 S	16 S	Petrol	1584	4	43
03/71→08/75	Ascona A 1.9 SR	19 S	Petrol	1897	4	57
10/70→08/75	Ascona A Voyage 1.6 S	16 S	Petrol	1584	4	43
10/70→08/75	Ascona A Voyage 1.9 SR	19 S	Petrol	1897	4	57
08/76→02/79	Ascona B 1.2	12 N	Petrol	1196	4	17
09/75→02/79	Ascona B 1.2 S	12 S	Petrol	1196	4	17
03/79→08/81	Ascona B 1.3 N	13 N	Petrol	1297	4	11
08/79→08/81	Ascona B 1.3 S	13 S	Petrol	1297	4	11
09/75→08/81	Ascona B 1.6 S	16 S	Petrol	1584	4	43
09/75→08/81	Ascona B 1.9 S	19 S	Petrol	1897	4	57
08/79→08/81	Ascona B 2.0 E	20 E	Petrol	1979	4	60
08/77→08/81	Ascona B 2.0 N	20 N	Petrol	1979	4	60
08/77→08/81	Ascona B 2.0 S	20 S	Petrol	1979	4	60
09/81→08/86	Ascona C 1.3 N	13 N	Petrol	1297	4	11
09/81→08/88	Ascona C 1.3 S	13 S	Petrol	1297	4	11
09/81→09/87	Ascona C 1.6	16 N	Petrol	1598	4	26
09/86→08/88	Ascona C 1.6	16 SV	Petrol	1598	4	18
03/82→08/88	Ascona C 1.6 D	16 D	Diesel	1598	4	25
03/82→08/88	Ascona C 1.6 D	16 DA	Diesel	1598	4	25
09/87→08/88	Ascona C 1.6 i	E 16 LZ	Petrol	1598	4	18
09/87→08/88	Ascona C 1.6 i	E 16 NZ	Petrol	1598	4	18
09/86→08/88	Ascona C 1.6 i CAT	C 16 LZ	Petrol	1598	4	18
09/86→08/88	Ascona C 1.6 i CAT	C 16 NZ	Petrol	1598	4	18
09/81→08/86	Ascona C 1.6 S	16 SH	Petrol	1598	4	26
09/87→08/88	Ascona C 1.8	E 18 NV	Petrol	1796	4	42
01/85→08/86	Ascona C 1.8 E	C 18 NE	Petrol	1796	4	41
01/85→08/86	Ascona C 1.8 E	S 18 NV	Petrol	1796	4	42
09/82→08/86	Ascona C 1.8 i	18 E	Petrol	1796	4	41
09/81→08/83	Ascona C 2.0	20 E	Petrol	1979	4	60
09/86→08/88	Ascona C 2.0 i	20 NE	Petrol	1998	4	45
09/86→08/88	Ascona C 2.0 i CAT	C 20 NE	Petrol	1998	4	45
03/87→08/88	Ascona C 2.0 i GT	20 SEH	Petrol	1998	4	45
09/81→08/86	Ascona C Hatchback 1.3 N	13 N	Petrol	1297	4	11
09/81→08/88	Ascona C Hatchback 1.3 S	13 S	Petrol	1297	4	11
09/81→08/88	Ascona C Hatchback 1.6	16 N	Petrol	1598	4	26
09/86→08/88	Ascona C Hatchback 1.6	16 SV	Petrol	1598	4	18
03/82→08/88	Ascona C Hatchback 1.6 D	16 D	Diesel	1598	4	25
03/82→08/88	Ascona C Hatchback 1.6 D	16 DA	Diesel	1598	4	25
09/87→08/88	Ascona C Hatchback 1.6 i	E 16 NZ	Petrol	1598	4	18
09/86→08/88	Ascona C Hatchback 1.6 i CAT	C 16 LZ	Petrol	1598	4	18
09/86→08/88	Ascona C Hatchback 1.6 i CAT	C 16 NZ	Petrol	1598	4	18
09/81→08/86	Ascona C Hatchback 1.6 S	16 SH	Petrol	1598	4	26
09/87→08/88	Ascona C Hatchback 1.8	E 18 NV	Petrol	1796	4	42
01/85→08/86	Ascona C Hatchback 1.8 E	C 18 NE	Petrol	1796	4	41

CCM
x

9

01/85→08/86	Ascona C Hatchback 1.8 E	S 18 NV	Petrol	1796	4	42
09/82→08/86	Ascona C Hatchback 1.8 i	18 E	Petrol	1796	4	41
09/86→08/88	Ascona C Hatchback 2.0 i	20 NE	Petrol	1998	4	45
09/86→08/88	Ascona C Hatchback 2.0 i CAT	C 20 NE	Petrol	1998	4	45
03/87→08/88	Ascona C Hatchback 2.0 i GT	20 SEH	Petrol	1998	4	45
09/91→09/93	Astra F 1.4	14 NV	Petrol	1389	4	13
09/91→09/98	Astra F 1.4 i	C 14 NZ	Petrol	1389	4	13
09/91→09/98	Astra F 1.4 i	X 14 NZ	Petrol	1389	4	13
02/96→09/98	Astra F 1.4 i 16V	X 14 XE	Petrol	1389	4	13
03/92→09/98	Astra F 1.4 Si	C 14 SE	Petrol	1389	4	13
09/95→09/98	Astra F 1.6	16 LZ2	Petrol	1598	4	18
09/95→09/98	Astra F 1.6	16 NZR	Petrol	1598	4	18
03/92→09/98	Astra F 1.6 i	C 16 NZ	Petrol	1598	4	18
05/93→07/96	Astra F 1.6 i	X 16 SZ	Petrol	1598	4	18
03/92→09/98	Astra F 1.6 i	X 16 SZR	Petrol	1598	4	18
08/94→09/98	Astra F 1.6 i 16V	X 16 XEL	Petrol	1598	4	21
05/92→12/94	Astra F 1.6 Si	C 16 SE	Petrol	1598	4	18
03/92→09/92	Astra F 1.7 D	17 D	Diesel	1699	4	34
07/92→09/98	Astra F 1.7 D	17 DR	Diesel	1699	4	34
11/94→09/98	Astra F 1.7 TD	X 17 DTL	Diesel	1699	4	34
03/92→09/98	Astra F 1.7 TDS	17 DT (TC4EE1)	Diesel	1686	4	19
03/92→09/98	Astra F 1.7 TDS	X 17 DT (TC4EE1)	Diesel	1686	4	19
03/92→09/98	Astra F 1.8 i	C 18 NZ	Petrol	1796	4	41
09/95→09/96	Astra F 1.8 i 16V	18 SE	Petrol	1796	4	41
06/93→10/94	Astra F 1.8 i 16V	C 18 XE	Petrol	1796	4	31
11/94→09/98	Astra F 1.8 i 16V	C 18 XEL	Petrol	1796	4	31
11/94→09/98	Astra F 1.8 i 16V	X 18 XE	Petrol	1796	4	31
03/92→09/98	Astra F 2.0 i	C 20 NE	Petrol	1998	4	45
02/95→09/98	Astra F 2.0 i 16V	X 20 XEV	Petrol	1998	4	45
01/98→01/05	Astra F Classic Estate 1.4 i	X 14 NZ	Petrol	1389	4	13
01/98→01/05	Astra F Classic Estate 1.6 i	X 16 SZR	Petrol	1598	4	18
01/98→01/05	Astra F Classic Estate 1.6 i 16V	X 16 XEL	Petrol	1598	4	21
02/03→07/04	Astra F Classic Estate 1.8	Z 18 XEL	Petrol	1796	4	30
03/98→08/00	Astra F Classic Hatchback 1.2 i	X 12 XE	Petrol	1199	4	9
01/98→08/02	Astra F Classic Hatchback 1.4 i	X 14 NZ	Petrol	1389	4	13
03/98→08/00	Astra F Classic Hatchback 1.4 i	X 14 XE	Petrol	1389	4	13
01/98→08/02	Astra F Classic Hatchback 1.6 i	X 16 SZR	Petrol	1598	4	18
01/98→08/02	Astra F Classic Hatchback 1.6 i 16V	X 16 XEL	Petrol	1598	4	21
03/98→08/00	Astra F Classic Hatchback 1.7 TD	X 17 DTL	Diesel	1699	4	34
03/98→08/00	Astra F Classic Hatchback 1.8 i	X 18 XE1	Petrol	1796	4	30
03/98→08/00	Astra F Classic Hatchback 2.0 Di	X 20 DTL	Diesel	1896	4	39
08/99→08/00	Astra F Classic Hatchback 2.0 DTi	X 20 DTH	Diesel	1995	4	38
03/98→08/00	Astra F Classic Hatchback 2.0 i	X 20 XEV	Petrol	1998	4	45
01/98→08/02	Astra F Classic Saloon 1.4 i	X 14 NZ	Petrol	1389	4	13
01/98→08/02	Astra F Classic Saloon 1.6 i	X 16 SZR	Petrol	1598	4	18
01/98→08/02	Astra F Classic Saloon 1.6 i 16V	X 16 XEL	Petrol	1598	4	21
01/96→03/01	Astra F Convertible 1.4 i 16V	X 14 XE	Petrol	1389	4	13
05/93→03/01	Astra F Convertible 1.4 Si	C 14 SE	Petrol	1389	4	13
03/93→08/96	Astra F Convertible 1.6 i	X 16 SZ	Petrol	1598	4	18
01/96→03/01	Astra F Convertible 1.6 i	X 16 SZR	Petrol	1598	4	18
11/94→03/01	Astra F Convertible 1.8 i 16V	C 18 XEL	Petrol	1796	4	31
11/94→03/01	Astra F Convertible 1.8 i 16V	X 18 XE	Petrol	1796	4	31
03/93→10/94	Astra F Convertible 2.0 i	C 20 NE	Petrol	1998	4	45
09/91→09/93	Astra F Estate 1.4	14 NV	Petrol	1389	4	13
09/91→01/98	Astra F Estate 1.4 i	C 14 NZ	Petrol	1389	4	13
02/96→01/98	Astra F Estate 1.4 i 16V	X 14 XE	Petrol	1389	4	13
03/92→01/98	Astra F Estate 1.4 Si	C 14 SE	Petrol	1389	4	13
09/95→01/98	Astra F Estate 1.6	16 LZ2	Petrol	1598	4	18
09/95→01/98	Astra F Estate 1.6	16 NZR	Petrol	1598	4	18
09/91→01/98	Astra F Estate 1.6 i	C 16 NZ	Petrol	1598	4	18

MODEL INDEX

Modelverzeichnis • Index de modele • Índice de Modelo
 Indeks modelu • Модель автомобиля • دليل الموديل

CCM
x

9

05/93→07/96	Astra F Estate 1.6 i	X 16 SZ	Petrol	1598	4	18
09/91→01/98	Astra F Estate 1.6 i	X 16 SZR	Petrol	1598	4	18
08/94→01/98	Astra F Estate 1.6 i 16V	X 16 XEL	Petrol	1598	4	21
03/92→12/94	Astra F Estate 1.6 Si	C 16 SE	Petrol	1598	4	18
12/91→09/92	Astra F Estate 1.7 D	17 D	Diesel	1699	4	34
07/92→01/98	Astra F Estate 1.7 D	17 DR	Diesel	1699	4	34
11/94→01/98	Astra F Estate 1.7 TD	X 17 DTL	Diesel	1699	4	34
12/91→01/98	Astra F Estate 1.7 TDS	17 DT (TC4EE1)	Diesel	1686	4	19
12/91→01/98	Astra F Estate 1.7 TDS	X 17 DT (TC4EE1)	Diesel	1686	4	19
09/91→01/98	Astra F Estate 1.8 i	C 18 NZ	Petrol	1796	4	41
06/93→01/98	Astra F Estate 1.8 i 16V	C 18 XE	Petrol	1796	4	31
07/94→01/98	Astra F Estate 1.8 i 16V	C 18 XEL	Petrol	1796	4	31
07/94→01/98	Astra F Estate 1.8 i 16V	X 18 XE	Petrol	1796	4	31
09/91→07/94	Astra F Estate 2.0 i	C 20 NE	Petrol	1998	4	45
03/93→01/98	Astra F Estate 2.0 i 16V	C 20 XE	Petrol	1998	4	45
02/95→01/98	Astra F Estate 2.0 i 16V	X 20 XEV	Petrol	1998	4	45
09/91→09/93	Astra F Hatchback 1.4	14 NV	Petrol	1389	4	13
03/92→01/98	Astra F Hatchback 1.4 i	C 14 NZ	Petrol	1389	4	13
01/96→01/98	Astra F Hatchback 1.4 i 16V	X 14 XE	Petrol	1389	4	13
03/92→01/98	Astra F Hatchback 1.4 Si	C 14 SE	Petrol	1389	4	13
09/95→01/98	Astra F Hatchback 1.6	16 LZ2	Petrol	1598	4	18
09/95→01/98	Astra F Hatchback 1.6	16 NZR	Petrol	1598	4	18
09/91→01/98	Astra F Hatchback 1.6 i	C 16 NZ	Petrol	1598	4	18
05/93→07/96	Astra F Hatchback 1.6 i	X 16 SZ	Petrol	1598	4	18
09/91→01/98	Astra F Hatchback 1.6 i	X 16 SZR	Petrol	1598	4	18
08/94→01/98	Astra F Hatchback 1.6 i 16V	X 16 XEL	Petrol	1598	4	21
03/92→12/94	Astra F Hatchback 1.6 Si	C 16 SE	Petrol	1598	4	18
12/91→09/92	Astra F Hatchback 1.7 D	17 D	Diesel	1699	4	34
07/92→01/98	Astra F Hatchback 1.7 D	17 DR	Diesel	1699	4	34
11/94→01/98	Astra F Hatchback 1.7 TD	X 17 DTL	Diesel	1699	4	34
12/91→01/98	Astra F Hatchback 1.7 TDS	17 DT (TC4EE1)	Diesel	1686	4	19
12/91→01/98	Astra F Hatchback 1.7 TDS	X 17 DT (TC4EE1)	Diesel	1686	4	19
09/91→01/98	Astra F Hatchback 1.8 i	C 18 NZ	Petrol	1796	4	41
06/93→08/94	Astra F Hatchback 1.8 i 16V	C 18 XE	Petrol	1796	4	31
09/94→01/98	Astra F Hatchback 1.8 i 16V	C 18 XEL	Petrol	1796	4	31
09/94→01/98	Astra F Hatchback 1.8 i 16V	X 18 XE	Petrol	1796	4	31
09/91→01/98	Astra F Hatchback 2.0 GSI 16V	C 20 XE	Petrol	1998	4	45
09/91→01/98	Astra F Hatchback 2.0 i	C 20 NE	Petrol	1998	4	45
02/95→01/98	Astra F Hatchback 2.0 i 16V	X 20 XEV	Petrol	1998	4	45
10/91→01/99	Astra F Van 1.4 i	C 14 NZ	Petrol	1389	4	13
10/91→04/93	Astra F Van 1.6 i	C 16 NZ	Petrol	1598	4	18
02/93→07/96	Astra F Van 1.6 i	X 16 SZ	Petrol	1598	4	18
08/94→03/98	Astra F Van 1.6 i 16V	X 16 XEL	Petrol	1598	4	21
12/91→09/92	Astra F Van 1.7 D	17 D	Diesel	1699	4	34
07/92→01/99	Astra F Van 1.7 D	17 DR	Diesel	1699	4	34
03/95→02/98	Astra F Van 1.7 TD	X 17 DT (TC4EE1)	Diesel	1686	4	19
08/94→01/99	Astra F Van 1.7 TD	X 17 DTL	Diesel	1699	4	34
01/99→09/00	Astra G Box 1.6	X 16 SZR	Petrol	1598	4	18
09/00→04/05	Astra G Box 1.6	Z 16 SE	Petrol	1598	4	22
01/99→04/05	Astra G Box 1.7 TD	X 17 DTL	Diesel	1699	4	34
01/99→04/05	Astra G Box 2.0 DI	X 20 DTL	Diesel	1896	4	39
01/03→10/05	Astra G Convertible 1.6	Z 16 XEP	Petrol	1598	4	23
03/01→10/05	Astra G Convertible 1.6 16V	Z 16 XE	Petrol	1598	4	22
03/01→10/05	Astra G Convertible 1.8 16V	Z 18 XE	Petrol	1799	4	30
09/02→10/05	Astra G Convertible 2.2 DTI	Y 22 DTR	Diesel	2172	4	40
03/00→05/05	Astra G Coupe 1.6 16V	Z 16 XE	Petrol	1598	4	22
03/00→05/05	Astra G Coupe 1.6 16V	Z 16 XEP	Petrol	1598	4	23
03/00→10/00	Astra G Coupe 1.8 16V	X 18 XE1	Petrol	1796	4	30
09/00→05/05	Astra G Coupe 1.8 16V	Z 18 XE	Petrol	1799	4	30
09/02→05/05	Astra G Coupe 2.2 DTI	Y 22 DTR	Diesel	2172	4	40



CCM

x



9

02/98→09/00	Astra G Estate 1.2 16V	X 12 XE	Petrol	1199	4	9
09/00→07/04	Astra G Estate 1.2 16V	Z 12 XE	Petrol	1199	4	9
09/07→12/09	Astra G Estate 1.4	Z 14 XEP	Petrol	1364	4	10
06/98→07/04	Astra G Estate 1.4 16V	X 14 XE	Petrol	1389	4	13
06/98→07/04	Astra G Estate 1.4 16V	Z 14 XE	Petrol	1389	4	14
02/98→09/00	Astra G Estate 1.6	X 16 SZR	Petrol	1598	4	18
09/00→07/04	Astra G Estate 1.6	Z 16 SE	Petrol	1598	4	22
12/02→07/09	Astra G Estate 1.6	Z 16 XEP	Petrol	1598	4	23
02/98→07/04	Astra G Estate 1.6 16V	X 16 XEL	Petrol	1598	4	21
02/98→07/04	Astra G Estate 1.6 16V	Z 16 XE	Petrol	1598	4	22
04/03→07/09	Astra G Estate 1.7 CDTI	Z 17 DTL	Diesel	1686	4	19
02/00→07/04	Astra G Estate 1.7 DTI 16V	Y 17 DT	Diesel	1686	4	19
02/98→08/00	Astra G Estate 1.7 TD	X 17 DTL	Diesel	1699	4	34
02/98→09/00	Astra G Estate 1.8 16V	X 18 XE1	Petrol	1796	4	30
09/00→07/04	Astra G Estate 1.8 16V	Z 18 XE	Petrol	1799	4	30
02/98→07/04	Astra G Estate 2.0 16V	X 20 XEV	Petrol	1998	4	45
02/98→07/04	Astra G Estate 2.0 DI	X 20 DTL	Diesel	1896	4	39
02/98→07/04	Astra G Estate 2.0 DI	Y 20 DTL	Diesel	1995	4	39
08/99→07/04	Astra G Estate 2.0 DTI 16V	X 20 DTH	Diesel	1995	4	38
08/99→07/04	Astra G Estate 2.0 DTI 16V	Y 20 DTH	Diesel	1995	4	40
09/02→07/04	Astra G Estate 2.2 DTI	Y 22 DTR	Diesel	2172	4	40
08/03→05/04	Astra G Hatchback 1.0	Z 10 XEP	Petrol	998	3	10
02/98→09/00	Astra G Hatchback 1.2 16V	X 12 XE	Petrol	1199	4	9
09/00→01/05	Astra G Hatchback 1.2 16V	Z 12 XE	Petrol	1199	4	9
09/07→12/09	Astra G Hatchback 1.4	Z 14 XEP	Petrol	1364	4	10
02/98→01/05	Astra G Hatchback 1.4 16V	X 14 XE	Petrol	1389	4	13
02/98→01/05	Astra G Hatchback 1.4 16V	Z 14 XE	Petrol	1389	4	14
02/98→09/00	Astra G Hatchback 1.6	X 16 SZR	Petrol	1598	4	18
09/00→01/05	Astra G Hatchback 1.6	Z 16 SE	Petrol	1598	4	22
12/02→12/09	Astra G Hatchback 1.6	Z 16 XEP	Petrol	1598	4	23
02/98→01/05	Astra G Hatchback 1.6 16V	X 16 XEL	Petrol	1598	4	21
02/98→01/05	Astra G Hatchback 1.6 16V	Z 16 XE	Petrol	1598	4	22
06/02→01/05	Astra G Hatchback 1.6 LPG	Z 16 XE	Petrol	1598	4	22
04/03→01/05	Astra G Hatchback 1.7 CDTI	Z 17 DTL	Diesel	1686	4	19
02/00→01/05	Astra G Hatchback 1.7 DTI 16V	Y 17 DT	Diesel	1686	4	19
02/98→08/00	Astra G Hatchback 1.7 TD	X 17 DTL	Diesel	1699	4	34
02/98→09/00	Astra G Hatchback 1.8 16V	X 18 XE1	Petrol	1796	4	30
09/00→01/05	Astra G Hatchback 1.8 16V	Z 18 XE	Petrol	1799	4	30
02/98→01/05	Astra G Hatchback 2.0 16V	C 20 SEL	Petrol	1998	4	45
02/98→01/05	Astra G Hatchback 2.0 16V	X 20 XEV	Petrol	1998	4	45
02/98→01/05	Astra G Hatchback 2.0 DI	X 20 DTL	Diesel	1896	4	39
02/98→01/05	Astra G Hatchback 2.0 DI	Y 20 DTL	Diesel	1995	4	39
08/99→01/05	Astra G Hatchback 2.0 DTI 16V	X 20 DTH	Diesel	1995	4	38
08/99→01/05	Astra G Hatchback 2.0 DTI 16V	Y 20 DTH	Diesel	1995	4	40
09/02→01/05	Astra G Hatchback 2.2 DTI	Y 22 DTR	Diesel	2172	4	40
09/98→09/00	Astra G Saloon 1.2 16V	X 12 XE	Petrol	1199	4	9
09/00→01/05	Astra G Saloon 1.2 16V	Z 12 XE	Petrol	1199	4	9
09/07→12/09	Astra G Saloon 1.4	Z 14 XEP	Petrol	1364	4	10
09/98→01/05	Astra G Saloon 1.4 16V	X 14 XE	Petrol	1389	4	13
09/98→01/05	Astra G Saloon 1.4 16V	Z 14 XE	Petrol	1389	4	14
09/98→09/00	Astra G Saloon 1.6	X 16 SZR	Petrol	1598	4	18
09/00→01/05	Astra G Saloon 1.6	Z 16 SE	Petrol	1598	4	22
12/02→01/05	Astra G Saloon 1.6	Z 16 XEP	Petrol	1598	4	23
09/98→01/05	Astra G Saloon 1.6 16V	X 16 XEL	Petrol	1598	4	21
09/98→01/05	Astra G Saloon 1.6 16V	Z 16 XE	Petrol	1598	4	22
06/02→01/05	Astra G Saloon 1.6 LPG	Z 16 XE	Petrol	1598	4	22
04/03→01/05	Astra G Saloon 1.7 CDTI	Z 17 DTL	Diesel	1686	4	19
02/00→01/05	Astra G Saloon 1.7 DTI 16V	Y 17 DT	Diesel	1686	4	19
09/98→08/00	Astra G Saloon 1.7 TD	X 17 DTL	Diesel	1699	4	34
09/98→09/00	Astra G Saloon 1.8 16V	X 18 XE1	Petrol	1796	4	30

MODEL INDEX

 Modelverzeichnis • Index de modele • Índice de Modelo
 Indeks modelu • Модель автомобиля • دليل الموديل

CCM
x

9

09/00→01/05	Astra G Saloon 1.8 16V	Z 18 XE	Petrol	1799	4	30
09/98→01/05	Astra G Saloon 2.0 16V	X 20 XEV	Petrol	1998	4	45
09/98→01/05	Astra G Saloon 2.0 DI	X 20 DTL	Diesel	1896	4	39
09/98→01/05	Astra G Saloon 2.0 DI	Y 20 DTL	Diesel	1995	4	39
08/99→01/05	Astra G Saloon 2.0 DTI 16V	X 20 DTH	Diesel	1995	4	38
08/99→01/05	Astra G Saloon 2.0 DTI 16V	Y 20 DTH	Diesel	1995	4	40
09/02→01/05	Astra G Saloon 2.2 DTI	Y 22 DTR	Diesel	2172	4	40
10/11→	Astra GTC J 1.4	A 14 NET Euro 5	Petrol	1364	4	8
10/11→	Astra GTC J 1.6	A 16 LET Euro 5	Petrol	1598	4	20
10/12→	Astra GTC J 2.0 BiTurbo CDTI	A 20 DTR Euro 5	Diesel	1956	4	35
10/11→	Astra GTC J 2.0 CDTI	A 20 DTH Euro 5	Diesel	1956	4	35
10/06→	Astra H 1.2	X 12 XE	Petrol	1199	4	9
08/05→	Astra H 1.2	Z 12 XEP	Petrol	1229	4	10
08/05→	Astra H 1.3 CDTI	Z 13 DTH	Diesel	1248	4	3
03/04→	Astra H 1.4	Z 14 XEP	Petrol	1364	4	10
08/09→	Astra H 1.4 LPG	Z 14 XEP	Petrol	1364	4	10
03/04→	Astra H 1.6	Z 16 XEP	Petrol	1598	4	23
12/06→	Astra H 1.6	Z 16 XER	Petrol	1598	4	24
03/04→	Astra H 1.7 CDTI	Z 17 DTH	Diesel	1686	4	19
03/04→	Astra H 1.7 CDTI	Z 17 DTL	Diesel	1686	4	19
03/04→	Astra H 1.8	Z 18 XE	Petrol	1799	4	30
01/06→	Astra H 1.8	Z 18 XER	Petrol	1796	4	30
06/04→	Astra H 1.9 CDTI	Z 19 DT	Diesel	1910	4	32
09/04→	Astra H 1.9 CDTI	Z 19 DTH	Diesel	1910	4	33
09/05→	Astra H 1.9 CDTI	Z 19 DTL Euro 4	Diesel	1910	4	32
04/04→	Astra H 1.9 CDTI 16V	Z 19 DTJ	Diesel	1910	4	33
08/05→	Astra H Estate 1.3 CDTI	Z 13 DTH	Diesel	1248	4	3
08/04→	Astra H Estate 1.4	Z 14 XEP	Petrol	1364	4	10
08/09→	Astra H Estate 1.4 LPG	Z 14 XEP	Petrol	1364	4	10
08/04→	Astra H Estate 1.6	Z 16 XEP	Petrol	1598	4	23
12/06→	Astra H Estate 1.6	Z 16 XER	Petrol	1598	4	24
08/09→	Astra H Estate 1.6 LPG	Z 16 XER	Petrol	1598	4	24
08/04→	Astra H Estate 1.7 CDTI	Z 17 DTH	Diesel	1686	4	19
08/04→	Astra H Estate 1.7 CDTI	Z 17 DTL	Diesel	1686	4	19
08/04→	Astra H Estate 1.8	Z 18 XE	Petrol	1799	4	30
08/05→	Astra H Estate 1.8	Z 18 XER	Petrol	1796	4	30
09/05→	Astra H Estate 1.9 CDTI	Z 19 DT	Diesel	1910	4	32
09/04→	Astra H Estate 1.9 CDTI	Z 19 DTH	Diesel	1910	4	33
09/05→	Astra H Estate 1.9 CDTI	Z 19 DTL Euro 4	Diesel	1910	4	32
08/04→	Astra H Estate 1.9 CDTI 16V	Z 19 DTJ	Diesel	1910	4	33
10/06→	Astra H GTC 1.2	X 12 XE	Petrol	1199	4	9
08/05→	Astra H GTC 1.2	Z 12 XEP	Petrol	1229	4	10
04/05→	Astra H GTC 1.3 CDTI	Z 13 DTH	Diesel	1248	4	3
03/05→	Astra H GTC 1.4	Z 14 XEP	Petrol	1364	4	10
03/05→	Astra H GTC 1.6	Z 16 XEP	Petrol	1598	4	23
12/06→	Astra H GTC 1.6	Z 16 XER	Petrol	1598	4	24
03/05→	Astra H GTC 1.7 CDTi	Z 17 DTH	Diesel	1686	4	19
03/05→	Astra H GTC 1.7 CDTI	Z 17 DTL	Diesel	1686	4	19
03/05→	Astra H GTC 1.8	Z 18 XE	Petrol	1799	4	30
01/06→	Astra H GTC 1.8	Z 18 XER	Petrol	1796	4	30
09/05→	Astra H GTC 1.9 CDTI	Z 19 DT	Diesel	1910	4	32
03/05→	Astra H GTC 1.9 CDTi	Z 19 DTH	Diesel	1910	4	33
01/06→	Astra H GTC 1.9 CDTI	Z 19 DTL Euro 4	Diesel	1910	4	32
03/05→	Astra H GTC 1.9 CDTi 16V	Z 19 DTJ	Diesel	1910	4	33
02/07→	Astra H Saloon 1.3 CDTi	Z 13 DTH	Diesel	1248	4	3
02/07→	Astra H Saloon 1.6	Z 16 XER	Petrol	1598	4	24
02/07→	Astra H Saloon 1.7 CDTi	Z 17 DTH	Diesel	1686	4	19
02/07→	Astra H Saloon 1.8	Z 18 XER	Petrol	1796	4	30
09/05→	Astra H TwinTop 1.6	Z 16 XEP	Petrol	1598	4	23
12/06→	Astra H TwinTop 1.6	Z 16 XER	Petrol	1598	4	24

CCM

x



9

09/05→	Astra H TwinTop 1.8	Z 18 XE	Petrol	1799	4	30
09/05→	Astra H TwinTop 1.8	Z 18 XER	Petrol	1796	4	30
09/05→	Astra H TwinTop 1.9 CDTi	Z 19 DTH	Diesel	1910	4	33
08/05→	Astra H Van 1.3 CDTi	Z 13 DTH	Diesel	1248	4	3
02/04→11/04	Astra H Van 1.6	Z 16 XEP	Petrol	1598	4	23
03/04→	Astra H Van 1.7 CDTi	Z 17 DTH	Diesel	1686	4	19
09/05→	Astra H Van 1.9 CDTi	Z 19 DT	Diesel	1910	4	32
09/04→	Astra H Van 1.9 CDTi	Z 19 DTH	Diesel	1910	4	33
08/04→	Astra H Van 1.9 CDTi 16V	Z 19 DTJ	Diesel	1910	4	33
01/12→	Astra J 1.4 LPG	A 14 NET Euro 5	Petrol	1364	4	8
12/09→	Astra J 1.4 Turbo	A 14 NET Euro 5	Petrol	1364	4	8
12/09→	Astra J 1.6 Turbo	A 16 LET Euro 5	Petrol	1598	4	20
12/12→	Astra J 2.0 BiTurbo CDTi	A 20 DTR Euro 5	Diesel	1956	4	35
12/09→	Astra J 2.0 CDTi	A 20 DTH Euro 5	Diesel	1956	4	35
06/12→	Astra J Saloon 1.4 Turbo	A 14 NET Euro 5	Petrol	1364	4	8
06/12→	Astra J Saloon 1.6 Turbo	A 16 LET Euro 5	Petrol	1598	4	20
01/12→	Astra Sports Tourer 1.4 LPG	A 14 NET Euro 5	Petrol	1364	4	8
10/10→	Astra Sports Tourer 1.4 Turbo	A 14 NET Euro 5	Petrol	1364	4	8
10/10→	Astra Sports Tourer 1.6 Turbo	A 16 LET Euro 5	Petrol	1598	4	20
12/12→	Astra Sports Tourer 2.0 BiTurbo CDTi	A 20 DTR Euro 5	Diesel	1956	4	35
10/10→	Astra Sports Tourer 2.0 CDTi	A 20 DTH Euro 5	Diesel	1956	4	35
01/67→12/87	Blitz	25 CIH	Petrol	2490	6	46
01/68→12/70	Blitz 2.1	XDP 90	Diesel	2112	4	53
06/90→07/97	Calibra A 2.0 i	C 20 NE	Petrol	1998	4	45
06/90→02/94	Calibra A 2.0 i 16V	C 20 XE	Petrol	1998	4	45
02/94→07/97	Calibra A 2.0 i 16V	X 20 XEV	Petrol	1998	4	45
06/90→02/94	Calibra A 2.0 i 16V 4x4	C 20 XE	Petrol	1998	4	45
02/94→07/97	Calibra A 2.0 i 16V 4x4	X 20 XEV	Petrol	1998	4	45
06/90→07/97	Calibra A 2.0 i 4x4	C 20 NE	Petrol	1998	4	45
03/92→07/97	Calibra A 2.0 i Turbo 4x4	C 20 LET	Petrol	1998	4	45
04/93→07/97	Calibra A 2.5 i V6	C 25 XE	Petrol	2498	V6	31
04/93→07/97	Calibra A 2.5 i V6	X 25 XE	Petrol	2498	V6	31
08/87→09/96	Campo 2.2 D	C 223	Diesel	2238	4	49
08/87→09/96	Campo 2.2 D 4x4	C 223	Diesel	2238	4	49
03/13→	Cascada 1.4 Turbo	A 14 NET Euro 5	Petrol	1364	4	8
03/13→	Cascada 2.0 CDTi	A 20 DTH Euro 5	Diesel	1956	4	35
03/13→	Cascada 2.0 CDTi	A 20 DTR Euro 5	Diesel	1956	4	35
07/94→10/01	Combo 1.2	C 12 NZ	Petrol	1187	4	5
07/94→10/01	Combo 1.2	X 12 SZ	Petrol	1195	4	5
07/94→10/01	Combo 1.4	C 14 NZ	Petrol	1389	4	13
07/94→10/01	Combo 1.4	C 14 SE	Petrol	1389	4	13
07/94→10/01	Combo 1.4	X 14 SZ	Petrol	1389	4	13
08/99→10/01	Combo 1.4 16V	X 14 XE	Petrol	1389	4	13
07/94→10/01	Combo 1.7 D	17 D (4EE1)	Diesel	1686	4	19
07/94→10/01	Combo 1.7 D	X 17 D (4EE1)	Diesel	1686	4	19
02/12→	Combo Box Body / Estate 1.3 CDTi	A 13 FD Euro 5 (CDTi)	Diesel	1248	4	1
08/05→	Combo Box Body / Estate 1.3 CDTi 16V	Z 13 DT Euro 4	Diesel	1248	4	2
10/05→	Combo Box Body / Estate 1.3 CDTi 16V	Z 13 DTJ	Diesel	1248	4	3
02/12→	Combo Box Body / Estate 1.4	A 14 FP Euro 5	Petrol	1368	4	7
02/12→	Combo Box Body / Estate 1.4	A 14 FC Euro 5	Bi-fuel (Petrol/ Gas)	1368	4	6
08/05→	Combo Box Body / Estate 1.4 16V	Z 14 XEP	Petrol	1364	4	10
02/12→	Combo Box Body / Estate 1.4 CNG	A 14 FC Euro 5	Bi-fuel (Petrol/ Gas)	1368	4	6
10/01→	Combo Box Body / Estate 1.6	Z 16 SE	Petrol	1598	4	22
12/04→	Combo Box Body / Estate 1.7 CDTi 16V	Z 17 DTH	Diesel	1686	4	19
10/01→	Combo Box Body / Estate 1.7 DI 16V	Y 17 DTL	Diesel	1686	4	19
10/01→	Combo Box Body / Estate 1.7 DTi 16V	Y 17 DT	Diesel	1686	4	19

MODEL INDEX

Modelverzeichnis • Index de modele • Índice de Modelo
Indeks modelu • Модель автомобиля • دليل الموديل



CCM

x



9

02/12→	Combo Box Body / Estate 2.0 CDTI	A 20 FD Euro 5	Diesel	1956	4	35
02/12→	Combo Tour 1.3 CDTI	A 13 FD Euro 5 (CDTI)	Diesel	1248	4	1
10/04→	Combo Tour 1.3 CDTI 16V	Y 13 DT Euro 3/4	Diesel	1248	4	2
10/04→	Combo Tour 1.3 CDTI 16V	Z 13 DT Euro 4	Diesel	1248	4	2
10/05→	Combo Tour 1.3 CDTI 16V	Z 13 DTJ	Diesel	1248	4	3
02/12→	Combo Tour 1.4	A 14 FP Euro 5	Petrol	1368	4	7
10/04→	Combo Tour 1.4	Z 14 XEP	Petrol	1364	4	10
02/12→	Combo Tour 1.4	A 14 FC Euro 5	Bi-fuel (Petrol/ Gas)	1368	4	6
02/12→	Combo Tour 1.4 CNG	A 14 FC Euro 5	Bi-fuel (Petrol/ Gas)	1368	4	6
10/01→	Combo Tour 1.6	Z 16 SE	Petrol	1598	4	22
12/04→	Combo Tour 1.7 CDTI 16V	Z 17 DTH	Diesel	1686	4	19
10/01→	Combo Tour 1.7 DI 16V	Y 17 DTL	Diesel	1686	4	19
10/01→	Combo Tour 1.7 DTI 16V	Y 17 DT	Diesel	1686	4	19
02/12→	Combo Tour 2.0 CDTI	A 20 FD Euro 5	Diesel	1956	4	35
01/67→12/87	Commodore	25 CIH	Petrol	2490	6	46
08/67→08/69	Commodore A 2.5	25 S	Petrol	2490	6	46
08/67→01/72	Commodore A 2.5 GS	25 H	Petrol	2490	6	46
08/67→08/69	Commodore A Coupe 2.5	25 S	Petrol	2490	6	46
08/67→01/72	Commodore A Coupe 2.5 GS	25 H	Petrol	2490	6	46
01/72→07/78	Commodore B 2.5	25 S	Petrol	2490	6	46
01/72→08/75	Commodore B 2.5 GS	25 H	Petrol	2490	6	46
01/72→07/78	Commodore B Coupe 2.5	25 S	Petrol	2490	6	46
01/72→08/75	Commodore B Coupe 2.5 GS	25 H	Petrol	2490	6	46
08/78→12/82	Commodore C 2.5 S	25 S	Petrol	2490	6	46
12/80→12/82	Commodore C Estate 2.5 S	25 S	Petrol	2490	6	46
02/86→04/89	Corsa A Box 1.0	10 S	Petrol	993	4	4
02/86→04/89	Corsa A Box 1.2	12 NC	Petrol	1196	4	17
02/86→07/90	Corsa A Box 1.2	12 S	Petrol	1196	4	17
02/86→04/89	Corsa A Box 1.2	12 ST	Petrol	1196	4	16
02/86→04/89	Corsa A Box 1.2	E 12 GV (Low compression)	Petrol	1196	4	17
02/86→04/89	Corsa A Box 1.3	13 NB	Petrol	1297	4	11
02/86→04/89	Corsa A Box 1.3	13 SB	Petrol	1297	4	11
06/87→04/89	Corsa A Box 1.5 D	15 D (4EC1)	Diesel	1488	4	12
09/82→03/93	Corsa A Hatchback 1.0	10 S	Petrol	993	4	4
09/82→08/90	Corsa A Hatchback 1.2	12 NC	Petrol	1196	4	17
09/82→08/90	Corsa A Hatchback 1.2	12 S	Petrol	1196	4	17
09/82→08/90	Corsa A Hatchback 1.2	E 12 GV (Low compression)	Petrol	1196	4	17
09/89→03/93	Corsa A Hatchback 1.2 i	C 12 NZ	Petrol	1187	4	5
01/90→03/93	Corsa A Hatchback 1.2 N	12 NV	Petrol	1196	4	15
09/82→02/90	Corsa A Hatchback 1.2 S	12 ST	Petrol	1196	4	16
09/85→10/89	Corsa A Hatchback 1.3	13 NB	Petrol	1297	4	11
09/82→03/93	Corsa A Hatchback 1.3 GL	13 S	Petrol	1297	4	11
09/86→09/90	Corsa A Hatchback 1.3 i	C 13 N	Petrol	1297	4	11
09/82→10/89	Corsa A Hatchback 1.3 S	13 SB	Petrol	1297	4	11
01/85→03/93	Corsa A Hatchback 1.4 i	C 14 NZ	Petrol	1389	4	13
01/90→03/93	Corsa A Hatchback 1.4 S	14 NV	Petrol	1389	4	13
09/91→03/93	Corsa A Hatchback 1.4 Si	C 14 SE	Petrol	1389	4	13
09/87→03/93	Corsa A Hatchback 1.5 D	15 D (4EC1)	Diesel	1488	4	12
03/88→03/93	Corsa A Hatchback 1.5 TD	15 DT (T4EC1)	Diesel	1488	4	12
08/88→09/92	Corsa A Hatchback 1.6 GSI	C 16 NZ	Petrol	1598	4	18
05/88→03/92	Corsa A Hatchback 1.6 GSI	E 16 SE	Petrol	1598	4	18
02/92→03/93	Corsa A Hatchback 1.6 GSI CAT	C 16 SE	Petrol	1598	4	18
09/82→09/92	Corsa A TR 1.0	10 S	Petrol	993	4	4
09/89→03/93	Corsa A TR 1.2 i	C 12 NZ	Petrol	1187	4	5
01/85→10/87	Corsa A TR 1.2 N	12 NC	Petrol	1196	4	17
01/85→10/87	Corsa A TR 1.2 N	E 12 GV (Low compression)	Petrol	1196	4	17



CCM

x



09/82→10/87	Corsa A TR 1.2 S	12 S	Petrol	1196	4	17
09/82→03/93	Corsa A TR 1.2 S	12 ST	Petrol	1196	4	16
09/85→10/87	Corsa A TR 1.3	13 NB	Petrol	1297	4	11
09/85→10/87	Corsa A TR 1.3	C 13 N	Petrol	1297	4	11
09/82→03/93	Corsa A TR 1.3 GL	13 S	Petrol	1297	4	11
09/82→10/87	Corsa A TR 1.3 S	13 SB	Petrol	1297	4	11
10/89→03/93	Corsa A TR 1.4 i	C 14 NZ	Petrol	1389	4	13
09/89→03/93	Corsa A TR 1.4 S	14 NV	Petrol	1389	4	13
10/87→11/92	Corsa A TR 1.5 D	15 D (4EC1)	Diesel	1488	4	12
10/87→03/93	Corsa A TR 1.5 TD	15 DT (T4EC1)	Diesel	1488	4	12
11/96→09/00	Corsa B 1.0 i 12V	X 10 XE	Petrol	973	3	9
03/93→09/00	Corsa B 1.2 i	12 NZ	Petrol	1195	4	5
03/93→09/00	Corsa B 1.2 i	C 12 NZ	Petrol	1187	4	5
03/93→09/00	Corsa B 1.2 i	X 12 SZ	Petrol	1195	4	5
03/98→09/00	Corsa B 1.2 i 16V	X 12 XE	Petrol	1199	4	9
04/93→08/94	Corsa B 1.4	C 14 SE	Petrol	1389	4	13
03/93→09/00	Corsa B 1.4 i	C 14 NZ	Petrol	1389	4	13
03/93→09/00	Corsa B 1.4 i	X 14 SZ	Petrol	1389	4	13
08/97→09/00	Corsa B 1.4 i 16V	C 14 SEL	Petrol	1389	4	13
09/94→09/00	Corsa B 1.4 i 16V	X 14 XE	Petrol	1389	4	13
03/93→09/00	Corsa B 1.4 Si	C 14 SE	Petrol	1389	4	13
03/93→09/00	Corsa B 1.5 D	15 D (4EC1)	Diesel	1488	4	12
03/93→09/00	Corsa B 1.5 TD	15 DT (T4EC1)	Diesel	1488	4	12
03/93→09/00	Corsa B 1.5 TD	X 15 DT (T4EC1)	Diesel	1488	4	12
03/93→09/00	Corsa B 1.6 GSI 16V	C 16 XE	Petrol	1598	4	21
09/94→09/00	Corsa B 1.6 i 16V	X 16 XE	Petrol	1598	4	21
02/96→09/00	Corsa B 1.7 D	17 D (4EE1)	Diesel	1686	4	19
02/96→09/00	Corsa B 1.7 D	X 17 D (4EE1)	Diesel	1686	4	19
08/99→09/00	Corsa B Box 1.4 i	X 14 SZ	Petrol	1389	4	13
08/99→09/00	Corsa B Box 1.7 D	17 D (4EE1)	Diesel	1686	4	19
08/99→09/00	Corsa B Box 1.7 D	X 17 D (4EE1)	Diesel	1686	4	19
01/99→	Corsa B Estate 1.4 i 16V	X 14 XE	Petrol	1389	4	13
01/99→	Corsa B Estate 1.7 D	X 17 D (4EE1)	Diesel	1686	4	19
09/00→12/09	Corsa C 1.0	Z 10 XE	Petrol	973	3	9
06/03→12/09	Corsa C 1.0	Z 10 XEP	Petrol	998	3	10
09/00→12/09	Corsa C 1.2	Z 12 XE	Petrol	1199	4	9
07/04→12/09	Corsa C 1.2 Twinport	Z 12 XEP	Petrol	1229	4	10
06/03→12/09	Corsa C 1.3 CDTI	Z 13 DT Euro 4	Diesel	1248	4	2
09/00→12/09	Corsa C 1.4	Z 14 XE	Petrol	1389	4	14
06/03→12/09	Corsa C 1.4 Twinport	Z 14 XEP	Petrol	1364	4	10
06/03→12/09	Corsa C 1.7 CDTI	Z 17 DTH	Diesel	1686	4	19
09/00→12/09	Corsa C 1.7 DI	Y 17 DTL	Diesel	1686	4	19
09/00→12/09	Corsa C 1.7 DTI	Y 17 DT	Diesel	1686	4	19
09/00→12/09	Corsa C 1.8	Z 18 XE	Petrol	1799	4	30
07/05→	Corsa C Box 1.2	Z 12 XEP	Petrol	1229	4	10
09/00→	Corsa C Box 1.2 16V	Z 12 XE	Petrol	1199	4	9
08/05→	Corsa C Box 1.3 CDTI 16V	Z 13 DT Euro 4	Diesel	1248	4	2
08/03→	Corsa C Box 1.4	Z 14 XEP	Petrol	1364	4	10
08/03→	Corsa C Box 1.7 CDTi	Z 17 DTH	Diesel	1686	4	19
09/00→	Corsa C Box 1.7 DI 16V	Y 17 DTL	Diesel	1686	4	19
09/00→	Corsa C Box 1.7 DTI 16V	Y 17 DT	Diesel	1686	4	19
07/06→	Corsa D 1.0	Z 10 XEP	Petrol	998	3	10
07/06→	Corsa D 1.2	Z 12 XEP	Petrol	1229	4	10
09/09→	Corsa D 1.2 LPG	Z 12 XEP	Petrol	1229	4	10
07/06→	Corsa D 1.3 CDTI	A 13 DTC Euro 5 (CDTI)	Diesel	1248	4	1
06/10→	Corsa D 1.3 CDTI	A 13 DTR Euro 5	Diesel	1248	4	1
07/06→	Corsa D 1.3 CDTI	Z 13 DTH	Diesel	1248	4	3
07/06→	Corsa D 1.3 CDTI	Z 13 DTJ	Diesel	1248	4	3
07/06→	Corsa D 1.4	Z 14 XEP	Petrol	1364	4	10
07/06→	Corsa D 1.4 LPG	Z 14 XEP	Petrol	1364	4	10

MODEL INDEX

Modelverzeichnis • Index de modele • Índice de Modelo
 Indeks modelu • Модель автомобиля • دليل الموديل

CCM
x

9

07/09→	Corsa D Van 1.2	Z 12 XEP	Petrol	1229	4	10
07/06→	Corsa D Van 1.3 CDTI	A 13 DTC Euro 5 (CDTI)	Diesel	1248	4	1
06/10→	Corsa D Van 1.3 CDTI	A 13 DTR Euro 5	Diesel	1248	4	1
07/06→	Corsa D Van 1.3 CDTI	Z 13 DTH	Diesel	1248	4	3
07/06→	Corsa D Van 1.3 CDTI	Z 13 DTJ	Diesel	1248	4	3
03/95→10/98	Frontera A 2.2 i	X 22 XE	Petrol	2198	4	45
03/92→10/98	Frontera A 2.3 TD	23 DTR	Diesel	2260	4	55
03/92→10/98	Frontera A 2.4 i	C 24 NE	Petrol	2410	4	62
09/96→10/98	Frontera A 2.5 TDS	25 TDS (VM41B)	Diesel	2500	4	56
03/92→10/98	Frontera A Sport 2.0 i	C 20 NE	Petrol	1998	4	45
03/92→10/98	Frontera A Sport 2.0 i	X 20 SE	Petrol	1998	4	45
09/96→10/98	Frontera A Sport 2.5 TDS	25 TDS (VM41B)	Diesel	2500	4	56
10/98→09/02	Frontera B 2.2 DTI	X 22 DTH	Diesel	2172	4	40
10/98→	Frontera B 2.2 DTI	Y 22 DTH	Diesel	2172	4	40
10/98→	Frontera B 2.2 i	X 22 SE	Petrol	2198	4	45
09/68→08/73	GT 1.9	19 S	Petrol	1897	4	57
04/11→	Insignia 1.4	A 14 NET Euro 5	Petrol	1364	4	8
07/12→	Insignia 1.4 LPG	A 14 NET Euro 5	Petrol	1364	4	8
07/08→	Insignia 1.6 Turbo	A 16 LET Euro 5	Petrol	1598	4	20
07/08→	Insignia 2.0 Biturbo CDTI	A 20 DTR Euro 5	Diesel	1956	4	35
05/09→	Insignia 2.0 Biturbo CDTI 4x4	A 20 DTR Euro 5	Diesel	1956	4	35
07/08→	Insignia 2.0 CDTI	A 20 DT Euro 5	Diesel	1956	4	35
07/08→	Insignia 2.0 CDTI	A 20 DTC Euro 5	Diesel	1956	4	35
03/12→	Insignia 2.0 CDTI	A 20 DTE Euro 5	Diesel	1956	4	35
07/08→	Insignia 2.0 CDTI	A 20 DTH Euro 5	Diesel	1956	4	35
07/08→	Insignia 2.0 CDTI	A 20 DTJ Euro 5	Diesel	1956	4	35
07/08→	Insignia 2.0 CDTI	A 20 DTL Euro 5	Diesel	1956	4	35
06/10→	Insignia 2.0 CDTI 4x4	A 20 DTH Euro 5	Diesel	1956	4	35
04/11→	Insignia Saloon 1.4	A 14 NET Euro 5	Petrol	1364	4	8
07/12→	Insignia Saloon 1.4 LPG	A 14 NET Euro 5	Petrol	1364	4	8
01/09→	Insignia Saloon 1.6 Turbo	A 16 LET Euro 5	Petrol	1598	4	20
07/08→	Insignia Saloon 2.0 Biturbo CDTI	A 20 DTR Euro 5	Diesel	1956	4	35
07/08→	Insignia Saloon 2.0 Biturbo CDTI 4x4	A 20 DTR Euro 5	Diesel	1956	4	35
07/08→	Insignia Saloon 2.0 CDTI	A 20 DT Euro 5	Diesel	1956	4	35
07/08→	Insignia Saloon 2.0 CDTI	A 20 DTC Euro 5	Diesel	1956	4	35
03/12→	Insignia Saloon 2.0 CDTI	A 20 DTE Euro 5	Diesel	1956	4	35
07/08→	Insignia Saloon 2.0 CDTI	A 20 DTH Euro 5	Diesel	1956	4	35
07/08→	Insignia Saloon 2.0 CDTI	A 20 DTJ Euro 5	Diesel	1956	4	35
07/08→	Insignia Saloon 2.0 CDTI	A 20 DTL Euro 5	Diesel	1956	4	35
06/10→	Insignia Saloon 2.0 CDTI 4x4	A 20 DTH Euro 5	Diesel	1956	4	35
09/11→	Insignia Sports Tourer 1.4	A 14 NET Euro 5	Petrol	1364	4	8
07/12→	Insignia Sports Tourer 1.4 LPG	A 14 NET Euro 5	Petrol	1364	4	8
01/09→	Insignia Sports Tourer 1.6 Turbo	A 16 LET Euro 5	Petrol	1598	4	20
07/08→	Insignia Sports Tourer 2.0 Biturbo CDTI	A 20 DTR Euro 5	Diesel	1956	4	35
07/08→	Insignia Sports Tourer 2.0 Biturbo CDTI 4x4	A 20 DTR Euro 5	Diesel	1956	4	35
07/08→	Insignia Sports Tourer 2.0 CDTI	A 20 DT Euro 5	Diesel	1956	4	35
07/08→	Insignia Sports Tourer 2.0 CDTI	A 20 DTC Euro 5	Diesel	1956	4	35
03/12→	Insignia Sports Tourer 2.0 CDTI	A 20 DTE Euro 5	Diesel	1956	4	35
07/08→	Insignia Sports Tourer 2.0 CDTI	A 20 DTH Euro 5	Diesel	1956	4	35
07/08→	Insignia Sports Tourer 2.0 CDTI	A 20 DTJ Euro 5	Diesel	1956	4	35
07/08→	Insignia Sports Tourer 2.0 CDTI	A 20 DTL Euro 5	Diesel	1956	4	35
06/10→	Insignia Sports Tourer 2.0 CDTI 4x4	A 20 DTH Euro 5	Diesel	1956	4	35
09/62→08/65	Kadett A 1.0	10 N	Petrol	993	4	4
09/62→08/65	Kadett A 1.0 S	10 S	Petrol	993	4	4
10/63→08/65	Kadett A Coupe 1.0 S	10 S	Petrol	993	4	4
03/63→08/65	Kadett A Estate 1.0 N	10 N	Petrol	993	4	4
03/63→08/65	Kadett A Estate 1.0 S	10 S	Petrol	993	4	4
08/71→08/73	Kadett B 1.2 S	12 S	Petrol	1196	4	17
08/71→08/73	Kadett B Coupe 1.2	12 S	Petrol	1196	4	17
08/67→08/73	Kadett B Coupe 1.9	19 S	Petrol	1897	4	57



CCM

x



08/71→08/73	Kadett B Estate 1.2	12 S	Petrol	1196	4	17
01/74→07/79	Kadett C 1.0	10 N	Petrol	993	4	4
08/73→07/79	Kadett C 1.2	12 N	Petrol	1196	4	17
08/73→07/79	Kadett C 1.2 S	12 S	Petrol	1196	4	17
05/77→07/79	Kadett C 1.6 S	16 S	Petrol	1584	4	43
05/75→07/79	Kadett C City 1.0	10 N	Petrol	993	4	4
05/75→07/79	Kadett C City 1.2	12 N	Petrol	1196	4	17
08/73→07/79	Kadett C City 1.2 S	12 S	Petrol	1196	4	17
05/77→07/79	Kadett C City 1.6 S	16 S	Petrol	1584	4	43
01/74→07/79	Kadett C Coupe 1.0	10 N	Petrol	993	4	4
08/73→07/79	Kadett C Coupe 1.2	12 N	Petrol	1196	4	17
08/73→07/79	Kadett C Coupe 1.2 S	12 S	Petrol	1196	4	17
05/77→07/79	Kadett C Coupe 1.6 S	16 S	Petrol	1584	4	43
08/77→07/79	Kadett C Coupe 2.0 E Rallye	20 E	Petrol	1979	4	60
01/74→07/79	Kadett C Estate 1.0	10 N	Petrol	993	4	4
08/73→07/79	Kadett C Estate 1.2	12 N	Petrol	1196	4	17
08/73→07/79	Kadett C Estate 1.2 S	12 S	Petrol	1196	4	17
05/77→07/79	Kadett C Estate 1.6 S	16 S	Petrol	1584	4	43
09/79→08/82	Kadett D 1.0	10 N	Petrol	993	4	4
08/79→08/84	Kadett D 1.0	10 S	Petrol	993	4	4
08/79→07/82	Kadett D 1.2	12 N	Petrol	1196	4	17
08/82→08/84	Kadett D 1.2	12 ST	Petrol	1196	4	16
08/79→08/84	Kadett D 1.2 S	12 S	Petrol	1196	4	17
08/79→08/84	Kadett D 1.3 N	13 N	Petrol	1297	4	11
08/79→08/84	Kadett D 1.3 N	C 13 N	Petrol	1297	4	11
08/79→08/84	Kadett D 1.3 S	13 S	Petrol	1297	4	11
09/79→08/84	Kadett D 1.6	16 N	Petrol	1598	4	26
03/82→08/84	Kadett D 1.6 D	16 D	Diesel	1598	4	25
09/81→08/84	Kadett D 1.6 S	16 SH	Petrol	1598	4	26
02/83→08/84	Kadett D 1.8 GT/E	18 E	Petrol	1796	4	41
08/79→07/82	Kadett D Estate 1.2	12 N	Petrol	1196	4	17
08/79→08/84	Kadett D Estate 1.2 S	12 S	Petrol	1196	4	17
08/79→08/84	Kadett D Estate 1.3 N	13 N	Petrol	1297	4	11
08/79→08/84	Kadett D Estate 1.3 S	13 S	Petrol	1297	4	11
09/79→08/84	Kadett D Estate 1.6	16 N	Petrol	1598	4	26
03/82→08/84	Kadett D Estate 1.6 D	16 D	Diesel	1598	4	25
09/81→08/84	Kadett D Estate 1.6 S	16 SH	Petrol	1598	4	26
09/84→07/86	Kadett E 1.2	12 SC	Petrol	1196	4	17
09/85→08/91	Kadett E 1.3 i CAT	C 13 N	Petrol	1297	4	11
09/84→08/89	Kadett E 1.3 N	13 N	Petrol	1297	4	11
09/84→08/89	Kadett E 1.3 N	13 NB	Petrol	1297	4	11
09/84→08/87	Kadett E 1.3 S	13 S	Petrol	1297	4	11
01/90→08/91	Kadett E 1.4 i	C 14 NZ	Petrol	1389	4	13
01/90→08/91	Kadett E 1.4 S	14 NV	Petrol	1389	4	13
07/88→08/91	Kadett E 1.5 TD	15 DT (T4EC1)	Diesel	1488	4	12
09/87→08/91	Kadett E 1.6	E 16 SE	Petrol	1598	4	18
09/84→01/89	Kadett E 1.6 D	16 D	Diesel	1598	4	25
09/84→01/89	Kadett E 1.6 D	16 DA	Diesel	1598	4	25
09/86→08/91	Kadett E 1.6 i	E 16 NZ	Petrol	1598	4	18
09/86→08/91	Kadett E 1.6 i CAT	C 16 LZ	Petrol	1598	4	18
09/86→08/91	Kadett E 1.6 i CAT	C 16 NZ	Petrol	1598	4	18
09/84→08/86	Kadett E 1.6 S	16 SH	Petrol	1598	4	26
09/86→08/91	Kadett E 1.6 S	16 SV	Petrol	1598	4	18
02/89→08/91	Kadett E 1.7 D	17 D	Diesel	1699	4	34
09/87→08/90	Kadett E 1.8	18 E	Petrol	1796	4	41
09/84→08/86	Kadett E 1.8 i	18 E	Petrol	1796	4	41
09/84→08/86	Kadett E 1.8 i	18 SE	Petrol	1796	4	41
09/90→08/91	Kadett E 1.8 i	18 SV	Petrol	1796	4	41
10/85→08/86	Kadett E 1.8 i	C 18 NE	Petrol	1796	4	41
09/90→08/91	Kadett E 1.8 i	C 18 NT	Petrol	1771	4	41

MODEL INDEX

Modelverzeichnis • Index de modele • Índice de Modelo
Indeks modelu • Модель автомобиля • دليل الموديل



CCM

x



9

09/90→08/91	Kadett E 1.8 i	C 18 NZ	Petrol	1796	4	41
09/87→08/91	Kadett E 1.8 S	E 18 NV	Petrol	1796	4	42
03/87→08/91	Kadett E 2.0 i	20 NE	Petrol	1998	4	45
03/87→08/91	Kadett E 2.0 i	20 SE	Petrol	1998	4	45
03/87→08/91	Kadett E 2.0 i CAT	C 20 NE	Petrol	1998	4	45
09/84→07/86	Kadett E Box 1.2	12 SC	Petrol	1196	4	17
09/84→07/89	Kadett E Box 1.3 N	13 N	Petrol	1297	4	11
09/84→07/89	Kadett E Box 1.3 N	13 NB	Petrol	1297	4	11
01/90→08/91	Kadett E Box 1.4 i	C 14 NZ	Petrol	1389	4	13
08/84→08/88	Kadett E Box 1.6 D	16 D	Diesel	1598	4	25
08/84→08/88	Kadett E Box 1.6 D	16 DA	Diesel	1598	4	25
08/89→09/93	Kadett E Box 1.6 i	C 16 NZ	Petrol	1598	4	18
08/88→09/92	Kadett E Box 1.7 D	17 D	Diesel	1699	4	34
08/84→09/92	Kadett E Box 1.8 i	C 18 NT	Petrol	1771	4	41
01/86→12/89	Kadett E Combo 1.3 N	13 N	Petrol	1297	4	11
01/86→12/89	Kadett E Combo 1.3 S	13 S	Petrol	1297	4	11
08/91→07/94	Kadett E Combo 1.4 i	C 14 NZ	Petrol	1389	4	13
07/89→08/91	Kadett E Combo 1.4 S	14 NV	Petrol	1389	4	13
09/86→06/93	Kadett E Combo 1.6	16 SH	Petrol	1598	4	26
09/86→12/91	Kadett E Combo 1.6	16 SV	Petrol	1598	4	18
01/86→12/89	Kadett E Combo 1.6 D	16 DA	Diesel	1598	4	25
08/91→07/94	Kadett E Combo 1.6 i	C 16 NZ	Petrol	1598	4	18
01/89→07/94	Kadett E Combo 1.7 D	17 D	Diesel	1699	4	34
07/92→07/94	Kadett E Combo 1.7 D	17 DR	Diesel	1699	4	34
03/87→02/93	Kadett E Convertible 1.3 S	13 S	Petrol	1297	4	11
01/90→08/91	Kadett E Convertible 1.4 i	C 14 NZ	Petrol	1389	4	13
08/90→02/93	Kadett E Convertible 1.4 S	14 NV	Petrol	1389	4	13
07/89→02/93	Kadett E Convertible 1.6 i	16 SV	Petrol	1598	4	18
10/86→02/93	Kadett E Convertible 1.6 i	E 16 NZ	Petrol	1598	4	18
10/87→02/93	Kadett E Convertible 1.6 i CAT	C 16 LZ	Petrol	1598	4	18
10/87→02/93	Kadett E Convertible 1.6 i CAT	C 16 NZ	Petrol	1598	4	18
09/90→05/92	Kadett E Convertible 2.0	C 20 XE	Petrol	1998	4	45
09/90→05/92	Kadett E Convertible 2.0 GSi	20 SER	Petrol	1998	4	45
10/86→02/93	Kadett E Convertible 2.0 i	20 NE	Petrol	1998	4	45
10/86→02/93	Kadett E Convertible 2.0 i CAT	C 20 NE	Petrol	1998	4	45
09/84→07/86	Kadett E Estate 1.2	12 SC	Petrol	1196	4	17
01/85→12/87	Kadett E Estate 1.3	13 S	Petrol	1297	4	11
09/85→08/91	Kadett E Estate 1.3 i CAT	C 13 N	Petrol	1297	4	11
09/84→08/91	Kadett E Estate 1.3 N	13 N	Petrol	1297	4	11
09/84→08/87	Kadett E Estate 1.3 S	13 S	Petrol	1297	4	11
01/90→08/91	Kadett E Estate 1.4 i	C 14 NZ	Petrol	1389	4	13
01/90→08/91	Kadett E Estate 1.4 S	14 NV	Petrol	1389	4	13
07/88→08/91	Kadett E Estate 1.5 TD	15 DT (T4EC1)	Diesel	1488	4	12
09/86→08/91	Kadett E Estate 1.6	16 SV	Petrol	1598	4	18
09/84→01/89	Kadett E Estate 1.6 D	16 D	Diesel	1598	4	25
09/84→01/89	Kadett E Estate 1.6 D	16 DA	Diesel	1598	4	25
09/86→08/91	Kadett E Estate 1.6 i	E 16 NZ	Petrol	1598	4	18
09/86→08/91	Kadett E Estate 1.6 i CAT	C 16 LZ	Petrol	1598	4	18
09/86→08/91	Kadett E Estate 1.6 i CAT	C 16 NZ	Petrol	1598	4	18
09/84→08/86	Kadett E Estate 1.6 S	16 SH	Petrol	1598	4	26
02/89→08/91	Kadett E Estate 1.7 D	17 D	Diesel	1699	4	34
12/88→08/91	Kadett E Estate 1.8	18 SE	Petrol	1796	4	41
10/85→08/86	Kadett E Estate 1.8 E	C 18 NE	Petrol	1796	4	41
09/84→08/86	Kadett E Estate 1.8 i	18 E	Petrol	1796	4	41
06/85→08/91	Kadett E Estate 1.8 i	C 18 NT	Petrol	1771	4	41
06/85→08/91	Kadett E Estate 1.8 i	C 18 NZ	Petrol	1796	4	41
09/87→08/91	Kadett E Estate 1.8 S	E 18 NV	Petrol	1796	4	42
09/87→08/91	Kadett E Estate 2.0 i	20 NE	Petrol	1998	4	45
09/87→08/91	Kadett E Estate 2.0 i CAT	C 20 NE	Petrol	1998	4	45
09/84→07/86	Kadett E Hatchback 1.2	12 SC	Petrol	1196	4	17



CCM

x



01/85→12/87	Kadett E Hatchback 1.3	13 S	Petrol	1297	4	11
09/85→08/91	Kadett E Hatchback 1.3 i CAT	C 13 N	Petrol	1297	4	11
09/84→08/91	Kadett E Hatchback 1.3 N	13 N	Petrol	1297	4	11
09/84→08/91	Kadett E Hatchback 1.3 N	13 NB	Petrol	1297	4	11
09/84→08/87	Kadett E Hatchback 1.3 S	13 S	Petrol	1297	4	11
01/90→08/91	Kadett E Hatchback 1.4 i	C 14 NZ	Petrol	1389	4	13
01/90→08/91	Kadett E Hatchback 1.4 S	14 NV	Petrol	1389	4	13
09/89→08/91	Kadett E Hatchback 1.4 S	C 14 SE	Petrol	1389	4	13
07/88→08/91	Kadett E Hatchback 1.5 TD	15 DT (T4EC1)	Diesel	1488	4	12
09/84→01/89	Kadett E Hatchback 1.6 D	16 D	Diesel	1598	4	25
09/84→01/89	Kadett E Hatchback 1.6 D	16 DA	Diesel	1598	4	25
09/86→08/91	Kadett E Hatchback 1.6 i	E 16 NZ	Petrol	1598	4	18
09/86→08/91	Kadett E Hatchback 1.6 i CAT	C 16 LZ	Petrol	1598	4	18
09/86→08/91	Kadett E Hatchback 1.6 i CAT	C 16 NZ	Petrol	1598	4	18
09/84→08/86	Kadett E Hatchback 1.6 S	16 SH	Petrol	1598	4	26
09/86→08/91	Kadett E Hatchback 1.6 S	16 SV	Petrol	1598	4	18
02/89→08/91	Kadett E Hatchback 1.7 D	17 D	Diesel	1699	4	34
10/85→08/86	Kadett E Hatchback 1.8 E	C 18 NE	Petrol	1796	4	41
09/84→08/86	Kadett E Hatchback 1.8 GSI	18 E	Petrol	1796	4	41
06/85→08/91	Kadett E Hatchback 1.8 i	C 18 NT	Petrol	1771	4	41
06/85→08/91	Kadett E Hatchback 1.8 i	C 18 NZ	Petrol	1796	4	41
06/85→08/91	Kadett E Hatchback 1.8 i	S 18 NV	Petrol	1796	4	42
09/87→08/91	Kadett E Hatchback 1.8 S	E 18 NV	Petrol	1796	4	42
09/87→08/91	Kadett E Hatchback 1.8 S	S 18 NV	Petrol	1796	4	42
09/86→08/91	Kadett E Hatchback 2.0 GSI	20 NE	Petrol	1998	4	45
09/86→08/91	Kadett E Hatchback 2.0 GSI	20 SEH	Petrol	1998	4	45
12/87→08/91	Kadett E Hatchback 2.0 GSI 16V	20 XE	Petrol	1998	4	45
03/88→08/91	Kadett E Hatchback 2.0 GSI 16V	20 XEJ	Petrol	1984	4	45
03/88→08/91	Kadett E Hatchback 2.0 GSI 16V CAT	C 20 XE	Petrol	1998	4	45
09/86→08/91	Kadett E Hatchback 2.0 GSI CAT	C 20 NE	Petrol	1998	4	45
04/72→08/75	Manta A 1.2	12 S	Petrol	1196	4	17
02/75→08/75	Manta A 1.6	16 S	Petrol	1584	4	43
09/70→08/75	Manta A 1.6 S	16 S	Petrol	1584	4	43
09/70→08/75	Manta A 1.9 S	19 S	Petrol	1897	4	57
08/76→07/83	Manta B 1.2 N	12 N	Petrol	1196	4	17
09/75→02/79	Manta B 1.2 S	12 S	Petrol	1196	4	17
03/79→12/80	Manta B 1.3 N	13 N	Petrol	1297	4	11
08/81→08/86	Manta B 1.3 S	13 S	Petrol	1297	4	11
09/75→12/81	Manta B 1.6 S	16 S	Petrol	1584	4	43
07/82→08/87	Manta B 1.8 S	18 S	Petrol	1796	4	41
09/75→12/80	Manta B 1.9 S	19 S	Petrol	1897	4	57
08/77→12/80	Manta B 2.0	20 N	Petrol	1979	4	60
08/77→08/88	Manta B 2.0 E	20 E	Petrol	1979	4	60
08/77→08/84	Manta B 2.0 S	20 S	Petrol	1979	4	60
03/79→12/80	Manta B Cc 1.3 N	13 N	Petrol	1297	4	11
08/79→08/86	Manta B Cc 1.3 S	13 S	Petrol	1297	4	11
08/77→07/81	Manta B Cc 1.6	16 S	Petrol	1584	4	43
07/82→08/87	Manta B Cc 1.8 S	18 S	Petrol	1796	4	41
08/77→12/80	Manta B Cc 2.0	20 N	Petrol	1979	4	60
08/77→08/88	Manta B Cc 2.0 E	20 E	Petrol	1979	4	60
08/77→08/84	Manta B Cc 2.0 S	20 S	Petrol	1979	4	60
04/05→05/10	Meriva 1.3 CDTI	Y 13 DT Euro 3/4	Diesel	1248	4	2
04/05→05/10	Meriva 1.3 CDTI	Z 13 DT Euro 4	Diesel	1248	4	2
09/03→05/10	Meriva 1.3 CDTI	Z 13 DTJ	Diesel	1248	4	3
07/04→05/10	Meriva 1.4 16V Twinport	Z 14 XEP	Petrol	1364	4	10
07/04→05/10	Meriva 1.4 16V Twinport LPG	Z 14 XEP	Petrol	1364	4	10
05/03→05/10	Meriva 1.6	Z 16 SE	Petrol	1598	4	22
01/06→05/10	Meriva 1.6	Z 16 XEP	Petrol	1598	4	23
05/03→05/10	Meriva 1.6 16V	Z 16 XE	Petrol	1598	4	22
09/03→05/10	Meriva 1.7 CDTI	Z 17 DTH	Diesel	1686	4	19

MODEL INDEX

Modelverzeichnis • Index de modele • Índice de Modelo
Indeks modelu • Модель автомобиля • دليل الموديل



CCM



9

Year Range	Model	Engine	Fuel	CCM	Gears	Index
09/03→05/10	Meriva 1.7 DTI	Y 17 DT	Diesel	1686	4	19
09/03→05/10	Meriva 1.7 DTI	Y 17 DTL	Diesel	1686	4	19
05/03→05/10	Meriva 1.8	Z 18 XE	Petrol	1799	4	30
06/10→	Meriva B 1.3 CDTI	A 13 DTC Euro 5 (CDTI)	Diesel	1248	4	1
06/10→	Meriva B 1.4	A 14 NET Euro 5	Petrol	1364	4	8
04/13→	Mokka 1.4	A 14 NET Euro 5	Petrol	1364	4	8
06/12→	Mokka 1.4 4x4	A 14 NET Euro 5	Petrol	1364	4	8
11/84→08/86	Monza A 2.2 E	22 E	Petrol	2197	4	61
04/78→07/82	Monza A 3.0	30 H	Petrol	2968	6	60
02/78→08/86	Monza A 3.0 GSE	30 E	Petrol	2969	6	60
09/85→08/86	Monza A 3.0 GSE	C 30 LE	Petrol	2969	6	60
05/10→	Movano B Box 2.3 CDTI [RWD]	M9T 686 Euro 5	Diesel	2298	4	44
05/10→	Movano B Box 2.3 CDTI [RWD]	M9T 690 Euro 5	Diesel	2298	4	44
05/10→	Movano B Box 2.3 CDTI [RWD]	M9T 692 Euro 4	Diesel	2298	4	44
05/10→	Movano B Box 2.3 CDTI [RWD]	M9T 694 Euro 4	Diesel	2298	4	44
05/10→	Movano B Box 2.3 CDTI [RWD]	M9T 696 Euro 4	Diesel	2298	4	44
05/10→	Movano B Box 2.3 CDTI [RWD]	M9T 698 Euro 5	Diesel	2298	4	44
05/10→	Movano B Box 2.3 CDTI FWD	M9T 670 Euro 5	Diesel	2298	4	44
05/10→	Movano B Box 2.3 CDTI FWD	M9T 672 Euro 5	Diesel	2298	4	44
05/10→	Movano B Box 2.3 CDTI FWD	M9T 676 Euro 4	Diesel	2298	4	44
05/10→	Movano B Box 2.3 CDTI FWD	M9T 678	Diesel	2298	4	44
05/10→	Movano B Box 2.3 CDTI FWD	M9T 680	Diesel	2298	4	44
12/10→	Movano B Bus 2.3 CDTI	M9T 670 Euro 5	Diesel	2298	4	44
12/10→	Movano B Bus 2.3 CDTI	M9T 672 Euro 5	Diesel	2298	4	44
12/10→	Movano B Bus 2.3 CDTI	M9T 676 Euro 4	Diesel	2298	4	44
12/10→	Movano B Bus 2.3 CDTI	M9T 678	Diesel	2298	4	44
12/10→	Movano B Bus 2.3 CDTI	M9T 680	Diesel	2298	4	44
05/10→	Movano B Platform/Chassis 2.3 CDTI [RWD]	M9T 690 Euro 5	Diesel	2298	4	44
05/10→	Movano B Platform/Chassis 2.3 CDTI [RWD]	M9T 692 Euro 4	Diesel	2298	4	44
05/10→	Movano B Platform/Chassis 2.3 CDTI [RWD]	M9T 694 Euro 4	Diesel	2298	4	44
05/10→	Movano B Platform/Chassis 2.3 CDTI [RWD]	M9T 696 Euro 4	Diesel	2298	4	44
05/10→	Movano B Platform/Chassis 2.3 CDTI [RWD]	M9T 698 Euro 5	Diesel	2298	4	44
05/10→	Movano B Platform/Chassis 2.3 CDTI FWD	M9T 670 Euro 5	Diesel	2298	4	44
05/10→	Movano B Platform/Chassis 2.3 CDTI FWD	M9T 672 Euro 5	Diesel	2298	4	44
05/10→	Movano B Platform/Chassis 2.3 CDTI FWD	M9T 676 Euro 4	Diesel	2298	4	44
05/10→	Movano B Platform/Chassis 2.3 CDTI FWD	M9T 678	Diesel	2298	4	44
05/10→	Movano B Platform/Chassis 2.3 CDTI FWD	M9T 680	Diesel	2298	4	44
09/00→	Movano Box 2.2 DTI	G9T 720	Diesel	2188	4	47
09/00→	Movano Box 2.2 DTI	G9T 722	Diesel	2188	4	47
10/03→	Movano Box 2.5 CDTI	G9U 632 Euro 4	Diesel	2464	4	51
10/03→	Movano Box 2.5 CDTI	G9U 650 Euro 4	Diesel	2464	4	51
10/01→	Movano Box 2.5 DTI	G9U 720 Euro 3	Diesel	2463	4	52
10/01→	Movano Box 2.5 DTI	G9U 724 Euro 3	Diesel	2463	4	52
10/01→	Movano Box 2.5 DTI	G9U 754 Euro 3	Diesel	2463	4	52
01/99→10/01	Movano Box 2.8 DTI	S9W 700	Diesel	2799	4	59
01/99→10/01	Movano Box 2.8 DTI	S9W 702	Diesel	2799	4	59
09/00→	Movano Combi	G9T 750	Diesel	2188	4	47
09/00→	Movano Combi 2.2 DTI	G9T 720	Diesel	2188	4	47
09/00→	Movano Combi 2.2 DTI	G9T 722	Diesel	2188	4	47
08/06→	Movano Combi 2.5 CDTI	G9U 632 Euro 4	Diesel	2464	4	51
08/06→	Movano Combi 2.5 CDTI	G9U 650 Euro 4	Diesel	2464	4	51
10/01→	Movano Combi 2.5 DTI	G9U 720 Euro 3	Diesel	2463	4	52
10/01→	Movano Combi 2.5 DTI	G9U 724 Euro 3	Diesel	2463	4	52
10/01→	Movano Combi 2.5 DTI	G9U 754 Euro 3	Diesel	2463	4	52
07/98→10/01	Movano Combi 2.8 DTI	S9W 700	Diesel	2799	4	59
07/98→10/01	Movano Combi 2.8 DTI	S9W 702	Diesel	2799	4	59
09/00→	Movano Dumptruck 2.2 DTI	G9T 720	Diesel	2188	4	47
09/00→	Movano Dumptruck 2.2 DTI	G9T 722	Diesel	2188	4	47
08/06→	Movano Dumptruck 2.5 CDTI	G9U 632 Euro 4	Diesel	2464	4	51
08/06→	Movano Dumptruck 2.5 CDTI	G9U 650 Euro 4	Diesel	2464	4	51



CCM

x



9

10/01→	Movano Dumptruck 2.5 DTI	G9U 720 Euro 3	Diesel	2463	4	52
10/01→	Movano Dumptruck 2.5 DTI	G9U 724 Euro 3	Diesel	2463	4	52
10/01→	Movano Dumptruck 2.5 DTI	G9U 754 Euro 3	Diesel	2463	4	52
01/99→10/01	Movano Dumptruck 2.8 DTI	S9W 700	Diesel	2799	4	59
01/99→10/01	Movano Dumptruck 2.8 DTI	S9W 702	Diesel	2799	4	59
09/00→	Movano Platform/Chassis 2.2 DTI	G9T 720	Diesel	2188	4	47
09/00→	Movano Platform/Chassis 2.2 DTI	G9T 722	Diesel	2188	4	47
08/06→	Movano Platform/Chassis 2.5 CDTI	G9U 632 Euro 4	Diesel	2464	4	51
08/06→	Movano Platform/Chassis 2.5 CDTI	G9U 650 Euro 4	Diesel	2464	4	51
10/01→	Movano Platform/Chassis 2.5 DTI	G9U 720 Euro 3	Diesel	2463	4	52
10/01→	Movano Platform/Chassis 2.5 DTI	G9U 724 Euro 3	Diesel	2463	4	52
10/01→	Movano Platform/Chassis 2.5 DTI	G9U 754 Euro 3	Diesel	2463	4	52
07/98→10/01	Movano Platform/Chassis 2.8 DTI	S9W 700	Diesel	2799	4	59
07/98→10/01	Movano Platform/Chassis 2.8 DTI	S9W 702	Diesel	2799	4	59
08/67→08/71	Olympia A Coupe 1.9	19 S	Petrol	1897	4	57
01/94→	Omega 2.5 TD	U 25TD	Diesel	2498	6	29
09/86→03/94	Omega A 1.8	18 SEH	Petrol	1796	4	41
09/87→03/94	Omega A 1.8	E 18 NVR	Petrol	1796	4	42
09/86→08/87	Omega A 1.8 N	18 NV	Petrol	1796	4	42
11/86→09/88	Omega A 1.8 N	18 SV	Petrol	1796	4	41
09/86→03/94	Omega A 1.8 S	18 SV	Petrol	1796	4	41
09/86→03/94	Omega A 2.0	20 SE	Petrol	1998	4	45
09/86→03/94	Omega A 2.0 i	C 20 NE	Petrol	1998	4	45
10/86→08/88	Omega A 2.3 TD	23 YDT	Diesel	2260	4	55
08/88→03/94	Omega A 2.3 TD Interc.	23 DTR	Diesel	2260	4	55
09/88→03/94	Omega A 2.4 i	C 24 NE	Petrol	2410	4	62
09/90→03/94	Omega A 2.6 i	C 26 NE	Petrol	2594	6	50
03/87→09/90	Omega A 3.0	30 NE	Petrol	2968	6	60
03/87→09/90	Omega A 3.0	30 NE	Petrol	2969	6	60
03/87→12/87	Omega A 3.0	C 30 LE	Petrol	2969	6	60
03/88→03/94	Omega A 3.0	C 30 NE	Petrol	2969	6	60
09/89→03/94	Omega A 3.0 24V	C 30 SE	Petrol	2969	6	62
09/89→03/94	Omega A 3.0 24V	C 30 SEJ	Petrol	2969	6	62
09/86→03/94	Omega A Estate 1.8	18 SEH	Petrol	1796	4	41
09/87→03/94	Omega A Estate 1.8	E 18 NVR	Petrol	1796	4	42
09/86→08/87	Omega A Estate 1.8 N	18 NV	Petrol	1796	4	42
11/86→09/88	Omega A Estate 1.8 N	18 SV	Petrol	1796	4	41
09/86→03/94	Omega A Estate 1.8 S	18 SV	Petrol	1796	4	41
09/86→03/94	Omega A Estate 2.0	20 SE	Petrol	1998	4	45
09/87→04/94	Omega A Estate 2.0	C 20 NE	Petrol	1998	4	45
09/86→03/94	Omega A Estate 2.0 i	C 20 NE	Petrol	1998	4	45
09/86→08/88	Omega A Estate 2.3 TD	23 YDT	Diesel	2260	4	55
09/88→03/94	Omega A Estate 2.3 TD Interc.	23 DTR	Diesel	2260	4	55
09/88→03/94	Omega A Estate 2.4 i	C 24 NE	Petrol	2410	4	62
09/90→03/94	Omega A Estate 2.6 i	C 26 NE	Petrol	2594	6	50
03/87→09/90	Omega A Estate 3.0	30 NE	Petrol	2968	6	60
03/87→09/90	Omega A Estate 3.0	30 NE	Petrol	2969	6	60
03/87→03/94	Omega A Estate 3.0	C 30 LE	Petrol	2969	6	60
09/89→03/94	Omega A Estate 3.0 24V	C 30 SEJ	Petrol	2969	6	62
09/88→04/94	Omega A Estate 3.0 24V Omega 3000	C 30 SE	Petrol	2969	6	62
03/87→03/94	Omega A Estate 3.0 CAT	C 30 NE	Petrol	2969	6	60
03/94→12/00	Omega B 2.0	20 SE	Petrol	1998	4	45
03/94→09/99	Omega B 2.0	X 20 SE	Petrol	1998	4	45
03/94→09/99	Omega B 2.0 16V	X 20 XEV	Petrol	1998	4	45
09/97→09/00	Omega B 2.0 DTI 16V	X 20 DTH	Diesel	1995	4	38
09/00→07/03	Omega B 2.2 DTI 16V	Y 22 DTH	Diesel	2172	4	40
01/01→	Omega B 2.2 DTI 16V	Y 22 DTR	Diesel	2172	4	40
05/94→05/99	Omega B 2.5 D	X 25 TD	Diesel	2498	6	29
04/94→07/03	Omega B 2.5 TD	X 25 TD	Diesel	2498	6	29
03/94→09/00	Omega B 2.5 V6	X 25 XE	Petrol	2498	V6	31

MODEL INDEX

 Modelverzeichnis • Index de modele • Índice de Modelo
 Indeks modelu • Модель автомобиля • دليل الموديل

CCM

9

09/00→07/03	Omega B 2.6 V6	Y 26 SE	Petrol	2597	V6	36
04/94→02/01	Omega B 3.0 V6	X 30 SE	Petrol	2962	V6	45
02/01→07/03	Omega B 3.2 V6	Y 32 SE	Petrol	3175	V6	48
03/94→09/99	Omega B Estate 2.0	X 20 SE	Petrol	1998	4	45
03/94→09/99	Omega B Estate 2.0 16V	X 20 XEV	Petrol	1998	4	45
09/97→09/00	Omega B Estate 2.0 DTI 16V	X 20 DTH	Diesel	1995	4	38
09/00→07/03	Omega B Estate 2.2 DTI 16V	Y 22 DTH	Diesel	2172	4	40
04/94→07/01	Omega B Estate 2.5 TD	X 25 TD	Diesel	2498	6	29
03/94→09/00	Omega B Estate 2.5 V6	X 25 XE	Petrol	2498	V6	31
09/00→07/03	Omega B Estate 2.6 V6	Y 26 SE	Petrol	2597	V6	36
04/94→02/01	Omega B Estate 3.0 V6	X 30 XE	Petrol	2962	V6	45
02/01→07/03	Omega B Estate 3.2 V6	Y 32 SE	Petrol	3175	V6	48
08/65→12/66	Rekord B 1.9	19 S	Petrol	1897	4	57
08/65→02/67	Rekord B Coupe 1.9	19 S	Petrol	1897	4	57
08/66→12/71	Rekord C 1.9	19 S	Petrol	1897	4	57
08/67→12/71	Rekord C 1.9 Sprint	19 SH	Petrol	1897	4	57
08/66→12/71	Rekord C Coupe 1.9	19 S	Petrol	1897	4	57
08/67→12/71	Rekord C Coupe 1.9 Sprint	19 SH	Petrol	1897	4	57
08/66→12/71	Rekord C Estate 1.9	19 S	Petrol	1897	4	57
03/75→08/77	Rekord D 1.9	19 SH	Petrol	1897	4	57
01/72→02/75	Rekord D 1.9 S	19 SH	Petrol	1897	4	57
09/75→08/77	Rekord D 2.0	20 S	Petrol	1979	4	60
03/75→08/77	Rekord D Coupe 1.9	19 SH	Petrol	1897	4	57
01/72→02/75	Rekord D Coupe 1.9 S	19 SH	Petrol	1897	4	57
09/75→08/77	Rekord D Coupe 2.0	20 S	Petrol	1979	4	60
03/75→08/77	Rekord D Estate 1.9	19 SH	Petrol	1897	4	57
01/72→02/75	Rekord D Estate 1.9 S	19 SH	Petrol	1897	4	57
09/75→08/77	Rekord D Estate 2.0 S	20 S	Petrol	1979	4	60
11/82→08/86	Rekord E 1.8 S	18 S	Petrol	1796	4	41
09/77→10/82	Rekord E 2.0	20 N	Petrol	1979	4	60
09/77→10/84	Rekord E 2.0 E	20 E	Petrol	1979	4	60
08/77→08/86	Rekord E 2.0 S	20 S	Petrol	1979	4	60
08/78→08/86	Rekord E 2.2 D	23 D	Diesel	2260	4	54
11/84→08/86	Rekord E 2.2 E	22 E	Petrol	2197	4	61
11/82→08/86	Rekord E Estate 1.8 S	18 S	Petrol	1796	4	41
09/77→10/82	Rekord E Estate 2.0	20 N	Petrol	1979	4	60
09/77→10/84	Rekord E Estate 2.0 E	20 E	Petrol	1979	4	60
08/77→08/86	Rekord E Estate 2.0 S	20 S	Petrol	1979	4	60
08/78→08/83	Rekord E Estate 2.2 D	23 D	Diesel	2260	4	54
11/84→08/86	Rekord E Estate 2.2 E	22 E	Petrol	2197	4	61
11/82→08/86	Rekord E Estate 2.3 D	23 D	Diesel	2260	4	54
01/67→12/72	Rekord Sprint	19 H	Petrol	1897	4	57
01/67→12/87	Senator	25 CIH	Petrol	2490	6	46
11/84→08/87	Senator A 2.2 E	22 E	Petrol	2197	4	61
05/78→12/80	Senator A 2.5	25 S	Petrol	2490	6	46
04/78→07/82	Senator A 3.0	30 H	Petrol	2968	6	60
09/85→08/87	Senator A 3.0	C 30 LE	Petrol	2969	6	60
02/78→12/86	Senator A 3.0 E	30 E	Petrol	2969	6	60
09/90→09/93	Senator B 2.6 i	C 26 NE	Petrol	2594	6	50
01/88→09/90	Senator B 3.0	30 NE	Petrol	2968	6	60
01/88→09/90	Senator B 3.0	30 NE	Petrol	2969	6	60
09/87→09/93	Senator B 3.0	C 30 LE	Petrol	2969	6	60
09/89→09/93	Senator B 3.0 24V	C 30 SE	Petrol	2969	6	62
01/88→09/93	Senator B 3.0 i CAT	C 30 NE	Petrol	2969	6	60
05/03→	Signum 1.8	Z 18 XE	Petrol	1799	4	30
09/05→	Signum 1.8	Z 18 XER	Petrol	1796	4	30
04/04→	Signum 1.9 CDTI	Z 19 DT	Diesel	1910	4	32
04/04→	Signum 1.9 CDTI	Z 19 DTH	Diesel	1910	4	33
05/03→	Signum 2.0 DTI	Y 20 DTH	Diesel	1995	4	40
05/03→	Signum 2.2 DTI	Y 22 DTR	Diesel	2172	4	40



CCM

x



05/03→06/08	Signum 2.2 DTI 16V	Y 22 DTR	Diesel	2172	4	40
07/97→04/99	Sintra 2.2 DTI	X 22 DTH	Diesel	2172	4	40
11/96→04/99	Sintra 2.2 i 16V	X 22 XE	Petrol	2198	4	45
11/96→04/99	Sintra 3.0 i 24V	X 30 XE	Petrol	2962	V6	45
07/94→12/00	Tigra 1.4 16V	X 14 XE	Petrol	1389	4	13
07/94→08/98	Tigra 1.6 16V	X 16 XE	Petrol	1598	4	21
06/04→	Tigra TwinTop 1.3 CDTI	Z 13 DT Euro 4	Diesel	1248	4	2
06/04→	Tigra TwinTop 1.4	Z 14 XEP	Petrol	1364	4	10
06/04→	Tigra TwinTop 1.8	Z 18 XE	Petrol	1799	4	30
09/88→06/92	Vectra A 1.4 S	14 NV	Petrol	1389	4	13
09/88→05/93	Vectra A 1.6	16 SV	Petrol	1598	4	18
08/92→07/93	Vectra A 1.6	C 16 LZ2	Petrol	1598	4	18
08/92→06/94	Vectra A 1.6	E 16 NZ	Petrol	1598	4	18
09/93→11/95	Vectra A 1.6 i	16 LZ2	Petrol	1598	4	18
09/93→11/95	Vectra A 1.6 i	C 16 LZ2	Petrol	1598	4	18
09/88→11/95	Vectra A 1.6 i	C 16 NZ	Petrol	1598	4	18
09/88→11/95	Vectra A 1.6 i	E 16 NZ	Petrol	1598	4	18
09/93→11/95	Vectra A 1.6 i	X 16 SZ	Petrol	1598	4	18
10/88→09/92	Vectra A 1.7 D	17 D	Diesel	1699	4	34
07/92→11/95	Vectra A 1.7 D	17 DR	Diesel	1699	4	34
03/90→11/95	Vectra A 1.7 TD	17 DT (TC4EE1)	Diesel	1686	4	19
03/90→11/95	Vectra A 1.7 TD	X 17 DT (TC4EE1)	Diesel	1686	4	19
03/90→11/95	Vectra A 1.8 i CAT	C 18 NZ	Petrol	1796	4	41
09/89→10/90	Vectra A 1.8 S	18 SV	Petrol	1796	4	41
09/88→07/89	Vectra A 1.8 S	E 18 NVR	Petrol	1796	4	42
01/89→07/89	Vectra A 1.8 S 4x4	E 18 NVR	Petrol	1796	4	42
09/88→10/90	Vectra A 2.0 i	20 NE	Petrol	1998	4	45
09/88→09/92	Vectra A 2.0 i	20 SEH	Petrol	1998	4	45
06/94→11/95	Vectra A 2.0 i 16V	X 20 XEV	Petrol	1998	4	45
06/94→11/95	Vectra A 2.0 i 16V 4x4	X 20 XEV	Petrol	1998	4	45
01/89→10/90	Vectra A 2.0 i 4x4	20 NE	Petrol	1998	4	45
01/89→09/92	Vectra A 2.0 i 4x4	20 SEH	Petrol	1998	4	45
01/89→11/95	Vectra A 2.0 i 4x4 CAT	C 20 NE	Petrol	1998	4	45
09/88→11/95	Vectra A 2.0 i CAT	C 20 NE	Petrol	1998	4	45
06/94→11/95	Vectra A 2.0 i Turbo 4x4	C 20 LET	Petrol	1998	4	45
08/92→08/95	Vectra A 2.5 CD 4x4	C 25 XE	Petrol	2498	V6	31
02/93→11/95	Vectra A 2.5 V6	C 25 XE	Petrol	2498	V6	31
01/89→10/90	Vectra A 2000 16V 4x4	20 XEJ	Petrol	1984	4	45
01/89→06/94	Vectra A 2000/GT 16V	20 XEJ	Petrol	1984	4	45
02/90→11/95	Vectra A 2000/GT 16V 4x4 CAT	C 20 XE	Petrol	1998	4	45
02/90→11/95	Vectra A 2000/GT 16V CAT	C 20 XE	Petrol	1998	4	45
04/88→06/92	Vectra A Hatchback 1.4 S	14 NV	Petrol	1389	4	13
08/92→07/93	Vectra A Hatchback 1.6	C 16 LZ2	Petrol	1598	4	18
09/93→11/95	Vectra A Hatchback 1.6 i	16 LZ2	Petrol	1598	4	18
09/93→11/95	Vectra A Hatchback 1.6 i	X 16 SZ	Petrol	1598	4	18
09/88→11/95	Vectra A Hatchback 1.6 i CAT	C 16 NZ	Petrol	1598	4	18
09/88→05/93	Vectra A Hatchback 1.6 S	16 SV	Petrol	1598	4	18
09/88→09/92	Vectra A Hatchback 1.7 D	17 D	Diesel	1699	4	34
07/92→11/95	Vectra A Hatchback 1.7 D	17 DR	Diesel	1699	4	34
03/90→11/95	Vectra A Hatchback 1.7 TD	17 DT (TC4EE1)	Diesel	1686	4	19
03/90→11/95	Vectra A Hatchback 1.7 TD	X 17 DT (TC4EE1)	Diesel	1686	4	19
09/88→10/90	Vectra A Hatchback 1.8 i	18 SV	Petrol	1796	4	41
03/90→11/95	Vectra A Hatchback 1.8 i CAT	C 18 NZ	Petrol	1796	4	41
09/88→07/89	Vectra A Hatchback 1.8 S	E 18 NVR	Petrol	1796	4	42
09/88→10/90	Vectra A Hatchback 2.0 i	20 NE	Petrol	1998	4	45
02/89→10/90	Vectra A Hatchback 2.0 i 16V	20 XEJ	Petrol	1984	4	45
06/94→11/95	Vectra A Hatchback 2.0 i 16V	X 20 XEV	Petrol	1998	4	45
02/90→11/95	Vectra A Hatchback 2.0 i 16V CAT	C 20 XE	Petrol	1998	4	45
09/88→11/95	Vectra A Hatchback 2.0 i CAT	C 20 NE	Petrol	1998	4	45
09/88→11/95	Vectra A Hatchback 2.0 i GT	20 SEH	Petrol	1998	4	45

MODEL INDEX

Modelverzeichnis • Index de modele • Índice de Modelo
Indeks modelu • Модель автомобиля • دليل الموديل



CCM

x



9

02/93→11/95	Vectra A Hatchback 2.5 V6	C 25 XE	Petrol	2498	V6	31
09/95→08/96	Vectra B 1.6 GL	16 SV	Petrol	1598	4	18
10/95→04/02	Vectra B 1.6 i	16 LZ2	Petrol	1598	4	18
10/95→04/02	Vectra B 1.6 i	X 16 SZR	Petrol	1598	4	18
10/95→04/02	Vectra B 1.6 i 16V	X 16 XEL	Petrol	1598	4	21
10/95→04/02	Vectra B 1.6 i 16V	Y 16 XE	Petrol	1598	4	22
10/95→04/02	Vectra B 1.6 i 16V	Z 16 XE	Petrol	1598	4	22
10/95→12/98	Vectra B 1.7 TD	X 17 DT (TC4EE1)	Diesel	1686	4	19
10/95→09/00	Vectra B 1.8 i 16V	X 18 XE	Petrol	1796	4	31
10/95→09/00	Vectra B 1.8 i 16V	X 18 XE1	Petrol	1796	4	30
09/00→04/02	Vectra B 1.8 i 16V	Z 18 XE	Petrol	1799	4	30
10/95→09/00	Vectra B 1.8 i 16V	Z 18 XEL	Petrol	1796	4	30
11/96→04/02	Vectra B 2.0 DI 16V	X 20 DTL	Diesel	1896	4	39
06/97→04/02	Vectra B 2.0 DTI 16V	X 20 DTH	Diesel	1995	4	38
06/97→04/02	Vectra B 2.0 DTI 16V	Y 20 DTH	Diesel	1995	4	40
10/95→09/00	Vectra B 2.0 i 16V	C 20 SEL	Petrol	1998	4	45
10/95→09/00	Vectra B 2.0 i 16V	X 20 XEV	Petrol	1998	4	45
09/00→04/02	Vectra B 2.2 DTI 16V	Y 22 DTR	Diesel	2172	4	40
09/00→04/02	Vectra B 2.2 i 16V	C 22 SEL	Petrol	2198	4	45
10/95→09/00	Vectra B 2.5 i V6	X 25 XE	Petrol	2498	V6	31
09/00→04/02	Vectra B 2.6 i V6	Y 26 SE	Petrol	2597	V6	36
11/96→06/00	Vectra B Estate 1.6 i	16 LZ2	Petrol	1598	4	18
11/96→06/00	Vectra B Estate 1.6 i	X 16 SZR	Petrol	1598	4	18
11/96→07/02	Vectra B Estate 1.6 i 16V	X 16 XEL	Petrol	1598	4	21
11/96→07/02	Vectra B Estate 1.6 i 16V	Y 16 XE	Petrol	1598	4	22
11/96→07/02	Vectra B Estate 1.6 i 16V	Z 16 XE	Petrol	1598	4	22
11/96→12/97	Vectra B Estate 1.7 TD	X 17 DT (TC4EE1)	Diesel	1686	4	19
11/96→09/00	Vectra B Estate 1.8 i 16V	X 18 XE	Petrol	1796	4	31
11/96→09/00	Vectra B Estate 1.8 i 16V	X 18 XE1	Petrol	1796	4	30
09/00→07/03	Vectra B Estate 1.8 i 16V	Z 18 XE	Petrol	1799	4	30
11/96→09/00	Vectra B Estate 1.8 i 16V	Z 18 XEL	Petrol	1796	4	30
11/96→06/00	Vectra B Estate 2.0 DI 16V	X 20 DTL	Diesel	1896	4	39
06/97→07/03	Vectra B Estate 2.0 DTI 16V	X 20 DTH	Diesel	1995	4	38
06/97→07/03	Vectra B Estate 2.0 DTI 16V	Y 20 DTH	Diesel	1995	4	40
11/96→09/00	Vectra B Estate 2.0 i 16V	C 20 SEL	Petrol	1998	4	45
11/96→09/00	Vectra B Estate 2.0 i 16V	X 20 XEV	Petrol	1998	4	45
09/00→07/03	Vectra B Estate 2.2 DTI 16V	Y 22 DTR	Diesel	2172	4	40
09/00→07/03	Vectra B Estate 2.2 i 16V	C 22 SEL	Petrol	2198	4	45
11/96→09/00	Vectra B Estate 2.5 i V6	X 25 XE	Petrol	2498	V6	31
09/00→07/03	Vectra B Estate 2.6 i V6	Y 26 SE	Petrol	2597	V6	36
05/98→09/00	Vectra B Estate i 500 2.5	X 25 XE	Petrol	2498	V6	31
10/95→07/03	Vectra B Hatchback 1.6 i	16 LZ2	Petrol	1598	4	18
10/95→07/03	Vectra B Hatchback 1.6 i	X 16 SZR	Petrol	1598	4	18
10/95→07/02	Vectra B Hatchback 1.6 i 16V	X 16 XEL	Petrol	1598	4	21
10/95→07/02	Vectra B Hatchback 1.6 i 16V	Y 16 XE	Petrol	1598	4	22
10/95→07/02	Vectra B Hatchback 1.6 i 16V	Z 16 XE	Petrol	1598	4	22
10/95→12/98	Vectra B Hatchback 1.7 TD	X 17 DT (TC4EE1)	Diesel	1686	4	19
10/95→09/00	Vectra B Hatchback 1.8 i 16V	X 18 XE	Petrol	1796	4	31
10/95→09/00	Vectra B Hatchback 1.8 i 16V	X 18 XE1	Petrol	1796	4	30
09/00→07/03	Vectra B Hatchback 1.8 i 16V	Z 18 XE	Petrol	1799	4	30
10/95→09/00	Vectra B Hatchback 1.8 i 16V	Z 18 XEL	Petrol	1796	4	30
11/96→06/00	Vectra B Hatchback 2.0 DI 16V	X 20 DTL	Diesel	1896	4	39
06/97→07/03	Vectra B Hatchback 2.0 DTI 16V	X 20 DTH	Diesel	1995	4	38
06/97→07/03	Vectra B Hatchback 2.0 DTI 16V	Y 20 DTH	Diesel	1995	4	40
10/95→09/00	Vectra B Hatchback 2.0 i 16V	C 20 SEL	Petrol	1998	4	45
10/95→09/00	Vectra B Hatchback 2.0 i 16V	X 20 XEV	Petrol	1998	4	45
09/00→07/03	Vectra B Hatchback 2.2 DTI 16V	Y 22 DTR	Diesel	2172	4	40
09/00→07/03	Vectra B Hatchback 2.2 i 16V	C 22 SEL	Petrol	2198	4	45
10/99→06/00	Vectra B Hatchback 2.5	X 25 XE	Petrol	2498	V6	31
10/95→09/00	Vectra B Hatchback 2.5 i V6	X 25 XE	Petrol	2498	V6	31

CCM
x

09/00→07/03	Vectra B Hatchback 2.6 i V6	Y 26 SE	Petrol	2597	V6	36
05/98→09/00	Vectra B i 500 2.5	X 25 XE	Petrol	2498	V6	31
01/06→	Vectra C 1.6	Z 16 XEP	Petrol	1598	4	23
06/04→	Vectra C 1.6 16V	Z 16 XE	Petrol	1598	4	22
04/02→	Vectra C 1.8	Z 18 XEL	Petrol	1796	4	30
01/06→	Vectra C 1.8	Z 18 XER	Petrol	1796	4	30
04/02→	Vectra C 1.8 16V	Z 18 XE	Petrol	1799	4	30
04/04→	Vectra C 1.9 CDTI	Z 19 DT	Diesel	1910	4	32
04/04→	Vectra C 1.9 CDTI	Z 19 DTH	Diesel	1910	4	33
04/02→	Vectra C 2.0 DTI 16V	Y 20 DTH	Diesel	1995	4	40
04/02→	Vectra C 2.2 DTI 16V	Y 22 DTR	Diesel	2172	4	40
01/06→	Vectra C Estate 1.6	Z 16 XEP	Petrol	1598	4	23
06/04→	Vectra C Estate 1.6 16V	Z 16 XE	Petrol	1598	4	22
10/03→	Vectra C Estate 1.8	Z 18 XE	Petrol	1799	4	30
01/06→	Vectra C Estate 1.8	Z 18 XER	Petrol	1796	4	30
04/04→	Vectra C Estate 1.9 CDTI	Z 19 DT	Diesel	1910	4	32
04/04→	Vectra C Estate 1.9 CDTI	Z 19 DTH	Diesel	1910	4	33
10/05→	Vectra C Estate 1.9 CDTI	Z 19 DTL Euro 4	Diesel	1910	4	32
10/03→	Vectra C Estate 2.0 DTI	Y 20 DTH	Diesel	1995	4	40
10/03→	Vectra C Estate 2.2 DTI	Y 22 DTR	Diesel	2172	4	40
08/05→	Vectra C Gts 1.6	Z 16 XE	Petrol	1598	4	22
01/06→	Vectra C Gts 1.6	Z 16 XEP	Petrol	1598	4	23
01/06→	Vectra C Gts 1.8	Z 18 XER	Petrol	1796	4	30
08/02→	Vectra C Gts 1.8 16V	Z 18 XE	Petrol	1799	4	30
08/02→12/06	Vectra C Gts 1.8 16V	Z 18 XEL	Petrol	1796	4	30
04/04→	Vectra C Gts 1.9 CDTI	Z 19 DT	Diesel	1910	4	32
04/04→	Vectra C Gts 1.9 CDTI	Z 19 DTH	Diesel	1910	4	33
08/02→	Vectra C Gts 2.0 DTI 16V	Y 20 DTH	Diesel	1995	4	40
08/02→	Vectra C Gts 2.2 DTI 16V	Y 22 DTR	Diesel	2172	4	40
08/01→	Vivaro Box 1.9 DTI	F9Q 760	Diesel	1870	4	28
08/06→	Vivaro Box 2.0 CDTI	M9R 630	Diesel	1995	4	37
08/06→	Vivaro Box 2.0 CDTI	M9R 780 Euro 4	Diesel	1995	4	37
08/06→	Vivaro Box 2.0 CDTI	M9R 782	Diesel	1995	4	37
08/06→	Vivaro Box 2.0 CDTI	M9R 784	Diesel	1995	4	37
08/06→	Vivaro Box 2.0 CDTI	M9R 786 Euro 4	Diesel	1995	4	37
08/06→	Vivaro Box 2.0 CDTI	M9R 788	Diesel	1995	4	37
08/06→	Vivaro Box 2.5 CDTI	G9U 630 Euro 4	Diesel	2464	4	51
05/03→	Vivaro Box 2.5 DTI	G9U 730 Euro 3	Diesel	2463	4	52
08/01→	Vivaro Combi 1.9 DTI	F9Q 760	Diesel	1870	4	28
08/06→	Vivaro Combi 2.0 CDTI	M9R 780 Euro 4	Diesel	1995	4	37
08/06→	Vivaro Combi 2.0 CDTI	M9R 782	Diesel	1995	4	37
08/06→	Vivaro Combi 2.0 CDTI	M9R 784	Diesel	1995	4	37
08/06→	Vivaro Combi 2.0 CDTI	M9R 786 Euro 4	Diesel	1995	4	37
08/06→	Vivaro Combi 2.0 CDTI	M9R 788	Diesel	1995	4	37
08/06→	Vivaro Combi 2.5 CDTI	G9U 630 Euro 4	Diesel	2464	4	51
05/03→	Vivaro Combi 2.5 DTI	G9U 730 Euro 3	Diesel	2463	4	52
08/06→	Vivaro Platform/Chassis 1.9 DTI	F9Q 760	Diesel	1870	4	28
01/06→	Vivaro Platform/Chassis 2.0 CDTI	M9R 782	Diesel	1995	4	37
08/06→	Vivaro Platform/Chassis 2.0 CDTI	M9R 780 Euro 4	Diesel	1995	4	37
08/06→	Vivaro Platform/Chassis 2.5 CDTI	G9U 630 Euro 4	Diesel	2464	4	51
08/06→	Vivaro Platform/Chassis 2.5 DTI	G9U 730 Euro 3	Diesel	2463	4	52
04/99→06/05	Zafira A 1.6 16V	X 16 XEL	Petrol	1598	4	21
04/99→06/05	Zafira A 1.6 16V	Z 16 XE	Petrol	1598	4	22
04/99→09/00	Zafira A 1.8 16V	X 18 XE1	Petrol	1796	4	30
09/00→06/05	Zafira A 1.8 16V	Z 18 XE	Petrol	1799	4	30
10/99→06/05	Zafira A 2.0 DI 16V	X 20 DTL	Diesel	1896	4	39
11/03→06/05	Zafira A 2.0 DTI	Y 20 DTL	Diesel	1995	4	39
09/00→06/05	Zafira A 2.0 DTI 16V	Y 20 DTH	Diesel	1995	4	40
01/02→06/05	Zafira A 2.2 DTI 16V	Y 22 DTR	Diesel	2172	4	40
07/05→	Zafira B 1.6	Z 16 XEP	Petrol	1598	4	23

MODEL INDEX

Modelverzeichnis • Index de modele • Índice de Modelo
Indeks modelu • Модель автомобиля • دليل الموديل



CCM

x



9

01/08→	Zafira B 1.6	Z 16 XER	Petrol	1598	4	24
07/05→	Zafira B 1.8	Z 18 XER	Petrol	1796	4	30
07/05→	Zafira B 1.9 CDTI	Z 19 DT	Diesel	1910	4	32
07/05→	Zafira B 1.9 CDTI	Z 19 DTH	Diesel	1910	4	33
07/05→	Zafira B 1.9 CDTI	Z 19 DTL Euro 4	Diesel	1910	4	32
07/05→	Zafira B Van 1.8	Z 18 XER	Petrol	1796	4	30
10/11→	Zafira C 1.4	A 14 NET Euro 5	Petrol	1364	4	8
10/11→	Zafira C 1.4 LPG	A 14 NET Euro 5	Petrol	1364	4	8
01/13→	Zafira C 2.0 BiTurbo CDTI	A 20 DTR Euro 5	Diesel	1956	4	35
10/11→	Zafira C 2.0 CDTi	A 20 DT Euro 5	Diesel	1956	4	35
10/11→	Zafira C 2.0 CDTi	A 20 DTH Euro 5	Diesel	1956	4	35
10/11→	Zafira C 2.0 CDTi	A 20 DTL Euro 5	Diesel	1956	4	35
10/11→	Zafira C 2.0 CDTi	Y 20 DTJ	Diesel	1956	4	35
10/11→	Zafira C 2.0 CDTi	Z 20 DTJ	Diesel	1956	4	35

Motorverzeichnis • Index de moteur • Índice de Motor
Indeks silnika • Модель двигателя • دليل المحرك

ENGINE INDEX



CCM

x



9

10 N	Petrol	993	4	72.00	4
10 S	Petrol	993	4	72.00	4
12 N	Petrol	1196	4	79.00	17
12 NC	Petrol	1196	4	79.00	17
12 NV	Petrol	1196	4	77.80	15
12 NZ	Petrol	1195	4	72.00	5
12 S	Petrol	1196	4	79.00	17
12 SC	Petrol	1196	4	79.00	17
12 ST	Petrol	1196	4	77.80	16
13 N	Petrol	1297	4	75.00	11
13 NB	Petrol	1297	4	75.00	11
13 S	Petrol	1297	4	75.00	11
13 SB	Petrol	1297	4	75.00	11
14 NV	Petrol	1389	4	77.60	13
15 D (4EC1)	Diesel	1488	4	76.00	12
15 DT (T4EC1)	Diesel	1488	4	76.00	12
16 D	Diesel	1598	4	80.00	25
16 DA	Diesel	1598	4	80.00	25
16 LZ2	Petrol	1598	4	79.00	18
16 N	Petrol	1598	4	80.00	26
16 NZR	Petrol	1598	4	79.00	18
16 S	Petrol	1584	4	85.00	43
16 SH	Petrol	1598	4	80.00	26
16 SV	Petrol	1598	4	79.00	18
17 D	Diesel	1699	4	82.50	34
17 D (4EE1)	Diesel	1686	4	79.00	19
17 DR	Diesel	1699	4	82.50	34
17 DT (TC4EE1)	Diesel	1686	4	79.00	19
18 E	Petrol	1796	4	84.80	41
18 NV	Petrol	1796	4	84.80	42
18 S	Petrol	1796	4	84.80	41
18 SE	Petrol	1796	4	84.80	41
18 SEH	Petrol	1796	4	84.80	41
18 SV	Petrol	1796	4	84.80	41
19 H	Petrol	1897	4	93.00	57
19 S	Petrol	1897	4	93.00	57
19 SH	Petrol	1897	4	93.00	57
20 E	Petrol	1979	4	95.00	60
20 N	Petrol	1979	4	95.00	60
20 NE	Petrol	1998	4	86.00	45
20 S	Petrol	1979	4	95.00	60
20 SE	Petrol	1998	4	86.00	45
20 SEH	Petrol	1998	4	86.00	45
20 SER	Petrol	1998	4	86.00	45
20 XE	Petrol	1998	4	86.00	45
20 XEJ	Petrol	1984	4	86.00	45
22 E	Petrol	2197	4	95.00	61
23 D	Diesel	2260	4	92.00	54
23 DTR	Diesel	2260	4	92.00	55
23 YDT	Diesel	2260	4	92.00	55
25 CIH	Petrol	2490	6	87.00	46
25 H	Petrol	2490	6	87.00	46
25 S	Petrol	2490	6	87.00	46
25 TDS (VM41B)	Diesel	2500	4	92.00	56
30 E	Petrol	2969	6	95.00	60
30 H	Petrol	2968	6	95.00	60
30 NE	Petrol	2968	6	95.00	60
30 NE	Petrol	2969	6	95.00	60
A 13 DTC Euro 5 (CDTI)	Diesel	1248	4	69.60	1
A 13 DTR Euro 5	Diesel	1248	4	69.60	1

ENGINE INDEX

Motorverzeichnis • Index de moteur • Índice de Motor
 Indeks silnika • Модель двигателя • دليل المحرك

CCM
x

9

A 13 FD Euro 5 (CDTI)	Diesel	1248	4	69.60	1
A 14 FC Euro 5	Bi-fuel (Petrol/ Gas)	1368	4	72.00	6
A 14 FP Euro 5	Petrol	1368	4	72.00	7
A 14 NET Euro 5	Petrol	1364	4	72.50	8
A 16 LET Euro 5	Petrol	1598	4	79.00	20
A 20 DT Euro 5	Diesel	1956	4	83.00	35
A 20 DTC Euro 5	Diesel	1956	4	83.00	35
A 20 DTE Euro 5	Diesel	1956	4	83.00	35
A 20 DTH Euro 5	Diesel	1956	4	83.00	35
A 20 DTJ Euro 5	Diesel	1956	4	83.00	35
A 20 DTL Euro 5	Diesel	1956	4	83.00	35
A 20 DTR Euro 5	Diesel	1956	4	83.00	35
A 20 FD Euro 5	Diesel	1956	4	83.00	35
C 12 NZ	Petrol	1187	4	72.00	5
C 13 N	Petrol	1297	4	75.00	11
C 14 NZ	Petrol	1389	4	77.60	13
C 14 SE	Petrol	1389	4	77.60	13
C 14 SEL	Petrol	1389	4	77.60	13
C 16 LZ	Petrol	1598	4	79.00	18
C 16 LZ2	Petrol	1598	4	79.00	18
C 16 NZ	Petrol	1598	4	79.00	18
C 16 SE	Petrol	1598	4	79.00	18
C 16 XE	Petrol	1598	4	79.00	21
C 18 NE	Petrol	1796	4	84.80	41
C 18 NT	Petrol	1771	4	84.80	41
C 18 NZ	Petrol	1796	4	84.80	41
C 18 XE	Petrol	1796	4	81.60	31
C 18 XEL	Petrol	1796	4	81.60	31
C 20 LET	Petrol	1998	4	86.00	45
C 20 NE	Petrol	1998	4	86.00	45
C 20 SEL	Petrol	1998	4	86.00	45
C 20 XE	Petrol	1998	4	86.00	45
C 22 SEL	Petrol	2198	4	86.00	45
C 24 NE	Petrol	2410	4	95.00	62
C 25 XE	Petrol	2498	V6	81.60	31
C 26 NE	Petrol	2594	6	88.80	50
C 30 LE	Petrol	2969	6	95.00	60
C 30 NE	Petrol	2969	6	95.00	60
C 30 SE	Petrol	2969	6	95.00	62
C 30 SEJ	Petrol	2969	6	95.00	62
C 223	Diesel	2238	4	88.00	49
E 12 GV (Low compression)	Petrol	1196	4	79.00	17
E 16 LZ	Petrol	1598	4	79.00	18
E 16 NZ	Petrol	1598	4	79.00	18
E 16 SE	Petrol	1598	4	79.00	18
E 18 NV	Petrol	1796	4	84.80	42
E 18 NVR	Petrol	1796	4	84.80	42
F8Q 600	Diesel	1870	4	80.00	27
F8Q 606	Diesel	1870	4	80.00	27
F8Q-676, F8Q-714, F8Q-730, F8Q-732	Diesel	1870	4	80.00	27
F9Q 760	Diesel	1870	4	80.00	28
G9T 720	Diesel	2188	4	87.00	47
G9T 722	Diesel	2188	4	87.00	47
G9T 750	Diesel	2188	4	87.00	47
G9U 630 Euro 4	Diesel	2464	4	89.00	51
G9U 632 Euro 4	Diesel	2464	4	89.00	51
G9U 650 Euro 4	Diesel	2464	4	89.00	51
G9U 720 Euro 3	Diesel	2463	4	89.00	52



CCM

x



9

G9U 724 Euro 3	Diesel	2463	4	89.00	52
G9U 730 Euro 3	Diesel	2463	4	89.00	52
G9U 754 Euro 3	Diesel	2463	4	89.00	52
M9R 630	Diesel	1995	4	84.00	37
M9R 780 Euro 4	Diesel	1995	4	84.00	37
M9R 782	Diesel	1995	4	84.00	37
M9R 784	Diesel	1995	4	84.00	37
M9R 786 Euro 4	Diesel	1995	4	84.00	37
M9R 788	Diesel	1995	4	84.00	37
M9T 670 Euro 5	Diesel	2298	4	85.00	44
M9T 672 Euro 5	Diesel	2298	4	85.00	44
M9T 676 Euro 4	Diesel	2298	4	85.00	44
M9T 678	Diesel	2298	4	85.00	44
M9T 680	Diesel	2298	4	85.00	44
M9T 686 Euro 5	Diesel	2298	4	85.00	44
M9T 690 Euro 5	Diesel	2298	4	85.00	44
M9T 692 Euro 4	Diesel	2298	4	85.00	44
M9T 694 Euro 4	Diesel	2298	4	85.00	44
M9T 696 Euro 4	Diesel	2298	4	85.00	44
M9T 698 Euro 5	Diesel	2298	4	85.00	44
S 18 NV	Petrol	1796	4	84.80	42
S8U 758	Diesel	2499	4	93.00	58
S8U 780	Diesel	2499	4	93.00	58
S9W 700	Diesel	2799	4	94.40	59
S9W 702	Diesel	2799	4	94.40	59
U 25TD	Diesel	2498	6	80.00	29
X 10 XE	Petrol	973	3	72.50	9
X 12 SZ	Petrol	1195	4	72.00	5
X 12 XE	Petrol	1199	4	72.50	9
X 14 NZ	Petrol	1389	4	77.60	13
X 14 SZ	Petrol	1389	4	77.60	13
X 14 XE	Petrol	1389	4	77.60	13
X 15 DT (T4EC1)	Diesel	1488	4	76.00	12
X 16 SZ	Petrol	1598	4	79.00	18
X 16 SZR	Petrol	1598	4	79.00	18
X 16 XE	Petrol	1598	4	79.00	21
X 16 XEL	Petrol	1598	4	79.00	21
X 17 D (4EE1)	Diesel	1686	4	79.00	19
X 17 DT (TC4EE1)	Diesel	1686	4	79.00	19
X 17 DTL	Diesel	1699	4	82.50	34
X 18 XE	Petrol	1796	4	81.60	31
X 18 XE1	Petrol	1796	4	80.50	30
X 20 DTH	Diesel	1995	4	84.00	38
X 20 DTL	Diesel	1896	4	84.00	39
X 20 SE	Petrol	1998	4	86.00	45
X 20 XEV	Petrol	1998	4	86.00	45
X 22 DTH	Diesel	2172	4	84.00	40
X 22 SE	Petrol	2198	4	86.00	45
X 22 XE	Petrol	2198	4	86.00	45
X 25 TD	Diesel	2498	6	80.00	29
X 25 XE	Petrol	2498	V6	81.60	31
X 30 XE	Petrol	2962	V6	86.00	45
XDP 90	Diesel	2112	4	90.00	53
Y 13 DT Euro 3/4	Diesel	1248	4	69.60	2
Y 16 XE	Petrol	1598	4	79.00	22
Y 17 DT	Diesel	1686	4	79.00	19
Y 17 DTL	Diesel	1686	4	79.00	19
Y 20 DTH	Diesel	1995	4	84.00	40
Y 20 DTJ	Diesel	1956	4	83.00	35
Y 20 DTL	Diesel	1995	4	84.00	39

ENGINE INDEX

Motorverzeichnis • Index de moteur • Índice de Motor
Indeks silnika • Модель двигателя • دليل المحرك





CCM



9

		CCM	x		
Y 22 DTH	Diesel	2172	4	84.00	40
Y 22 DTR	Diesel	2172	4	84.00	40
Y 26 SE	Petrol	2597	V6	83.20	36
Y 32 SE	Petrol	3175	V6	87.50	48
Z 10 XE	Petrol	973	3	72.50	9
Z 10 XEP	Petrol	998	3	73.40	10
Z 12 XE	Petrol	1199	4	72.50	9
Z 12 XEP	Petrol	1229	4	73.40	10
Z 13 DT Euro 4	Diesel	1248	4	69.60	2
Z 13 DTH	Diesel	1248	4	69.60	3
Z 13 DTJ	Diesel	1248	4	69.60	3
Z 14 XE	Petrol	1389	4	77.60	14
Z 14 XEP	Petrol	1364	4	73.40	10
Z 16 SE	Petrol	1598	4	79.00	22
Z 16 XE	Petrol	1598	4	79.00	22
Z 16 XEP	Petrol	1598	4	79.00	23
Z 16 XER	Petrol	1598	4	79.00	24
Z 17 DTH	Diesel	1686	4	79.00	19
Z 17 DTL	Diesel	1686	4	79.00	19
Z 18 XE	Petrol	1799	4	80.50	30
Z 18 XEL	Petrol	1796	4	80.50	30
Z 18 XER	Petrol	1796	4	80.50	30
Z 19 DT	Diesel	1910	4	82.00	32
Z 19 DTH	Diesel	1910	4	82.00	33
Z 19 DTJ	Diesel	1910	4	82.00	33
Z 19 DTL Euro 4	Diesel	1910	4	82.00	32
Z 20 DTJ	Diesel	1956	4	83.00	35

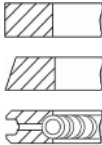

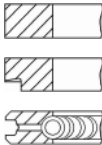
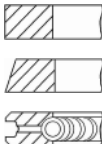
Corsa D 1.3 CDTI, Corsa D Van 1.3 CDTI Meriva B 1.3 CDTI		07/06→ 06/10→	A 13 DTC Euro 5 (CDTI) 4cyl. 1248cc 55kW (75PS) Diesel Turbo Intercooled		1
					TD24265
Corsa D 1.3 CDTI, Corsa D Van 1.3 CDTI		06/10→	A 13 DTR Euro 5 4cyl. 1248cc 70kW (95PS) Diesel Turbo Intercooled		TD24378
Combo Box Body / Estate 1.3 CDTI, Combo Tour 1.3 CDTI		02/12→	A 13 FD Euro 5 (CDTI) 4cyl. 1248cc 66kW (89PS) Diesel Turbo Intercooled		TD26182
08-435700-00 08-435706-00	STD 0.40mm	69.60	1.500 1.500 2.000	 001 GDC P 005 P 231 LKZ CR P	KV4 F12/F14 GOE13
					
Combo Tour 1.3 CDTI 16V Meriva 1.3 CDTI		10/04→ 04/05→05/10	Y 13 DT Euro 3/4 4cyl. 1248cc 51kW (69PS) Diesel Turbo Intercooled		2
					TD20084
Agila 1.3 CDTI Combo Box Body / Estate 1.3 CDTI 16V Combo Tour 1.3 CDTI 16V Corsa C 1.3 CDTI Corsa C Box 1.3 CDTI 16V Meriva 1.3 CDTI Tigra TwinTop 1.3 CDTI		08/03→12/07 08/05→ 10/04→ 06/03→12/09 08/05→ 04/05→05/10 06/04→	Z 13 DT Euro 4 4cyl. 1248cc 51kW (69PS) Diesel Turbo Intercooled		TD17477
08-137600-00 08-137606-00	STD 0.40mm	69.60	2.000 1.500 2.000	 001 CK P 023 P 231 P	KV1 F12/F14 F12/F14
<i>[R66830]</i>					
Astra H 1.3 CDTI, Astra H Estate 1.3 CDTI Astra H GTC 1.3 CDTI Astra H Saloon 1.3 CDTi Astra H Van 1.3 CDTI Corsa D 1.3 CDTI, Corsa D Van 1.3 CDTI		08/05→ 04/05→ 02/07→ 08/05→ 07/06→	Z 13 DTH 4cyl. 1248cc 66-74kW (90-101PS) Diesel Turbo Intercooled		3
					TD18653
Agila 1.3 CDTI Combo Box Body / Estate 1.3 CDTI 16V, Combo Tour 1.3 CDTI 16V Corsa D 1.3 CDTI, Corsa D Van 1.3 CDTI Meriva 1.3 CDTI		04/08→ 10/05→ 07/06→ 09/03→05/10	Z 13 DTJ 4cyl. 1248cc 55kW (75PS) Diesel		TD18989
08-425600-00 08-425606-00 08-425608-00	STD 0.40mm 0.60mm	69.60	2.000 1.500 2.000	 001 CK P 005 NT 231 CR P	KV4 F12/F14 GOE13



Kadett A 1.0	09/62→08/65	10 N						4
Kadett A Estate 1.0 N	03/63→08/65		4cyl.					
Kadett C 1.0	01/74→07/79		993cc	29kW (39PS)				
Kadett C City 1.0	05/75→07/79							
Kadett C Coupe 1.0, Kadett C Estate 1.0	01/74→07/79							
Kadett D 1.0	09/79→08/82							TD2576

Corsa A Box 1.0	02/86→04/89	10 S						
Corsa A Hatchback 1.0	09/82→03/93		4cyl.					
Corsa A TR 1.0	09/82→09/92		993cc	33-35kW (45-48PS)				
Kadett A 1.0 S	09/62→08/65							
Kadett A Coupe 1.0 S	10/63→08/65							
Kadett A Estate 1.0 S	03/63→08/65							
Kadett D 1.0	08/79→08/84							TD2578

08-302200-00	STD	72.00	2.000		001 IF CR P	STD
08-302207-00	0.50mm		2.000		026 P	STD
[R40240]			5.000		236 P	STD

Corsa B 1.2 i	03/93→09/00	12 NZ					5
			4cyl.				
			1195cc	33kW (45PS)			
							TD4719

Combo 1.2	07/94→10/01	C 12 NZ					
Corsa A Hatchback 1.2 i, Corsa A TR 1.2 i	09/89→03/93		4cyl.				
Corsa B 1.2 i	03/93→09/00		1187cc	33kW (45PS)			
							TD4780

Combo 1.2	07/94→10/01	X 12 SZ					
Corsa B 1.2 i	03/93→09/00		4cyl.				
			1195cc	33kW (45PS)			
							TD2732

08-307500-00	STD	72.00	1.500		001 CR P	IKA
08-307507-00	0.50mm		1.500		026 P	STD
[R49590]			3.000		712 CR	ST

Combo Box Body / Estate 1.4,	02/12→	A 14 FC Euro 5					6
Combo Box Body / Estate 1.4 CNG,			4cyl.				
Combo Tour 1.4, Combo Tour 1.4 CNG			1368cc	88kW (120PS)			
				Turbo Intercooled			TD26181

08-438300-00	STD	72.00	1.200		021 GDC P	KV1
08-438306-00	0.40mm		1.200		026 P	GOE13
			2.000		231 LKZ CR P	GOE13

Combo Box Body / Estate 1.4,	02/12→	A 14 FP Euro 5					7
Combo Tour 1.4			4cyl.				
			1368cc	70kW (95PS)			
							TD26180

08-433200-00	STD	72.00	1.000		001 IF NT	ST
08-433206-00	0.40mm		1.200		005 IF P	GOE13
			2.000		231 P	GOE13



Astra GTC J 1.4	10/11→	A 14 NET Euro 5	8
Astra J 1.4 LPG	01/12→	4cyl.	
Astra J 1.4 Turbo	12/09→	1364cc 103kW (140PS)	
Astra J Saloon 1.4 Turbo	06/12→	Turbo Intercooled	
Astra Sports Tourer 1.4 LPG	01/12→		
Astra Sports Tourer 1.4 Turbo	10/10→		
Cascada 1.4 Turbo	03/13→		
Insignia 1.4	04/11→		
Insignia 1.4 LPG	07/12→		
Insignia Saloon 1.4	04/11→		
Insignia Saloon 1.4 LPG	07/12→		
Insignia Sports Tourer 1.4	09/11→		
Insignia Sports Tourer 1.4 LPG	07/12→		
Meriva B 1.4	06/10→		
Mokka 1.4	04/13→		
Mokka 1.4 4x4	06/12→		
Zafira C 1.4, Zafira C 1.4 LPG	10/11→		TD23882

08-437400-00	STD	72.50	1.200		001 NT DLC	ST
			1.200		026 P	GOE13
			2.000		712 NT	ST
CARBOGLIDE®						

Corsa B 1.0 i 12V	11/96→09/00	X 10 XE	9
		3cyl. 973cc 40kW (54PS)	
			TD5512

Astra F ClassIC Hatchback 1.2 i	03/98→08/00	X 12 XE	TD9508
Astra G Estate 1.2 16V,	02/98→09/00	4cyl. 1199cc 48kW (65PS)	
Astra G Hatchback 1.2 16V			
Astra G Saloon 1.2 16V	09/98→09/00		
Astra H 1.2, Astra H GTC 1.2	10/06→		
Corsa B 1.2 i 16V	03/98→09/00		

Agila 1.0 12V	09/00→12/07	Z 10 XE	TD14008
Corsa C 1.0	09/00→12/09	3cyl. 973cc 43kW (58PS)	

Agila 1.2 16V	09/00→12/07	Z 12 XE	TD14009
Astra G Estate 1.2 16V	09/00→07/04	4cyl. 1199cc 55kW (75PS)	
Astra G Hatchback 1.2 16V,	09/00→01/05		
Astra G Saloon 1.2 16V			
Corsa C 1.2	09/00→12/09		
Corsa C Box 1.2 16V	09/00→		



08-102700-00	STD	72.50	1.200		001 NT	ST	
			[R49990]	1.500		005 P	STD
				2.000		712 CR	ST



Agila 1.0	08/03→12/07	Z 10 XEP				10
Astra G Hatchback 1.0	08/03→05/04		3cyl.			
Corsa C 1.0	06/03→12/09		998cc	44kW (60PS)		
Corsa D 1.0	07/06→				TD17475	

Agila 1.2 16V Twinport	07/04→12/07	Z 12 XEP				TD18012
Astra H 1.2, Astra H GTC 1.2	08/05→		4cyl.			
Corsa C 1.2 Twinport	07/04→12/09		1229cc	59kW (80PS)		
Corsa C Box 1.2	07/05→					
Corsa D 1.2	07/06→					
Corsa D 1.2 LPG	09/09→					
Corsa D Van 1.2	07/09→					

Astra G Estate 1.4,	09/07→12/09	Z 14 XEP				TD17476
Astra G Hatchback 1.4, Astra G Saloon 1.4			4cyl.			
Astra H 1.4	03/04→		1364cc	66kW (89PS)		
Astra H 1.4 LPG	08/09→					
Astra H Estate 1.4	08/04→					
Astra H Estate 1.4 LPG	08/09→					
Astra H GTC 1.4	03/05→					
Combo Box Body / Estate 1.4 16V	08/05→					
Combo Tour 1.4	10/04→					
Corsa C 1.4 Twinport	06/03→12/09					
Corsa C Box 1.4	08/03→					
Corsa D 1.4, Corsa D 1.4 LPG	07/06→					
Meriva 1.4 16V Twinport,	07/04→05/10					
Meriva 1.4 16V Twinport LPG						
Tigra TwinTop 1.4	06/04→					

08-429500-00	STD	73.40	1.200		001 NT	ST
08-429507-00	0.50mm		1.200		026 P	F12/F14
			2.000		712 CR	ST

Ascona B 1.3 N	03/79→08/81	13 N				11
Ascona C 1.3 N, Ascona C Hatchback 1.3 N	09/81→08/86		4cyl.			
Kadett D 1.3 N, Kadett D Estate 1.3 N	08/79→08/84		1297cc	39-44kW (53-60PS)		
Kadett E 1.3 N	09/84→08/89					
Kadett E Box 1.3 N	09/84→07/89					
Kadett E Combo 1.3 N	01/86→12/89					
Kadett E Estate 1.3 N,	09/84→08/91					
Kadett E Hatchback 1.3 N						
Manta B 1.3 N, Manta B Cc 1.3 N	03/79→12/80				TD4723	

Corsa A Box 1.3	02/86→04/89	13 NB				TD4724
Corsa A Hatchback 1.3	09/85→10/89		4cyl.			
Corsa A TR 1.3	09/85→10/87		1297cc	44kW (60PS)		
Kadett E 1.3 N	09/84→08/89					
Kadett E Box 1.3 N	09/84→07/89					
Kadett E Hatchback 1.3 N	09/84→08/91					

Ascona B 1.3 S	08/79→08/81	13 S				TD4725
Ascona C 1.3 S, Ascona C Hatchback 1.3 S	09/81→08/88		4cyl.			
Corsa A Hatchback 1.3 GL,	09/82→03/93		1297cc	42-55kW (57-75PS)		
Corsa A TR 1.3 GL						
Kadett D 1.3 S, Kadett D Estate 1.3 S	08/79→08/84					
Kadett E 1.3 S	09/84→08/87					
Kadett E Combo 1.3 S	01/86→12/89					
Kadett E Convertible 1.3 S	03/87→02/93					
Kadett E Estate 1.3	01/85→12/87					
Kadett E Estate 1.3 S	09/84→08/87					
Kadett E Hatchback 1.3	01/85→12/87					
Kadett E Hatchback 1.3 S	09/84→08/87					
Manta B 1.3 S	08/81→08/86					
Manta B Cc 1.3 S	08/79→08/86					





Corsa A Box 1.3	02/86→04/89	13 SB			
Corsa A Hatchback 1.3 S	09/82→10/89		4cyl.		
Corsa A TR 1.3 S	09/82→10/87		1297cc	51kW (69PS)	
					TD4726

Corsa A Hatchback 1.3 i	09/86→09/90	C 13 N			
Corsa A TR 1.3	09/85→10/87		4cyl.		
Kadett D 1.3 N	08/79→08/84		1297cc	44kW (60PS)	
Kadett E 1.3 i CAT,	09/85→08/91				
Kadett E Estate 1.3 i CAT,					
Kadett E Hatchback 1.3 i CAT					
					TD4781

08-305500-00	STD	75.00	1.750		001 IF CR P	IKA
08-305507-00	0.50mm		2.000		026 P	STD
→eng.M.13N1225588			4.000		712 CR	ST
[R33516]						
08-306300-00	STD	75.00	1.500		001 IF CR P	IKA
08-306307-00	0.50mm		1.500		005 IF P	STD
08-306311-00	1.00mm		4.000		231 CR P	STD
eng.M.13N1225589→						
[R41270]						

Corsa A Box 1.5 D	06/87→04/89	15 D (4EC1)			
Corsa A Hatchback 1.5 D	09/87→03/93		4cyl.		
Corsa A TR 1.5 D	10/87→11/92		1488cc	37kW (50PS)	
Corsa B 1.5 D	03/93→09/00	Diesel			
					TD4732

12

Corsa A Hatchback 1.5 TD	03/88→03/93	15 DT (T4EC1)			
Corsa A TR 1.5 TD	10/87→03/93		4cyl.		
Corsa B 1.5 TD	03/93→09/00		1488cc	49-53kW (67-72PS)	
Kadett E 1.5 TD, Kadett E Estate 1.5 TD,	07/88→08/91	Diesel	Turbo		
Kadett E Hatchback 1.5 TD					
					TD4733

Corsa B 1.5 TD	03/93→09/00	X 15 DT (T4EC1)			
			4cyl.		
			1488cc	49kW (67PS)	
		Diesel	Turbo		
					TD5301

08-307000-00	STD	76.00	2.000		001 CR P	KV1
08-307007-00	0.50mm		1.500		005 P	STD
08-307011-00	1.00mm		3.000		231 CR P	STD
[R43910]						

Astra F 1.4, Astra F Estate 1.4,	09/91→09/93	14 NV			
Astra F Hatchback 1.4			4cyl.		
Corsa A Hatchback 1.4 S	01/90→03/93		1389cc	53-55kW (72-75PS)	
Corsa A TR 1.4 S	09/89→03/93				
Kadett E 1.4 S	01/90→08/91				
Kadett E Combo 1.4 S	07/89→08/91				
Kadett E Convertible 1.4 S	08/90→02/93				
Kadett E Estate 1.4 S,	01/90→08/91				
Kadett E Hatchback 1.4 S					
Vectra A 1.4 S	09/88→06/92				
Vectra A Hatchback 1.4 S	04/88→06/92				
					TD4728

13





Astra F 1.4 i		09/91→09/98	C 14 NZ			
Astra F Estate 1.4 i		09/91→01/98		4cyl.		
Astra F Hatchback 1.4 i		03/92→01/98		1389cc	44kW (60PS)	
Astra F Van 1.4 i		10/91→01/99				
Combo 1.4		07/94→10/01				
Corsa A Hatchback 1.4 i		01/85→03/93				
Corsa A TR 1.4 i		10/89→03/93				
Corsa B 1.4 i		03/93→09/00				
Kadett E 1.4 i, Kadett E Box 1.4 i		01/90→08/91				
Kadett E Combo 1.4 i		08/91→07/94				
Kadett E Convertible 1.4 i,		01/90→08/91				
Kadett E Estate 1.4 i,						
Kadett E Hatchback 1.4 i						TD4782
Astra F 1.4 Si		03/92→09/98	C 14 SE			
Astra F Convertible 1.4 Si		05/93→03/01		4cyl.		
Astra F Estate 1.4 Si,		03/92→01/98		1389cc	60kW (81PS)	
Astra F Hatchback 1.4 Si						
Combo 1.4		07/94→10/01				
Corsa A Hatchback 1.4 Si		09/91→03/93				
Corsa B 1.4		04/93→08/94				
Corsa B 1.4 Si		03/93→09/00				
Kadett E Hatchback 1.4 S		09/89→08/91				TD4783
Corsa B 1.4 i 16V		08/97→09/00	C 14 SEL			
				4cyl.		
				1389cc	63kW (86PS)	
						TD16393
Astra F 1.4 i		09/91→09/98	X 14 NZ			
Astra F Classic Estate 1.4 i		01/98→01/05		4cyl.		
Astra F Classic Hatchback 1.4 i,		01/98→08/02		1389cc	44kW (60PS)	
Astra F Classic Saloon 1.4 i						TD14828
Combo 1.4		07/94→10/01	X 14 SZ			
Corsa B 1.4 i		03/93→09/00		4cyl.		
Corsa B Box 1.4 i		08/99→09/00		1389cc	40-44kW (54-60PS)	
						TD8405
Astra F 1.4 i 16V		02/96→09/98	X 14 XE			
Astra F Classic Hatchback 1.4 i		03/98→08/00		4cyl.		
Astra F Convertible 1.4 i 16V		01/96→03/01		1389cc	66kW (89PS)	
Astra F Estate 1.4 i 16V		02/96→01/98				
Astra F Hatchback 1.4 i 16V		01/96→01/98				
Astra G Estate 1.4 16V		06/98→07/04				
Astra G Hatchback 1.4 16V		02/98→01/05				
Astra G Saloon 1.4 16V		09/98→01/05				
Combo 1.4 16V		08/99→10/01				
Corsa B 1.4 i 16V		09/94→09/00				
Corsa B Estate 1.4 i 16V		01/99→				
Tigra 1.4 16V		07/94→12/00				TD2733
08-307100-00	STD	77.60	1.500		001 IF CR P	KV1
08-307107-00	0.50mm		1.500		026 P	STD
[R43740]			3.000		712 CR	ST



Astra G Estate 1.4 16V	06/98→07/04	Z 14 XE							
Astra G Hatchback 1.4 16V	02/98→01/05				4cyl.				14
Astra G Saloon 1.4 16V	09/98→01/05				1389cc	66kW (89PS)			
Corsa C 1.4	09/00→12/09								TD14920

08-144200-00	STD	77.60	1.200		001 NT		ST
08-144207-00	0.50mm		1.500		005 P		GOE12
			2.000		712 CR		ST

Corsa A Hatchback 1.2 N	01/90→03/93	12 NV							
					4cyl.				15
					1196cc	38kW (52PS)			
									TD4718

08-306400-00	STD	77.80	1.500		001 IF CR P		IKA
[R40250]			1.500		005 IF P		STD
			4.000		712 CR		ST

Corsa A Box 1.2	02/86→04/89	12 ST							
Corsa A Hatchback 1.2 S	09/82→02/90				4cyl.				16
Corsa A TR 1.2 S	09/82→03/93				1196cc	40-43kW (55-58PS)			
Kadett D 1.2	08/82→08/84								TD4722

08-306200-00	STD	77.80	1.750		001 IF CR P		IKA
→eng.12ST19136602			2.000		026 P		STD
[R40260]			4.000		712 CR		ST
08-306400-00	STD	77.80	1.500		001 IF CR P		IKA
eng.12ST19136603→			1.500		005 IF P		STD
[R40250]			4.000		712 CR		ST

Ascona B 1.2	08/76→02/79	12 N							
Kadett C 1.2	08/73→07/79				4cyl.				17
Kadett C City 1.2	05/75→07/79				1196cc	38-40kW (52-55PS)			
Kadett C Coupe 1.2, Kadett C Estate 1.2	08/73→07/79								
Kadett D 1.2, Kadett D Estate 1.2	08/79→07/82								
Manta B 1.2 N	08/76→07/83								TD2583

Corsa A Box 1.2	02/86→04/89	12 NC							
Corsa A Hatchback 1.2	09/82→08/90				4cyl.				
Corsa A TR 1.2 N	01/85→10/87				1196cc	33kW (45PS)			
									TD4717

Ascona A 1.2 S	04/72→08/75	12 S							
Ascona B 1.2 S	09/75→02/79				4cyl.				
Corsa A Box 1.2	02/86→07/90				1196cc	40-44kW (54-60PS)			
Corsa A Hatchback 1.2	09/82→08/90								
Corsa A TR 1.2 S	09/82→10/87								
Kadett B 1.2 S, Kadett B Coupe 1.2,	08/71→08/73								
Kadett B Estate 1.2									
Kadett C 1.2 S, Kadett C City 1.2 S,	08/73→07/79								
Kadett C Coupe 1.2 S,									
Kadett C Estate 1.2 S									
Kadett D 1.2 S, Kadett D Estate 1.2 S	08/79→08/84								
Manta A 1.2	04/72→08/75								
Manta B 1.2 S	09/75→02/79								TD4720





Kadett E 1.2, Kadett E Box 1.2, Kadett E Estate 1.2, Kadett E Hatchback 1.2		09/84→07/86	12 SC	4cyl. 1196cc	40kW (54PS)	TD4721
Corsa A Box 1.2 Corsa A Hatchback 1.2 Corsa A TR 1.2 N		02/86→04/89 09/82→08/90 01/85→10/87	E 12 GV (Low compression)	4cyl. 1196cc	33kW (45PS)	TD4809
08-304200-00	STD	79.00	2.000		001 CR P	STD
08-304207-00	0.50mm		2.000		026 P	GOE12
08-304211-00	1.00mm		5.000		236 P	STD
[R33294K]						
Astra F 1.6 Astra F Estate 1.6, Astra F Hatchback 1.6 Vectra A 1.6 i, Vectra A Hatchback 1.6 i Vectra B 1.6 i Vectra B Estate 1.6 i Vectra B Hatchback 1.6 i		09/95→09/98 09/95→01/98 09/93→11/95 10/95→04/02 11/96→06/00 10/95→07/03	16 LZ2	4cyl. 1598cc	55kW (75PS)	18 TD4736
Astra F 1.6 Astra F Estate 1.6, Astra F Hatchback 1.6		09/95→09/98 09/95→01/98	16 NZR	4cyl. 1598cc	55kW (75PS)	TD16169
Ascona C 1.6, Ascona C Hatchback 1.6 Kadett E 1.6 S Kadett E Combo 1.6 Kadett E Convertible 1.6 i Kadett E Estate 1.6, Kadett E Hatchback 1.6 S Vectra A 1.6, Vectra A Hatchback 1.6 S Vectra B 1.6 GL		09/86→08/88 09/86→08/91 09/86→12/91 07/89→02/93 09/86→08/91 09/88→05/93 09/95→08/96	16 SV	4cyl. 1598cc	60kW (81PS)	TD4740
Ascona C 1.6 i CAT, Ascona C Hatchback 1.6 i CAT Kadett E 1.6 i CAT Kadett E Convertible 1.6 i CAT Kadett E Estate 1.6 i CAT, Kadett E Hatchback 1.6 i CAT		09/86→08/88 09/86→08/91 10/87→02/93 09/86→08/91	C 16 LZ	4cyl. 1598cc	55kW (75PS)	TD4784
Vectra A 1.6 Vectra A 1.6 i Vectra A Hatchback 1.6		08/92→07/93 09/93→11/95 08/92→07/93	C 16 LZ2	4cyl. 1598cc	51-55kW (69-75PS)	TD21179
Ascona C 1.6 i CAT, Ascona C Hatchback 1.6 i CAT Astra F 1.6 i Astra F Estate 1.6 i, Astra F Hatchback 1.6 i Astra F Van 1.6 i Corsa A Hatchback 1.6 GSI Kadett E 1.6 i CAT Kadett E Box 1.6 i Kadett E Combo 1.6 i Kadett E Convertible 1.6 i CAT Kadett E Estate 1.6 i CAT, Kadett E Hatchback 1.6 i CAT Vectra A 1.6 i, Vectra A Hatchback 1.6 i CAT		09/86→08/88 03/92→09/98 09/91→01/98 10/91→04/93 08/88→09/92 09/86→08/91 08/89→09/93 08/91→07/94 10/87→02/93 09/86→08/91	C 16 NZ	4cyl. 1598cc	55kW (75PS)	TD4785





Astra F 1.6 Si	05/92→12/94	C 16 SE	4cyl.	1598cc	74kW (100PS)				
Astra F Estate 1.6 Si,	03/92→12/94								
Astra F Hatchback 1.6 Si									
Corsa A Hatchback 1.6 GSI CAT	02/92→03/93								TD4787
Ascona C 1.6 i	09/87→08/88	E 16 LZ	4cyl.	1598cc	55kW (75PS)				TD25784
Ascona C 1.6 i, Ascona C Hatchback 1.6 i	09/87→08/88	E 16 NZ	4cyl.	1598cc	55kW (75PS)				
Kadett E 1.6 i	09/86→08/91								
Kadett E Convertible 1.6 i	10/86→02/93								
Kadett E Estate 1.6 i,	09/86→08/91								
Kadett E Hatchback 1.6 i									
Vectra A 1.6	08/92→06/94								
Vectra A 1.6 i	09/88→11/95								TD4810
Corsa A Hatchback 1.6 GSI	05/88→03/92	E 16 SE	4cyl.	1598cc	74kW (100PS)				
Kadett E 1.6	09/87→08/91								TD4811
Astra F 1.6 i	05/93→07/96	X 16 SZ	4cyl.	1598cc	52kW (71PS)				
Astra F Convertible 1.6 i	03/93→08/96								
Astra F Estate 1.6 i,	05/93→07/96								
Astra F Hatchback 1.6 i									
Astra F Van 1.6 i	02/93→07/96								
Vectra A 1.6 i, Vectra A Hatchback 1.6 i	09/93→11/95								TD2734
Astra F 1.6 i	03/92→09/98	X 16 SZR	4cyl.	1598cc	55kW (75PS)				
Astra F ClassiC Estate 1.6 i	01/98→01/05								
Astra F ClassiC Hatchback 1.6 i,	01/98→08/02								
Astra F ClassiC Saloon 1.6 i									
Astra F Convertible 1.6 i	01/96→03/01								
Astra F Estate 1.6 i,	09/91→01/98								
Astra F Hatchback 1.6 i									
Astra G Box 1.6	01/99→09/00								
Astra G Estate 1.6, Astra G Hatchback 1.6	02/98→09/00								
Astra G Saloon 1.6	09/98→09/00								
Vectra B 1.6 i	10/95→04/02								
Vectra B Estate 1.6 i	11/96→06/00								
Vectra B Hatchback 1.6 i	10/95→07/03								TD4819
08-306900-00	STD	79.00	1.200		001 CR				ST
08-306907-00	0.50mm				026 P				STD
[R43150]			3.000		712 CR				ST
Combo 1.7 D	07/94→10/01	17 D (4EE1)	4cyl.	1686cc	44kW (60PS)				19
Corsa B 1.7 D	02/96→09/00								
Corsa B Box 1.7 D	08/99→09/00								TD5284
		Diesel							
Astra F 1.7 TDS	03/92→09/98	17 DT (TC4EE1)	4cyl.	1686cc	60kW (81PS)				
Astra F Estate 1.7 TDS,	12/91→01/98								
Astra F Hatchback 1.7 TDS									
Vectra A 1.7 TD,	03/90→11/95	Diesel	Turbo						
Vectra A Hatchback 1.7 TD									TD4747
Combo 1.7 D	07/94→10/01	X 17 D (4EE1)	4cyl.	1686cc	44kW (60PS)				
Corsa B 1.7 D	02/96→09/00								
Corsa B Box 1.7 D	08/99→09/00								
Corsa B Estate 1.7 D	01/99→	Diesel							TD5298





Astra F 1.7 TDS	03/92→09/98	X 17 DT (TC4EE1)	
Astra F Estate 1.7 TDS,	12/91→01/98	4cyl.	
Astra F Hatchback 1.7 TDS		1686cc 60kW (81PS)	
Astra F Van 1.7 TD	03/95→02/98	Diesel Turbo Intercooled	
Vectra A 1.7 TD,	03/90→11/95		
Vectra A Hatchback 1.7 TD			
Vectra B 1.7 TD	10/95→12/98		
Vectra B Estate 1.7 TD	11/96→12/97		
Vectra B Hatchback 1.7 TD	10/95→12/98		TD4822

Astra G Estate 1.7 DTI 16V	02/00→07/04	Y 17 DT	
Astra G Hatchback 1.7 DTI 16V,	02/00→01/05	4cyl.	
Astra G Saloon 1.7 DTI 16V		1686cc 55kW (75PS)	
Combo Box Body / Estate 1.7 DTI 16V,	10/01→	Diesel Turbo Intercooled	
Combo Tour 1.7 DTI 16V			
Corsa C 1.7 DTI	09/00→12/09		
Corsa C Box 1.7 DTI 16V	09/00→		
Meriva 1.7 DTI	09/03→05/10		TD13689

Combo Box Body / Estate 1.7 DI 16V,	10/01→	Y 17 DTL	
Combo Tour 1.7 DI 16V		4cyl.	
Corsa C 1.7 DI	09/00→12/09	1686cc 48kW (65PS)	
Corsa C Box 1.7 DI 16V	09/00→	Diesel Turbo Intercooled	
Meriva 1.7 DTI	09/03→05/10		TD14921

Astra H 1.7 CDTI	03/04→	Z 17 DTH	
Astra H Estate 1.7 CDTI	08/04→	4cyl.	
Astra H GTC 1.7 CDTI	03/05→	1686cc 74kW (100PS)	
Astra H Saloon 1.7 CDTI	02/07→	Diesel Turbo Intercooled	
Astra H Van 1.7 CDTI	03/04→		
Combo Box Body / Estate 1.7 CDTI 16V,	12/04→		
Combo Tour 1.7 CDTI 16V			
Corsa C 1.7 CDTI	06/03→12/09		
Corsa C Box 1.7 CDTI	08/03→		
Meriva 1.7 CDTI	09/03→05/10		TD17478

Astra G Estate 1.7 CDTI	04/03→07/09	Z 17 DTL	
Astra G Hatchback 1.7 CDTI,	04/03→01/05	4cyl.	
Astra G Saloon 1.7 CDTI		1686cc 59kW (80PS)	
Astra H 1.7 CDTI	03/04→	Diesel Turbo Intercooled	
Astra H Estate 1.7 CDTI	08/04→		
Astra H GTC 1.7 CDTI	03/05→		TD17947

08-307600-00	STD	79.00	2.000		001 CR P	KV1
08-307607-00	0.50mm		1.500		005 CR P	STD
[R48400]			3.000		231 CR P	STD

Astra GTC J 1.6	10/11→	A 16 LET Euro 5	
Astra J 1.6 Turbo	12/09→	4cyl.	
Astra J Saloon 1.6 Turbo	06/12→	1598cc 132kW (180PS)	
Astra Sports Tourer 1.6 Turbo	10/10→	Turbo Intercooled	
Insignia 1.6 Turbo	07/08→		
Insignia Saloon 1.6 Turbo,	01/09→		
Insignia Sports Tourer 1.6 Turbo			TD22589

20

08-435500-00	STD	79.00	1.200		001 NT	ST
08-435507-00	0.50mm		1.200		026 P	GOE13
			2.000		712 NT	ST



Corsa B 1.6 GSI 16V		03/93→09/00	C 16 XE	4cyl. 1598cc	80kW (109PS)	21
TD4789						
Corsa B 1.6 i 16V		09/94→09/00	X 16 XE	4cyl. 1598cc	78kW (106PS)	
Tigra 1.6 16V		07/94→08/98				
TD2735						
Astra F 1.6 i 16V		08/94→09/98	X 16 XEL	4cyl. 1598cc	74-78kW (100-106PS)	
Astra F ClassiC Estate 1.6 i 16V		01/98→01/05				
Astra F ClassiC Hatchback 1.6 i 16V,		01/98→08/02				
Astra F ClassiC Saloon 1.6 i 16V						
Astra F Estate 1.6 i 16V,		08/94→01/98				
Astra F Hatchback 1.6 i 16V						
Astra F Van 1.6 i 16V		08/94→03/98				
Astra G Estate 1.6 16V		02/98→07/04				
Astra G Hatchback 1.6 16V		02/98→01/05				
Astra G Saloon 1.6 16V		09/98→01/05				
Vectra B 1.6 i 16V		10/95→04/02				
Vectra B Estate 1.6 i 16V		11/96→07/02				
Vectra B Hatchback 1.6 i 16V		10/95→07/02				
Zafira A 1.6 16V		04/99→06/05				TD4820
08-307800-00	STD	79.00	1.200		001 CR	ST
08-307807-00	0.50mm		1.500		026 P	STD
08-307811-00	1.00mm		2.500		712 CR	ST
[R48380]						
Vectra B 1.6 i 16V		10/95→04/02	Y 16 XE	4cyl. 1598cc	74kW (100PS)	22
Vectra B Estate 1.6 i 16V		11/96→07/02				
Vectra B Hatchback 1.6 i 16V		10/95→07/02				
TD13688						
Astra G Box 1.6		09/00→04/05	Z 16 SE	4cyl. 1598cc	62kW (84PS)	
Astra G Estate 1.6		09/00→07/04				
Astra G Hatchback 1.6, Astra G Saloon 1.6		09/00→01/05				
Combo Box Body / Estate 1.6,		10/01→				
Combo Tour 1.6						
Meriva 1.6		05/03→05/10				TD15089
Astra G Convertible 1.6 16V		03/01→10/05	Z 16 XE	4cyl. 1598cc	74kW (100PS)	
Astra G Coupe 1.6 16V		03/00→05/05				
Astra G Estate 1.6 16V		02/98→07/04				
Astra G Hatchback 1.6 16V		02/98→01/05				
Astra G Hatchback 1.6 LPG		06/02→01/05				
Astra G Saloon 1.6 16V		09/98→01/05				
Astra G Saloon 1.6 LPG		06/02→01/05				
Meriva 1.6 16V		05/03→05/10				
Vectra B 1.6 i 16V		10/95→04/02				
Vectra B Estate 1.6 i 16V		11/96→07/02				
Vectra B Hatchback 1.6 i 16V		10/95→07/02				
Vectra C 1.6 16V, Vectra C Estate 1.6 16V		06/04→				
Vectra C Gts 1.6		08/05→				
Zafira A 1.6 16V		04/99→06/05				TD14923
08-125600-00	STD	79.00	1.200		001 NT	ST
08-125607-00	0.50mm		1.500		026 P	STD
			2.500		712 CR	ST
[R60570]						



Astra G Convertible 1.6	01/03→10/05	Z 16 XEP					
Astra G Coupe 1.6 16V	03/00→05/05		4cyl.				23
Astra G Estate 1.6	12/02→07/09		1598cc	74-77kW (101-105PS)			
Astra G Hatchback 1.6	12/02→12/09						
Astra G Saloon 1.6	12/02→01/05						
Astra H 1.6	03/04→						
Astra H Estate 1.6	08/04→						
Astra H GTC 1.6	03/05→						
Astra H TwinTop 1.6	09/05→						
Astra H Van 1.6	02/04→11/04						
Meriva 1.6	01/06→05/10						
Vectra C 1.6, Vectra C Estate 1.6,	01/06→						
Vectra C Gts 1.6							
Zafira B 1.6	07/05→						TD17892

08-427800-00	STD	79.00	1.200		001 NT	ST
08-427807-00	0.50mm		1.200		026 P	GOE13
			2.000		712 CR	ST

Astra H 1.6, Astra H Estate 1.6	12/06→	Z 16 XER					
Astra H Estate 1.6 LPG	08/09→		4cyl.				24
Astra H GTC 1.6	12/06→		1598cc	85kW (116PS)			
Astra H Saloon 1.6	02/07→						
Astra H TwinTop 1.6	12/06→						
Zafira B 1.6	01/08→						TD20060

08-435300-00	STD	79.00	1.200		001 NT	ST
08-435307-00	0.50mm		1.200		026 P	F12/F14
			2.000		712 NT	ST

Ascona C 1.6 D, Ascona C Hatchback 1.6 D	03/82→08/88	16 D					
Kadett D 1.6 D, Kadett D Estate 1.6 D	03/82→08/84		4cyl.				25
Kadett E 1.6 D	09/84→01/89		1598cc	40kW (54PS)			
Kadett E Box 1.6 D	08/84→08/88		Diesel				
Kadett E Estate 1.6 D,	09/84→01/89						
Kadett E Hatchback 1.6 D							TD4734

Ascona C 1.6 D, Ascona C Hatchback 1.6 D	03/82→08/88	16 DA					
Kadett E 1.6 D	09/84→01/89		4cyl.				
Kadett E Box 1.6 D	08/84→08/88		1598cc	40kW (54PS)			
Kadett E Combo 1.6 D	01/86→12/89		Diesel				
Kadett E Estate 1.6 D,	09/84→01/89						
Kadett E Hatchback 1.6 D							TD4735

08-305900-10	STD	80.00	2.000		001 CR P	KV1
08-305907-10	0.50mm		2.000		005 IF P	STD
08-305911-10	1.00mm		3.000		231 CR P	STD
<i>[R35900]</i>						



Ascona C 1.6	09/81→09/87	16 N					
Ascona C Hatchback 1.6	09/81→08/88		4cyl.				26
Kadett D 1.6, Kadett D Estate 1.6	09/79→08/84		1598cc	55kW (75PS)			
							TD5281

Ascona C 1.6 S, Ascona C Hatchback 1.6 S	09/81→08/86	16 SH					
Kadett D 1.6 S, Kadett D Estate 1.6 S	09/81→08/84		4cyl.				
Kadett E 1.6 S	09/84→08/86		1598cc	66kW (89PS)			
Kadett E Combo 1.6	09/86→06/93						
Kadett E Estate 1.6 S,	09/84→08/86						
Kadett E Hatchback 1.6 S							TD4739

08-305600-00	STD	80.00	1.500		001 IF CR P		IKA
08-305607-00	0.50mm				026 P		STD
08-305611-00	1.00mm		1.750		712 CR		ST
<i>[R35930]</i>			4.000				

Arena Box 1.9 D, Arena Combi 1.9 D	03/98→08/01	F8Q 600					27
			4cyl.				
			1870cc	44kW (60PS)			
			Diesel				TD21361

Arena Box 1.9 D, Arena Combi 1.9 D	03/98→08/01	F8Q 606					
			4cyl.				
			1870cc	44kW (60PS)			
			Diesel				TD21359

Arena	03/98→	F8Q-676, F8Q-714, F8Q-730, F8Q-732					
			4cyl.				
			1870cc				
			Diesel				FM13232

08-336500-00	STD	80.00	2.000		001 MO P		KV1
08-336505-00	0.25mm				005 IFU P		IKA
08-336507-00	0.50mm		2.000		231 CR P		STD
08-336510-00	0.80mm		3.000				
<i>[R66330]</i>							

Vivaro Box 1.9 DTI, Vivaro Combi 1.9 DTI	08/01→	F9Q 760					28
Vivaro Platform/Chassis 1.9 DTI	08/06→		4cyl.				
			1870cc	74kW (100PS)			
			Diesel				TD18872

08-113700-00	STD	80.00	2.500		001 IF CK P		KV1
			2.000		005 IFU P		IKA
			3.000		231 CR P		STD



Omega 2.5 TD	01/94 →	U 25TD	6cyl. 2498cc 96kW (131PS)	29	
		Diesel	Turbo Intercooled	TD18952	
Omega B 2.5 TD	04/94 →07/03	X 25 TD	6cyl. 2498cc 96kW (131PS)		
Omega B Estate 2.5 TD	04/94 →07/01	Diesel	Turbo Intercooled	TD4828	
Omega B 2.5 D	05/94 →05/99	X 25 TD	6cyl. 2498cc 96kW (131PS)		
Omega B 2.5 TD	04/94 →07/03	Diesel	Turbo Intercooled	TD17322	
Omega B Estate 2.5 TD	04/94 →07/01				
08-704500-00	STD	80.00	3.000	008 CR P	KV1
08-704507-00	0.50mm		1.750	005 IFU P	IKA
[R49900]			3.000	231 CR P	STD
Astra F Classic Hatchback 1.8 i	03/98 →08/00	X 18 XE1	4cyl. 1796cc 85kW (116PS)	30	
Astra G Coupe 1.8 16V	03/00 →10/00				
Astra G Estate 1.8 16V,	02/98 →09/00				
Astra G Hatchback 1.8 16V					
Astra G Saloon 1.8 16V	09/98 →09/00				
Vectra B 1.8 i 16V	10/95 →09/00				
Vectra B Estate 1.8 i 16V	11/96 →09/00				
Vectra B Hatchback 1.8 i 16V	10/95 →09/00				
Zafira A 1.8 16V	04/99 →09/00			TD9509	
Astra G Convertible 1.8 16V	03/01 →10/05	Z 18 XE	4cyl. 1799cc 92kW (125PS)		
Astra G Coupe 1.8 16V	09/00 →05/05				
Astra G Estate 1.8 16V	09/00 →07/04				
Astra G Hatchback 1.8 16V,	09/00 →01/05				
Astra G Saloon 1.8 16V					
Astra H 1.8	03/04 →				
Astra H Estate 1.8	08/04 →				
Astra H GTC 1.8	03/05 →				
Astra H TwinTop 1.8	09/05 →				
Corsa C 1.8	09/00 →12/09				
Meriva 1.8	05/03 →05/10				
Signum 1.8	05/03 →				
Tigra TwinTop 1.8	06/04 →				
Vectra B 1.8 i 16V	09/00 →04/02				
Vectra B Estate 1.8 i 16V,	09/00 →07/03				
Vectra B Hatchback 1.8 i 16V					
Vectra C 1.8 16V	04/02 →				
Vectra C Estate 1.8	10/03 →				
Vectra C Gts 1.8 16V	08/02 →				
Zafira A 1.8 16V	09/00 →06/05			TD14922	
Astra F Classic Estate 1.8	02/03 →07/04	Z 18 XEL	4cyl. 1796cc 81-85kW (110-116PS)		
Vectra B 1.8 i 16V	10/95 →09/00				
Vectra B Estate 1.8 i 16V	11/96 →09/00				
Vectra B Hatchback 1.8 i 16V	10/95 →09/00				
Vectra C 1.8	04/02 →				
Vectra C Gts 1.8 16V	08/02 →12/06			TD17894	





Astra H 1.8	01/06→	Z 18 XER			
Astra H Estate 1.8	08/05→		4cyl.		
Astra H GTC 1.8	01/06→		1796cc	103kW (140PS)	
Astra H Saloon 1.8	02/07→				
Astra H TwinTop 1.8, Signum 1.8	09/05→				
Vectra C 1.8, Vectra C Estate 1.8,	01/06→				
Vectra C Gts 1.8					
Zafira B 1.8, Zafira B Van 1.8	07/05→				TD18730

08-141200-00	STD	80.50	1.200		001 NT	ST
08-141207-00	0.50mm		1.200		005 P	GOE12
			2.000		712 CR	ST

Astra F 1.8 i 16V	06/93→10/94	C 18 XE			
Astra F Estate 1.8 i 16V	06/93→01/98		4cyl.		
Astra F Hatchback 1.8 i 16V	06/93→08/94		1796cc	92kW (125PS)	
					31
					TD4795

Astra F 1.8 i 16V	11/94→09/98	C 18 XEL			
Astra F Convertible 1.8 i 16V	11/94→03/01		4cyl.		
Astra F Estate 1.8 i 16V	07/94→01/98		1796cc	85kW (116PS)	
Astra F Hatchback 1.8 i 16V	09/94→01/98				TD4796

Calibra A 2.5 i V6	04/93→07/97	C 25 XE			
Vectra A 2.5 CD 4x4	08/92→08/95		V6cyl.		
Vectra A 2.5 V6,	02/93→11/95		2498cc	125kW (170PS)	
Vectra A Hatchback 2.5 V6					TD4804

Astra F 1.8 i 16V	11/94→09/98	X 18 XE			
Astra F Convertible 1.8 i 16V	11/94→03/01		4cyl.		
Astra F Estate 1.8 i 16V	07/94→01/98		1796cc	85kW (116PS)	
Astra F Hatchback 1.8 i 16V	09/94→01/98				
Vectra B 1.8 i 16V	10/95→09/00				
Vectra B Estate 1.8 i 16V	11/96→09/00				
Vectra B Hatchback 1.8 i 16V	10/95→09/00				TD4823

Calibra A 2.5 i V6	04/93→07/97	X 25 XE			
Omega B 2.5 V6, Omega B Estate 2.5 V6	03/94→09/00		V6cyl.		
Vectra B 2.5 i V6	10/95→09/00		2498cc	125kW (170PS)	
Vectra B i 500 2.5	05/98→09/00				
Vectra B Estate 2.5 i V6	11/96→09/00				
Vectra B Estate i 500 2.5	05/98→09/00				
Vectra B Hatchback 2.5	10/99→06/00				
Vectra B Hatchback 2.5 i V6	10/95→09/00				TD2738

08-307700-00	STD	81.60	1.500		001 MO P	IKA
08-307707-00	0.50mm		1.500		026 P	STD
08-307711-00	1.00mm		3.000		712 CR	ST
[R49600]						



Astra H 1.9 CDTI	06/04→	Z 19 DT							
Astra H Estate 1.9 CDTI,	09/05→		4cyl.						32
Astra H GTC 1.9 CDTI,			1910cc	74-88kW (100-120PS)					
Astra H Van 1.9 CDTI		Diesel	Turbo Intercooled						
Signum 1.9 CDTI, Vectra C 1.9 CDTI,	04/04→								
Vectra C Estate 1.9 CDTI,									
Vectra C Gts 1.9 CDTI									
Zafira B 1.9 CDTI	07/05→							TD18046	

Astra H 1.9 CDTI, Astra H Estate 1.9 CDTI	09/05→	Z 19 DTL Euro 4							
Astra H GTC 1.9 CDTI	01/06→		4cyl.						
Vectra C Estate 1.9 CDTI	10/05→		1910cc	74kW (100PS)					
Zafira B 1.9 CDTI	07/05→	Diesel	Turbo Intercooled					TD18671	

08-124000-00	STD	82.00	2.000		001 CK P		KV1
08-124006-00	0.40mm		2.000		026 P		F12/F14
08-124008-00	0.60mm		2.000		231 CR P		GOE12
[R60580]							

Astra H 1.9 CDTI, Astra H Estate 1.9 CDTI	09/04→	Z 19 DTH							33
Astra H GTC 1.9 CDTI	03/05→		4cyl.						
Astra H TwinTop 1.9 CDTI	09/05→		1910cc	88-110kW (120-150PS)					
Astra H Van 1.9 CDTI	09/04→	Diesel	Turbo Intercooled						
Signum 1.9 CDTI, Vectra C 1.9 CDTI,	04/04→								
Vectra C Estate 1.9 CDTI,									
Vectra C Gts 1.9 CDTI									
Zafira B 1.9 CDTI	07/05→							TD18014	

Astra H 1.9 CDTI 16V	04/04→	Z 19 DTJ							
Astra H Estate 1.9 CDTI 16V	08/04→		4cyl.						
Astra H GTC 1.9 CDTI 16V	03/05→		1910cc	88kW (120PS)					
Astra H Van 1.9 CDTI 16V	08/04→	Diesel	Turbo Intercooled					TD18011	

08-146100-00	STD	82.00	2.000		001 CK P		KV1
08-146106-00	0.40mm		2.000		023 IWU P		F12/F14
08-146108-00	0.60mm		2.000		231 CK P		GOE12
[R67925]							

Astra F 1.7 D	03/92→09/92	17 D							34
Astra F Estate 1.7 D,	12/91→09/92		4cyl.						
Astra F Hatchback 1.7 D,			1699cc	42kW (57PS)					
Astra F Van 1.7 D		Diesel							
Kadett E 1.7 D	02/89→08/91								
Kadett E Box 1.7 D	08/88→09/92								
Kadett E Combo 1.7 D	01/89→07/94								
Kadett E Estate 1.7 D,	02/89→08/91								
Kadett E Hatchback 1.7 D									
Vectra A 1.7 D	10/88→09/92								
Vectra A Hatchback 1.7 D	09/88→09/92							TD4742	

Astra F 1.7 D	07/92→09/98	17 DR							
Astra F Estate 1.7 D,	07/92→01/98		4cyl.						
Astra F Hatchback 1.7 D			1699cc	42-44kW (57-60PS)					
Astra F Van 1.7 D	07/92→01/99	Diesel							
Kadett E Combo 1.7 D	07/92→07/94								
Vectra A 1.7 D, Vectra A Hatchback 1.7 D	07/92→11/95							TD4744	





Astra F 1.7 TD	11/94→09/98				X 17 DTL	
Astra F Classic Hatchback 1.7 TD	03/98→08/00				4cyl.	
Astra F Estate 1.7 TD,	11/94→01/98				1699cc 50kW (68PS)	
Astra F Hatchback 1.7 TD					Diesel Turbo Intercooled	
Astra F Van 1.7 TD	08/94→01/99					
Astra G Box 1.7 TD	01/99→04/05					
Astra G Estate 1.7 TD,	02/98→08/00					
Astra G Hatchback 1.7 TD						
Astra G Saloon 1.7 TD	09/98→08/00					TD4821

08-306700-00	STD	82.50	2.000		001 CR P	KV1
08-306707-00	0.50mm					
08-306711-00	1.00mm		2.000		005 P	STD
[R48750]			3.000		231 CR P	STD

Insignia 2.0 CDTI,	07/08→				A 20 DT Euro 5	
Insignia Saloon 2.0 CDTI,					4cyl.	
Insignia Sports Tourer 2.0 CDTI					1956cc 96kW (131PS)	35
Zafira C 2.0 CDTi	10/11→				Diesel Turbo Intercooled	TD25782

Insignia 2.0 CDTI,	07/08→				A 20 DTC Euro 5	
Insignia Saloon 2.0 CDTI,					4cyl.	
Insignia Sports Tourer 2.0 CDTI					1956cc 81kW (110PS)	
					Diesel Turbo Intercooled	TD22597

Insignia 2.0 CDTI,	03/12→				A 20 DTE Euro 5	
Insignia Saloon 2.0 CDTI,					4cyl.	
Insignia Sports Tourer 2.0 CDTI					1956cc 88-103kW (120-140PS)	
					Diesel Turbo Direct Injection	TD28123

Astra GTC J 2.0 CDTI	10/11→				A 20 DTH Euro 5	
Astra J 2.0 CDTI	12/09→				4cyl.	
Astra Sports Tourer 2.0 CDTI	10/10→				1956cc 118kW (160PS)	
Cascada 2.0 CDTI	03/13→				Diesel Turbo Intercooled	
Insignia 2.0 CDTI	07/08→					
Insignia 2.0 CDTI 4x4	06/10→					
Insignia Saloon 2.0 CDTI	07/08→					
Insignia Saloon 2.0 CDTI 4x4	06/10→					
Insignia Sports Tourer 2.0 CDTI	07/08→					
Insignia Sports Tourer 2.0 CDTI 4x4	06/10→					
Zafira C 2.0 CDTi	10/11→					TD22601

Insignia 2.0 CDTI,	07/08→				A 20 DTJ Euro 5	
Insignia Saloon 2.0 CDTI,					4cyl.	
Insignia Sports Tourer 2.0 CDTI					1956cc 96kW (131PS)	
					Diesel Turbo Intercooled	TD22599

Insignia 2.0 CDTI,	07/08→				A 20 DTL Euro 5	
Insignia Saloon 2.0 CDTI,					4cyl.	
Insignia Sports Tourer 2.0 CDTI					1956cc 81kW (110PS)	
Zafira C 2.0 CDTi	10/11→				Diesel Turbo Intercooled	TD25724

Astra GTC J 2.0 BiTurbo CDTI	10/12→				A 20 DTR Euro 5	
Astra J 2.0 BiTurbo CDTI,	12/12→				4cyl.	
Astra Sports Tourer 2.0 BiTurbo CDTI					1956cc 140kW (190PS)	
Cascada 2.0 CDTI	03/13→				Diesel Bi-Turbo Intercooled	
Insignia 2.0 Biturbo CDTI	07/08→					
Insignia 2.0 Biturbo CDTI 4x4	05/09→					
Insignia Saloon 2.0 Biturbo CDTI,	07/08→					
Insignia Saloon 2.0 Biturbo CDTI 4x4,						
Insignia Sports Tourer 2.0 Biturbo CDTI,						
Insignia Sports Tourer 2.0 Biturbo CDTI 4x4						
Zafira C 2.0 BiTurbo CDTI	01/13→					TD22604

















Combo Box Body / Estate 2.0 CDTI, Combo Tour 2.0 CDTI		02/12→	A 20 FD Euro 5		4cyl. 1956cc 99kW (135PS)		
			Diesel Turbo Intercooled				TD26185
Zafira C 2.0 CDTi		10/11→	Y 20 DTJ		4cyl. 1956cc 96kW (131PS)		
			Diesel Turbo Intercooled				TD26542
Zafira C 2.0 CDTi		10/11→	Z 20 DTJ		4cyl. 1956cc 96kW (131PS)		
			Diesel Turbo Intercooled				TD26541
08-436500-00	STD	83.00	1.500		001 GDC P		KV4
08-436506-00	0.40mm		1.500		050 P		F12/F14
			2.000		231 LKZ CK P		GOE13
Omega B 2.6 V6, Omega B Estate 2.6 V6		09/00→07/03	Y 26 SE		V6cyl. 2597cc 125-132kW (170-180PS)		36
Vectra B 2.6 i V6		09/00→04/02					
Vectra B Estate 2.6 i V6,		09/00→07/03					
Vectra B Hatchback 2.6 i V6							TD14925
08-126100-00	STD	83.20	1.200		001 CK		ST
08-126107-00	0.50mm		1.500		026 P		GOE12
[R66640]			3.000		712 CR		ST
Vivaro Box 2.0 CDTI		08/06→	M9R 630		4cyl. 1995cc 66-84kW (90-114PS)		37
			Diesel Turbo Intercooled				TD25646
Vivaro Box 2.0 CDTI, Vivaro Combi 2.0 CDTI, Vivaro Platform/ Chassis 2.0 CDTI		08/06→	M9R 780 Euro 4		4cyl. 1995cc 66-84kW (90-114PS)		
			Diesel Turbo Intercooled				TD20888
Vivaro Box 2.0 CDTI, Vivaro Combi 2.0 CDTI		08/06→	M9R 782		4cyl. 1995cc 66-84kW (90-114PS)		
Vivaro Platform/Chassis 2.0 CDTI		01/06→					TD24726
Vivaro Box 2.0 CDTI, Vivaro Combi 2.0 CDTI		08/06→	M9R 784		4cyl. 1995cc 84kW (114PS)		
			Diesel Turbo Intercooled				TD25140
Vivaro Box 2.0 CDTI, Vivaro Combi 2.0 CDTI		08/06→	M9R 786 Euro 4		4cyl. 1995cc 66-84kW (90-114PS)		
			Diesel Turbo Intercooled				TD25139





Vivaro Box 2.0 CDTI,			08/06→	M9R 788				
Vivaro Combi 2.0 CDTI					4cyl.			
					1995cc	84kW (114PS)		
					Diesel	Turbo Intercooled		TD25143
08-422000-00	STD	84.00	2.500		007 MOL P			KV1
08-422007-00	0.50mm		2.000		005 IFU MOL P			GOE12
			2.000		231 CR P			GOE12
Astra F Classic Hatchback 2.0 DTi			08/99→08/00	X 20 DTH				38
Astra G Estate 2.0 DTI 16V			08/99→07/04		4cyl.			
Astra G Hatchback 2.0 DTI 16V,			08/99→01/05		1995cc	74kW (100PS)		
Astra G Saloon 2.0 DTI 16V					Diesel	Turbo Intercooled		
Omega B 2.0 DTI 16V,			09/97→09/00					
Omega B Estate 2.0 DTI 16V								
Vectra B 2.0 DTI 16V			06/97→04/02					
Vectra B Estate 2.0 DTI 16V,			06/97→07/03					
Vectra B Hatchback 2.0 DTI 16V								TD9729
08-102900-00	STD	84.00	2.500		008 CK P			KV1
08-102907-00	0.50mm		1.750		005 P			IKA
[R49840]			3.000		231 CR P			STD
Astra F Classic Hatchback 2.0 Di			03/98→08/00	X 20 DTL				39
Astra G Box 2.0 DI			01/99→04/05		4cyl.			
Astra G Estate 2.0 DI			02/98→07/04		1896cc	60kW (81PS)		
Astra G Hatchback 2.0 DI			02/98→01/05		Diesel			
Astra G Saloon 2.0 DI			09/98→01/05					
Vectra B 2.0 DI 16V			11/96→04/02					
Vectra B Estate 2.0 DI 16V,			11/96→06/00					
Vectra B Hatchback 2.0 DI 16V								
Zafira A 2.0 DI 16V			10/99→06/05					TD4824
Astra G Estate 2.0 DI			02/98→07/04	Y 20 DTL				
Astra G Hatchback 2.0 DI			02/98→01/05		4cyl.			
Astra G Saloon 2.0 DI			09/98→01/05		1995cc	60kW (81PS)		
Zafira A 2.0 DTI			11/03→06/05		Diesel			TD15848
08-102800-00	STD	84.00	2.000		001 CK P			KV1
08-102807-00	0.50mm		1.750		005 P			IKA
[R49830]			3.000		231 CR P			STD



Frontera B 2.2 DTI Sintra 2.2 DTI	10/98→09/02 07/97→04/99	X 22 DTH	4cyl. 2172cc 85kW (116PS)	40
		Diesel	Turbo	TD9510
Astra G Estate 2.0 DTI 16V Astra G Hatchback 2.0 DTI 16V, Astra G Saloon 2.0 DTI 16V Signum 2.0 DTI Vectra B 2.0 DTI 16V Vectra B Estate 2.0 DTI 16V, Vectra B Hatchback 2.0 DTI 16V Vectra C 2.0 DTI 16V Vectra C Estate 2.0 DTI Vectra C Gts 2.0 DTI 16V Zafira A 2.0 DTI 16V	08/99→07/04 08/99→01/05 05/03→ 06/97→04/02 06/97→07/03 04/02→ 10/03→ 08/02→ 09/00→06/05	Y 20 DTH	4cyl. 1995cc 74kW (100PS) Diesel Turbo Intercooled	TD13752
Frontera B 2.2 DTI Omega B 2.2 DTI 16V, Omega B Estate 2.2 DTI 16V	10/98→ 09/00→07/03	Y 22 DTH	4cyl. 2172cc 85-92kW (115-125PS) Diesel Turbo Intercooled	TD15091
Astra G Convertible 2.2 DTI Astra G Coupe 2.2 DTI Astra G Estate 2.2 DTI Astra G Hatchback 2.2 DTI, Astra G Saloon 2.2 DTI Omega B 2.2 DTI 16V Signum 2.2 DTI Signum 2.2 DTI 16V Vectra B 2.2 DTI 16V Vectra B Estate 2.2 DTI 16V, Vectra B Hatchback 2.2 DTI 16V Vectra C 2.2 DTI 16V Vectra C Estate 2.2 DTI Vectra C Gts 2.2 DTI 16V Zafira A 2.2 DTI 16V	09/02→10/05 09/02→05/05 09/02→07/04 09/02→01/05 01/01→ 05/03→ 05/03→06/08 09/00→04/02 09/00→07/03 04/02→ 10/03→ 08/02→ 01/02→06/05	Y 22 DTR	4cyl. 2172cc 92kW (125PS) Diesel Turbo Intercooled	TD14924
08-126000-00 STD	84.00	1.750	 001 CK P	KV1
08-126007-00 0.50mm		1.750	 005 P	IKA
[R60610]		3.000	 231 CR P	GOE12
Ascona C 1.8 i, Ascona C Hatchback 1.8 i Kadett D 1.8 GT/E Kadett E 1.8 Kadett E 1.8 i, Kadett E Estate 1.8 i, Kadett E Hatchback 1.8 GSI	09/82→08/86 02/83→08/84 09/87→08/90 09/84→08/86	18 E	4cyl. 1796cc 82-85kW (112-115PS)	41
				TD4749
Manta B 1.8 S, Manta B Cc 1.8 S Rekord E 1.8 S, Rekord E Estate 1.8 S	07/82→08/87 11/82→08/86	18 S	4cyl. 1796cc 65-66kW (88-90PS)	TD4752
Astra F 1.8 i 16V Kadett E 1.8 i Kadett E Estate 1.8	09/95→09/96 09/84→08/86 12/88→08/91	18 SE	4cyl. 1796cc 82-85kW (112-116PS)	TD4753
Omega A 1.8, Omega A Estate 1.8	09/86→03/94	18 SEH	4cyl. 1796cc 85kW (116PS)	TD4754





Kadett E 1.8 i			09/90→08/91	18 SV			
Omega A 1.8 N			11/86→09/88		4cyl.		
Omega A 1.8 S			09/86→03/94		1796cc	66kW (89PS)	
Omega A Estate 1.8 N			11/86→09/88				
Omega A Estate 1.8 S			09/86→03/94				
Vectra A 1.8 S			09/89→10/90				
Vectra A Hatchback 1.8 i			09/88→10/90				TD4755
Ascona C 1.8 E, Ascona C Hatchback 1.8 E			01/85→08/86	C 18 NE			
Kadett E 1.8 i, Kadett E Estate 1.8 E, Kadett E Hatchback 1.8 E			10/85→08/86		4cyl.		
					1796cc	74kW (100PS)	
							TD4790
Kadett E 1.8 i			09/90→08/91	C 18 NT			
Kadett E Box 1.8 i			08/84→09/92		4cyl.		
Kadett E Estate 1.8 i, Kadett E Hatchback 1.8 i			06/85→08/91		1771cc	66kW (89PS)	
							TD4791
Astra F 1.8 i			03/92→09/98	C 18 NZ			
Astra F Estate 1.8 i, Astra F Hatchback 1.8 i			09/91→01/98		4cyl.		
					1796cc	66kW (89PS)	
Kadett E 1.8 i			09/90→08/91				
Kadett E Estate 1.8 i, Kadett E Hatchback 1.8 i			06/85→08/91				
Vectra A 1.8 i CAT, Vectra A Hatchback 1.8 i CAT			03/90→11/95				TD4793
08-306000-00	STD	84.80	1.500		001 IF CR P		IKA
08-306007-00	0.50mm		1.750		026 P		STD
<i>[R39880]</i>			4.000		712 CR		ST
08-306100-00	STD	84.80	1.500		001 IF MO P		IKA
			1.750		026 P		STD
			4.000		712 CR		ST
08-307200-00	STD	84.80	1.500		001 CR P		KV1
08-307207-00	0.50mm		1.500		026 P		STD
09/1986→			3.000		712 CR		ST
<i>[R43260]</i>							
Omega A 1.8 N, Omega A Estate 1.8 N			09/86→08/87	18 NV			
					4cyl.		42
					1796cc	60kW (81PS)	
							TD4751
Ascona C 1.8, Ascona C Hatchback 1.8			09/87→08/88	E 18 NV			
Kadett E 1.8 S, Kadett E Estate 1.8 S, Kadett E Hatchback 1.8 S			09/87→08/91		4cyl.		
					1796cc	62kW (84PS)	
							TD4812
Omega A 1.8, Omega A Estate 1.8			09/87→03/94	E 18 NVR			
Vectra A 1.8 S			09/88→07/89		4cyl.		
Vectra A 1.8 S 4x4			01/89→07/89		1796cc	65kW (88PS)	
Vectra A Hatchback 1.8 S			09/88→07/89				TD4813





Ascona C 1.8 E, Ascona C Hatchback 1.8 E	01/85→08/86	S 18 NV			
Kadett E Hatchback 1.8 i	06/85→08/91		4cyl.		
Kadett E Hatchback 1.8 S	09/87→08/91		1796cc	62-74kW (84-101PS)	
					TD17891

08-307200-00	STD	84.80	1.500		001 CR P	KV1
08-307207-00	0.50mm		1.500		026 P	STD
09/1986→			3.000		712 CR	ST
<i>[R43260]</i>						

Ascona A 1.6 S, Ascona A Voyage 1.6 S	10/70→08/75	16 S				43
Ascona B 1.6 S	09/75→08/81		4cyl.			
Kadett C 1.6 S, Kadett C City 1.6 S,	05/77→07/79		1584cc	55kW (75PS)		
Kadett C Coupe 1.6 S,						
Kadett C Estate 1.6 S						
Manta A 1.6	02/75→08/75					
Manta A 1.6 S	09/70→08/75					
Manta B 1.6 S	09/75→12/81					
Manta B Cc 1.6	08/77→07/81					TD4737

08-304000-00	STD	85.00	2.000		001 IF CR P	STD
			2.000		026 P	STD
			5.000		236 P	STD

Movano B Box 2.3 CDTI FWD	05/10→	M9T 670 Euro 5				44
Movano B Bus 2.3 CDTI	12/10→		4cyl.			
Movano B Platform/Chassis 2.3 CDTI FWD	05/10→		2298cc	74-92kW (101-125PS)		
					Diesel Turbo Intercooled	TD25055

Movano B Box 2.3 CDTI FWD	05/10→	M9T 672 Euro 5				
Movano B Bus 2.3 CDTI	12/10→		4cyl.			
Movano B Platform/Chassis 2.3 CDTI FWD	05/10→		2298cc	74-92kW (101-125PS)		
					Diesel Turbo Intercooled	TD25226

Movano B Box 2.3 CDTI FWD	05/10→	M9T 676 Euro 4				
Movano B Bus 2.3 CDTI	12/10→		4cyl.			
Movano B Platform/Chassis 2.3 CDTI FWD	05/10→		2298cc	74-92kW (101-125PS)		
					Diesel Turbo Intercooled	TD25056

Movano B Box 2.3 CDTI FWD	05/10→	M9T 678				
Movano B Bus 2.3 CDTI	12/10→		4cyl.			
Movano B Platform/Chassis 2.3 CDTI FWD	05/10→		2298cc	107kW (146PS)		
					Diesel Turbo Intercooled	TD25157

Movano B Box 2.3 CDTI FWD	05/10→	M9T 680				
Movano B Bus 2.3 CDTI	12/10→		4cyl.			
Movano B Platform/Chassis 2.3 CDTI FWD	05/10→		2298cc	92-107kW (125-146PS)		
					Diesel Turbo Intercooled	TD25137

Movano B Box 2.3 CDTI [RWD]	05/10→	M9T 686 Euro 5				
			4cyl.			
			2298cc	92kW (125PS)		
					Diesel Turbo Intercooled	TD25231

Movano B Box 2.3 CDTI [RWD],	05/10→	M9T 690 Euro 5				
Movano B Platform/Chassis 2.3 CDTI [RWD]			4cyl.			
			2298cc	74-92kW (101-125PS)		
					Diesel Turbo Intercooled	TD25230

Movano B Box 2.3 CDTI [RWD],	05/10→	M9T 692 Euro 4				
Movano B Platform/Chassis 2.3 CDTI [RWD]			4cyl.			
			2298cc	74-92kW (101-125PS)		
					Diesel Turbo Intercooled	TD25224





Movano B Box 2.3 CDTI [RWD], Movano B Platform/Chassis 2.3 CDTI [RWD]	05/10→			M9T 694 Euro 4 4cyl. 2298cc 107kW (146PS) Diesel Turbo Intercooled		TD25058
Movano B Box 2.3 CDTI [RWD], Movano B Platform/Chassis 2.3 CDTI [RWD]	05/10→			M9T 696 Euro 4 4cyl. 2298cc 92-107kW (125-146PS) Diesel Turbo Intercooled		TD25225
Movano B Box 2.3 CDTI [RWD], Movano B Platform/Chassis 2.3 CDTI [RWD]	05/10→			M9T 698 Euro 5 4cyl. 2298cc 92-107kW (125-146PS) Diesel Turbo Intercooled		TD25057
08-435200-00 08-435207-00	STD 0.50mm	85.00	2.500 2.000 2.000	 	007 GDC P 005 IF MO P 231 CR P	KV1 GOE13 GOE13
Ascona C 2.0 i, Ascona C Hatchback 2.0 i Kadett E 2.0 i Kadett E Convertible 2.0 i Kadett E Estate 2.0 i Kadett E Hatchback 2.0 GSI Vectra A 2.0 i Vectra A 2.0 i 4x4 Vectra A Hatchback 2.0 i	09/86→08/88 03/87→08/91 10/86→02/93 09/87→08/91 09/86→08/91 09/88→10/90 01/89→10/90 09/88→10/90			20 NE 4cyl. 1998cc 85kW (116PS)		45 TD4759
Kadett E 2.0 i Omega A 2.0, Omega A Estate 2.0 Omega B 2.0	03/87→08/91 09/86→03/94 03/94→12/00			20 SE 4cyl. 1998cc 85-90kW (115-122PS)		TD2651
Ascona C 2.0 i GT, Ascona C Hatchback 2.0 i GT Kadett E Hatchback 2.0 GSI Vectra A 2.0 i Vectra A 2.0 i 4x4 Vectra A Hatchback 2.0 i GT	03/87→08/88 09/86→08/91 09/88→09/92 01/89→09/92 09/88→11/95			20 SEH 4cyl. 1998cc 95kW (129PS)		TD4763
Kadett E Convertible 2.0 GSi	09/90→05/92			20 SER 4cyl. 1998cc 90-115kW (122-156PS)		TD18871
Kadett E Hatchback 2.0 GSI 16V	12/87→08/91			20 XE 4cyl. 1998cc 115kW (156PS)		TD4765
Kadett E Hatchback 2.0 GSI 16V Vectra A 2000 16V 4x4 Vectra A 2000/GT 16V Vectra A Hatchback 2.0 i 16V	03/88→08/91 01/89→10/90 01/89→06/94 02/89→10/90			20 XEJ 4cyl. 1984cc 110kW (150PS)		TD4764
Calibra A 2.0 i Turbo 4x4 Vectra A 2.0 i Turbo 4x4	03/92→07/97 06/94→11/95			C 20 LET 4cyl. 1998cc 150kW (204PS) Turbo Intercooled		TD4798





Ascona C 2.0 i CAT, Ascona C Hatchback 2.0 i CAT	09/86→08/88	C 20 NE	4cyl.		
Astra F 2.0 i	03/92→09/98		1998cc	85kW (116PS)	
Astra F Convertible 2.0 i	03/93→10/94				
Astra F Estate 2.0 i	09/91→07/94				
Astra F Hatchback 2.0 i	09/91→01/98				
Calibra A 2.0 i, Calibra A 2.0 i 4x4	06/90→07/97				
Frontera A Sport 2.0 i	03/92→10/98				
Kadett E 2.0 i CAT	03/87→08/91				
Kadett E Convertible 2.0 i CAT	10/86→02/93				
Kadett E Estate 2.0 i CAT	09/87→08/91				
Kadett E Hatchback 2.0 GSI CAT	09/86→08/91				
Omega A 2.0 i	09/86→03/94				
Omega A Estate 2.0	09/87→04/94				
Omega A Estate 2.0 i	09/86→03/94				
Vectra A 2.0 i 4x4 CAT	01/89→11/95				
Vectra A 2.0 i CAT, Vectra A Hatchback 2.0 i CAT	09/88→11/95				TD4799
Astra G Hatchback 2.0 16V Vectra B 2.0 i 16V	02/98→01/05 10/95→09/00	C 20 SEL	4cyl.		
Vectra B Estate 2.0 i 16V Vectra B Hatchback 2.0 i 16V	11/96→09/00 10/95→09/00		1998cc	100kW (136PS)	TD15968
Astra F Estate 2.0 i 16V Astra F Hatchback 2.0 GSI 16V	03/93→01/98 09/91→01/98	C 20 XE	4cyl.		
Calibra A 2.0 i 16V, Calibra A 2.0 i 16V 4x4	06/90→02/94		1998cc	110kW (150PS)	
Kadett E Convertible 2.0	09/90→05/92				
Kadett E Hatchback 2.0 GSI 16V CAT	03/88→08/91				
Vectra A 2000/GT 16V 4x4 CAT, Vectra A 2000/GT 16V CAT, Vectra A Hatchback 2.0 i 16V CAT	02/90→11/95				TD4801
Vectra B 2.2 i 16V Vectra B Estate 2.2 i 16V, Vectra B Hatchback 2.2 i 16V	09/00→04/02 09/00→07/03	C 22 SEL	4cyl.		
			2198cc	102-106kW (139-144PS)	TD22202
Frontera A Sport 2.0 i Omega B 2.0, Omega B Estate 2.0	03/92→10/98 03/94→09/99	X 20 SE	4cyl.		
			1998cc	85kW (116PS)	TD2736
Astra F 2.0 i 16V Astra F Classic Hatchback 2.0 i Astra F Estate 2.0 i 16V, Astra F Hatchback 2.0 i 16V	02/95→09/98 03/98→08/00 02/95→01/98	X 20 XEV	4cyl.		
Astra G Estate 2.0 16V Astra G Hatchback 2.0 16V Astra G Saloon 2.0 16V Calibra A 2.0 i 16V, Calibra A 2.0 i 16V 4x4	02/98→07/04 02/98→01/05 09/98→01/05 02/94→07/97		1998cc	100kW (136PS)	
Omega B 2.0 16V, Omega B Estate 2.0 16V Vectra A 2.0 i 16V, Vectra A 2.0 i 16V 4x4, Vectra A Hatchback 2.0 i 16V	03/94→09/99 06/94→11/95				
Vectra B 2.0 i 16V Vectra B Estate 2.0 i 16V Vectra B Hatchback 2.0 i 16V	10/95→09/00 11/96→09/00 10/95→09/00				TD2737
Frontera B 2.2 i	10/98→	X 22 SE	4cyl.		
			2198cc	100-104kW (136-141PS)	TD15849





Frontera A 2.2 i Sintra 2.2 i 16V			03/95→10/98 11/96→04/99	X 22 XE	4cyl. 2198cc	100kW (136PS)	TD4827
Omega B 3.0 V6, Omega B Estate 3.0 V6 Sintra 3.0 i 24V			04/94→02/01 11/96→04/99	X 30 XE	V6cyl. 2962cc	155kW (211PS)	TD2739
08-306800-00	STD	86.00	1.500		001 IF CR P		IKA
08-306807-00	0.50mm		1.500		005 IF P		STD
08-306811-00	1.00mm		3.000		712 CR		ST
[R43290]							
Blitz, Commodore, Senator			01/67→12/87	25 CIH	6cyl. 2490cc		46 FM6187
Commodore A 2.5 GS, Commodore A Coupe 2.5 GS Commodore B 2.5 GS, Commodore B Coupe 2.5 GS			08/67→01/72 01/72→08/75	25 H	6cyl. 2490cc	96kW (131PS)	TD2669
Commodore A 2.5, Commodore A Coupe 2.5 Commodore B 2.5, Commodore B Coupe 2.5 Commodore C 2.5 S Commodore C Estate 2.5 S Senator A 2.5			08/67→08/69 01/72→07/78 08/78→12/82 12/80→12/82 05/78→12/80	25 S	6cyl. 2490cc	85kW (116PS)	TD2671
08-303200-00	STD	87.00	2.000		001 IF MO P		IKA
			2.000		026 P		STD
			5.000		236 P		STD
Movano Box 2.2 DTI, Movano Combi 2.2 DTI, Movano Dumptruck 2.2 DTI, Movano Platform/Chassis 2.2 DTI			09/00→	G9T 720	4cyl. 2188cc	66kW (89PS)	47 TD18875
				Diesel	Turbo Intercooled		
Movano Box 2.2 DTI, Movano Combi 2.2 DTI, Movano Dumptruck 2.2 DTI, Movano Platform/Chassis 2.2 DTI			09/00→	G9T 722	4cyl. 2188cc	66kW (89PS)	TD21397
				Diesel	Turbo Intercooled		
Movano Combi			09/00→	G9T 750	4cyl. 2188cc	66kW (89PS)	TD23885
				Diesel	Turbo Intercooled		
08-127400-00	STD	87.00	3.000		007 P PS		KV1
08-127407-00	0.50mm		1.750		005 IFU P		IKA
			2.500		236 P		IKA
[R66780]							



Omega B 3.2 V6, Omega B Estate 3.2 V6	02/01→07/03	Y 32 SE	V6cyl. 3175cc	160kW (218PS)	48
					TD15851

08-126200-00	STD	87.50	1.200		001 CK	ST
08-126207-00	0.50mm		1.500		026 P	GOE13
[R66630]			2.500		712 CR	ST

Campo 2.2 D, Campo 2.2 D 4x4	08/87→09/96	C 223	4cyl. 2238cc	39-54kW (53-73PS)	49
					TD22878

08-247600-00	STD	88.00	2.000		001 P	IKA
12/1983→			2.000		005 P	STD
[R42520]			4.000		236 P	STD

Omega A 2.6 i, Omega A Estate 2.6 i	09/90→03/94	C 26 NE	6cyl. 2594cc	110kW (150PS)	50
Senator B 2.6 i	09/90→09/93				TD4805

08-307400-00	STD	88.80	1.500		001 IF MO P	IKA
			1.500		026 P	STD
			3.000		236 P	STD

Vivaro Box 2.5 CDTI,	08/06→	G9U 630 Euro 4	4cyl. 2464cc	84-107kW (114-146PS)	51
Vivaro Combi 2.5 CDTI, Vivaro Platform/ Chassis 2.5 CDTI		Diesel Turbo Intercooled			TD20987

Movano Box 2.5 CDTI	10/03→	G9U 632 Euro 4	4cyl. 2464cc	88-107kW (120-146PS)	
Movano Combi 2.5 CDTI,	08/06→	Diesel Turbo Intercooled			TD21014
Movano Dumptruck 2.5 CDTI,					
Movano Platform/Chassis 2.5 CDTI					

Movano Box 2.5 CDTI	10/03→	G9U 650 Euro 4	4cyl. 2464cc	74-88kW (101-120PS)	
Movano Combi 2.5 CDTI,	08/06→	Diesel Turbo Intercooled			TD21012
Movano Dumptruck 2.5 CDTI,					
Movano Platform/Chassis 2.5 CDTI					

08-137500-00	STD	89.00	3.000		007 MO P	KV1
08-137507-00	0.50mm		1.750		005 IFU P	STD
[R66720]			2.500		236 P	GOE12

Movano Box 2.5 DTI, Movano Combi 2.5 DTI,	10/01→	G9U 720 Euro 3	4cyl. 2463cc	85kW (116PS)	52
Movano Dumptruck 2.5 DTI,		Diesel Turbo Intercooled			TD18874
Movano Platform/Chassis 2.5 DTI					

Movano Box 2.5 DTI, Movano Combi 2.5 DTI,	10/01→	G9U 724 Euro 3	4cyl. 2463cc	84kW (114PS)	
Movano Dumptruck 2.5 DTI,		Diesel Turbo Intercooled			TD19367
Movano Platform/Chassis 2.5 DTI					





Vivaro Box 2.5 DTI, Vivaro Combi 2.5 DTI		05/03→	G9U 730 Euro 3			
Vivaro Platform/Chassis 2.5 DTi		08/06→	4cyl.			
			2463cc 99kW (135PS)			
			Diesel Turbo Intercooled			TD18497
Movano Box 2.5 DTI, Movano Combi 2.5 DTI,		10/01→	G9U 754 Euro 3			
Movano Dumptruck 2.5 DTI,			4cyl.			
Movano Platform/Chassis 2.5 DTI			2463cc 84-73kW (115-99PS)			
			Diesel Turbo Intercooled			TD19817
08-137500-10	STD	89.00	2.500		001 IF MO P	KV1
08-137507-10	0.50mm		1.750		005 IFU P	F12/F14
			2.500		231 CR P	GOE12
Blitz 2.1		01/68→12/70	XDP 90			53
			4cyl.			
			2112cc			
			Diesel			FM1425
08-314900-10	STD	90.00	2.000		001 IW CR P	KV1
[R66070]			2.000		001 P	STD
			2.000		023 P	STD
			4.500		231 CR P	STD
Rekord E 2.2 D		08/78→08/86	23 D			54
Rekord E Estate 2.2 D		08/78→08/83	4cyl.			
Rekord E Estate 2.3 D		11/82→08/86	2260cc 48kW (65PS)			
			Diesel			TD2663
08-305400-10	STD	92.00	2.000		001 CR P	KV1
08-305407-10	0.50mm		2.000		005 IF P	STD
08-305411-10	1.00mm		4.000		231 CR P	STD
Frontera A 2.3 TD		03/92→10/98	23 DTR			55
Omega A 2.3 TD Interc.		08/88→03/94	4cyl.			
Omega A Estate 2.3 TD Interc.		09/88→03/94	2260cc 74kW (100PS)			
			Diesel Turbo Intercooled			TD4767
Omega A 2.3 TD		10/86→08/88	23 YDT			
Omega A Estate 2.3 TD		09/86→08/88	4cyl.			
			2260cc 66kW (89PS)			
			Diesel Turbo			TD4769
08-306600-00	STD	92.00	2.500		008 MOL P	KV1
08-306607-00	0.50mm		2.000		005 P	F12/F14
			4.000		231 CR P	STD



Frontera A 2.5 TDS, Frontera A Sport 2.5 TDS		09/96→10/98	25 TDS (VM41B)		56
			4cyl.		
			2500cc	85kW (116PS)	
			Diesel	Turbo Intercooled	TD2673
08-110100-00	STD	92.00	2.500	008 CR P	KV1
[R47730]			2.000	026 P	STD
			4.000	231 CR P	STD
Rekord Sprint		01/67→12/72	19 H		57
			4cyl.		
			1897cc		
					FM5343
Ascona A 1.9 SR		03/71→08/75	19 S		
Ascona A Voyage 1.9 SR		10/70→08/75	4cyl.		
Ascona B 1.9 S		09/75→08/81	1897cc	66kW (89PS)	
GT 1.9		09/68→08/73			
Kadett B Coupe 1.9		08/67→08/73			
Manta A 1.9 S		09/70→08/75			
Manta B 1.9 S		09/75→12/80			
Olympia A Coupe 1.9		08/67→08/71			
Rekord B 1.9		08/65→12/66			
Rekord B Coupe 1.9		08/65→02/67			
Rekord C 1.9, Rekord C Coupe 1.9, Rekord C Estate 1.9		08/66→12/71			TD4756
Rekord C 1.9 Sprint, Rekord C Coupe 1.9 Sprint		08/67→12/71	19 SH		
Rekord D 1.9		03/75→08/77	4cyl.		
Rekord D 1.9 S		01/72→02/75	1897cc	66-78kW (90-107PS)	
Rekord D Coupe 1.9		03/75→08/77			
Rekord D Coupe 1.9 S		01/72→02/75			
Rekord D Estate 1.9		03/75→08/77			
Rekord D Estate 1.9 S		01/72→02/75			TD2640
08-302600-00	STD	93.00	2.000	001 IF CR P	STD
			2.000	026 P	STD
			5.000	236 P	STD
Arena Box 2.5 D, Arena Combi 2.5 D		03/98→08/01	S8U 758		58
			4cyl.		
			2499cc	55-58kW (75-79PS)	
			Diesel		TD22880
Arena Box 2.5 D, Arena Combi 2.5 D		03/98→08/01	S8U 780		
			4cyl.		
			2499cc	55kW (75PS)	
			Diesel		TD22882
08-783300-00	STD	93.00	3.000	001 CR P	KV1
08-783308-00	0.60mm		2.000	026 P	STD
[R47100]			3.000	231 CR P	STD



Movano Box 2.8 DTI	01/99→10/01	S9W 700					
Movano Combi 2.8 DTI	07/98→10/01		4cyl.				59
Movano Dumptruck 2.8 DTI	01/99→10/01		2799cc	84kW	(114PS)		
Movano Platform/Chassis 2.8 DTI	07/98→10/01	Diesel	Turbo Intercooled				TD21149
Movano Box 2.8 DTI	01/99→10/01	S9W 702					
Movano Combi 2.8 DTI	07/98→10/01		4cyl.				
Movano Dumptruck 2.8 DTI	01/99→10/01		2799cc	84kW	(114PS)		
Movano Platform/Chassis 2.8 DTI	07/98→10/01	Diesel	Turbo Intercooled				TD19360
08-122200-00	STD	94.40	2.500		008 CK P		KV1
08-122208-00	0.60mm				005 P		IKA
eng.2572280→					231 CR P		GOE12
<i>[R60070]</i>			2.500				
08-854700-00	STD	94.40	3.000		008 CR		GOE12
08-854708-00	0.60mm				005 IWU P		GOE12
→eng.2572279					231 CR		GOE12
<i>[R49690]</i>			3.000				
Ascona B 2.0 E	08/79→08/81	20 E					60
Ascona C 2.0	09/81→08/83		4cyl.				
Kadett C Coupe 2.0 E Rallye	08/77→07/79		1979cc	81kW	(110PS)		
Manta B 2.0 E, Manta B Cc 2.0 E	08/77→08/88						
Rekord E 2.0 E, Rekord E Estate 2.0 E	09/77→10/84					TD2642	
Ascona B 2.0 N	08/77→08/81	20 N					TD4758
Manta B 2.0, Manta B Cc 2.0	08/77→12/80		4cyl.				
Rekord E 2.0, Rekord E Estate 2.0	09/77→10/82		1979cc	56-66kW	(76-90PS)		
Ascona B 2.0 S	08/77→08/81	20 S					TD4762
Manta B 2.0 S, Manta B Cc 2.0 S	08/77→08/84		4cyl.				
Rekord D 2.0, Rekord D Coupe 2.0,	09/75→08/77		1979cc	74kW	(100PS)		
Rekord D Estate 2.0 S							
Rekord E 2.0 S, Rekord E Estate 2.0 S	08/77→08/86						
Monza A 3.0 GSE	02/78→08/86	30 E					TD4775
Senator A 3.0 E	02/78→12/86		6cyl.	2969cc	132kW	(180PS)	
Monza A 3.0, Senator A 3.0	04/78→07/82	30 H					TD5307
			6cyl.	2968cc	110kW	(150PS)	
Omega A 3.0, Omega A Estate 3.0	03/87→09/90	30 NE					TD4776
Senator B 3.0	01/88→09/90		6cyl.	2969cc	130kW	(177PS)	
		30 S					TD4777
			6cyl.	2968cc	110kW	(150PS)	
Monza A 3.0 GSE	09/85→08/86	C 30 LE					TD4806
Omega A 3.0	03/87→12/87		6cyl.				
Omega A Estate 3.0	03/87→03/94		2969cc	115kW	(156PS)		
Senator A 3.0	09/85→08/87						
Senator B 3.0	09/87→09/93						





Omega A 3.0	03/88→03/94	C 30 NE			
Omega A Estate 3.0 CAT	03/87→03/94		6cyl.		
Senator B 3.0 i CAT	01/88→09/93		2969cc	130kW (177PS)	
					TD2709

08-305000-00	STD	95.00	2.000		001 IF MO P	IKA
08-305007-00	0.50mm		2.000		026 P	STD
[R41350V1]			4.000		712 CR	ST

Monza A 2.2 E, Rekord E 2.2 E,	11/84→08/86	22 E			
Rekord E Estate 2.2 E			4cyl.		
Senator A 2.2 E	11/84→08/87		2197cc	85kW (116PS)	
					61
					TD2659

08-306500-00	STD	95.00	1.750		001 IF MO P	IKA
			1.500		005 IF P	STD
			3.500		712 CR	ST

Frontera A 2.4 i	03/92→10/98	C 24 NE			
Omega A 2.4 i, Omega A Estate 2.4 i	09/88→03/94		4cyl.		
			2410cc	92kW (125PS)	
					62
					TD4803

Omega A 3.0 24V	09/89→03/94	C 30 SE			
Omega A Estate 3.0 24V Omega 3000	09/88→04/94		6cyl.		
Senator B 3.0 24V	09/89→09/93		2969cc	150kW (204PS)	
					TD4807

Omega A 3.0 24V, Omega A Estate 3.0 24V	09/89→03/94	C 30 SEJ			
			6cyl.		
			2969cc	147kW (200PS)	
					TD4808

08-307300-00	STD	95.00	1.500		001 MOL P	KV1
08-307307-00	0.50mm		1.500		026 P	STD
[R49610]			3.000		712 CR	ST

Motorverzeichnis • Index de moteur • Índice de Motor
Indeks silnika • Модель двигателя • دليل المحرك

ENGINE INDEX



CCM

x



9

1G	Diesel	2383	6	76.50	1
96R11EX	Diesel	11900	6	130.00	9
9100-9101	Diesel	7546	6	118.00	4
9152, 9154	Diesel	11946	6	130.00	7
9156.13	Diesel	11945	6	130.00	8
9156.16	Diesel	11945	6	130.00	8
9156.17	Diesel	11945	6	130.00	8
9156.3	Diesel	11945	6	130.00	8
9180	Diesel	11946	6	130.00	8
9222	Diesel	10500	6	120.00	5
CP (D24 engine)	Diesel	2383	6	76.50	2
D2542MTE	Diesel	20911	V12	125.00	6
Super Comet	Diesel		6	107.19	3



						1
1G		6cyl.	2383cc	Diesel Turbo		FM7196
08-109500-00	STD	76.50	1.750		001 IF CR P	KV1
08-109505-00	0.25mm				005 IFU P	STD
08-109507-00	0.50mm		2.000		231 CR P	STD
08-109511-00 08/1987→	1.00mm		3.000			
[R43850]						

						2
CP (D24 engine)		6cyl.	2383cc	Diesel		FM3020
08-405200-00	STD	76.50	1.750		001 IF CR P	KV1
08-405205-00	0.25mm				005 IF P	STD
08-405207-00	0.50mm		2.000		231 CR P	STD
08-405211-00 05/1987→	1.00mm		3.000			

						3
Super Comet		6cyl.			Diesel	FM8957
08-318400-00	STD	107.19	3.000		007 P	IKA
			2.385		005 P	STD
			2.385		026 P	STD
			6.335		231 P	STD
			6.335		031 P	STD

						4
9100-9101		6cyl.	7546cc	125-147kW (170-200PS)	Diesel	FM4930
08-318500-00	STD	118.00	3.000		007 CR P	STD
			3.000		005 P	STD
			3.000		023 P	STD
			6.000		231 CR P	STD
			6.000		032 P	STD

						5
9222		6cyl.	10500cc	165kW (224PS)	Diesel Turbo	TD8456
08-323700-00	STD	120.00	3.000		007 CR P	KV1
			3.000		005 CR P	STD
			3.000		005 CR P	STD
			6.000		231 CR P	STD



6

D2542MTE		V12cyl. 20911cc		Diesel Turbo		FM7096
08-282400-10	STD	125.00	3.500		008 CR	IKA
			3.000		005 IF P	STD
			3.000		026 P	STD
			5.000		231 CR P	STD

7

9152, 9154		6cyl. 11946cc (350PS)		Diesel		FM4929
08-319300-10	STD	130.00	3.000		007 CR P	KV1
			3.000		005 IF	STD
			3.000		023	STD
			6.000		231 CR P	STD

8

9156.13		6cyl. 11945cc 228kW (310PS)		Diesel Turbo		TD8437
9156.16		6cyl. 11945cc 206kW (280PS)		Diesel Turbo		TD8436
9156.17		6cyl. 11945cc 228kW (310PS)		Diesel Turbo		TD8450
9156.3		6cyl. 11945cc 259kW (352PS)		Diesel Turbo		TD8445
9180		6cyl. 11946cc 250kW (340PS)		Diesel Turbo Intercooled		TD8438
08-323800-00	STD	130.00	3.000		007 CR P	KV1
			3.000		005 CR P	STD
			3.000		005 IF P	STD
			6.000		231 CR P	STD

9

96R11EX		6cyl. 11900cc (360-400PS)		Diesel		FM8959
08-324400-00	STD	130.00	3.500		008 IF P PS	KV1
01/1986→			3.000		005 IF CR P	STD
			4.000		231 CR P	STD

ENGINE INDEX

Motorverzeichnis • Index de moteur • Índice de Motor
Indeks silnika • Модель двигателя • دليل المحرك



CCM

x



9

3.144	Diesel	2358	3	88.90	3
3.152	Diesel	2490	3	91.49	4
3.177	Diesel	2900	3	98.48	10
4.107	Diesel	1760	4	79.38	1
4.108	Diesel	1760	4	79.39	2
4.165	Diesel	2710	4	92.00	9
4.192	Diesel	3140	4	88.90	3
4.203	Diesel	3335	4	91.49	5
4.212	Diesel	3470	4	98.48	11
4.236	Diesel	3864	4	98.48	12
4.248 / A4.248	Diesel	4065	4	101.054	23
4.256	Diesel		4	111.77	26
4.318	Diesel	5215	4	114.30	27
6.288	Diesel	4716	6	88.90	3
6.305	Diesel	5000	6	91.49	6
6.354	Diesel	5794	6	98.48	13
6.354.1	Diesel	5800	6	98.48	14
6.354.2	Diesel	5794	6	98.48	15
6.354.4	Diesel	5794	6	98.48	16
6.372	Diesel	6372	6	101.05	22
1004.42 Euro 1	Diesel	4230	4	103.00	24
1004-40 / 1004-40T	Diesel	3990	4	100.00	18
1103B-33 Euro 2	Diesel	3300	3	105.00	25
1103C-33 Euro 2	Diesel	3300	3	105.00	25
1104C-44 Euro 2	Diesel	4400	4	105.00	25
AD3.152	Diesel	2499	3	91.49	7
AT4.236	Diesel	3866	4	98.48	17
C4.40	Diesel	3990	4	100.00	19
D3.152	Diesel	2500	3	91.49	8
D235 Phaser 160/180T	Diesel	5985	6	100.00	19
Phaser 90 (1004-4)	Diesel	3990	4	100.00	21
Phaser 110T (1004-4T)	Diesel	3990	4	100.00	20
Phaser 125 (1006-6)	Diesel	5985	6	100.00	21
Phaser 160T (1006-6T) 1989>	Diesel	5985	6	100.00	19
Phaser 180Ti (1006-6TW)	Diesel	5985	6	100.00	20
Phaser 180Ti (CC6.60)	Diesel	5985	6	100.00	20
Phaser 200Ti Euro 1	Diesel	5985	6	100.00	20
T4.236	Diesel	3866	4	98.48	17
T6.354.4	Diesel	5794	6	98.48	17
T6.60	Diesel	5985	6	100.00	20
V8.605	Diesel	9900	8	114.30	27



1

4.107		4cyl.	1760cc	30kW (41PS)	Diesel	TD6333
08-313400-00	STD	79.38	1.990		001 IF CR P	STD
[R34610]	1.600			001 IF P	STD	
	1.600			023 P	STD	
	4.747			231 P	STD	
	4.747			031 P	STD	

2

4.108		4cyl.	1760cc	36kW (49PS)	Diesel	TD6334
08-315200-00	STD	79.39	1.990		001 IF CR P	KV1
[R34590]	1.600			005 IF P	STD	
	1.600			005 IF P	STD	
	3.160			026 P	STD	
	4.747			231 P	STD	

3

3.144		3cyl.	2358cc	22-28kW (30-38PS)	Diesel	TD6787
4.192		4cyl.	3140cc	29-37kW (39-50PS)	Diesel	TD6396
6.288		6cyl.	4716cc	45kW (61PS)	Diesel	TD6498
08-317200-00	STD	88.90	2.385		001 IW CR P	STD
	2.385			001 IW P	STD	
	3.160			023 P	STD	
	6.335			231 P	STD	
	6.335			031 P	STD	



4

3.152	3cyl.	2490cc	22-33kW (30-45PS)	Diesel	Indirect Injection	TD6788
08-313100-00 STD 01/1960→	91.49	2.385		001 IW CR P	STD	
		2.385		001 P	STD	
		2.385		023 P	STD	
		6.335		231 P	STD	
		6.335		031 P	STD	
08-314600-00 STD 01/1960→ eng.1935854→ [R34560K]	91.49	2.385		001 IW CR P	STD	
		2.385		005 IF P	STD	
		3.160		026 P	STD	
		6.335		231 P	STD	
		6.335		031 P	STD	
08-322000-00 STD [R34510K]	91.49	2.385		001 CR P	IKA	
		2.385		005 IW P	STD	
		2.385		005 IW P	STD	
		4.747		231 CR P	STD	
08-525100-00 STD [R34550]	91.49	2.385		001 P	GOE12	
		2.385		005 P	GOE12	
		3.160		026 P	GOE12	
		6.350		030	GOE12	
		6.350		030	GOE12	

Not for chromed cylinders

Nicht für verchromte Zylinder

Non appropriés pour cylindres chromés

No se usan para cilindros cromados



4.203		4cyl.	3335cc	44kW (60PS)	Diesel	Direct Injection	TD7381
08-313100-00 STD 01/1960→	91.49		2.385		001 IW CR P		STD
			2.385		001 P		STD
			2.385		023 P		STD
			6.335		231 P		STD
			6.335		031 P		STD
08-314600-00 STD 01/1960→ eng.2939037→ <i>[R34560K]</i>	91.49		2.385		001 IW CR P		STD
			2.385		005 IF P		STD
			3.160		026 P		STD
			6.335		231 P		STD
			6.335		031 P		STD
08-322000-00 STD <i>[R34510K]</i>	91.49		2.385		001 CR P		IKA
			2.385		005 IW P		STD
			2.385		005 IW P		STD
			4.747		231 CR P		STD
08-525100-00 STD <i>[R34550]</i>	91.49		2.385		001 P		GOE12
			2.385		005 P		GOE12
			3.160		026 P		GOE12
			6.350		030		GOE12
			6.350		030		GOE12

Not for chromed cylinders

Nicht für verchromte Zylinder

Non appropriés pour cylindres chromés

No se usan para cilindros cromados



6

6.305	6cyl.	5000cc	Diesel		FM9000
08-313100-00 STD 01/1960→	91.49	2.385		001 IW CR P	STD
		2.385		001 P	STD
		2.385		023 P	STD
		6.335		231 P	STD
		6.335		031 P	STD
08-314600-00 STD 01/1960→ [R34560K]	91.49	2.385		001 IW CR P	STD
		2.385		005 IF P	STD
		3.160		026 P	STD
		6.335		231 P	STD
		6.335		031 P	STD

Not for chromed cylinders

Nicht für verchromte Zylinder

Non appropriés pour cylindres chromés

No se usan para cilindros cromados

7

AD3.152	3cyl.	2499cc	Diesel	Direct Injection	FM11352
08-322000-00 STD [R34510K]	91.49	2.385		001 CR P	IKA
		2.385		005 IW P	STD
		2.385		005 IW P	STD
		4.747		231 CR P	STD

Not for chromed cylinders

Nicht für verchromte Zylinder

Non appropriés pour cylindres chromés

No se usan para cilindros cromados



8

D3.152		3cyl.	2500cc		Diesel	Direct Injection	FM1352
08-314600-00 STD 01/1960→ eng.2939037→ [R34560K]		91.49	2.385		001 IW CR P		STD
			2.385		005 IF P		STD
			3.160		026 P		STD
			6.335		231 P		STD
			6.335		031 P		STD
08-322000-00 STD [R34510K]		91.49	2.385		001 CR P		IKA
			2.385		005 IW P		STD
			2.385		005 IW P		STD
			4.747		231 CR P		STD
08-525100-00 STD [R34550]		91.49	2.385		001 P		GOE12
			2.385		005 P		GOE12
			3.160		026 P		GOE12
			6.350		030		GOE12
			6.350		030		GOE12

Not for chromed cylinders

Nicht für verchromte Zylinder

Non appropriés pour cylindres chromés

No se usan para cilindros cromados

9

4.165		4cyl.	2710cc	47-51kW (65-70PS)	Diesel		TD6734
08-399600-10 STD		92.00	2.000		001 IF CR P		KV1
			2.500		005 IF		STD
			4.000		231 CR P		STD

10

3.177		3cyl.	2900cc		Diesel		FM8534
08-318900-10 STD 08-318905-10 0.25mm [R34740/2K]		98.48	2.385		001 IF CR P		KV1
			2.385		005 IW P		STD
			4.747		231 CR P		STD

11

4.212		4cyl.	3470cc		Diesel		FM1359
08-322100-00 STD →eng.87000 [R34680K]		98.48	2.385		001 CR P		IKA
			2.385		005 IW P		STD
			2.385		001 P		STD
			6.335		231 CR P		STD



12

4.236		4cyl.	3864cc	65kW (88PS)	Diesel	TD6398
08-107200-00	STD	98.48	2.385		001 IF CR P	STD
08-107209-00	.030		2.385		001 IF P	STD
01/1961→			2.385		023 P	STD
[R34760K]			6.335		231 CR P	STD
			6.335		031 P	STD
08-315000-10	STD	98.48	2.385		001 IF CR P	STD
08-315007-10	0.50mm		2.385		001 IF P	STD
01/1961→			2.385		023 P	STD
[R39140]			6.335		231 P	STD
			6.335		031 P	STD
08-325000-00	STD	98.48	2.385		001 IF CR P	IKA
01/1961→			2.385		005 IF P	STD
			2.385		005 IF P	STD
			4.747		231 CR P	STD
			4.747		031 P	STD



6.354		6cyl.	5794cc	71-82kW (97-112PS)	Diesel	TD6713
08-107200-00	STD	98.48	2.385		001 IF CR P	STD
08-107209-00	.030		2.385		001 IF P	STD
01/1961→			2.385		023 P	STD
[R34760K]			6.335		231 CR P	STD
			6.335		031 P	STD
08-318900-10	STD	98.48	2.385		001 IF CR P	KV1
08-318905-10	0.25mm		2.385		005 IW P	STD
[R34740/2K]			4.747		231 CR P	STD
08-325000-00	STD	98.48	2.385		001 IF CR P	IKA
01/1961→			2.385		005 IF P	STD
			2.385		005 IF P	STD
			4.747		231 CR P	STD
			4.747		031 P	STD
08-525200-00	STD	98.48	2.385		001 CR P	GOE12
08-525209-00	.030		2.385		001 IW P	GOE12
[R34770K]			2.385		001 IW P	GOE12
			6.350		030 P	GOE12
			6.350		030 P	GOE12



6.354.1		6cyl.	5800cc	Diesel		FM5218
08-101000-00 ¹ STD [R34690/3K]		98.48	3.160		001 CR P	KV1
			2.385		001 IF P	STD
			2.385		023 P	STD
			6.335		231 P	STD
			6.335		031 P	STD
08-107200-00 STD 08-107209-00 .030 01/1961→ [R34760K]		98.48	2.385		001 IF CR P	STD
			2.385		001 IF P	STD
			2.385		023 P	STD
			6.335		231 CR P	STD
			6.335		031 P	STD
08-315000-10 STD 08-315007-10 0.50mm [R39140]		98.48	2.385		001 IF CR P	STD
			2.385		001 IF P	STD
			2.385		023 P	STD
			6.335		231 P	STD
			6.335		031 P	STD
08-525200-00 STD 08-525209-00 .030 [R34770K]		98.48	2.385		001 CR P	GOE12
			2.385		001 IW P	GOE12
			2.385		001 IW P	GOE12
			6.350		030 P	GOE12
			6.350		030 P	GOE12

¹ For Cast Iron Bores only

¹ Nur für Gußeisenbohrungen

¹ Pour intérieur cylindre seulement

¹ Para diámetro internos de hierro fundido solamente



15

6.354.2		6cyl.	5794cc	84-87kW (114-118PS)	Diesel	TD6548
08-101000-00 ¹ STD [R34690/3K]		98.48	3.160		001 CR P	KV1
			2.385		001 IF P	STD
			2.385		023 P	STD
			6.335		231 P	STD
			6.335		031 P	STD
08-315000-10 STD 08-315007-10 0.50mm [R39140]		98.48	2.385		001 IF CR P	STD
			2.385		001 IF P	STD
			2.385		023 P	STD
			6.335		231 P	STD
			6.335		031 P	STD
08-319000-10 STD 08-319005-10 0.25mm [R44030]		98.48	3.160		008 MO P	KV1
			2.385		005 IW P	STD
			4.747		231 CR P	STD

¹ For Cast Iron Bores only ¹ Nur für Gußeisenbohrungen ¹ Pour intérieur cylindre seulement ¹ Para diámetro internos de hierro fundido solamente

16

6.354.4		6cyl.	5794cc	94kW (128PS)	Diesel	TD6546
08-315000-10 STD 08-315007-10 0.50mm [R39140]		98.48	2.385		001 IF CR P	STD
			2.385		001 IF P	STD
			2.385		023 P	STD
			6.335		231 P	STD
			6.335		031 P	STD
08-318900-10 STD 08-318905-10 0.25mm [R34740/2K]		98.48	2.385		001 IF CR P	KV1
			2.385		005 IW P	STD
			4.747		231 CR P	STD
08-525200-00 STD 08-525209-00 .030 [R34770K]		98.48	2.385		001 CR P	GOE12
			2.385		001 IW P	GOE12
			2.385		001 IW P	GOE12
			6.350		030 P	GOE12
			6.350		030 P	GOE12

17

AT4.236		4cyl.	3866cc		Diesel Turbo	FM13911
T4.236		4cyl.	3866cc	66-76kW (90-103PS)	Diesel Turbo	TD6746
T6.354.4		6cyl.	5794cc	110-119kW (150-162PS)	Diesel Turbo	TD8703
08-319000-10	STD	98.48	3.160		008 MO P	KV1
08-319005-10	0.25mm		2.385		005 IW P	STD
[R44030]			4.747		231 CR P	STD

18

1004-40 / 1004-40T		4cyl.	3990cc	48-52kW (65-71PS)	Diesel	TD20891
08-422100-00	STD	100.00	3.500		008 CK P	KV1
			2.500		026 P	F12/F14
			3.500		231 CR P	STD

19

C4.40		4cyl.	3990cc	88kW (120PS)	Diesel Turbo Intercooled	FM5069
D235 Phaser 160/180T		6cyl.	5985cc	118-132kW (160-180PS)	Diesel Turbo	TD6412
Phaser 160T (1006-6T) 1989>		6cyl.	5985cc	119kW (162PS)	Diesel Turbo	TD6547
08-324300-00	STD	100.00	3.000		008 MO P	KV1
01/1989→			2.500		005 P	STD
[R43840]			4.000		231 CR P	STD

20

Phaser 110T (1004-4T)		4cyl.	3990cc	82kW (111PS)	Diesel Turbo	TD8659
Phaser 180Ti (1006-6TW)		6cyl.	5985cc	134kW (182PS)	Diesel Turbo	TD6404
Phaser 180Ti (CC6.60)		6cyl.	5985cc	131-134kW (177-182PS)	Diesel Turbo Intercooled	TD8922
Phaser 200Ti Euro 1		6cyl.	5985cc	148kW (201PS)	Diesel Turbo	FM6366
T6.60		6cyl.	5985cc	154kW (210PS)	Diesel Turbo	FM6365
08-325600-00	STD	100.00	3.500		008 IW MO P	KV1
01/1992→			2.500		026 P	STD
[R48830]			4.000		231 CR P	STD

21

Phaser 125 (1006-6)		6cyl.	5985cc		Diesel	FM5073
Phaser 90 (1004-4)		4cyl.	3990cc		Diesel	FM5072
08-101700-00	STD	100.00	2.500		001 IF MO	KV1
[R43830]			2.500		005 P	STD
			4.000		231 CR P	STD



6.372							22
		6cyl.	6372cc	Diesel		FM8787	
08-318000-10	STD	101.05	2.385		001 IF CR P	IKA	
[R27350/3K]	2.385			005 IF P	STD		
	2.385			005	STD		
	6.335			231 CR P	STD		

4.248 / A4.248							23
		4cyl.	4065cc	53-61kW (72-83PS)	Diesel	Direct Injection	FM26364
08-318000-10	STD	101.054	2.385		001 IF CR P	IKA	
[R27350/3K]	2.385			005 IF P	STD		
	2.385			005	STD		
	6.335			231 CR P	STD		
08-322700-00	STD	101.054	2.500		001 IW MO P	KV1	
[R39910]	2.500			023 IF P	STD		
	5.000			231 CR P	STD		

1004.42 Euro 1							24
		4cyl.	4230cc	45-51kW (61-69PS)	Diesel	TD23905	
08-425400-00	STD	103.00	2.500		008 CK P	KV1	
08-425407-00	0.50mm		2.500		026 P	F12/F14	
08-425411-00	1.00mm		3.500		231 CR P	GOE12	

1103B-33 Euro 2							25
		3cyl.	3300cc	43kW (58PS)	Diesel	TD23904	
1103C-33 Euro 2							TD17273
		3cyl.	3300cc	41kW (55PS)	Diesel		
1104C-44 Euro 2							TD17275
		4cyl.	4400cc	64kW (87PS)	Diesel		
08-426200-00	STD	105.00	3.500		008 CK P	KV1	
			2.500		005 IFU P	IKA	
			3.500		231 CR P	STD	

4.256							26
		4cyl.	Diesel		FM8535		
08-202400-10	STD	111.77	2.385		001 IW CR P	KV1	
08-202407-10	.020		2.385		001 IW P	STD	
08-202409-10	.030		2.385		023 P	STD	
[R31640/2K/V2]			4.747		231 CR P	STD	



27

4.318 4cyl. 5215cc Diesel FM1377

V8.605 8cyl. 9900cc Diesel FM1378

08-322300-00	STD	114.30	2.385		001 IF CR P	IKA
			2.385		005 P	STD
			2.385		005 P	STD
			6.335		231 CR P	STD

Modelverzeichnis • Index de modele • Índice de Modelo
 Indeks modelu • Модель автомобиля • دليل الموديل

MODEL INDEX

CCM
x

9

03/00→12/04	06 Coupe	DW12TED4 (4HZ)	Diesel	2179	4	37
10/72→10/79	104 0.9	XV3	Petrol	954	4	3
10/79→10/83	104 0.9	XV5	Petrol	954	4	3
09/83→06/88	104 1.0	XV8 (108C)	Petrol	954	4	3
09/78→09/79	104 1.1	XW3S	Petrol	1124	4	7
08/80→06/88	104 1.1	XW7 (109F)	Petrol	1124	4	7
08/79→06/83	104 1.2	XZ5 (129)	Petrol	1219	4	15
08/79→06/83	104 1.4	XY6B (150)	Petrol	1360	4	15
09/73→10/83	104 Coupe 0.9	XV3	Petrol	954	4	3
09/73→10/83	104 Coupe 0.9	XV5	Petrol	954	4	3
09/73→09/79	104 Coupe 1.1	XW3S	Petrol	1124	4	7
08/75→06/80	104 Coupe 1.1	XW3S (121)	Petrol	1124	4	7
08/79→06/88	104 Coupe 1.1	XW7 (109F)	Petrol	1124	4	7
08/79→06/84	104 Coupe 1.4	XY6B (150)	Petrol	1360	4	15
09/91→	106 1.4 i Le Mans	TU3 F (Cast Iron Block), TU3 F2 (Cast Iron Block), TU3 F2C (Cast Iron Block), TU3 FJ2 (Cast Iron Block), TU3 FM (Cast Iron Block)	Petrol	1360	4	12
09/91→	106 1.4 i XSI	TU3 F (Cast Iron Block), TU3 F2 (Cast Iron Block), TU3 F2C (Cast Iron Block), TU3 FJ2 (Cast Iron Block), TU3 FM (Cast Iron Block)	Petrol	1360	4	12
09/91→	106 1.4i	TU3 F (Cast Iron Block), TU3 F2 (Cast Iron Block), TU3 F2C (Cast Iron Block), TU3 FJ2 (Cast Iron Block), TU3 FM (Cast Iron Block)	Petrol	1360	4	12
09/91→04/96	106 I 1.0	TU9	Petrol	954	4	2
09/91→04/96	106 I 1.0	TU9M (CDY)	Petrol	954	4	2
09/91→04/96	106 I 1.0	TU9M (CDZ)	Petrol	954	4	2
09/91→04/96	106 I 1.1	TU1M (HDZ)	Petrol	1124	4	5
09/91→04/96	106 I 1.4	TU3J2 (KFZ)	Petrol	1360	4	12
09/91→04/96	106 I 1.4	TU3M (KDY)	Petrol	1360	4	12
09/91→04/96	106 I 1.4	TU3MC (KDX)	Petrol	1360	4	12
09/92→04/96	106 I 1.4 D	TUD3	Diesel	1360	4	14
06/94→04/96	106 I 1.5 D	TUD5 (VJY)	Diesel	1527	4	17
01/94→04/96	106 I 1.6	TU5J2 (NFW/NFY)	Petrol	1587	4	20
06/93→04/96	106 I 1.6	TU5JP (NFZ)	Petrol	1587	4	20
05/96→	106 II 1.0 i	TU9M (CDY)	Petrol	954	4	2
01/97→	106 II 1.0 i	TU9M (CDZ)	Petrol	954	4	2
05/96→	106 II 1.1 i	TU1JP (HFX)	Petrol	1124	4	6
01/97→	106 II 1.1 i	TU1M (HDY)	Petrol	1124	4	5
05/96→	106 II 1.1 i	TU1M (HDZ)	Petrol	1124	4	5
05/96→	106 II 1.4 i	TU3JP (KFW)	Petrol	1360	4	13
05/96→	106 II 1.4 i	TU3JP (KFX)	Petrol	1360	4	13
10/00→	106 II 1.5 D	TUD5 (VJX)	Diesel	1527	4	17
05/96→	106 II 1.5 D	TUD5 (VJY)	Diesel	1527	4	17
05/96→	106 II 1.6 i	TU5J2 (NFW)	Petrol	1587	4	20
05/96→	106 II 1.6 i	TU5J2 (NFW/NFY)	Petrol	1587	4	20
05/96→	106 II 1.6 i	TU5JP (NFZ)	Petrol	1587	4	20
05/96→	106 II 1.6 S16	TU5J4 (NFX)	Petrol	1587	4	21
09/91→03/01	106 Van 1.0	TU9	Petrol	954	4	2
09/91→03/01	106 Van 1.0	TU9M (CDY)	Petrol	954	4	2
10/00→03/01	106 Van 1.5 D	TUD5 (VJX)	Diesel	1527	4	17
05/96→03/01	106 Van 1.5 D	TUD5 (VJY)	Diesel	1527	4	17
06/05→	107 1.0	1KR (384 F)	Petrol	998	3	4
06/05→	107 1.4 HDi	DV4TD (8HT)	Diesel	1398	4	8
09/75→07/77	204 1.1	XK5	Petrol	1130	4	18
09/73→12/77	204 1.4 D	XL4D	Diesel	1357	4	19
01/73→10/77	204 Break 1.3 D	XL4D	Diesel	1357	4	19
06/91→	205	TU3.2, TU3.2 F, TU3.2 F2	Petrol	1360	4	12

MODEL INDEX

Modelverzeichnis • Index de modele • Índice de Modelo
Indeks modelu • Модель автомобиля • دليل المحرك



CCM

x



9

06/87→12/94	205 1.4	TU3A (K6D)	Petrol	1360	4	12
06/87→12/94	205 1.4	TU3A (K6E)	Petrol	1360	4	12
06/87→12/94	205 1.4	TU3A (K6F)	Petrol	1360	4	12
01/91→	205 1.4 i	TU3 F (Cast Iron Block), TU3 F2 (Cast Iron Block), TU3 F2C (Cast Iron Block), TU3 FJ2 (Cast Iron Block), TU3 FM (Cast Iron Block)	Petrol	1360	4	12
02/83→09/98	205 1.6	XU51C (B1D)	Petrol	1580	4	29
08/87→07/90	205 Box 1.1	TU1 (H1A/H1B/H3A)	Petrol	1124	4	5
03/94→	205 Box 1.7 Diesel	XUD7 (161A)	Diesel	1769	4	23
02/83→07/90	205 Box 1.8 D	XUD7 (A9A)	Diesel	1769	4	23
01/87→	205 GTX	J2	Flexfuel	1592	4	25
02/83→10/87	205 I 1.0	XV8 (108C)	Petrol	954	4	3
02/83→10/87	205 I 1.1	XW7 (109F)	Petrol	1124	4	7
02/83→10/87	205 I 1.1	XW7 (109N)	Petrol	1124	4	7
02/84→10/87	205 I 1.3	G1 / G2	Petrol	1294	4	16
02/83→10/87	205 I 1.4	XY6B (150)	Petrol	1360	4	15
02/83→10/87	205 I 1.4	XY7 (150D)	Petrol	1360	4	15
02/83→10/87	205 I 1.4	XY7 (150G)	Petrol	1360	4	15
02/83→10/87	205 I 1.4	XY8 (150B)	Petrol	1360	4	15
10/85→10/87	205 I 1.4	XY8 (150H)	Petrol	1360	4	15
08/86→10/87	205 I 1.6	XU5 (B1AA)	Petrol	1580	4	29
08/86→10/87	205 I 1.6	XU5CP (BAZ)	Petrol	1580	4	29
03/87→10/87	205 I 1.6	XU51C (B1A/B1C/B1E)	Petrol	1580	4	29
12/84→10/87	205 I 1.6 GTI	XU5J (180A)	Petrol	1580	4	30
08/83→10/87	205 I 1.7 Diesel	XUD7 (161A)	Diesel	1769	4	23
03/87→10/87	205 I 1.9 GTI	XU9J1 (DFZ)	Petrol	1905	4	30
10/86→10/87	205 I 1.9 GTI	XU9JA (D6B)	Petrol	1905	4	30
10/89→12/94	205 I Convertible 1.1 CJ	TU1M (HDZ)	Petrol	1124	4	5
08/87→06/94	205 I Convertible 1.4	TU3S (K2B)	Petrol	1360	4	12
03/89→12/94	205 I Convertible 1.4 CJ	TU3A (K1D)	Petrol	1360	4	12
05/91→12/94	205 I Convertible 1.4 CJ	TU3M (KDY)	Petrol	1360	4	12
05/91→12/94	205 I Convertible 1.4 CJ	TU3M (KDZ)	Petrol	1360	4	12
03/88→05/89	205 I Convertible 1.4 CJ	XY7 (150D)	Petrol	1360	4	15
03/88→05/89	205 I Convertible 1.4 CJ	XY7 (150G)	Petrol	1360	4	15
01/89→09/93	205 I Convertible 1.4 CJ CAT	TU3CP (KAY)	Petrol	1360	4	12
04/86→12/88	205 I Convertible 1.4 CT	XY8 (150B)	Petrol	1360	4	15
04/86→12/88	205 I Convertible 1.4 CT	XY8 (150H)	Petrol	1360	4	15
04/86→10/90	205 I Convertible 1.6 CTI	XU5J (180)	Petrol	1580	4	30
04/86→10/90	205 I Convertible 1.6 CTI	XU5J (180A)	Petrol	1580	4	30
05/86→07/87	205 I Convertible 1.9	XU9J1 (DFZ)	Petrol	1905	4	30
08/87→12/94	205 I Convertible 1.9 CTi	XU9J1 (DFZ)	Petrol	1905	4	30
10/87→09/98	205 II 1.0	TU9	Petrol	954	4	2
08/92→05/97	205 II 1.0	TU9M (CDZ)	Petrol	954	4	2
10/87→10/90	205 II 1.1	TU1 (H1A/H1B/H3A)	Petrol	1124	4	5
07/89→09/98	205 II 1.1	TU1M (HDZ)	Petrol	1124	4	5
10/87→10/90	205 II 1.1	XW7 (109N)	Petrol	1124	4	7
07/87→10/88	205 II 1.1 XA	E1	Petrol	1118	4	9
01/87→12/90	205 II 1.2	F1	Petrol	1118	4	9
08/90→07/92	205 II 1.3	G1 / G2	Petrol	1294	4	16
10/87→10/90	205 II 1.3 Rallye	TU2.4	Petrol	1294	4	12
10/87→10/90	205 II 1.4	TU3A (K1D)	Petrol	1360	4	12
07/88→09/98	205 II 1.4	TU3JP (KFX)	Petrol	1360	4	13
07/88→09/98	205 II 1.4	TU3M (KDY)	Petrol	1360	4	12
07/88→09/98	205 II 1.4	TU3M (KDZ)	Petrol	1360	4	12
08/90→07/98	205 II 1.4	TU3MC (KDX)	Petrol	1360	4	12
06/87→12/89	205 II 1.4	TU3S (K2B)	Petrol	1360	4	12
01/87→07/88	205 II 1.4	XY6B (150)	Petrol	1360	4	15
10/87→05/89	205 II 1.4	XY7 (150D)	Petrol	1360	4	15
10/87→05/89	205 II 1.4	XY7 (150G)	Petrol	1360	4	15



CCM

x



9

07/88→05/89	205 II 1.4	XY8 (150B)	Petrol	1360	4	15
07/88→05/89	205 II 1.4	XY8 (150H)	Petrol	1360	4	15
08/87→09/93	205 II 1.4 CAT	TU3CP (KAY)	Petrol	1360	4	12
10/87→09/98	205 II 1.6	XU5 (B1AA)	Petrol	1580	4	29
10/87→09/98	205 II 1.6	XU5CP (BAZ)	Petrol	1580	4	29
08/90→07/92	205 II 1.6	XU5S (171)	Petrol	1580	4	29
10/87→09/98	205 II 1.6	XU51C (B1A/B1C/B1E)	Petrol	1580	4	29
10/87→12/89	205 II 1.6 GTI	XU5J (180)	Petrol	1580	4	30
10/87→12/89	205 II 1.6 GTI	XU5J (180A)	Petrol	1580	4	30
07/87→09/98	205 II 1.7 Diesel	XUD7 (161A)	Diesel	1769	4	23
01/90→09/98	205 II 1.8 TD	XUD7TE (A8B)	Diesel	1769	4	24
08/90→05/97	205 II 1.8 XDT	XUD7T	Diesel	1769	4	24
08/92→05/97	205 II 1.9	XU9J1 (DFZ)	Petrol	1905	4	30
08/90→05/97	205 II 1.9	XU9JAZ (DKZ)	Petrol	1905	4	30
10/87→09/98	205 II 1.9 Diesel	XUD9 (DJZ)	Diesel	1905	4	32
10/87→09/98	205 II 1.9 GTI	XU9JA (D6B)	Petrol	1905	4	30
10/87→10/94	205 II 1.9 GTI	XU9JAZ (DKZ)	Petrol	1905	4	30
10/87→05/89	205 II 1.9 GTI	XU92C (D2A)	Petrol	1905	4	30
10/87→07/94	205 II 1.9 GTI CAT	XU9J1 (DFZ)	Petrol	1905	4	30
01/02→	206 1.4 TD	DV4TED4 (8HY)	Diesel	1399	4	8
03/00→	206 1.6i 16V	TU5JP4 (N6A)	Petrol	1587	4	20
09/00→	206 CC 1.6 16V	TU5JP4 (NFU/N6A)	Petrol	1587	4	21
04/05→	206 CC 1.6 HDi 110	DV6TED4 (9HZ) Euro 4	Diesel	1560	4	10
09/98→	206 Hatchback 1.1 i	TU1JP (HFZ)	Petrol	1124	4	6
09/98→	206 Hatchback 1.1 i	TU1JP (HFZ)	Petrol	1124	4	6
09/02→02/07	206 Hatchback 1.4 HDi	DV4TD (8HX)	Diesel	1399	4	8
09/01→	206 Hatchback 1.4 HDi eco 70	DV4TD (8HX)	Diesel	1399	4	8
09/01→	206 Hatchback 1.4 HDi eco 70	DV4TD (8HZ)	Diesel	1398	4	8
09/98→	206 Hatchback 1.4 i	TU3JP (KFW)	Petrol	1360	4	13
09/98→	206 Hatchback 1.4 i	TU3JP (KFX)	Petrol	1360	4	13
05/06→09/07	206 Hatchback 1.4 LPG	TU3JP-L4	Petrol	1360	4	13
12/00→	206 Hatchback 1.6 16V	TU5JP4 (NFU/N6A)	Petrol	1587	4	21
05/04→	206 Hatchback 1.6 HDi 110	DV6TED4 (9HY) Euro 4	Diesel	1560	4	10
05/04→	206 Hatchback 1.6 HDi 110	DV6TED4 (9HZ) Euro 4	Diesel	1560	4	10
09/98→12/00	206 Hatchback 1.6 i	TU5JP (NFZ)	Petrol	1587	4	20
09/98→11/01	206 Hatchback 1.9 D	DW8 (WJZ)	Diesel	1868	4	27
12/99→	206 Hatchback 2.0 HDi 90	DW10TD (RHY)	Diesel	1997	4	37
03/07→	206 Saloon 1.4	TU3A (KFW)	Petrol	1360	4	12
03/07→	206 Saloon 1.4	TU3JP (KFW)	Petrol	1360	4	13
09/08→	206 Saloon 1.4 HDi eco 70	DV4TD (8HZ)	Diesel	1398	4	8
03/07→	206 Saloon 1.6 16V	TU5JP4 (NFU/N6A)	Petrol	1587	4	21
07/02→	206 SW 1.1	TU1JP (HFZ)	Petrol	1124	4	6
07/02→	206 SW 1.4	TU3A (KFW)	Petrol	1360	4	12
07/02→	206 SW 1.4	TU3JP (KFW)	Petrol	1360	4	13
07/02→	206 SW 1.4 HDi	DV4TD (8HX)	Diesel	1399	4	8
07/02→	206 SW 1.6 16V	TU5JP4 (NFU/N6A)	Petrol	1587	4	21
05/04→	206 SW 1.6 HDi 110	DV6TED4 (9HZ) Euro 4	Diesel	1560	4	10
07/02→	206 SW 2.0 HDi	DW10TD (RHY)	Diesel	1997	4	37
09/01→03/09	206 Van 1.4 HDi	DV4TD (8HX)	Diesel	1399	4	8
09/01→03/09	206 Van 1.4 HDi	DV4TD (8HZ)	Diesel	1398	4	8
04/99→05/07	206 Van 1.9 D	DW8 (WJZ)	Diesel	1868	4	27
01/09→	206+ 1.1	TU1JP (HFZ)	Petrol	1124	4	6
01/09→	206+ 1.4 HDi eco 70	DV4TD (8HX)	Diesel	1399	4	8
01/09→	206+ 1.4 HDi eco 70	DV4TD (8HZ)	Diesel	1398	4	8
09/10→	206+ 1.4 i	TU3A (KFT)	Petrol	1360	4	12
01/09→	206+ 1.4 i	TU3A (KFW)	Petrol	1360	4	12
01/09→	206+ 1.4 i	TU3A (KFW)	Petrol	1360	4	12
02/06→	207 1.4	TU3A (KFW)	Petrol	1360	4	12
08/08→	207 1.4	TU3A (KFW)	Petrol	1360	4	12
02/06→	207 1.4 HDi	DV4TD (8HZ)	Diesel	1398	4	8

MODEL INDEX

Modelverzeichnis • Index de modele • Índice de Modelo
Indeks modelu • Модель автомобиля • دليل الموديل



CCM

x



9

02/06→	207 1.6 16V	TU5JP4 (NFU/N6A)	Petrol	1587	4	21
02/06→	207 1.6 HDi	DV6ATED4 (9HV)	Diesel	1560	4	10
02/06→	207 1.6 HDi	DV6ATED4 (9HX) Euro 4	Diesel	1560	4	10
11/09→	207 1.6 HDi	DV6DTEd (9HP) Euro 4	Diesel	1560	4	11
11/09→	207 1.6 HDi	DV6DTEdM (9HJ) Euro 4	Diesel	1560	4	11
11/09→	207 1.6 HDi	DV6ETEdM (9HK) Euro 4	Diesel	1560	4	11
02/06→	207 1.6 HDi	DV6TEd4 (9HY) Euro 4	Diesel	1560	4	10
02/06→	207 1.6 HDi	DV6TEd4 (9HZ) Euro 4	Diesel	1560	4	10
08/09→	207 1.6 HDi 110	DV6TEd4 (9HZ) Euro 4	Diesel	1560	4	10
08/09→	207 CC 1.6 HDi	DV6C (9HR)	Diesel	1560	4	11
02/07→	207 CC 1.6 HDi	DV6TEd4 (9HZ) Euro 4	Diesel	1560	4	10
12/07→	207 Saloon 1.4	TU3A (KFV)	Petrol	1360	4	12
11/08→	207 Saloon 1.4 Bioflex	TU3A (KFW)	Petrol	1360	4	12
06/07→	207 SW 1.4	TU3A (KFV)	Petrol	1360	4	12
06/07→	207 SW 1.6 HDi	DV6ATED4 (9HX) Euro 4	Diesel	1560	4	10
08/09→	207 SW 1.6 HDi	DV6C (9HR)	Diesel	1560	4	11
11/09→	207 SW 1.6 HDi	DV6DTEd (9HP) Euro 4	Diesel	1560	4	11
11/09→	207 SW 1.6 Hdi	DV6DTEdM (9HJ) Euro 4	Diesel	1560	4	11
11/09→	207 SW 1.6 Hdi	DV6ETEdM (9HK) Euro 4	Diesel	1560	4	11
06/07→	207 SW 1.6 HDi	DV6TEd4 (9HZ) Euro 4	Diesel	1560	4	10
04/07→	207 Van 1.4 HDi	DV4TD (8HZ)	Diesel	1398	4	8
04/07→	207 Van 1.6 HDi	DV6ATED4 (9HX) Euro 4	Diesel	1560	4	10
03/12→	208 1.6 HDi	DV6DTEd (9HP) Euro 4	Diesel	1560	4	11
03/12→	208 1.6 Hdi	DV6DTEdM (9HJ) Euro 4	Diesel	1560	4	11
03/12→	208 1.6 Hdi	DV6ETEdM (9HK) Euro 4	Diesel	1560	4	11
11/12→	301 1.6 HDi 90	DV6DTEd (9HF) Euro 4	Diesel	1560	4	11
08/72→09/75	304 1.3	XL5S	Petrol	1290	4	18
09/72→10/79	304 1.3 GL	XL5	Petrol	1290	4	18
10/76→10/79	304 1.4 D	XL4D	Diesel	1357	4	19
10/76→10/80	304 Break 1.1	XK5	Petrol	1130	4	18
09/70→10/80	304 Break 1.3	XL5	Petrol	1290	4	18
10/76→10/79	304 Break 1.4 D	XL4D	Diesel	1357	4	19
10/82→07/90	305 1.6	XU51C (B1D)	Petrol	1580	4	29
11/77→09/82	305 I 1.3	XL5	Petrol	1290	4	18
11/77→09/82	305 I 1.3	XL5 (118)	Petrol	1290	4	18
11/79→09/82	305 I 1.5	XR5 (142)	Petrol	1472	4	18
05/80→09/82	305 I 1.5	XR5S (117)	Petrol	1472	4	18
11/77→09/82	305 I 1.5 Diesel	XID (149)	Diesel	1548	4	22
08/80→09/82	305 I Break 1.3	XL5 (118)	Petrol	1290	4	18
08/80→09/82	305 I Break 1.5	XR5 (142)	Petrol	1472	4	18
08/80→09/82	305 I Break 1.5 Diesel	XID (149)	Diesel	1548	4	22
11/82→12/88	305 II 1.1	XK5	Petrol	1130	4	18
10/82→08/85	305 II 1.3	XL5 (118)	Petrol	1290	4	18
10/82→08/85	305 II 1.5	XR5 (142)	Petrol	1472	4	18
09/85→07/90	305 II 1.5	XR5A (142)	Petrol	1472	4	18
10/82→07/88	305 II 1.6	XU5 (B1AA)	Petrol	1580	4	29
11/86→12/88	305 II 1.6	XU5CP (BAZ)	Petrol	1580	4	29
10/82→06/88	305 II 1.6	XU5S (171)	Petrol	1580	4	29
11/82→12/88	305 II 1.8 D	XUD7 (161A)	Diesel	1769	4	23
11/86→12/88	305 II 1.9	XU9J1 (DFZ)	Petrol	1905	4	30
10/82→08/85	305 II 1.9	XU92C	Petrol	1905	4	30
10/82→07/88	305 II 1.9 D	XUD9 (162)	Diesel	1905	4	32
10/82→07/88	305 II 1.9 D	XUD9 (D9A)	Diesel	1905	4	32
10/82→08/86	305 II Break 1.3	XL5 (118)	Petrol	1290	4	18
10/82→08/86	305 II Break 1.5	XR5 (142)	Petrol	1472	4	18
09/85→10/86	305 II Break 1.5	XR5A (142)	Petrol	1472	4	18
02/86→12/88	305 II Break 1.6	XU5 (B1AA)	Petrol	1580	4	29
11/86→12/88	305 II Break 1.6	XU5CP (BAZ)	Petrol	1580	4	29
09/83→12/87	305 II Break 1.6	XU5S (171)	Petrol	1580	4	29
11/82→12/88	305 II Break 1.8 D	XUD7 (161A)	Diesel	1769	4	23

Modelverzeichnis • Index de modele • Índice de Modelo
 Indeks modelu • Модель автомобиля • دليل الموديل

MODEL INDEX

CCM
x

9

11/86→12/88	305 II Break 1.9	XU9J1 (DFZ)	Petrol	1905	4	30
09/84→10/87	305 II Break 1.9	XU92C	Petrol	1905	4	30
10/82→12/88	305 II Break 1.9 Diesel	XUD9 (162)	Diesel	1905	4	32
10/82→12/88	305 II Break 1.9 Diesel	XUD9 (D9A)	Diesel	1905	4	32
06/94→05/01	306 1.1	TU1M (HDZ)	Petrol	1124	4	5
06/94→05/01	306 1.4 SL	TU3JP (KFW)	Petrol	1360	4	13
06/94→05/01	306 1.4 SL	TU3JP (KFX)	Petrol	1360	4	13
06/94→05/01	306 1.4 SL	TU3MC (KDX)	Petrol	1360	4	12
06/94→10/00	306 1.6 SR	TU5JP (NFZ)	Petrol	1587	4	20
10/95→04/97	306 1.8	XU7JP (LFZ)	Petrol	1761	4	31
03/97→05/01	306 1.8 16V	XU7JP4 (LFY)	Petrol	1761	4	31
06/94→05/01	306 1.8 ST	XU7JP (LFZ)	Petrol	1761	4	31
09/98→05/01	306 1.9 D	DW8 (WJZ)	Diesel	1868	4	27
09/98→05/01	306 1.9 D	DW8B (WJY)	Diesel	1868	4	27
05/93→10/03	306 1.9 D	XUD9A (D9B/DJY)	Diesel	1905	4	33
03/98→05/01	306 1.9 D	XUD9BSD (DHV)	Diesel	1905	4	33
02/94→04/97	306 1.9 D	XUD9TE	Diesel	1905	4	33
06/94→05/01	306 1.9 SLD	XUD9 (DJZ)	Diesel	1905	4	32
06/94→05/01	306 1.9 SLD	XUD9A (DJY)	Diesel	1905	4	32
06/94→05/01	306 1.9 SRDT	XUD9TE (DHY)	Diesel	1905	4	33
02/94→10/95	306 1.9 STD	XUD9	Diesel	1905	4	32
03/97→05/01	306 2.0	XU10J4R (RFV/R6E)	Petrol	1998	4	42
06/99→05/01	306 2.0 HDI 90	DW10TD (RHY)	Diesel	1997	4	37
06/94→05/01	306 2.0 S16	XU10J4 (RFT)	Petrol	1998	4	42
06/94→05/01	306 2.0 S16	XU10J4 (RFT/RFY)	Petrol	1998	4	42
07/94→05/01	306 2.0 ST	XU10J2 (RFX)	Petrol	1998	4	42
03/97→04/02	306 Break 1.4	TU3JP (KFW)	Petrol	1360	4	13
03/97→04/02	306 Break 1.4	TU3JP (KFX)	Petrol	1360	4	13
03/97→10/00	306 Break 1.6	TU5JP (NFZ)	Petrol	1587	4	20
03/97→04/02	306 Break 1.8	XU7JP (LFZ)	Petrol	1761	4	31
03/97→04/02	306 Break 1.8 16V	XU7JP4 (LFY)	Petrol	1761	4	31
09/98→04/02	306 Break 1.9 D	DW8 (WJZ)	Diesel	1868	4	27
09/98→04/02	306 Break 1.9 D	DW8B (WJY)	Diesel	1868	4	27
03/97→04/02	306 Break 1.9 D	XUD9A (DJY)	Diesel	1905	4	32
03/98→04/02	306 Break 1.9 D	XUD9BSD (DHV)	Diesel	1905	4	33
02/97→04/02	306 Break 1.9 TD	XUD9TE (DHY)	Diesel	1905	4	33
03/97→04/02	306 Break 2.0	XU10J4R (RFV/R6E)	Petrol	1998	4	42
06/99→04/02	306 Break 2.0 HDI 90	DW10TD (RHY)	Diesel	1997	4	37
04/96→10/00	306 Convertible 1.6	TU5JP (NFZ)	Petrol	1587	4	20
03/94→04/02	306 Convertible 1.8	XU7JP (LFZ)	Petrol	1761	4	31
07/00→04/02	306 Convertible 1.8 16V	XU7JP4 (LFY)	Petrol	1761	4	31
03/94→04/02	306 Convertible 2.0	XU10J2 (RFX)	Petrol	1998	4	42
03/97→04/02	306 Convertible 2.0 16V	XU10J4R (RFV/R6E)	Petrol	1998	4	42
05/93→05/01	306 Hatchback 1.1	TU1M (HDZ)	Petrol	1124	4	5
05/93→05/01	306 Hatchback 1.4	TU3JP (KFW)	Petrol	1360	4	13
05/93→05/01	306 Hatchback 1.4	TU3JP (KFX)	Petrol	1360	4	13
05/93→05/01	306 Hatchback 1.4	TU3MC (KDX)	Petrol	1360	4	12
05/93→10/00	306 Hatchback 1.6	TU5JP (NFZ)	Petrol	1587	4	20
05/93→05/01	306 Hatchback 1.8	XU7JP (LFZ)	Petrol	1761	4	31
03/97→05/01	306 Hatchback 1.8 16V	XU7JP4 (LFY)	Petrol	1761	4	31
05/93→05/01	306 Hatchback 1.8 D	XUD7 (A9A)	Diesel	1769	4	23
09/98→05/01	306 Hatchback 1.9 D	DW8 (WJZ)	Diesel	1868	4	27
09/98→05/01	306 Hatchback 1.9 D	DW8B (WJY)	Diesel	1868	4	27
04/93→05/99	306 Hatchback 1.9 D	XUD9	Diesel	1905	4	32
05/93→05/01	306 Hatchback 1.9 D	XUD9 (DJZ)	Diesel	1905	4	32
06/94→05/01	306 Hatchback 1.9 D	XUD9A (DJY)	Diesel	1905	4	32
03/98→05/01	306 Hatchback 1.9 D	XUD9BSD (DHV)	Diesel	1905	4	33
04/93→04/97	306 Hatchback 1.9 D	XUD9TE	Diesel	1905	4	33
05/93→05/01	306 Hatchback 1.9 DT	XUD9TE (DHY)	Diesel	1905	4	33
03/97→05/01	306 Hatchback 2.0 16V	XU10J4R (RFV/R6E)	Petrol	1998	4	42

MODEL INDEX

Modelverzeichnis • Index de modele • Índice de Modelo
 Indeks modelu • Модель автомобиля • دليل الموديل

CCM
x

9

06/99→05/01	306 Hatchback 2.0 HDI 90	DW10TD (RHY)	Diesel	1997	4	37
06/94→05/01	306 Hatchback 2.0 S16	XU10J4 (RFT)	Petrol	1998	4	42
05/93→05/01	306 Hatchback 2.0 S16	XU10J4 (RFT/RFY)	Petrol	1998	4	42
05/93→05/01	306 Hatchback 2.0 XSi	XU10J2 (RFX)	Petrol	1998	4	42
02/94→04/99	306 Van 1.9 D	XUD9TE	Diesel	1905	4	33
02/94→10/95	306 Van 1.9 STD	XUD9	Diesel	1905	4	32
08/00→	307 1.4	TU3JP (KFW)	Petrol	1360	4	13
10/01→	307 1.4 HDi	DV4TD (8HX)	Diesel	1399	4	8
10/01→	307 1.4 HDi	DV4TD (8HZ)	Diesel	1398	4	8
01/02→	307 1.4 TD	DV4TED4 (8HY)	Diesel	1399	4	8
08/00→	307 1.6 16V	TU5JP4 (NFU/N6A)	Petrol	1587	4	21
09/07→	307 1.6 BioFlex	TU5JP4 (NFU/N6A)	Petrol	1587	4	21
04/05→	307 1.6 HDi	DV6ATED4 (9HV)	Diesel	1560	4	10
02/04→	307 1.6 HDi 110	DV6TED4 (9HY) Euro 4	Diesel	1560	4	10
02/04→	307 1.6 HDi 110	DV6TED4 (9HZ) Euro 4	Diesel	1560	4	10
08/00→	307 2.0 HDi 110	DW10ATED (RHS)	Diesel	1997	4	37
10/03→	307 2.0 HDi 135	DW10BTED4 (RHR)	Diesel	1997	4	37
08/00→	307 2.0 HDi 90	DW10TD (RHY)	Diesel	1997	4	37
04/02→09/03	307 Break 1.4	TU3JP (KFW)	Petrol	1360	4	13
03/02→	307 Break 1.4 HDi	DV4TD (8HZ)	Diesel	1398	4	8
03/02→	307 Break 1.6 16V	TU5JP4 (NFU/N6A)	Petrol	1587	4	21
09/07→	307 Break 1.6 BioFlex	TU5JP4 (NFU/N6A)	Petrol	1587	4	21
04/05→	307 Break 1.6 HDi	DV6ATED4 (9HV)	Diesel	1560	4	10
02/04→	307 Break 1.6 HDi 110	DV6TED4 (9HY) Euro 4	Diesel	1560	4	10
02/04→	307 Break 1.6 HDi 110	DV6TED4 (9HZ) Euro 4	Diesel	1560	4	10
03/02→	307 Break 2.0 HDi 110	DW10ATED (RHS)	Diesel	1997	4	37
02/04→	307 Break 2.0 HDi 135	DW10BTED4 (RHR)	Diesel	1997	4	37
03/02→	307 Break 2.0 HDi 90	DW10TD (RHY)	Diesel	1997	4	37
03/05→	307 CC 1.6 16V	TU5JP4 (NFU/N6A)	Petrol	1587	4	21
06/05→	307 CC 2.0 HDi 135	DW10BTED4 (RHR)	Diesel	1997	4	37
04/02→09/03	307 SW 1.4	TU3JP (KFW)	Petrol	1360	4	13
03/02→01/05	307 SW 1.4 HDi 70	DV4TD (8HZ)	Diesel	1398	4	8
03/02→	307 SW 1.6 16V	TU5JP4 (NFU/N6A)	Petrol	1587	4	21
09/07→	307 SW 1.6 BioFlex	TU5JP4 (NFU/N6A)	Petrol	1587	4	21
02/04→	307 SW 1.6 HDi 110	DV6TED4 (9HY) Euro 4	Diesel	1560	4	10
02/04→	307 SW 1.6 HDi 110	DV6TED4 (9HZ) Euro 4	Diesel	1560	4	10
12/06→	307 SW 1.6 HDi 90	DV6ATED4 (9HV)	Diesel	1560	4	10
03/02→	307 SW 2.0 HDi 110	DW10ATED (RHS)	Diesel	1997	4	37
02/04→	307 SW 2.0 HDi 135	DW10BTED4 (RHR)	Diesel	1997	4	37
03/02→	307 SW 2.0 HDi 90	DW10TD (RHY)	Diesel	1997	4	37
04/08→	308 1.6 BioFlex	TU5JP4 (NFU/N6A)	Petrol	1587	4	21
12/09→	308 1.6 HDi	DV6C (9HR)	Diesel	1560	4	11
11/09→	308 1.6 HDi	DV6DTED (9HP) Euro 4	Diesel	1560	4	11
11/09→	308 1.6 Hdi	DV6DTEDM (9HJ) Euro 4	Diesel	1560	4	11
11/09→	308 1.6 Hdi	DV6ETEDM (9HK) Euro 4	Diesel	1560	4	11
09/07→	308 1.6 HDi	DV6TED4 (9HZ) Euro 4	Diesel	1560	4	10
09/07→	308 2.0 HDi	DW10BTED4 (RHR)	Diesel	1997	4	37
06/09→	308 CC 1.6 HDi	DV6C (9HR)	Diesel	1560	4	11
04/09→	308 CC 2.0 HDi	DW10BTED4 (RHR)	Diesel	1997	4	37
03/09→	308 SW 1.6 Bioflex	TU5JP4 (NFU/N6A)	Petrol	1587	4	21
09/07→	308 SW 1.6 HDi	DV6ATED4 (9HV)	Diesel	1560	4	10
09/07→	308 SW 1.6 HDi	DV6ATED4 (9HX) Euro 4	Diesel	1560	4	10
12/09→	308 SW 1.6 HDi	DV6C (9HR)	Diesel	1560	4	11
11/09→	308 SW 1.6 HDi	DV6DTED (9HP) Euro 4	Diesel	1560	4	11
11/09→	308 SW 1.6 Hdi	DV6DTEDM (9HJ) Euro 4	Diesel	1560	4	11
11/09→	308 SW 1.6 Hdi	DV6ETEDM (9HK) Euro 4	Diesel	1560	4	11
09/07→	308 SW 1.6 HDi	DV6TED4 (9HZ) Euro 4	Diesel	1560	4	10
09/07→	308 SW 2.0 HDi	DW10BTED4 (RHR)	Diesel	1997	4	37



CCM

x



9

01/91→	309 1.4 i	TU3 F (Cast Iron Block), TU3 F2 (Cast Iron Block), TU3 F2C (Cast Iron Block), TU3 FJ2 (Cast Iron Block), TU3 FM (Cast Iron Block)	Petrol	1360	4	12
10/85→12/90	309 1.6	XU51C (B1D)	Petrol	1580	4	29
10/85→07/89	309 I 1.1	E1	Petrol	1118	4	9
10/85→07/89	309 I 1.3	G1 / G2	Petrol	1294	4	16
03/89→07/89	309 I 1.4	TU3A (K1D)	Petrol	1360	4	12
03/89→07/89	309 I 1.4	TU3M (KDY)	Petrol	1360	4	12
03/89→07/89	309 I 1.4	TU3M (KDZ)	Petrol	1360	4	12
03/89→07/89	309 I 1.4	TU3S (K2B)	Petrol	1360	4	12
10/85→07/89	309 I 1.6	XU5 (B1AA)	Petrol	1580	4	29
11/85→09/88	309 I 1.6	XU5J (180)	Petrol	1580	4	30
11/85→09/88	309 I 1.6	XU5J (B6B)	Petrol	1580	4	30
08/87→07/89	309 I 1.6	XU51C (B1A/B1C/B1E)	Petrol	1580	4	29
09/86→12/89	309 I 1.6 CAT	XU5CP (BAZ)	Petrol	1580	4	29
03/86→07/89	309 I 1.9	XU9J1 (DFZ)	Petrol	1905	4	30
07/88→07/89	309 I 1.9	XU9M (DDZ)	Petrol	1905	4	30
10/85→07/89	309 I 1.9	XU9S (D2B)	Petrol	1905	4	30
06/86→07/89	309 I 1.9 D	XUD9 (162)	Diesel	1905	4	32
06/86→07/89	309 I 1.9 D	XUD9 (D9A)	Diesel	1905	4	32
10/86→07/89	309 I 1.9 GTI	XU9JA (D6B)	Petrol	1905	4	30
07/88→07/89	309 I 1.9 GTI	XU9JAZ (DKZ)	Petrol	1905	4	30
09/89→10/93	309 II 1.1	TU1 (H1A/H1B/H3A)	Petrol	1124	4	5
08/90→12/93	309 II 1.1	TU1M (HDZ)	Petrol	1124	4	5
07/90→12/93	309 II 1.4	TU3A (K1D)	Petrol	1360	4	12
07/89→12/93	309 II 1.4	TU3M (KDY)	Petrol	1360	4	12
07/89→12/93	309 II 1.4	TU3M (KDZ)	Petrol	1360	4	12
07/89→12/93	309 II 1.6	XU5M (BDZ)	Petrol	1580	4	30
07/89→12/93	309 II 1.6	XU52C (B2A)	Petrol	1580	4	29
07/89→12/93	309 II 1.8 Diesel	XUD7 (161A)	Diesel	1769	4	23
08/89→12/93	309 II 1.8 TD	XUD7TE (A8B)	Diesel	1769	4	24
08/89→12/93	309 II 1.9	XU9J1 (DFZ)	Petrol	1905	4	30
10/90→12/93	309 II 1.9	XU9M (DDZ)	Petrol	1905	4	30
07/89→12/93	309 II 1.9 Diesel	XUD9 (162)	Diesel	1905	4	32
07/89→12/93	309 II 1.9 Diesel	XUD9 (D9A)	Diesel	1905	4	32
07/89→12/93	309 II 1.9 Diesel	XUD9 (DJZ)	Diesel	1905	4	32
07/89→12/93	309 II 1.9 GTI	XU9JAZ (DKZ)	Petrol	1905	4	30
08/89→07/90	309 II 1.9 GTI 16V	XU9J4 (D6C/DFW)	Petrol	1905	4	31
10/90→12/93	309 II 1.9 GTI 16V	XU9J4 (DFW)	Petrol	1905	4	31
	309 SR	J2	Flexfuel	1592	4	25
11/67→12/71	404 1.6	XC6	Petrol	1618	4	36
07/71→12/71	404 1.6 GT	XC6	Petrol	1618	4	36
01/93→	405 1.4 i GL	TU3 F (Cast Iron Block), TU3 F2 (Cast Iron Block), TU3 F2C (Cast Iron Block), TU3 FJ2 (Cast Iron Block), TU3 FM (Cast Iron Block)	Petrol	1360	4	12
01/93→	405 1.4 i GR	TU3 F (Cast Iron Block), TU3 F2 (Cast Iron Block), TU3 F2C (Cast Iron Block), TU3 FJ2 (Cast Iron Block), TU3 FM (Cast Iron Block)	Petrol	1360	4	12
03/88→04/97	405 1.9 D	XUD9A (D9B/DJY)	Diesel	1905	4	33
01/92→	405 GL	TU3.2, TU3.2 F, TU3.2 F2	Petrol	1360	4	12
07/87→06/88	405 I 1.6	XU5CP (BAZ)	Petrol	1580	4	29
07/87→12/92	405 I 1.6	XU5M (BDZ)	Petrol	1580	4	30
07/87→12/92	405 I 1.6	XU51C (B1A/B1C/B1E)	Petrol	1580	4	29
01/87→12/92	405 I 1.6	XU52C (B2A)	Petrol	1580	4	29
04/88→07/92	405 I 1.6 4x4	XU5M (BDZ)	Petrol	1580	4	30
03/88→12/92	405 I 1.8 Turbo Diesel	XUD7TE (A8A)	Diesel	1769	4	24
03/88→12/92	405 I 1.8 Turbo Diesel	XUD7TE (AJZ)	Diesel	1769	4	24

MODEL INDEX

Modelverzeichnis • Index de modele • Índice de Modelo
 Indeks modelu • Модель автомобиля • دليل الموديل

CCM
x

9

01/89→12/92	405 I 1.9	XU9J2 (D6A)	Petrol	1905	4	30
07/88→12/92	405 I 1.9	XU9JAZ (DKZ)	Petrol	1905	4	30
07/88→12/92	405 I 1.9	XU9M (DDZ)	Petrol	1905	4	30
07/87→12/92	405 I 1.9	XU92C (D2C)	Petrol	1905	4	30
06/87→07/92	405 I 1.9 4x4	XU9J4 (D6C/DFW)	Petrol	1905	4	31
06/87→07/92	405 I 1.9 4x4	XU9JAZ (DKZ)	Petrol	1905	4	30
07/88→12/92	405 I 1.9 4x4	XU9M (DDZ)	Petrol	1905	4	30
07/88→09/92	405 I 1.9 Diesel	XUD9 (DJZ)	Diesel	1905	4	32
03/88→12/92	405 I 1.9 Diesel	XUD9A (D9B)	Diesel	1905	4	32
07/87→12/92	405 I 1.9 Injection	XU9J1 (DFZ)	Petrol	1905	4	30
07/87→11/91	405 I 1.9 Sport MI-16	XU9J4 (D6C/DFW)	Petrol	1905	4	31
04/88→12/92	405 I 1.9 Sport MI-16	XU9J4 (DFW)	Petrol	1905	4	31
04/88→12/92	405 I 1.9 SPort MI-16 4x4	XU9J4 (DFW)	Petrol	1905	4	31
10/88→08/92	405 I Break 1.6	XU5CP (BAZ)	Petrol	1580	4	29
10/88→08/92	405 I Break 1.6	XU5M (BDZ)	Petrol	1580	4	30
10/88→08/92	405 I Break 1.6	XU51C (B1A/B1C/B1E)	Petrol	1580	4	29
05/88→07/92	405 I Break 1.6	XU52C (B2A)	Petrol	1580	4	29
04/88→07/92	405 I Break 1.6 SRi 4x4	XU5M (BDZ)	Petrol	1580	4	30
10/88→08/92	405 I Break 1.8 TD	XUD7TE (A8A)	Diesel	1769	4	24
10/88→08/92	405 I Break 1.8 TD	XUD7TE (AJZ)	Diesel	1769	4	24
05/88→08/92	405 I Break 1.9	XU9J1 (DFZ)	Petrol	1905	4	30
10/88→08/92	405 I Break 1.9	XU9JAZ (DKZ)	Petrol	1905	4	30
10/88→08/92	405 I Break 1.9	XU9M (DDZ)	Petrol	1905	4	30
10/88→08/92	405 I Break 1.9	XU92C (D2C)	Petrol	1905	4	30
07/90→07/92	405 I Break 1.9 4x4	XU9JAZ (DKZ)	Petrol	1905	4	30
10/88→08/92	405 I Break 1.9 4x4	XU9M (DDZ)	Petrol	1905	4	30
09/88→07/92	405 I Break 1.9 All-wheel Drive	XU9J1 (DFZ)	Petrol	1905	4	30
06/87→07/92	405 I Break 1.9 All-wheel Drive	XU9J4 (D6C/DFW)	Petrol	1905	4	31
10/88→08/92	405 I Break 1.9 D	XUD9 (DJZ)	Diesel	1905	4	32
10/88→08/92	405 I Break 1.9 D	XUD9A (D9B)	Diesel	1905	4	32
10/88→08/92	405 I Break 1.9 D	XUD9A (DJY)	Diesel	1905	4	32
08/92→10/95	405 II 1.4	TU3MC (KDX)	Petrol	1360	4	12
08/92→05/97	405 II 1.6	XU5JP (BFZ)	Petrol	1580	4	31
08/92→10/95	405 II 1.6	XU5M (BDZ)	Petrol	1580	4	30
08/92→05/97	405 II 1.6	XU52C (B2A)	Petrol	1580	4	29
08/92→11/99	405 II 1.8	XU7JP (LFZ)	Petrol	1761	4	31
08/92→10/95	405 II 1.9 D	XUD9 (DJZ)	Diesel	1905	4	32
08/97→11/99	405 II 1.9 D	XUD9A (D9B)	Diesel	1905	4	32
06/94→10/95	405 II 1.9 D	XUD9A (DJY)	Diesel	1905	4	32
08/92→05/97	405 II 1.9 TD	XUD9TE	Diesel	1905	4	33
08/92→10/95	405 II 1.9 TD	XUD9TE (DHY)	Diesel	1905	4	33
08/92→10/95	405 II 2.0	XU10J2 (RFX)	Petrol	1998	4	42
06/94→10/95	405 II 2.0 16V	XU10J4 (RFT)	Petrol	1998	4	42
08/92→10/95	405 II 2.0 MI-16	XU10J4 (RFT/RFY)	Petrol	1998	4	42
08/92→10/95	405 II 2.0 X4	XU10J2 (RFX)	Petrol	1998	4	42
08/92→10/96	405 II Break 1.4	TU3MC (KDX)	Petrol	1360	4	12
08/92→10/96	405 II Break 1.6	XU5JP (BFZ)	Petrol	1580	4	31
08/92→10/96	405 II Break 1.6	XU5M (BDZ)	Petrol	1580	4	30
08/92→10/96	405 II Break 1.8	XU7JP (LFZ)	Petrol	1761	4	31
09/93→12/95	405 II Break 1.9 D	XUD9	Diesel	1905	4	32
08/92→10/96	405 II Break 1.9 D	XUD9 (DJZ)	Diesel	1905	4	32
06/94→10/96	405 II Break 1.9 D	XUD9A (DJY)	Diesel	1905	4	32
08/92→10/96	405 II Break 1.9 TD	XUD9TE (DHY)	Diesel	1905	4	33
08/92→10/96	405 II Break 2.0	XU10J2 (RFX)	Petrol	1998	4	42
08/92→10/96	405 II Break 2.0 4x4	XU10J2 (RFX)	Petrol	1998	4	42
03/00→05/04	406	DW12TED4 (4HZ)	Diesel	2179	4	37
11/95→05/04	406 1.6	XU5JP (BFZ)	Petrol	1580	4	31
05/97→05/04	406 1.8	XU7JB (LFX)	Petrol	1761	4	31
10/00→05/04	406 1.8 16V	EW7J4 (6FZ)	Petrol	1749	4	28
11/95→10/00	406 1.8 16V	XU7JP4 (LFY)	Petrol	1761	4	31

CCM
x

9

10/96→05/04	406 1.9 D	XUD9SD (DHW)	Diesel	1905	4	33
01/96→05/04	406 1.9 TD	XUD9TE (DHX)	Diesel	1905	4	33
01/96→05/04	406 1.9 TD	XUD9TE (DHY)	Diesel	1905	4	33
11/96→03/99	406 2.0	XU10J2TE (RGY)	Petrol	1998	4	42
11/95→05/04	406 2.0 16V	XU10J4R (RFV/R6E)	Petrol	1998	4	42
08/01→05/04	406 2.0 HDi 110	DW10ATED (RHS)	Diesel	1997	4	37
06/98→05/04	406 2.0 HDi 110	DW10ATED (RHZ)	Diesel	1997	4	37
02/99→05/04	406 2.0 HDi 90	DW10TD (RHY)	Diesel	1997	4	37
04/96→05/04	406 2.0 Turbo	XU10J2TE (RGX)	Petrol	1998	4	42
01/96→05/04	406 2.1 TD 12V	XUD11BTE (P8C)	Diesel	2088	4	40
03/00→05/04	406 2.2 Hdi	DW12BTED4 (4HW)	Diesel	2179	4	37
03/00→05/04	406 2.2 HDi	DW12TED4 (4HX/4HW)	Diesel	2179	4	37
10/96→05/04	406 3.0 24V	ES9J4 (XFZ)	Petrol	2946	6	44
03/00→05/04	406 3.0 V6	ES9J4S (XFX/XFW)	Petrol	2946	6	44
03/00→10/04	406 Break	DW12TED4 (4HZ)	Diesel	2179	4	37
05/97→10/04	406 Break 1.8	XU7JB (LFX)	Petrol	1761	4	31
10/00→10/04	406 Break 1.8 16V	EW7J4 (6FZ)	Petrol	1749	4	28
10/96→10/00	406 Break 1.8 16V	XU7JP4 (LFY)	Petrol	1761	4	31
10/96→10/04	406 Break 1.9 D	XUD9SD (DHW)	Diesel	1905	4	33
10/96→10/04	406 Break 1.9 TD	XUD9TE (DHX)	Diesel	1905	4	33
11/96→03/99	406 Break 2.0	XU10J2TE (RGY)	Petrol	1998	4	42
10/96→10/04	406 Break 2.0 16V	XU10J4R (RFV/R6E)	Petrol	1998	4	42
08/01→10/04	406 Break 2.0 HDi 110	DW10ATED (RHS)	Diesel	1997	4	37
02/99→10/04	406 Break 2.0 HDi 110	DW10ATED (RHZ)	Diesel	1997	4	37
02/99→10/04	406 Break 2.0 HDi 90	DW10TD (RHY)	Diesel	1997	4	37
10/96→10/04	406 Break 2.0 Turbo	XU10J2TE (RGX)	Petrol	1998	4	42
10/96→10/04	406 Break 2.1 TD 12V	XUD11BTE (P8C)	Diesel	2088	4	40
03/00→10/04	406 Break 2.2 Hdi	DW12BTED4 (4HW)	Diesel	2179	4	37
03/00→10/04	406 Break 2.2 HDi	DW12TED4 (4HX/4HW)	Diesel	2179	4	37
10/96→10/04	406 Break 3.0 24V	ES9J4 (XFZ)	Petrol	2946	6	44
03/00→10/04	406 Break 3.0 V6	ES9J4S (XFX/XFW)	Petrol	2946	6	44
03/97→12/04	406 Coupe 2.0 16V	XU10J4R (RFV/R6E)	Petrol	1998	4	42
03/00→12/04	406 Coupe 2.2 Hdi	DW12BTED4 (4HW)	Diesel	2179	4	37
03/00→12/04	406 Coupe 2.2 HDi	DW12TED4 (4HX/4HW)	Diesel	2179	4	37
03/00→12/04	406 Coupe 3.0 V6	ES9J4S (XFX/XFW)	Petrol	2946	6	44
03/97→12/04	406 Coupe 3.0 V6 24V	ES9J4 (XFZ)	Petrol	2946	6	44
05/04→	407 1.6 HDi 110	DV6TED4 (9HY) Euro 4	Diesel	1560	4	10
05/04→	407 1.8	EW7J4 (6FZ)	Petrol	1749	4	28
08/08→	407 2.0 HDi	DW10BTED4 (RHR)	Diesel	1997	4	37
05/04→	407 2.0 HDi 135	DW10BTED4 (RHR)	Diesel	1997	4	37
10/05→	407 Coupe 2.0 HDi	DW10BTED4 (RHR)	Diesel	1997	4	37
06/09→	407 Coupe 3.0 HDi	DT20C Euro 5	Diesel	2993	V6	34
05/04→	407 SW 1.6 HDi 110	DV6TED4 (9HY) Euro 4	Diesel	1560	4	10
05/04→	407 SW 1.8	EW7J4 (6FZ)	Petrol	1749	4	28
08/08→	407 SW 2.0 HDi	DW10BTED4 (RHR)	Diesel	1997	4	37
05/04→	407 SW 2.0 HDi 135	DW10BTED4 (RHR)	Diesel	1997	4	37
07/68→02/71	504 1.8	XM	Petrol	1796	4	35
01/71→06/83	504 1.8	XM7	Petrol	1796	4	35
07/68→02/71	504 1.8 Injection	KF5	Petrol	1796	4	35
07/68→02/71	504 1.8 Injection	KF6	Petrol	1796	4	35
03/73→07/86	504 1.9 D	XD 4.88	Diesel	1948	4	46
03/73→07/86	504 1.9 D	XD 88	Diesel	1948	4	46
09/79→08/82	504 2.0	XN1	Petrol	1971	4	47
03/71→06/86	504 2.0	XN1 (106)	Petrol	1971	4	47
01/71→06/83	504 2.0 TI	XN2 (107)	Petrol	1971	4	47
02/71→07/86	504 2.1 D	XD90	Diesel	2112	4	48
07/75→12/83	504 2.3 D	XD2 (134)	Diesel	2304	4	56
04/71→07/86	504 Break 1.8	XM7	Petrol	1796	4	35
04/71→07/86	504 Break 2.0	XN1	Petrol	1971	4	47
04/71→07/86	504 Break 2.1 D	XD90	Diesel	2112	4	48

MODEL INDEX

Modelverzeichnis • Index de modele • Índice de Modelo
 Indeks modelu • Модель автомобиля • دليل المحرك

CCM
x

9

07/75→07/86	504 Break 2.3 D	XD2 (134)	Diesel	2304	4	56
08/82→08/84	504 Convertible 2.0	XN2 (107)	Petrol	1971	4	47
08/82→08/84	504 Coupe 2.0	XN2 (107)	Petrol	1971	4	47
10/77→08/84	504 Coupe 2.7	ZMJ (140)	Petrol	2664	6	47
01/80→06/87	504 Pickup 1.6	XC7P	Petrol	1618	4	36
08/81→12/89	504 Pickup 1.8	XM7	Petrol	1796	4	35
01/80→12/89	504 Pickup 1.9 D	XD 4.88	Diesel	1948	4	46
01/80→12/89	504 Pickup 1.9 D	XD 88	Diesel	1948	4	46
01/80→12/89	504 Pickup 2.3 D	XD2 (134)	Diesel	2304	4	56
06/81→10/85	505 1.8	XM7 (105)	Petrol	1796	4	35
09/85→10/86	505 1.8	XM7A (105C)	Petrol	1796	4	35
09/80→09/85	505 2.0	XN1	Petrol	1971	4	47
11/80→12/85	505 2.0	XN1 (106)	Petrol	1971	4	47
09/85→09/95	505 2.0	XN1A (106E)	Petrol	1971	4	47
08/79→10/86	505 2.0 TI, STI	ZEJ (829)	Petrol	1995	4	45
05/81→10/84	505 2.2	ZDJ (851)	Petrol	2165	4	45
03/86→12/93	505 2.2	ZDJL (851X)	Petrol	2165	4	45
08/83→12/93	505 2.2 GTI	ZDJL (851B)	Petrol	2165	4	45
05/79→09/84	505 2.3 D	XD2	Diesel	2304	4	56
09/80→06/86	505 2.3 Turbo Diesel	XD2S (147)	Diesel	2304	4	57
06/81→12/93	505 2.5 Diesel	XD3 (155)	Diesel	2498	4	56
10/83→12/90	505 2.5 Turbo Diesel	XD3T	Diesel	2498	4	57
10/83→12/93	505 2.5 Turbo Diesel	XD3T (152A)	Diesel	2498	4	57
10/86→12/93	505 2.5 Turbo Diesel	XD3TE (152B)	Diesel	2498	4	57
06/86→12/93	505 2.8 GTI V6	ZN3J (154X)	Petrol	2849	6	49
04/82→09/85	505 Break 1.8	XM7	Petrol	1796	4	35
08/83→12/85	505 Break 2.0	XN1 (106)	Petrol	1971	4	47
09/85→11/87	505 Break 2.0	XN1A (106E)	Petrol	1971	4	47
10/85→09/89	505 Break 2.0	ZEJ (829)	Petrol	1995	4	45
01/86→12/93	505 Break 2.2	ZDJL (851X)	Petrol	2165	4	45
09/85→12/86	505 Break 2.2 GTI	ZDJL (851B)	Petrol	2165	4	45
06/82→09/84	505 Break 2.3 D	XD2	Diesel	2304	4	56
04/82→06/86	505 Break 2.3 Diesel	XD2S (147)	Diesel	2304	4	57
10/85→08/91	505 Break 2.5 D	XD3T	Diesel	2498	4	57
08/83→12/93	505 Break 2.5 Diesel	XD3 (155)	Diesel	2498	4	56
10/85→11/87	505 Break 2.5 Turbo Diesel	XD3T (152A)	Diesel	2498	4	57
10/86→12/93	505 Break 2.5 Turbo Diesel	XD3TE (152B)	Diesel	2498	4	57
01/86→	505 GTI Familiale	J7T	Petrol	2165	4	45
01/86→	505 GTX	J7T	Petrol	2165	4	45
11/10→	508 1.6 HDi	DV6C (9HR)	Diesel	1560	4	11
02/12→	508 1.6 HDi	DV6CTED (9HD)	Diesel	1560	4	11
11/10→	508 2.0 HDi	DW10BTED4 (RHF)	Diesel	1997	4	37
11/10→	508 2.0 HDi	DW10BTED4 (RHR)	Diesel	1997	4	37
11/10→	508 2.2 HDi	DW12C (4HL) Euro 5	Diesel	2179	4	38
11/10→	508 SW 1.6 HDi	DV6C (9HR)	Diesel	1560	4	11
02/12→	508 SW 1.6 HDi	DV6CTED (9HD)	Diesel	1560	4	11
11/10→	508 SW 2.0 HDi	DW10BTED4 (RHF)	Diesel	1997	4	37
11/10→	508 SW 2.0 HDi	DW10BTED4 (RHR)	Diesel	1997	4	37
11/10→	508 SW 2.2 HDi	DW12C (4HL) Euro 5	Diesel	2179	4	38
09/79→05/83	604 2.3 TD	XD2S (147)	Diesel	2304	4	57
08/83→12/86	604 2.5 TD	XD3T (152A)	Diesel	2498	4	57
08/77→05/83	604 2.7 SL	ZM (112)	Petrol	2664	6	47
08/77→05/83	604 2.7 TI, STI	ZMJ (140)	Petrol	2664	6	47
06/89→09/99	605 2.0	XU10J2 (RFZ/R6A)	Petrol	1998	4	42
06/89→09/99	605 2.0	XU102C (R5A)	Petrol	1998	4	42
07/94→09/99	605 2.0 16V	XU10J4R (RFV/R6E)	Petrol	1998	4	42
07/91→09/99	605 2.0 Turbo	XU10J2TE (RGX)	Petrol	1998	4	42
07/92→09/99	605 2.0 Turbo	XU10J2TE (RGY)	Petrol	1998	4	42
06/89→07/95	605 2.1 D	XUD11A (P9A/PJZ)	Diesel	2138	4	43
08/94→09/99	605 2.1 TD 12V	XUD11BTE (P8C)	Diesel	2088	4	40



CCM

x



9

06/89→09/99	605 2.1 Turbo Diesel	XUD11ATE (PHZ/P8A/P8B)	Diesel	2088	4	39
07/94→09/99	605 2.5 Turbo Diesel	DK5ATE (THY)	Diesel	2446	4	53
04/97→09/99	605 3.0 V6	ES9J4 (XFZ)	Petrol	2946	6	44
03/00→	607	DW12TED4 (4HZ)	Diesel	2179	4	37
03/01→07/04	607 2.0 HDi	DW10ATED (RHS)	Diesel	1997	4	37
05/00→	607 2.0 HDi	DW10ATED (RHZ)	Diesel	1997	4	37
09/05→	607 2.0 HDi	DW10BTED4 (RHR)	Diesel	1997	4	37
02/00→	607 2.2 Hdi	DW12BTED4 (4HW)	Diesel	2179	4	37
02/00→	607 2.2 HDi	DW12TED4 (4HX/4HW)	Diesel	2179	4	37
12/04→	607 2.7 HDi 24V	DT17TED4	Diesel	2721	6	26
02/00→	607 3.0 V6 24V	ES9J4S (XFX/XFW)	Petrol	2946	6	44
07/95→08/02	806 1.8	XU7JP (LFW)	Petrol	1761	4	31
07/95→08/02	806 1.9 TD	XUD9TE (DHX)	Diesel	1905	4	33
05/97→08/02	806 1.9 TD	XUD9TE (DHY)	Diesel	1905	4	33
06/94→08/02	806 2.0	XU10J2 (RFU)	Petrol	1998	4	42
05/98→09/00	806 2.0 16V	XU10J4R (RFV/R6E)	Petrol	1998	4	42
08/99→08/02	806 2.0 HDi	DW10ATED (RHZ)	Diesel	1997	4	37
08/99→08/02	806 2.0 HDi 16V	DW10ATED4 (RHW)	Diesel	1997	4	37
06/94→08/02	806 2.0 Turbo	XU10J2TE (RGX)	Petrol	1998	4	42
06/96→08/99	806 2.1 td 12V	XUD11BTE (P8C)	Diesel	2088	4	40
06/02→	807	DW12TED4 (4HZ)	Diesel	2179	4	37
06/02→	807 2.0 HDi	DW10ATED4 (RHM)	Diesel	1997	4	37
06/02→	807 2.0 HDi	DW10ATED4 (RHT)	Diesel	1997	4	37
06/02→	807 2.0 HDi	DW10ATED4 (RHW)	Diesel	1997	4	37
06/06→	807 2.0 HDi	DW10BTED4 (RHR)	Diesel	1997	4	37
02/06→	807 2.0 HDi	DW10UTED4 (RHK) Euro 4	Diesel	1997	4	37
06/02→	807 2.2 Hdi	DW12BTED4 (4HW)	Diesel	2179	4	37
06/02→	807 2.2 HDi	DW12TED4 (4HX/4HW)	Diesel	2179	4	37
06/02→	807 3.0 V6	ES9J4S (XFX/XFW)	Petrol	2946	6	44
04/05→	1007 1.4	TU3JP-L4	Petrol	1360	4	13
04/05→	1007 1.4 HDi	DV4TD (8HX)	Diesel	1399	4	8
04/05→	1007 1.4 HDi	DV4TD (8HZ)	Diesel	1398	4	8
04/05→	1007 1.6 16V	TU5JP4 (NFU/N6A)	Petrol	1587	4	21
06/07→	1007 1.6 HDi	DV6TED4 (9HZ) Euro 4	Diesel	1560	4	10
03/13→	2008 1.6 HDi	DV6CTED (9HD)	Diesel	1560	4	11
03/13→	2008 1.6 HDi	DV6DTED (9HP) Euro 4	Diesel	1560	4	11
03/13→	2008 1.6 Hdi	DV6DTEDM (9HJ) Euro 4	Diesel	1560	4	11
03/13→	2008 1.6 Hdi	DV6ETEDM (9HK) Euro 4	Diesel	1560	4	11
08/10→	3008 1.6 HDi	DV6C (9HR)	Diesel	1560	4	11
03/13→	3008 1.6 HDi	DV6CTED (9HD)	Diesel	1560	4	11
06/09→	3008 1.6 HDi	DV6TED4 (9HZ) Euro 4	Diesel	1560	4	10
02/07→	4007 2.2 HDi	DW12MTED4 (4HN)	Diesel	2179	4	38
	4007 2.2 Hdi 200702	DW12MTED4 (4HK)	Diesel	2179	4	38
08/10→	5008 1.6 HDi	DV6C (9HR)	Diesel	1560	4	11
03/13→	5008 1.6 HDi	DV6CTED (9HD)	Diesel	1560	4	11
09/09→	5008 1.6 HDi	DV6TED4 (9HZ) Euro 4	Diesel	1560	4	10
10/10→	Bipper 1.3 HDi 75	199 A9.000 Euro 5	Diesel	1248	4	1
02/08→	Bipper 1.4	TU3A (KFV)	Petrol	1360	4	12
02/08→	Bipper 1.4 HDi	DV4TD (8HS)	Diesel	1398	4	8
10/10→	Bipper Tepee 1.3 HDi 75	199 A9.000 Euro 5	Diesel	1248	4	1
04/08→	Bipper Tepee 1.4	TU3A (KFV)	Petrol	1360	4	12
04/08→	Bipper Tepee 1.4 HDi	DV4TD (8HS)	Diesel	1398	4	8
02/94→02/02	Boxer 1.9	XUD9A (D9B/DJY)	Diesel	1905	4	33
03/94→04/02	Boxer Box 1.9 D	XUD9A (D9B)	Diesel	1905	4	32
07/99→04/02	Boxer Box 1.9 D	XUD9A (DJY)	Diesel	1905	4	32
03/96→09/98	Boxer Box 1.9 DT 4x4	XUD9TE	Diesel	1905	4	33
07/99→04/02	Boxer Box 1.9 TD	XUD9TE	Diesel	1905	4	33
03/94→04/02	Boxer Box 1.9 TD	XUD9UTF (D8C)	Diesel	1905	4	33
04/02→	Boxer Box 2.0 HDi	DW10TD (RHV)	Diesel	1997	4	37
08/01→	Boxer Box 2.0 HDi	DW10UTD (RHV)	Diesel	1997	4	37

MODEL INDEX

Modelverzeichnis • Index de modele • Índice de Modelo
 Indeks modelu • Модель автомобиля • دليل الموديل

CCM
x

9

06/94→04/02	Boxer Box 2.0 i	XU10J2 (RFW)	Petrol	1998	4	42
04/02→	Boxer Box 2.2 HDi	DW12UTED (4HY)	Diesel	2179	4	37
04/06→	Boxer Box 2.2 HDi 100	4HV Euro 4	Diesel	2198	4	41
04/06→	Boxer Box 2.2 HDi 120	4HU Euro 4	Diesel	2198	4	41
03/94→04/02	Boxer Box 2.5 D	DJ5 (T9A)	Diesel	2446	4	50
07/99→04/02	Boxer Box 2.5 D 4x4	DJ5 (T9A)	Diesel	2446	4	50
03/94→04/02	Boxer Box 2.5 TD	DJ5T (T8A/THZ)	Diesel	2446	4	51
01/97→04/02	Boxer Box 2.5 TDI	DJ5TED (THX)	Diesel	2446	4	52
07/99→04/02	Boxer Box 2.5 TDI 4x4	DJ5TED (THX)	Diesel	2446	4	52
01/99→02/02	Boxer Box 2.8 D	8140.63 (F28D)	Diesel	2798	4	59
04/04→	Boxer Box 2.8 HDi	8140.43N	Diesel	2798	4	58
10/00→	Boxer Box 2.8 HDi	8140.43S Euro 3	Diesel	2798	4	58
10/00→	Boxer Box 2.8 HDi 4x4	8140.43S Euro 3	Diesel	2798	4	58
03/94→04/02	Boxer Bus 1.9 D	XUD9A (D9B)	Diesel	1905	4	32
08/94→04/02	Boxer Bus 1.9 TD	XUD9TE (DHY)	Diesel	1905	4	33
03/94→04/02	Boxer Bus 1.9 TD	XUD9UTF (D8C)	Diesel	1905	4	33
07/96→04/02	Boxer Bus 1.9 TD 4x4	XUD9UTF (D8C)	Diesel	1905	4	33
04/02→	Boxer Bus 2.0 HDi	DW10TD (RHV)	Diesel	1997	4	37
04/02→	Boxer Bus 2.0 HDi	DW10UTD (RHV)	Diesel	1997	4	37
03/94→04/02	Boxer Bus 2.0 i	XU10J2 (RFW)	Petrol	1998	4	42
08/96→04/02	Boxer Bus 2.0 i 4x4	XU10J2 (RFW)	Petrol	1998	4	42
04/02→	Boxer Bus 2.2 HDi	DW12UTED (4HY)	Diesel	2179	4	37
04/06→	Boxer Bus 2.2 HDi 100	4HV Euro 4	Diesel	2198	4	41
04/06→	Boxer Bus 2.2 HDi 120	4HU Euro 4	Diesel	2198	4	41
08/94→04/02	Boxer Bus 2.5 D	DJ5 (T9A)	Diesel	2446	4	50
07/96→04/02	Boxer Bus 2.5 D 4x4	DJ5 (T9A)	Diesel	2446	4	50
07/94→04/02	Boxer Bus 2.5 TD	DJ5T (T8A/THZ)	Diesel	2446	4	51
07/96→04/02	Boxer Bus 2.5 TD 4x4	DJ5T (T8A/THZ)	Diesel	2446	4	51
01/97→04/02	Boxer Bus 2.5 TDI	DJ5TED (THX)	Diesel	2446	4	52
01/97→04/02	Boxer Bus 2.5 TDI 4x4	DJ5TED (THX)	Diesel	2446	4	52
01/99→02/02	Boxer Bus 2.8 D	8140.63 (F28D)	Diesel	2798	4	59
04/04→	Boxer Bus 2.8 HDi	8140.43N	Diesel	2798	4	58
10/00→	Boxer Bus 2.8 HDi	8140.43S Euro 3	Diesel	2798	4	58
10/00→	Boxer Bus 2.8 HDi 4x4	8140.43S Euro 3	Diesel	2798	4	58
10/00→11/01	Boxer Bus 2.8 HDi All-wheel Drive	8140.43S Euro 3	Diesel	2798	4	58
04/06→	Boxer Platform/Chassis 2.2 HDi 120	4HU Euro 4	Diesel	2198	4	41
04/06→	Boxer Platform/Chassis 2.2 HDi 100	4HV Euro 4	Diesel	2198	4	41
10/00→11/01	Boxer Platform/Chassis 2.8 HDi All-wheel Drive	8140.43S Euro 3	Diesel	2798	4	58
04/02→	Boxer Platform/Chassis 2.0 HDi	DW10UTD (RHV)	Diesel	1997	4	37
07/96→04/02	Boxer Platform/Chassis 1.9 TD	XUD9UTF (D8C)	Diesel	1905	4	33
12/98→04/02	Boxer Platform/Chassis 1.9 TD	XUD9TE (DHY)	Diesel	1905	4	33
04/02→	Boxer Platform/Chassis 2.0 HDi	DW10TD (RHV)	Diesel	1997	4	37
06/94→04/02	Boxer Platform/Chassis 2.0 i	XU10J2 (RFW)	Petrol	1998	4	42
04/02→	Boxer Platform/Chassis 2.2 HDi	DW12UTED (4HY)	Diesel	2179	4	37
03/94→04/02	Boxer Platform/Chassis 2.5 D	DJ5 (T9A)	Diesel	2446	4	50
07/99→04/02	Boxer Platform/Chassis 2.5 D 4x4	DJ5 (T9A)	Diesel	2446	4	50
03/94→04/02	Boxer Platform/Chassis 2.5 TD	DJ5T (T8A/THZ)	Diesel	2446	4	51
01/97→04/02	Boxer Platform/Chassis 2.5 TDI	DJ5TED (THX)	Diesel	2446	4	52
07/99→04/02	Boxer Platform/Chassis 2.5 TDI 4x4	DJ5TED (THX)	Diesel	2446	4	52
01/99→02/02	Boxer Platform/Chassis 2.8 D	8140.63 (F28D)	Diesel	2798	4	59
04/04→	Boxer Platform/Chassis 2.8 HDi	8140.43N	Diesel	2798	4	58
10/00→	Boxer Platform/Chassis 2.8 HDi	8140.43S Euro 3	Diesel	2798	4	58
04/02→	Boxer Platform/Chassis 2.8 HDi 4x4	8140.43S Euro 3	Diesel	2798	4	58
10/96→09/00	Expert 1.8	XU7JP (LFZ)	Petrol	1761	4	31
12/03→	Expert 1.9 D	DW8 (WJZ)	Diesel	1868	4	27
12/03→	Expert 1.9 D	DW8B (WJY)	Diesel	1868	4	27
02/96→	Expert 1.9 D	XUD9A (D9B)	Diesel	1905	4	32
02/96→	Expert 1.9 TD	XUD9TE (D8B)	Diesel	1905	4	33
02/96→	Expert 1.9 TD	XUD9TE (DHY)	Diesel	1905	4	33
07/00→	Expert 2.0 HDI	DW10ATED (RHZ)	Diesel	1997	4	37

Modelverzeichnis • Index de modele • Índice de Modelo
Indeks modelu • Модель автомобиля • دليل الموديل

MODEL INDEX



CCM

x



07/00→	Expert 2.0 HDI	DW10ATED4 (RHW)	Diesel	1997	4	37
10/00→11/03	Expert 2.0 HDi	DW10BTED (RHX)	Diesel	1997	4	37
01/07→	Expert Box 1.6 HDi 90	DV6UTED4 (9HU)	Diesel	1560	4	10
10/96→09/00	Expert Box 1.8	XU7JP (LFZ)	Petrol	1761	4	31
02/96→	Expert Box 1.9 D	XUD9A (D9B)	Diesel	1905	4	32
12/98→	Expert Box 1.9 D 70	DW8 (WJZ)	Diesel	1868	4	27
12/98→	Expert Box 1.9 D 70	DW8B (WJY)	Diesel	1868	4	27
02/96→	Expert Box 1.9 TD	XUD9TE (D8B)	Diesel	1905	4	33
02/96→	Expert Box 1.9 TD	XUD9TE (DHX)	Diesel	1905	4	33
07/00→	Expert Box 2.0 HDI	DW10ATED (RHZ)	Diesel	1997	4	37
07/00→	Expert Box 2.0 HDI	DW10ATED4 (RHW)	Diesel	1997	4	37
07/00→	Expert Box 2.0 HDI	DW10BTED (RHX)	Diesel	1997	4	37
01/07→	Expert Box 2.0 HDi 120	DW10UTED4 (RHK) Euro 4	Diesel	1997	4	37
01/07→	Expert Box 2.0 HDi 140	DW10BTED4 (RHR)	Diesel	1997	4	37
01/01→	Expert HDi	DW10CTED	Diesel	1997	4	37
01/07→	Expert Platform/Chassis 1.6 HDi 90	DV6UTED4 (9HU)	Diesel	1560	4	10
01/07→	Expert Platform/Chassis 2.0 HDi 120	DW10UTED4 (RHK) Euro 4	Diesel	1997	4	37
01/07→	Expert Platform/Chassis 2.0 HDi 140	DW10BTED4 (RHR)	Diesel	1997	4	37
06/98→11/03	Expert Platform/Chassis 1.9 D	DW8 (WJZ)	Diesel	1868	4	27
06/98→11/03	Expert Platform/Chassis 1.9 D	DW8B (WJY)	Diesel	1868	4	27
02/96→	Expert Platform/Chassis 1.9 D	XUD9A (D9B)	Diesel	1905	4	32
02/96→	Expert Platform/Chassis 1.9 TD	XUD9TE (D8B)	Diesel	1905	4	33
02/96→	Expert Platform/Chassis 1.9 TD	XUD9TE (DHX)	Diesel	1905	4	33
10/00→10/06	Expert Platform/Chassis 2.0 HDi	DW10ATED4 (RHW)	Diesel	1997	4	37
01/07→	Expert Tepee 1.6 HDi 90	DV6UTED4 (9HU)	Diesel	1560	4	10
01/07→	Expert Tepee 2.0 HDi 120	DW10UTED4 (RHK) Euro 4	Diesel	1997	4	37
01/07→	Expert Tepee 2.0 HDi 120 4x4	DW10UTED4 (RHK) Euro 4	Diesel	1997	4	37
01/07→	Expert Tepee 2.0 HDi 140	DW10BTED4 (RHR)	Diesel	1997	4	37
01/83→01/94	J5 Box 1.8	XM7T (169B)	Petrol	1796	4	35
09/87→08/90	J5 Box 1.9 D	XUD9	Diesel	1905	4	32
09/87→03/94	J5 Box 1.9 D	XUD9A (D9B)	Diesel	1905	4	32
09/81→08/90	J5 Box 2.0	XN1P	Petrol	1971	4	47
09/87→08/90	J5 Box 2.0	XN1T	Petrol	1971	4	47
09/90→01/94	J5 Box 2.0	XN1TA	Petrol	1971	4	47
09/90→01/94	J5 Box 2.0	XN1TA (170C)	Petrol	1971	4	47
09/81→01/94	J5 Box 2.5 D	CRD93	Diesel	2498	4	54
10/90→03/94	J5 Box 2.5 D 4x4	CRD93 (U25/651/661)	Diesel	2500	4	54
09/81→01/94	J5 Box 2.5 DT	CRD93L	Diesel	2498	4	54
09/81→08/90	J5 Box 2.5 DT	CRD93LS (U25/673)	Diesel	2500	4	55
10/90→03/94	J5 Box 2.5 TD 4x4	CRD93LS (U25/673)	Diesel	2500	4	55
10/90→02/94	J5 Bus 1.9 D	XUD9A (D9B)	Diesel	1905	4	32
01/83→09/90	J5 Bus 2.0	XN1T (170)	Petrol	1971	4	47
09/81→09/90	J5 Bus 2.0	XN1T (170B)	Petrol	1971	4	47
09/81→02/94	J5 Bus 2.5 D	CRD93 (U25/651/661)	Diesel	2500	4	54
10/90→02/94	J5 Bus 2.5 D 4x4	CRD93 (U25/651/661)	Diesel	2500	4	54
10/90→02/94	J5 Bus 2.5 TD	CRD93LS (U25/673)	Diesel	2500	4	55
10/90→02/94	J5 Bus 2.5 TD 4x4	CRD93LS (U25/673)	Diesel	2500	4	55
10/90→02/94	J5 Platform/Chassis 2.5 TD 4x4	CRD93LS (U25/673)	Diesel	2500	4	55
10/90→02/94	J5 Platform/Chassis 1.9 D	XUD9A (D9B)	Diesel	1905	4	32
01/83→11/88	J5 Platform/Chassis 2.0	XN1T (170)	Petrol	1971	4	47
01/86→11/88	J5 Platform/Chassis 2.0	XN1T (170B)	Petrol	1971	4	47
09/81→02/94	J5 Platform/Chassis 2.5 D	CRD93 (U25/651/661)	Diesel	2500	4	54
09/81→08/90	J5 Platform/Chassis 2.5 D 4x4	CRD93	Diesel	2498	4	54
10/90→02/94	J5 Platform/Chassis 2.5 D 4x4	CRD93 (U25/651/661)	Diesel	2500	4	54
09/81→08/90	J5 Platform/Chassis 2.5 DT	CRD93L	Diesel	2498	4	54
10/90→02/94	J5 Platform/Chassis 2.5 TD	CRD93LS (U25/673)	Diesel	2500	4	55
08/68→03/80	J7 Box 1.6	XC5P (3rd Series)	Petrol	1618	4	36
08/68→03/80	J7 Box 1.6	XC7P	Petrol	1618	4	36
07/70→03/80	J7 Box 1.8	XM7P	Petrol	1796	4	35
08/68→07/78	J7 Box 1.9 D	XDP 4.88	Diesel	1948	4	46

MODEL INDEX

Modelverzeichnis • Index de modele • Índice de Modelo
Indeks modelu • Модель автомобиля • دليل الموديل



CCM

x



9

08/68→07/77	J7 Box 2.1 D	XDP90	Diesel	2112	4	48
07/77→03/80	J7 Box 2.3 D	XD2P94	Diesel	2304	4	56
08/68→07/70	J7 Bus 1.6	XC5P (3rd Series)	Petrol	1618	4	36
07/70→03/80	J7 Bus 1.6	XC7P	Petrol	1618	4	36
07/70→03/80	J7 Bus 1.8	XM7P	Petrol	1796	4	35
08/68→07/78	J7 Bus 1.9 D	XDP 4.88	Diesel	1948	4	46
08/68→07/77	J7 Bus 2.1 D	XDP90	Diesel	2112	4	48
07/77→03/80	J7 Bus 2.3 D	XD2P94	Diesel	2304	4	56
08/68→07/78	J7 Platform/Chassis 1.9 D	XDP 4.88	Diesel	1948	4	46
07/70→03/80	J7 Platform/Chassis 1.8	XM7P	Petrol	1796	4	35
07/77→03/80	J7 Platform/Chassis 2.3 D	XD2P94	Diesel	2304	4	56
08/68→07/78	J7 Platform/Chassis 1.9 D	XDP 4.88	Diesel	1948	4	46
08/68→07/77	J7 Platform/Chassis 2.1 D	XDP90	Diesel	2112	4	48
08/68→07/70	J7 Platform/Chassis 1.6	XC5P (3rd Series)	Petrol	1618	4	36
07/70→03/80	J7 Platform/Chassis 1.6	XC7P	Petrol	1618	4	36
03/80→06/87	J9 Box 1.6	XC7P	Petrol	1618	4	36
03/80→06/87	J9 Box 2.0	XN1P	Petrol	1971	4	47
03/80→07/82	J9 Box 2.3 D	XD2P / XD94	Diesel	2304	4	56
07/82→06/87	J9 Box 2.5 D	XD3P	Diesel	2498	4	56
03/80→06/87	J9 Bus 2.0	XN1P	Petrol	1971	4	47
03/80→07/82	J9 Bus 2.3 D	XD2P / XD94	Diesel	2304	4	56
08/82→06/87	J9 Bus 2.5 D	XD3P	Diesel	2498	4	56
03/80→06/87	J9 Platform/Chassis 2.0	XN1P	Petrol	1971	4	47
03/80→07/82	J9 Platform/Chassis 2.3 D	XD2P / XD94	Diesel	2304	4	56
07/82→06/87	J9 Platform/Chassis 2.5 D	XD3P	Diesel	2498	4	56
09/96→	Partner 1.4	TU3.2, TU3.2 F, TU3.2 F2	Petrol	1360	4	12
06/96→	Partner Box 1.1	TU1M (HDZ)	Petrol	1124	4	5
11/02→10/06	Partner Box 1.4	TU3A (KFV)	Petrol	1360	4	12
06/96→	Partner Box 1.4	TU3JP (KFX)	Petrol	1360	4	13
04/03→	Partner Box 1.4 BiFuel	TU3JP (KFW)	Petrol	1360	4	13
09/00→	Partner Box 1.6	TU5JP4 (NFU/N6A)	Petrol	1587	4	21
04/08→	Partner Box 1.6 HDi	DV6ATED4 (9HX) Euro 4	Diesel	1560	4	10
04/08→	Partner Box 1.6 HDi	DV6BTED4 (9HT) Euro 4	Diesel	1560	4	11
03/13→	Partner Box 1.6 HDi	DV6C (9HL)	Diesel	1560	4	11
04/08→	Partner Box 1.6 HDi	DV6TED4 (9HZ) Euro 4	Diesel	1560	4	10
04/12→	Partner Box 1.6 HDi 4x4	DV6ATED4 (9HX) Euro 4	Diesel	1560	4	10
02/06→	Partner Box 1.6 HDi 75	DV6BTED4 (9HW) Euro 4	Diesel	1560	4	11
02/06→	Partner Box 1.6 HDi 90	DV6ATED4 (9HX) Euro 4	Diesel	1560	4	10
06/96→	Partner Box 1.8 D	XUD7 (A9A)	Diesel	1769	4	23
06/96→	Partner Box 1.9 D	DW8 (WJZ)	Diesel	1868	4	27
06/96→	Partner Box 1.9 D	DW8B (WJY)	Diesel	1868	4	27
05/96→	Partner Box 1.9 D	XUD9A (DJY)	Diesel	1905	4	32
04/04→	Partner Box 1.9 D 4x4	DW8B (WJY)	Diesel	1868	4	27
04/00→	Partner Box 2.0 HDi	DW10TD (RHY)	Diesel	1997	4	37
04/04→	Partner Box 2.0 HDi 4x4	DW10TD (RHY)	Diesel	1997	4	37
06/96→	Partner Combispace 1.1	TU1JP (HFX)	Petrol	1124	4	6
06/96→	Partner Combispace 1.1	TU1M (HDZ)	Petrol	1124	4	5
06/96→	Partner Combispace 1.4	TU3JP (KFW)	Petrol	1360	4	13
06/96→	Partner Combispace 1.4	TU3JP (KFX)	Petrol	1360	4	13
07/01→	Partner Combispace 1.6 16V	TU5JP4 (NFU/N6A)	Petrol	1587	4	21
02/06→	Partner Combispace 1.6 HDi 75	DV6BTED4 (9HW) Euro 4	Diesel	1560	4	11
02/06→	Partner Combispace 1.6 HDi 90	DV6ATED4 (9HX) Euro 4	Diesel	1560	4	10
05/97→	Partner Combispace 1.8	XU7JB (LFX)	Petrol	1761	4	31
12/98→	Partner Combispace 1.9 D	DW8 (WJZ)	Diesel	1868	4	27
12/98→	Partner Combispace 1.9 D	DW8B (WJY)	Diesel	1868	4	27
05/96→12/98	Partner Combispace 1.9 D	XUD9	Diesel	1905	4	32
06/96→	Partner Combispace 1.9 D	XUD9A (DJY)	Diesel	1905	4	32
04/04→08/05	Partner Combispace 1.9 D 4x4	DW8B (WJY)	Diesel	1868	4	27
02/00→	Partner Combispace 2.0 HDi	DW10TD (RHY)	Diesel	1997	4	37
04/04→08/05	Partner Combispace 2.0 HDi 4x4	DW10TD (RHY)	Diesel	1997	4	37

Modelverzeichnis • Index de modele • Índice de Modelo
Indeks modelu • Модель автомобиля • دليل الموديل

MODEL INDEX



CCM

x



9

01/09→	Partner Platform/Chassis 1.6 HDi	DV6ATED4 (9HX) Euro 4	Diesel	1560	4	10
01/09→	Partner Platform/Chassis 1.6 HDi	DV6BTED4 (9HT) Euro 4	Diesel	1560	4	11
04/08→	Partner Tepee 1.6	TU5JP4 (NFU/N6A)	Petrol	1587	4	21
04/08→	Partner Tepee 1.6 HDi	DV6ATED4 (9HX) Euro 4	Diesel	1560	4	10
04/08→	Partner Tepee 1.6 HDi	DV6BTED4 (9HT) Euro 4	Diesel	1560	4	11
03/13→	Partner Tepee 1.6 HDi	DV6C (9HL)	Diesel	1560	4	11
04/08→	Partner Tepee 1.6 HDi	DV6TED4 (9HZ) Euro 4	Diesel	1560	4	10
04/10→	Partner Tepee 1.6 HDi 90	DV6ATED4 (9HX) Euro 4	Diesel	1560	4	10

ENGINE INDEX

Motorverzeichnis • Index de moteur • Índice de Motor
Indeks silnika • Модель двигателя • دليل المحرك



CCM



9

1KR (384 F)	Petrol	998	3	71.00	4
4HU Euro 4	Diesel	2198	4	86.00	41
4HV Euro 4	Diesel	2198	4	86.00	41
199 A9.000 Euro 5	Diesel	1248	4	69.60	1
8140.43N	Diesel	2798	4	94.40	58
8140.43S Euro 3	Diesel	2798	4	94.40	58
8140.63 (F28D)	Diesel	2798	4	94.40	59
CRD93	Diesel	2498	4	93.00	54
CRD93 (U25/651/661)	Diesel	2500	4	93.00	54
CRD93L	Diesel	2498	4	93.00	54
CRD93LS (U25/673)	Diesel	2500	4	93.00	55
DJ5 (T9A)	Diesel	2446	4	92.00	50
DJ5T (T8A/THZ)	Diesel	2446	4	92.00	51
DJ5TED (THX)	Diesel	2446	4	92.00	52
DK5ATE (THY)	Diesel	2446	4	92.00	53
DT17TED4	Diesel	2721	6	81.00	26
DT20C Euro 5	Diesel	2993	V6	84.00	34
DV4TD (8HS)	Diesel	1398	4	73.70	8
DV4TD (8HT)	Diesel	1398	4	73.70	8
DV4TD (8HX)	Diesel	1399	4	73.70	8
DV4TD (8HZ)	Diesel	1398	4	73.70	8
DV4TED4 (8HY)	Diesel	1399	4	73.70	8
DV6ATED4 (9HV)	Diesel	1560	4	75.00	10
DV6ATED4 (9HX) Euro 4	Diesel	1560	4	75.00	10
DV6BTED4 (9HT) Euro 4	Diesel	1560	4	75.00	11
DV6BTED4 (9HW) Euro 4	Diesel	1560	4	75.00	11
DV6C (9HL)	Diesel	1560	4	75.00	11
DV6C (9HR)	Diesel	1560	4	75.00	11
DV6CTED (9HD)	Diesel	1560	4	75.00	11
DV6DTE4 (9HF) Euro 4	Diesel	1560	4	75.00	11
DV6DTE4 (9HP) Euro 4	Diesel	1560	4	75.00	11
DV6DTE4 (9HJ) Euro 4	Diesel	1560	4	75.00	11
DV6ETED4 (9HK) Euro 4	Diesel	1560	4	75.00	11
DV6TED4 (9HY) Euro 4	Diesel	1560	4	75.00	10
DV6TED4 (9HZ) Euro 4	Diesel	1560	4	75.00	10
DV6UTED4 (9HU)	Diesel	1560	4	75.00	10
DW8 (WJZ)	Diesel	1868	4	82.20	27
DW8B (WJY)	Diesel	1868	4	82.20	27
DW10ATED (RHS)	Diesel	1997	4	85.00	37
DW10ATED (RHZ)	Diesel	1997	4	85.00	37
DW10ATED4 (RHM)	Diesel	1997	4	85.00	37
DW10ATED4 (RHT)	Diesel	1997	4	85.00	37
DW10ATED4 (RHW)	Diesel	1997	4	85.00	37
DW10BTED (RHX)	Diesel	1997	4	85.00	37
DW10BTED4 (RHF)	Diesel	1997	4	85.00	37
DW10BTED4 (RHR)	Diesel	1997	4	85.00	37
DW10CTED	Diesel	1997	4	85.00	37
DW10TD (RHV)	Diesel	1997	4	85.00	37
DW10TD (RHY)	Diesel	1997	4	85.00	37
DW10UTD (RHV)	Diesel	1997	4	85.00	37
DW10UTED4 (RHK) Euro 4	Diesel	1997	4	85.00	37
DW12BTED4 (4HW)	Diesel	2179	4	85.00	37
DW12C (4HL) Euro 5	Diesel	2179	4	85.00	38
DW12MTED4 (4HK)	Diesel	2179	4	85.00	38
DW12MTED4 (4HN)	Diesel	2179	4	85.00	38
DW12TED4 (4HX/4HW)	Diesel	2179	4	85.00	37
DW12TED4 (4HZ)	Diesel	2179	4	85.00	37
DW12UTED (4HY)	Diesel	2179	4	85.00	37
E1	Petrol	1118	4	74.00	9
ES9J4 (XFZ)	Petrol	2946	6	87.00	44

Motorverzeichnis • Index de moteur • Índice de Motor
Indeks silnika • Модель двигателя • دليل المحرك

ENGINE INDEX



CCM

x



9

ES9J4S (XFX/XFW)	Petrol	2946	6	87.00	44
EW7J4 (6FZ)	Petrol	1749	4	82.70	28
F1	Petrol	1118	4	74.00	9
G1 / G2	Petrol	1294	4	76.70	16
J2	Flexfuel	1592	4	80.60	25
J7T	Petrol	2165	4	88.00	45
KF5	Petrol	1796	4	84.00	35
KF6	Petrol	1796	4	84.00	35
TU1 (H1A/H1B/H3A)	Petrol	1124	4	72.00	5
TU1JP (HFX)	Petrol	1124	4	72.00	6
TU1JP (HFZ)	Petrol	1124	4	72.00	6
TU1M (HDY)	Petrol	1124	4	72.00	5
TU1M (HDZ)	Petrol	1124	4	72.00	5
TU2.4	Petrol	1294	4	75.00	12
TU3 F (Cast Iron Block)	Petrol	1360	4	75.00	12
TU3 F2 (Cast Iron Block)	Petrol	1360	4	75.00	12
TU3 F2C (Cast Iron Block),	Petrol	1360	4	75.00	12
TU3 FJ2 (Cast Iron Block)	Petrol	1360	4	75.00	12
TU3 FM (Cast Iron Block)	Petrol	1360	4	75.00	12
TU3.2, TU3.2 F, TU3.2 F2	Petrol	1360	4	75.00	12
TU3A (K1D)	Petrol	1360	4	75.00	12
TU3A (K6D)	Petrol	1360	4	75.00	12
TU3A (K6E)	Petrol	1360	4	75.00	12
TU3A (K6F)	Petrol	1360	4	75.00	12
TU3A (KFT)	Petrol	1360	4	75.00	12
TU3A (KFV)	Petrol	1360	4	75.00	12
TU3A (KFW)	Petrol	1360	4	75.00	12
TU3CP (KAY)	Petrol	1360	4	75.00	12
TU3J2 (KFZ)	Petrol	1360	4	75.00	12
TU3JP (KFW)	Petrol	1360	4	75.00	13
TU3JP (KFX)	Petrol	1360	4	75.00	13
TU3JP-L4	Petrol	1360	4	75.00	13
TU3M (KDY)	Petrol	1360	4	75.00	12
TU3M (KDZ)	Petrol	1360	4	75.00	12
TU3MC (KDX)	Petrol	1360	4	75.00	12
TU3S (K2B)	Petrol	1360	4	75.00	12
TU5J2 (NFW)	Petrol	1587	4	78.50	20
TU5J2 (NFW/NFY)	Petrol	1587	4	78.50	20
TU5J4 (NFX)	Petrol	1587	4	78.50	21
TU5JP (NFZ)	Petrol	1587	4	78.50	20
TU5JP4 (N6A)	Petrol	1587	4	78.50	20
TU5JP4 (NFU/N6A)	Petrol	1587	4	78.50	21
TU9	Petrol	954	4	70.00	2
TU9M (CDY)	Petrol	954	4	70.00	2
TU9M (CDZ)	Petrol	954	4	70.00	2
TUD3	Diesel	1360	4	75.00	14
TUD5 (VJX)	Diesel	1527	4	77.00	17
TUD5 (VJY)	Diesel	1527	4	77.00	17
XC5P (3rd Series)	Petrol	1618	4	84.00	36
XC6	Petrol	1618	4	84.00	36
XC7P	Petrol	1618	4	84.00	36
XD 4.88	Diesel	1948	4	88.00	46
XD 88	Diesel	1948	4	88.00	46
XD2	Diesel	2304	4	94.00	56
XD2 (134)	Diesel	2304	4	94.00	56
XD2P / XD94	Diesel	2304	4	94.00	56
XD2P94	Diesel	2304	4	94.00	56
XD2S (147)	Diesel	2304	4	94.00	57
XD3 (155)	Diesel	2498	4	94.00	56
XD3P	Diesel	2498	4	94.00	56

ENGINE INDEX

Motorverzeichnis • Index de moteur • Índice de Motor
Indeks silnika • Модель двигателя • دليل المحرك



CCM

x



9

XD3T	Diesel	2498	4	94.00	57
XD3T (152A)	Diesel	2498	4	94.00	57
XD3TE (152B)	Diesel	2498	4	94.00	57
XD90	Diesel	2112	4	90.00	48
XDP 4.88	Diesel	1948	4	88.00	46
XDP90	Diesel	2112	4	90.00	48
XID (149)	Diesel	1548	4	80.00	22
XK5	Petrol	1130	4	78.00	18
XL4D	Diesel	1357	4	78.00	19
XL5	Petrol	1290	4	78.00	18
XL5 (118)	Petrol	1290	4	78.00	18
XL5S	Petrol	1290	4	78.00	18
XM	Petrol	1796	4	84.00	35
XM7	Petrol	1796	4	84.00	35
XM7 (105)	Petrol	1796	4	84.00	35
XM7A (105C)	Petrol	1796	4	84.00	35
XM7P	Petrol	1796	4	84.00	35
XM7T (169B)	Petrol	1796	4	84.00	35
XN1	Petrol	1971	4	88.00	47
XN1 (106)	Petrol	1971	4	88.00	47
XN1A (106E)	Petrol	1971	4	88.00	47
XN1P	Petrol	1971	4	88.00	47
XN1T	Petrol	1971	4	88.00	47
XN1T (170)	Petrol	1971	4	88.00	47
XN1T (170B)	Petrol	1971	4	88.00	47
XN1TA	Petrol	1971	4	88.00	47
XN1TA (170C)	Petrol	1971	4	88.00	47
XN2 (107)	Petrol	1971	4	88.00	47
XR5 (142)	Petrol	1472	4	78.00	18
XR5A (142)	Petrol	1472	4	78.00	18
XR5S (117)	Petrol	1472	4	78.00	18
XU5 (B1AA)	Petrol	1580	4	83.00	29
XU5CP (BAZ)	Petrol	1580	4	83.00	29
XU5J (180)	Petrol	1580	4	83.00	30
XU5J (180A)	Petrol	1580	4	83.00	30
XU5J (B6B)	Petrol	1580	4	83.00	30
XU5JP (BFZ)	Petrol	1580	4	83.00	31
XU5M (BDZ)	Petrol	1580	4	83.00	30
XU5S (171)	Petrol	1580	4	83.00	29
XU7JB (LFX)	Petrol	1761	4	83.00	31
XU7JP (LFW)	Petrol	1761	4	83.00	31
XU7JP (LFZ)	Petrol	1761	4	83.00	31
XU7JP4 (LFY)	Petrol	1761	4	83.00	31
XU9J1 (DFZ)	Petrol	1905	4	83.00	30
XU9J2 (D6A)	Petrol	1905	4	83.00	30
XU9J4 (D6C/DFW)	Petrol	1905	4	83.00	31
XU9J4 (DFW)	Petrol	1905	4	83.00	31
XU9JA (D6B)	Petrol	1905	4	83.00	30
XU9JAZ (DKZ)	Petrol	1905	4	83.00	30
XU9M (DDZ)	Petrol	1905	4	83.00	30
XU9S (D2B)	Petrol	1905	4	83.00	30
XU10J2 (RFU)	Petrol	1998	4	86.00	42
XU10J2 (RFW)	Petrol	1998	4	86.00	42
XU10J2 (RFX)	Petrol	1998	4	86.00	42
XU10J2 (RFZ/R6A)	Petrol	1998	4	86.00	42
XU10J2TE (RGX)	Petrol	1998	4	86.00	42
XU10J2TE (RGY)	Petrol	1998	4	86.00	42
XU10J4 (RFT)	Petrol	1998	4	86.00	42
XU10J4 (RFT/RFY)	Petrol	1998	4	86.00	42
XU10J4R (RFV/R6E)	Petrol	1998	4	86.00	42

Motorverzeichnis • Index de moteur • Índice de Motor
Indeks silnika • Модель двигателя • دليل المحرك

ENGINE INDEX



CCM















x



9

XU51C (B1A/B1C/B1E)	Petrol	1580	4	83.00	29
XU51C (B1D)	Petrol	1580	4	83.00	29
XU52C (B2A)	Petrol	1580	4	83.00	29
XU92C	Petrol	1905	4	83.00	30
XU92C (D2A)	Petrol	1905	4	83.00	30
XU92C (D2C)	Petrol	1905	4	83.00	30
XU102C (R5A)	Petrol	1998	4	86.00	42
XUD7 (161A)	Diesel	1769	4	80.00	23
XUD7 (A9A)	Diesel	1769	4	80.00	23
XUD7T	Diesel	1769	4	80.00	24
XUD7TE (A8A)	Diesel	1769	4	80.00	24
XUD7TE (A8B)	Diesel	1769	4	80.00	24
XUD7TE (AJZ)	Diesel	1769	4	80.00	24
XUD9	Diesel	1905	4	83.00	32
XUD9 (162)	Diesel	1905	4	83.00	32
XUD9 (D9A)	Diesel	1905	4	83.00	32
XUD9 (DJZ)	Diesel	1905	4	83.00	32
XUD9A (D9B)	Diesel	1905	4	83.00	32
XUD9A (D9B/DJY)	Diesel	1905	4	83.00	33
XUD9A (DJY)	Diesel	1905	4	83.00	32
XUD9BSD (DHV)	Diesel	1905	4	83.00	33
XUD9SD (DHW)	Diesel	1905	4	83.00	33
XUD9TE	Diesel	1905	4	83.00	33
XUD9TE (D8B)	Diesel	1905	4	83.00	33
XUD9TE (DHX)	Diesel	1905	4	83.00	33
XUD9TE (DHY)	Diesel	1905	4	83.00	33
XUD9UTF (D8C)	Diesel	1905	4	83.00	33
XUD11A (P9A/PJZ)	Diesel	2138	4	86.00	43
XUD11ATE (PHZ/P8A/P8B)	Diesel	2088	4	85.00	39
XUD11BTE (P8C)	Diesel	2088	4	85.00	40
XV3	Petrol	954	4	70.00	3
XV5	Petrol	954	4	70.00	3
XV8 (108C)	Petrol	954	4	70.00	3
XW3S	Petrol	1124	4	72.00	7
XW3S (121)	Petrol	1124	4	72.00	7
XW7 (109F)	Petrol	1124	4	72.00	7
XW7 (109N)	Petrol	1124	4	72.00	7
XY6B (150)	Petrol	1360	4	75.00	15
XY7 (150D)	Petrol	1360	4	75.00	15
XY7 (150G)	Petrol	1360	4	75.00	15
XY8 (150B)	Petrol	1360	4	75.00	15
XY8 (150H)	Petrol	1360	4	75.00	15
XZ5 (129)	Petrol	1219	4	75.00	15
ZDJ (851)	Petrol	2165	4	88.00	45
ZDJL (851B)	Petrol	2165	4	88.00	45
ZDJL (851X)	Petrol	2165	4	88.00	45
ZEJ (829)	Petrol	1995	4	88.00	45
ZM (112)	Petrol	2664	6	88.00	47
ZMJ (140)	Petrol	2664	6	88.00	47
ZN3J (154X)	Petrol	2849	6	91.00	49



Bipper 1.3 HDi 75, Bipper Tepee 1.3 HDi 75		10/10→	199 A9.000 Euro 5	1	
			4cyl. 1248cc 55kW (75PS)		
			Diesel Turbo Intercooled	TD26979	
08-435700-00	STD	69.60	1.500	 001 GDC P	KV4
08-435706-00	0.40mm		1.500	 005 P	F12/F14
			2.000	 231 LKZ CR P	GOE13
				 	
106 I 1.0 106 Van 1.0 205 II 1.0		09/91→04/96 09/91→03/01 10/87→09/98	TU9	2	
			4cyl. 954cc 33kW (45PS)		
				TD2783	
106 I 1.0 106 II 1.0 i 106 Van 1.0		09/91→04/96 05/96→ 09/91→03/01	TU9M (CDY)		
			4cyl. 954cc 37kW (50PS)		
				TD4841	
106 I 1.0 106 II 1.0 i 205 II 1.0		09/91→04/96 01/97→ 08/92→05/97	TU9M (CDZ)		
			4cyl. 954cc 37kW (50PS)		
				TD9405	
08-154200-00	STD	70.00	1.500	 001 IF CR P	IKA
08-154206-00	0.40mm		1.500	 005 IF P	STD
08-154208-00	0.60mm		3.000	 712 CR	ST
<i>[R46910]</i>					
104 0.9 104 Coupe 0.9		10/72→10/79 09/73→10/83	XV3	3	
			4cyl. 954cc 24kW (32PS)		
				TD2892	
104 0.9 104 Coupe 0.9		10/79→10/83 09/73→10/83	XV5		
			4cyl. 954cc 26kW (35PS)		
				TD2893	
104 1.0 205 I 1.0		09/83→06/88 02/83→10/87	XV8 (108C)		
			4cyl. 954cc 33kW (45PS)		
				TD2894	
08-317300-00	STD	70.00	2.000	 001 IF CR P	STD
<i>[R66100]</i>			2.000	 026 P	STD
			4.000	 712 CR	ST
107 1.0		06/05→	1KR (384 F)	4	
			3cyl. 998cc 50kW (68PS)		
				TD20286	
08-439600-00	STD	71.00	1.000	 001 IF CR	ST
			1.000	 026	ST
			1.500	 231 PVD	ST



205 Box 1.1	08/87→07/90	TU1 (H1A/H1B/H3A)				5
205 II 1.1	10/87→10/90	4cyl.				
309 II 1.1	09/89→10/93	1124cc	40kW (54PS)			
TD2758						

106 II 1.1 i	01/97→	TU1M (HDY)				6
		4cyl.				
		1124cc	40kW (54PS)			
TD9404						

106 I 1.1	09/91→04/96	TU1M (HDZ)				7
106 II 1.1 i	05/96→	4cyl.				
205 I Convertible 1.1 CJ	10/89→12/94	1124cc	44kW (60PS)			
205 II 1.1	07/89→09/98					
306 1.1	06/94→05/01					
306 Hatchback 1.1	05/93→05/01					
309 II 1.1	08/90→12/93					
Partner Box 1.1, Partner Combispace 1.1	06/96→					
TD4834						

08-154300-00	STD	72.00	1.500		001 IF CR P	IKA
08-154307-00	0.50mm		2.000		026 P	STD
[R60860]			3.000		712 CR	ST

106 II 1.1 i	05/96→	TU1JP (HFX)				6
206 Hatchback 1.1 i	09/98→	4cyl.				
206 SW 1.1	07/02→	1124cc	44kW (60PS)			
206+ 1.1	01/09→					
Partner Combispace 1.1	06/96→					
TD14728						

206 Hatchback 1.1 i	09/98→	TU1JP (HFZ)				7
		4cyl.				
		1124cc	44kW (60PS)			
TD9848						

08-426300-00	STD	72.00	1.500		001 NT	KV1
			1.500		026 P	GOE13
			2.500		236 P	GOE13

104 1.1	09/78→09/79	XW3S				7
104 Coupe 1.1	09/73→09/79	4cyl.				
		1124cc	48kW (65PS)			TD12688

104 Coupe 1.1	08/75→06/80	XW3S (121)				7
		4cyl.				
		1124cc	49kW (67PS)			
TD2896						

104 1.1	08/80→06/88	XW7 (109F)				7
104 Coupe 1.1	08/79→06/88	4cyl.				
205 I 1.1	02/83→10/87	1124cc	37kW (50PS)			
TD2899						

205 I 1.1	02/83→10/87	XW7 (109N)				7
205 II 1.1	10/87→10/90	4cyl.				
		1124cc	36kW (49PS)			
TD2900						

08-319400-00	STD	72.00	1.500		001 IF CR P	STD
[R66090]			2.000		026 P	STD
			4.000		712 CR	ST



Bipper 1.4 HDi	02/08 →	DV4TD (8HS)	4cyl.	1398cc	50kW (68PS)	8
Bipper Tepee 1.4 HDi	04/08 →	Diesel	Turbo Intercooled			
						TD24699
107 1.4 HDi	06/05 →	DV4TD (8HT)	4cyl.	1398cc	40kW (54PS)	8
		Diesel	Turbo Intercooled			
						TD24924
206 Hatchback 1.4 HDi	09/02 → 02/07	DV4TD (8HX)	4cyl.	1399cc	52kW (71PS)	8
206 Hatchback 1.4 HDi eco 70	09/01 →	Diesel	Turbo Intercooled			
206 SW 1.4 HDi	07/02 →					
206 Van 1.4 HDi	09/01 → 03/09					
206+ 1.4 HDi eco 70	01/09 →					
307 1.4 HDi	10/01 →					
1007 1.4 HDi	04/05 →					
206 Hatchback 1.4 HDi eco 70	09/01 →	DV4TD (8HZ)	4cyl.	1398cc	50kW (68PS)	8
206 Saloon 1.4 HDi eco 70	09/08 →	Diesel	Turbo Intercooled			
206 Van 1.4 HDi	09/01 → 03/09					
206+ 1.4 HDi eco 70	01/09 →					
207 1.4 HDi	02/06 →					
207 Van 1.4 HDi	04/07 →					
307 1.4 HDi	10/01 →					
307 Break 1.4 HDi	03/02 →					
307 SW 1.4 HDi 70	03/02 → 01/05					
1007 1.4 HDi	04/05 →					
						TD17509
206 1.4 TD, 307 1.4 TD	01/02 →	DV4TED4 (8HY)	4cyl.	1399cc	66kW (89PS)	8
		Diesel	Turbo Intercooled			
						FM19023





08-135300-00	STD	73.70	2.500		008 CK P	KV1
08-135305-00	0.25mm		1.950		005 IFU P	GOE12
08-135307-00	0.50mm		2.500		231 CR P	GOE12
[R66770]						

205 II 1.1 XA	07/87 → 10/88	E1	4cyl.	1118cc	40kW (54PS)	9
309 I 1.1	10/85 → 07/89					
						TD4832
205 II 1.2	01/87 → 12/90	F1	4cyl.	1118cc	46kW (63PS)	9
						TD2750

08-344500-00	STD	74.00	1.750		001 IF CR P	IKA
[R66370]			2.000		026 P	STD
			4.000		712 CR	ST



207 1.6 HDi 307 1.6 HDi, 307 Break 1.6 HDi 307 SW 1.6 HDi 90 308 SW 1.6 HDi	02/06→ 04/05→ 12/06→ 09/07→	DV6ATED4 (9HV) 4cyl. 1560cc 66kW (89PS) Diesel Turbo Intercooled	10 TD24730
207 1.6 HDi 207 SW 1.6 HDi 207 Van 1.6 HDi 308 SW 1.6 HDi Partner Box 1.6 HDi Partner Box 1.6 HDi 4x4 Partner Box 1.6 HDi 90, Partner Comspace 1.6 HDi 90 Partner Platform/Chassis 1.6 HDi Partner Tepee 1.6 HDi Partner Tepee 1.6 HDi 90	02/06→ 06/07→ 04/07→ 09/07→ 04/08→ 04/12→ 02/06→ 01/09→ 04/08→ 04/10→	DV6ATED4 (9HX) Euro 4 4cyl. 1560cc 66kW (89PS) Diesel Turbo Intercooled	TD20147
206 Hatchback 1.6 HDi 110 207 1.6 HDi 307 1.6 HDi 110, 307 Break 1.6 HDi 110, 307 SW 1.6 HDi 110 407 1.6 HDi 110, 407 SW 1.6 HDi 110	05/04→ 02/06→ 02/04→ 05/04→	DV6TED4 (9HY) Euro 4 4cyl. 1560cc 80kW (109PS) Diesel Turbo Intercooled	TD17506
206 CC 1.6 HDi 110 206 Hatchback 1.6 HDi 110, 206 SW 1.6 HDi 110 207 1.6 HDi 207 1.6 HDi 110 207 CC 1.6 HDi 207 SW 1.6 HDi 307 1.6 HDi 110, 307 Break 1.6 HDi 110, 307 SW 1.6 HDi 110 308 1.6 HDi, 308 SW 1.6 HDi 1007 1.6 HDi 3008 1.6 HDi 5008 1.6 HDi Partner Box 1.6 HDi, Partner Tepee 1.6 HDi	04/05→ 05/04→ 02/06→ 08/09→ 02/07→ 06/07→ 02/04→ 09/07→ 06/07→ 06/09→ 09/09→ 04/08→	DV6TED4 (9HZ) Euro 4 4cyl. 1560cc 80kW (109PS) Diesel Turbo Intercooled	TD18520
Expert Box 1.6 HDi 90, Expert Platform/ Chassis 1.6 HDi 90, Expert Tepee 1.6 HDi 90	01/07→	DV6UTED4 (9HU) 4cyl. 1560cc 66kW (89PS) Diesel Turbo Intercooled	TD24693

08-424000-00	STD	75.00	3.000		008 CK P	KV1
08-424007-00	0.50mm		1.950		005 P	F12/F14
08-424008-00	0.60mm		2.500		231 LKZ CR P	GOE12
						

Partner Box 1.6 HDi Partner Platform/Chassis 1.6 HDi Partner Tepee 1.6 HDi	04/08→ 01/09→ 04/08→	DV6BTED4 (9HT) Euro 4 4cyl. 1560cc 55kW (75PS) Diesel Turbo Intercooled	11 TD23537
Partner Box 1.6 HDi 75, Partner Comspace 1.6 HDi 75	02/06→	DV6BTED4 (9HW) Euro 4 4cyl. 1560cc 55kW (75PS) Diesel Turbo Intercooled	TD24701
Partner Box 1.6 HDi, Partner Tepee 1.6 HDi	03/13→	DV6C (9HL) 4cyl. 1560cc 82-85kW (112-116PS) Diesel Turbo Intercooled	TD26986





207 CC 1.6 HDi, 207 SW 1.6 HDi	08/09→				DV6C (9HR)		
308 1.6 HDi	12/09→				4cyl.		
308 CC 1.6 HDi	06/09→				1560cc	82kW (111PS)	
308 SW 1.6 HDi	12/09→				Diesel	Turbo Intercooled	
508 1.6 HDi, 508 SW 1.6 HDi	11/10→						
3008 1.6 HDi, 5008 1.6 HDi	08/10→						TD26421
508 1.6 HDi, 508 SW 1.6 HDi	02/12→				DV6CTED (9HD)		
2008 1.6 HDi, 3008 1.6 HDi, 5008 1.6 HDi	03/13→				4cyl.		
					1560cc	84kW (114PS)	
					Diesel	Turbo Intercooled	TD26896
301 1.6 HDi 90	11/12→				DV6DTE (9HF) Euro 4		
					4cyl.		
					1560cc	66kW (89PS)	
					Diesel	Turbo Intercooled	TD26710
207 1.6 HDi, 207 SW 1.6 HDi	11/09→				DV6DTE (9HP) Euro 4		
208 1.6 HDi	03/12→				4cyl.		
308 1.6 HDi, 308 SW 1.6 HDi	11/09→				1560cc	68kW (92PS)	
2008 1.6 HDi	03/13→				Diesel	Turbo Intercooled	TD27064
207 1.6 HDi, 207 SW 1.6 HDi	11/09→				DV6DTE (9HJ) Euro 4		
208 1.6 HDi	03/12→				4cyl.		
308 1.6 HDi, 308 SW 1.6 HDi	11/09→				1560cc	68kW (92PS)	
2008 1.6 HDi	03/13→				Diesel	Turbo Intercooled	TD27967
207 1.6 HDi, 207 SW 1.6 HDi	11/09→				DV6ETE (9HK) Euro 4		
208 1.6 HDi	03/12→				4cyl.		
308 1.6 HDi, 308 SW 1.6 HDi	11/09→				1560cc	55kW (75PS)	
2008 1.6 HDi	03/13→				Diesel	Turbo Intercooled	TD27968
08-433600-00	STD	75.00	2.500		008 CK P		KV1
08-433607-00	0.50mm		1.950		026 P		F12/F14
			2.000		231 LKZ CR P		KV1
205 II 1.3 Rallye	10/87→10/90				TU2.4		12
					4cyl.		
					1294cc	70kW (95PS)	
							TD12689
106 1.4 i Le Mans, 106 1.4 i XSI, 106 1.4i	09/91→				TU3 F (Cast Iron Block), TU3 F2 (Cast Iron Block),		
205 1.4 i, 309 1.4 i	01/91→				TU3 F2C (Cast Iron Block), TU3 FJ2 (Cast Iron Block),		
405 1.4 i GL, 405 1.4 i GR	01/93→				TU3 FM (Cast Iron Block)		
					4cyl.		
					1360cc		
					SPi		FM38715
205	06/91→				TU3.2, TU3.2 F, TU3.2 F2		
405 GL	01/92→				4cyl.		
Partner 1.4	09/96→				1360cc		
							FM28714
205 I Convertible 1.4 CJ	03/89→12/94				TU3A (K1D)		
205 II 1.4	10/87→10/90				4cyl.		
309 I 1.4	03/89→07/89				1360cc	49kW (67PS)	
309 II 1.4	07/90→12/93						TD2766
205 1.4	06/87→12/94				TU3A (K6D)		
					4cyl.		
					1360cc	53kW (72PS)	
							TD24928





205 1.4	06/87→12/94	TU3A (K6E)	4cyl. 1360cc	53kW (72PS)	TD24930
205 1.4	06/87→12/94	TU3A (K6F)	4cyl. 1360cc	53kW (72PS)	TD24929
206+ 1.4 i	09/10→	TU3A (KFT)	4cyl. 1360cc	54kW (73PS)	TD24931
206 Saloon 1.4	03/07→	TU3A (KFV)	4cyl. 1360cc	54kW (73PS)	TD21111
206 SW 1.4	07/02→				
206+ 1.4 i	01/09→				
207 1.4	02/06→				
207 Saloon 1.4	12/07→				
207 SW 1.4	06/07→				
Bipper 1.4	02/08→				
Bipper Tepee 1.4	04/08→				
Partner Box 1.4	11/02→10/06				
206+ 1.4 i	01/09→	TU3A (KFW)	4cyl. 1360cc	55kW (75PS)	TD24927
207 1.4	08/08→				
207 Saloon 1.4 Bioflex	11/08→				
205 I Convertible 1.4 CJ CAT	01/89→09/93	TU3CP (KAY)	4cyl. 1360cc	44kW (60PS)	TD2767
205 II 1.4 CAT	08/87→09/93				
106 I 1.4	09/91→04/96	TU3J2 (KFZ)	4cyl. 1360cc	69kW (93PS)	TD2770
106 I 1.4	09/91→04/96	TU3M (KDY)	4cyl. 1360cc	55-58kW (75-79PS)	TD4836
205 I Convertible 1.4 CJ	05/91→12/94				
205 II 1.4	07/88→09/98				
309 I 1.4	03/89→07/89				
309 II 1.4	07/89→12/93				
205 I Convertible 1.4 CJ	05/91→12/94	TU3M (KDZ)	4cyl. 1360cc	55kW (75PS)	TD2775
205 II 1.4	07/88→09/98				
309 I 1.4	03/89→07/89				
309 II 1.4	07/89→12/93				
106 I 1.4	09/91→04/96	TU3MC (KDX)	4cyl. 1360cc	55-56kW (75-76PS)	TD2777
205 II 1.4	08/90→07/98				
306 1.4 SL	06/94→05/01				
306 Hatchback 1.4	05/93→05/01				
405 II 1.4	08/92→10/95				
405 II Break 1.4	08/92→10/96				
205 I Convertible 1.4	08/87→06/94	TU3S (K2B)	4cyl. 1360cc	62kW (84PS)	TD2779
205 II 1.4	06/87→12/89				
309 I 1.4	03/89→07/89				

08-154400-00	STD	75.00	1.750		001 IF CR P	IKA
08-154407-00	0.50mm		2.000		026 P	STD
[R60880]			3.000		236 P	STD



106 II 1.4 i	05/96→	TU3JP (KFW)							13
206 Hatchback 1.4 i	09/98→		4cyl.						
206 Saloon 1.4	03/07→			1360cc		55kW (75PS)			
206 SW 1.4	07/02→								
306 1.4 SL	06/94→05/01								
306 Break 1.4	03/97→04/02								
306 Hatchback 1.4	05/93→05/01								
307 1.4	08/00→								
307 Break 1.4, 307 SW 1.4	04/02→09/03								
Partner Box 1.4 BiFuel	04/03→								
Partner Combispace 1.4	06/96→							TD14729	

106 II 1.4 i	05/96→	TU3JP (KFX)							TD5396
205 II 1.4	07/88→09/98		4cyl.						
206 Hatchback 1.4 i	09/98→			1360cc		55kW (75PS)			
306 1.4 SL	06/94→05/01								
306 Break 1.4	03/97→04/02								
306 Hatchback 1.4	05/93→05/01								
Partner Box 1.4, Partner Combispace 1.4	06/96→								

206 Hatchback 1.4 LPG	05/06→09/07	TU3JP-L4							TD18518
1007 1.4	04/05→		4cyl.	1360cc		55kW (75PS)			

08-138900-00	STD	75.00	1.500		001 CK P			KV1
[R67020]			1.500		026 P			GOE13
			2.500		236 P			GOE13

106 I 1.4 D	09/92→04/96	TUD3							14
			4cyl.	1360cc		39kW (53PS)			
					Diesel			TD2786	

08-154500-00	STD	75.00	2.250		001 IF P PS			KV1
[R60980]			1.750		005 P			IKA
			3.000		231 CR P			STD

104 1.4	08/79→06/83	XY6B (150)							15
104 Coupe 1.4	08/79→06/84		4cyl.						
205 I 1.4	02/83→10/87			1360cc		53kW (72PS)			
205 II 1.4	01/87→07/88							TD2901	

205 I 1.4	02/83→10/87	XY7 (150D)							TD2902
205 I Convertible 1.4 CJ	03/88→05/89		4cyl.						
205 II 1.4	10/87→05/89			1360cc		44kW (60PS)			

205 I 1.4	02/83→10/87	XY7 (150G)							TD2903
205 I Convertible 1.4 CJ	03/88→05/89		4cyl.						
205 II 1.4	10/87→05/89			1360cc		44kW (60PS)			

205 I 1.4	02/83→10/87	XY8 (150B)							TD2905
205 I Convertible 1.4 CT	04/86→12/88		4cyl.						
205 II 1.4	07/88→05/89			1360cc		58-59kW (79-80PS)			

205 I 1.4	10/85→10/87	XY8 (150H)							TD2904
205 I Convertible 1.4 CT	04/86→12/88		4cyl.						
205 II 1.4	07/88→05/89			1360cc		58kW (79PS)			





104 1.2		08/79→06/83	XZ5 (129)	4cyl. 1219cc	42kW (57PS)		TD2906
08-334200-00	STD	75.00	1.750		001 IF CR P	IKA	
08-334207-00	0.50mm		2.000		026 P	STD	
[R66320]			4.000		712 CR	ST	
205 I 1.3		02/84→10/87	G1 / G2	4cyl.			16
205 II 1.3		08/90→07/92		1294cc	47-48kW (64-65PS)		TD4833
309 I 1.3		10/85→07/89					
08-346000-00	STD	76.70	1.750		001 IF CR P	IKA	
[R66380]			2.000		026 P	STD	
			4.000		712 CR	ST	
106 II 1.5 D		10/00→	TUD5 (VJX)	4cyl.			17
106 Van 1.5 D		10/00→03/01		1527cc	40kW (54PS)		TD16193
				Diesel			
106 I 1.5 D		06/94→04/96	TUD5 (VJY)	4cyl.			
106 II 1.5 D		05/96→		1527cc	42kW (57PS)		TD4842
106 Van 1.5 D		05/96→03/01					
				Diesel			
08-325800-00	STD	77.00	2.000		001 CK P	KV1	
08-325806-00	0.40mm		1.750		005 P	STD	
[R49960]			3.000		231 CR P	STD	
204 1.1		09/75→07/77	XK5	4cyl.			18
304 Break 1.1		10/76→10/80		1130cc	43kW (58PS)		TD2815
305 II 1.1		11/82→12/88					
304 1.3 GL		09/72→10/79	XL5	4cyl.			
304 Break 1.3		09/70→10/80		1290cc	44-48kW (60-65PS)		TD4844
305 I 1.3		11/77→09/82					
305 I 1.3		11/77→09/82	XL5 (118)	4cyl.			
305 I Break 1.3		08/80→09/82		1290cc	44kW (60PS)		TD2822
305 II 1.3		10/82→08/85					
305 II Break 1.3		10/82→08/86					
304 1.3		08/72→09/75	XL5S	4cyl.			
				1290cc	55kW (75PS)		TD2821
305 I 1.5		11/79→09/82	XR5 (142)	4cyl.			
305 I Break 1.5		08/80→09/82		1472cc	54kW (73PS)		TD2749
305 II 1.5		10/82→08/85					
305 II Break 1.5		10/82→08/86					





305 II 1.5		09/85→07/90	XR5A (142)		4cyl.	1472cc	50kW (68PS)		
305 II Break 1.5		09/85→10/86							TD2842
305 I 1.5		05/80→09/82	XR5S (117)		4cyl.	1472cc	65kW (88PS)		TD2844
08-320100-00	STD	78.00	1.750		001 IF CR P				IKA
[R66130]			2.000		026 P				STD
			4.000		712 CR				ST
204 1.4 D		09/73→12/77	XL4D		4cyl.	1357cc	33kW (45PS)		19
204 Break 1.3 D		01/73→10/77							
304 1.4 D, 304 Break 1.4 D		10/76→10/79	Diesel						TD2819
08-317600-10	STD	78.00	1.750		001 IW CR P				KV1
[R66120]			2.000		005 IF P				STD
			3.000		231 CR P				STD
106 II 1.6 i		05/96→	TU5J2 (NFW)		4cyl.	1587cc	65kW (88PS)		20
									TD4837
106 I 1.6		01/94→04/96	TU5J2 (NFW/NFY)		4cyl.	1587cc	65kW (88PS)		TD4838
106 II 1.6 i		05/96→							
106 I 1.6		06/93→04/96	TU5JP (NFZ)		4cyl.	1587cc	65kW (88PS)		TD4840
106 II 1.6 i		05/96→							
206 Hatchback 1.6 i		09/98→12/00							
306 1.6 SR		06/94→10/00							
306 Break 1.6		03/97→10/00							
306 Convertible 1.6		04/96→10/00							
306 Hatchback 1.6		05/93→10/00							
206 1.6i 16V		03/00→	TU5JP4 (N6A)		4cyl.	1587cc	78-80kW (106-109PS)		TD21503
08-103800-00	STD	78.50	1.500		001 CK P				KV1
08-103806-00	0.40mm		1.500		026 P				STD
[R66740]			3.000		231 CR P				STD



106 II 1.6 S16	05/96→	TU5J4 (NFX)	4cyl.	1587cc	87kW (118PS)	21
						TD4839

206 CC 1.6 16V	09/00→	TU5JP4 (NFU/N6A)	4cyl.	1587cc	80kW (109PS)	22
206 Hatchback 1.6 16V	12/00→					
206 Saloon 1.6 16V	03/07→					
206 SW 1.6 16V	07/02→					
207 1.6 16V	02/06→					
307 1.6 16V	08/00→					
307 1.6 BioFlex	09/07→					
307 Break 1.6 16V	03/02→					
307 Break 1.6 BioFlex	09/07→					
307 CC 1.6 16V	03/05→					
307 SW 1.6 16V	03/02→					
307 SW 1.6 BioFlex	09/07→					
308 1.6 BioFlex	04/08→					
308 SW 1.6 Bioflex	03/09→					
1007 1.6 16V	04/05→					
Partner Box 1.6	09/00→					
Partner Combispace 1.6 16V	07/01→					
Partner Tepee 1.6	04/08→				TD15668	

08-139400-00	STD	78.50	1.200		001 CK P	KV1
08-139406-00	0.40mm		1.500		026 P	GOE13
08-139407-00	0.50mm		2.500		231 P	GOE13
[R67250]						

305 I 1.5 Diesel	11/77→09/82	XID (149)	4cyl.	1548cc	36kW (49PS)	22
305 I Break 1.5 Diesel	08/80→09/82					
						TD2812

08-319100-10	STD	80.00	1.750		001 CR P	KV1
			2.000		005 IF P	STD
			3.000		231 CR P	STD
[R66030]						

205 Box 1.7 Diesel	03/94→	XUD7 (161A)	4cyl.	1769cc	44kW (60PS)	23
205 I 1.7 Diesel	08/83→10/87					
205 II 1.7 Diesel	07/87→09/98					
305 II 1.8 D, 305 II Break 1.8 D	11/82→12/88	Diesel				
309 II 1.8 Diesel	07/89→12/93					TD2882

205 Box 1.8 D	02/83→07/90	XUD7 (A9A)	4cyl.	1769cc	44kW (60PS)	23
306 Hatchback 1.8 D	05/93→05/01					
Partner Box 1.8 D	06/96→					
						TD12351

08-321500-00	STD	80.00	2.000		001 CR P	KV1
08-321507-00	0.50mm		2.000		005 P	STD
08-321510-00	0.80mm		3.000		231 CR P	STD
[R66400]						



205 II 1.8 XDT	08/90→05/97	XUD7T	4cyl. 1769cc 58kW (79PS)	24
		Diesel	Turbo Intercooled	TD18394
405 I 1.8 Turbo Diesel	03/88→12/92	XUD7TE (A8A)	4cyl. 1769cc 66kW (89PS)	
405 I Break 1.8 TD	10/88→08/92		Diesel Turbo Intercooled	TD2884
205 II 1.8 TD	01/90→09/98	XUD7TE (A8B)	4cyl. 1769cc 57kW (77PS)	
309 II 1.8 TD	08/89→12/93		Diesel Turbo	TD10789
405 I 1.8 Turbo Diesel	03/88→12/92	XUD7TE (AJZ)	4cyl. 1769cc 66kW (89PS)	
405 I Break 1.8 TD	10/88→08/92		Diesel Turbo Intercooled	TD2885

08-323600-00	STD	80.00	3.000		008 MOL P	KV1
08-323607-00	0.50mm		2.000		005 P	STD
[R49910]			3.000		231 CR P	STD

205 GTX	01/87→	J2	4cyl. 1592cc 69kW (93PS)	25
309 SR				FM5303

08-348200-00	STD	80.60	1.750		001 IF MO P	IKA
			2.000		026 P	STD
			4.000		712 CR	ST

607 2.7 HDi 24V	12/04→	DT17TED4	6cyl. 2721cc 150kW (204PS)	26
		Diesel	Turbo Intercooled	TD18175

08-432400-00	STD	81.00	2.000		001 IF CK	KV1
			2.000		005 IFU	GOE13
			2.000		231	F12/F14



206 Hatchback 1.9 D	09/98→11/01	DW8 (WJZ)			27
206 Van 1.9 D	04/99→05/07		4cyl.		
306 1.9 D	09/98→05/01		1868cc	51kW (69PS)	
306 Break 1.9 D	09/98→04/02	Diesel			
306 Hatchback 1.9 D	09/98→05/01				
Expert 1.9 D	12/03→				
Expert Box 1.9 D 70	12/98→				
Expert Platform/Chassis 1.9 D	06/98→11/03				
Partner Box 1.9 D	06/96→				
Partner Combispace 1.9 D	12/98→				

306 1.9 D	09/98→05/01	DW8B (WJY)			28
306 Break 1.9 D	09/98→04/02		4cyl.		
306 Hatchback 1.9 D	09/98→05/01		1868cc	51kW (69PS)	
Expert 1.9 D	12/03→	Diesel			
Expert Box 1.9 D 70	12/98→				
Expert Platform/Chassis 1.9 D	06/98→11/03				
Partner Box 1.9 D	06/96→				
Partner Box 1.9 D 4x4	04/04→				
Partner Combispace 1.9 D	12/98→				
Partner Combispace 1.9 D 4x4	04/04→08/05				

08-104000-00	STD	82.20	2.000		001 CK P	KV1
08-104008-00	0.60mm		2.000		026 P	STD
[R60230]			3.000		231 CR P	STD

406 1.8 16V	10/00→05/04	EW7J4 (6FZ)			29
406 Break 1.8 16V	10/00→10/04		4cyl.		
407 1.8, 407 SW 1.8	05/04→		1749cc	85kW (116PS)	

08-323400-00	STD	82.70	1.500		001 P PS	KV1
[R60190]			1.500		026 P	STD
			3.000		231 CR P	STD

205 I 1.6	08/86→10/87	XU5 (B1AA)			29
205 II 1.6	10/87→09/98		4cyl.		
305 II 1.6	10/82→07/88		1580cc	55kW (75PS)	
305 II Break 1.6	02/86→12/88				
309 I 1.6	10/85→07/89				

205 I 1.6	03/87→10/87	XU51C (B1A/B1C/B1E)			29
205 II 1.6	10/87→09/98		4cyl.		
309 I 1.6	08/87→07/89		1580cc	53-55kW (72-75PS)	
405 I 1.6	07/87→12/92				
405 I Break 1.6	10/88→08/92				

205 1.6	02/83→09/98	XU51C (B1D)			29
305 1.6	10/82→07/90		4cyl.		
309 1.6	10/85→12/90		1580cc	55kW (75PS)	

309 II 1.6	07/89→12/93	XU52C (B2A)			29
405 I 1.6	01/87→12/92		4cyl.		
405 I Break 1.6	05/88→07/92		1580cc	68kW (92PS)	
405 II 1.6	08/92→05/97				





205 I 1.6			08/86→10/87	XU5CP (BAZ)			
205 II 1.6			10/87→09/98		4cyl.		
305 II 1.6, 305 II Break 1.6			11/86→12/88		1580cc	54-55kW (74-75PS)	
309 I 1.6 CAT			09/86→12/89				
405 I 1.6			07/87→06/88				
405 I Break 1.6			10/88→08/92				TD2859
205 II 1.6			08/90→07/92	XU5S (171)			
305 II 1.6			10/82→06/88		4cyl.		
305 II Break 1.6			09/83→12/87		1580cc	66-71kW (90-97PS)	
							TD2865
08-151200-00	STD	83.00	1.750		001 IF CR P		IKA
[R60940]			1.750		026 P		STD
			4.000		712 CR		ST
205 I Convertible 1.6 CTI			04/86→10/90	XU5J (180)			30
205 II 1.6 GTI			10/87→12/89		4cyl.		
309 I 1.6			11/85→09/88		1580cc	76kW (103PS)	TD2862
205 I 1.6 GTI			12/84→10/87	XU5J (180A)			
205 I Convertible 1.6 CTI			04/86→10/90		4cyl.		
205 II 1.6 GTI			10/87→12/89		1580cc	76kW (103PS)	TD2861
309 I 1.6			11/85→09/88	XU5J (B6B)			
					4cyl.		
					1580cc	76kW (103PS)	TD2858
309 II 1.6			07/89→12/93	XU5M (BDZ)			
405 I 1.6			07/87→12/92		4cyl.		
405 I 1.6 4x4			04/88→07/92		1580cc	65-66kW (88-90PS)	
405 I Break 1.6			10/88→08/92				
405 I Break 1.6 SRi 4x4			04/88→07/92				
405 II 1.6			08/92→10/95				
405 II Break 1.6			08/92→10/96				TD2839
305 II 1.9			10/82→08/85	XU92C			
305 II Break 1.9			09/84→10/87		4cyl.		
					1905cc	75kW (102PS)	TD2879
205 II 1.9 GTI			10/87→05/89	XU92C (D2A)			
					4cyl.		
					1905cc	75kW (102PS)	TD2869
405 I 1.9			07/87→12/92	XU92C (D2C)			
405 I Break 1.9			10/88→08/92		4cyl.		
					1905cc	70kW (95PS)	TD2871
205 I 1.9 GTI			03/87→10/87	XU9J1 (DFZ)			
205 I Convertible 1.9			05/86→07/87		4cyl.		
205 I Convertible 1.9 CTi			08/87→12/94		1905cc	90kW (122PS)	
205 II 1.9			08/92→05/97				
205 II 1.9 GTI CAT			10/87→07/94				
305 II 1.9, 305 II Break 1.9			11/86→12/88				
309 I 1.9			03/86→07/89				
309 II 1.9			08/89→12/93				
405 I 1.9 Injection			07/87→12/92				
405 I Break 1.9			05/88→08/92				
405 I Break 1.9 All-wheel Drive			09/88→07/92				TD2870





405 I 1.9			01/89→12/92	XU9J2 (D6A)	4cyl. 1905cc	90-92kW (122-125PS)	TD22159
205 I 1.9 GTI			10/86→10/87	XU9JA (D6B)	4cyl.		
205 II 1.9 GTI			10/87→09/98		1905cc	94-96kW (128-131PS)	TD2872
309 I 1.9 GTI			10/86→07/89				
205 II 1.9			08/90→05/97	XU9JAZ (DKZ)	4cyl.	90kW (122PS)	
205 II 1.9 GTI			10/87→10/94		1905cc		
309 I 1.9 GTI			07/88→07/89				
309 II 1.9 GTI			07/89→12/93				
405 I 1.9			07/88→12/92				
405 I 1.9 4x4			06/87→07/92				
405 I Break 1.9			10/88→08/92				
405 I Break 1.9 4x4			07/90→07/92				TD2877
309 I 1.9			07/88→07/89	XU9M (DDZ)	4cyl.	90kW (122PS)	
309 II 1.9			10/90→12/93		1905cc		
405 I 1.9, 405 I 1.9 4x4			07/88→12/92				
405 I Break 1.9, 405 I Break 1.9 4x4			10/88→08/92				TD2878
309 I 1.9			10/85→07/89	XU9S (D2B)	4cyl.	75kW (102PS)	
					1905cc		TD2772
08-322400-00	STD	83.00	1.500		001 IF MO P		IKA
[R60950]			1.500		005 IF P		STD
			4.000		231 CR P		STD
405 II 1.6			08/92→05/97	XU5JP (BFZ)	4cyl.	65kW (88PS)	31
405 II Break 1.6			08/92→10/96		1580cc		TD2863
406 1.6			11/95→05/04				
406 1.8			05/97→05/04	XU7JB (LFX)	4cyl.	66kW (89PS)	
406 Break 1.8			05/97→10/04		1761cc		TD12708
Partner Combispace 1.8			05/97→				
806 1.8			07/95→08/02	XU7JP (LFW)	4cyl.	73kW (99PS)	
					1761cc		TD2867
306 1.8			10/95→04/97	XU7JP (LFZ)	4cyl.	74kW (100PS)	
306 1.8 ST			06/94→05/01		1761cc		
306 Break 1.8			03/97→04/02				
306 Convertible 1.8			03/94→04/02				
306 Hatchback 1.8			05/93→05/01				
405 II 1.8			08/92→11/99				
405 II Break 1.8			08/92→10/96				
Expert 1.8, Expert Box 1.8			10/96→09/00				TD2866
306 1.8 16V			03/97→05/01	XU7JP4 (LFY)	4cyl.	81kW (110PS)	
306 Break 1.8 16V			03/97→04/02		1761cc		
306 Convertible 1.8 16V			07/00→04/02				
306 Hatchback 1.8 16V			03/97→05/01				
406 1.8 16V			11/95→10/00				
406 Break 1.8 16V			10/96→10/00				TD4849





309 II 1.9 GTI 16V	08/89→07/90	XU9J4 (D6C/DFW)				
405 I 1.9 4x4	06/87→07/92	4cyl.				
405 I 1.9 Sport MI-16	07/87→11/91	1905cc	116kW (158PS)			
405 I Break 1.9 All-wheel Drive	06/87→07/92				TD2873	
309 II 1.9 GTI 16V	10/90→12/93	XU9J4 (DFW)				
405 I 1.9 Sport MI-16,	04/88→12/92	4cyl.				
405 I 1.9 SPort MI-16 4x4		1905cc	90kW (122PS)			
					TD2875	
08-323400-00	STD	83.00	1.500		001 P PS	KV1
[R60190]			1.500		026 P	STD
			3.000		231 CR P	STD
306 1.9 STD	02/94→10/95	XUD9				32
306 Hatchback 1.9 D	04/93→05/99	4cyl.				
306 Van 1.9 STD	02/94→10/95	1905cc	51kW (69PS)			
405 II Break 1.9 D	09/93→12/95	Diesel				
J5 Box 1.9 D	09/87→08/90					
Partner Combispace 1.9 D	05/96→12/98					TD8478
305 II 1.9 D	10/82→07/88	XUD9 (16Z)				
305 II Break 1.9 Diesel	10/82→12/88	4cyl.				
309 I 1.9 D	06/86→07/89	1905cc	47-48kW (64-65PS)			
309 II 1.9 Diesel	07/89→12/93	Diesel				TD2886
305 II 1.9 D	10/82→07/88	XUD9 (D9A)				
305 II Break 1.9 Diesel	10/82→12/88	4cyl.				
309 I 1.9 D	06/86→07/89	1905cc	47kW (64PS)			
309 II 1.9 Diesel	07/89→12/93	Diesel				TD2754
205 II 1.9 Diesel	10/87→09/98	XUD9 (DJZ)				
306 1.9 SLD	06/94→05/01	4cyl.				
306 Hatchback 1.9 D	05/93→05/01	1905cc	47kW (64PS)			
309 II 1.9 Diesel	07/89→12/93	Diesel				
405 I 1.9 Diesel	07/88→09/92					
405 I Break 1.9 D	10/88→08/92					
405 II 1.9 D	08/92→10/95					
405 II Break 1.9 D	08/92→10/96					TD2891
405 I 1.9 Diesel	03/88→12/92	XUD9A (D9B)				
405 I Break 1.9 D	10/88→08/92	4cyl.				
405 II 1.9 D	08/97→11/99	1905cc	51kW (69PS)			
J5 Box 1.9 D	09/87→03/94	Diesel				
J5 Bus 1.9 D, J5 Platform/Chassis 1.9 D	10/90→02/94					TD2834
Boxer Box 1.9 D, Boxer Bus 1.9 D	03/94→04/02	XUD9A (D9B)				
Expert 1.9 D, Expert Box 1.9 D,	02/96→	4cyl.				
Expert Platform/Chassis 1.9 D		1905cc	51kW (69PS)			
		Diesel				TD2880





306 1.9 SLD	06/94→05/01	XUD9A (DJY)	
306 Break 1.9 D	03/97→04/02	4cyl.	
306 Hatchback 1.9 D	06/94→05/01	1905cc	51kW (69PS)
405 I Break 1.9 D	10/88→08/92	Diesel	
405 II 1.9 D	06/94→10/95		
405 II Break 1.9 D	06/94→10/96		
Boxer Box 1.9 D	07/99→04/02		
Partner Box 1.9 D	05/96→		
Partner Combispace 1.9 D	06/96→		TD2887

08-152000-00	STD	83.00	2.000		001 CR P	KV1
08-152003-00	0.125mm					
08-152007-00	0.50mm		2.000		005 P	STD
08-152010-00	0.80mm					
08-152011-00	1.00mm		3.000		231 CR P	STD

[R66390]

306 1.9 D	05/93→10/03	XUD9A (D9B/DJY)	
405 1.9 D	03/88→04/97	4cyl.	33
Boxer 1.9 D	02/94→02/02	1905cc	51kW (69PS)
		Diesel	TD10827

306 1.9 D	03/98→05/01	XUD9BSD (DHV)	
306 Break 1.9 D	03/98→04/02	4cyl.	
306 Hatchback 1.9 D	03/98→05/01	1905cc	55kW (75PS)
		Diesel	TD9867

406 1.9 D	10/96→05/04	XUD9SD (DHW)	
406 Break 1.9 D	10/96→10/04	4cyl.	
		1905cc	66kW (89PS)
		Diesel Turbo	TD9365

306 1.9 D	02/94→04/97	XUD9TE	
306 Hatchback 1.9 D	04/93→04/97	4cyl.	
306 Van 1.9 D	02/94→04/99	1905cc	66kW (89PS)
405 II 1.9 TD	08/92→05/97	Diesel	Turbo Intercooled
Boxer Box 1.9 DT 4x4	03/96→09/98		
Boxer Box 1.9 TD	07/99→04/02		TD18953

Expert 1.9 TD, Expert Box 1.9 TD, Expert Platform/Chassis 1.9 TD	02/96→	XUD9TE (D8B)	
		4cyl.	
		1905cc	66kW (89PS)
		Diesel Turbo Intercooled	TD2751

406 1.9 TD	01/96→05/04	XUD9TE (DHX)	
406 Break 1.9 TD	10/96→10/04	4cyl.	
806 1.9 TD	07/95→08/02	1905cc	66kW (89PS)
Expert 1.9 TD, Expert Box 1.9 TD, Expert Platform/Chassis 1.9 TD	02/96→	Diesel	Turbo Intercooled
			TD2889

306 1.9 SRDT	06/94→05/01	XUD9TE (DHY)	
306 Break 1.9 TD	02/97→04/02	4cyl.	
306 Hatchback 1.9 DT	05/93→05/01	1905cc	66kW (89PS)
405 II 1.9 TD	08/92→10/95	Diesel	Turbo Intercooled
405 II Break 1.9 TD	08/92→10/96		
406 1.9 TD	01/96→05/04		
806 1.9 TD	05/97→08/02		
Boxer Bus 1.9 TD	08/94→04/02		
Boxer Platform/Chassis 1.9 TD	12/98→04/02		TD2888





Boxer Box 1.9 TD, Boxer Bus 1.9 TD		03/94→04/02	XUD9UTF (D8C)			
Boxer Bus 1.9 TD 4x4, Boxer Platform/ Chassis 1.9 TD		07/96→04/02	4cyl.			
			1905cc			66kW (89PS)
			Diesel	Turbo		TD2890
08-105500-00	STD	83.00	3.000		008 CK	KV1
08-105507-00	0.50mm				005 IF NT	IKA
08-105510-00	0.80mm		2.000		231 CR P	STD
01/1997→			3.000			
[R60140]						
08-325500-00	STD	83.00	3.500		008 MOL P	KV1
08-325507-00	0.50mm		2.000		005 P	STD
→12/1996			3.000		231 CR P	STD
[R49920]						
<hr/>						
407 Coupe 3.0 HDi		06/09→	DT20C Euro 5			34
			V6cyl.			
			2993cc			177kW (240PS)
			Diesel	Bi-Turbo Intercooled		TD23527
08-439100-00	STD	84.00	2.000		001 IF CK P	KV1
			2.000		005 IFU P	F12/F14
			2.000		231 LKZ CR P	GOE13
<hr/>						
504 1.8 Injection		07/68→02/71	KF5			35
			4cyl.			
			1796cc			71kW (96PS)
						TD2883
504 1.8 Injection		07/68→02/71	KF6			
			4cyl.			
			1796cc			71kW (96PS)
						TD2755
504 1.8		07/68→02/71	XM			
			4cyl.			
			1796cc			60kW (81PS)
						TD2824
504 1.8		01/71→06/83	XM7			
504 Break 1.8		04/71→07/86	4cyl.			
504 Pickup 1.8		08/81→12/89	1796cc			53-58kW (72-79PS)
505 Break 1.8		04/82→09/85				TD2825
505 1.8		06/81→10/85	XM7 (105)			
			4cyl.			
			1796cc			55-60kW (75-82PS)
						TD2826
505 1.8		09/85→10/86	XM7A (105C)			
			4cyl.			
			1796cc			62-66kW (90-90PS)
						TD2827
J7 Box 1.8, J7 Bus 1.8, J7 Platform/ Chassis 1.8		07/70→03/80	XM7P			
			4cyl.			
			1796cc			48-50kW (65-68PS)
						TD8497





J5 Box 1.8			01/83→01/94	XM7T (169B)	4cyl. 1796cc	51kW (69PS)	TD6793
08-315300-00	STD	84.00	1.500		001 IF CR P		KV1
08-315307-00	0.50mm		2.000		026 P		STD
[R66060]			4.000		712 CR		ST
J7 Box 1.6			08/68→03/80	XC5P (3rd Series)	4cyl. 1618cc	50kW (68PS)	36 TD8495
J7 Bus 1.6, J7 Platform/Chassis 1.6			08/68→07/70				
404 1.6			11/67→12/71	XC6	4cyl. 1618cc	50-54kW (68-74PS)	TD2793
404 1.6 GT			07/71→12/71				
504 Pickup 1.6			01/80→06/87	XC7P	4cyl. 1618cc	46kW (63PS)	TD8496
J7 Box 1.6			08/68→03/80				
J7 Bus 1.6, J7 Platform/Chassis 1.6			07/70→03/80				
J9 Box 1.6			03/80→06/87				
08-520300-00	STD	84.00	2.000		001 IF CR P		IKA
			2.000		026 P		STD
			4.500		236 P		STD
307 2.0 HDi 110			08/00→	DW10ATED (RHS)	4cyl. 1997cc	81kW (110PS)	37 TD20417
307 Break 2.0 HDi 110, 307 SW 2.0 HDi 110			03/02→				
406 2.0 HDi 110			08/01→05/04	Diesel	Turbo Intercooled		
406 Break 2.0 HDi 110			08/01→10/04				
607 2.0 HDi			03/01→07/04				
406 2.0 HDi 110			06/98→05/04	DW10ATED (RHZ)	4cyl. 1997cc	80kW (109PS)	TD10727
406 Break 2.0 HDi 110			02/99→10/04				
607 2.0 HDi			05/00→				
806 2.0 HDi			08/99→08/02	Diesel	Turbo Intercooled		
Expert 2.0 HDi, Expert Box 2.0 HDi			07/00→				
807 2.0 HDi			06/02→	DW10ATED4 (RHM)	4cyl. 1997cc	79kW (107PS)	TD20790
				Diesel	Turbo Intercooled		
807 2.0 HDi			06/02→	DW10ATED4 (RHT)	4cyl. 1997cc	79kW (107PS)	TD20789
				Diesel	Turbo Intercooled		
806 2.0 HDi 16V			08/99→08/02	DW10ATED4 (RHW)	4cyl. 1997cc	80kW (109PS)	TD17510
807 2.0 HDi			06/02→				
Expert 2.0 HDi, Expert Box 2.0 HDi			07/00→				
Expert Platform/Chassis 2.0 HDi			10/00→10/06	Diesel	Turbo Intercooled		
Expert 2.0 HDi			10/00→11/03	DW10BTED (RHX)	4cyl. 1997cc	69kW (93PS)	TD17515
Expert Box 2.0 HDi			07/00→				
				Diesel	Turbo Intercooled		





508 2.0 HDi, 508 SW 2.0 HDi	11/10→	DW10BTED4 (RHF) 4cyl. 1997cc 103kW (140PS) Diesel Turbo Intercooled	TD26794
307 2.0 HDi 135	10/03→	DW10BTED4 (RHR) 4cyl. 1997cc 100kW (136PS) Diesel Turbo Intercooled	
307 Break 2.0 HDi 135	02/04→		
307 CC 2.0 HDi 135	06/05→		
307 SW 2.0 HDi 135	02/04→		
308 2.0 HDi	09/07→		
308 CC 2.0 HDi	04/09→		
308 SW 2.0 HDi	09/07→		
407 2.0 HDi	08/08→		
407 2.0 HDi 135	05/04→		
407 Coupe 2.0 HDi	10/05→		
407 SW 2.0 HDi	08/08→		
407 SW 2.0 HDi 135	05/04→		
508 2.0 HDi, 508 SW 2.0 HDi	11/10→		
607 2.0 HDi	09/05→		
807 2.0 HDi	06/06→		
Expert Box 2.0 HDi 140, Expert Platform/ Chassis 2.0 HDi 140, Expert Tepee 2.0 HDi 140	01/07→		TD17507
Expert HDi	01/01→	DW10CTED 4cyl. 1997cc 80kW (109PS) Diesel Turbo Intercooled	FM55701
Boxer Box 2.0 HDi, Boxer Bus 2.0 HDi, Boxer Platform/Chassis 2.0 HDi	04/02→	DW10TD (RHV) 4cyl. 1997cc 62kW (84PS) Diesel Turbo Intercooled	TD24911
206 Hatchback 2.0 HDi 90	12/99→	DW10TD (RHY) 4cyl. 1997cc 63kW (86PS) Diesel Turbo Intercooled	
206 SW 2.0 HDi	07/02→		
306 2.0 HDi 90	06/99→05/01		
306 Break 2.0 HDi 90	06/99→04/02		
306 Hatchback 2.0 HDi 90	06/99→05/01		
307 2.0 HDi 90	08/00→		
307 Break 2.0 HDi 90, 307 SW 2.0 HDi 90	03/02→		
406 2.0 HDi 90	02/99→05/04		
406 Break 2.0 HDi 90	02/99→10/04		
Partner Box 2.0 HDi	04/00→		
Partner Box 2.0 HDi 4x4	04/04→		
Partner Combispace 2.0 HDi	02/00→		
Partner Combispace 2.0 HDi 4x4	04/04→08/05		TD12569
Boxer Box 2.0 HDi	08/01→	DW10UTD (RHV) 4cyl. 1997cc 62kW (84PS) Diesel Turbo Intercooled	TD17512
Boxer Bus 2.0 HDi, Boxer Platform/ Chassis 2.0 HDi	04/02→		
807 2.0 HDi	02/06→	DW10UTED4 (RHK) Euro 4 4cyl. 1997cc 85-88kW (116-120PS) Diesel Turbo Intercooled	TD19814
Expert Box 2.0 HDi 120, Expert Platform/ Chassis 2.0 HDi 120, Expert Tepee 2.0 HDi 120, Expert Tepee 2.0 HDi 120 4x4	01/07→		
406 2.2 Hdi	03/00→05/04	DW12BTED4 (4HW) 4cyl. 2179cc 94kW (128PS) Diesel Turbo Intercooled	TD24913
406 Break 2.2 Hdi	03/00→10/04		
406 Coupe 2.2 Hdi	03/00→12/04		
607 2.2 Hdi	02/00→		
807 2.2 Hdi	06/02→		





406 2.2 HDi			03/00→05/04	DW12TED4 (4HX/4HW)		
406 Break 2.2 HDi			03/00→10/04	4cyl.		
406 Coupe 2.2 HDi			03/00→12/04	2179cc	100kW (136PS)	
607 2.2 HDi			02/00→	Diesel	Turbo Intercooled	
807 2.2 HDi			06/02→			TD16128
06 Coupe			03/00→12/04	DW12TED4 (4HZ)		
406			03/00→05/04	4cyl.		
406 Break			03/00→10/04	2179cc	100kW (136PS)	
607			03/00→	Diesel	Turbo Intercooled	
807			06/02→			TD24912
Boxer Box 2.2 HDi, Boxer Bus 2.2 HDi, Boxer Platform/Chassis 2.2 HDi			04/02→	DW12UTED (4HY)		
				4cyl.		
				2179cc	74kW (100PS)	
				Diesel	Turbo Intercooled	TD17513
08-114700-00	STD	85.00	3.500		008 CK P	KV1
08-114708-00	0.60mm		2.000		005 IFU P	STD
[R60410]			3.000		231 CR P	STD
508 2.2 HDi, 508 SW 2.2 HDi			11/10→	DW12C (4HL) Euro 5		38
				4cyl.		
				2179cc	147-150kW (200-204PS)	
				Diesel	Turbo Intercooled	TD24921
4007 2.2 Hdi 200702				DW12MTED4 (4HK)		
				4cyl.		
				2179cc	115kW (156PS)	
				Diesel	Turbo Intercooled	TD24916
4007 2.2 HDi			02/07→	DW12MTED4 (4HN)		
				4cyl.		
				2179cc	115kW (156PS)	
				Diesel	Turbo Intercooled	TD24727
08-436700-00	STD	85.00	2.500		008 GDC P	KV1
			2.000		005 IFU P	STD
			2.000		231 LKZ CK	GOE13
605 2.1 Turbo Diesel			06/89→09/99	XUD11ATE (PHZ/P8A/P8B)		39
				4cyl.		
				2088cc	80kW (109PS)	
				Diesel	Turbo Intercooled	TD2881
08-154900-00	STD	85.00	3.000		008 P PS	KV1
08-154908-00	0.60mm		2.000		005 P	F12/F14
[R60550]			3.000		231 CR P	STD



406 2.1 TD 12V	01/96→05/04	XUD11BTE (P8C)		40
406 Break 2.1 TD 12V	10/96→10/04	4cyl.		
605 2.1 TD 12V	08/94→09/99	2088cc	81kW (110PS)	
806 2.1 td 12V	06/96→08/99	Diesel	Turbo Intercooled	
TD4850				

08-126600-00	STD	85.00	3.000		008 CK P	KV1
08-126608-00	0.60mm		2.000		005 IF NT	IKA
[R60670]			3.000		231 CR	STD

Boxer Box 2.2 HDi 120, Boxer Bus 2.2 HDi 120, Boxer Platform/ Chassis 2.2 HDi 120	04/06→	4HU Euro 4		41
		4cyl.		
		2198cc	88kW (120PS)	
		Diesel	Turbo Intercooled	TD24470

Boxer Box 2.2 HDi 100, Boxer Bus 2.2 HDi 100, Boxer Platform/ Chassis 2.2 HDi 100	04/06→	4HV Euro 4		41
		4cyl.		
		2198cc	74kW (100PS)	
		Diesel	Turbo Intercooled	TD24469

08-427700-00	STD	86.00	2.000		001 IF CK P	KV1
08-427707-00	0.50mm		2.000		026 P	GOE13
			2.000		231 NT	ST

605 2.0	06/89→09/99	XU102C (R5A)		42
		4cyl.		
		1998cc	84kW (114PS)	
				TD8480

806 2.0	06/94→08/02	XU10J2 (RFU)		42
		4cyl.		
		1998cc	89-90kW (121-123PS)	
				TD2848

Boxer Box 2.0 i	06/94→04/02	XU10J2 (RFW)		42
Boxer Bus 2.0 i	03/94→04/02	4cyl.		
Boxer Bus 2.0 i 4x4	08/96→04/02	1998cc	80kW (109PS)	
Boxer Platform/Chassis 2.0 i	06/94→04/02			
				TD2847

306 2.0 ST	07/94→05/01	XU10J2 (RFX)		42
306 Convertible 2.0	03/94→04/02	4cyl.		
306 Hatchback 2.0 XSi	05/93→05/01	1998cc	89-96kW (121-131PS)	
405 II 2.0, 405 II 2.0 X4	08/92→10/95			
405 II Break 2.0, 405 II Break 2.0 4x4	08/92→10/96			
				TD2846

605 2.0	06/89→09/99	XU10J2 (RFZ/R6A)		42
		4cyl.		
		1998cc	89-90kW (121-123PS)	
				TD2851

406 2.0 Turbo	04/96→05/04	XU10J2TE (RGX)		42
406 Break 2.0 Turbo	10/96→10/04	4cyl.		
605 2.0 Turbo	07/91→09/99	1998cc	108kW (147PS)	
806 2.0 Turbo	06/94→08/02	Turbo Intercooled		
				TD4847

406 2.0, 406 Break 2.0	11/96→03/99	XU10J2TE (RGY)		42
605 2.0 Turbo	07/92→09/99	4cyl.		
		1998cc	104kW (141PS)	
		Turbo Intercooled		TD2850

306 2.0 S16, 306 Hatchback 2.0 S16	06/94→05/01	XU10J4 (RFT)		42
405 II 2.0 16V	06/94→10/95	4cyl.		
		1998cc	110-112kW (150-152PS)	
				TD2852





306 2.0 S16	06/94→05/01	XU10J4 (RFT/RFY)			
306 Hatchback 2.0 S16	05/93→05/01	4cyl.			
405 II 2.0 MI-16	08/92→10/95	1998cc	112kW (152PS)		TD2855

306 2.0	03/97→05/01	XU10J4R (RFV/R6E)			
306 Break 2.0, 306 Convertible 2.0 16V	03/97→04/02	4cyl.			
306 Hatchback 2.0 16V	03/97→05/01	1998cc	99kW (135PS)		
406 2.0 16V	11/95→05/04				
406 Break 2.0 16V	10/96→10/04				
406 Coupe 2.0 16V	03/97→12/04				
605 2.0 16V	07/94→09/99				
806 2.0 16V	05/98→09/00				TD2853

08-154600-00	STD	86.00	1.500		001 IF MO P	IKA
08-154605-00	0.25mm				026 P	STD
08-154608-00	0.60mm		1.750		712 CR	ST
[R60210]			3.000			

605 2.1 D	06/89→07/95	XUD11A (P9A/PJZ)			43
		4cyl.			
		2138cc	61kW (82PS)		
		Diesel			TD11187

08-154700-00	STD	86.00	2.500		001 P PS	KV1
[R67440]			2.000		005 P	F12/F14
			3.000		231 CR P	STD

406 3.0 24V	10/96→05/04	ES9J4 (XFZ)			44
406 Break 3.0 24V	10/96→10/04	6cyl.			
406 Coupe 3.0 V6 24V	03/97→12/04	2946cc	152kW (207PS)		
605 3.0 V6	04/97→09/99				TD9406

406 3.0 V6	03/00→05/04	ES9J4S (XFX/XFW)			
406 Break 3.0 V6	03/00→10/04	6cyl.			
406 Coupe 3.0 V6	03/00→12/04	2946cc	152kW (207PS)		
607 3.0 V6 24V	02/00→				
807 3.0 V6	06/02→				TD13908

08-101400-00	STD	87.00	1.500		001 CK P	KV1
[R66750]			1.500		026 P	STD
			3.000		236 P	STD

505 GTI Familiare, 505 GTX	01/86→	J7T			45
		4cyl.			
		2165cc			
					FM4391

505 2.2	05/81→10/84	ZDJ (851)			
		4cyl.			
		2165cc	85kW (116PS)		
					TD2908

505 2.2 GTI	08/83→12/93	ZDJL (851B)			
505 Break 2.2 GTI	09/85→12/86	4cyl.			
		2165cc	90kW (122PS)		
					TD2909











505 2.2		03/86→12/93	ZDJL (851X)				
505 Break 2.2		01/86→12/93	4cyl.	2165cc	84kW (114PS)		
							TD2910
505 2.0 TI, STI		08/79→10/86	ZEJ (829)				
505 Break 2.0		10/85→09/89	4cyl.	1995cc	81kW (110PS)		
							TD2911
08-334400-00	STD	88.00	1.750		001 IF MO P		IKA
[R66300]			2.000		026 P		STD
			4.000		712 CR		ST
<hr/>							
504 1.9 D		03/73→07/86	XD 4.88				46
504 Pickup 1.9 D		01/80→12/89	4cyl.	1948cc	40kW (54PS)		
							TD2807
504 1.9 D		03/73→07/86	XD 88				
504 Pickup 1.9 D		01/80→12/89	4cyl.	1948cc	44kW (60PS)		
							TD23802
J7 Box 1.9 D, J7 Bus 1.9 D, J7 Platform/ Chassis 1.9 D		08/68→07/78	XDP 4.88				
			4cyl.	1948cc	40kW (54PS)		
							TD8499
J7 Box 1.9 D, J7 Bus 1.9 D, J7 Platform, /Chassis 1.9 D		08/68→07/78	XDP 4.88				
			4cyl.	1948cc	36-46kW (49-63PS)		
							TD22477
08-313800-10	STD	88.00	2.000		001 IW CR P		KV1
[R66050]			2.000		005 P		STD
			2.000		026 P		STD
			4.500		231 CR P		STD
<hr/>							
504 2.0		09/79→08/82	XN1				47
504 Break 2.0		04/71→07/86	4cyl.	1971cc	57kW (77PS)		
505 2.0		09/80→09/85					
							TD2833
504 2.0		03/71→06/86	XN1 (106)				
505 2.0		11/80→12/85	4cyl.	1971cc	57kW (77PS)		
505 Break 2.0		08/83→12/85					
							TD2830
505 2.0		09/85→09/95	XN1A (106E)				
505 Break 2.0		09/85→11/87	4cyl.	1971cc	57kW (77PS)		
							TD4845
J5 Box 2.0		09/81→08/90	XN1P				
J9 Box 2.0, J9 Bus 2.0, J9 Platform/ Chassis 2.0		03/80→06/87	4cyl.	1971cc	57kW (77PS)		
							TD8502





J5 Box 2.0		09/87→08/90	XN1T	4cyl. 1971cc	55-63kW (75-86PS)	TD22486
J5 Bus 2.0		01/83→09/90	XN1T (170)	4cyl. 1971cc	57kW (77PS)	TD2837
J5 Platform/Chassis 2.0		01/83→11/88				
J5 Bus 2.0		09/81→09/90	XN1T (170B)	4cyl. 1971cc	57kW (77PS)	TD2836
J5 Platform/Chassis 2.0		01/86→11/88				
J5 Box 2.0		09/90→01/94	XN1TA	4cyl. 1971cc	62-72kW (84-98PS)	TD8490
J5 Box 2.0		09/90→01/94	XN1TA (170C)	4cyl. 1971cc	62kW (84PS)	TD6804
504 2.0 TI		01/71→06/83	XN2 (107)	4cyl. 1971cc	78kW (106PS)	TD2831
504 Convertible 2.0, 504 Coupe 2.0		08/82→08/84				
604 2.7 SL		08/77→05/83	ZM (112)	6cyl. 2664cc	100kW (136PS)	TD2912
504 Coupe 2.7		10/77→08/84	ZMJ (140)	6cyl. 2664cc	106kW (144PS)	TD2914
604 2.7 TI, STI		08/77→05/83				
08-316900-00	STD	88.00	1.500		001 IF CR P	IKA
08-316907-00	0.50mm		2.000		026 P	STD
[R66110]			4.000		712 CR	ST
504 2.1 D		02/71→07/86	XD90	4cyl. 2112cc	48kW (65PS)	48 TD2808
504 Break 2.1 D		04/71→07/86				
J7 Box 2.1 D, J7 Bus 2.1 D, J7 Platform/Chassis 2.1 D		08/68→07/77	XDP90	4cyl. 2112cc	42kW (57PS)	TD8500
08-314900-10		STD	90.00	2.000		KV1
[R66070]			2.000		001 P	STD
			2.000		023 P	STD
			4.500		231 CR P	STD



505 2.8 GTI V6	06/86 → 12/93	ZN3J (154X)	49
		6cyl. 2849cc 105kW (143PS)	
			TD2917

08-408800-00 STD	91.00	1.500		001 IF CR P	IKA
		2.000		026 P	STD
		4.000		712 CR	ST

Boxer Box 2.5 D	03/94 → 04/02	DJ5 (T9A)	50
Boxer Box 2.5 D 4x4	07/99 → 04/02	4cyl. 2446cc 63kW (86PS)	
Boxer Bus 2.5 D	08/94 → 04/02	Diesel	
Boxer Bus 2.5 D 4x4	07/96 → 04/02		
Boxer Platform/Chassis 2.5 D	03/94 → 04/02		
Boxer Platform/Chassis 2.5 D 4x4	07/99 → 04/02		TD4830

08-112400-00 STD	92.00	2.250		001 CK P	KV1
08-112407-00 0.50mm		2.000		026 P	GOE13
[R67380]		2.000		231 CR P	GOE12

Boxer Box 2.5 TD	03/94 → 04/02	DJ5T (T8A/THZ)	51
Boxer Bus 2.5 TD	07/94 → 04/02	4cyl. 2446cc 76kW (103PS)	
Boxer Bus 2.5 TD 4x4	07/96 → 04/02	Diesel Turbo Intercooled	
Boxer Platform/Chassis 2.5 TD	03/94 → 04/02		
			TD4831

08-118900-00 STD	92.00	3.500		008 P PS	KV1
08-118907-00 0.50mm		2.000		026 P	GOE13
[R60450]		3.000		231 CR P	GOE13
08-326300-00 STD	92.00	3.000		008 P PS	KV1
08-326307-00 0.50mm		1.750		005 IF CR P	IKA
[R67430]		3.500		231 CR P	STD

Boxer Box 2.5 TDI	01/97 → 04/02	DJ5TED (THX)	52
Boxer Box 2.5 TDI 4x4	07/99 → 04/02	4cyl. 2446cc 79kW (107PS)	
Boxer Bus 2.5 TDI, Boxer Bus 2.5 TDI 4x4,	01/97 → 04/02	Diesel Turbo Intercooled	
Boxer Platform/Chassis 2.5 TDI			
Boxer Platform/Chassis 2.5 TDI 4x4	07/99 → 04/02		TD11067

08-135800-00 STD	92.00	3.500		008 P PS	KV1
08-135807-00 0.50mm		2.000		026 P	GOE13
[R66650]		3.500		231 CR P	GOE13

605 2.5 Turbo Diesel	07/94 → 09/99	DK5ATE (THY)	53
		4cyl. 2446cc 95kW (129PS)	
		Diesel Turbo Intercooled	TD2748

08-326300-00 STD	92.00	3.000		008 P PS	KV1
08-326307-00 0.50mm		1.750		005 IF CR P	IKA
[R67430]		3.500		231 CR P	STD



J5 Box 2.5 D		09/81→01/94	CRD93						
J5 Platform/Chassis 2.5 D 4x4		09/81→08/90		4cyl.					54
				2498cc	54kW (73PS)				
			Diesel						TD21168
J5 Box 2.5 D 4x4		10/90→03/94	CRD93 (U25/651/661)						
J5 Bus 2.5 D		09/81→02/94		4cyl.					
J5 Bus 2.5 D 4x4		10/90→02/94		2500cc	54kW (73PS)				
J5 Platform/Chassis 2.5 D		09/81→02/94	Diesel						
J5 Platform/Chassis 2.5 D 4x4		10/90→02/94							TD2747
J5 Box 2.5 DT		09/81→01/94	CRD93L						
J5 Platform/Chassis 2.5 DT		09/81→08/90		4cyl.					
				2498cc	70kW (95PS)				
			Diesel						TD18876
08-147300-10	STD	93.00	2.000		001 MOL P				KV1
→07/1984			2.000		005 IF P				STD
			4.000		231 CR P				STD
08-152700-00	STD	93.00	2.500		001 MOL P				KV1
08-152707-00	0.50mm		2.000		005 IF P				STD
08/1984→			4.000		231 CR P				STD
[R60970]									
08-214400-10	STD	93.00	2.000		001 CR P				KV1
[R60960]			2.000		005 IF P				STD
			4.000		231 CR P				STD
J5 Box 2.5 DT		09/81→08/90	CRD93LS (U25/673)						
J5 Box 2.5 TD 4x4		10/90→03/94		4cyl.					55
J5 Bus 2.5 TD, J5 Bus 2.5 TD 4x4,		10/90→02/94		2500cc	70kW (95PS)				
J5 Platform/Chassis 2.5 TD, J5 Platform/			Diesel	Turbo					
Chassis 2.5 TD 4x4									TD4829
08-152900-00	STD	93.00	3.000		008 MOL P				KV1
[R60990]			2.000		001 IF CR P				STD
			4.000		231 CR P				STD
505 2.5 Diesel		06/81→12/93	EN 55						
505 Break 2.5 Diesel		08/83→12/93		4cyl.					56
				2498cc	53-56kW (72-76PS)				
			Diesel						TD6685
505 2.3 D		05/79→09/84	XD2						
505 Break 2.3 D		06/82→09/84		4cyl.					
				2304cc	44-53kW (60-72PS)				
			Diesel						TD22473
504 2.3 D		07/75→12/83	XD2 (134)						
504 Break 2.3 D		07/75→07/86		4cyl.					
504 Pickup 2.3 D		01/80→12/89		2304cc	51kW (69PS)				
			Diesel						TD2800
J9 Box 2.3 D, J9 Bus 2.3 D, J9 Platform/		03/80→07/82	XD2P / XD94						
Chassis 2.3 D				4cyl.					
				2304cc	49kW (67PS)				
			Diesel						TD8504





J7 Box 2.3 D, J7 Bus 2.3 D, J7 Platform/ Chassis 2.3 D	07/77→03/80	XD2P94	4cyl. 2304cc	49kW (67PS)		
		Diesel				TD8501
505 2.5 Diesel	06/81→12/93	XD3 (155)	4cyl. 2498cc	51-55kW (70-75PS)		
505 Break 2.5 Diesel	08/83→12/93					TD2803
J9 Box 2.5 D	07/82→06/87	XD3P	4cyl. 2498cc	53kW (72PS)		
J9 Bus 2.5 D	08/82→06/87					
J9 Platform/Chassis 2.5 D	07/82→06/87					TD8505
		Diesel				

08-318700-10	STD	94.00	2.000		001 CR P	KV1	
08-318704-10	0.20mm						
08-318706-10	0.40mm			2.000		005 IF P	STD
08-318707-10	0.50mm						
08-318708-10	0.60mm			4.000		231 CR P	STD
08-318710-10	0.80mm						
08-318711-10	1.00mm						
<i>[R66140]</i>							

505 2.3 TD	09/80→06/86	XD2S	4cyl. 2304cc	54-59kW (73-80PS)		57
604 2.3 TD	02/79→06/83					
		Diesel	Turbo			TD22474
505 2.3 Turbo Diesel	09/80→06/86	XD2S (147)	4cyl. 2304cc	59kW (80PS)		
505 Break 2.3 Diesel	04/82→06/86					
604 2.3 TD	09/79→05/83					TD2802
		Diesel	Turbo			
505 2.5 Turbo Diesel	10/83→12/90	XD3T	4cyl. 2498cc	66-70kW (90-95PS)		
505 Break 2.5 D	10/85→08/91					
		Diesel	Turbo Intercooled			TD22475
505 2.5 Turbo Diesel	10/83→12/93	XD3T (152A)	4cyl. 2498cc	66kW (89PS)		
505 Break 2.5 Turbo Diesel	10/85→11/87					
604 2.5 TD	08/83→12/86					TD2805
		Diesel	Turbo			
505 2.5 Turbo Diesel,	10/86→12/93	XD3TE (152B)	4cyl. 2498cc	77kW (105PS)		
505 Break 2.5 Turbo Diesel						
		Diesel	Turbo			TD2806

08-320200-10	STD	94.00	3.000		008 MOL P	IKA	
08-320204-10	0.20mm						
08-320206-10	0.40mm			2.000		005 P	IKA
08-320208-10	0.60mm						
08-320211-10	1.00mm			4.000		231 CR P	STD
<i>[R66000]</i>							



Boxer Box 2.8 HDi, Boxer Bus 2.8 HDi, Boxer Platform/Chassis 2.8 HDi	04/04→	8140.43N	4cyl. 2798cc 107kW (146PS)	58
		Diesel	Turbo Intercooled	TD24923

Boxer Box 2.8 HDi, Boxer Box 2.8 HDi 4x4, Boxer Bus 2.8 HDi, Boxer Bus 2.8 HDi 4x4 Boxer Bus 2.8 HDi All-wheel Drive Boxer Platform/Chassis 2.8 HDi Boxer Platform/Chassis 2.8 HDi 4x4 Boxer Platform/ Chassis 2.8 HDi All-wheel Drive	10/00→ 10/00→11/01 10/00→ 04/02→ 10/00→11/01	8140.43S Euro 3	4cyl. 2798cc 92kW (125PS)	59
		Diesel	Turbo Intercooled	TD17514

08-122200-00	STD	94.40	2.500		008 CK P	KV1
08-122208-00	0.60mm		2.000		005 P	IKA
[R60070]			2.500		231 CR P	GOE12

Boxer Box 2.8 D, Boxer Bus 2.8 D, Boxer Platform/Chassis 2.8 D	01/99→02/02	8140.63 (F28D)	4cyl. 2798cc 64kW (87PS)	59
		Diesel		TD24917

08-108200-00	STD	94.40	3.000		008 CR P	KV1
08-108208-00	0.60mm		2.000		026 P	STD
[R60060]			2.500		231 CR P	STD

MODEL INDEX

Modelverzeichnis • Index de modele • Índice de Modelo
Indeks modelu • Модель автомобиля • دليل الموديل



CCM

x



9

01/55→12/59	356 Cabriolet/Speedster A 1600 S	616.15	Petrol	1582	B4	2
01/59→12/63	356 Cabriolet/Speedster B 1600 Super 75	616.15	Petrol	1582	B4	2
	356 Cabriolet/Speedster B 1600 Super 75	616.16	Petrol	1582	B4	2
	356 Cabriolet/Speedster B 1600 Super 90	616.16	Petrol	1582	B4	2
01/63→12/65	356 Cabriolet/Speedster C 1600	616.15	Petrol	1582	B4	2
01/55→12/59	356 Coupe A 1600 Super	616.15	Petrol	1582	B4	2
01/59→12/63	356 Coupe B 1600 Super 75	616.15	Petrol	1582	B4	2
01/63→12/65	356 Coupe C 1600	616.15	Petrol	1582	B4	2
08/90→09/93	911 (964) 3.3 Turbo	M 30.69	Petrol	3299	B6	22
06/91→12/92	911 (964) 3.3 Turbo S	M 30.69S	Petrol	3299	B6	22
07/89→09/93	911 (964) 3.6 Carrera	M 64.01	Petrol	3598	B6	27
07/89→09/93	911 (964) 3.6 Carrera	M 64.02	Petrol	3598	B6	27
12/88→09/93	911 (964) 3.6 Carrera 4	M 64.01	Petrol	3598	B6	27
01/93→09/93	911 (964) 3.6 Turbo	M 64.50	Petrol	3600	B6	27
10/93→08/95	911 (993) 3.6 Carrera	M 64.05	Petrol	3600	B6	28
10/93→08/95	911 (993) 3.6 Carrera	M 64.06	Petrol	3600	B6	28
10/93→08/95	911 (993) 3.6 Carrera	M 64.07	Petrol	3600	B6	28
10/93→08/95	911 (993) 3.6 Carrera	M 64.08	Petrol	3600	B6	28
08/95→09/97	911 (993) 3.6 Carrera	M 64.21	Petrol	3600	B6	28
08/95→09/97	911 (993) 3.6 Carrera	M 64.22	Petrol	3600	B6	28
08/95→09/97	911 (993) 3.6 Carrera	M 64.23	Petrol	3600	B6	28
08/95→09/97	911 (993) 3.6 Carrera	M 64.24	Petrol	3600	B6	28
07/94→08/95	911 (993) 3.6 Carrera 4	M 64.05	Petrol	3600	B6	28
07/94→08/95	911 (993) 3.6 Carrera 4	M 64.07	Petrol	3600	B6	28
08/95→09/97	911 (993) 3.6 Carrera 4	M 64.21	Petrol	3600	B6	28
08/95→09/97	911 (993) 3.6 Carrera 4	M 64.23	Petrol	3600	B6	28
03/95→09/97	911 (993) 3.6 Turbo 4	M 64.60	Petrol	3598	B6	29
06/95→09/97	911 (993) 3.8 Carrera RS	M 64.20	Petrol	3746	B6	33
09/97→09/01	911 (996) 3.4 Carrera	M 96.01	Petrol	3387	B6	19
09/97→09/01	911 (996) 3.4 Carrera	M 96.04	Petrol	3387	B6	19
09/97→09/01	911 (996) 3.4 Carrera 4	M 96.01	Petrol	3387	B6	19
09/97→09/01	911 (996) 3.4 Carrera 4	M 96.04	Petrol	3387	B6	19
10/01→08/05	911 (996) 3.6 Carrera	M 96.03	Petrol	3596	B6	20
10/01→08/05	911 (996) 3.6 Carrera 4	M 96.03	Petrol	3596	B6	20
02/03→08/05	911 (996) 3.6 Carrera 4S	M 96.03	Petrol	3596	B6	20
02/03→08/05	911 (996) 3.6 Carrera S	M 96.03	Petrol	3596	B6	20
04/01→08/05	911 (996) 3.6 GT2	M 96.70	Petrol	3600	B6	30
03/99→08/05	911 (996) 3.6 GT3	M 96.76	Petrol	3598	B6	31
03/03→08/05	911 (996) 3.6 GT3	M 96.79	Petrol	3598	B6	31
08/04→08/05	911 (996) 3.6 S	M 96.70	Petrol	3600	B6	30
06/00→08/05	911 (996) 3.6 Turbo 4	M 96.70	Petrol	3600	B6	30
02/03→08/05	911 (996) 3.6 Turbo 4S	M 96.70	Petrol	3600	B6	30
07/04→	911 (997) 3.6 Carrera	M 96.05	Petrol	3596	B6	20
07/04→	911 (997) 3.6 Carrera 4	M 96.05	Petrol	3596	B6	20
09/07→	911 (997) 3.6 GT 2	M 97.70S	Petrol	3600	B6	30
05/10→	911 (997) 3.6 GT2 RS	M 97.70	Petrol	3600	B6	30
03/06→	911 (997) 3.6 Turbo	M 97.70	Petrol	3600	B6	30
05/09→	911 (997) 3.8 GT3	M 97.77	Petrol	3797	B6	34
08/09→	911 (997) 3.8 GT3 RS	M 97.77R	Petrol	3797	B6	34
09/68→12/69	911 2.0 E	901.09	Petrol	1990	B6	1
09/68→12/69	911 2.0 E	901.11	Petrol	1990	B6	1
01/63→08/67	911 2.0 L	901.01	Petrol	1990	B6	1
01/63→08/67	911 2.0 L	901.05	Petrol	1990	B6	1
07/66→11/68	911 2.0 S	901.02	Petrol	1990	B6	1
09/68→12/69	911 2.0 S	901.10	Petrol	1990	B6	1
08/68→02/72	911 2.0 T	901.03	Petrol	1990	B6	1
08/68→02/72	911 2.0 T	901.13	Petrol	1990	B6	1
09/69→12/71	911 2.2 E	911.01	Petrol	2179	B6	3
09/69→12/71	911 2.2 E	911.04	Petrol	2179	B6	3
09/69→12/71	911 2.2 S	911.02	Petrol	2179	B6	4



CCM

x



9

01/70→12/72	911 2.2 T	911.06	Petrol	2195	B6	5
01/70→12/72	911 2.2 T	911.07	Petrol	2195	B6	5
01/70→12/72	911 2.2 T	911.08	Petrol	2195	B6	5
08/71→12/73	911 2.3 E	911.52	Petrol	2341	B6	4
08/71→12/73	911 2.3 E	911.62	Petrol	2311	B6	4
08/71→01/76	911 2.3 S	911.53	Petrol	2341	B6	4
08/71→01/76	911 2.3 S	911.63	Petrol	2311	B6	4
08/73→01/76	911 2.7 S Carrera	911.42	Petrol	2687	B6	9
08/73→01/76	911 2.7 S Carrera	911.47	Petrol	2687	B6	9
08/73→01/76	911 2.7 S Carrera	911.93	Petrol	2687	B6	9
08/73→01/76	911 2.7 S Carrera	911.98	Petrol	2687	B6	9
08/72→01/79	911 2.7 SC Carrera RS	911.83	Petrol	2687	B6	10
09/75→06/77	911 3.0 SC Carrera	930.02	Petrol	2993	B6	14
07/77→06/80	911 3.0 SC Carrera	930.03	Petrol	2993	B6	14
09/79→06/80	911 3.0 SC Carrera	930.09	Petrol	2993	B6	14
07/77→06/80	911 3.0 SC Carrera	930.13	Petrol	2993	B6	14
01/75→12/77	911 3.0 Turbo	930.50	Petrol	2993	B6	16
01/75→12/77	911 3.0 Turbo	930.52	Petrol	2993	B6	16
08/86→08/89	911 3.2	930.25	Petrol	3164	B6	15
08/83→08/89	911 3.2 SC Carrera	930.20	Petrol	3164	B6	15
02/84→06/87	911 3.2 SC Carrera	930.21	Petrol	3164	B6	15
08/83→08/89	911 3.2 SC Carrera	930.26	Petrol	3164	B6	15
09/77→06/87	911 3.3 SC Turbo	930.60	Petrol	3299	B6	22
09/77→06/87	911 3.3 SC Turbo	930.66/68	Petrol	3299	B6	22
09/86→11/90	911 3.3 Turbo	930.60	Petrol	3299	B6	22
06/86→08/89	911 3.3 Turbo	930.66/68	Petrol	3299	B6	22
05/89→05/94	911 Convertible (964) 3.6 Carrera 4	M 64.01	Petrol	3598	B6	27
07/89→05/94	911 Convertible (964) 3.6 Carrera	M 64.01	Petrol	3598	B6	27
07/89→05/94	911 Convertible (964) 3.6 Carrera	M 64.02	Petrol	3598	B6	27
07/94→08/95	911 Convertible (993) 3.6 Carrera	M 64.05	Petrol	3600	B6	28
07/94→08/95	911 Convertible (993) 3.6 Carrera 4	M 64.05	Petrol	3600	B6	28
07/94→08/95	911 Convertible (993) 3.6 Carrera	M 64.06	Petrol	3600	B6	28
07/94→08/95	911 Convertible (993) 3.6 Carrera	M 64.07	Petrol	3600	B6	28
07/94→08/95	911 Convertible (993) 3.6 Carrera 4	M 64.07	Petrol	3600	B6	28
07/94→08/95	911 Convertible (993) 3.6 Carrera	M 64.08	Petrol	3600	B6	28
08/95→09/97	911 Convertible (993) 3.6 Carrera	M 64.21	Petrol	3600	B6	28
08/95→09/97	911 Convertible (993) 3.6 Carrera 4	M 64.21	Petrol	3600	B6	28
08/95→09/97	911 Convertible (993) 3.6 Carrera	M 64.22	Petrol	3600	B6	28
08/95→09/97	911 Convertible (993) 3.6 Carrera	M 64.23	Petrol	3600	B6	28
08/95→09/97	911 Convertible (993) 3.6 Carrera 4	M 64.23	Petrol	3600	B6	28
08/95→09/97	911 Convertible (993) 3.6 Carrera	M 64.24	Petrol	3600	B6	28
02/98→09/01	911 Convertible (996) 3.4 Carrera	M 96.01	Petrol	3387	B6	19
02/98→09/01	911 Convertible (996) 3.4 Carrera 4	M 96.02	Petrol	3387	B6	19
02/98→09/01	911 Convertible (996) 3.4 Carrera	M 96.04	Petrol	3387	B6	19
02/98→09/01	911 Convertible (996) 3.4 Carrera 4	M 96.04	Petrol	3387	B6	19
06/02→08/05	911 Convertible (996) 3.6 Carrera 4S	M 96.03	Petrol	3596	B6	20
06/02→08/05	911 Convertible (996) 3.6 Carrera S	M 96.03	Petrol	3596	B6	20
10/01→08/05	911 Convertible (996) 3.6 Carrera	M 96.03	Petrol	3596	B6	20
10/01→08/05	911 Convertible (996) 3.6 Carrera 4	M 96.03	Petrol	3596	B6	20
08/04→08/05	911 Convertible (996) 3.6 S	M 96.70	Petrol	3600	B6	30
10/03→08/05	911 Convertible (996) 3.6 Turbo 4	M 96.70	Petrol	3600	B6	30
10/03→08/05	911 Convertible (996) 3.6 Turbo 4S	M 96.70	Petrol	3600	B6	30
04/05→	911 Convertible (997) 3.6 Carrera	M 96.05	Petrol	3596	B6	20
04/05→	911 Convertible (997) 3.6 Carrera 4	M 96.05	Petrol	3596	B6	20
09/07→	911 Convertible (997) 3.6 Turbo	M 97.70	Petrol	3600	B6	30
08/86→08/89	911 Convertible 3.1 Carrera Speedster	930.20	Petrol	3164	B6	15
08/86→08/89	911 Convertible 3.1 Carrera Speedster	930.25	Petrol	3164	B6	15
08/83→08/84	911 Convertible 3.1 SC Carrera	930.20	Petrol	3164	B6	15
10/84→08/89	911 Convertible 3.1 SC Carrera	930.21	Petrol	3164	B6	15
09/86→08/89	911 Convertible 3.3 Turbo	930.66/68	Petrol	3299	B6	22

MODEL INDEX

Modelverzeichnis • Index de modele • Índice de Modelo
Indeks modelu • Модель автомобиля • دليل الموديل



CCM

x



9

01/00→	911 GT3R	M 64	Petrol	3746	B6	32
08/92→06/94	911 Speedster (964) 3.6 Carrera	M 64.01	Petrol	3598	B6	27
08/92→06/94	911 Speedster (964) 3.6 Carrera	M 64.02	Petrol	3598	B6	27
12/88→09/93	911 Targa (964) 3.6 Carrera	M 64.01	Petrol	3598	B6	27
12/88→09/93	911 Targa (964) 3.6 Carrera	M 64.02	Petrol	3598	B6	27
12/88→09/93	911 Targa (964) 3.6 Carrera 4	M 64.01	Petrol	3598	B6	27
08/95→09/97	911 Targa (993) 3.6 Carrera	M 64.21	Petrol	3600	B6	28
08/95→09/97	911 Targa (993) 3.6 Carrera	M 64.22	Petrol	3600	B6	28
08/95→09/97	911 Targa (993) 3.6 Carrera	M 64.23	Petrol	3600	B6	28
08/95→09/97	911 Targa (993) 3.6 Carrera	M 64.24	Petrol	3600	B6	28
12/01→08/05	911 Targa (996) 3.6	M 96.03	Petrol	3596	B6	20
07/06→	911 Targa (997) 3.6 Carrera 4	M 96.05	Petrol	3596	B6	20
09/68→02/72	911 Targa 2.0 E	901.09	Petrol	1990	B6	1
09/68→02/72	911 Targa 2.0 E	901.11	Petrol	1990	B6	1
11/64→11/68	911 Targa 2.0 L	901.01	Petrol	1990	B6	1
11/64→11/68	911 Targa 2.0 L	901.05	Petrol	1990	B6	1
07/66→11/68	911 Targa 2.0 S	901.02	Petrol	1990	B6	1
07/66→02/72	911 Targa 2.0 S	901.10	Petrol	1990	B6	1
06/67→02/72	911 Targa 2.0 T	901.03	Petrol	1990	B6	1
06/67→02/72	911 Targa 2.0 T	901.13	Petrol	1990	B6	1
09/69→02/72	911 Targa 2.2 E	911.01	Petrol	2179	B6	3
09/69→02/72	911 Targa 2.2 E	911.04	Petrol	2179	B6	3
09/69→02/72	911 Targa 2.2 S	911.02	Petrol	2179	B6	4
01/70→12/72	911 Targa 2.2 T	911.06	Petrol	2195	B6	5
08/71→12/73	911 Targa 2.3 E	911.52	Petrol	2341	B6	4
08/71→12/73	911 Targa 2.3 E	911.62	Petrol	2311	B6	4
09/71→08/73	911 Targa 2.3 S	911.53	Petrol	2341	B6	4
09/71→08/73	911 Targa 2.3 S	911.63	Petrol	2311	B6	4
08/73→01/76	911 Targa 2.7 S	911.42	Petrol	2687	B6	9
08/73→01/76	911 Targa 2.7 S	911.47	Petrol	2687	B6	9
08/73→01/76	911 Targa 2.7 S	911.93	Petrol	2687	B6	9
08/73→01/76	911 Targa 2.7 S	911.98	Petrol	2687	B6	9
08/72→01/79	911 Targa 2.7 SC Carrera RS	911.83	Petrol	2687	B6	10
09/75→06/77	911 Targa 3.0 SC Carrera	930.02	Petrol	2993	B6	14
07/77→06/80	911 Targa 3.0 SC Carrera	930.03	Petrol	2993	B6	14
09/79→06/80	911 Targa 3.0 SC Carrera	930.09	Petrol	2993	B6	14
07/77→06/80	911 Targa 3.0 SC Carrera	930.13	Petrol	2993	B6	14
09/86→11/90	911 Targa 3.3 Turbo	930.66/68	Petrol	3299	B6	22
01/65→12/69	912 1.6	616.36	Petrol	1582	B4	2
01/65→12/69	912 1.6	616.39	Petrol	1582	B4	2
01/65→12/69	912 1.6	616.40	Petrol	1582	B4	2
03/65→02/70	912 Targa 1.6	616.36	Petrol	1582	B4	2
03/65→02/70	912 Targa 1.6	616.39	Petrol	1582	B4	2
03/65→02/70	912 Targa 1.6	616.40	Petrol	1582	B4	2
01/73→	914	AP	Petrol	1795	4	11
11/69→12/73	914 /6 2.0	901.36	Petrol	1990	B6	1
11/69→12/73	914 /6 2.0	901.37	Petrol	1990	B6	1
08/73→02/76	914 1.8	AN	Petrol	1795	B4	11
01/72→12/75	914 2.0	GB	Petrol	1971	B4	13
11/75→08/89	924 2.0	XJ	Petrol	1984	4	8
06/80→10/86	924 2.0 Carrera GT	M 31.50	Petrol	1984	4	7
11/78→06/80	924 2.0 Turbo	M 31.01	Petrol	1984	4	7
06/80→10/86	924 2.0 Turbo	M 31.03	Petrol	1984	4	7
10/81→12/84	924 2.5 S	M 44.01	Petrol	2479	4	25
10/81→12/84	924 2.5 S	M 44.03	Petrol	2479	4	25
09/85→07/87	924 2.5 S	M 44.07	Petrol	2479	4	25
09/85→07/87	924 2.5 S	M 44.08	Petrol	2479	4	25
08/87→07/88	924 2.5 S	M 44.09	Petrol	2479	4	24
08/87→07/88	924 2.5 S	M 44.10	Petrol	2479	4	24
09/77→08/82	928 4.5	M 28.10	Petrol	4474	V8	17

Modelverzeichnis • Index de modele • Índice de Modelo
Indeks modelu • Модель автомобиля • دليل الموديل

MODEL INDEX



CCM

x



9

09/79→07/83	928 4.7 S	M 28.11	Petrol	4664	V8	23
09/79→07/83	928 4.7 S	M 28.12	Petrol	4664	V8	23
09/82→12/84	928 4.7 S	M 28.20	Petrol	4664	V8	23
08/83→07/86	928 4.7 S	M 28.21	Petrol	4664	V8	23
08/83→07/86	928 4.7 S	M 28.22	Petrol	4664	V8	23
	928 4.75	M 28.19	Petrol	4664	V8	23
08/91→11/95	928 5.4 GTS	M 28.49	Petrol	5397	V8	24
08/91→11/95	928 5.4 GTS	M 28.50	Petrol	5397	V8	24
06/81→07/87	944 2.5	M 44.01	Petrol	2479	4	25
01/85→07/87	944 2.5	M 44.02	Petrol	2479	4	25
06/81→07/87	944 2.5	M 44.03	Petrol	2479	4	25
01/85→07/87	944 2.5	M 44.04	Petrol	2479	4	25
06/81→12/90	944 2.5	M 44.05	Petrol	2479	4	26
06/81→07/87	944 2.5	M 44.06	Petrol	2479	4	25
01/85→07/87	944 2.5	M 44.07	Petrol	2479	4	25
01/85→07/87	944 2.5	M 44.08	Petrol	2479	4	25
08/87→12/90	944 2.5	M 44.09	Petrol	2479	4	24
08/87→12/90	944 2.5	M 44.10	Petrol	2479	4	24
08/86→07/88	944 2.5 S	M 44.40	Petrol	2479	4	24
08/85→07/88	944 2.5 Turbo	M 44.50	Petrol	2479	4	24
08/85→07/88	944 2.5 Turbo	M 44.51	Petrol	2479	4	24
09/87→07/91	944 2.5 Turbo	M 44.52	Petrol	2479	4	24
12/88→07/91	944 3.0 S2	M 44.41	Petrol	2990	4	35
11/90→07/91	944 Convertible 2.5 Turbo	M 44.52	Petrol	2479	4	24
12/88→07/91	944 Convertible 3.0 S2	M 44.41	Petrol	2990	4	35
06/91→11/95	968 3.0	M 44.43	Petrol	2990	4	35
06/91→11/95	968 3.0	M 44.44	Petrol	2990	4	35
06/91→11/95	968 Convertible 3.0	M 44.43	Petrol	2990	4	35
06/91→11/95	968 Convertible 3.0	M 44.44	Petrol	2990	4	35
07/06→	Boxster (987) S 3.4	M 97.21	Petrol	3387	B6	21
08/08→	Boxster (987) S 3.4	M 97.22	Petrol	3387	B6	21
10/03→	Cayenne (955) 3.2	M02.2Y	Petrol	3189	V6	6
01/04→	Cayenne (955) Turbo S 4.5	M 48.50S	Petrol	4511	V8	12
06/12→	Cayenne 4.8 GTS	M 48.02	Petrol	4806	V8	18
06/10→	Cayenne 4.8 S	M 48.02	Petrol	4806	V8	18
11/05→	Cayman (987) S 3.4	M 97.21	Petrol	3387	B6	21
08/08→	Cayman (987) S 3.4 Sport	M 97.22	Petrol	3387	B6	21
05/10→	Panamera 3.6	M 46.20	Petrol	3605	V6	18
05/10→	Panamera 3.6 4	M 46.40	Petrol	3605	V6	18
09/09→	Panamera 4.8 4S	M 48.40	Petrol	4806	V8	18
01/12→	Panamera 4.8 GTS	M 48.40	Petrol	4806	V8	18
09/09→	Panamera 4.8 S	M 48.20	Petrol	4806	V8	18

ENGINE INDEX

Motorverzeichnis • Index de moteur • Índice de Motor
Indeks silnika • Модель двигателя • دليل المحرك



CCM



9

616.15	Petrol	1582	B4	82.50	2
616.16	Petrol	1582	B4	82.50	2
616.36	Petrol	1582	B4	82.50	2
616.39	Petrol	1582	B4	82.50	2
616.40	Petrol	1582	B4	82.50	2
901.01	Petrol	1990	B6	80.00	1
901.02	Petrol	1990	B6	80.00	1
901.03	Petrol	1990	B6	80.00	1
901.05	Petrol	1990	B6	80.00	1
901.09	Petrol	1990	B6	80.00	1
901.10	Petrol	1990	B6	80.00	1
901.11	Petrol	1990	B6	80.00	1
901.13	Petrol	1990	B6	80.00	1
901.36	Petrol	1990	B6	80.00	1
901.37	Petrol	1990	B6	80.00	1
911.01	Petrol	2179	B6	84.00	3
911.02	Petrol	2179	B6	84.00	4
911.04	Petrol	2179	B6	84.00	3
911.06	Petrol	2195	B6	84.00	5
911.07	Petrol	2195	B6	84.00	5
911.08	Petrol	2195	B6	84.00	5
911.42	Petrol	2687	B6	90.00	9
911.47	Petrol	2687	B6	90.00	9
911.52	Petrol	2341	B6	84.00	4
911.53	Petrol	2341	B6	84.00	4
911.62	Petrol	2311	B6	84.00	4
911.63	Petrol	2311	B6	84.00	4
911.83	Petrol	2687	B6	90.00	10
911.93	Petrol	2687	B6	90.00	9
911.98	Petrol	2687	B6	90.00	9
930.02	Petrol	2993	B6	95.00	14
930.03	Petrol	2993	B6	95.00	14
930.09	Petrol	2993	B6	95.00	14
930.13	Petrol	2993	B6	95.00	14
930.20	Petrol	3164	B6	95.00	15
930.21	Petrol	3164	B6	95.00	15
930.25	Petrol	3164	B6	95.00	15
930.26	Petrol	3164	B6	95.00	15
930.50	Petrol	2993	B6	95.00	16
930.52	Petrol	2993	B6	95.00	16
930.60	Petrol	3299	B6	97.00	22
930.66/68	Petrol	3299	B6	97.00	22
AN	Petrol	1795	B4	93.00	11
AP	Petrol	1795	4	93.00	11
GB	Petrol	1971	B4	94.00	13
M 28.10	Petrol	4474	V8	95.00	17
M 28.11	Petrol	4664	V8	97.00	23
M 28.12	Petrol	4664	V8	97.00	23
M 28.19	Petrol	4664	V8	97.00	23
M 28.20	Petrol	4664	V8	97.00	23
M 28.21	Petrol	4664	V8	97.00	23
M 28.22	Petrol	4664	V8	97.00	23
M 28.49	Petrol	5397	V8	100.00	24
M 28.50	Petrol	5397	V8	100.00	24
M 30.69	Petrol	3299	B6	97.00	22
M 30.69S	Petrol	3299	B6	97.00	22
M 31.01	Petrol	1984	4	86.50	7
M 31.03	Petrol	1984	4	86.50	7
M 31.50	Petrol	1984	4	86.50	7
M 44.01	Petrol	2479	4	100.00	25

Motorverzeichnis • Index de moteur • Índice de Motor
Indeks silnika • Модель двигателя • دليل المحرك

ENGINE INDEX



CCM

x



9

M 44.02	Petrol	2479	4	100.00	25
M 44.03	Petrol	2479	4	100.00	25
M 44.04	Petrol	2479	4	100.00	25
M 44.05	Petrol	2479	4	100.00	26
M 44.06	Petrol	2479	4	100.00	25
M 44.07	Petrol	2479	4	100.00	25
M 44.08	Petrol	2479	4	100.00	25
M 44.09	Petrol	2479	4	100.00	24
M 44.10	Petrol	2479	4	100.00	24
M 44.40	Petrol	2479	4	100.00	24
M 44.41	Petrol	2990	4	104.00	35
M 44.43	Petrol	2990	4	104.00	35
M 44.44	Petrol	2990	4	104.00	35
M 44.50	Petrol	2479	4	100.00	24
M 44.51	Petrol	2479	4	100.00	24
M 44.52	Petrol	2479	4	100.00	24
M 46.20	Petrol	3605	V6	96.00	18
M 46.40	Petrol	3605	V6	96.00	18
M 48.02	Petrol	4806	V8	96.00	18
M 48.20	Petrol	4806	V8	96.00	18
M 48.40	Petrol	4806	V8	96.00	18
M 48.50S	Petrol	4511	V8	93.00	12
M 64	Petrol	3746	B6	102.00	32
M 64.01	Petrol	3598	B6	100.00	27
M 64.02	Petrol	3598	B6	100.00	27
M 64.05	Petrol	3600	B6	100.00	28
M 64.06	Petrol	3600	B6	100.00	28
M 64.07	Petrol	3600	B6	100.00	28
M 64.08	Petrol	3600	B6	100.00	28
M 64.20	Petrol	3746	B6	102.00	33
M 64.21	Petrol	3600	B6	100.00	28
M 64.22	Petrol	3600	B6	100.00	28
M 64.23	Petrol	3600	B6	100.00	28
M 64.24	Petrol	3600	B6	100.00	28
M 64.50	Petrol	3600	B6	100.00	27
M 64.60	Petrol	3598	B6	100.00	29
M 96.01	Petrol	3387	B6	96.00	19
M 96.02	Petrol	3387	B6	96.00	19
M 96.03	Petrol	3596	B6	96.00	20
M 96.04	Petrol	3387	B6	96.00	19
M 96.05	Petrol	3596	B6	96.00	20
M 96.70	Petrol	3600	B6	100.00	30
M 96.76	Petrol	3598	B6	100.00	31
M 96.79	Petrol	3598	B6	100.00	31
M 97.21	Petrol	3387	B6	96.00	21
M 97.22	Petrol	3387	B6	96.00	21
M 97.70	Petrol	3600	B6	100.00	30
M 97.70S	Petrol	3600	B6	100.00	30
M 97.77	Petrol	3797	B6	102.70	34
M 97.77R	Petrol	3797	B6	102.70	34
M02.2Y	Petrol	3189	V6	84.00	6
XJ	Petrol	1984	4	86.50	8



911 2.0 L 911 Targa 2.0 L	01/63→08/67 11/64→11/68	901.01	B6cyl. 1990cc	81-118kW (110-160PS)	1	TD10287
911 2.0 S, 911 Targa 2.0 S	07/66→11/68	901.02	B6cyl. 1990cc	81-118kW (110-160PS)		TD10289
911 2.0 T 911 Targa 2.0 T	08/68→02/72 06/67→02/72	901.03	B6cyl. 1990cc	81-118kW (110-160PS)		TD5409
911 2.0 L 911 Targa 2.0 L	01/63→08/67 11/64→11/68	901.05	B6cyl. 1990cc	81-118kW (110-160PS)		TD10288
911 2.0 E 911 Targa 2.0 E	09/68→12/69 09/68→02/72	901.09	B6cyl. 1990cc	81-118kW (110-160PS)		TD5407
911 2.0 S 911 Targa 2.0 S	09/68→12/69 07/66→02/72	901.10	B6cyl. 1990cc	81-118kW (110-160PS)		TD10290
911 2.0 E 911 Targa 2.0 E	09/68→12/69 09/68→02/72	901.11	B6cyl. 1990cc	81-118kW (110-160PS)		TD5408
911 2.0 T 911 Targa 2.0 T	08/68→02/72 06/67→02/72	901.13	B6cyl. 1990cc	81-118kW (110-160PS)		TD5410
914 /6 2.0	11/69→12/73	901.36	B6cyl. 1990cc	81-118kW (110-160PS)		TD5403
914 /6 2.0	11/69→12/73	901.37	B6cyl. 1990cc	81-118kW (110-160PS)		TD5404

08-320700-10	STD	80.00	1.500		005 IF P	IKA
			2.000		005 IF P	STD
			4.000		232	STD

356 Cabriolet/Speedster A 1600 S 356 Cabriolet/Speedster B 1600 Super 75 356 Cabriolet/Speedster C 1600 356 Coupe A 1600 Super 356 Coupe B 1600 Super 75 356 Coupe C 1600	01/55→12/59 01/59→12/63 01/63→12/65 01/55→12/59 01/59→12/63 01/63→12/65	616.15	B4cyl. 1582cc	55kW (75PS)	2	TD20989
356 Cabriolet/Speedster B 1600 Super 75, 356 Cabriolet/Speedster B 1600 Super 90		616.16	B4cyl. 1582cc	66kW (89PS)		TD20955





912 1.6			01/65→12/69	616.36				
912 Targa 1.6			03/65→02/70		B4cyl.			
					1582cc	66kW (89PS)		TD20956
912 1.6			01/65→12/69	616.39				
912 Targa 1.6			03/65→02/70		B4cyl.			
					1582cc	66kW (89PS)		TD27907
912 1.6			01/65→12/69	616.40				
912 Targa 1.6			03/65→02/70		B4cyl.			
					1582cc	66kW (89PS)		TD27908
08-320600-10	STD	82.50	1.500		005 IF P			IKA
			2.000		005 IF P			STD
			4.000		232			STD
911 2.2 E			09/69→12/71	911.01				
911 Targa 2.2 E			09/69→02/72		B6cyl.			3
					2179cc	114kW (155PS)		TD5411
911 2.2 E			09/69→12/71	911.04				
911 Targa 2.2 E			09/69→02/72		B6cyl.			
					2179cc	114kW (155PS)		TD5412
08-319500-10	STD	84.00	1.500		005 IF P			IKA
			2.000		005 IF P			STD
			4.000		231			STD
911 2.2 S			09/69→12/71	911.02				
911 Targa 2.2 S			09/69→02/72		B6cyl.			4
					2179cc	132kW (180PS)		TD5413
911 2.3 E, 911 Targa 2.3 E			08/71→12/73	911.52				
					B6cyl.			
					2341cc	121kW (165PS)		TD5416
911 2.3 S			08/71→01/76	911.53				
911 Targa 2.3 S			09/71→08/73		B6cyl.			
					2341cc	140kW (190PS)		TD5414
911 2.3 E, 911 Targa 2.3 E			08/71→12/73	911.62				
					B6cyl.			
					2311cc	121kW (165PS)		TD5417





911 2.3 S			08/71→01/76	911.63				
911 Targa 2.3 S			09/71→08/73		B6cyl. 2311cc	140kW (190PS)		
								TD5415
08-319600-10	STD	84.00	1.500		005 IF P			IKA
			1.500		026 IW P			STD
			4.000		232 P			STD
911 2.2 T, 911 Targa 2.2 T			01/70→12/72	911.06				5
					B6cyl. 2195cc	92kW (125PS)		TD20957
911 2.2 T			01/70→12/72	911.07				
					B6cyl. 2195cc	92kW (125PS)		TD20958
911 2.2 T			01/70→12/72	911.08				
					B6cyl. 2195cc	92kW (125PS)		TD20959
08-325300-00	STD	84.00	1.500		005 IF P			IKA
			2.000		005 IF P			STD
			5.000		230 P			STD
Cayenne (955) 3.2			10/03→	M02.2Y				6
					V6cyl. 3189cc	177-184kW (241-250PS)		TD23319
08-137400-00	STD	84.00	1.200		001 NT			ST
			1.500		026 P			F12/F14
			2.000		712 CR			ST
924 2.0 Turbo			11/78→06/80	M 31.01				7
					4cyl. 1984cc	125kW (170PS)		TD2972
924 2.0 Turbo			06/80→10/86	M 31.03				
					4cyl. 1984cc	130kW (177PS)		TD2973
924 2.0 Carrera GT			06/80→10/86	M 31.50				
					4cyl. 1984cc	154kW (210PS)		TD2974
					Turbo Intercooled			
08-320500-10	STD	86.50	1.500		001 IF CR P			KV1
			1.750		026 P			IKA
			3.000		231 CR P			STD



924 2.0			11/75→08/89	XJ		4cyl. 1984cc	92kW (125PS)	8
								TD2994
08-399700-10	STD	86.50	2.000		001 IF CR P			KV1
08-399707-10	0.50mm		2.500		005 IF P			STD
			5.000		231 CR P			STD
911 2.7 S Carrera, 911 Targa 2.7 S			08/73→01/76	911.42		B6cyl. 2687cc	129kW (175PS)	9
								TD5421
911 2.7 S Carrera, 911 Targa 2.7 S			08/73→01/76	911.47		B6cyl. 2687cc	129kW (175PS)	
								TD5422
911 2.7 S Carrera, 911 Targa 2.7 S			08/73→01/76	911.93		B6cyl. 2687cc	129kW (175PS)	
								TD5419
911 2.7 S Carrera, 911 Targa 2.7 S			08/73→01/76	911.98		B6cyl. 2687cc	129kW (175PS)	
								TD5420
08-319800-10	STD	90.00	1.500		006 IF P			IKA
			1.750		026 P			IKA
			4.000		232 P			STD
911 2.7 SC Carrera RS, 911 Targa 2.7 SC Carrera RS			08/72→01/79	911.83		B6cyl. 2687cc	154kW (210PS)	10
								TD5418
08-319700-10	STD	90.00	1.500		006 IF P			IKA
			1.500		005 IF P			STD
			4.000		232 P			STD
914 1.8			08/73→02/76	AN		B4cyl. 1795cc	63kW (86PS)	11
								TD22922
914			01/73→	AP		4cyl. 1795cc	50kW (68PS)	
								FM6592
08-398800-00	STD	93.00	2.000		005 IF P			IKA
			2.000		026 P			STD
			4.000		712 CR			ST



Cayenne (955) Turbo S 4.5		01/04→	M 48.50S		V8cyl. 4511cc	368kW (500PS)	12
TD18466							

08-431200-00	STD	93.00	1.200		001 NT	ST
			1.500		005 P	GOE13
			2.000		712	ST

914 2.0		01/72→12/75	GB		B4cyl. 1971cc	74kW (100PS)	13
TD18879							

08-318600-10	STD	94.00	1.500		005 IW P	F12/F14
			1.750		005 IW	STD
			4.000		231 P	STD
08-399100-00	STD	94.00	1.750		005 IF P	IKA
08-399105-00	0.25mm		2.000		026 P	STD
08-399107-00	0.50mm		4.000		231 P	STD
08-399111-00	1.00mm					

911 3.0 SC Carrera, 911 Targa 3.0 SC Carrera		09/75→06/77	930.02		B6cyl. 2993cc	147kW (200PS)	14
TD21393							

911 3.0 SC Carrera, 911 Targa 3.0 SC Carrera		07/77→06/80	930.03		B6cyl. 2993cc	132kW (180PS)	TD28033
---	--	-------------	---------------	--	-------------------------	----------------------	----------------

911 3.0 SC Carrera, 911 Targa 3.0 SC Carrera		09/79→06/80	930.09		B6cyl. 2993cc	138kW (188PS)	TD21394
---	--	-------------	---------------	--	-------------------------	----------------------	----------------

911 3.0 SC Carrera, 911 Targa 3.0 SC Carrera		07/77→06/80	930.13		B6cyl. 2993cc	132kW (180PS)	TD28034
---	--	-------------	---------------	--	-------------------------	----------------------	----------------

08-320000-10	STD	95.00	1.500		005 IF P	IKA
			1.750		026 P	IKA
			4.000		232 P	STD



911 3.2 SC Carrera	08/83→08/89	930.20					
911 Convertible 3.1 Carrera Speedster	08/86→08/89		B6cyl.				15
911 Convertible 3.1 SC Carrera	08/83→08/84		3164cc	170kW (231PS)			
TD2944							
911 3.2 SC Carrera	02/84→06/87	930.21					
911 Convertible 3.1 SC Carrera	10/84→08/89		B6cyl.				
			3164cc	152kW (207PS)			
TD2945							
911 3.2,	08/86→08/89	930.25					
911 Convertible 3.1 Carrera Speedster			B6cyl.				
			3164cc	160kW (218PS)			
TD2946							
911 3.2 SC Carrera	08/83→08/89	930.26					
			B6cyl.				
			3164cc	170kW (231PS)			
TD2947							

08-320900-10	STD	95.00	1.500		005 IF P		IKA
08/1980→			1.750		026 P		IKA
			3.500		232 P		STD

911 3.0 Turbo	01/75→12/77	930.50					
			B6cyl.				16
			2993cc	184kW (250PS)			
			Turbo				TD10048
911 3.0 Turbo	01/75→12/77	930.52					
			B6cyl.				
			2993cc	191kW (260PS)			
			Turbo				TD21395

08-319900-10	STD	95.00	1.500		005 IF P		IKA
			1.500		005 IF P		IKA
			4.000		232 P		STD

928 4.5	09/77→08/82	M 28.10					
			V8cyl.				17
			4474cc	177kW (240PS)			
TD18880							

08-320000-10	STD	95.00	1.500		005 IF P		IKA
→07/1979			1.750		026 P		IKA
			4.000		232 P		STD
08-321700-00	STD	95.00	1.500		005 P		IKA
08/1979→			1.750		026 P		IKA
			3.000		232 P		STD



Panamera 3.6	05/10→	M 46.20	V6cyl. 3605cc	220kW (299PS)	18	TD25179
Panamera 3.6 4	05/10→	M 46.40	V6cyl. 3605cc	220kW (299PS)		TD25180
Cayenne 4.8 GTS Cayenne 4.8 S	06/12→ 06/10→	M 48.02	V8cyl. 4806cc	294kW (400PS)		TD25178
Panamera 4.8 S	09/09→	M 48.20	V8cyl. 4806cc	294kW (400PS)		TD25181
Panamera 4.8 4S Panamera 4.8 GTS	09/09→ 01/12→	M 48.40	V8cyl. 4806cc	294kW (400PS)		TD25182

08-428200-00	STD	96.00	1.200		001 DLC	ST
			1.500		026 CR	KV1
			2.000		231 LKZ CR	KV1

911 (996) 3.4 Carrera, 911 (996) 3.4 Carrera 4 911 Convertible (996) 3.4 Carrera	09/97→09/01 02/98→09/01	M 96.01	B6cyl. 3387cc	221kW (300PS)	19	TD9460
911 Convertible (996) 3.4 Carrera 4	02/98→09/01	M 96.02	B6cyl. 3387cc	221kW (300PS)		TD17343
911 (996) 3.4 Carrera, 911 (996) 3.4 Carrera 4 911 Convertible (996) 3.4 Carrera, 911 Convertible (996) 3.4 Carrera 4	09/97→09/01 02/98→09/01	M 96.04	B6cyl. 3387cc	221kW (300PS)		TD17342

08-431400-00	STD	96.00	1.200		001 NT	ST
			1.500		005 IF P	F12/F14
			2.000		712 NT	ST



911 (996) 3.6 Carrera, 911 (996) 3.6 Carrera 4	10/01→08/05	M 96.03	B6cyl. 3596cc	235-239kW (320-325PS)	20
911 (996) 3.6 Carrera 4S, 911 (996) 3.6 Carrera S	02/03→08/05				
911 Convertible (996) 3.6 Carrera, 911 Convertible (996) 3.6 Carrera 4	10/01→08/05				
911 Convertible (996) 3.6 Carrera 4S, 911 Convertible (996) 3.6 Carrera S	06/02→08/05				
911 Targa (996) 3.6	12/01→08/05				TD17344

911 (997) 3.6 Carrera, 911 (997) 3.6 Carrera 4	07/04→	M 96.05	B6cyl. 3596cc	235-239kW (320-325PS)	
911 Convertible (997) 3.6 Carrera, 911 Convertible (997) 3.6 Carrera 4	04/05→				
911 Targa (997) 3.6 Carrera 4	07/06→				TD18566

08-428500-00 STD	96.00	1.200		001 NT	ST
		1.500		005 IF P	GOE13
		2.000		712 NT	ST

Boxster (987) S 3.4 Cayman (987) S 3.4	07/06→ 11/05→	M 97.21	B6cyl. 3387cc	217kW (295PS)	21
					TD23314

Boxster (987) S 3.4, Cayman (987) S 3.4 Sport	08/08→	M 97.22	B6cyl. 3387cc	223kW (304PS)	
					TD23322

08-441000-00 STD	96.00	1.200		001 NT	ST
		1.500		050 P	F12/F14
		2.000		712 NT	ST

911 3.3 SC Turbo 911 3.3 Turbo	09/77→06/87 09/86→11/90	930.60	B6cyl. 3299cc	221-243kW (300-330PS)	22
			Turbo Intercooled		TD2948

911 3.3 SC Turbo 911 3.3 Turbo 911 Convertible 3.3 Turbo 911 Targa 3.3 Turbo	09/77→06/87 06/86→08/89 09/86→08/89 09/86→11/90	930.66/68	B6cyl. 3299cc	210-221kW (282-300PS)	
			Turbo Intercooled		TD2949

911 (964) 3.3 Turbo	08/90→09/93	M 30.69	B6cyl. 3299cc	235-261kW (320-355PS)	
			Turbo Intercooled		TD2934

911 (964) 3.3 Turbo S	06/91→12/92	M 30.69S	B6cyl. 3299cc	235-261kW (320-355PS)	
			Turbo Intercooled		TD5406

08-320300-10 STD	97.00	1.500		005 IF P	IKA
		1.500		005 IF P	IKA
		3.500		232 P	STD



928 4.7 S		09/79→07/83	M 28.11	V8cyl. 4664cc	221kW (300PS)	23	TD2954
928 4.7 S		09/79→07/83	M 28.12	V8cyl. 4664cc	221kW (300PS)		TD2955
928 4.7 S			M 28.19	V8cyl. 4664cc	178-200kW (242-272PS)		TD2958
928 4.7 S		09/82→12/84	M 28.20	V8cyl. 4664cc	178-200kW (242-272PS)		TD2959
928 4.7 S		08/83→07/86	M 28.21	V8cyl. 4664cc	228kW (310PS)		TD2960
928 4.7 S		08/83→07/86	M 28.22	V8cyl. 4664cc	228kW (310PS)		TD2961
08-321200-00	STD	97.00	1.500	 005 IF P			IKA
			1.750	 026 P			IKA
			3.000	 712 CR			ST
928 5.4 GTS		08/91→11/95	M 28.49	V8cyl. 5397cc	257kW (350PS)	24	TD2970
928 5.4 GTS		08/91→11/95	M 28.50	V8cyl. 5397cc	257kW (350PS)		TD2971
924 2.5 S		08/87→07/88	M 44.09	4cyl. 2479cc	118kW (160PS)		TD2983
944 2.5		08/87→12/90					
924 2.5 S		08/87→07/88	M 44.10	4cyl. 2479cc	118kW (160PS)		TD2984
944 2.5		08/87→12/90					
944 2.5 S		08/86→07/88	M 44.40	4cyl. 2479cc	140kW (190PS)		TD2987
944 2.5 Turbo		08/85→07/88	M 44.50	4cyl. 2479cc	162kW (220PS) Turbo Intercooled		TD2991
944 2.5 Turbo		08/85→07/88	M 44.51	4cyl. 2479cc	162kW (220PS) Turbo Intercooled		TD2992





944 2.5 Turbo			09/87→07/91	M 44.52				
944 Convertible 2.5 Turbo			11/90→07/91		4cyl.	2479cc	184kW (250PS)	
								Turbo Intercooled
								TD2993
08-323300-00	STD	100.00	1.500		001 IF CR P			KV1
			1.750		005 P			STD
			3.000		231 CR P			KV1
924 2.5 S			10/81→12/84	M 44.01				
944 2.5			06/81→07/87		4cyl.	2479cc	120kW (163PS)	
								25
								TD2975
944 2.5			01/85→07/87	M 44.02				
					4cyl.	2479cc	110kW (150PS)	
								TD2976
924 2.5 S			10/81→12/84	M 44.03				
944 2.5			06/81→07/87		4cyl.	2479cc	120kW (163PS)	
								TD2977
944 2.5			01/85→07/87	M 44.04				
					4cyl.	2479cc	110kW (150PS)	
								TD2978
944 2.5			06/81→07/87	M 44.06				
					4cyl.	2479cc	120kW (163PS)	
								TD2980
924 2.5 S			09/85→07/87	M 44.07				
944 2.5			01/85→07/87		4cyl.	2479cc	110kW (150PS)	
								TD2981
924 2.5 S			09/85→07/87	M 44.08				
944 2.5			01/85→07/87		4cyl.	2479cc	110kW (150PS)	
								TD2982
08-320400-10	STD	100.00	1.500		005 P			IKA
			1.750		026 P			IKA
			3.000		712 CR			ST



944 2.5			06/81→12/90	M 44.05					26
					4cyl.				
					2479cc		118-120kW (160-163PS)		
									TD2979

08-320400-10 →07/1987	STD	100.00	1.500		005 P		IKA
			1.750		026 P		IKA
			3.000		712 CR		ST
08-323300-00 08/1987→	STD	100.00	1.500		001 IF CR P		KV1
			1.750		005 P		STD
			3.000		231 CR P		KV1

911 (964) 3.6 Carrera	07/89→09/93	M 64.01						27
911 (964) 3.6 Carrera 4	12/88→09/93				B6cyl.			
911 Convertible (964) 3.6 Carrera	07/89→05/94				3598cc		184kW (250PS)	
911 Convertible (964) 3.6 Carrera 4	05/89→05/94							
911 Speedster (964) 3.6 Carrera	08/92→06/94							
911 Targa (964) 3.6 Carrera,	12/88→09/93							
911 Targa (964) 3.6 Carrera 4								TD2935

911 (964) 3.6 Carrera	07/89→09/93	M 64.02						
911 Convertible (964) 3.6 Carrera	07/89→05/94				B6cyl.			
911 Speedster (964) 3.6 Carrera	08/92→06/94				3598cc		184kW (250PS)	
911 Targa (964) 3.6 Carrera	12/88→09/93							TD2936

911 (964) 3.6 Turbo	01/93→09/93	M 64.50						
					B6cyl.			
					3600cc		265kW (360PS)	
					Turbo Intercooled			TD5477

08-325100-00	STD	100.00	1.500		005 P		IKA
			1.750		026 P		IKA
			3.000		231 P		STD

911 (993) 3.6 Carrera	10/93→08/95	M 64.05						28
911 (993) 3.6 Carrera 4,	07/94→08/95				B6cyl.			
911 Convertible (993) 3.6 Carrera,					3600cc		200kW (272PS)	
911 Convertible (993) 3.6 Carrera 4								TD2938

911 (993) 3.6 Carrera	10/93→08/95	M 64.06						
911 Convertible (993) 3.6 Carrera	07/94→08/95				B6cyl.			
					3600cc		200kW (272PS)	
								TD2939

911 (993) 3.6 Carrera	10/93→08/95	M 64.07						
911 (993) 3.6 Carrera 4,	07/94→08/95				B6cyl.			
911 Convertible (993) 3.6 Carrera,					3600cc		200kW (272PS)	
911 Convertible (993) 3.6 Carrera 4								TD16161

911 (993) 3.6 Carrera	10/93→08/95	M 64.08						
911 Convertible (993) 3.6 Carrera	07/94→08/95				B6cyl.			
					3600cc		200kW (272PS)	
								TD16162

911 (993) 3.6 Carrera,	08/95→09/97	M 64.21						
911 (993) 3.6 Carrera 4,					B6cyl.			
911 Convertible (993) 3.6 Carrera,					3600cc		210kW (286PS)	
911 Convertible (993) 3.6 Carrera 4,								
911 Targa (993) 3.6 Carrera								TD5451





911 (993) 3.6 Carrera, 911 Convertible (993) 3.6 Carrera, 911 Targa (993) 3.6 Carrera			08/95→09/97	M 64.22	B6cyl. 3600cc	210kW (286PS)	TD5452
911 (993) 3.6 Carrera, 911 (993) 3.6 Carrera 4, 911 Convertible (993) 3.6 Carrera, 911 Convertible (993) 3.6 Carrera 4, 911 Targa (993) 3.6 Carrera			08/95→09/97	M 64.23	B6cyl. 3600cc	210kW (286PS)	TD16159
911 (993) 3.6 Carrera, 911 Convertible (993) 3.6 Carrera, 911 Targa (993) 3.6 Carrera			08/95→09/97	M 64.24	B6cyl. 3600cc	210kW (286PS)	TD16160
08-112500-00	STD	100.00	1.200		001 MO		ST
			1.750		026 P		GOE13
			2.000		236 P		KV1
08-326100-00	STD	100.00	1.500		005 P		IKA
			1.750		026 P		STD
			2.000		236 P		KV1
911 (993) 3.6 Turbo 4			03/95→09/97	M 64.60	B6cyl. 3598cc	264-300kW (359-408PS)	29
					Turbo Intercooled		TD5456
08-326200-00	STD	100.00	1.750		005 P		IKA
01/1995→			1.750		026 P		STD
			2.000		236		KV1
911 (996) 3.6 GT2 911 (996) 3.6 S 911 (996) 3.6 Turbo 4 911 (996) 3.6 Turbo 4S 911 Convertible (996) 3.6 S 911 Convertible (996) 3.6 Turbo 4, 911 Convertible (996) 3.6 Turbo 4S			04/01→08/05	M 96.70	B6cyl. 3600cc	309kW (420PS)	30
					Turbo Intercooled		TD16158
911 (997) 3.6 GT2 RS 911 (997) 3.6 Turbo 911 Convertible (997) 3.6 Turbo			05/10→	M 97.70	B6cyl. 3600cc	353kW (480PS)	TD21272
911 (997) 3.6 GT 2			09/07→	M 97.70S	B6cyl. 3600cc	390kW (530PS)	TD21273
08-425100-00	STD	100.00	1.200		005 NT		KV1
			1.750		026 P		F12/F14
			2.000		231 NT		F12/F14



911 (996) 3.6 GT3	03/99→08/05	M 96.76	B6cyl. 3598cc	265kW (360PS)	31
					TD13628

911 (996) 3.6 GT3	03/03→08/05	M 96.79	B6cyl. 3598cc	280kW (381PS)	32
					TD20764

08-115700-00	STD	100.00	1.200		005 NT	KV1
			1.750		026 P	IKA
			2.000		236 P	KV1

911 GT3R	01/00→	M 64	B6cyl. 3746cc Turbo	32	
					FM9032

08-125700-00	STD	102.00	1.200		001 MO P	KV1
			1.750		026 P	GOE13
			2.000		236 P	KV1

911 (993) 3.8 Carrera RS	06/95→09/97	M 64.20	B6cyl. 3746cc	221kW (300PS)	33
					TD4851

08-125700-00	STD	102.00	1.200		001 MO P	KV1
			1.750		026 P	GOE13
			2.000		236 P	KV1
08-325900-00	STD	102.00	1.500		005 P	IKA
			1.750		026 P	IKA
			3.000		232 P	STD



911 (997) 3.8 GT3	05/09→	M 97.77	B6cyl. 3797cc	331kW (450PS)	34
					TD24404

911 (997) 3.8 GT3 RS	08/09→	M 97.77R	B6cyl. 3797cc	331kW (450PS)	34
					TD25670

08-439200-00	STD	102.70	1.000		001 NT	ST
			1.200		050 P	F12/F14
			2.000		231 P	KV1



944 3.0 S2, 944 Convertible 3.0 S2	12/88→07/91	M 44.41	4cyl. 2990cc	155kW (211PS)	35	TD2988
968 3.0, 968 Convertible 3.0	06/91→11/95	M 44.43	4cyl. 2990cc	176kW (239PS)		TD2989
968 3.0, 968 Convertible 3.0	06/91→11/95	M 44.44	4cyl. 2990cc	176kW (239PS)		TD2990

08-324500-00	STD	104.00	1.750		001 IF CR P	KV1
			2.000		005 IF CR P	KV1
			3.000		231 CR P	STD



Aeroback Hatchback 1.5	01/91→09/93	4 G15				1
Jumbuck Pickup 1.5	05/02→		4cyl.			
Persona 400 415 GLi/GLSi,	01/94→		1468cc	64-66kW (86-90PS)		
Persona 400 Hatchback 415 GLi/GLSi						
Saga Hatchback 1.5 GLS 12V,	01/91→06/96					
Saga Saloon 1.5 GLE 12V						
Saloon Saloon 1.5	01/91→09/93					
Satria 1.5	04/96→					
Wira 1.5	08/00→				TD3003	
Persona 300 315 GLSi	09/96→	Mitsubishi G15B	4cyl.	1468cc	64-66kW (87-90PS)	

08-286700-00	STD	75.50	1.500		001 CR P	IKA
[R42150]			1.500		005 P	STD
			4.000		236 P	STD



1

D10TC Euro 2		6cyl.	10350cc	150kW (204PS)	Diesel	Turbo Intercooled	FM18540
D10UT 150 Euro 1		6cyl.	10350cc	150kW (204PS)	Diesel	Turbo Intercooled	FM8540
08-337600-00	STD	121.00	3.500		008 CK P		IKA
			2.000		005 NT		IKA
			3.500		231 CR P		STD

2

D2146		6cyl.	9659cc		Diesel		FM8539
08-274200-10	STD	121.00	3.500		001 CR P		IKA
08-274207-10	0.50mm		3.000		001 IF P		STD
			3.000		023 P		STD
			5.500		231 CR P		STD



Bond Bug 750E, Bond Bug 750ES Robin, Van 5cwt TW8	01/73→12/75 01/74→12/75	748	4cyl. 748cc	1
FM1473				

Rebel	01/73→12/75	748	4cyl. 748cc	FM2864
--------------	-------------	------------	-----------------------	---------------

Fox Utility, Kitten Deluxe, Rialto, Robin	01/75→	848	4cyl. 848cc	FM1474
--	--------	------------	-----------------------	---------------

08-523900-00	STD	62.50	1.270		001 P	GOE12
<i>[R27146]</i>			1.270		005 P	GOE12
			3.170		232 P	GOE12

Sabre 1400 Scimitar SS1 1400 Scimitar SST 1400	11/92→ 10/87→01/90 01/90→11/92	HL14G C.V.H.	4cyl. 1392cc CFi CVH	55kW (75PS)	2
FM3753					

08-781100-00	STD	77.24	1.600		001 IF MO P	IKA
08-781107-00	0.50mm		2.000		026 P	STD
08-781111-00	1.00mm		4.000		712 CR	ST
<i>[R42330]</i>						

Scimitar GTC, Scimitar GTE	01/80→12/86	TV28	V6cyl. 2792cc EFi	3
FM2457				

08-214700-00	STD	93.00	2.000		001 IF MO P	IKA
<i>[R31130K]</i>			2.500		026 P	STD
			4.000		712 CR	ST

Modelverzeichnis • Index de modele • Índice de Modelo
Indeks modelu • Модель автомобиля • دليل الموديل

MODEL INDEX



CCM

x



9

10/62→09/83	4 0.8	800	Petrol	847	4	1
09/71→12/88	4 0.8	800 01	Petrol	845	4	1
	4 0.8	800 05	Petrol	845	4	1
10/62→10/88	4 0.8	800 705	Petrol	845	4	1
10/83→10/88	4 0.8	B1B 707	Petrol	845	4	1
12/85→06/93	4 1.0	689 710	Petrol	956	4	2
06/87→06/93	4 1.0	C1C 708	Petrol	956	4	2
02/78→06/90	4 1.1	688 12	Petrol	1108	4	5
09/66→12/88	4 Box 0.8	800 01	Petrol	845	4	1
04/83→07/89	4 Box 0.8	800 705	Petrol	845	4	1
04/83→07/89	4 Box 0.8	B1B 707	Petrol	845	4	1
06/87→12/93	4 Box 1.0	C1C 708	Petrol	956	4	2
10/76→07/89	4 Box 1.1	688 11	Petrol	1108	4	5
10/76→07/89	4 Box 1.1	688 12	Petrol	1108	4	5
10/62→09/83	4 0.8	670.8	Petrol	845	4	1
10/72→12/84	5 0.8	800 710	Petrol	845	4	1
01/72→12/85	5 1.0	689 710	Petrol	956	4	2
09/80→12/85	5 1.1	688 13	Petrol	1108	4	5
06/79→09/84	5 1.3	810.19	Petrol	1289	4	8
09/75→09/84	5 1.3	810.25	Petrol	1289	4	8
09/76→09/79	5 1.3	810.26	Petrol	1289	4	8
09/76→09/79	5 1.3	810.96	Petrol	1289	4	8
09/76→09/79	5 1.3	810.97	Petrol	1289	4	8
06/79→09/84	5 1.3 Automatik	810.29	Petrol	1289	4	8
09/80→03/85	5 1.4	840 730	Petrol	1397	4	12
01/82→12/85	5 1.4	C2J 713	Petrol	1397	4	13
06/80→01/85	5 1.4 Turbo	840 730	Petrol	1397	4	12
10/72→08/84	5 Box 0.8	800 710	Petrol	845	4	1
01/72→12/85	5 Box 1.0	689 710	Petrol	956	4	2
09/80→12/85	5 Box 1.1	688 13	Petrol	1108	4	5
03/76→08/82	5 Box 1.3	810.26	Petrol	1289	4	8
03/76→08/82	5 Box 1.3	810.96	Petrol	1289	4	8
03/76→08/82	5 Box 1.3	810.97	Petrol	1289	4	8
08/89→07/98	5 D	S8U 742	Diesel	2499	4	50
08/89→07/98	5 TD	S9U 714	Diesel	2499	4	48
10/69→04/80	6 0.8	800.02	Petrol	845	4	1
08/70→04/87	6 1.1	688 10	Petrol	1108	4	5
11/62→10/72	8 1.1	C1E (688.01)	Petrol	1108	4	5
09/81→05/87	9 1.1	C1E 715	Petrol	1108	4	5
09/81→05/87	9 1.1	C1E 720	Petrol	1108	4	5
09/85→12/88	9 1.2	C1G 710	Petrol	1237	4	7
12/81→12/88	9 1.4	C1J 715	Petrol	1397	4	13
09/81→12/85	9 1.4	C2J 717	Petrol	1397	4	13
04/84→12/89	9 1.4 Turbo	C1J 760	Petrol	1397	4	12
04/84→12/89	9 1.4 Turbo	C1J 764	Petrol	1397	4	12
10/82→12/88	9 1.6 D	F8M 700	Diesel	1595	4	17
10/82→12/88	9 1.6 D	F8M 720	Diesel	1595	4	17
10/82→12/88	9 1.6 D	F8M 730	Diesel	1595	4	17
09/84→12/88	9 1.7	F2N 700	Petrol	1721	4	25
09/84→12/88	9 1.7	F2N 704	Petrol	1721	4	25
10/86→12/88	9 1.7	F2N 708	Petrol	1721	4	25
10/86→12/88	9 1.7	F2N 710	Petrol	1721	4	25
10/86→12/88	9 1.7	F2N 730	Petrol	1721	4	25
10/86→12/88	9 1.7	F2N 796	Petrol	1721	4	25
10/86→12/88	9 1.7	F2N 797	Petrol	1721	4	25
10/86→12/88	9 1.7	F2N 798	Petrol	1721	4	25
06/87→12/88	9 1.7	F3N 708	Petrol	1721	4	25
10/86→12/88	9 1.7	F3N 718	Petrol	1721	4	25
05/66→10/72	10 1.1	C1E (688.01)	Petrol	1108	4	5
07/69→10/72	10 1.3	810.03	Petrol	1289	4	8

MODEL INDEX

Modelverzeichnis • Index de modele • Índice de Modelo
Indeks modelu • Модель автомобиля • دليل الموديل



CCM

x



9

03/83→06/86	11 1.1	C1E 715	Petrol	1108	4	5
03/83→06/86	11 1.1	C1E 720	Petrol	1108	4	5
10/84→12/88	11 1.2	C1G 710	Petrol	1237	4	7
03/83→12/88	11 1.4	C1J 715	Petrol	1397	4	13
05/83→12/85	11 1.4	C2J 717	Petrol	1397	4	13
04/84→12/86	11 1.4 Turbo	C1J 760	Petrol	1397	4	12
02/84→12/86	11 1.4 Turbo	C1J 764	Petrol	1397	4	12
10/86→12/88	11 1.4 Turbo	C1J 770	Petrol	1397	4	12
10/86→12/88	11 1.4 Turbo	C1J 782	Petrol	1397	4	12
08/83→12/88	11 1.6 D	F8M 700	Diesel	1595	4	17
08/83→12/88	11 1.6 D	F8M 720	Diesel	1595	4	17
08/83→12/88	11 1.6 D	F8M 730	Diesel	1595	4	17
10/83→12/87	11 1.7	F2N 700	Petrol	1721	4	25
10/83→12/87	11 1.7	F2N 704	Petrol	1721	4	25
10/86→12/88	11 1.7	F2N 708	Petrol	1721	4	25
10/86→12/88	11 1.7	F2N 710	Petrol	1721	4	25
10/86→12/88	11 1.7	F2N 730	Petrol	1721	4	25
06/87→12/88	11 1.7	F2N 732	Petrol	1721	4	25
06/87→12/88	11 1.7	F2N 742	Petrol	1721	4	25
10/86→12/88	11 1.7	F2N 796	Petrol	1721	4	25
10/86→12/88	11 1.7	F2N 797	Petrol	1721	4	25
10/86→12/88	11 1.7	F2N 798	Petrol	1721	4	25
06/87→12/88	11 1.7	F3N 708	Petrol	1721	4	25
10/84→12/88	11 1.7	F3N 718	Petrol	1721	4	25
03/83→06/86	11 Box 1.1	C1E 715	Petrol	1108	4	5
03/83→06/86	11 Box 1.1	C1E 720	Petrol	1108	4	5
10/84→12/88	11 Box 1.2	C1G 710	Petrol	1237	4	7
03/83→09/86	11 Box 1.4	C1J 715	Petrol	1397	4	13
08/83→12/88	11 Box 1.6 D	F8M 700	Diesel	1595	4	17
08/83→12/88	11 Box 1.6 D	F8M 720	Diesel	1595	4	17
08/83→12/88	11 Box 1.6 D	F8M 730	Diesel	1595	4	17
07/75→04/80	12 1.3	810.02	Petrol	1289	4	8
10/69→08/80	12 1.3	810.02/97	Petrol	1289	4	8
08/72→08/80	12 1.3 TS	810.05	Petrol	1289	4	8
08/72→08/80	12 1.3 TS	810.06	Petrol	1289	4	8
08/70→12/74	12 1.6 Gordini	807 20	Petrol	1565	4	16
08/70→12/74	12 1.6 Gordini	821 20	Petrol	1565	4	16
07/75→04/80	12 Box 1.3	810.02	Petrol	1289	4	8
07/75→04/80	12 Variable 1.3	810.02	Petrol	1289	4	8
10/70→08/80	12 Variable 1.3	810.02/97	Petrol	1289	4	8
08/73→08/80	12 Variable 1.3	810.05	Petrol	1289	4	8
08/73→08/80	12 Variable 1.3	810.06	Petrol	1289	4	8
08/70→07/75	12 Variable 1.6	821 20	Petrol	1565	4	16
05/76→12/83	14 1.2	129	Petrol	1218	4	10
09/79→06/83	14 1.4	150	Petrol	1360	4	10
12/81→12/83	14 1.4	X5J	Petrol	1360	4	10
03/72→10/80	15 1.3	810.05	Petrol	1289	4	8
01/71→08/80	16 1.6 TL	821	Petrol	1565	4	16
01/71→08/80	16 1.6 TL	821.03	Petrol	1565	4	16
01/71→08/80	16 1.6 TL	821.04	Petrol	1565	4	16
09/68→08/80	16 1.6 TS	807	Petrol	1565	4	16
09/68→08/80	16 1.6 TS	807 03	Petrol	1565	4	16
09/68→08/80	16 1.6 TS	807.04	Petrol	1565	4	16
09/68→08/80	16 1.6 TS	807.05	Petrol	1565	4	16
06/74→08/80	16 1.6 TX	843	Petrol	1647	4	18
06/74→08/80	16 1.6 TX	843.01	Petrol	1647	4	18
06/74→08/79	17 1.6	843.05	Petrol	1647	4	18
04/78→07/86	18 1.4	847 720	Petrol	1397	4	13
04/82→07/86	18 1.6	841 717	Petrol	1647	4	18
04/78→09/82	18 1.6	841.25	Petrol	1647	4	18

Modelverzeichnis • Index de modele • Índice de Modelo
Indeks modelu • Модель автомобиля • دليل الموديل

MODEL INDEX



CCM

x



9

04/78→09/82	18 1.6	841.26	Petrol	1647	4	18
04/82→11/93	18 1.6	A2M 723	Petrol	1647	4	18
10/80→09/82	18 1.6 Turbo	807 727	Petrol	1565	4	16
05/82→07/86	18 2.0	J6R 716	Petrol	1995	4	40
03/86→03/92	18 2.1	J8S 234	Diesel	2068	4	33
11/81→07/86	18 2.1 Diesel	852 710	Diesel	2068	4	32
03/86→03/92	18 2.1 TD	J8S 120	Diesel	2068	4	33
11/81→07/86	18 2.1 TD	J8S 712	Diesel	2068	4	34
	18 2.1 TD	J8S 852	Diesel	2068	4	34
05/79→07/86	18 Box 1.4	847 720	Petrol	1397	4	13
11/81→07/86	18 Box 2.1 Diesel	852 710	Diesel	2068	4	32
05/79→07/86	18 Variable 1.4	847 720	Petrol	1397	4	13
01/82→07/86	18 Variable 1.6	841 717	Petrol	1647	4	18
05/79→09/82	18 Variable 1.6	841.25	Petrol	1647	4	18
05/79→09/82	18 Variable 1.6	841.26	Petrol	1647	4	18
01/82→11/93	18 Variable 1.6	A2M 723	Petrol	1647	4	18
01/83→07/86	18 Variable 1.6 4x4	841 717	Petrol	1647	4	18
02/79→06/81	18 Variable 1.6 4x4	841.25	Petrol	1647	4	18
01/83→07/86	18 Variable 1.6 4x4	A2M 723	Petrol	1647	4	18
09/82→07/86	18 Variable 1.6 Turbo	807 727	Petrol	1565	4	16
10/81→07/86	18 Variable 2.0	J6R 716	Petrol	1995	4	40
05/83→12/86	18 Variable 2.0 4x4	J6R 716	Petrol	1995	4	40
11/80→07/86	18 Variable 2.1 Diesel	852 710	Diesel	2068	4	32
05/92→12/01	19 1.9 D	F8Q 764	Diesel	1870	4	21
01/88→12/92	19 I 1.2	C1G 730	Petrol	1237	4	7
01/89→12/89	19 I 1.4	C2J 772	Petrol	1397	4	13
01/89→04/92	19 I 1.4	C3J 710	Petrol	1397	4	13
01/88→12/92	19 I 1.4	E6J 700	Petrol	1390	4	11
01/88→12/92	19 I 1.4	E6J 701	Petrol	1390	4	11
	19 I 1.7	F2N 726	Petrol	1721	4	25
	19 I 1.7	F2N 728	Petrol	1721	4	25
09/88→04/92	19 I 1.7	F3N 740	Petrol	1721	4	25
09/88→04/92	19 I 1.7	F3N 741	Petrol	1721	4	25
09/88→04/92	19 I 1.7	F3N 742	Petrol	1721	4	25
09/88→04/92	19 I 1.7	F3N 743	Petrol	1721	4	25
06/89→04/92	19 I 1.8 16V	F7P 704	Petrol	1763	4	26
09/88→04/92	19 I 1.9 D	F8Q 706	Diesel	1870	4	21
09/88→04/92	19 I 1.9 D	F8Q 742	Diesel	1870	4	21
09/90→04/92	19 I 1.9 DT	F8Q 610	Diesel	1870	4	22
01/88→12/92	19 I Box 1.2	C1G 730	Petrol	1237	4	7
01/88→12/92	19 I Box 1.4	E6J 700	Petrol	1390	4	11
01/88→12/92	19 I Box 1.9 D	F8Q 706	Diesel	1870	4	21
01/88→12/92	19 I Box 1.9 D	F8Q 742	Diesel	1870	4	21
07/91→04/92	19 I Cabriolet 1.7	F2N 724	Petrol	1721	4	25
07/91→04/92	19 I Cabriolet 1.7	F3N 742	Petrol	1721	4	25
07/91→04/92	19 I Cabriolet 1.7	F3N 743	Petrol	1721	4	25
07/91→04/92	19 I Cabriolet 1.8 16V	F7P 704	Petrol	1763	4	26
01/88→12/92	19 I Chamade 1.2	C1G 730	Petrol	1237	4	7
07/88→04/92	19 I Chamade 1.4	C2J 772	Petrol	1397	4	13
07/88→04/92	19 I Chamade 1.4	C3J 710	Petrol	1397	4	13
07/88→08/90	19 I Chamade 1.4	E6J 700	Petrol	1390	4	11
07/88→08/90	19 I Chamade 1.4	E6J 701	Petrol	1390	4	11
09/88→12/92	19 I Chamade 1.7	F2N 720	Petrol	1721	4	25
09/88→12/92	19 I Chamade 1.7	F2N 721	Petrol	1721	4	25
09/88→12/92	19 I Chamade 1.7	F2N 722	Petrol	1721	4	25
	19 I Chamade 1.7	F2N 727	Petrol	1721	4	25
10/89→04/92	19 I Chamade 1.7	F3N 740	Petrol	1721	4	25
10/89→04/92	19 I Chamade 1.7	F3N 741	Petrol	1721	4	25
07/88→04/92	19 I Chamade 1.7	F3N 742	Petrol	1721	4	25
07/88→04/92	19 I Chamade 1.7	F3N 743	Petrol	1721	4	25

MODEL INDEX

Modelverzeichnis • Index de modele • Índice de Modelo
 Indeks modelu • Модель автомобиля • دليل الموديل

CCM
x

9

08/88→12/92	19 I Chamade 1.7	F3N 746	Petrol	1721	4	25
06/89→08/90	19 I Chamade 1.8 16V	F7P 700	Petrol	1763	4	26
10/89→04/92	19 I Chamade 1.8 16V	F7P 704	Petrol	1763	4	26
10/89→04/92	19 I Chamade 1.9 D	F8Q 706	Diesel	1870	4	21
10/89→04/92	19 I Chamade 1.9 D	F8Q 742	Diesel	1870	4	21
09/90→04/92	19 I Chamade 1.9 TD	F8Q 740	Diesel	1870	4	22
04/92→12/95	19 II 1.2	C1G 730	Petrol	1237	4	7
05/92→09/94	19 II 1.2	E7F 730	Petrol	1171	4	11
04/92→12/95	19 II 1.4	C3J 710	Petrol	1397	4	13
01/92→12/95	19 II 1.4	E6J 700	Petrol	1390	4	11
10/96→06/01	19 II 1.4	E6J 706	Petrol	1390	4	11
01/92→12/95	19 II 1.4	E7J 742	Petrol	1390	4	11
04/92→12/95	19 II 1.7	F3N 740	Petrol	1721	4	25
04/92→12/95	19 II 1.7	F3N 741	Petrol	1721	4	25
04/92→12/95	19 II 1.7	F3N 743	Petrol	1721	4	25
05/92→09/94	19 II 1.7	F3N 746	Petrol	1721	4	25
04/92→12/95	19 II 1.8 16V	F7P 704	Petrol	1763	4	26
04/92→12/95	19 II 1.9 D	F8Q 742	Diesel	1870	4	21
04/92→12/95	19 II 1.9 dT	F8Q 744	Diesel	1870	4	22
03/92→12/95	19 II Box 1.2	C1G 730	Petrol	1237	4	7
03/92→12/95	19 II Box 1.4	E6J 700	Petrol	1390	4	11
03/92→12/95	19 II Box 1.9 D	F8Q 706	Diesel	1870	4	21
03/92→12/95	19 II Box 1.9 D	F8Q 742	Diesel	1870	4	21
03/92→12/95	19 II Box 1.9 dT	F8Q 740	Diesel	1870	4	22
04/92→09/93	19 II Cabriolet 1.7	F3N 742	Petrol	1721	4	25
04/92→09/93	19 II Cabriolet 1.7	F3N 743	Petrol	1721	4	25
04/92→06/96	19 II Cabriolet 1.8 16V	F7P 704	Petrol	1763	4	26
05/92→09/94	19 II Chamade 1.4	C1J 742	Petrol	1397	4	13
05/92→09/94	19 II Chamade 1.4	C2J 772	Petrol	1397	4	13
04/92→12/95	19 II Chamade 1.4	C3J 710	Petrol	1397	4	13
10/94→11/95	19 II Chamade 1.4	E6J 700	Petrol	1390	4	11
11/93→12/95	19 II Chamade 1.4	E7J 742	Petrol	1390	4	11
01/93→08/95	19 II Chamade 1.7	F2N 720	Petrol	1721	4	25
01/93→08/95	19 II Chamade 1.7	F2N 721	Petrol	1721	4	25
01/93→08/95	19 II Chamade 1.7	F2N 722	Petrol	1721	4	25
04/92→12/95	19 II Chamade 1.7	F3N 740	Petrol	1721	4	25
04/92→12/95	19 II Chamade 1.7	F3N 741	Petrol	1721	4	25
04/92→12/95	19 II Chamade 1.7	F3N 742	Petrol	1721	4	25
04/92→12/95	19 II Chamade 1.7	F3N 743	Petrol	1721	4	25
04/92→12/95	19 II Chamade 1.8 16V	F7P 704	Petrol	1763	4	26
04/92→12/95	19 II Chamade 1.9 D	F8Q 742	Diesel	1870	4	21
05/92→11/95	19 II Chamade 1.9 D	F8Q 744	Diesel	1870	4	22
04/92→12/95	19 II Chamade 1.9 dT	F8Q 744	Diesel	1870	4	22
10/75→05/77	20 1.6	843	Petrol	1647	4	18
10/77→10/80	20 2.0	829.01	Petrol	1995	4	40
10/80→12/83	20 2.1 Diesel	852	Diesel	2068	4	32
01/82→12/83	20 2.1 TD	J8S 702	Diesel	2068	4	33
10/80→12/83	20 2.2	851 700	Petrol	2165	4	40
07/89→05/93	21 1.7	F2N 711	Petrol	1721	4	25
07/89→05/93	21 1.7	F2N 712	Petrol	1721	4	25
07/89→05/93	21 1.7	F2N 716	Petrol	1721	4	25
07/89→05/93	21 1.7	F2N 753	Petrol	1721	4	25
07/89→05/93	21 1.7	F2N 754	Petrol	1721	4	25
07/89→05/93	21 1.7	F2N 758	Petrol	1721	4	25
07/89→05/93	21 1.7	F2N 786	Petrol	1721	4	25
09/89→06/94	21 1.7	F3N 722	Petrol	1721	4	25
09/89→06/94	21 1.7	F3N 723	Petrol	1721	4	25
07/89→05/93	21 1.7	F3N 726	Petrol	1721	4	25
09/89→01/94	21 1.9 D	F8Q 710	Diesel	1870	4	21
02/90→10/92	21 2.0	J7R 740	Petrol	1995	4	40

Modelverzeichnis • Index de modele • Índice de Modelo
Indeks modelu • Модель автомобиля • دليل الموديل

MODEL INDEX



CCM

x



9

09/89→12/93	21 2.0	J7R 746	Petrol	1995	4	40
09/89→12/93	21 2.0	J7R 747	Petrol	1995	4	40
07/89→06/92	21 2.0	J7R 751	Petrol	1995	4	40
09/90→10/92	21 2.0 4x4	J7R 740	Petrol	1995	4	40
07/89→05/93	21 2.0 TXi	J7R 740	Petrol	1995	4	40
09/89→12/92	21 2.1 D	J8S 600	Diesel	2068	4	34
07/89→05/93	21 2.1 D	J8S 704	Diesel	2068	4	34
09/89→12/92	21 2.1 D	J8S 740	Diesel	2068	4	34
07/89→06/94	21 2.1 D	J8S 784	Diesel	2068	4	34
07/86→03/93	21 2.1 TD	J8S 742	Diesel	2068	4	33
07/86→03/93	21 2.1 TD	J8S 746	Diesel	2068	4	33
09/89→06/94	21 2.1 Turbo-D	J8S 714	Diesel	2068	4	33
09/89→06/94	21 2.1 Turbo-D	J8S 786 (KAT)	Diesel	2068	4	33
09/89→06/94	21 2.1 Turbo-D	J8S 788	Diesel	2068	4	33
09/89→06/94	21 2.2	J7T 754	Petrol	2165	4	40
07/89→06/94	21 2.2	J7T 755	Petrol	2165	4	40
07/90→06/94	21 2.2 4x4	J7T 754	Petrol	2165	4	40
07/90→06/94	21 2.2 4x4	J7T 755	Petrol	2165	4	40
06/86→04/95	21 Box 1.7	F2N 710	Petrol	1721	4	25
06/86→08/94	21 Box 1.9 D	F8Q 710	Diesel	1870	4	21
06/86→08/94	21 Box 2.1 D	J8S 704	Diesel	2068	4	34
10/86→12/88	21 Estate 1.7	F2N 710	Petrol	1721	4	25
06/86→03/93	21 Estate 1.7	F2N 712	Petrol	1721	4	25
06/86→03/93	21 Estate 1.7	F2N 716	Petrol	1721	4	25
06/86→12/89	21 Estate 1.7	F2N 750	Petrol	1721	4	25
06/87→04/89	21 Estate 1.7	F2N 752	Petrol	1721	4	25
06/86→12/93	21 Estate 1.7	F3N 722	Petrol	1721	4	25
06/86→12/93	21 Estate 1.7	F3N 723	Petrol	1721	4	25
05/88→06/93	21 Estate 1.7	F3N 726	Petrol	1721	4	25
03/86→08/94	21 Estate 1.9 D	F8Q 710	Diesel	1870	4	21
06/91→05/93	21 Estate 2.0	J6R 758	Petrol	1995	4	40
06/91→05/93	21 Estate 2.0	J6R 759	Petrol	1995	4	40
06/91→05/93	21 Estate 2.0	J6R 792	Petrol	1995	4	40
06/90→02/94	21 Estate 2.0	J7R 740	Petrol	1995	4	40
03/86→12/93	21 Estate 2.0	J7R 746	Petrol	1995	4	40
03/86→12/93	21 Estate 2.0	J7R 747	Petrol	1995	4	40
06/86→06/92	21 Estate 2.0	J7R 751	Petrol	1995	4	40
03/89→12/93	21 Estate 2.0 4x4	J7R 746	Petrol	1995	4	40
03/89→12/93	21 Estate 2.0 4x4	J7R 747	Petrol	1995	4	40
08/89→12/92	21 Estate 2.1 D	J8S 600	Diesel	2068	4	34
10/86→09/90	21 Estate 2.1 D	J8S 704	Diesel	2068	4	34
08/89→12/92	21 Estate 2.1 D	J8S 740	Diesel	2068	4	34
02/92→09/95	21 Estate 2.1 D	J8S 784	Diesel	2068	4	34
10/88→05/92	21 Estate 2.1 D 4x4	J8S 704	Diesel	2068	4	34
10/86→11/93	21 Estate 2.1 Turbo-D	J8S 714	Diesel	2068	4	33
10/86→11/93	21 Estate 2.1 Turbo-D	J8S 786 (KAT)	Diesel	2068	4	33
10/86→11/93	21 Estate 2.1 Turbo-D	J8S 788	Diesel	2068	4	33
06/86→11/93	21 Estate 2.2	J7T 754	Petrol	2165	4	40
06/86→11/93	21 Estate 2.2	J7T 755	Petrol	2165	4	40
06/86→12/93	21 Estate 2.2 4x4	J7T 754	Petrol	2165	4	40
06/86→12/93	21 Estate 2.2 4x4	J7T 755	Petrol	2165	4	40
03/86→03/93	21 Saloon 1.7	F2N 710	Petrol	1721	4	25
03/86→12/87	21 Saloon 1.7	F2N 712	Petrol	1721	4	25
03/86→12/87	21 Saloon 1.7	F2N 716	Petrol	1721	4	25
07/86→02/94	21 Saloon 1.7	F2N 750	Petrol	1721	4	25
06/87→04/89	21 Saloon 1.7	F2N 752	Petrol	1721	4	25
03/86→02/94	21 Saloon 1.7	F3N 722	Petrol	1721	4	25
03/86→02/94	21 Saloon 1.7	F3N 723	Petrol	1721	4	25
07/86→02/94	21 Saloon 1.7	F3N 726	Petrol	1721	4	25
08/89→10/93	21 Saloon 1.9 D	F8Q 710	Diesel	1870	4	21

MODEL INDEX

Modelverzeichnis • Index de modele • Índice de Modelo
Indeks modelu • Модель автомобиля • دليل الموديل



CCM

x



9

03/86→10/93	21 Saloon 2.0	J6R 758	Petrol	1995	4	40
03/86→10/93	21 Saloon 2.0	J6R 759	Petrol	1995	4	40
03/86→10/93	21 Saloon 2.0	J6R 792	Petrol	1995	4	40
03/86→10/93	21 Saloon 2.0	J6R 793	Petrol	1995	4	40
02/90→06/94	21 Saloon 2.0	J7R 740	Petrol	1995	4	40
03/86→12/93	21 Saloon 2.0	J7R 746	Petrol	1995	4	40
03/86→12/93	21 Saloon 2.0	J7R 747	Petrol	1995	4	40
03/86→06/89	21 Saloon 2.0	J7R 751	Petrol	1995	4	40
12/89→02/94	21 Saloon 2.0 4x4	J7R 740	Petrol	1995	4	40
04/87→03/90	21 Saloon 2.0 Turbo	J7R 752	Petrol	1995	4	40
02/90→10/92	21 Saloon 2.0 Turbo	J7R 756	Petrol	1995	4	41
08/89→10/93	21 Saloon 2.0 Turbo 4x4	J7R 752	Petrol	1995	4	40
02/90→10/92	21 Saloon 2.0 Turbo 4x4	J7R 756	Petrol	1995	4	41
05/89→06/94	21 Saloon 2.1 D	J8S 600	Diesel	2068	4	34
03/86→12/89	21 Saloon 2.1 D	J8S 704	Diesel	2068	4	34
05/89→06/94	21 Saloon 2.1 D	J8S 740	Diesel	2068	4	34
10/92→06/94	21 Saloon 2.1 D	J8S 784	Diesel	2068	4	34
04/86→06/89	21 Saloon 2.1 TD	J8S 704	Diesel	2068	4	34
03/86→06/94	21 Saloon 2.1 Turbo-D	J8S 714	Diesel	2068	4	33
03/86→06/94	21 Saloon 2.1 Turbo-D	J8S 786 (KAT)	Diesel	2068	4	33
03/86→06/94	21 Saloon 2.1 Turbo-D	J8S 788	Diesel	2068	4	33
07/86→02/94	21 Saloon 2.2	J7T 754	Petrol	2165	4	40
04/86→02/94	21 Saloon 2.2	J7T 755	Petrol	2165	4	40
07/90→02/94	21 Saloon 2.2 4x4	J7T 754	Petrol	2165	4	40
07/90→02/94	21 Saloon 2.2 4x4	J7T 755	Petrol	2165	4	40
04/84→12/92	25 2.0	J6R 706	Petrol	1995	4	40
04/84→12/92	25 2.0	J6R 707	Petrol	1995	4	40
04/84→12/92	25 2.0	J6R 760	Petrol	1995	4	40
04/84→12/92	25 2.0	J6R 762	Petrol	1995	4	40
03/87→12/93	25 2.0	J7R 722	Petrol	1995	4	40
03/87→12/93	25 2.0	J7R 723	Petrol	1995	4	40
04/84→05/89	25 2.1 Diesel	J8S 706	Diesel	2068	4	34
06/89→12/92	25 2.1 Diesel	J8S 736	Diesel	2068	4	34
04/84→12/92	25 2.1 Turbo-D	J8S 708	Diesel	2068	4	33
04/84→12/92	25 2.1 Turbo-D	J8S 738	Diesel	2068	4	33
04/84→12/89	25 2.2	J7T 706	Petrol	2165	4	40
04/84→12/89	25 2.2	J7T 714	Petrol	2165	4	40
04/84→12/89	25 2.2	J7T 715	Petrol	2165	4	40
04/84→12/89	25 2.2	J7T 730	Petrol	2165	4	40
04/84→12/89	25 2.2	J7T 731	Petrol	2165	4	40
09/86→12/92	25 2.2	J7T 732	Petrol	2165	4	40
09/86→12/92	25 2.2	J7T 733	Petrol	2165	4	40
10/84→05/90	25 2.4 V6 Turbo	Z7U 702	Petrol	2458	6	44
01/90→12/92	25 2.5 V6 Turbo	Z7U 700	Petrol	2458	6	44
04/84→08/89	25 2.7 V6 Injection	Z7V 708	Petrol	2664	6	39
04/84→08/89	25 2.7 V6 Injection	Z7V 709	Petrol	2664	6	39
04/84→08/89	25 2.7 V6 Injection	Z7V 711	Petrol	2664	6	39
06/87→02/90	25 2.8 V6	Z7W 700	Petrol	2849	6	45
06/86→02/88	25 2.8 V6 Injection	Z7W 702	Petrol	2849	6	45
06/87→12/92	25 2.8 V6 Injection	Z7W 706	Petrol	2849	6	45
06/87→12/92	25 2.8 V6 Injection	Z7W 707	Petrol	2849	6	45
02/82→03/86	30 2.1 Turbo-D	J8S 702	Diesel	2068	4	33
02/75→08/78	30 2.6	112	Petrol	2664	6	39
05/02→05/03	Avantime 2.2 dCi	G9T 712	Diesel	2188	4	37
04/86→09/90	B Box Body / Estate 90	8140.21.235 IDS	Diesel	2445	4	47
04/86→09/90	B Platform/Chassis 90	8140.21.235 IDS	Diesel	2445	4	47



CCM

x



08/02→	Clio Grandtour 1.2 16V	D4F 740	Petrol	1149	4	3
08/02→	Clio Grandtour 1.2 16V	D4F 764	Petrol	1149	4	3
08/07→	Clio Grandtour 1.2 16V Hi-Flex	D4F 740	Petrol	1149	4	3
02/10→	Clio Grandtour 1.4 16V	K4J 780	Petrol	1390	4	19
02/08→	Clio Grandtour 1.5 dCi	K9K 714 Euro 4	Diesel	1461	4	15
02/10→	Clio Grandtour 1.5 dCi	K9K 752 Euro 3	Diesel	1461	4	15
02/08→	Clio Grandtour 1.5 dCi	K9K 764 Euro 4	Diesel	1461	4	14
02/08→	Clio Grandtour 1.5 dCi	K9K 766 Euro 4	Diesel	1461	4	15
02/08→	Clio Grandtour 1.5 dCi	K9K 768 Euro 4	Diesel	1461	4	15
08/10→	Clio Grandtour 1.5 dCi	K9K 770	Diesel	1461	4	14
02/08→	Clio Grandtour 1.5 dCi	K9K 772	Diesel	1461	4	14
13/01→	Clio Grandtour IV 1.2 16V	D4F 740	Petrol	1149	4	3
01/13→	Clio Grandtour IV 1.5 dCi 75	K9K 612	Diesel	1461	4	14
01/13→	Clio Grandtour IV 1.5 dCi 90	K9K 608	Diesel	1461	4	14
01/91→09/98	Clio I 1.1	C1E 700	Petrol	1108	4	5
01/96→12/96	Clio I 1.2	C3G 720	Petrol	1239	4	9
01/96→12/96	Clio I 1.2	C3G 750	Petrol	1239	4	9
01/96→09/98	Clio I 1.2	D7F 730	Petrol	1149	4	4
05/90→03/96	Clio I 1.2	E5F 710	Petrol	1171	4	11
05/90→09/98	Clio I 1.2	E7F 700	Petrol	1171	4	11
05/90→09/98	Clio I 1.2	E7F 704	Petrol	1171	4	11
01/91→06/96	Clio I 1.2	E7F 706	Petrol	1171	4	11
05/90→09/98	Clio I 1.2	E7F 708	Petrol	1171	4	11
05/90→09/98	Clio I 1.2	E7F 750	Petrol	1171	4	11
05/90→02/98	Clio I 1.4	E6J 712	Petrol	1390	4	11
05/90→02/98	Clio I 1.4	E6J 713	Petrol	1390	4	11
05/90→02/98	Clio I 1.4	E6J 718	Petrol	1390	4	11
	Clio I 1.4	E6J 738	Petrol	1390	4	11
05/90→02/98	Clio I 1.4	E6J 760	Petrol	1390	4	11
01/91→09/98	Clio I 1.4	E7J 718	Petrol	1390	4	11
01/91→09/98	Clio I 1.4	E7J 719	Petrol	1390	4	11
01/91→09/98	Clio I 1.4	E7J 754	Petrol	1390	4	11
01/91→12/93	Clio I 1.7	F2N 770	Petrol	1721	4	25
01/91→09/98	Clio I 1.8	F3P 710	Petrol	1794	4	27
01/91→09/98	Clio I 1.8	F3P 714	Petrol	1794	4	27
08/94→09/98	Clio I 1.8	F3P 754	Petrol	1794	4	27
08/90→09/98	Clio I 1.8	F3P 755	Petrol	1794	4	27
	Clio I 1.8 16V	F7P 720	Petrol	1763	4	26
01/91→03/96	Clio I 1.8 16V	F7P 722	Petrol	1763	4	26
01/93→08/95	Clio I 1.8 Rsi	F3P 712	Petrol	1794	4	27
08/95→09/98	Clio I 1.8 Rsi	F3P 758	Petrol	1794	4	27
05/96→02/98	Clio I 1.9 D	F8Q 676	Diesel	1870	4	21
01/97→09/98	Clio I 1.9 D	F8Q 678	Diesel	1870	4	21
05/96→02/98	Clio I 1.9 D	F8Q 696	Diesel	1870	4	21
01/91→09/98	Clio I 1.9 D	F8Q 714	Diesel	1870	4	21
01/91→09/98	Clio I 1.9 D	F8Q 730	Diesel	1870	4	21
01/91→09/98	Clio I 1.9 D	F8Q 732	Diesel	1870	4	21
01/91→09/98	Clio I Box 1.1	C1E 700	Petrol	1108	4	5
06/94→02/98	Clio I Box 1.2	C3G 720	Petrol	1239	4	9
06/94→02/98	Clio I Box 1.2	C3G 750	Petrol	1239	4	9
	Clio I Box 1.2	E5F 716	Petrol	1171	4	11
01/91→09/98	Clio I Box 1.2	E7F 706	Petrol	1171	4	11
01/91→09/98	Clio I Box 1.2	E7F 750	Petrol	1171	4	11
01/91→09/98	Clio I Box 1.9 D	F8Q 714	Diesel	1870	4	21
01/91→09/98	Clio I Box 1.9 D	F8Q 730	Diesel	1870	4	21
01/91→09/98	Clio I Box 1.9 D	F8Q 732	Diesel	1870	4	21
04/96→02/98	Clio I Box 1.9 RND	F8Q 678	Diesel	1870	4	21

MODEL INDEX

Modelverzeichnis • Index de modele • Índice de Modelo
 Indeks modelu • Модель автомобиля • دليل الموديل

CCM
x

9

01/94→09/98	Clio I Williams	F7R 700	Petrol	1998	4	28
09/98→	Clio II 1.2	D7F 720	Petrol	1149	4	4
03/99→05/01	Clio II 1.2	D7F 722	Petrol	1149	4	4
09/98→	Clio II 1.2	D7F 726	Petrol	1149	4	4
09/98→	Clio II 1.2	D7F 746	Petrol	1149	4	4
09/98→	Clio II 1.2	D7F 764	Petrol	1149	4	4
09/98→	Clio II 1.2	D7F 766 Euro 4	Petrol	1149	4	4
01/06→	Clio II 1.2 16V	D4F 706	Petrol	1149	4	3
06/06→	Clio II 1.2 16V	D4F 706	Petrol	1149	4	3
01/06→	Clio II 1.2 16V	D4F 712	Petrol	1149	4	3
06/06→	Clio II 1.2 16V	D4F 712	Petrol	1149	4	3
01/06→	Clio II 1.2 16V	D4F 714	Petrol	1149	4	3
01/06→	Clio II 1.2 16V	D4F 722	Petrol	1149	4	3
01/06→	Clio II 1.2 16V	D4F 728	Petrol	1149	4	3
09/98→06/09	Clio II 1.2 LPG	D7F 764	Petrol	1149	4	4
09/98→06/09	Clio II 1.2 LPG	D7F 766 Euro 4	Petrol	1149	4	4
09/98→05/05	Clio II 1.4	E7J 780	Petrol	1390	4	11
08/00→	Clio II 1.4 16V	K4J 700	Petrol	1390	4	19
08/00→	Clio II 1.4 16V	K4J 710 Euro 4	Petrol	1390	4	19
08/00→	Clio II 1.4 16V	K4J 711 Euro 4	Petrol	1390	4	19
10/99→	Clio II 1.4 16V	K4J 712	Petrol	1390	4	19
10/99→	Clio II 1.4 16V	K4J 713	Petrol	1390	4	19
05/00→10/07	Clio II 1.4i	K4J 715	Petrol	1390	4	19
06/01→	Clio II 1.5 dCi	K9K 700 Euro 3	Diesel	1461	4	15
06/01→	Clio II 1.5 dCi	K9K 702 Euro 3	Diesel	1461	4	15
06/01→	Clio II 1.5 dCi	K9K 704 Euro 3	Diesel	1461	4	15
06/01→	Clio II 1.5 dCi	K9K 706	Diesel	1461	4	15
06/01→	Clio II 1.5 dCi	K9K 708	Diesel	1461	4	15
01/04→	Clio II 1.5 dCi	K9K 712 Euro 3	Diesel	1461	4	15
08/04→	Clio II 1.5 dCi	K9K 714 Euro 4	Diesel	1461	4	15
02/07→	Clio II 1.5 dCi	K9K 718 Euro 4	Diesel	1461	4	15
06/05→	Clio II 1.5 dCi	K9K 740 Euro 4	Diesel	1461	4	15
09/98→05/05	Clio II 1.6	K7M 744	Petrol	1598	4	20
09/98→05/05	Clio II 1.6	K7M 745	Petrol	1598	4	20
09/98→	Clio II 1.6 16V	K4M 708	Petrol	1598	4	19
09/98→	Clio II 1.6 16V	K4M 740	Petrol	1598	4	19
09/98→	Clio II 1.6 16V	K4M 742	Petrol	1598	4	19
09/98→	Clio II 1.6 16V	K4M 743	Petrol	1598	4	19
09/98→	Clio II 1.6 16V	K4M 744 Euro 4	Petrol	1598	4	19
09/98→	Clio II 1.6 16V	K4M 745	Petrol	1598	4	19
09/98→	Clio II 1.6 16V	K4M 748	Petrol	1598	4	19
01/05→02/10	Clio II 1.6 Hi-Flex	K4M 748	Petrol	1598	4	19
11/01→	Clio II 1.6i	K4M 732	Petrol	1598	4	19
11/01→	Clio II 1.6i	K4M 734	Petrol	1598	4	19
11/01→	Clio II 1.6i	K4M 736	Petrol	1598	4	19
09/98→05/05	Clio II 1.9 D	F8Q 630	Diesel	1870	4	21
02/00→05/01	Clio II 1.9 D	F8Q 632	Diesel	1870	4	21
02/00→05/01	Clio II 1.9 D	F8Q 636	Diesel	1870	4	21
12/99→05/05	Clio II 1.9 dTi	F9Q 780	Diesel	1870	4	24
09/98→	Clio II Box 1.1	D7F 720	Petrol	1149	4	4
09/98→	Clio II Box 1.1	D7F 726	Petrol	1149	4	4
09/98→	Clio II Box 1.1	D7F 746	Petrol	1149	4	4
03/99→10/03	Clio II Box 1.2	D7F 722	Petrol	1149	4	4
03/99→10/03	Clio II Box 1.2	D7F 726	Petrol	1149	4	4
03/99→10/03	Clio II Box 1.2	D7F 746	Petrol	1149	4	4
06/01→	Clio II Box 1.5 dCi	K9K 700 Euro 3	Diesel	1461	4	15
06/01→	Clio II Box 1.5 dCi	K9K 702 Euro 3	Diesel	1461	4	15
06/01→	Clio II Box 1.5 dCi	K9K 704 Euro 3	Diesel	1461	4	15
06/01→	Clio II Box 1.5 dCi	K9K 706	Diesel	1461	4	15
06/01→	Clio II Box 1.5 dCi	K9K 708	Diesel	1461	4	15



CCM

x



11/03→	Clio II Box 1.5 dCi	K9K 710 Euro 3	Diesel	1461	4	15
04/04→	Clio II Box 1.5 dCi	K9K 714 Euro 4	Diesel	1461	4	15
11/03→	Clio II Box 1.5 dCi	K9K 716	Diesel	1461	4	14
09/98→	Clio II Box 1.9 D	F8Q 630	Diesel	1870	4	21
02/00→05/01	Clio II Box 1.9 D	F8Q 632	Diesel	1870	4	21
02/00→05/01	Clio II Box 1.9 D	F8Q 636	Diesel	1870	4	21
02/00→05/01	Clio II Box 1.9 DTi	F9Q 780	Diesel	1870	4	24
05/10→	Clio III 1.2	D4F 764	Petrol	1149	4	3
05/06→	Clio III 1.2 16V	D4F 740	Petrol	1149	4	3
05/06→	Clio III 1.2 16V	D4F 764	Petrol	1149	4	3
08/07→	Clio III 1.2 16V Hi-Flex	D4F 740	Petrol	1149	4	3
08/07→	Clio III 1.2 16V Hi-Flex	D4F 742	Petrol	1149	4	3
06/05→	Clio III 1.4 16V	K4J 780	Petrol	1390	4	19
06/05→	Clio III 1.5 dCi	K9K 714 Euro 4	Diesel	1461	4	15
11/07→	Clio III 1.5 dCi	K9K 750 Euro 3	Diesel	1461	4	15
05/05→	Clio III 1.5 dCi	K9K 752 Euro 3	Diesel	1461	4	15
06/05→	Clio III 1.5 dCi	K9K 764 Euro 4	Diesel	1461	4	14
06/05→	Clio III 1.5 dCi	K9K 766 Euro 4	Diesel	1461	4	15
06/05→	Clio III 1.5 dCi	K9K 768 Euro 4	Diesel	1461	4	15
08/10→	Clio III 1.5 dCi	K9K 770	Diesel	1461	4	14
06/05→	Clio III 1.5 dCi	K9K 772	Diesel	1461	4	14
05/05→02/10	Clio III 1.6 Hi-Flex	K4M 748	Petrol	1598	4	19
12/11→	Clio IV 1.2 16V	D4F 740	Petrol	1149	4	3
11/12→	Clio IV 1.5 dCi 75	K9K 612	Diesel	1461	4	14
01/56→12/69	Dauphine	670.8	Petrol	845	4	1
06/09→	Duster 1.5 dCi	K9K 884 Euro 5	Diesel	1461	4	14
01/84→10/96	Espace 2.1	J8S 814	Diesel	2068	4	33
	Espace 2.1TD	J8S 604	Diesel	2068	4	33
07/84→12/90	Espace I 2.0	J6R 234	Petrol	1995	4	40
07/84→12/90	Espace I 2.0	J6R 236	Petrol	1995	4	40
01/89→12/90	Espace I 2.0 i	J7R 760	Petrol	1995	4	40
03/88→12/92	Espace I 2.0 i Quadra	J7R 760	Petrol	1995	4	40
10/84→12/90	Espace I 2.1 TD	J8S 240	Diesel	2068	4	33
10/84→12/90	Espace I 2.1 TD	J8S 774	Diesel	2068	4	33
07/86→12/90	Espace I 2.2	J7T 770	Petrol	2165	4	40
01/88→12/90	Espace I 2.2 Quadra	J7T 770	Petrol	2165	4	40
01/91→10/96	Espace II 2.0	J7R 768	Petrol	1995	4	40
01/91→05/92	Espace II 2.1 RTDT Quadra	J8S 772	Diesel	2068	4	33
01/91→10/96	Espace II 2.1 TD	J8S 610	Diesel	2068	4	33
11/94→10/96	Espace II 2.1 TD	J8S 612	Diesel	2068	4	33
01/91→10/96	Espace II 2.1 TD	J8S 772	Diesel	2068	4	33
01/91→10/96	Espace II 2.1 TD	J8S 776	Diesel	2068	4	33
01/91→10/96	Espace II 2.1 TD	J8S 778	Diesel	2068	4	33
01/91→10/96	Espace II 2.1 TD	J8S 890	Diesel	2068	4	33
01/91→10/96	Espace II 2.2	J7T 772	Petrol	2165	4	41
01/91→10/96	Espace II 2.2	J7T 776	Petrol	2165	4	41
03/91→12/96	Espace II 2.2 4x4	J7T 772	Petrol	2165	4	41
11/96→10/00	Espace III 2.0	F3R 728	Petrol	1998	4	27
11/96→10/00	Espace III 2.0	F3R 729	Petrol	1998	4	27
11/96→10/00	Espace III 2.2 12V TD	G8T 714	Petrol	2188	4	36
11/96→10/00	Espace III 2.2 12V TD	G8T 716	Petrol	2188	4	36
11/96→10/00	Espace III 2.2 12V TD	G8T 760	Petrol	2188	4	36
11/97→01/00	Espace III 2.2 D	G8T 716	Petrol	2188	4	36
10/00→10/02	Espace III 2.2 dCi	G9T 642	Diesel	2188	4	37
07/00→10/02	Espace III 2.2 dCi	G9T 710	Diesel	2188	4	37
11/02→	Espace IV 1.9 dCi	F9Q 820	Diesel	1870	4	23
11/02→	Espace IV 1.9 dCi	F9Q 826	Diesel	1870	4	23
01/06→	Espace IV 2.0 dCi	M9R 740	Diesel	1995	4	30
01/06→	Espace IV 2.0 dCi	M9R 750	Diesel	1995	4	30
01/06→	Espace IV 2.0 dCi	M9R 760	Diesel	1995	4	30

MODEL INDEX

Modelverzeichnis • Index de modele • Índice de Modelo
Indeks modelu • Модель автомобиля • دليل الموديل



CCM

x



9

01/06→	Espace IV 2.0 dCi	M9R 761	Diesel	1995	4	30
01/06→	Espace IV 2.0 dCi	M9R 762	Diesel	1995	4	30
01/06→	Espace IV 2.0 dCi	M9R 763	Diesel	1995	4	30
01/06→	Espace IV 2.0 dCi	M9R 802	Diesel	1995	4	30
02/06→	Espace IV 2.2 dCi	G9T 645 Euro 4	Diesel	2188	4	37
11/02→	Espace IV 2.2 dCi	G9T 742	Diesel	2188	4	37
11/02→	Espace IV 2.2 dCi	G9T 743	Diesel	2188	4	37
02/62→12/81	Estafette 1.1	C1E (688.01)	Petrol	1108	4	5
08/69→12/81	Estafette 1.3	810.01	Petrol	1289	4	8
03/86→08/91	Express 1.0	C1C 754	Petrol	956	4	2
03/86→07/90	Express 1.1	C1E 688	Petrol	1108	4	6
09/91→10/97	Express 1.1	C1E 764	Petrol	1108	4	5
03/86→09/97	Express 1.4i	E6J 734	Petrol	1390	4	11
02/10→	Fluence 1.5 dCi	K9K 830	Diesel	1461	4	14
06/05→	Fluence 1.5 dCi	K9K 832 Euro 4	Diesel	1461	4	14
02/10→	Fluence 1.5 dCi	K9K 834	Diesel	1461	4	14
02/10→	Fluence 1.5 dCi	K9K 836	Diesel	1461	4	14
02/10→	Fluence 1.5 dCi	K9K 837 Euro 5	Diesel	1461	4	14
02/80→10/85	Fuego 1.4 TL/GTL	847 720	Petrol	1397	4	13
04/83→10/85	Fuego 1.6	A2M 723	Petrol	1647	4	18
10/80→10/85	Fuego 2.0 TX/GTX	J6R 710	Petrol	1995	4	40
10/80→10/85	Fuego 2.0 TX/GTX	J6R 712	Petrol	1995	4	40
10/80→10/85	Fuego 2.0 TX/GTX	J6R 713	Petrol	1995	4	40
10/80→10/85	Fuego 2.0 TX/GTX	J6R 715	Petrol	1995	4	40
08/82→10/85	Fuego 2.1 TD	J8S 712	Diesel	2068	4	34
09/05→	Grand Scenic 2.0 dCi	M9R A 700 Euro 4	Diesel	1995	4	30
04/04→	Grand Scénic II 1.5 dCi	K9K 729 Euro 3	Diesel	1461	4	15
05/05→	Grand Scénic II 1.5 dCi	K9K P 732	Diesel	1461	4	14
04/04→	Grand Scénic II 1.9 dCi	F9Q 812	Diesel	1870	4	23
05/05→	Grand Scénic II 1.9 dCi	F9Q 816	Diesel	1870	4	23
05/05→	Grand Scénic II 1.9 dCi	F9Q 818	Diesel	1870	4	23
09/05→	Grand Scénic II 2.0 dCi	M9R 700	Diesel	1995	4	30
09/05→	Grand Scénic II 2.0 dCi	M9R 721	Diesel	1995	4	30
09/05→	Grand Scénic II 2.0 dCi	M9R 722	Diesel	1995	4	30
04/09→	Grand Scénic III 1.5 dCi	K9K 636 Euro 5	Diesel	1461	4	14
04/09→	Grand Scénic III 1.5 dCi	K9K 830	Diesel	1461	4	14
02/09→	Grand Scénic III 1.5 dCi	K9K 832 Euro 4	Diesel	1461	4	14
04/09→	Grand Scénic III 1.5 dCi	K9K 836	Diesel	1461	4	14
04/09→	Grand Scénic III 1.5 dCi	K9K 837 Euro 5	Diesel	1461	4	14
11/10→	Grand Scénic III 1.5 dCi	K9K 846 Euro 5	Diesel	1461	4	14
04/09→	Grand Scénic III 2.0 dCi	M9R 610	Diesel	1995	4	30
02/09→	Grand Scénic III 2.0 dCi	M9R 615	Diesel	1995	4	30
02/08→	Kangoo / Grand Kangoo 1.5 dCi	K9K 800	Diesel	1461	4	14
02/08→	Kangoo / Grand Kangoo 1.5 dCi	K9K 802 Euro 4	Diesel	1461	4	15
02/08→	Kangoo / Grand Kangoo 1.5 dCi	K9K 804 Euro 4	Diesel	1461	4	14
02/08→	Kangoo / Grand Kangoo 1.5 dCi	K9K 806 Euro 4 (FAP)	Diesel	1461	4	14
11/12→	Kangoo / Grand Kangoo 1.5 dCi	K9K 808	Diesel	1461	4	14
09/10→	Kangoo / Grand Kangoo 1.5 dCi 110	K9K 804 Euro 4	Diesel	1461	4	14
02/08→	Kangoo / Grand Kangoo 1.6 16V	K4M 830 Euro 4	Petrol	1598	4	20
02/08→	Kangoo / Grand Kangoo 1.6 16V	K4M 831 Euro 4	Petrol	1598	4	20
08/97→	Kangoo 1.2	D7F 710	Petrol	1149	4	4
08/97→	Kangoo 1.2	D7F 720	Petrol	1149	4	4
08/97→	Kangoo 1.2	D7F 722	Petrol	1149	4	4
08/97→	Kangoo 1.2	D7F 726	Petrol	1149	4	4
08/97→	Kangoo 1.2	D7F 744	Petrol	1149	4	4
08/97→	Kangoo 1.2	D7F 746	Petrol	1149	4	4
01/06→	Kangoo 1.2 16V	D4F 712	Petrol	1149	4	3
01/06→	Kangoo 1.2 16V	D4F 714	Petrol	1149	4	3
01/06→	Kangoo 1.2 16V	D4F 716	Petrol	1149	4	3
08/97→	Kangoo 1.4	E7J 634	Petrol	1390	4	11



CCM

x



08/97→	Kangoo 1.4	E7J 635	Petrol	1390	4	11
08/97→	Kangoo 1.4	E7J 780	Petrol	1390	4	11
12/01→	Kangoo 1.5 dCi	K9K 700 Euro 3	Diesel	1461	4	15
07/02→	Kangoo 1.5 dCi	K9K 702 Euro 3	Diesel	1461	4	15
12/01→	Kangoo 1.5 dCi	K9K 704 Euro 3	Diesel	1461	4	15
07/02→	Kangoo 1.5 dCi	K9K 706	Diesel	1461	4	15
07/02→	Kangoo 1.5 dCi	K9K 708	Diesel	1461	4	15
07/02→	Kangoo 1.5 dCi	K9K 710 Euro 3	Diesel	1461	4	15
06/05→	Kangoo 1.5 dCi	K9K 714 Euro 4	Diesel	1461	4	15
06/05→	Kangoo 1.5 dCi	K9K 718 Euro 4	Diesel	1461	4	15
02/08→	Kangoo 1.5 dCi	K9K 794	Diesel	1461	4	15
	Kangoo 1.5 dCi	K9K 812	Diesel	1461	4	14
02/08→	Kangoo 1.5 dCi	K9K G 724	Diesel	1461	4	15
09/99→06/01	Kangoo 1.6	K7M 746	Petrol	1598	4	20
06/01→	Kangoo 1.6 16V	K4M 752	Petrol	1598	4	19
06/01→	Kangoo 1.6 16V	K4M 753	Petrol	1598	4	19
10/01→	Kangoo 1.6 16V 4x4	K4M 752	Petrol	1598	4	19
10/01→	Kangoo 1.6 16V 4x4	K4M 753	Petrol	1598	4	19
09/01→	Kangoo 1.6i	K4M 730	Petrol	1598	4	19
10/01→	Kangoo 1.9 dCi 4x4	F9Q 782	Diesel	1870	4	24
10/01→	Kangoo 1.9 dCi 4x4	F9Q 790	Diesel	1870	4	24
02/00→	Kangoo 1.9 dTi	F9Q 780	Diesel	1870	4	24
09/99→06/01	Kangoo 1.9 RXED	F8Q 632	Diesel	1870	4	21
09/99→06/01	Kangoo 1.9 RXED	F8Q 636	Diesel	1870	4	21
06/09→	Kangoo Be Bop 1.5 dCi	K9K 804 Euro 4	Diesel	1461	4	14
02/09→	Kangoo Be Bop 1.5 dCi	K9K 806 Euro 4 (FAP)	Diesel	1461	4	14
06/09→	Kangoo Be Bop 1.5 dCi	K9K 808	Diesel	1461	4	14
09/10→	Kangoo Be Bop 1.5 dCi 75	K9K 802 Euro 4	Diesel	1461	4	15
02/09→	Kangoo Be Bop 1.6	K4M 830 Euro 4	Petrol	1598	4	20
08/97→	Kangoo D 55 1.9	F8Q 662	Diesel	1870	4	21
08/97→	Kangoo D 65 1.9	F8Q 630	Diesel	1870	4	21
08/97→	Kangoo D 65 1.9	F8Q 632	Diesel	1870	4	21
08/97→	Kangoo D 65 1.9	F8Q 636	Diesel	1870	4	21
08/97→	Kangoo Express 1.2	D7F 710	Petrol	1149	4	4
08/97→	Kangoo Express 1.2	D7F 720	Petrol	1149	4	4
08/97→	Kangoo Express 1.2	D7F 722	Petrol	1149	4	4
08/97→	Kangoo Express 1.2	D7F 726	Petrol	1149	4	4
08/97→	Kangoo Express 1.2	D7F 744	Petrol	1149	4	4
08/97→	Kangoo Express 1.2	D7F 746	Petrol	1149	4	4
07/98→07/01	Kangoo Express 1.2	D7F 764	Petrol	1149	4	4
07/98→07/01	Kangoo Express 1.2	D7F 766 Euro 4	Petrol	1149	4	4
01/10→	Kangoo Express 1.2 16V	D4F 712	Petrol	1149	4	3
01/10→	Kangoo Express 1.2 16V	D4F 714	Petrol	1149	4	3
01/10→	Kangoo Express 1.2 16V	D4F 730	Petrol	1149	4	3
07/98→07/01	Kangoo Express 1.2 BiFuel	D7F 710	Petrol	1149	4	4
07/98→07/01	Kangoo Express 1.2 BiFuel	D7F 744	Petrol	1149	4	4
08/97→	Kangoo Express 1.4	E7J 634	Petrol	1390	4	11
08/97→	Kangoo Express 1.4	E7J 635	Petrol	1390	4	11
08/97→	Kangoo Express 1.4	E7J 780	Petrol	1390	4	11
12/01→	Kangoo Express 1.5 dCi	K9K 700 Euro 3	Diesel	1461	4	15
12/01→	Kangoo Express 1.5 dCi	K9K 702 Euro 3	Diesel	1461	4	15
12/01→	Kangoo Express 1.5 dCi	K9K 704 Euro 3	Diesel	1461	4	15
12/01→	Kangoo Express 1.5 dCi	K9K 706	Diesel	1461	4	15
12/01→	Kangoo Express 1.5 dCi	K9K 708	Diesel	1461	4	15
04/03→	Kangoo Express 1.5 dCi	K9K 710 Euro 3	Diesel	1461	4	15
06/05→	Kangoo Express 1.5 dCi	K9K 714 Euro 4	Diesel	1461	4	15
06/05→	Kangoo Express 1.5 dCi	K9K 718 Euro 4	Diesel	1461	4	15
02/08→	Kangoo Express 1.5 dCi	K9K 800	Diesel	1461	4	14
02/08→	Kangoo Express 1.5 dCi	K9K 806 Euro 4 (FAP)	Diesel	1461	4	14
09/10→	Kangoo Express 1.5 dCi 110	K9K 804 Euro 4	Diesel	1461	4	14

MODEL INDEX

Modelverzeichnis • Index de modele • Índice de Modelo
Indeks modelu • Модель автомобиля • دليل الموديل



CCM

x



9

09/10→	Kangoo Express 1.5 dCi 75	K9K 800	Diesel	1461	4	14
02/08→	Kangoo Express 1.5 dCi 85	K9K 800	Diesel	1461	4	14
02/08→	Kangoo Express 1.5 dCi 85	K9K 802 Euro 4	Diesel	1461	4	15
06/09→	Kangoo Express 1.5 dCi 90	K9K 808	Diesel	1461	4	14
10/01→	Kangoo Express 1.6 16V	K4M 752	Petrol	1598	4	19
02/08→	Kangoo Express 1.6 16V	K4M 830 Euro 4	Petrol	1598	4	20
10/01→	Kangoo Express 1.6 16V 4x4	K4M 752	Petrol	1598	4	19
10/01→	Kangoo Express 1.6 16V 4x4	K4M 753	Petrol	1598	4	19
02/08→	Kangoo Express 1.6 16V LPG	K4M 834 Euro 4	Gas	1598	4	20
09/99→06/03	Kangoo Express 1.9 D	F8Q 632	Diesel	1870	4	21
09/99→06/03	Kangoo Express 1.9 D	F8Q 636	Diesel	1870	4	21
07/03→	Kangoo Express 1.9 dCi	F9Q 782	Diesel	1870	4	24
07/03→	Kangoo Express 1.9 dCi	F9Q 790	Diesel	1870	4	24
10/01→	Kangoo Express 1.9 dCi 4x4	F9Q 782	Diesel	1870	4	24
10/01→	Kangoo Express 1.9 dCi 4x4	F9Q 790	Diesel	1870	4	24
02/00→	Kangoo Express 1.9 dTi	F9Q 780	Diesel	1870	4	24
08/97→	Kangoo Express D 55 1.9	F8Q 662	Diesel	1870	4	21
08/97→	Kangoo Express D 65 1.9	F8Q 630	Diesel	1870	4	21
08/97→	Kangoo Express D 65 1.9	F8Q 632	Diesel	1870	4	21
08/97→	Kangoo Express D 65 1.9	F8Q 636	Diesel	1870	4	21
12/05→	Kangoo II 1.6i	K4M 698	Petrol	1598	4	19
09/08→	Koleos 2.0 dCi	M9R 830	Diesel	1995	4	30
09/08→	Koleos 2.0 dCi	M9R 832	Diesel	1995	4	30
09/08→	Koleos 2.0 dCi 4x4	M9R 830	Diesel	1995	4	30
09/08→	Koleos 2.0 dCi 4x4	M9R 832	Diesel	1995	4	30
05/98→02/01	Laguna 1.6i	K4M 724	Petrol	1598	4	19
03/12→	Laguna Coupe 1.5 dCi	K9K 846 Euro 5	Diesel	1461	4	14
09/08→	Laguna Coupe 2.0 dCi	M9R 800	Diesel	1995	4	30
09/08→	Laguna Coupe 2.0 dCi	M9R 802	Diesel	1995	4	30
09/08→	Laguna Coupe 2.0 dCi	M9R 809	Diesel	1995	4	30
03/08→	Laguna Coupe 2.0 dCi GT	M9R 816	Diesel	1995	4	30
11/97→03/01	Laguna Grandtour 1.6 16V	K4M 720	Petrol	1598	4	19
09/95→03/01	Laguna Grandtour 1.8	F3P 670	Petrol	1794	4	27
09/95→03/01	Laguna Grandtour 1.8	F3P 678	Petrol	1794	4	27
09/95→03/01	Laguna Grandtour 1.8	F3P 720	Petrol	1794	4	27
09/95→03/01	Laguna Grandtour 1.8	F3P 724	Petrol	1794	4	27
09/99→03/01	Laguna Grandtour 1.9 dCi	F9Q 718	Diesel	1870	4	24
10/97→03/01	Laguna Grandtour 1.9 dTi	F9Q 710	Diesel	1870	4	24
10/97→03/01	Laguna Grandtour 1.9 dTi	F9Q 717	Diesel	1870	4	24
09/95→03/01	Laguna Grandtour 2.0	F3R 722	Petrol	1998	4	27
09/95→03/01	Laguna Grandtour 2.0	F3R 723	Petrol	1998	4	27
09/95→03/01	Laguna Grandtour 2.0 16V	N7Q 700	Petrol	1948	4	29
09/95→03/01	Laguna Grandtour 2.0 16V	N7Q 704	Petrol	1948	4	29
09/95→03/01	Laguna Grandtour 2.2 D	G8T 706	Diesel	2188	4	35
09/95→03/01	Laguna Grandtour 2.2 D	G8T 752	Diesel	2188	4	35
09/95→03/01	Laguna Grandtour 2.2 D	G8T 790	Diesel	2188	4	35
09/95→03/01	Laguna Grandtour 2.2 D	G8T 792	Diesel	2188	4	35
09/95→03/01	Laguna Grandtour 2.2 D	G8T 794	Diesel	2188	4	35
03/96→03/01	Laguna Grandtour 2.2 dT	G8T 760	Petrol	2188	4	36
03/97→03/01	Laguna Grandtour 3.0 24V	L7X 700	Petrol	2946	V6	38
03/97→03/01	Laguna Grandtour 3.0 24V	L7X 701	Petrol	2946	V6	38
11/97→03/01	Laguna I 1.6 16V	K4M 720	Petrol	1598	4	19
08/95→03/01	Laguna I 1.8	F3P 670	Petrol	1794	4	27
08/95→03/01	Laguna I 1.8	F3P 678	Petrol	1794	4	27
11/93→03/01	Laguna I 1.8	F3P 720	Petrol	1794	4	27
11/93→03/01	Laguna I 1.8	F3P 724	Petrol	1794	4	27
09/99→03/01	Laguna I 1.9 dCi	F9Q 718	Diesel	1870	4	24
10/97→03/01	Laguna I 1.9 dTi	F9Q 710	Diesel	1870	4	24
10/97→03/01	Laguna I 1.9 dTi	F9Q 717	Diesel	1870	4	24
11/93→03/01	Laguna I 2.0	F3R 722	Petrol	1998	4	27

Modelverzeichnis • Index de modele • Índice de Modelo
Indeks modelu • Модель автомобиля • دليل الموديل

MODEL INDEX



CCM

x



9

11/93→03/01	Laguna I 2.0	F3R 723	Petrol	1998	4	27
06/95→02/01	Laguna I 2.0	N7Q 700	Petrol	1948	4	29
06/95→02/01	Laguna I 2.0	N7Q 704	Petrol	1948	4	29
06/95→03/01	Laguna I 2.0 16V	N7Q 700	Petrol	1948	4	29
06/95→03/01	Laguna I 2.0 16V	N7Q 704	Petrol	1948	4	29
11/93→03/01	Laguna I 2.2 D	G8T 706	Diesel	2188	4	35
11/93→03/01	Laguna I 2.2 D	G8T 752	Diesel	2188	4	35
11/93→03/01	Laguna I 2.2 D	G8T 790	Diesel	2188	4	35
11/93→03/01	Laguna I 2.2 D	G8T 792	Diesel	2188	4	35
11/93→03/01	Laguna I 2.2 D	G8T 794	Diesel	2188	4	35
03/96→03/01	Laguna I 2.2 dT	G8T 760	Petrol	2188	4	36
03/97→03/01	Laguna I 3.0 24V	L7X 700	Petrol	2946	V6	38
03/97→03/01	Laguna I 3.0 24V	L7X 701	Petrol	2946	V6	38
03/01→	Laguna II 1.6 16V	K4M 710	Petrol	1598	4	19
03/01→	Laguna II 1.6 16V	K4M 711	Petrol	1598	4	19
03/01→	Laguna II 1.6 16V	K4M 712	Petrol	1598	4	19
03/01→	Laguna II 1.6 16V	K4M 714	Petrol	1598	4	19
02/05→	Laguna II 1.6 16V	K4M 716	Petrol	1598	4	19
	Laguna II 1.9 dCi	F9Q 650	Diesel	1870	4	23
03/04→	Laguna II 1.9 dCi	F9Q 664	Diesel	1870	4	23
03/01→	Laguna II 1.9 dCi	F9Q 670	Diesel	1870	4	23
03/01→	Laguna II 1.9 dCi	F9Q 674	Diesel	1870	4	23
03/01→	Laguna II 1.9 dCi	F9Q 718	Diesel	1870	4	24
03/01→	Laguna II 1.9 dCi	F9Q 750	Diesel	1870	4	23
06/01→	Laguna II 1.9 dCi	F9Q 752	Diesel	1870	4	24
03/01→	Laguna II 1.9 dCi	F9Q 754	Diesel	1870	4	24
03/01→	Laguna II 1.9 dCi	F9Q 756	Diesel	1870	4	23
01/05→	Laguna II 1.9 dCi	F9Q 758	Diesel	1870	4	23
05/05→	Laguna II 1.9 dCi	F9Q 759	Diesel	1870	4	23
08/05→	Laguna II 2.0 dCi	M9R 740	Diesel	1995	4	30
01/06→	Laguna II 2.0 dCi	M9R 760	Diesel	1995	4	30
04/04→	Laguna II 2.2 dCi	G9T 600 Euro 4	Diesel	2188	4	37
05/05→	Laguna II 2.2 dCi	G9T 605 Euro 4	Diesel	2188	4	37
10/01→	Laguna II 2.2 dCi	G9T 700	Diesel	2188	4	37
10/01→	Laguna II 2.2 dCi	G9T 702	Diesel	2188	4	37
10/01→	Laguna II 2.2 dCi	G9T 704	Diesel	2188	4	37
05/05→	Laguna II 2.2 dCi	G9T 706	Diesel	2188	4	37
05/05→	Laguna II 2.2 dCi	G9T 707	Diesel	2188	4	37
03/01→	Laguna II Grandtour 1.6 16V	K4M 710	Petrol	1598	4	19
03/01→	Laguna II Grandtour 1.6 16V	K4M 711	Petrol	1598	4	19
03/01→	Laguna II Grandtour 1.6 16V	K4M 712	Petrol	1598	4	19
03/01→	Laguna II Grandtour 1.6 16V	K4M 714	Petrol	1598	4	19
02/05→	Laguna II Grandtour 1.6 16V	K4M 716	Petrol	1598	4	19
	Laguna II Grandtour 1.9 dCi	F9Q 650	Diesel	1870	4	23
03/04→	Laguna II Grandtour 1.9 dCi	F9Q 664	Diesel	1870	4	23
03/01→	Laguna II Grandtour 1.9 dCi	F9Q 670	Diesel	1870	4	23
03/01→	Laguna II Grandtour 1.9 dCi	F9Q 674	Diesel	1870	4	23
03/01→	Laguna II Grandtour 1.9 dCi	F9Q 718	Diesel	1870	4	24
03/01→	Laguna II Grandtour 1.9 dCi	F9Q 750	Diesel	1870	4	23
06/01→	Laguna II Grandtour 1.9 dCi	F9Q 752	Diesel	1870	4	24
03/01→	Laguna II Grandtour 1.9 dCi	F9Q 754	Diesel	1870	4	24
	Laguna II Grandtour 1.9 dCi	F9Q 756	Diesel	1870	4	23
01/05→	Laguna II Grandtour 1.9 dCi	F9Q 758	Diesel	1870	4	23
05/05→	Laguna II Grandtour 1.9 dCi	F9Q 759	Diesel	1870	4	23
08/05→	Laguna II Grandtour 2.0 dCi	M9R 740	Diesel	1995	4	30
01/06→	Laguna II Grandtour 2.0 dCi	M9R 760	Diesel	1995	4	30
04/04→	Laguna II Grandtour 2.2 dCi	G9T 600 Euro 4	Diesel	2188	4	37
10/01→	Laguna II Grandtour 2.2 dCi	G9T 702	Diesel	2188	4	37
05/05→	Laguna II Grandtour 2.2 dCi	G9T 706	Diesel	2188	4	37
05/05→	Laguna II Grandtour 2.2 dCi	G9T 707	Diesel	2188	4	37

MODEL INDEX

Modelverzeichnis • Index de modele • Índice de Modelo
Indeks modelu • Модель автомобиля • دليل الموديل



CCM



9

Year	Model	Engine	Fuel	CCM	Oil	9
10/07→	Laguna III 1.5 dCi	K9K 780 Euro 4	Diesel	1461	4	14
10/07→	Laguna III 2.0 dCi	M9R 742	Diesel	1995	4	30
10/07→	Laguna III 2.0 dCi	M9R 744	Diesel	1995	4	30
10/07→	Laguna III 2.0 dCi	M9R 746	Diesel	1995	4	30
10/07→	Laguna III 2.0 dCi	M9R 748	Diesel	1995	4	30
01/08→	Laguna III 2.0 dCi	M9R 800	Diesel	1995	4	30
10/07→	Laguna III 2.0 dCi	M9R 802	Diesel	1995	4	30
01/08→	Laguna III 2.0 dCi	M9R 809	Diesel	1995	4	30
10/07→	Laguna III 2.0 dCi	M9Ra 742 Euro 4	Diesel	1995	4	30
03/08→	Laguna III 2.0 dCi GT	M9R 816	Diesel	1995	4	30
10/07→	Laguna III Grandtour 1.5 dCi	K9K 780 Euro 4	Diesel	1461	4	14
10/07→	Laguna III Grandtour 2.0 dCi	M9R 742	Diesel	1995	4	30
10/07→	Laguna III Grandtour 2.0 dCi	M9R 744	Diesel	1995	4	30
10/07→	Laguna III Grandtour 2.0 dCi	M9R 746	Diesel	1995	4	30
10/07→	Laguna III Grandtour 2.0 dCi	M9R 748	Diesel	1995	4	30
01/08→	Laguna III Grandtour 2.0 dCi	M9R 800	Diesel	1995	4	30
10/07→	Laguna III Grandtour 2.0 dCi	M9R 802	Diesel	1995	4	30
01/08→	Laguna III Grandtour 2.0 dCi	M9R 809	Diesel	1995	4	30
03/08→	Laguna III Grandtour 2.0 dCi GT	M9R 816	Diesel	1995	4	30
07/10→	Latitude 1.5 dCi	K9K 782	Diesel	1461	4	14
09/04→	Logan 1.4	K7J	Petrol	1390	4	20
09/04→	Logan 1.4	K7J 710	Petrol	1390	4	20
04/07→	Logan 1.5 dCi	K9K 792	Diesel	1461	4	15
02/08→	Logan 1.5 dCi	K9K 796	Diesel	1461	4	15
04/07→	Logan 1.6	K4M 690	Petrol	1598	4	19
09/04→	Logan 1.6	K7M 710	Petrol	1598	4	20
10/07→	Logan Estate 1.4	K7J	Petrol	1390	4	20
10/07→	Logan Estate 1.4	K7J 710	Petrol	1390	4	20
	Logan Estate 1.5 dCi	K9K 790	Diesel	1461	4	15
04/07→	Logan Estate 1.5 dCi	K9K 792	Diesel	1461	4	15
02/08→	Logan Estate 1.5 dCi	K9K 796	Diesel	1461	4	15
04/07→	Logan Estate 1.6	K4M 697	Petrol	1598	4	19
04/07→	Logan Estate 1.6	K7M 710	Petrol	1598	4	20
09/80→	Master	J8S 232 (852.232)	Diesel	2068	4	33
01/94→09/97	Master 2.4 D	S8U 748	Diesel	2445	4	49
09/89→12/93	Master 2.5 D	8140-07 (Sofim)	Diesel	2499	4	46
08/89→07/98	Master 2.5 TD	8140.27 (Sofim)	Diesel	2499	4	47
08/89→07/98	Master 2.5 TD	8140.27.2565 (Sofim)	Diesel	2499	4	47
08/89→07/98	Master 2.5 TD	8140.27.2582	Diesel	2499	4	47
08/89→07/98	Master 2.5 TD	8140.27.2585	Diesel	2499	4	47
09/89→12/93	Master 2.5D	8140.07.2700	Diesel	2499	4	46
09/89→	Master 2.5D	8140.07.3700 Euro 1	Diesel	2499	4	46
10/93→08/95	Master 2.5D	8140.27.2565 (Sofim)	Diesel	2499	4	47
09/95→08/96	Master 2.5D Dist. Catena	8140.27.2565 (Sofim)	Diesel	2499	4	47
01/94→09/97	Master 2.5TD	8140.27.2560	Diesel	2499	4	48
09/80→00/93	Master 2.5TD	8140.27.2700	Diesel	2499	4	47
01/94→09/97	Master 2.5TD	8140.47.2535	Diesel	2499	4	48
09/80→	Master 2.5TD	8140.47.2700 Euro 1	Diesel	2499	4	48
09/80→	Master 2.5TD	8140.47.2721 Euro 1	Diesel	2499	4	48
09/80→	Master 2.5TD	8140.47.2785 Euro 1	Diesel	2499	4	48
	Master B80	8140.07.2701 (Sofim), 8140.07.2710	Diesel	2499	4	46
06/85→10/89	Master I Box 2.0	829 730	Petrol	1995	4	40
06/85→10/89	Master I Box 2.0	J5R 728	Petrol	1995	4	40
07/83→12/92	Master I Box 2.4 D	S8U 730	Diesel	2445	4	49
07/80→06/83	Master I Box 2.4 D	S8U 731	Diesel	2445	4	49
08/80→10/86	Master I Box 28-35 2.0	829 731	Petrol	1995	4	40
10/86→07/98	Master I Box 28-35 2.0	J5R 718	Petrol	1995	4	40
08/80→07/98	Master I Box 28-35 2.1 D	J8S 330	Diesel	2068	4	34
08/80→08/89	Master I Box 28-35 2.4 D	8140.61.2300	Diesel	2445	4	49
08/80→08/89	Master I Box 28-35 2.4 D	S8U 731	Diesel	2445	4	49

Modelverzeichnis • Index de modele • Índice de Modelo
Indeks modelu • Модель автомобиля • دليل الموديل

MODEL INDEX



CCM

x



9

08/89→07/98	Master I Box 28-35 2.5 D	S8U 742	Diesel	2499	4	50
08/89→07/98	Master I Box 28-35 2.5 TD	8140.27 (Sofim)	Diesel	2499	4	47
08/89→07/98	Master I Box 28-35 2.5 TD	8140.27.2565 (Sofim)	Diesel	2499	4	47
08/89→07/98	Master I Box 28-35 2.5 TD	8140.27.2582	Diesel	2499	4	47
08/89→07/98	Master I Box 28-35 2.5 TD	8140.27.2585	Diesel	2499	4	47
08/80→07/98	Master I Box 30 2.2	J7T 782	Petrol	2165	4	40
08/89→07/98	Master I Box 35 2.5	S9U 714	Diesel	2499	4	48
06/85→10/89	Master I Bus 2.0	J5R 728	Petrol	1995	4	40
11/89→04/95	Master I Bus 2.1 D	J8S 330	Diesel	2068	4	34
09/86→10/89	Master I Bus 2.4 D	S8U 731	Diesel	2445	4	49
08/80→09/86	Master I Bus 28-35 2.0	829 731	Petrol	1995	4	40
10/86→07/98	Master I Bus 28-35 2.0	J5R 718	Petrol	1995	4	40
08/80→07/98	Master I Bus 28-35 2.1 D	J8S 330	Diesel	2068	4	34
08/80→08/89	Master I Bus 28-35 2.4 D	8140.61.2300	Diesel	2445	4	49
08/80→08/89	Master I Bus 28-35 2.4 D	S8U 731	Diesel	2445	4	49
08/89→07/98	Master I Bus 28-35 2.5 D	S8U 742	Diesel	2499	4	50
08/80→07/98	Master I Bus 30 2.2	J7T 782	Petrol	2165	4	40
08/89→07/98	Master I Bus 35 2.5	S9U 714	Diesel	2499	4	48
07/80→06/85	Master I Platform/Chassis 2.0	829 731	Petrol	1995	4	40
11/89→12/95	Master I Platform/Chassis 2.0	J5R 716	Petrol	1995	4	40
11/89→07/93	Master I Platform/Chassis 2.0	J5R 718	Petrol	1995	4	40
11/89→12/95	Master I Platform/Chassis 2.0	J5R 728	Petrol	1995	4	40
11/89→07/93	Master I Platform/Chassis 2.1 D	J8S 330	Diesel	2068	4	34
08/93→02/98	Master I Platform/Chassis 2.4 D	S8U 730	Diesel	2445	4	49
07/80→10/89	Master I Platform/Chassis 2.5 D	S8U 742	Diesel	2499	4	50
10/82→09/86	Master I Platform/Chassis 28-35 2.0	829 730	Petrol	1995	4	40
10/86→07/98	Master I Platform/Chassis 28-35 2.0	J5R 728	Petrol	1995	4	40
09/80→07/98	Master I Platform/Chassis 28-35 2.5 D	8140.61.2300	Diesel	2445	4	49
09/80→07/98	Master I Platform/Chassis 28-35 2.5 D	S8U 731	Diesel	2445	4	49
11/01→	Master II Box 1.9 dCi 80	F9Q 772	Diesel	1870	4	24
11/01→	Master II Box 1.9 dCi 80	F9Q 774	Diesel	1870	4	24
09/00→	Master II Box 1.9 dTI	F9Q 770	Diesel	1870	4	24
09/00→	Master II Box 2.2 dCI 90	G9T 720	Diesel	2188	4	37
09/00→	Master II Box 2.2 dCI 90	G9T 722	Diesel	2188	4	37
09/00→	Master II Box 2.2 dCI 90	G9T 750	Diesel	2188	4	37
08/06→	Master II Box 2.5 dCi	G9U 632 Euro 4	Diesel	2464	4	42
08/06→	Master II Box 2.5 dCi	G9U 650 Euro 4	Diesel	2464	4	42
01/04→	Master II Box 2.5 dCi	G9U 750 Euro 3	Diesel	2463	4	43
08/06→	Master II Box 2.5 dCi	G9U 754 Euro 3	Diesel	2463	4	43
10/03→	Master II Box 2.5 dCi 100	G9U 754 Euro 3	Diesel	2463	4	43
10/01→	Master II Box 2.5 dCi 120	G9U 720 Euro 3	Diesel	2463	4	43
10/01→	Master II Box 2.5 dCi 120	G9U 724 Euro 3	Diesel	2463	4	43
10/01→	Master II Box 2.5 dCi 120	G9U 754 Euro 3	Diesel	2463	4	43
07/98→10/01	Master II Box 2.8 dTI	S9W 700/S9W 702	Diesel	2799	4	51
11/01→	Master II Bus 1.9 dCi 80	F9Q 772	Diesel	1870	4	24
11/01→	Master II Bus 1.9 dCi 80	F9Q 774	Diesel	1870	4	24
09/00→	Master II Bus 1.9 dTI	F9Q 770	Diesel	1870	4	24
09/00→	Master II Bus 2.2 dCI 90	G9T 720	Diesel	2188	4	37
09/00→	Master II Bus 2.2 dCI 90	G9T 722	Diesel	2188	4	37
09/00→	Master II Bus 2.2 dCI 90	G9T 750	Diesel	2188	4	37
08/06→	Master II Bus 2.5 dCi	G9U 632 Euro 4	Diesel	2464	4	42
08/06→	Master II Bus 2.5 dCi	G9U 650 Euro 4	Diesel	2464	4	42
01/04→	Master II Bus 2.5 dCi	G9U 750 Euro 3	Diesel	2463	4	43
08/06→	Master II Bus 2.5 dCi	G9U 754 Euro 3	Diesel	2463	4	43
10/03→	Master II Bus 2.5 dCi 100	G9U 754 Euro 3	Diesel	2463	4	43
10/01→	Master II Bus 2.5 dCi 120	G9U 720 Euro 3	Diesel	2463	4	43
10/01→	Master II Bus 2.5 dCi 120	G9U 754 Euro 3	Diesel	2463	4	43
07/98→10/01	Master II Bus 2.8 dTI	S9W 700/S9W 702	Diesel	2799	4	51
09/00→	Master II Platform/Chassis 2.2 dCI 90	G9T 720	Diesel	2188	4	37
09/00→	Master II Platform/Chassis 2.2 dCI 90	G9T 722	Diesel	2188	4	37

MODEL INDEX

Modelverzeichnis • Index de modele • Índice de Modelo
Indeks modelu • Модель автомобиля • دليل الموديل



CCM

x



9

09/00→	Master II Platform/Chassis 2.2 dCi 90	G9T 750	Diesel	2188	4	37
08/06→	Master II Platform/Chassis 2.5 dCi	G9U 632 Euro 4	Diesel	2464	4	42
08/06→	Master II Platform/Chassis 2.5 dCi	G9U 650 Euro 4	Diesel	2464	4	42
01/04→	Master II Platform/Chassis 2.5 dCi	G9U 750 Euro 3	Diesel	2463	4	43
08/06→	Master II Platform/Chassis 2.5 dCi	G9U 754 Euro 3	Diesel	2463	4	43
10/03→	Master II Platform/Chassis 2.5 dCi 100	G9U 754 Euro 3	Diesel	2463	4	43
10/01→	Master II Platform/Chassis 2.5 dCi 120	G9U 720 Euro 3	Diesel	2463	4	43
10/01→	Master II Platform/Chassis 2.5 dCi 120	G9U 754 Euro 3	Diesel	2463	4	43
07/98→10/01	Master II Platform/Chassis 2.8 dTi	S9W 700/S9W 702	Diesel	2799	4	51
02/10→	Master III Box 2.3 dCi [RWD]	M9T 686 Euro 5	Diesel	2298	4	31
02/10→	Master III Box 2.3 dCi [RWD]	M9T 690 Euro 5	Diesel	2298	4	31
02/10→	Master III Box 2.3 dCi [RWD]	M9T 692 Euro 4	Diesel	2298	4	31
02/10→	Master III Box 2.3 dCi [RWD]	M9T 694 Euro 4	Diesel	2298	4	31
02/10→	Master III Box 2.3 dCi [RWD]	M9T 696 Euro 4	Diesel	2298	4	31
02/10→	Master III Box 2.3 dCi [RWD]	M9T 698 Euro 5	Diesel	2298	4	31
02/10→	Master III Box 2.3 dCi FWD	M9T 670 Euro 5	Diesel	2298	4	31
02/10→	Master III Box 2.3 dCi FWD	M9T 672 Euro 5	Diesel	2298	4	31
02/10→	Master III Box 2.3 dCi FWD	M9T 676 Euro 4	Diesel	2298	4	31
02/10→	Master III Box 2.3 dCi FWD	M9T 678	Diesel	2298	4	31
02/10→	Master III Box 2.3 dCi FWD	M9T 680	Diesel	2298	4	31
02/10→	Master III Box 2.3 dCi FWD	M9T 694 Euro 4	Diesel	2298	4	31
02/10→	Master III Box 2.3 dCi FWD	M9T 696 Euro 4	Diesel	2298	4	31
02/10→	Master III Box 2.3 dCi FWD	M9T 698 Euro 5	Diesel	2298	4	31
02/11→	Master III Bus 2.3 dCi 100 FWD	M9T 670 Euro 5	Diesel	2298	4	31
02/11→	Master III Bus 2.3 dCi 100 FWD	M9T 672 Euro 5	Diesel	2298	4	31
02/11→	Master III Bus 2.3 dCi 100 FWD	M9T 676 Euro 4	Diesel	2298	4	31
02/11→	Master III Bus 2.3 dCi 125 FWD	M9T 670 Euro 5	Diesel	2298	4	31
02/11→	Master III Bus 2.3 dCi 125 FWD	M9T 672 Euro 5	Diesel	2298	4	31
02/11→	Master III Bus 2.3 dCi 125 FWD	M9T 676 Euro 4	Diesel	2298	4	31
02/11→	Master III Bus 2.3 dCi FWD	M9T 680	Diesel	2298	4	31
02/10→	Master III Platform/Chassis 2.3 dCi	M9T 686 Euro 5	Diesel	2298	4	31
02/10→	Master III Platform/Chassis 2.3 dCi	M9T 690 Euro 5	Diesel	2298	4	31
02/10→	Master III Platform/Chassis 2.3 dCi	M9T 692 Euro 4	Diesel	2298	4	31
02/10→	Master III Platform/Chassis 2.3 dCi	M9T 694 Euro 4	Diesel	2298	4	31
02/10→	Master III Platform/Chassis 2.3 dCi	M9T 696 Euro 4	Diesel	2298	4	31
02/10→	Master III Platform/Chassis 2.3 dCi	M9T 698 Euro 5	Diesel	2298	4	31
02/10→	Master III Platform/Chassis 2.3 dCi FWD	M9T 670 Euro 5	Diesel	2298	4	31
02/10→	Master III Platform/Chassis 2.3 dCi FWD	M9T 672 Euro 5	Diesel	2298	4	31
02/10→	Master III Platform/Chassis 2.3 dCi FWD	M9T 676 Euro 4	Diesel	2298	4	31
02/10→	Master III Platform/Chassis 2.3 dCi FWD	M9T 678	Diesel	2298	4	31
02/10→	Master III Platform/Chassis 2.3 dCi FWD	M9T 680	Diesel	2298	4	31
06/10→	Megane CC 1.5 dCi	K9K 836	Diesel	1461	4	14
06/10→	Megane CC 2.0 dCi	M9R 610	Diesel	1995	4	30
03/99→08/03	Megane I 1.4 16V	K4J 714	Petrol	1390	4	19
03/99→08/03	Megane I 1.4 16V	K4J 750	Petrol	1390	4	19
01/96→08/03	Megane I 1.4 e	E7J 626	Petrol	1390	4	11
01/96→08/03	Megane I 1.4 e	E7J 764	Petrol	1390	4	11
01/96→03/99	Megane I 1.4 Eco	E7J 624	Petrol	1390	4	11
03/99→08/03	Megane I 1.6 16V	K4M 700	Petrol	1598	4	19
03/99→08/03	Megane I 1.6 16V	K4M 701	Petrol	1598	4	19
03/99→08/03	Megane I 1.6 16V	K4M 704	Petrol	1598	4	19
03/99→08/03	Megane I 1.6 16V	K4M 708	Petrol	1598	4	19
01/96→03/99	Megane I 1.6 e	K7M 702	Petrol	1598	4	20
01/96→03/99	Megane I 1.6 e	K7M 703	Petrol	1598	4	20
01/96→03/99	Megane I 1.6 e	K7M 790	Petrol	1598	4	20
01/96→03/99	Megane I 1.6 i	K7M 720	Petrol	1598	4	20
10/00→08/02	Megane I 1.6 LPG	K4M 704	Petrol	1598	4	19
04/96→02/01	Megane I 1.9 D	F8Q 784	Diesel	1870	4	22
01/96→08/03	Megane I 1.9 D Eco	F8Q 620	Diesel	1870	4	21
03/99→08/03	Megane I 1.9 dCi	F9Q 732	Diesel	1870	4	24



CCM

x



02/01→08/03	Megane I 1.9 dCi	F9Q 733	Diesel	1870	4	24
03/99→08/03	Megane I 1.9 DCi	F9Q 738	Diesel	1870	4	24
	Megane I 1.9 dT	F8Q 768	Diesel	1870	4	22
01/96→08/03	Megane I 1.9 dT	F8Q 784	Diesel	1870	4	22
01/96→08/03	Megane I 1.9 dT	F8Q 785	Diesel	1870	4	22
01/96→08/03	Megane I 1.9 dT	F8Q 786	Diesel	1870	4	22
03/97→02/01	Megane I 1.9 dTi	F9Q 730	Diesel	1870	4	24
03/97→02/01	Megane I 1.9 dTi	F9Q 734	Diesel	1870	4	24
03/97→02/01	Megane I 1.9 dTi	F9Q 736	Diesel	1870	4	24
02/01→08/03	Megane I 1.9 dTi	F9Q 744	Diesel	1870	4	24
09/96→08/03	Megane I 1.9 TDI	F8Q 784	Diesel	1870	4	22
07/96→08/03	Megane I 2.0 16V	F7R 710	Petrol	1998	4	28
07/96→08/03	Megane I 2.0 16V	F7R 714	Petrol	1998	4	28
01/96→08/03	Megane I 2.0 i	F3R 750	Petrol	1998	4	27
03/99→08/03	Megane I Cabriolet 1.4 16V	K4J 714	Petrol	1390	4	19
03/99→08/03	Megane I Cabriolet 1.4 16V	K4J 750	Petrol	1390	4	19
03/99→08/03	Megane I Cabriolet 1.6 16V	K4M 700	Petrol	1598	4	19
03/99→08/03	Megane I Cabriolet 1.6 16V	K4M 701	Petrol	1598	4	19
03/99→08/03	Megane I Cabriolet 1.6 16V	K4M 708	Petrol	1598	4	19
10/96→03/99	Megane I Cabriolet 1.6 e	K7M 702	Petrol	1598	4	20
10/96→03/99	Megane I Cabriolet 1.6 e	K7M 703	Petrol	1598	4	20
04/97→08/03	Megane I Cabriolet 2.0	F3R 750	Petrol	1998	4	27
10/96→11/99	Megane I Cabriolet 2.0 16V	F7R 710	Petrol	1998	4	28
10/96→11/99	Megane I Cabriolet 2.0 16V	F7R 714	Petrol	1998	4	28
09/96→08/03	Megane I Classic 1.4	E7J 626	Petrol	1390	4	11
09/96→08/03	Megane I Classic 1.4	E7J 764	Petrol	1390	4	11
03/99→08/03	Megane I Classic 1.4 16V	K4J 714	Petrol	1390	4	19
03/99→08/03	Megane I Classic 1.4 16V	K4J 750	Petrol	1390	4	19
03/99→08/03	Megane I Classic 1.6 16V	K4M 700	Petrol	1598	4	19
03/99→08/03	Megane I Classic 1.6 16V	K4M 701	Petrol	1598	4	19
03/99→08/03	Megane I Classic 1.6 16V	K4M 708	Petrol	1598	4	19
09/96→03/99	Megane I Classic 1.6 e	K7M 702	Petrol	1598	4	20
09/96→03/99	Megane I Classic 1.6 e	K7M 703	Petrol	1598	4	20
09/96→03/99	Megane I Classic 1.6 e	K7M 790	Petrol	1598	4	20
09/96→03/99	Megane I Classic 1.6 i	K7M 720	Petrol	1598	4	20
09/96→08/03	Megane I Classic 1.9 D	F8Q 620	Diesel	1870	4	21
02/01→08/03	Megane I Classic 1.9 dCi	F9Q 732	Diesel	1870	4	24
03/99→08/03	Megane I Classic 1.9 dCi	F9Q 733	Diesel	1870	4	24
02/01→08/03	Megane I Classic 1.9 dCi	F9Q 738	Diesel	1870	4	24
09/96→08/03	Megane I Classic 1.9 dT	F8Q 784	Diesel	1870	4	22
09/96→08/03	Megane I Classic 1.9 dT	F8Q 785	Diesel	1870	4	22
09/96→08/03	Megane I Classic 1.9 dT	F8Q 786	Diesel	1870	4	22
03/97→02/01	Megane I Classic 1.9 dTi	F9Q 730	Diesel	1870	4	24
03/97→02/01	Megane I Classic 1.9 dTi	F9Q 734	Diesel	1870	4	24
03/97→02/01	Megane I Classic 1.9 dTi	F9Q 736	Diesel	1870	4	24
02/01→08/03	Megane I Classic 1.9 dTi	F9Q 744	Diesel	1870	4	24
09/96→08/03	Megane I Classic 1.9 TDI	F8Q 784	Diesel	1870	4	22
09/96→08/03	Megane I Classic 2.0 i	F3R 750	Petrol	1998	4	27
03/99→08/03	Megane I Coach 1.4 16V	K4J 714	Petrol	1390	4	19
03/99→08/03	Megane I Coach 1.4 16V	K4J 750	Petrol	1390	4	19
03/99→08/03	Megane I Coach 1.6 16V	K4M 700	Petrol	1598	4	19
03/99→08/03	Megane I Coach 1.6 16V	K4M 701	Petrol	1598	4	19
03/99→08/03	Megane I Coach 1.6 16V	K4M 708	Petrol	1598	4	19
03/96→03/99	Megane I Coach 1.6 e	K7M 702	Petrol	1598	4	20
03/96→03/99	Megane I Coach 1.6 e	K7M 703	Petrol	1598	4	20
02/01→08/03	Megane I Coach 1.9 dCi	F9Q 732	Diesel	1870	4	24
02/01→08/03	Megane I Coach 1.9 dCi	F9Q 733	Diesel	1870	4	24
03/97→02/01	Megane I Coach 1.9 dTi	F9Q 734	Diesel	1870	4	24
03/97→02/01	Megane I Coach 1.9 dTi	F9Q 736	Diesel	1870	4	24
03/96→11/99	Megane I Coach 2.0 16V	F7R 710	Petrol	1998	4	28

MODEL INDEX

Modelverzeichnis • Index de modele • Índice de Modelo
Indeks modelu • Модель автомобиля • دليل الموديل



CCM



9

03/96→11/99	Megane I Coach 2.0 16V	F7R 714	Petrol	1998	4	28
03/96→08/03	Megane I Coach 2.0 i	F3R 750	Petrol	1998	4	27
03/99→08/03	Megane I Grandtour 1.4 16V	K4J 714	Petrol	1390	4	19
03/99→08/03	Megane I Grandtour 1.4 16V	K4J 750	Petrol	1390	4	19
03/99→08/03	Megane I Grandtour 1.4 e	E7J 626	Petrol	1390	4	11
03/99→08/03	Megane I Grandtour 1.6 16V	K4M 700	Petrol	1598	4	19
03/99→08/03	Megane I Grandtour 1.6 16V	K4M 701	Petrol	1598	4	19
03/99→08/03	Megane I Grandtour 1.6 16V	K4M 704	Petrol	1598	4	19
03/99→08/03	Megane I Grandtour 1.6 16V	K4M 708	Petrol	1598	4	19
03/99→08/03	Megane I Grandtour 1.6 e	K7M 702	Petrol	1598	4	20
03/99→08/03	Megane I Grandtour 1.6 e	K7M 703	Petrol	1598	4	20
02/01→08/03	Megane I Grandtour 1.9 dCi	F9Q 732	Diesel	1870	4	24
02/01→08/03	Megane I Grandtour 1.9 dCi	F9Q 733	Diesel	1870	4	24
02/01→08/03	Megane I Grandtour 1.9 dCi	F9Q 738	Diesel	1870	4	24
03/99→02/01	Megane I Grandtour 1.9 dTi	F9Q 736	Diesel	1870	4	24
02/01→08/03	Megane I Grandtour 1.9 dTi	F9Q 744	Diesel	1870	4	24
11/02→	Megane II 1.4 16V	K4J 730	Petrol	1390	4	19
10/03→	Megane II 1.4 16V	K4J 732	Petrol	1390	4	19
11/02→	Megane II 1.4 16V	K4J 740	Petrol	1390	4	19
10/03→	Megane II 1.4 16V	K4J D 740	Petrol	1390	4	19
11/02→	Megane II 1.5 dCi	K9K 722 Euro 3	Diesel	1461	4	15
05/05→	Megane II 1.5 dCi	K9K 724 Euro 4	Diesel	1461	4	15
10/03→	Megane II 1.5 dCi	K9K 728 Euro 3	Diesel	1461	4	15
10/03→	Megane II 1.5 dCi	K9K 729 Euro 3	Diesel	1461	4	15
05/05→	Megane II 1.5 dCi	K9K 732 Euro 4	Diesel	1461	4	14
11/02→	Megane II 1.6 16V	K4M 760	Petrol	1598	4	19
	Megane II 1.9 dCi	F9Q 650	Diesel	1870	4	23
11/02→	Megane II 1.9 dCi	F9Q 800	Diesel	1870	4	23
11/02→	Megane II 1.9 dCi	F9Q 808	Diesel	1870	4	23
11/02→	Megane II 1.9 dCi	F9Q 816	Diesel	1870	4	23
11/02→	Megane II 1.9 dCi	F9Q 818	Diesel	1870	4	23
09/05→	Megane II 2.0 dCi	M9R 700	Diesel	1995	4	30
09/05→	Megane II 2.0 dCi	M9R 722	Diesel	1995	4	30
01/07→	Megane II 2.0 dCi	M9R 724	Diesel	1995	4	30
03/06→	Megane II Coupé-Cabriolet 1.5 dCi	K9K 732 Euro 4	Diesel	1461	4	14
09/03→	Megane II Coupé-Cabriolet 1.6	K4M 760	Petrol	1598	4	19
01/06→	Megane II Coupé-Cabriolet 1.6 16V	K4M 760	Petrol	1598	4	19
01/06→	Megane II Coupé-Cabriolet 1.6 16V	K4M D 812	Petrol	1598	4	19
09/03→	Megane II Coupé-Cabriolet 1.9 dCi	F9Q 800	Diesel	1870	4	23
09/03→	Megane II Coupé-Cabriolet 1.9 dCi	F9Q 816	Diesel	1870	4	23
09/03→	Megane II Coupé-Cabriolet 1.9 dCi	F9Q 818	Diesel	1870	4	23
09/05→	Megane II Coupé-Cabriolet 2.0 dCi	M9R 700	Diesel	1995	4	30
09/05→	Megane II Coupé-Cabriolet 2.0 dCi	M9R 722	Diesel	1995	4	30
08/03→	Megane II Estate 1.4	K4J 730	Petrol	1390	4	19
08/03→	Megane II Estate 1.4	K4J 740	Petrol	1390	4	19
08/03→	Megane II Estate 1.5 dCi	K9K 722 Euro 3	Diesel	1461	4	15
05/05→	Megane II Estate 1.5 dCi	K9K 724 Euro 4	Diesel	1461	4	15
02/04→	Megane II Estate 1.5 dCi	K9K 728 Euro 3	Diesel	1461	4	15
02/04→	Megane II Estate 1.5 dCi	K9K 729 Euro 3	Diesel	1461	4	15
05/05→	Megane II Estate 1.5 dCi	K9K 732 Euro 4	Diesel	1461	4	14
08/03→	Megane II Estate 1.6	K4M 760	Petrol	1598	4	19
01/06→	Megane II Estate 1.6 16V	K4M 760	Petrol	1598	4	19
01/06→	Megane II Estate 1.6 16V	K4M D 812	Petrol	1598	4	19
08/03→	Megane II Estate 1.9 dCi	F9Q 800	Diesel	1870	4	23
03/04→	Megane II Estate 1.9 dCi	F9Q 808	Diesel	1870	4	23
05/05→	Megane II Estate 1.9 dCi	F9Q 818	Diesel	1870	4	23
09/05→	Megane II Estate 2.0 dCi	M9R 700	Diesel	1995	4	30
09/05→	Megane II Estate 2.0 dCi	M9R 722	Diesel	1995	4	30
09/03→	Megane II Saloon 1.4	K4J 730	Petrol	1390	4	19
09/03→	Megane II Saloon 1.4	K4J 732	Petrol	1390	4	19



CCM

x



09/03→	Megane II Saloon 1.4	K4J 740	Petrol	1390	4	19
09/03→	Megane II Saloon 1.4	K4J D 740	Petrol	1390	4	19
09/03→	Megane II Saloon 1.5 dCi	K9K 722 Euro 3	Diesel	1461	4	15
05/05→	Megane II Saloon 1.5 dCi	K9K 724 Euro 4	Diesel	1461	4	15
02/04→	Megane II Saloon 1.5 dCi	K9K 728 Euro 3	Diesel	1461	4	15
02/04→	Megane II Saloon 1.5 dCi	K9K 729 Euro 3	Diesel	1461	4	15
05/05→	Megane II Saloon 1.5 dCi	K9K 732 Euro 4	Diesel	1461	4	14
09/03→	Megane II Saloon 1.6	K4M 760	Petrol	1598	4	19
01/06→	Megane II Saloon 1.6 16V	K4M D 812	Petrol	1598	4	19
09/03→	Megane II Saloon 1.9 dCi	F9Q 800	Diesel	1870	4	23
09/03→	Megane II Saloon 1.9 dCi	F9Q 808	Diesel	1870	4	23
05/05→	Megane II Saloon 1.9 dCi	F9Q 816	Diesel	1870	4	23
05/05→	Megane II Saloon 1.9 dCi	F9Q 818	Diesel	1870	4	23
09/05→	Megane II Saloon 2.0 dCi	M9R 700	Diesel	1995	4	30
09/05→	Megane II Saloon 2.0 dCi	M9R 722	Diesel	1995	4	30
11/08→	Megane III Coupe 1.5 dCi	K9K F 830	Diesel	1461	4	14
02/09→	Megane III Coupe 1.5 dCi	K9K G 832	Diesel	1461	4	14
11/08→	Megane III Coupe 1.5 dCi	K9K H 834	Diesel	1461	4	14
02/09→	Megane III Coupe 1.5 dCi	K9K J 836	Diesel	1461	4	14
02/09→	Megane III Coupe 1.5 dCi	K9K N 837	Diesel	1461	4	14
04/09→	Megane III Coupe 2.0 dCi	M9R 610	Diesel	1995	4	30
04/09→	Megane III Coupe 2.0 dCi	M9R 615	Diesel	1995	4	30
05/09→	Megane III Grandtour 1.5 dCi	K9K 834	Diesel	1461	4	14
02/09→	Megane III Grandtour 1.5 dCi	K9K 836	Diesel	1461	4	14
02/09→	Megane III Grandtour 1.5 dCi	K9K 837 Euro 5	Diesel	1461	4	14
02/09→	Megane III Grandtour 1.5 dCi	K9K 846 Euro 5	Diesel	1461	4	14
04/09→	Megane III Grandtour 2.0 dCi	M9R 610	Diesel	1995	4	30
10/10→	Megane III Grandtour 2.0 dCi	M9R 615	Diesel	1995	4	30
12/09→	Megane III Hatchback 1.5 dCi	K9K 830	Diesel	1461	4	14
02/09→	Megane III Hatchback 1.5 dCi	K9K 836	Diesel	1461	4	14
02/09→	Megane III Hatchback 1.5 dCi	K9K G 832	Diesel	1461	4	14
11/08→	Megane III Hatchback 1.5 dCi	K9K H 834	Diesel	1461	4	14
11/08→	Megane III Hatchback 1.6 16V	K4M 760	Petrol	1598	4	19
04/09→	Megane III Hatchback 2.0 dCi	M9R 610	Diesel	1995	4	30
10/10→	Megane III Hatchback 2.0 dCi	M9R 615	Diesel	1995	4	30
01/97→09/99	Megane Scenic 1.4 i	E7J 764	Petrol	1390	4	11
04/98→10/99	Megane Scenic 1.6 16V	K4M 700	Petrol	1598	4	19
04/98→10/99	Megane Scenic 1.6 16V	K4M 701	Petrol	1598	4	19
04/98→10/99	Megane Scenic 1.6 16V	K4M 704	Petrol	1598	4	19
04/98→10/99	Megane Scenic 1.6 16V	K4M 708	Petrol	1598	4	19
10/96→10/99	Megane Scenic 1.6 e	K7M 702	Petrol	1598	4	20
10/96→10/99	Megane Scenic 1.6 e	K7M 703	Petrol	1598	4	20
01/97→09/99	Megane Scenic 1.6 i	K7M 720	Petrol	1598	4	20
01/97→09/99	Megane Scenic 1.9 dT	F8Q 784	Diesel	1870	4	22
01/97→09/99	Megane Scenic 1.9 dT	F8Q 785	Diesel	1870	4	22
01/97→09/99	Megane Scenic 1.9 dT	F8Q 786	Diesel	1870	4	22
04/97→09/99	Megane Scenic 1.9 dTi	F9Q 730	Diesel	1870	4	24
04/97→09/99	Megane Scenic 1.9 dTi	F9Q 734	Diesel	1870	4	24
01/97→09/99	Megane Scenic 2.0 i	F3R 750	Petrol	1998	4	27
05/97→10/99	Megane Scenic 2.0 RXE 4x4	F3R 750	Petrol	1998	4	27
09/90→06/99	Messenger B80	8140.07.2530	Diesel	2499	4	46
	Messenger B120.35	8140.47.2530	Diesel	2499	4	48
04/12→	Modus / Grand Modus 1.2	D4F 740	Petrol	1149	4	3
05/05→	Modus / Grand Modus 1.2	D4F 740	Petrol	1149	4	3
04/12→	Modus / Grand Modus 1.2	D4F 764	Petrol	1149	4	3
08/10→	Modus / Grand Modus 1.2 16V Hi-Flex	D4F 740	Petrol	1149	4	3
12/04→	Modus / Grand Modus 1.4	K4J 770	Petrol	1390	4	19
09/04→	Modus / Grand Modus 1.5 dCi	K9K 750 Euro 3	Diesel	1461	4	15
12/04→	Modus / Grand Modus 1.5 dCi	K9K 752 Euro 3	Diesel	1461	4	15
12/04→	Modus / Grand Modus 1.5 dCi	K9K 760 Euro 4	Diesel	1461	4	15

MODEL INDEX

Modelverzeichnis • Index de modele • Índice de Modelo
Indeks modelu • Модель автомобиля • دليل الموديل



CCM



9

Year	Model	Engine	CCM	Oil Pan	Oil Capacity
12/04→	Modus / Grand Modus 1.5 dCi	K9K 762 Euro 4	Diesel	1461	4 15
05/05→	Modus / Grand Modus 1.5 dCi	K9K 764 Euro 4	Diesel	1461	4 14
12/04→	Modus / Grand Modus 1.5 dCi	K9K 766 Euro 4	Diesel	1461	4 15
12/04→	Modus / Grand Modus 1.5 dCi	K9K 768 Euro 4	Diesel	1461	4 15
05/07→	Modus / Grand Modus 1.5 dCi	K9K 772	Diesel	1461	4 14
10/10→	Modus / Grand Modus 1.5 dCi 75	K9K 770	Diesel	1461	4 14
10/10→	Modus / Grand Modus 1.5 dCi 90	K9K 750 Euro 3	Diesel	1461	4 15
12/04→	Modus / Grand Modus 1.6	K4M 790	Petrol	1598	4 19
10/82→12/93	R4 1.1	688.11	Petrol	1108	4 5
10/79→03/85	R5 1.1	688 13	Petrol	1108	4 5
01/62→12/68	R6	C1E (688.01)	Petrol	1108	4 6
08/70→04/87	R6 1.1	688 03	Petrol	1108	4 5
09/80→03/86	R6 1.1	688 13	Petrol	1108	4 5
01/62→12/68	R8	C1E (688.01)	Petrol	1108	4 6
07/65→10/72	R8 1.0	689.01	Petrol	956	4 2
02/69→01/75	R8 1.1	688 02	Petrol	1108	4 5
01/62→12/68	R10	C1E (688.01)	Petrol	1108	4 6
01/74→01/80	R11 1.3	810.1	Petrol	1289	4 8
01/75→12/84	R30 TS	Z7V-140	Petrol	2664	V6 39
01/78→12/84	R30 TX	Z7V-140	Petrol	2664	V6 39
04/97→09/97	Rapid 1.9 D	F8Q 648	Diesel	1870	4 22
09/85→05/92	Rapid Box 1.0	C1C 706	Petrol	956	4 2
07/85→04/95	Rapid Box 1.1	C1E 750	Petrol	1108	4 5
07/85→04/95	Rapid Box 1.1	C1E 752	Petrol	1108	4 5
07/85→04/95	Rapid Box 1.1	C1E 754	Petrol	1108	4 5
06/87→09/91	Rapid Box 1.1	C1E 756	Petrol	1108	4 5
07/85→04/95	Rapid Box 1.1	C1E 760	Petrol	1108	4 5
07/85→04/95	Rapid Box 1.1	C1E 762	Petrol	1108	4 5
07/85→04/95	Rapid Box 1.1	C1E 792	Petrol	1108	4 5
09/91→08/93	Rapid Box 1.2	C1G 726	Petrol	1237	4 7
09/91→03/98	Rapid Box 1.2	C3G 710	Petrol	1239	4 9
09/91→03/98	Rapid Box 1.2	C3G 712	Petrol	1239	4 9
05/95→11/98	Rapid Box 1.2	E7F 708	Petrol	1171	4 11
07/85→08/91	Rapid Box 1.4	C1J 768	Petrol	1397	4 13
07/85→08/91	Rapid Box 1.4	C1J 780	Petrol	1397	4 13
03/86→08/91	Rapid Box 1.4	C2J 784	Petrol	1397	4 13
08/88→03/98	Rapid Box 1.4	C3J 700	Petrol	1397	4 13
08/88→03/98	Rapid Box 1.4	C3J 702	Petrol	1397	4 13
08/88→03/98	Rapid Box 1.4	C3J 760	Petrol	1397	4 13
08/88→03/98	Rapid Box 1.4	C3J 762	Petrol	1397	4 13
09/91→03/98	Rapid Box 1.4	E7J 720	Petrol	1390	4 11
09/91→03/98	Rapid Box 1.4	E7J 724	Petrol	1390	4 11
09/91→03/98	Rapid Box 1.4	E7J 726	Petrol	1390	4 11
01/94→03/98	Rapid Box 1.4	E7J 728	Petrol	1390	4 11
09/91→03/98	Rapid Box 1.4	E7J 773	Petrol	1390	4 11
03/86→08/98	Rapid Box 1.6 D	F8M 720	Diesel	1595	4 17
03/86→08/98	Rapid Box 1.6 D	F8M 730	Diesel	1595	4 17
03/86→08/98	Rapid Box 1.6 D	F8M 736	Diesel	1595	4 17
03/86→08/98	Rapid Box 1.6 D	F8M 760	Diesel	1595	4 17
09/94→03/98	Rapid Box 1.9 D	F8Q 640	Diesel	1870	4 21
09/94→03/98	Rapid Box 1.9 D	F8Q 644	Diesel	1870	4 21
09/91→03/98	Rapid Box 1.9 D	F8Q 646	Diesel	1870	4 21
09/94→03/98	Rapid Box 1.9 D	F8Q 682	Diesel	1870	4 21
09/91→03/98	Rapid Box 1.9 D	F8Q 722	Diesel	1870	4 21
09/91→03/98	Rapid Box 1.9 D	F8Q 724	Diesel	1870	4 21
09/91→03/98	Rapid Box 1.9 D	F8Q 774	Diesel	1870	4 21
09/91→03/98	Rapid Box 1.9 D	F8Q 776	Diesel	1870	4 21
08/71→11/81	Rodeo 4 0.8	800 01	Petrol	845	4 1
11/81→12/87	Rodeo 5 1.1	688 12	Petrol	1108	4 5
07/81→02/84	Rodeo 5 1.3	810.26	Petrol	1289	4 8

Modelverzeichnis • Index de modele • Índice de Modelo
Indeks modelu • Модель автомобиля • دليل الموديل

MODEL INDEX



CCM

x



07/81→02/84	Rodeo 5 1.3	810.96	Petrol	1289	4	8
07/81→02/84	Rodeo 5 1.3	810.97	Petrol	1289	4	8
05/70→08/73	Rodeo 6 0.8	800.02	Petrol	845	4	1
08/73→11/81	Rodeo 6 1.1	688 10	Petrol	1108	4	5
11/93→07/96	Safrane I 2.1 dT	J8S 760	Diesel	2068	4	33
04/92→07/96	Safrane I 2.2	J7T 760	Petrol	2165	4	41
04/92→07/96	Safrane I 2.2	J7T 761	Petrol	2165	4	41
04/92→07/96	Safrane I 2.2	J7T 762	Petrol	2165	4	41
07/96→12/00	Safrane II 2.0 16V	N7Q 710	Petrol	1948	4	29
07/96→12/00	Safrane II 2.0 16V	N7Q 711	Petrol	1948	4	29
07/96→12/00	Safrane II 2.2 dT	G8T 740	Petrol	2188	4	36
03/99→12/00	Safrane II 2.9 24V	L7X 713	Petrol	2946	6	38
11/08→	Sandero	D4F 732	Petrol	1149	4	3
02/09→	Sandero/Stepway 1.4	K7J	Petrol	1390	4	20
02/09→	Sandero/Stepway 1.4	K7J 710	Petrol	1390	4	20
12/07→	Sandero/Stepway 1.6	K7M 710	Petrol	1598	4	20
09/05→	Scenic 2.0 dCi	M9R B 721 Euro 4	Diesel	1995	4	30
09/99→08/03	Scénic I 1.4 16V	K4J 714	Petrol	1390	4	19
09/99→08/03	Scénic I 1.4 16V	K4J 750	Petrol	1390	4	19
09/99→09/03	Scénic I 1.6	K4M 700	Petrol	1598	4	19
09/99→09/03	Scénic I 1.6	K4M 706	Petrol	1598	4	19
03/01→08/03	Scénic I 1.6	K4M 708	Petrol	1598	4	19
03/01→08/03	Scénic I 1.6	K4M 709	Petrol	1598	4	19
09/99→04/01	Scénic I 1.6 BiFuel	K4M 704	Petrol	1598	4	19
09/99→08/03	Scénic I 1.9 dCi	F9Q 732	Diesel	1870	4	24
09/99→08/03	Scénic I 1.9 dCi	F9Q 733	Diesel	1870	4	24
12/02→08/03	Scénic I 1.9 dCi RX4	F9Q 732	Diesel	1870	4	24
11/00→08/03	Scénic I 1.9 dCi RX4	F9Q 740	Diesel	1870	4	24
12/02→08/03	Scénic I 1.9 dCi RX4	F9Q 748	Diesel	1870	4	24
09/99→08/03	Scénic I 1.9 dTi	F9Q 734	Diesel	1870	4	24
09/99→08/03	Scénic I 1.9 dTi	F9Q 736	Diesel	1870	4	24
02/01→08/03	Scénic I 1.9 dTi	F9Q 744	Diesel	1870	4	24
06/03→	Scénic II 1.4	K4J 730	Petrol	1390	4	19
06/03→	Scénic II 1.4	K4J 740	Petrol	1390	4	19
06/03→	Scénic II 1.4	K4J 770	Petrol	1390	4	19
06/03→	Scénic II 1.5 dCi	K9K 722 Euro 3	Diesel	1461	4	15
05/05→	Scénic II 1.5 dCi	K9K 724 Euro 4	Diesel	1461	4	15
11/03→	Scénic II 1.5 dCi	K9K 728 Euro 3	Diesel	1461	4	15
11/03→	Scénic II 1.5 dCi	K9K 729 Euro 3	Diesel	1461	4	15
05/05→	Scénic II 1.5 dCi	K9K 732 Euro 4	Diesel	1461	4	14
06/06→	Scénic II 1.9 D	F9Q 812	Diesel	1870	4	23
06/03→	Scénic II 1.9 dCi	F9Q 812	Diesel	1870	4	23
05/05→	Scénic II 1.9 dCi	F9Q 816	Diesel	1870	4	23
05/05→	Scénic II 1.9 dCi	F9Q 818	Diesel	1870	4	23
09/05→	Scénic II 2.0 dCi	M9R 700	Diesel	1995	4	30
09/05→	Scénic II 2.0 dCi	M9R 721	Diesel	1995	4	30
09/05→	Scénic II 2.0 dCi	M9R 722	Diesel	1995	4	30
04/09→	Scénic III 1.5 dCi	K9K 636 Euro 5	Diesel	1461	4	14
04/09→	Scénic III 1.5 dCi	K9K 830	Diesel	1461	4	14
02/09→	Scénic III 1.5 dCi	K9K 832 Euro 4	Diesel	1461	4	14
04/09→	Scénic III 1.5 dCi	K9K 836	Diesel	1461	4	14
04/09→	Scénic III 1.5 dCi	K9K 837 Euro 5	Diesel	1461	4	14
11/10→	Scénic III 1.5 dCi	K9K 846 Euro 5	Diesel	1461	4	14
04/09→	Scénic III 2.0 dCi	M9R 610	Diesel	1995	4	30
02/09→	Scénic III 2.0 dCi	M9R 615	Diesel	1995	4	30
12/95→08/96	Sport Spider 2.0	F7R 710	Petrol	1998	4	28
03/95→10/99	Sport Spider 2.0 16V	F7R 710	Petrol	1998	4	28
10/84→10/88	Super 5 1.0	C1C 700	Petrol	956	4	2
10/84→03/95	Super 5 1.1	C1E 750	Petrol	1108	4	5
10/84→03/95	Super 5 1.1	C1E 752	Petrol	1108	4	5

MODEL INDEX

Modelverzeichnis • Index de modele • Índice de Modelo
Indeks modelu • Модель автомобиля • دليل الموديل



CCM

x



9

10/84→10/88	Super 5 1.1	C1E 754	Petrol	1108	4	5
01/86→03/95	Super 5 1.1	C1E 756	Petrol	1108	4	5
01/86→03/95	Super 5 1.1	C1E 760	Petrol	1108	4	5
01/87→08/90	Super 5 1.2	C1G 702	Petrol	1237	4	7
01/87→08/90	Super 5 1.2	C1G 720	Petrol	1237	4	7
01/87→08/90	Super 5 1.2	C1G 722	Petrol	1237	4	7
10/84→06/88	Super 5 1.4	C1J 768	Petrol	1397	4	13
10/84→06/88	Super 5 1.4	C1J 780	Petrol	1397	4	13
10/84→07/89	Super 5 1.4	C2J 700	Petrol	1397	4	13
06/87→07/89	Super 5 1.4	C2J 782	Petrol	1397	4	13
06/87→08/90	Super 5 1.4	C2J 784	Petrol	1397	4	13
10/85→12/96	Super 5 1.4	C3J 700	Petrol	1397	4	13
10/85→12/96	Super 5 1.4	C3J 702	Petrol	1397	4	13
10/85→12/96	Super 5 1.4	C3J 760	Petrol	1397	4	13
04/85→08/90	Super 5 1.4 Turbo	C1J 782	Petrol	1397	4	12
04/85→08/90	Super 5 1.4 Turbo	C1J 784	Petrol	1397	4	12
04/85→08/90	Super 5 1.4 Turbo	C1J 788	Petrol	1397	4	12
01/85→05/91	Super 5 1.4 Turbo GT	840 730	Petrol	1397	4	12
08/85→12/96	Super 5 1.6 D	F8M 720	Diesel	1595	4	17
04/85→12/96	Super 5 1.6 D	F8M 730	Diesel	1595	4	17
06/87→03/95	Super 5 1.7	F2N 740	Petrol	1721	4	25
06/87→03/95	Super 5 1.7	F2N 742	Petrol	1721	4	25
10/86→03/95	Super 5 1.7	F3N 716	Petrol	1721	4	25
10/86→03/95	Super 5 1.7	F3N 717	Petrol	1721	4	25
10/86→08/91	Super 5 1.7 i	F3N 702	Petrol	1721	4	25
10/86→08/91	Super 5 1.7 i	F3N 722	Petrol	1721	4	25
10/84→10/88	Super 5 Box 1.0	C1C 700	Petrol	956	4	2
10/84→12/96	Super 5 Box 1.1	C1E 750	Petrol	1108	4	5
10/84→12/96	Super 5 Box 1.1	C1E 752	Petrol	1108	4	5
10/84→12/96	Super 5 Box 1.1	C1E 754	Petrol	1108	4	5
01/87→12/96	Super 5 Box 1.2	C1G 702	Petrol	1237	4	7
04/85→10/87	Super 5 Box 1.4	C1J 788	Petrol	1397	4	12
09/85→07/86	Super 5 Box 1.4	C3J 700	Petrol	1397	4	13
10/84→12/96	Super 5 Box 1.6 D	F8M 720	Diesel	1595	4	17
02/98→10/03	Thalia 1.2	D7F 744	Petrol	1149	4	4
02/98→10/03	Thalia 1.2	D7F 746	Petrol	1149	4	4
08/00→	Thalia 1.4 16V	K4J 712	Petrol	1390	4	19
04/02→	Thalia 1.5 dCi	K9K 700 Euro 3	Diesel	1461	4	15
06/01→	Thalia 1.5 dCi	K9K 702 Euro 3	Diesel	1461	4	15
06/01→	Thalia 1.5 dCi	K9K 706	Diesel	1461	4	15
06/01→	Thalia 1.5 dCi	K9K 708	Diesel	1461	4	15
02/03→	Thalia 1.5 dCi	K9K 714 Euro 4	Diesel	1461	4	15
06/05→	Thalia 1.5 dCi	K9K 740 Euro 4	Diesel	1461	4	15
03/98→	Thalia 1.6	K7M 746	Petrol	1598	4	20
04/02→	Thalia 1.6 16V	K4M 740	Petrol	1598	4	19
02/98→05/01	Thalia 1.9 D	F8Q 630	Diesel	1870	4	21
02/04→	Thalia I 1.2 16V	D4F 712	Petrol	1149	4	3
08/09→	Thalia II 1.2 16V	D4F 728	Petrol	1149	4	3
01/09→	Thalia II 1.5 dCi	K9K 700 Euro 3	Diesel	1461	4	15
09/08→	Thalia II 1.5 dCi	K9K 718 Euro 4	Diesel	1461	4	15
09/08→	Thalia II 1.5 dCi	K9K 740 Euro 4	Diesel	1461	4	15
09/08→	Thalia II 1.6 16V	K4M 743	Petrol	1598	4	19
01/81→	Traction T1	841 A1M	Petrol	1647	4	18
01/81→	Traction T4	841 A1M	Petrol	1647	4	18
01/81→	Traction T5	841 A1M	Petrol	1647	4	18
01/81→	Traction T6	841 A1M	Petrol	1647	4	18
01/82→12/86	Trafic 4x4	841 A1M	Petrol	1647	4	18
03/80→04/89	Trafic Box 1.4	847 700	Petrol	1397	4	13
03/80→04/89	Trafic Box 1.4	847 701	Petrol	1397	4	13
03/80→06/91	Trafic Box 1.4	C1J 700	Petrol	1397	4	13



CCM

x



01/83→06/86	Traffic Box 1.6	A1M	Petrol	1647	4	18
01/83→06/86	Traffic Box 1.6	A1M 707	Petrol	1647	4	18
08/85→06/86	Traffic Box 1.6 4x4	A1M 707	Petrol	1647	4	18
08/92→08/94	Traffic Box 1.7	F1N 720	Petrol	1721	4	25
06/86→08/94	Traffic Box 1.7	F1N 724	Petrol	1721	4	25
06/97→03/01	Traffic Box 1.9 D	F8Q 606	Diesel	1870	4	21
05/85→08/90	Traffic Box 2.0	J5R 716	Petrol	1995	4	40
06/86→04/89	Traffic Box 2.0	J5R 722	Petrol	1995	4	40
06/86→04/89	Traffic Box 2.0	J5R 726	Petrol	1995	4	40
06/86→04/89	Traffic Box 2.0 4x4	J5R 716	Petrol	1995	4	40
06/86→04/89	Traffic Box 2.0 4x4	J5R 722	Petrol	1995	4	40
06/86→04/89	Traffic Box 2.0 4x4	J5R 726	Petrol	1995	4	40
09/80→06/94	Traffic Box 2.1 D	852 750	Diesel	2068	4	32
06/94→10/97	Traffic Box 2.1 D	J8S 758	Diesel	2068	4	34
11/86→04/89	Traffic Box 2.1 D 4x4	852 750	Diesel	2068	4	32
06/94→10/97	Traffic Box 2.2	J7T 600	Petrol	2165	4	41
05/89→06/94	Traffic Box 2.2	J7T 780	Petrol	2165	4	40
06/94→10/97	Traffic Box 2.2 4x4	J7T 600	Petrol	2165	4	41
05/89→06/94	Traffic Box 2.2 4x4	J7T 780	Petrol	2165	4	40
05/89→03/01	Traffic Box 2.5 D	8140.67.2500	Diesel	2499	4	50
05/89→03/01	Traffic Box 2.5 D	8140.67.2550	Diesel	2499	4	50
05/89→03/01	Traffic Box 2.5 D	8140.67.2580 Euro 2	Diesel	2499	4	46
03/89→03/01	Traffic Box 2.5 D	S8U 750	Diesel	2499	4	50
05/89→03/01	Traffic Box 2.5 D	S8U 752	Diesel	2499	4	50
05/89→03/01	Traffic Box 2.5 D	S8U 758	Diesel	2499	4	50
05/89→03/01	Traffic Box 2.5 D 4x4	8140.67.2500	Diesel	2499	4	50
05/89→03/01	Traffic Box 2.5 D 4x4	8140.67.2580 Euro 2	Diesel	2499	4	46
05/89→03/01	Traffic Box 2.5 D 4x4	S8U 750	Diesel	2499	4	50
05/89→03/01	Traffic Box 2.5 D 4x4	S8U 752	Diesel	2499	4	50
03/80→04/89	Traffic Bus 1.4	847 700	Petrol	1397	4	13
03/80→04/89	Traffic Bus 1.4	847 701	Petrol	1397	4	13
03/80→04/89	Traffic Bus 1.4	C1J 700	Petrol	1397	4	13
01/84→06/86	Traffic Bus 1.6	A1M	Petrol	1647	4	18
01/84→06/86	Traffic Bus 1.6	A1M 707	Petrol	1647	4	18
03/80→08/86	Traffic Bus 1.6 4x4	A1M 707	Petrol	1647	4	18
06/86→08/94	Traffic Bus 1.7	F1N 724	Petrol	1721	4	25
06/97→03/01	Traffic Bus 1.9 D	F8Q 606	Diesel	1870	4	21
06/86→04/89	Traffic Bus 2.0	J5R 716	Petrol	1995	4	40
06/86→04/89	Traffic Bus 2.0	J5R 722	Petrol	1995	4	40
06/86→08/90	Traffic Bus 2.0	J5R 726	Petrol	1995	4	40
06/86→04/89	Traffic Bus 2.0 4x4	J5R 716	Petrol	1995	4	40
06/86→04/89	Traffic Bus 2.0 4x4	J5R 722	Petrol	1995	4	40
06/86→04/89	Traffic Bus 2.0 4x4	J5R 726	Petrol	1995	4	40
05/89→06/94	Traffic Bus 2.1 D	852 720	Diesel	2068	4	32
03/80→06/94	Traffic Bus 2.1 D	852 750	Diesel	2068	4	32
06/94→10/97	Traffic Bus 2.1 D	J8S 758	Diesel	2068	4	34
05/85→02/89	Traffic Bus 2.1 D 4x4	852 750	Diesel	2068	4	32
06/94→10/97	Traffic Bus 2.2	J7T 600	Petrol	2165	4	41
05/89→06/94	Traffic Bus 2.2	J7T 780	Petrol	2165	4	40
06/94→10/97	Traffic Bus 2.2 4x4	J7T 600	Petrol	2165	4	41
05/89→06/94	Traffic Bus 2.2 4x4	J7T 780	Petrol	2165	4	40
05/89→03/01	Traffic Bus 2.5 D	8140.67.2500	Diesel	2499	4	50
05/89→03/01	Traffic Bus 2.5 D	8140.67.2550	Diesel	2499	4	50
05/89→03/01	Traffic Bus 2.5 D	8140.67.2580 Euro 2	Diesel	2499	4	46
03/89→03/01	Traffic Bus 2.5 D	S8U 750	Diesel	2499	4	50
05/89→03/01	Traffic Bus 2.5 D	S8U 752	Diesel	2499	4	50
05/89→03/01	Traffic Bus 2.5 D	S8U 758	Diesel	2499	4	50
08/89→03/01	Traffic Bus 2.5 D 4x4	8140.67.2500	Diesel	2499	4	50
08/89→03/01	Traffic Bus 2.5 D 4x4	8140.67.2550	Diesel	2499	4	50
08/89→03/01	Traffic Bus 2.5 D 4x4	8140.67.2580 Euro 2	Diesel	2499	4	46

MODEL INDEX

Modelverzeichnis • Index de modele • Índice de Modelo
Indeks modelu • Модель автомобиля • دليل المحرك



CCM

x



9

08/89→03/01	Trafic Bus 2.5 D 4x4	S8U 750	Diesel	2499	4	50
08/89→03/01	Trafic Bus 2.5 D 4x4	S8U 752	Diesel	2499	4	50
08/89→03/01	Trafic Bus 2.5 D 4x4	S8U 758	Diesel	2499	4	50
03/01→	Trafic II Box 1.9 dCi	F9Q 760	Diesel	1870	4	24
04/01→07/03	Trafic II Box 1.9 dCi	F9Q 762	Diesel	1870	4	24
03/01→	Trafic II Box 1.9 dCi 100	F9Q 760	Diesel	1870	4	24
03/01→	Trafic II Box 1.9 dCi 80	F9Q 760	Diesel	1870	4	24
03/01→	Trafic II Box 1.9 dCi 80	F9Q 762	Diesel	1870	4	24
08/06→	Trafic II Box 2.0 dCi 115	M9R 780 Euro 4	Diesel	1995	4	30
08/06→	Trafic II Box 2.0 dCi 115	M9R 782	Diesel	1995	4	30
08/06→	Trafic II Box 2.0 dCi 115	M9R 786 Euro 4	Diesel	1995	4	30
08/06→	Trafic II Box 2.0 dCi 90	M9R 780 Euro 4	Diesel	1995	4	30
08/06→	Trafic II Box 2.0 dCi 90	M9R 782	Diesel	1995	4	30
05/03→	Trafic II Box 2.5 dCi 135	G9U 730 Euro 3	Diesel	2464	4	43
08/06→	Trafic II Box 2.5 dCi 145	G9U 630 Euro 4	Diesel	2464	4	42
03/03→07/03	Trafic II Box 2.5 DTi	G9U 730 Euro 3	Diesel	2464	4	43
04/01→07/03	Trafic II Bus 1.9 dCi	F9Q 762	Diesel	1870	4	24
03/01→	Trafic II Bus 1.9 dCi 100	F9Q 760	Diesel	1870	4	24
03/01→	Trafic II Bus 1.9 dCi 80	F9Q 762	Diesel	1870	4	24
08/06→	Trafic II Bus 2.0 dCi 115	M9R 780 Euro 4	Diesel	1995	4	30
08/06→	Trafic II Bus 2.0 dCi 115	M9R 782	Diesel	1995	4	30
08/06→	Trafic II Bus 2.0 dCi 115	M9R 786 Euro 4	Diesel	1995	4	30
08/06→	Trafic II Bus 2.0 dCi 90	M9R 782	Diesel	1995	4	30
02/08→	Trafic II Bus 2.5 dCi 115	G9U 630 Euro 4	Diesel	2464	4	42
05/03→	Trafic II Bus 2.5 dCi 135	G9U 730 Euro 3	Diesel	2464	4	43
08/06→	Trafic II Bus 2.5 dCi 145	G9U 630 Euro 4	Diesel	2464	4	42
03/03→07/03	Trafic II Bus 2.5 DTi	G9U 730 Euro 3	Diesel	2464	4	43
09/01→07/03	Trafic II Platform/Chassis 1.9 dCi	F9Q 762	Diesel	1870	4	24
03/01→	Trafic II Platform/Chassis 1.9 dCi 100	F9Q 760	Diesel	1870	4	24
03/01→	Trafic II Platform/Chassis 1.9 dCi 80	F9Q 762	Diesel	1870	4	24
08/06→	Trafic II Platform/Chassis 2.0 dCi 115	M9R 780 Euro 4	Diesel	1995	4	30
08/06→	Trafic II Platform/Chassis 2.0 dCi 115	M9R 782	Diesel	1995	4	30
08/06→	Trafic II Platform/Chassis 2.0 dCi 115	M9R 786 Euro 4	Diesel	1995	4	30
08/06→	Trafic II Platform/Chassis 2.0 dCi 90	M9R 780 Euro 4	Diesel	1995	4	30
08/06→	Trafic II Platform/Chassis 2.0 dCi 90	M9R 782	Diesel	1995	4	30
08/07→	Trafic II Platform/Chassis 2.5 dCi	G9U 630 Euro 4	Diesel	2464	4	42
03/01→	Trafic II Platform/Chassis 2.5 dCi 135	G9U 730 Euro 3	Diesel	2464	4	43
08/06→	Trafic II Platform/Chassis 2.5 dCi 145	G9U 630 Euro 4	Diesel	2464	4	42
03/80→04/89	Trafic Platform/Chassis 1.4	C1J 700	Petrol	1397	4	13
03/80→04/89	Trafic Platform/Chassis 1.4	847 700	Petrol	1397	4	13
06/86→08/94	Trafic Platform/Chassis 1.7	F1N 722	Petrol	1721	4	25
03/80→12/91	Trafic Platform/Chassis 2.0	J5R 726	Petrol	1995	4	40
05/89→10/97	Trafic Platform/Chassis 2.0 [RWD]	J5R 726	Petrol	1995	4	40
05/85→02/89	Trafic Platform/Chassis 2.0 4x4	J5R 716	Petrol	1995	4	40
03/80→04/89	Trafic Platform/Chassis 2.1 D	852 720	Diesel	2068	4	32
07/80→04/85	Trafic Platform/Chassis 2.1 D	852 750	Diesel	2068	4	32
05/89→06/94	Trafic Platform/Chassis 2.1 D [RWD]	852 720	Diesel	2068	4	32
06/94→10/97	Trafic Platform/Chassis 2.1 D [RWD]	J8S 758	Diesel	2068	4	34
05/85→02/89	Trafic Platform/Chassis 2.1 D 4x4	852 750	Diesel	2068	4	32
09/94→04/98	Trafic Platform/Chassis 2.2	J7T 600	Petrol	2165	4	41
05/89→06/94	Trafic Platform/Chassis 2.2	J7T 780	Petrol	2165	4	40
09/94→04/98	Trafic Platform/Chassis 2.2 4x4	J7T 600	Petrol	2165	4	41
03/80→03/01	Trafic Platform/Chassis 2.5 D	8140.61.240 (Sofim)	Diesel	2445	4	49
03/80→03/01	Trafic Platform/Chassis 2.5 D	S8U 720	Diesel	2445	4	49
03/80→03/01	Trafic Platform/Chassis 2.5 D	S8U 722	Diesel	2445	4	49
03/89→08/94	Trafic Platform/Chassis 2.5 D	S8U 750	Diesel	2499	4	50
09/94→03/01	Trafic Platform/Chassis 2.5 D	S8U 758	Diesel	2499	4	50
05/98→03/01	Trafic Platform/Chassis 2.5 D	S8U 780	Diesel	2499	4	50
03/89→08/94	Trafic Platform/Chassis 2.5 D 4x4	S8U 750	Diesel	2499	4	50
09/94→01/99	Trafic Platform/Chassis 2.5 D 4x4	S8U 758	Diesel	2499	4	50

Modelverzeichnis • Index de modele • Índice de Modelo
Indeks modelu • Модель автомобиля • دليل الموديل

MODEL INDEX



CCM

x



9

03/93→10/96	Twingo 1.2	C3G 700	Petrol	1239	4	9
03/93→10/96	Twingo 1.2	C3G 702	Petrol	1239	4	9
05/96→	Twingo 1.2	D7F 700	Petrol	1149	4	4
05/96→	Twingo 1.2	D7F 701	Petrol	1149	4	4
05/96→	Twingo 1.2	D7F 702	Petrol	1149	4	4
05/96→	Twingo 1.2	D7F 703	Petrol	1149	4	4
05/96→	Twingo 1.2	D7F 704	Petrol	1149	4	4
10/03→	Twingo 1.2 LPG	D7F 702	Petrol	1149	4	4
04/08→	Twingo 1.5 dCi	K9K 718 Euro 4	Diesel	1461	4	15
03/07→	Twingo 1.5 dCi	K9K 740 Euro 4	Diesel	1461	4	15
	Twingo 1.5 dCi	K9K 840	Diesel	1461	4	14
10/10→	Twingo 1.5 dCi 75	K9K 820	Diesel	1461	4	14
10/10→	Twingo 1.5 dCi 90	K9K 830	Diesel	1461	4	14
03/93→05/96	Twingo Box 1.2	C3G 700	Petrol	1239	4	9
03/93→05/96	Twingo Box 1.2	C3G 702	Petrol	1239	4	9
05/96→	Twingo Box 1.2	D7F 700	Petrol	1149	4	4
05/96→	Twingo Box 1.2	D7F 701	Petrol	1149	4	4
05/96→	Twingo Box 1.2	D7F 702	Petrol	1149	4	4
05/96→	Twingo Box 1.2	D7F 703	Petrol	1149	4	4
05/96→	Twingo Box 1.2	D7F 704	Petrol	1149	4	4
05/96→	Twingo Box 1.2	D7F 706	Petrol	1149	4	4
01/01→	Twingo I 1.2 16V	D4F 702	Petrol	1149	4	3
04/08→	Twingo I 1.2 16V	D4F 708	Petrol	1149	4	3
07/03→	Twingo II 1.2 16V	D4F 764	Petrol	1149	4	3
07/03→	Twingo II 1.2 16V	D4F 772	Petrol	1149	4	3
08/05→	Vel Satis 2.0 dCi	M9R 760	Diesel	1995	4	30
01/06→	Vel Satis 2.0 dCi	M9R 762	Diesel	1995	4	30
01/06→	Vel Satis 2.0 dCi	M9R 763	Diesel	1995	4	30
04/04→	Vel Satis 2.2 dCi	G9T 600 Euro 4	Diesel	2188	4	37
09/04→	Vel Satis 2.2 dCi	G9T 606 Euro 4	Diesel	2188	4	37
09/04→	Vel Satis 2.2 dCi	G9T 607	Diesel	2188	4	37
09/04→	Vel Satis 2.2 dCi	G9T 700	Diesel	2188	4	37
06/02→	Vel Satis 2.2 dCi	G9T 702	Diesel	2188	4	37
06/02→	Vel Satis 2.2 dCi	G9T 703	Diesel	2188	4	37

ENGINE INDEX

Motorverzeichnis • Index de moteur • Índice de Motor
Indeks silnika • Модель двигателя • دليل المحرك



CCM



9

112	Petrol	2664	6	88.00	39
129	Petrol	1218	4	75.00	10
150	Petrol	1360	4	75.00	10
670.800	Petrol	845	4	58.00	1
688 02	Petrol	1108	4	70.00	5
688 03	Petrol	1108	4	70.00	5
688 10	Petrol	1108	4	70.00	5
688 11	Petrol	1108	4	70.00	5
688 12	Petrol	1108	4	70.00	5
688 13	Petrol	1108	4	70.00	5
688.11	Petrol	1108	4	70.00	5
689 710	Petrol	956	4	65.00	2
689.01	Petrol	956	4	65.00	2
800	Petrol	847	4	58.00	1
800 01	Petrol	845	4	58.00	1
800 05	Petrol	845	4	58.00	1
800 705	Petrol	845	4	58.00	1
800 710	Petrol	845	4	58.00	1
800.02	Petrol	845	4	58.00	1
807	Petrol	1565	4	77.00	16
807 03	Petrol	1565	4	77.00	16
807 20	Petrol	1565	4	77.00	16
807 727	Petrol	1565	4	77.00	16
807.04	Petrol	1565	4	77.00	16
807.05	Petrol	1565	4	77.00	16
810.01	Petrol	1289	4	73.00	8
810.02	Petrol	1289	4	73.00	8
810.02/97	Petrol	1289	4	73.00	8
810.03	Petrol	1289	4	73.00	8
810.05	Petrol	1289	4	73.00	8
810.06	Petrol	1289	4	73.00	8
810.10	Petrol	1289	4	73.00	8
810.19	Petrol	1289	4	73.00	8
810.25	Petrol	1289	4	73.00	8
810.26	Petrol	1289	4	73.00	8
810.29	Petrol	1289	4	73.00	8
810.96	Petrol	1289	4	73.00	8
810.97	Petrol	1289	4	73.00	8
821	Petrol	1565	4	77.00	16
821 20	Petrol	1565	4	77.00	16
821.03	Petrol	1565	4	77.00	16
821.04	Petrol	1565	4	77.00	16
829 730	Petrol	1995	4	88.00	40
829 731	Petrol	1995	4	88.00	40
829.01	Petrol	1995	4	88.00	40
840 730	Petrol	1397	4	76.00	12
841 717	Petrol	1647	4	79.00	18
841 A1M	Petrol	1647	4	79.00	18
841.25	Petrol	1647	4	79.00	18
841.26	Petrol	1647	4	79.00	18
843	Petrol	1647	4	79.00	18
843.01	Petrol	1647	4	79.00	18
843.05	Petrol	1647	4	79.00	18
847 700	Petrol	1397	4	76.00	13
847 701	Petrol	1397	4	76.00	13
847 720	Petrol	1397	4	76.00	13
851 700	Petrol	2165	4	88.00	40
852	Diesel	2068	4	86.00	32
852 710	Diesel	2068	4	86.00	32
852 720	Diesel	2068	4	86.00	32

Motorverzeichnis • Index de moteur • Índice de Motor
Indeks silnika • Модель двигателя • دليل المحرك

ENGINE INDEX



CCM

x



9

852 750	Diesel	2068	4	86.00	32
8140.07.2530	Diesel	2499	4	93.00	46
8140.07.2700	Diesel	2499	4	93.00	46
8140.07.2701 (Sofim), 8140.07.2710	Diesel	2499	4	93.00	46
8140.07.3700 Euro 1	Diesel	2499	4	93.00	46
8140.21.235 IDS	Diesel	2445	4	93.00	47
8140.27 (Sofim)	Diesel	2499	4	93.00	47
8140.27.2560	Diesel	2499	4	93.00	48
8140.27.2565 (Sofim)	Diesel	2499	4	93.00	47
8140.27.2582	Diesel	2499	4	93.00	47
8140.27.2585	Diesel	2499	4	93.00	47
8140.27.2700	Diesel	2499	4	93.00	47
8140.47.2530	Diesel	2499	4	93.00	48
8140.47.2535	Diesel	2499	4	93.00	48
8140.47.2700 Euro 1	Diesel	2499	4	93.00	48
8140.47.2721 Euro 1	Diesel	2499	4	93.00	48
8140.47.2785 Euro 1	Diesel	2499	4	93.00	48
8140.61.2300	Diesel	2445	4	93.00	49
8140.61.240 (Sofim)	Diesel	2445	4	93.00	49
8140.67.2500	Diesel	2499	4	93.00	50
8140.67.2550	Diesel	2499	4	93.00	50
8140.67.2580 Euro 2	Diesel	2499	4	93.00	46
8140-07 (Sofim)	Diesel	2499	4	93.00	46
A1M	Petrol	1647	4	79.00	18
A1M 707	Petrol	1647	4	79.00	18
A2M 723	Petrol	1647	4	79.00	18
B1B 707	Petrol	845	4	58.00	1
C1C 700	Petrol	956	4	65.00	2
C1C 706	Petrol	956	4	65.00	2
C1C 708	Petrol	956	4	65.00	2
C1C 754	Petrol	956	4	65.00	2
C1E (688.01)	Petrol	1108	4	70.00	5
C1E (688.01)	Petrol	1108	4	70.00	6
C1E 688	Petrol	1108	4	70.00	6
C1E 700	Petrol	1108	4	70.00	5
C1E 715	Petrol	1108	4	70.00	5
C1E 720	Petrol	1108	4	70.00	5
C1E 750	Petrol	1108	4	70.00	5
C1E 752	Petrol	1108	4	70.00	5
C1E 754	Petrol	1108	4	70.00	5
C1E 756	Petrol	1108	4	70.00	5
C1E 760	Petrol	1108	4	70.00	5
C1E 762	Petrol	1108	4	70.00	5
C1E 764	Petrol	1108	4	70.00	5
C1E 792	Petrol	1108	4	70.00	5
C1G 702	Petrol	1237	4	71.50	7
C1G 710	Petrol	1237	4	71.50	7
C1G 720	Petrol	1237	4	71.50	7
C1G 722	Petrol	1237	4	71.50	7
C1G 726	Petrol	1237	4	71.50	7
C1G 730	Petrol	1237	4	71.50	7
C1J 700	Petrol	1397	4	76.00	13
C1J 715	Petrol	1397	4	76.00	13
C1J 742	Petrol	1397	4	76.00	13
C1J 760	Petrol	1397	4	76.00	12
C1J 764	Petrol	1397	4	76.00	12
C1J 768	Petrol	1397	4	76.00	13
C1J 770	Petrol	1397	4	76.00	12
C1J 780	Petrol	1397	4	76.00	13
C1J 782	Petrol	1397	4	76.00	12

ENGINE INDEX

Motorverzeichnis • Index de moteur • Índice de Motor
Indeks silnika • Модель двигателя • دليل المحرك



CCM



9

Engine Code	Fuel Type	CCM	x	Valve Train	9
C1J 784	Petrol	1397	4	76.00	12
C1J 788	Petrol	1397	4	76.00	12
C2J 700	Petrol	1397	4	76.00	13
C2J 713	Petrol	1397	4	76.00	13
C2J 717	Petrol	1397	4	76.00	13
C2J 772	Petrol	1397	4	76.00	13
C2J 782	Petrol	1397	4	76.00	13
C2J 784	Petrol	1397	4	76.00	13
C3G 700	Petrol	1239	4	74.00	9
C3G 702	Petrol	1239	4	74.00	9
C3G 710	Petrol	1239	4	74.00	9
C3G 712	Petrol	1239	4	74.00	9
C3G 720	Petrol	1239	4	74.00	9
C3G 750	Petrol	1239	4	74.00	9
C3J 700	Petrol	1397	4	76.00	13
C3J 702	Petrol	1397	4	76.00	13
C3J 710	Petrol	1397	4	76.00	13
C3J 760	Petrol	1397	4	76.00	13
C3J 762	Petrol	1397	4	76.00	13
D4F 702	Petrol	1149	4	69.00	3
D4F 706	Petrol	1149	4	69.00	3
D4F 708	Petrol	1149	4	69.00	3
D4F 712	Petrol	1149	4	69.00	3
D4F 714	Petrol	1149	4	69.00	3
D4F 716	Petrol	1149	4	69.00	3
D4F 722	Petrol	1149	4	69.00	3
D4F 728	Petrol	1149	4	69.00	3
D4F 730	Petrol	1149	4	69.00	3
D4F 732	Petrol	1149	4	69.00	3
D4F 740	Petrol	1149	4	69.00	3
D4F 742	Petrol	1149	4	69.00	3
D4F 764	Petrol	1149	4	69.00	3
D4F 772	Petrol	1149	4	69.00	3
D7F 700	Petrol	1149	4	69.00	4
D7F 701	Petrol	1149	4	69.00	4
D7F 702	Petrol	1149	4	69.00	4
D7F 703	Petrol	1149	4	69.00	4
D7F 704	Petrol	1149	4	69.00	4
D7F 706	Petrol	1149	4	69.00	4
D7F 710	Petrol	1149	4	69.00	4
D7F 720	Petrol	1149	4	69.00	4
D7F 722	Petrol	1149	4	69.00	4
D7F 726	Petrol	1149	4	69.00	4
D7F 730	Petrol	1149	4	69.00	4
D7F 744	Petrol	1149	4	69.00	4
D7F 746	Petrol	1149	4	69.00	4
D7F 764	Petrol	1149	4	69.00	4
D7F 766 Euro 4	Petrol	1149	4	69.00	4
E5F 710	Petrol	1171	4	75.80	11
E5F 716	Petrol	1171	4	75.80	11
E6J 700	Petrol	1390	4	75.80	11
E6J 701	Petrol	1390	4	75.80	11
E6J 706	Petrol	1390	4	75.80	11
E6J 712	Petrol	1390	4	75.80	11
E6J 713	Petrol	1390	4	75.80	11
E6J 718	Petrol	1390	4	75.80	11
E6J 734	Petrol	1390	4	75.80	11
E6J 738	Petrol	1390	4	75.80	11
E6J 760	Petrol	1390	4	75.80	11
E7F 700	Petrol	1171	4	75.80	11

Motorverzeichnis • Index de moteur • Índice de Motor
Indeks silnika • Модель двигателя • دليل المحرك

ENGINE INDEX



CCM

x



9

E7F 704	Petrol	1171	4	75.80	11
E7F 706	Petrol	1171	4	75.80	11
E7F 708	Petrol	1171	4	75.80	11
E7F 730	Petrol	1171	4	75.80	11
E7F 750	Petrol	1171	4	75.80	11
E7J 624	Petrol	1390	4	75.80	11
E7J 626	Petrol	1390	4	75.80	11
E7J 634	Petrol	1390	4	75.80	11
E7J 635	Petrol	1390	4	75.80	11
E7J 718	Petrol	1390	4	75.80	11
E7J 719	Petrol	1390	4	75.80	11
E7J 720	Petrol	1390	4	75.80	11
E7J 724	Petrol	1390	4	75.80	11
E7J 726	Petrol	1390	4	75.80	11
E7J 728	Petrol	1390	4	75.80	11
E7J 742	Petrol	1390	4	75.80	11
E7J 754	Petrol	1390	4	75.80	11
E7J 764	Petrol	1390	4	75.80	11
E7J 773	Petrol	1390	4	75.80	11
E7J 780	Petrol	1390	4	75.80	11
F1N 720	Petrol	1721	4	81.00	25
F1N 722	Petrol	1721	4	81.00	25
F1N 724	Petrol	1721	4	81.00	25
F2N 700	Petrol	1721	4	81.00	25
F2N 704	Petrol	1721	4	81.00	25
F2N 708	Petrol	1721	4	81.00	25
F2N 710	Petrol	1721	4	81.00	25
F2N 711	Petrol	1721	4	81.00	25
F2N 712	Petrol	1721	4	81.00	25
F2N 716	Petrol	1721	4	81.00	25
F2N 720	Petrol	1721	4	81.00	25
F2N 721	Petrol	1721	4	81.00	25
F2N 722	Petrol	1721	4	81.00	25
F2N 724	Petrol	1721	4	81.00	25
F2N 726	Petrol	1721	4	81.00	25
F2N 727	Petrol	1721	4	81.00	25
F2N 728	Petrol	1721	4	81.00	25
F2N 730	Petrol	1721	4	81.00	25
F2N 732	Petrol	1721	4	81.00	25
F2N 740	Petrol	1721	4	81.00	25
F2N 742	Petrol	1721	4	81.00	25
F2N 750	Petrol	1721	4	81.00	25
F2N 752	Petrol	1721	4	81.00	25
F2N 753	Petrol	1721	4	81.00	25
F2N 754	Petrol	1721	4	81.00	25
F2N 758	Petrol	1721	4	81.00	25
F2N 770	Petrol	1721	4	81.00	25
F2N 786	Petrol	1721	4	81.00	25
F2N 796	Petrol	1721	4	81.00	25
F2N 797	Petrol	1721	4	81.00	25
F2N 798	Petrol	1721	4	81.00	25
F3N 702	Petrol	1721	4	81.00	25
F3N 708	Petrol	1721	4	81.00	25
F3N 716	Petrol	1721	4	81.00	25
F3N 717	Petrol	1721	4	81.00	25
F3N 718	Petrol	1721	4	81.00	25
F3N 722	Petrol	1721	4	81.00	25
F3N 723	Petrol	1721	4	81.00	25
F3N 726	Petrol	1721	4	81.00	25
F3N 740	Petrol	1721	4	81.00	25

ENGINE INDEX

Motorverzeichnis • Index de moteur • Índice de Motor
Indeks silnika • Модель двигателя • دليل المحرك



CCM



9

F3N 741	Petrol	1721	4	81.00	25
F3N 742	Petrol	1721	4	81.00	25
F3N 743	Petrol	1721	4	81.00	25
F3N 746	Petrol	1721	4	81.00	25
F3P 670	Petrol	1794	4	82.70	27
F3P 678	Petrol	1794	4	82.70	27
F3P 710	Petrol	1794	4	82.70	27
F3P 712	Petrol	1794	4	82.70	27
F3P 714	Petrol	1794	4	82.70	27
F3P 720	Petrol	1794	4	82.70	27
F3P 724	Petrol	1794	4	82.70	27
F3P 754	Petrol	1794	4	82.70	27
F3P 755	Petrol	1794	4	82.70	27
F3P 758	Petrol	1794	4	82.70	27
F3R 722	Petrol	1998	4	82.70	27
F3R 723	Petrol	1998	4	82.70	27
F3R 728	Petrol	1998	4	82.70	27
F3R 729	Petrol	1998	4	82.70	27
F3R 750	Petrol	1998	4	82.70	27
F7P 700	Petrol	1763	4	82.00	26
F7P 704	Petrol	1763	4	82.00	26
F7P 720	Petrol	1763	4	82.00	26
F7P 722	Petrol	1763	4	82.00	26
F7R 700	Petrol	1998	4	82.70	28
F7R 710	Petrol	1998	4	82.70	28
F7R 714	Petrol	1998	4	82.70	28
F8M 700	Diesel	1595	4	78.00	17
F8M 720	Diesel	1595	4	78.00	17
F8M 730	Diesel	1595	4	78.00	17
F8M 736	Diesel	1595	4	78.00	17
F8M 760	Diesel	1595	4	78.00	17
F8Q 606	Diesel	1870	4	80.00	21
F8Q 610	Diesel	1870	4	80.00	22
F8Q 620	Diesel	1870	4	80.00	21
F8Q 630	Diesel	1870	4	80.00	21
F8Q 632	Diesel	1870	4	80.00	21
F8Q 636	Diesel	1870	4	80.00	21
F8Q 640	Diesel	1870	4	80.00	21
F8Q 644	Diesel	1870	4	80.00	21
F8Q 646	Diesel	1870	4	80.00	21
F8Q 648	Diesel	1870	4	80.00	22
F8Q 662	Diesel	1870	4	80.00	21
F8Q 676	Diesel	1870	4	80.00	21
F8Q 678	Diesel	1870	4	80.00	21
F8Q 682	Diesel	1870	4	80.00	21
F8Q 696	Diesel	1870	4	80.00	21
F8Q 706	Diesel	1870	4	80.00	21
F8Q 710	Diesel	1870	4	80.00	21
F8Q 714	Diesel	1870	4	80.00	21
F8Q 722	Diesel	1870	4	80.00	21
F8Q 724	Diesel	1870	4	80.00	21
F8Q 730	Diesel	1870	4	80.00	21
F8Q 732	Diesel	1870	4	80.00	21
F8Q 740	Diesel	1870	4	80.00	22
F8Q 742	Diesel	1870	4	80.00	21
F8Q 744	Diesel	1870	4	80.00	22
F8Q 764	Diesel	1870	4	80.00	21
F8Q 768	Diesel	1870	4	80.00	22
F8Q 774	Diesel	1870	4	80.00	21
F8Q 776	Diesel	1870	4	80.00	21

Motorverzeichnis • Index de moteur • Índice de Motor
Indeks silnika • Модель двигателя • دليل المحرك

ENGINE INDEX



CCM

x



9

F8Q 784	Diesel	1870	4	80.00	22
F8Q 785	Diesel	1870	4	80.00	22
F8Q 786	Diesel	1870	4	80.00	22
F9Q 650	Diesel	1870	4	80.00	23
F9Q 664	Diesel	1870	4	80.00	23
F9Q 670	Diesel	1870	4	80.00	23
F9Q 674	Diesel	1870	4	80.00	23
F9Q 710	Diesel	1870	4	80.00	24
F9Q 717	Diesel	1870	4	80.00	24
F9Q 718	Diesel	1870	4	80.00	24
F9Q 730	Diesel	1870	4	80.00	24
F9Q 732	Diesel	1870	4	80.00	24
F9Q 733	Diesel	1870	4	80.00	24
F9Q 734	Diesel	1870	4	80.00	24
F9Q 736	Diesel	1870	4	80.00	24
F9Q 738	Diesel	1870	4	80.00	24
F9Q 740	Diesel	1870	4	80.00	24
F9Q 744	Diesel	1870	4	80.00	24
F9Q 748	Diesel	1870	4	80.00	24
F9Q 750	Diesel	1870	4	80.00	23
F9Q 752	Diesel	1870	4	80.00	24
F9Q 754	Diesel	1870	4	80.00	24
F9Q 756	Diesel	1870	4	80.00	23
F9Q 758	Diesel	1870	4	80.00	23
F9Q 759	Diesel	1870	4	80.00	23
F9Q 760	Diesel	1870	4	80.00	24
F9Q 762	Diesel	1870	4	80.00	24
F9Q 770	Diesel	1870	4	80.00	24
F9Q 772	Diesel	1870	4	80.00	24
F9Q 774	Diesel	1870	4	80.00	24
F9Q 780	Diesel	1870	4	80.00	24
F9Q 782	Diesel	1870	4	80.00	24
F9Q 790	Diesel	1870	4	80.00	24
F9Q 800	Diesel	1870	4	80.00	23
F9Q 808	Diesel	1870	4	80.00	23
F9Q 812	Diesel	1870	4	80.00	23
F9Q 816	Diesel	1870	4	80.00	23
F9Q 818	Diesel	1870	4	80.00	23
F9Q 820	Diesel	1870	4	80.00	23
F9Q 826	Diesel	1870	4	80.00	23
G8T 706	Diesel	2188	4	87.00	35
G8T 714	Petrol	2188	4	87.00	36
G8T 716	Petrol	2188	4	87.00	36
G8T 740	Petrol	2188	4	87.00	36
G8T 752	Diesel	2188	4	87.00	35
G8T 760	Petrol	2188	4	87.00	36
G8T 790	Diesel	2188	4	87.00	35
G8T 792	Diesel	2188	4	87.00	35
G8T 794	Diesel	2188	4	87.00	35
G9T 600 Euro 4	Diesel	2188	4	87.00	37
G9T 605 Euro 4	Diesel	2188	4	87.00	37
G9T 606 Euro 4	Diesel	2188	4	87.00	37
G9T 607	Diesel	2188	4	87.00	37
G9T 642	Diesel	2188	4	87.00	37
G9T 645 Euro 4	Diesel	2188	4	87.00	37
G9T 700	Diesel	2188	4	87.00	37
G9T 702	Diesel	2188	4	87.00	37
G9T 703	Diesel	2188	4	87.00	37
G9T 704	Diesel	2188	4	87.00	37
G9T 706	Diesel	2188	4	87.00	37

ENGINE INDEX

Motorverzeichnis • Index de moteur • Índice de Motor
Indeks silnika • Модель двигателя • دليل المحرك



CCM



9

G9T 707	Diesel	2188	4	87.00	37
G9T 710	Diesel	2188	4	87.00	37
G9T 712	Diesel	2188	4	87.00	37
G9T 720	Diesel	2188	4	87.00	37
G9T 722	Diesel	2188	4	87.00	37
G9T 742	Diesel	2188	4	87.00	37
G9T 743	Diesel	2188	4	87.00	37
G9T 750	Diesel	2188	4	87.00	37
G9U 630 Euro 4	Diesel	2464	4	89.00	42
G9U 632 Euro 4	Diesel	2464	4	89.00	42
G9U 650 Euro 4	Diesel	2464	4	89.00	42
G9U 720 Euro 3	Diesel	2463	4	89.00	43
G9U 724 Euro 3	Diesel	2463	4	89.00	43
G9U 730 Euro 3	Diesel	2464	4	89.00	43
G9U 750 Euro 3	Diesel	2463	4	89.00	43
G9U 754 Euro 3	Diesel	2463	4	89.00	43
J5R 716	Petrol	1995	4	88.00	40
J5R 718	Petrol	1995	4	88.00	40
J5R 722	Petrol	1995	4	88.00	40
J5R 726	Petrol	1995	4	88.00	40
J5R 728	Petrol	1995	4	88.00	40
J6R 234	Petrol	1995	4	88.00	40
J6R 236	Petrol	1995	4	88.00	40
J6R 706	Petrol	1995	4	88.00	40
J6R 707	Petrol	1995	4	88.00	40
J6R 710	Petrol	1995	4	88.00	40
J6R 712	Petrol	1995	4	88.00	40
J6R 713	Petrol	1995	4	88.00	40
J6R 715	Petrol	1995	4	88.00	40
J6R 716	Petrol	1995	4	88.00	40
J6R 758	Petrol	1995	4	88.00	40
J6R 759	Petrol	1995	4	88.00	40
J6R 760	Petrol	1995	4	88.00	40
J6R 762	Petrol	1995	4	88.00	40
J6R 792	Petrol	1995	4	88.00	40
J6R 793	Petrol	1995	4	88.00	40
J7R 722	Petrol	1995	4	88.00	40
J7R 723	Petrol	1995	4	88.00	40
J7R 740	Petrol	1995	4	88.00	40
J7R 746	Petrol	1995	4	88.00	40
J7R 747	Petrol	1995	4	88.00	40
J7R 751	Petrol	1995	4	88.00	40
J7R 752	Petrol	1995	4	88.00	40
J7R 756	Petrol	1995	4	88.00	41
J7R 760	Petrol	1995	4	88.00	40
J7R 768	Petrol	1995	4	88.00	40
J7T 600	Petrol	2165	4	88.00	41
J7T 706	Petrol	2165	4	88.00	40
J7T 714	Petrol	2165	4	88.00	40
J7T 715	Petrol	2165	4	88.00	40
J7T 730	Petrol	2165	4	88.00	40
J7T 731	Petrol	2165	4	88.00	40
J7T 732	Petrol	2165	4	88.00	40
J7T 733	Petrol	2165	4	88.00	40
J7T 754	Petrol	2165	4	88.00	40
J7T 755	Petrol	2165	4	88.00	40
J7T 760	Petrol	2165	4	88.00	41
J7T 761	Petrol	2165	4	88.00	41
J7T 762	Petrol	2165	4	88.00	41
J7T 770	Petrol	2165	4	88.00	40

Motorverzeichnis • Index de moteur • Índice de Motor
Indeks silnika • Модель двигателя • دليل المحرك

ENGINE INDEX



CCM

x



9

J7T 772	Petrol	2165	4	88.00	41
J7T 776	Petrol	2165	4	88.00	41
J7T 780	Petrol	2165	4	88.00	40
J7T 782	Petrol	2165	4	88.00	40
J8S 120	Diesel	2068	4	86.00	33
J8S 232 (852.232)	Diesel	2068	4	86.00	33
J8S 234	Diesel	2068	4	86.00	33
J8S 240	Diesel	2068	4	86.00	33
J8S 330	Diesel	2068	4	86.00	34
J8S 600	Diesel	2068	4	86.00	34
J8S 604	Diesel	2068	4	86.00	33
J8S 610	Diesel	2068	4	86.00	33
J8S 612	Diesel	2068	4	86.00	33
J8S 702	Diesel	2068	4	86.00	33
J8S 704	Diesel	2068	4	86.00	34
J8S 706	Diesel	2068	4	86.00	34
J8S 708	Diesel	2068	4	86.00	33
J8S 712	Diesel	2068	4	86.00	34
J8S 714	Diesel	2068	4	86.00	33
J8S 736	Diesel	2068	4	86.00	34
J8S 738	Diesel	2068	4	86.00	33
J8S 740	Diesel	2068	4	86.00	34
J8S 742	Diesel	2068	4	86.00	33
J8S 746	Diesel	2068	4	86.00	33
J8S 758	Diesel	2068	4	86.00	34
J8S 760	Diesel	2068	4	86.00	33
J8S 772	Diesel	2068	4	86.00	33
J8S 774	Diesel	2068	4	86.00	33
J8S 776	Diesel	2068	4	86.00	33
J8S 778	Diesel	2068	4	86.00	33
J8S 784	Diesel	2068	4	86.00	34
J8S 786 (KAT)	Diesel	2068	4	86.00	33
J8S 788	Diesel	2068	4	86.00	33
J8S 814	Diesel	2068	4	86.00	33
J8S 852	Diesel	2068	4	86.00	34
J8S 890	Diesel	2068	4	86.00	33
K4J 700	Petrol	1390	4	79.50	19
K4J 710 Euro 4	Petrol	1390	4	79.50	19
K4J 711 Euro 4	Petrol	1390	4	79.50	19
K4J 712	Petrol	1390	4	79.50	19
K4J 713	Petrol	1390	4	79.50	19
K4J 714	Petrol	1390	4	79.50	19
K4J 715	Petrol	1390	4	79.50	19
K4J 730	Petrol	1390	4	79.50	19
K4J 732	Petrol	1390	4	79.50	19
K4J 740	Petrol	1390	4	79.50	19
K4J 750	Petrol	1390	4	79.50	19
K4J 770	Petrol	1390	4	79.50	19
K4J 780	Petrol	1390	4	79.50	19
K4J D 740	Petrol	1390	4	79.50	19
K4M 690	Petrol	1598	4	79.50	19
K4M 697	Petrol	1598	4	79.50	19
K4M 698	Petrol	1598	4	79.50	19
K4M 700	Petrol	1598	4	79.50	19
K4M 701	Petrol	1598	4	79.50	19
K4M 704	Petrol	1598	4	79.50	19
K4M 706	Petrol	1598	4	79.50	19
K4M 708	Petrol	1598	4	79.50	19
K4M 709	Petrol	1598	4	79.50	19
K4M 710	Petrol	1598	4	79.50	19

ENGINE INDEX

Motorverzeichnis • Index de moteur • Índice de Motor
Indeks silnika • Модель двигателя • دليل المحرك



CCM



9

K4M 711	Petrol	1598	4	79.50	19
K4M 712	Petrol	1598	4	79.50	19
K4M 714	Petrol	1598	4	79.50	19
K4M 716	Petrol	1598	4	79.50	19
K4M 720	Petrol	1598	4	79.50	19
K4M 724	Petrol	1598	4	79.50	19
K4M 730	Petrol	1598	4	79.50	19
K4M 732	Petrol	1598	4	79.50	19
K4M 734	Petrol	1598	4	79.50	19
K4M 736	Petrol	1598	4	79.50	19
K4M 740	Petrol	1598	4	79.50	19
K4M 742	Petrol	1598	4	79.50	19
K4M 743	Petrol	1598	4	79.50	19
K4M 744 Euro 4	Petrol	1598	4	79.50	19
K4M 745	Petrol	1598	4	79.50	19
K4M 748	Petrol	1598	4	79.50	19
K4M 752	Petrol	1598	4	79.50	19
K4M 753	Petrol	1598	4	79.50	19
K4M 760	Petrol	1598	4	79.50	19
K4M 790	Petrol	1598	4	79.50	19
K4M 830 Euro 4	Petrol	1598	4	79.50	20
K4M 831 Euro 4	Petrol	1598	4	79.50	20
K4M 834 Euro 4	Gas	1598	4	79.50	20
K4M D 812	Petrol	1598	4	79.50	19
K7J	Petrol	1390	4	79.50	20
K7J 710	Petrol	1390	4	79.50	20
K7M 702	Petrol	1598	4	79.50	20
K7M 703	Petrol	1598	4	79.50	20
K7M 710	Petrol	1598	4	79.50	20
K7M 720	Petrol	1598	4	79.50	20
K7M 744	Petrol	1598	4	79.50	20
K7M 745	Petrol	1598	4	79.50	20
K7M 746	Petrol	1598	4	79.50	20
K7M 790	Petrol	1598	4	79.50	20
K9K 608	Diesel	1461	4	76.00	14
K9K 612	Diesel	1461	4	76.00	14
K9K 636 Euro 5	Diesel	1461	4	76.00	14
K9K 700 Euro 3	Diesel	1461	4	76.00	15
K9K 702 Euro 3	Diesel	1461	4	76.00	15
K9K 704 Euro 3	Diesel	1461	4	76.00	15
K9K 706	Diesel	1461	4	76.00	15
K9K 708	Diesel	1461	4	76.00	15
K9K 710 Euro 3	Diesel	1461	4	76.00	15
K9K 712 Euro 3	Diesel	1461	4	76.00	15
K9K 714 Euro 4	Diesel	1461	4	76.00	15
K9K 716	Diesel	1461	4	76.00	14
K9K 718 Euro 4	Diesel	1461	4	76.00	15
K9K 722 Euro 3	Diesel	1461	4	76.00	15
K9K 724 Euro 4	Diesel	1461	4	76.00	15
K9K 728 Euro 3	Diesel	1461	4	76.00	15
K9K 729 Euro 3	Diesel	1461	4	76.00	15
K9K 732 Euro 4	Diesel	1461	4	76.00	14
K9K 740 Euro 4	Diesel	1461	4	76.00	15
K9K 750 Euro 3	Diesel	1461	4	76.00	15
K9K 752 Euro 3	Diesel	1461	4	76.00	15
K9K 760 Euro 4	Diesel	1461	4	76.00	15
K9K 762 Euro 4	Diesel	1461	4	76.00	15
K9K 764 Euro 4	Diesel	1461	4	76.00	14
K9K 766 Euro 4	Diesel	1461	4	76.00	15
K9K 768 Euro 4	Diesel	1461	4	76.00	15

Motorverzeichnis • Index de moteur • Índice de Motor
Indeks silnika • Модель двигателя • دليل المحرك

ENGINE INDEX



CCM

x



9

K9K 770	Diesel	1461	4	76.00	14
K9K 772	Diesel	1461	4	76.00	14
K9K 780 Euro 4	Diesel	1461	4	76.00	14
K9K 782	Diesel	1461	4	76.00	14
K9K 790	Diesel	1461	4	76.00	15
K9K 792	Diesel	1461	4	76.00	15
K9K 794	Diesel	1461	4	76.00	15
K9K 796	Diesel	1461	4	76.00	15
K9K 800	Diesel	1461	4	76.00	14
K9K 802 Euro 4	Diesel	1461	4	76.00	15
K9K 804 Euro 4	Diesel	1461	4	76.00	14
K9K 806 Euro 4 (FAP)	Diesel	1461	4	76.00	14
K9K 808	Diesel	1461	4	76.00	14
K9K 812	Diesel	1461	4	76.00	14
K9K 820	Diesel	1461	4	76.00	14
K9K 830	Diesel	1461	4	76.00	14
K9K 832 Euro 4	Diesel	1461	4	76.00	14
K9K 834	Diesel	1461	4	76.00	14
K9K 836	Diesel	1461	4	76.00	14
K9K 837 Euro 5	Diesel	1461	4	76.00	14
K9K 840	Diesel	1461	4	76.00	14
K9K 846 Euro 5	Diesel	1461	4	76.00	14
K9K 884 Euro 5	Diesel	1461	4	76.00	14
K9K F 830	Diesel	1461	4	76.00	14
K9K G 724	Diesel	1461	4	76.00	15
K9K G 832	Diesel	1461	4	76.00	14
K9K H 834	Diesel	1461	4	76.00	14
K9K J 836	Diesel	1461	4	76.00	14
K9K N 837	Diesel	1461	4	76.00	14
K9K P 732	Diesel	1461	4	76.00	14
L7X 700	Petrol	2946	V6	87.00	38
L7X 701	Petrol	2946	V6	87.00	38
L7X 713	Petrol	2946	6	87.00	38
M9R 610	Diesel	1995	4	84.00	30
M9R 615	Diesel	1995	4	84.00	30
M9R 700	Diesel	1995	4	84.00	30
M9R 721	Diesel	1995	4	84.00	30
M9R 722	Diesel	1995	4	84.00	30
M9R 724	Diesel	1995	4	84.00	30
M9R 740	Diesel	1995	4	84.00	30
M9R 742	Diesel	1995	4	84.00	30
M9R 744	Diesel	1995	4	84.00	30
M9R 746	Diesel	1995	4	84.00	30
M9R 748	Diesel	1995	4	84.00	30
M9R 750	Diesel	1995	4	84.00	30
M9R 760	Diesel	1995	4	84.00	30
M9R 761	Diesel	1995	4	84.00	30
M9R 762	Diesel	1995	4	84.00	30
M9R 763	Diesel	1995	4	84.00	30
M9R 780 Euro 4	Diesel	1995	4	84.00	30
M9R 782	Diesel	1995	4	84.00	30
M9R 786 Euro 4	Diesel	1995	4	84.00	30
M9R 800	Diesel	1995	4	84.00	30
M9R 802	Diesel	1995	4	84.00	30
M9R 809	Diesel	1995	4	84.00	30
M9R 816	Diesel	1995	4	84.00	30
M9R 830	Diesel	1995	4	84.00	30
M9R 832	Diesel	1995	4	84.00	30
M9R A 700 Euro 4	Diesel	1995	4	84.00	30
M9R B 721 Euro 4	Diesel	1995	4	84.00	30

ENGINE INDEX

Motorverzeichnis • Index de moteur • Índice de Motor
Indeks silnika • Модель двигателя • دليل المحرك



CCM

x



9

M9Ra 742 Euro 4	Diesel	1995	4	84.00	30
M9T 670 Euro 5	Diesel	2298	4	85.00	31
M9T 672 Euro 5	Diesel	2298	4	85.00	31
M9T 676 Euro 4	Diesel	2298	4	85.00	31
M9T 678	Diesel	2298	4	85.00	31
M9T 680	Diesel	2298	4	85.00	31
M9T 686 Euro 5	Diesel	2298	4	85.00	31
M9T 690 Euro 5	Diesel	2298	4	85.00	31
M9T 692 Euro 4	Diesel	2298	4	85.00	31
M9T 694 Euro 4	Diesel	2298	4	85.00	31
M9T 696 Euro 4	Diesel	2298	4	85.00	31
M9T 698 Euro 5	Diesel	2298	4	85.00	31
N7Q 700	Petrol	1948	4	83.00	29
N7Q 704	Petrol	1948	4	83.00	29
N7Q 710	Petrol	1948	4	83.00	29
N7Q 711	Petrol	1948	4	83.00	29
S8U 720	Diesel	2445	4	93.00	49
S8U 722	Diesel	2445	4	93.00	49
S8U 730	Diesel	2445	4	93.00	49
S8U 731	Diesel	2445	4	93.00	49
S8U 742	Diesel	2499	4	93.00	50
S8U 748	Diesel	2445	4	93.00	49
S8U 750	Diesel	2499	4	93.00	50
S8U 752	Diesel	2499	4	93.00	50
S8U 758	Diesel	2499	4	93.00	50
S8U 780	Diesel	2499	4	93.00	50
S9U 714	Diesel	2499	4	93.00	48
S9W 700/S9W 702	Diesel	2799	4	94.40	51
X5J	Petrol	1360	4	75.00	10
Z7U 700	Petrol	2458	6	91.00	44
Z7U 702	Petrol	2458	6	91.00	44
Z7V 708	Petrol	2664	6	88.00	39
Z7V 709	Petrol	2664	6	88.00	39
Z7V 711	Petrol	2664	6	88.00	39
Z7V-140	Petrol	2664	V6	88.00	39
Z7W 700	Petrol	2849	6	91.00	45
Z7W 702	Petrol	2849	6	91.00	45
Z7W 706	Petrol	2849	6	91.00	45
Z7W 707	Petrol	2849	6	91.00	45



4.0.8 Dauphine		10/62→09/83 01/56→12/69	670.800	4cyl. 845cc	19-26kW (26-35PS)	1	TD22489
4 0.8		10/62→09/83	800	4cyl. 847cc	27kW (37PS)		TD3023
4 0.8 4 Box 0.8 Rodeo 4 0.8		09/71→12/88 09/66→12/88 08/71→11/81	800 01	4cyl. 845cc	25kW (34PS)		TD3024
4 0.8			800 05	4cyl. 845cc	22-25kW (30-34PS)		TD3025
4 0.8 4 Box 0.8		10/62→10/88 04/83→07/89	800 705	4cyl. 845cc	27kW (37PS)		TD4852
5 0.8 5 Box 0.8		10/72→12/84 10/72→08/84	800 710	4cyl. 845cc	27kW (37PS)		TD3028
6 0.8 Rodeo 6 0.8		10/69→04/80 05/70→08/73	800.02	4cyl. 845cc	21-26kW (29-35PS)		TD21383
4 0.8 4 Box 0.8		10/83→10/88 04/83→07/89	B1B 707	4cyl. 845cc	21kW (29PS)		TD4855
08-331600-10 →01/1969 [R66180]	STD	58.00	2.000		001 IF CR P		IKA
			2.000		023 P		STD
			3.500		231		STD
08-333300-00 01/1969→ [R66210]	STD	58.00	1.750		001 IF CR P		STD
			2.000		026 P		STD
			3.500		036 P		STD
4 1.0 5 1.0, 5 Box 1.0		12/85→06/93 01/72→12/85	689 710	4cyl. 956cc	32kW (44PS)	2	TD3017
R8 1.0		07/65→10/72	689.01	4cyl. 956cc	29kW (39PS)		TD21063
Super 5 1.0, Super 5 Box 1.0		10/84→10/88	C1C 700	4cyl. 956cc	30kW (41PS)		TD3097





Rapid Box 1.0		09/85→05/92	C1C 706	4cyl. 956cc	27-30kW (37-42PS)	TD3098
4 1.0		06/87→06/93	C1C 708	4cyl. 956cc	25kW (34PS)	TD3099
4 Box 1.0		06/87→12/93				
Express 1.0		03/86→08/91	C1C 754	4cyl. 956cc	24kW (33PS)	TD22353
08-334000-00	STD	65.00	1.750		001 IF CR P	STD
[R66240]			2.000		026 P	STD
			3.500		712 CR	ST
Twingo I 1.2 16V		01/01→	D4F 702	4cyl. 1149cc	55kW (75PS)	3 TD16272
			D4F 704	4cyl. 1149cc	55kW (75PS)	TD16273
Clio II 1.2 16V		06/06→	D4F 706	4cyl. 1149cc	55kW (75PS)	TD21205
Clio II 1.2 16V		01/06→				
Twingo I 1.2 16V		04/08→	D4F 708	4cyl. 1149cc	44kW (60PS)	TD19014
Clio II 1.2 16V		06/06→	D4F 712	4cyl. 1149cc	55kW (75PS)	TD16186
Clio II 1.2 16V		01/06→				
Kangoo 1.2 16V		01/06→				
Kangoo Express 1.2 16V		01/10→				
Thalia I 1.2 16V		02/04→				
Clio II 1.2 16V		01/06→	D4F 714	4cyl. 1149cc	55kW (75PS)	TD16187
Kangoo 1.2 16V		01/06→				
Kangoo Express 1.2 16V		01/10→				
Kangoo 1.2 16V		01/06→	D4F 716	4cyl. 1149cc	55kW (75PS)	TD17270
Clio II 1.2 16V		01/06→	D4F 722	4cyl. 1149cc	55kW (75PS)	TD19671
Clio II 1.2 16V		01/06→	D4F 728	4cyl. 1149cc	55kW (75PS)	TD21206
Thalia II 1.2 16V		08/09→				





Kangoo Express 1.2 16V		01/10→	D4F 730	4cyl. 1149cc	55kW (75PS)	TD21207
Sandero		11/08→	D4F 732	4cyl. 1149cc	55kW (75PS)	TD23528
Clio Grandtour 1.2 16V Hi-Flex		08/07→	D4F 740	4cyl. 1149cc	55kW (75PS)	TD18421
Clio Grandtour 1.2 16V		08/02→		4cyl. 1149cc	55kW (75PS)	
Clio Grandtour IV 1.2 16V		13/01→		4cyl. 1149cc	55kW (75PS)	
Clio III 1.2 16V Hi-Flex		08/07→		4cyl. 1149cc	55kW (75PS)	
Clio III 1.2 16V		05/06→		4cyl. 1149cc	55kW (75PS)	
Clio III 1.2 16V		05/06→		4cyl. 1149cc	55kW (75PS)	
Clio IV 1.2 16V		12/11→		4cyl. 1149cc	55kW (75PS)	
Modus / Grand Modus 1.2		05/05→		4cyl. 1149cc	55kW (75PS)	
Modus / Grand Modus 1.2		04/12→		4cyl. 1149cc	55kW (75PS)	
Modus / Grand Modus 1.2 16V Hi-Flex		08/10→		4cyl. 1149cc	55kW (75PS)	
Clio III 1.2 16V Hi-Flex		08/07→	D4F 742	4cyl. 1149cc	55kW (75PS)	TD24895
Clio Grandtour 1.2 16V		08/02→	D4F 764	4cyl. 1149cc	57kW (77PS)	TD18530
Clio III 1.2		05/10→		4cyl. 1149cc	57kW (77PS)	
Clio III 1.2 16V		05/06→		4cyl. 1149cc	57kW (77PS)	
Modus / Grand Modus 1.2		04/12→		4cyl. 1149cc	57kW (77PS)	
Twingo II 1.2 16V		07/03→		4cyl. 1149cc	57kW (77PS)	
Twingo II 1.2 16V		07/03→	D4F 772	4cyl. 1149cc	56kW (76PS)	TD20444
08-450000-00	STD	69.00	1.200		001 NT	ST
08-450007-00	0.50mm		1.500		005 IFU P	STD
			2.500		712 CR	ST
Twingo 1.2, Twingo Box 1.2		05/96→	D7F 700	4cyl. 1149cc	44kW (60PS)	4 TD5520
Twingo 1.2, Twingo Box 1.2		05/96→	D7F 701	4cyl. 1149cc	44kW (60PS)	TD5521
Twingo 1.2		05/96→	D7F 702	4cyl. 1149cc	44kW (60PS)	TD16274
Twingo 1.2 LPG		10/03→		4cyl. 1149cc	44kW (60PS)	
Twingo Box 1.2		05/96→		4cyl. 1149cc	44kW (60PS)	
Twingo 1.2, Twingo Box 1.2		05/96→	D7F 703	4cyl. 1149cc	43kW (58PS)	TD16275
Twingo 1.2, Twingo Box 1.2		05/96→	D7F 704	4cyl. 1149cc	43-44kW (58-60PS)	TD16276





Twingo Box 1.2	05/96→	D7F 706	4cyl. 1149cc	43kW (58PS)	TD18178
Kangoo 1.2, Kangoo Express 1.2 Kangoo Express 1.2 BiFuel	08/97→ 07/98→07/01	D7F 710	4cyl. 1149cc	44kW (60PS)	TD9624
Clio II 1.2, Clio II Box 1.1 Kangoo 1.2, Kangoo Express 1.2	09/98→ 08/97→	D7F 720	4cyl. 1149cc	44kW (60PS)	TD14328
Clio II 1.2 Clio II Box 1.2 Kangoo 1.2, Kangoo Express 1.2	03/99→05/01 03/99→10/03 08/97→	D7F 722	4cyl. 1149cc	44kW (60PS)	TD16326
Clio II 1.2, Clio II Box 1.1 Clio II Box 1.2 Kangoo 1.2, Kangoo Express 1.2	09/98→ 03/99→10/03 08/97→	D7F 726	4cyl. 1149cc	44kW (60PS)	TD14329
Clio I 1.2	01/96→09/98	D7F 730	4cyl. 1149cc	44kW (60PS)	TD5522
Kangoo 1.2, Kangoo Express 1.2 Kangoo Express 1.2 BiFuel Thalia 1.2	08/97→ 07/98→07/01 02/98→10/03	D7F 744	4cyl. 1149cc	43kW (58PS)	TD17266
Clio II 1.2, Clio II Box 1.1 Clio II Box 1.2 Kangoo 1.2, Kangoo Express 1.2 Thalia 1.2	09/98→ 03/99→10/03 08/97→ 02/98→10/03	D7F 746	4cyl. 1149cc	43kW (58PS)	TD17267
Clio II 1.2 Clio II 1.2 LPG Kangoo Express 1.2	09/98→ 09/98→06/09 07/98→07/01	D7F 764	4cyl. 1149cc	43kW (58PS)	TD20903
Clio II 1.2 Clio II 1.2 LPG Kangoo Express 1.2	09/98→ 09/98→06/09 07/98→07/01	D7F 766 Euro 4	4cyl. 1149cc	43kW (58PS)	TD19670

08-104100-00	STD	69.00	1.500		001 IF CR P	KV1
08-104105-00	0.25mm		1.500		005 IFU P	STD
08-104107-00	0.50mm		2.500		231 CR P	STD
[R60510]						

R8 1.1	02/69→01/75	688 02	4cyl. 1108cc	41kW (55PS)	5 TD3012
R6 1.1	08/70→04/87	688 03	4cyl. 1108cc	25-39kW (34-53PS)	TD22492





6 1.1 Rodeo 6 1.1	08/70→04/87 08/73→11/81	688 10	4cyl. 1108cc	25-39kW (34-53PS)	TD21382
4 Box 1.1	10/76→07/89	688 11	4cyl. 1108cc	33kW (45PS)	TD3014
4 1.1 4 Box 1.1 Rodeo 5 1.1	02/78→06/90 10/76→07/89 11/81→12/87	688 12	4cyl. 1108cc	25kW (34PS)	TD3015
5 1.1, 5 Box 1.1	09/80→12/85	688 13	4cyl. 1108cc	33kW (45PS)	TD3013
R5 1.1 R6 1.1	10/79→03/85 09/80→03/86	688 13	4cyl. 1108cc	33kW (45PS)	TD23801
R4 1.1	10/82→12/93	688.11	4cyl. 1108cc	25-39kW (34-53PS)	TD28180
8 1.1 10 1.1 Estafette 1.1	11/62→10/72 05/66→10/72 02/62→12/81	C1E (688.01)	4cyl. 1108cc	25-39kW (34-53PS)	TD22490
Clio I 1.1, Clio I Box 1.1	01/91→09/98	C1E 700	4cyl. 1108cc	35kW (47PS)	TD3100
9 1.1 11 1.1, 11 Box 1.1	09/81→05/87 03/83→06/86	C1E 715	4cyl. 1108cc	35kW (47PS)	TD3102
9 1.1 11 1.1, 11 Box 1.1	09/81→05/87 03/83→06/86	C1E 720	4cyl. 1108cc	35kW (47PS)	TD3105
Rapid Box 1.1 Super 5 1.1 Super 5 Box 1.1	07/85→04/95 10/84→03/95 10/84→12/96	C1E 750	4cyl. 1108cc	33-34kW (45-46PS)	TD3106
Rapid Box 1.1 Super 5 1.1 Super 5 Box 1.1	07/85→04/95 10/84→03/95 10/84→12/96	C1E 752	4cyl. 1108cc	33-34kW (45-46PS)	TD3107
Rapid Box 1.1 Super 5 1.1 Super 5 Box 1.1	07/85→04/95 10/84→10/88 10/84→12/96	C1E 754	4cyl. 1108cc	33-34kW (45-46PS)	TD3108
Rapid Box 1.1 Super 5 1.1	06/87→09/91 01/86→03/95	C1E 756	4cyl. 1108cc	33kW (45PS)	TD3109





Rapid Box 1.1		07/85→04/95	C1E 760	4cyl.	1108cc	33kW (45PS)	TD3110
Super 5 1.1		01/86→03/95					
Rapid Box 1.1		07/85→04/95	C1E 762	4cyl.	1108cc	33-36kW (45-49PS)	TD3111
Express 1.1		09/91→10/97	C1E 764	4cyl.	1108cc	36kW (49PS)	TD3112
Rapid Box 1.1		07/85→04/95	C1E 792	4cyl.	1108cc	33kW (45PS)	TD3113
08-334600-00	STD	70.00	1.750		001 IF CR P	IKA	
[R66160]			2.000		026 P	STD	
			3.500		712 CR	ST	
R6, R8, R10		01/62→12/68	C1E (688.01)	4cyl.	1108cc	25-39kW (34-53PS)	6 FM4911
Express 1.1		03/86→07/90	C1E 688	4cyl.	1108cc	25kW (34PS)	TD24999
08-332200-00	STD	70.00	2.000		001 IF CR P	IKA	
[R66150]			2.000		026 P	STD	
			3.500		712 CR	ST	
Super 5 1.2		01/87→08/90	C1G 702	4cyl.	1237cc	40kW (54PS)	7 TD3115
Super 5 Box 1.2		01/87→12/96					
9 1.2		09/85→12/88	C1G 710	4cyl.	1237cc	40kW (54PS)	TD3116
11 1.2, 11 Box 1.2		10/84→12/88					
Super 5 1.2		01/87→08/90	C1G 720	4cyl.	1237cc	40kW (54PS)	TD3117
Super 5 1.2		01/87→08/90	C1G 722	4cyl.	1237cc	40kW (54PS)	TD3118
Rapid Box 1.2		09/91→08/93	C1G 726	4cyl.	1237cc	40kW (54PS)	TD3119





19 I 1.2, 19 I Box 1.2, 19 I Chamade 1.2		01/88→12/92	C1G 730				
19 II 1.2		04/92→12/95			4cyl.		
19 II Box 1.2		03/92→12/95			1237cc	40kW (54PS)	TD3120
08-105000-00	STD	71.50	1.750		001 CR P		KV1
			2.000		005 IFU P		STD
			4.000		231 CR P		STD
08-335500-00	STD	71.50	1.750		001 IF CR P		IKA
			2.000		026 P		STD
			4.000		712 CR		ST
[R66170]							
Estafette 1.3		08/69→12/81	810.01		4cyl.		8
					1289cc	26-32kW (37-44PS)	TD8555
12 1.3, 12 Box 1.3, 12 Variable 1.3		07/75→04/80	810.02		4cyl.		
					1289cc	37kW (50PS)	TD3033
12 1.3		10/69→08/80	810.02/97		4cyl.		
12 Variable 1.3		10/70→08/80			1289cc	40kW (54PS)	TD3032
10 1.3		07/69→10/72	810.03		4cyl.		
					1289cc	35kW (47PS)	TD23613
12 1.3 TS		08/72→08/80	810.05		4cyl.		
12 Variable 1.3		08/73→08/80			1289cc	31-45kW (42-61PS)	TD21386
15 1.3		03/72→10/80					
12 1.3 TS		08/72→08/80	810.06		4cyl.		
12 Variable 1.3		08/73→08/80			1289cc	44kW (60PS)	TD3034
R11 1.3		01/74→01/80	810.10		4cyl.		
					1289cc	44kW (60PS)	TD21387
5 1.3		06/79→09/84	810.19		4cyl.		
					1289cc	33kW (45PS)	TD3035
5 1.3		09/75→09/84	810.25		4cyl.		
					1289cc	40kW (54PS)	TD3036
5 1.3		09/75→09/84	810.25		4cyl.		
					1289cc	31-50kW (42-68PS)	TD22391







5 1.3	09/76→09/79	810.26			
5 Box 1.3	03/76→08/82		4cyl.		
Rodeo 5 1.3	07/81→02/84		1289cc	32kW (44PS)	
					TD3037

5 1.3	09/76→09/79	810.26			
5 Box 1.3	03/76→08/82		4cyl.		
Rodeo 5 1.3	07/81→02/84		1289cc	31-50kW (42-68PS)	
					TD22392

5 1.3 Automatik	06/79→09/84	810.29			
			4cyl.		
			1289cc	40kW (54PS)	
					TD3038

5 1.3	09/76→09/79	810.96			
5 Box 1.3	03/76→08/82		4cyl.		
Rodeo 5 1.3	07/81→02/84		1289cc	49kW (67PS)	
					TD3039

5 1.3	09/76→09/79	810.97			
5 Box 1.3	03/76→08/82		4cyl.		
Rodeo 5 1.3	07/81→02/84		1289cc	41kW (55PS)	
					TD3040

08-333400-10	STD	73.00	1.750		001 IF CR P	IKA
[R66220]			2.000		026 P	STD
			4.000		712 CR	ST

Twingo 1.2	03/93→10/96	C3G 700				9
Twingo Box 1.2	03/93→05/96		4cyl.			
			1239cc	40kW (54PS)		
					TD3172	



Twingo 1.2	03/93→10/96	C3G 702				
Twingo Box 1.2	03/93→05/96		4cyl.			
			1239cc	40kW (54PS)		
					TD5515	

Rapid Box 1.2	09/91→03/98	C3G 710				
			4cyl.			
			1239cc	40kW (54PS)		
					TD3173	

Rapid Box 1.2	09/91→03/98	C3G 712				
			4cyl.			
			1239cc	40kW (54PS)		
					TD16545	

Clio I 1.2	01/96→12/96	C3G 720				
Clio I Box 1.2	06/94→02/98		4cyl.			
			1239cc	40kW (54PS)		
					TD14314	

Clio I 1.2	01/96→12/96	C3G 750				
Clio I Box 1.2	06/94→02/98		4cyl.			
			1239cc	40kW (54PS)		
					TD22356	

08-337300-00	STD	74.00	1.500		001 CR P	IKA
[R60460]			1.750		005 IFU P	STD
			3.000		236 P	STD



14 1.2		05/76→12/83	129		4cyl. 1218cc	42-43kW (57-58PS)	10	
								TD3007
14 1.4		09/79→06/83	150		4cyl. 1360cc	51-52kW (70-71PS)		TD3008
14 1.4		12/81→12/83	X5J		4cyl. 1360cc	44kW (60PS)		TD3434
08-334200-00 08-334207-00 [R66320]	STD 0.50mm	75.00	1.750 2.000 4.000	 	001 IF CR P 026 P 712 CR		IKA STD ST	
Clio I 1.2		05/90→03/96	E5F 710		4cyl. 1171cc	40-44kW (55-60PS)	11	TD3181
Clio I Box 1.2			E5F 716		4cyl. 1171cc	40-44kW (55-60PS)		TD3182
19 I 1.4, 19 I Box 1.4 19 I Chamade 1.4 19 II 1.4 19 II Box 1.4 19 II Chamade 1.4		01/88→12/92 07/88→08/90 01/92→12/95 03/92→12/95 10/94→11/95	E6J 700		4cyl. 1390cc	58-59kW (79-80PS)		TD3183
19 I 1.4 19 I Chamade 1.4		01/88→12/92 07/88→08/90	E6J 701		4cyl. 1390cc	58-59kW (79-80PS)		TD3184
19 II 1.4		10/96→06/01	E6J 706		4cyl. 1390cc	58-59kW (79-80PS)		TD3185
Clio I 1.4		05/90→02/98	E6J 712		4cyl. 1390cc	55-57kW (75-80PS)		TD3186
Clio I 1.4		05/90→02/98	E6J 713		4cyl. 1390cc	55-57kW (75-80PS)		TD3187
Clio I 1.4		05/90→02/98	E6J 718		4cyl. 1390cc	55-57kW (75-78PS)		TD3188
Express 1.4i		03/86→09/97	E6J 734		4cyl. 1390cc	43kW (58PS)		TD3189





Clio I 1.4		E6J 738	4cyl. 1390cc	43kW (58PS)	TD3190
Clio I 1.4	05/90→02/98	E6J 760	4cyl. 1390cc	55-57kW (75-78PS)	TD3191
Clio I 1.2	05/90→09/98	E7F 700	4cyl. 1171cc	55kW (75PS)	TD3192
Clio I 1.2	05/90→09/98	E7F 704	4cyl. 1171cc	44kW (60PS)	TD3193
Clio I 1.2 Clio I Box 1.2	01/91→06/96 01/91→09/98	E7F 706	4cyl. 1171cc	55kW (75PS)	TD3194
Clio I 1.2 Rapid Box 1.2	05/90→09/98 05/95→11/98	E7F 708	4cyl. 1171cc	43-44kW (58-60PS)	TD3195
19 II 1.2	05/92→09/94	E7F 730	4cyl. 1171cc	46kW (63PS)	TD3196
Clio I 1.2 Clio I Box 1.2	05/90→09/98 01/91→09/98	E7F 750	4cyl. 1171cc	43-44kW (58-60PS)	TD3197
Megane I 1.4 Eco	01/96→03/99	E7J 624	4cyl. 1390cc	52kW (71PS)	TD5526
Megane I 1.4 e Megane I Classic 1.4 Megane I Grandtour 1.4 e	01/96→08/03 09/96→08/03 03/99→08/03	E7J 626	4cyl. 1390cc	55kW (75PS)	TD16362
Kangoo 1.4, Kangoo Express 1.4	08/97→	E7J 634	4cyl. 1390cc	55kW (75PS)	TD17271
Kangoo 1.4, Kangoo Express 1.4	08/97→	E7J 635	4cyl. 1390cc	55kW (75PS)	TD17272
Clio I 1.4	01/91→09/98	E7J 718	4cyl. 1390cc	58kW (79PS)	TD3205
Clio I 1.4	01/91→09/98	E7J 719	4cyl. 1390cc	58kW (79PS)	TD3206





Rapid Box 1.4	09/91→03/98	E7J 720	4cyl. 1390cc	55-59kW (75-80PS)	TD3207	
Rapid Box 1.4	09/91→03/98	E7J 724	4cyl. 1390cc	55-59kW (75-80PS)	TD3208	
Rapid Box 1.4	09/91→03/98	E7J 726	4cyl. 1390cc	55-59kW (75-80PS)	TD5508	
Rapid Box 1.4	01/94→03/98	E7J 728	4cyl. 1390cc	58-59kW (79-80PS)	TD3209	
19 II 1.4 19 II Chamade 1.4	01/92→12/95 11/93→12/95	E7J 742	4cyl. 1390cc	55kW (75PS)	TD3212	
Clio I 1.4	01/91→09/98	E7J 754	4cyl. 1390cc	55-59kW (75-80PS)	TD3211	
Megane I 1.4 e Megane I Classic 1.4 Megane Scenic 1.4 i	01/96→08/03 09/96→08/03 01/97→09/99	E7J 764	4cyl. 1390cc	55kW (75PS)	TD4858	
Rapid Box 1.4	09/91→03/98	E7J 773	4cyl. 1390cc	55-59kW (75-80PS)	TD3213	
Clio II 1.4 Kangoo 1.4, Kangoo Express 1.4	09/98→05/05 08/97→	E7J 780	4cyl. 1390cc	55kW (75PS)	TD9623	
08-336400-00 08-336407-00 [R66200]	STD 0.50mm	75.80	1.500 1.750 3.000	 	001 CR P 005 P 236 P	IKA STD STD
5 1.4 5 1.4 Turbo Super 5 1.4 Turbo GT	09/80→03/85 06/80→01/85 01/85→05/91	840 730	4cyl. 1397cc	77kW (105PS) Turbo Intercooled	12 TD3054	
9 1.4 Turbo 11 1.4 Turbo	04/84→12/89 04/84→12/86	C1J 760	4cyl. 1397cc	77kW (105PS) Turbo Intercooled	TD3126	
9 1.4 Turbo 11 1.4 Turbo	04/84→12/89 02/84→12/86	C1J 764	4cyl. 1397cc	77kW (105PS) Turbo Intercooled	TD3127	





Super 5 1.4	10/84→07/89	C2J 700	4cyl. 1397cc	52-53kW (71-72PS)	TD3137
5 1.4	01/82→12/85	C2J 713	4cyl. 1397cc	46kW (63PS)	TD3138
9 1.4 11 1.4	09/81→12/85 05/83→12/85	C2J 717	4cyl. 1397cc	53kW (72PS)	TD3141
19 I 1.4 19 I Chamade 1.4 19 II Chamade 1.4	01/89→12/89 07/88→04/92 05/92→09/94	C2J 772	4cyl. 1397cc	43kW (58PS)	TD3154
Super 5 1.4	06/87→07/89	C2J 782	4cyl. 1397cc	49kW (67PS)	TD3158
Rapid Box 1.4 Super 5 1.4	03/86→08/91 06/87→08/90	C2J 784	4cyl. 1397cc	44kW (60PS)	TD3161
Rapid Box 1.4 Super 5 1.4 Super 5 Box 1.4	08/88→03/98 10/85→12/96 09/85→07/86	C3J 700	4cyl. 1397cc	43-44kW (58-60PS)	TD4856
Rapid Box 1.4 Super 5 1.4	08/88→03/98 10/85→12/96	C3J 702	4cyl. 1397cc	43-44kW (58-60PS)	TD3175
19 I 1.4 19 I Chamade 1.4 19 II 1.4, 19 II Chamade 1.4	01/89→04/92 07/88→04/92 04/92→12/95	C3J 710	4cyl. 1397cc	43-44kW (58-60PS)	TD3176
Rapid Box 1.4 Super 5 1.4	08/88→03/98 10/85→12/96	C3J 760	4cyl. 1397cc	43-44kW (58-60PS)	TD3179
Rapid Box 1.4	08/88→03/98	C3J 762	4cyl. 1397cc	43-44kW (58-60PS)	TD3180

08-333500-00	STD	76.00	1.750		001 IF CR P	IKA
08-333505-00	0.25mm		2.000		026 P	STD
08-333507-00	0.50mm		4.000		712 CR	ST
[R66190]						



Clio Grandtour IV 1.5 dCi 90	01/13→	K9K 608	4cyl. 1461cc 66kW (89PS)	14
		Diesel	Turbo Intercooled	TD27682
Clio Grandtour IV 1.5 dCi 75	01/13→	K9K 612	4cyl. 1461cc 55kW (75PS)	
Clio IV 1.5 dCi 75	11/12→			TD27683
		Diesel	Turbo Intercooled	
Grand Scénic III 1.5 dCi, Scénic III 1.5 dCi	04/09→	K9K 636 Euro 5	4cyl. 1461cc 81kW (110PS)	
		Diesel	Turbo Intercooled	TD28220
Clio II Box 1.5 dCi	11/03→	K9K 716	4cyl. 1461cc 60kW (81PS)	
		Diesel	Turbo Intercooled	TD22179
Megane II 1.5 dCi	05/05→	K9K 732 Euro 4	4cyl. 1461cc 78kW (106PS)	
Megane II Coupé-Cabriolet 1.5 dCi	03/06→			TD20829
Megane II Estate 1.5 dCi, Megane II Saloon 1.5 dCi, Scénic II 1.5 dCi	05/05→	Diesel	Turbo Intercooled	
Clio Grandtour 1.5 dCi	02/08→	K9K 764 Euro 4	4cyl. 1461cc 78kW (106PS)	
Clio III 1.5 dCi	06/05→			TD18538
Modus / Grand Modus 1.5 dCi	05/05→	Diesel	Turbo Intercooled	
Clio Grandtour 1.5 dCi, Clio III 1.5 dCi	08/10→	K9K 770	4cyl. 1461cc 55-65kW (75-88PS)	
Modus / Grand Modus 1.5 dCi 75	10/10→			TD25691
		Diesel	Turbo Intercooled	
Clio Grandtour 1.5 dCi	02/08→	K9K 772	4cyl. 1461cc 63-76kW (86-103PS)	
Clio III 1.5 dCi	06/05→			TD23549
Modus / Grand Modus 1.5 dCi	05/07→	Diesel	Turbo Intercooled	
Laguna III 1.5 dCi, Laguna III Grandtour 1.5 dCi	10/07→	K9K 780 Euro 4	4cyl. 1461cc 76kW (103PS)	
		Diesel	Turbo Intercooled	TD20817
Latitude 1.5 dCi	07/10→	K9K 782	4cyl. 1461cc 81kW (110PS)	
		Diesel	Turbo Intercooled	TD27990
Kangoo / Grand Kangoo 1.5 dCi, Kangoo Express 1.5 dCi	02/08→	K9K 800	4cyl. 1461cc 63kW (86PS)	
Kangoo Express 1.5 dCi 75	09/10→			TD22193
Kangoo Express 1.5 dCi 85	02/08→	Diesel	Turbo Intercooled	
Kangoo / Grand Kangoo 1.5 dCi	02/08→	K9K 804 Euro 4	4cyl. 1461cc 78kW (106PS)	
Kangoo / Grand Kangoo 1.5 dCi 110	09/10→			TD20831
Kangoo Be Bop 1.5 dCi	06/09→	Diesel	Turbo Intercooled	
Kangoo Express 1.5 dCi 110	09/10→			
Kangoo / Grand Kangoo 1.5 dCi	02/08→	K9K 806 Euro 4 (FAP)	4cyl. 1461cc 76kW (103PS)	
Kangoo Be Bop 1.5 dCi	02/09→			TD20832
Kangoo Express 1.5 dCi	02/08→	Diesel	Turbo Intercooled	
Kangoo / Grand Kangoo 1.5 dCi	11/12→	K9K 808	4cyl. 1461cc 66kW (89PS)	
Kangoo Be Bop 1.5 dCi, Kangoo Express 1.5 dCi 90	06/09→			TD26258
		Diesel	Turbo Intercooled	





Kangoo 1.5 dCi		K9K 812	4cyl. 1461cc 60kW (81PS)	
		Diesel	Turbo Intercooled	TD24967
Twingo 1.5 dCi 75	10/10→	K9K 820	4cyl. 1461cc 55kW (75PS)	
		Diesel	Turbo Intercooled	TD25692
Fluence 1.5 dCi	02/10→	K9K 830	4cyl. 1461cc 63kW (86PS)	
Grand Scénic III 1.5 dCi	04/09→			
Megane III Hatchback 1.5 dCi	12/09→			
Scénic III 1.5 dCi	04/09→	Diesel	Turbo Intercooled	
Twingo 1.5 dCi 90	10/10→			TD25693
Fluence 1.5 dCi	06/05→	K9K 832 Euro 4	4cyl. 1461cc 78kW (106PS)	
Grand Scénic III 1.5 dCi,	02/09→			
Scénic III 1.5 dCi		Diesel	Turbo Intercooled	TD23521
Fluence 1.5 dCi	02/10→	K9K 834	4cyl. 1461cc 66kW (89PS)	
Megane III Grandtour 1.5 dCi	05/09→			
		Diesel	Turbo Intercooled	TD23742
Fluence 1.5 dCi	02/10→	K9K 836	4cyl. 1461cc 81kW (110PS)	
Grand Scénic III 1.5 dCi	04/09→			
Megane CC 1.5 dCi	06/10→			
Megane III Grandtour 1.5 dCi,	02/09→	Diesel	Turbo Intercooled	
Megane III Hatchback 1.5 dCi				
Scénic III 1.5 dCi	04/09→			TD23743
Fluence 1.5 dCi	02/10→	K9K 837 Euro 5	4cyl. 1461cc 81kW (110PS)	
Grand Scénic III 1.5 dCi	04/09→			
Megane III Grandtour 1.5 dCi	02/09→			
Scénic III 1.5 dCi	04/09→	Diesel	Turbo Intercooled	TD26246
Twingo 1.5 dCi		K9K 840	4cyl. 1461cc 50kW (68PS)	
		Diesel		TD22194
Grand Scénic III 1.5 dCi	11/10→	K9K 846 Euro 5	4cyl. 1461cc 70kW (95PS)	
Laguna Coupe 1.5 dCi	03/12→			
Megane III Grandtour 1.5 dCi	02/09→			
Scénic III 1.5 dCi	11/10→	Diesel	Turbo Intercooled	TD24579
Duster 1.5 dCi	06/09→	K9K 884 Euro 5	4cyl. 1461cc 66kW (89PS)	
		Diesel	Turbo Intercooled	TD27697
Megane III Coupe 1.5 dCi	11/08→	K9K F 830	4cyl. 1461cc 63kW (86PS)	
		Diesel	Turbo Intercooled	TD23566
Megane III Coupe 1.5 dCi,	02/09→	K9K G 832	4cyl. 1461cc 78kW (106PS)	
Megane III Hatchback 1.5 dCi				
		Diesel	Turbo Intercooled	TD23522
Megane III Coupe 1.5 dCi,	11/08→	K9K H 834	4cyl. 1461cc 66kW (89PS)	
Megane III Hatchback 1.5 dCi				
		Diesel	Turbo Intercooled	TD23569





Megane III Coupe 1.5 dCi		02/09 →	K9K J 836		4cyl. 1461cc 81kW (110PS)	Diesel Turbo Intercooled	TD23567
Megane III Coupe 1.5 dCi		02/09 →	K9K N 837		4cyl. 1461cc 81kW (110PS)	Diesel Turbo Intercooled	TD24968
Grand Scénic II 1.5 dCi		05/05 →	K9K P 732		4cyl. 1461cc 78kW (106PS)	Diesel Turbo Intercooled	TD19693
08-123400-30	STD	76.00	2.000		001 IF CK P		KV1
08-123407-30	0.50mm		2.000		005 IFU P		GOE13
			2.500		231 LKZ CR P		GOE13
Clio II 1.5 dCi, Clio II Box 1.5 dCi		06/01 →	K9K 700 Euro 3		4cyl. 1461cc 48kW (65PS)	Diesel Turbo Intercooled	TD16219
Kangoo 1.5 dCi, Kangoo Express 1.5 dCi		12/01 →					15
Thalia 1.5 dCi		04/02 →					
Thalia II 1.5 dCi		01/09 →					
Clio II 1.5 dCi, Clio II Box 1.5 dCi		06/01 →	K9K 702 Euro 3		4cyl. 1461cc 60kW (81PS)	Diesel Turbo Intercooled	TD16344
Kangoo 1.5 dCi		07/02 →					
Kangoo Express 1.5 dCi		12/01 →					
Thalia 1.5 dCi		06/01 →					
Clio II 1.5 dCi, Clio II Box 1.5 dCi		06/01 →	K9K 704 Euro 3		4cyl. 1461cc 48kW (65PS)	Diesel Turbo Intercooled	TD16343
Kangoo 1.5 dCi, Kangoo Express 1.5 dCi		12/01 →					
Clio II 1.5 dCi, Clio II Box 1.5 dCi		06/01 →	K9K 706		4cyl. 1461cc 48-50kW (65-68PS)	Diesel Turbo Intercooled	TD20974
Kangoo 1.5 dCi		07/02 →					
Kangoo Express 1.5 dCi		12/01 →					
Thalia 1.5 dCi		06/01 →					
Clio II 1.5 dCi, Clio II Box 1.5 dCi		06/01 →	K9K 708		4cyl. 1461cc 48-50kW (65-68PS)	Diesel Turbo Intercooled	TD26047
Kangoo 1.5 dCi		07/02 →					
Kangoo Express 1.5 dCi		12/01 →					
Thalia 1.5 dCi		06/01 →					
Clio II Box 1.5 dCi		11/03 →	K9K 710 Euro 3		4cyl. 1461cc 60kW (81PS)	Diesel Turbo Intercooled	TD17488
Kangoo 1.5 dCi		07/02 →					
Kangoo Express 1.5 dCi		04/03 →					
Clio II 1.5 dCi		01/04 →	K9K 712 Euro 3		4cyl. 1461cc 74kW (100PS)	Diesel Turbo Intercooled	TD18419
Clio Grandtour 1.5 dCi		02/08 →	K9K 714 Euro 4		4cyl. 1461cc 50kW (68PS)	Diesel Turbo Intercooled	TD21173
Clio II 1.5 dCi		08/04 →					
Clio II Box 1.5 dCi		04/04 →					
Clio III 1.5 dCi, Kangoo 1.5 dCi,		06/05 →					
Kangoo Express 1.5 dCi							
Thalia 1.5 dCi		02/03 →					







Clio II 1.5 dCi	02/07→	K9K 718 Euro 4		
Kangoo 1.5 dCi, Kangoo Express 1.5 dCi	06/05→		4cyl.	
Thalia II 1.5 dCi	09/08→		1461cc	62kW (84PS)
Twingo 1.5 dCi	04/08→	Diesel	Turbo Intercooled	TD21171
Megane II 1.5 dCi	11/02→	K9K 722 Euro 3		
Megane II Estate 1.5 dCi	08/03→		4cyl.	
Megane II Saloon 1.5 dCi	09/03→		1461cc	60kW (81PS)
Scénic II 1.5 dCi	06/03→	Diesel	Turbo Intercooled	TD16534
Megane II 1.5 dCi, Megane II Estate 1.5 dCi, Megane II Saloon 1.5 dCi, Scénic II 1.5 dCi	05/05→	K9K 724 Euro 4		
			4cyl.	
			1461cc	63kW (86PS)
		Diesel	Turbo Intercooled	TD20988
Megane II 1.5 dCi	10/03→	K9K 728 Euro 3		
Megane II Estate 1.5 dCi, Megane II Saloon 1.5 dCi	02/04→		4cyl.	
Scénic II 1.5 dCi	11/03→		1461cc	74kW (100PS)
		Diesel	Turbo Intercooled	TD20707
Grand Scénic II 1.5 dCi	04/04→	K9K 729 Euro 3		
Megane II 1.5 dCi	10/03→		4cyl.	
Megane II Estate 1.5 dCi, Megane II Saloon 1.5 dCi	02/04→		1461cc	74kW (100PS)
Scénic II 1.5 dCi	11/03→	Diesel	Turbo Intercooled	TD20706
Clio II 1.5 dCi, Thalia 1.5 dCi	06/05→	K9K 740 Euro 4		
Thalia II 1.5 dCi	09/08→		4cyl.	
Twingo 1.5 dCi	03/07→		1461cc	47kW (64PS)
		Diesel	Turbo Intercooled	TD20446
Clio III 1.5 dCi	11/07→	K9K 750 Euro 3		
Modus / Grand Modus 1.5 dCi	09/04→		4cyl.	
Modus / Grand Modus 1.5 dCi 90	10/10→		1461cc	57-65kW (78-88PS)
		Diesel	Turbo Intercooled	TD21133
Clio Grandtour 1.5 dCi	02/10→	K9K 752 Euro 3		
Clio III 1.5 dCi	05/05→		4cyl.	
Modus / Grand Modus 1.5 dCi	12/04→		1461cc	48-50kW (65-68PS)
		Diesel	Turbo Intercooled	TD21134
Modus / Grand Modus 1.5 dCi	12/04→	K9K 760 Euro 4		
			4cyl.	
			1461cc	50kW (68PS)
		Diesel	Turbo Intercooled	TD21135
Modus / Grand Modus 1.5 dCi	12/04→	K9K 762 Euro 4		
			4cyl.	
			1461cc	50kW (68PS)
		Diesel	Turbo Intercooled	TD20922
Clio Grandtour 1.5 dCi	02/08→	K9K 766 Euro 4		
Clio III 1.5 dCi	06/05→		4cyl.	
Modus / Grand Modus 1.5 dCi	12/04→		1461cc	63kW (86PS)
		Diesel	Turbo Intercooled	TD18537
Clio Grandtour 1.5 dCi	02/08→	K9K 768 Euro 4		
Clio III 1.5 dCi	06/05→		4cyl.	
Modus / Grand Modus 1.5 dCi	12/04→		1461cc	50kW (68PS)
		Diesel	Turbo Intercooled	TD18536
Logan Estate 1.5 dCi		K9K 790		
			4cyl.	
			1461cc	48kW (65PS)
		Diesel	Turbo Intercooled	TD21438
Logan 1.5 dCi, Logan Estate 1.5 dCi	04/07→	K9K 792		
			4cyl.	
			1461cc	50kW (68PS)
		Diesel	Turbo Intercooled	TD21439







Kangoo 1.5 dCi		02/08 →	K9K 794		4cyl. 1461cc 48-50kW (65-68PS)	
			Diesel	Turbo Intercooled		TD23795
Logan 1.5 dCi, Logan Estate 1.5 dCi		02/08 →	K9K 796		4cyl. 1461cc 63kW (86PS)	
			Diesel	Turbo Intercooled		TD26080
Kangoo / Grand Kangoo 1.5 dCi		02/08 →	K9K 802 Euro 4		4cyl. 1461cc 63kW (86PS)	
Kangoo Be Bop 1.5 dCi 75		09/10 →				
Kangoo Express 1.5 dCi 85		02/08 →	Diesel	Turbo Intercooled		TD20830
Kangoo 1.5 dCi		02/08 →	K9K G 724		4cyl. 1461cc 63kW (86PS)	
			Diesel	Turbo Intercooled		TD19692
08-123400-00	STD	76.00	2.000		001 IF CK P	KV1
08-123407-00	0.50mm		2.000		005 IFU P	GOE13
[R60620]			2.500		231 NT	GOE13
16 1.6 TS		09/68 → 08/80	807		4cyl. 1565cc 63kW (86PS)	16 TD3029
16 1.6 TS		09/68 → 08/80	807 03		4cyl. 1565cc 61kW (82PS)	TD18884
12 1.6 Gordini		08/70 → 12/74	807 20		4cyl. 1565cc 83kW (113PS)	TD19214
18 1.6 Turbo		10/80 → 09/82	807 727		4cyl. 1565cc 63kW (86PS)	TD3030
18 Variable 1.6 Turbo		09/82 → 07/86			Turbo	
16 1.6 TS		09/68 → 08/80	807.04		4cyl. 1565cc 61kW (82PS)	TD21384
16 1.6 TS		09/68 → 08/80	807.05		4cyl. 1565cc 61kW (82PS)	TD21385
16 1.6 TL		01/71 → 08/80	821		4cyl. 1565cc 49kW (67PS)	TD3042
12 1.6 Gordini		08/70 → 12/74	821 20		4cyl. 1565cc 83kW (113PS)	TD12308
12 Variable 1.6		08/70 → 07/75				





16 1.6 TL	01/71→08/80	821.03	4cyl. 1565cc	40-48kW (54-65PS)	TD21388
-----------	-------------	--------	-----------------	-------------------	---------

16 1.6 TL	01/71→08/80	821.04	4cyl. 1565cc	40-48kW (54-65PS)	TD21389
-----------	-------------	--------	-----------------	-------------------	---------

08-334500-00	STD	77.00	1.750		001 IF CR P	IKA
[R66250]			2.000		026 P	STD
			4.000		712 CR	ST



9 1.6 D 11 1.6 D, 11 Box 1.6 D	10/82→12/88 08/83→12/88	F8M 700	4cyl. 1595cc	40kW (54PS)	17 TD3282
-----------------------------------	----------------------------	---------	-----------------	-------------	--------------

9 1.6 D 11 1.6 D, 11 Box 1.6 D Rapid Box 1.6 D Super 5 1.6 D Super 5 Box 1.6 D	10/82→12/88 08/83→12/88 03/86→08/98 08/85→12/96 10/84→12/96	F8M 720	4cyl. 1595cc	40kW (54PS)	TD3283
--	---	---------	-----------------	-------------	--------

9 1.6 D 11 1.6 D, 11 Box 1.6 D Rapid Box 1.6 D Super 5 1.6 D	10/82→12/88 08/83→12/88 03/86→08/98 04/85→12/96	F8M 730	4cyl. 1595cc	40kW (54PS)	TD3284
---	--	---------	-----------------	-------------	--------

Rapid Box 1.6 D	03/86→08/98	F8M 736	4cyl. 1595cc	40kW (54PS)	TD3285
-----------------	-------------	---------	-----------------	-------------	--------

Rapid Box 1.6 D	03/86→08/98	F8M 760	4cyl. 1595cc	40kW (54PS)	TD3286
-----------------	-------------	---------	-----------------	-------------	--------

08-335000-10	STD	78.00	2.000		001 CR P	KV1
08-335003-10	0.125mm				005 IF P	STD
08-335005-10	0.25mm		2.000			
08-335007-10	0.50mm		3.000		231 CR P	STD
[R66350]						

18 1.6 18 Variable 1.6 18 Variable 1.6 4x4	04/82→07/86 01/82→07/86 01/83→07/86	841 717	4cyl. 1647cc	54kW (73PS)	18 TD4854
--	---	---------	-----------------	-------------	--------------

Traction T1, Traction T4, Traction T5, Traction T6 Trafic 4x4	01/81→ 01/82→12/86	841 A1M	4cyl. 1647cc		FM4389
---	-----------------------	---------	-----------------	--	--------

18 1.6 18 Variable 1.6 18 Variable 1.6 4x4	04/78→09/82 05/79→09/82 02/79→06/81	841.25	4cyl. 1647cc	58kW (79PS)	TD3056
--	---	--------	-----------------	-------------	--------





18 1.6 18 Variable 1.6	04/78→09/82 05/79→09/82	841.26	4cyl. 1647cc	58kW (79PS)	TD3055
16 1.6 TX 20 1.6	06/74→08/80 10/75→05/77	843	4cyl. 1647cc	66kW (89PS)	TD3058
16 1.6 TX	06/74→08/80	843.01	4cyl. 1647cc	66-68kW (90-92PS)	TD21391
17 1.6	06/74→08/79	843.05	4cyl. 1647cc	53-72kW (72-98PS)	TD21381
Trafic Box 1.6 Trafic Bus 1.6	01/83→06/86 01/84→06/86	A1M	4cyl. 1647cc	48-49kW (65-67PS)	TD3083
Trafic Box 1.6 Trafic Box 1.6 4x4 Trafic Bus 1.6 Trafic Bus 1.6 4x4	01/83→06/86 08/85→06/86 01/84→06/86 03/80→08/86	A1M 707	4cyl. 1647cc	48-49kW (65-67PS)	TD3082
18 1.6 18 Variable 1.6 18 Variable 1.6 4x4 Fuego 1.6	04/82→11/93 01/82→11/93 01/83→07/86 04/83→10/85	A2M 723	4cyl. 1647cc	54kW (73PS)	TD5055

08-334300-00	STD	79.00	1.750		001 IF CR P	IKA
[R66270]			2.000		026 P	GOE13
			4.000		712 CR	ST

Clio II 1.4 16V	08/00→	K4J 700	4cyl. 1390cc	72kW (98PS)	19 TD16342
Clio II 1.4 16V	08/00→	K4J 710 Euro 4	4cyl. 1390cc	72kW (98PS)	TD19673
Clio II 1.4 16V	08/00→	K4J 711 Euro 4	4cyl. 1390cc	72kW (98PS)	TD19672
Clio II 1.4 16V Thalia 1.4 16V	10/99→ 08/00→	K4J 712	4cyl. 1390cc	70-72kW (95-98PS)	TD14330
Clio II 1.4 16V	10/99→	K4J 713	4cyl. 1390cc	72kW (98PS)	TD14331





Megane I 1.4 16V, Megane I Cabriolet 1.4 16V, Megane I Classic 1.4 16V, Megane I Coach 1.4 16V, Megane I Grandtour 1.4 16V Scénic I 1.4 16V	03/99→08/03 09/99→08/03	K4J 714	4cyl. 1390cc	70kW (95PS)	TD16349
Clio II 1.4i	05/00→10/07	K4J 715	4cyl. 1390cc	70-72kW (95-98PS)	TD20907
Megane II 1.4 16V Megane II Estate 1.4 Megane II Saloon 1.4 Scénic II 1.4	11/02→ 08/03→ 09/03→ 06/03→	K4J 730	4cyl. 1390cc	72kW (98PS)	TD16531
Megane II 1.4 16V Megane II Saloon 1.4	10/03→ 09/03→	K4J 732	4cyl. 1390cc	60kW (81PS)	TD20910
Megane II 1.4 16V Megane II Estate 1.4 Megane II Saloon 1.4 Scénic II 1.4	11/02→ 08/03→ 09/03→ 06/03→	K4J 740	4cyl. 1390cc	72kW (98PS)	TD21208
Megane I 1.4 16V, Megane I Cabriolet 1.4 16V, Megane I Classic 1.4 16V, Megane I Coach 1.4 16V, Megane I Grandtour 1.4 16V Scénic I 1.4 16V	03/99→08/03 09/99→08/03	K4J 750	4cyl. 1390cc	70kW (95PS)	TD13310
Modus / Grand Modus 1.4 Scénic II 1.4	12/04→ 06/03→	K4J 770	4cyl. 1390cc	72kW (98PS)	TD18422
Clio Grandtour 1.4 16V Clio III 1.4 16V	02/10→ 06/05→	K4J 780	4cyl. 1390cc	72kW (98PS)	TD18533
Megane II 1.4 16V Megane II Saloon 1.4	10/03→ 09/03→	K4J D 740	4cyl. 1390cc	72kW (98PS)	TD19686
Logan 1.6	04/07→	K4M 690	4cyl. 1598cc	77kW (105PS)	TD22187
Logan Estate 1.6	04/07→	K4M 697	4cyl. 1598cc	77kW (105PS)	TD23897
Kangoo II 1.6i	12/05→	K4M 698	4cyl. 1598cc	77kW (105PS)	TD23898





Megane I 1.6 16V, Megane I Cabriolet 1.6 16V, Megane I Classic 1.6 16V, Megane I Coach 1.6 16V, Megane I Grandtour 1.6 16V	03/99→08/03	K4M 700	4cyl. 1598cc	79-81kW (107-109PS)	
Megane Scenic 1.6 16V Scénic I 1.6	04/98→10/99 09/99→09/03				TD13308
Megane I 1.6 16V, Megane I Cabriolet 1.6 16V, Megane I Classic 1.6 16V, Megane I Coach 1.6 16V, Megane I Grandtour 1.6 16V	03/99→08/03	K4M 701	4cyl. 1598cc	79-81kW (107-109PS)	
Megane Scenic 1.6 16V	04/98→10/99				TD13309
Megane I 1.6 16V Megane I 1.6 LPG Megane I Grandtour 1.6 16V Megane Scenic 1.6 16V Scénic I 1.6 BiFuel	03/99→08/03 10/00→08/02 03/99→08/03 04/98→10/99 09/99→04/01	K4M 704	4cyl. 1598cc	79-81kW (107-109PS)	
Scénic I 1.6	09/99→09/03	K4M 706	4cyl. 1598cc	79kW (107PS)	TD16346
Clio II 1.6 16V Megane I 1.6 16V, Megane I Cabriolet 1.6 16V, Megane I Classic 1.6 16V, Megane I Coach 1.6 16V, Megane I Grandtour 1.6 16V	09/98→ 03/99→08/03	K4M 708	4cyl. 1598cc	79-81kW (107-109PS)	
Megane Scenic 1.6 16V Scénic I 1.6	04/98→10/99 03/01→08/03				TD16345
Scénic I 1.6	03/01→08/03	K4M 709	4cyl. 1598cc	79kW (107PS)	TD21194
Laguna II 1.6 16V, Laguna II Grandtour 1.6 16V	03/01→	K4M 710	4cyl. 1598cc	79kW (107PS)	TD16214
Laguna II 1.6 16V, Laguna II Grandtour 1.6 16V	03/01→	K4M 711	4cyl. 1598cc	79-81kW (107-109PS)	TD16215
Laguna II 1.6 16V, Laguna II Grandtour 1.6 16V	03/01→	K4M 712	4cyl. 1598cc	79kW (107PS)	TD21163
Laguna II 1.6 16V, Laguna II Grandtour 1.6 16V	03/01→	K4M 714	4cyl. 1598cc	79kW (107PS)	TD21164
Laguna II 1.6 16V, Laguna II Grandtour 1.6 16V	02/05→	K4M 716	4cyl. 1598cc	82kW (111PS)	TD21200
Laguna Grandtour 1.6 16V, Laguna I 1.6 16V	11/97→03/01	K4M 720	4cyl. 1598cc	79-81kW (107-109PS)	TD16269





Laguna 1.6i	05/98→02/01	K4M 724	4cyl. 1598cc	79-81kW (107-109PS)	TD16270
Kangoo 1.6i	09/01→	K4M 730	4cyl. 1598cc	70kW (95PS)	TD21195
Clio II 1.6i	11/01→	K4M 732	4cyl. 1598cc	66-70kW (90-95PS)	TD20911
Clio II 1.6i	11/01→	K4M 734	4cyl. 1598cc	66kW (89PS)	TD20912
Clio II 1.6i	11/01→	K4M 736	4cyl. 1598cc	79kW (107PS)	TD21201
Clio II 1.6 16V Thalia 1.6 16V	09/98→ 04/02→	K4M 740	4cyl. 1598cc	79kW (107PS)	TD18445
Clio II 1.6 16V	09/98→	K4M 742	4cyl. 1598cc	66-79kW (90-107PS)	TD20913
Clio II 1.6 16V Thalia II 1.6 16V	09/98→ 09/08→	K4M 743	4cyl. 1598cc	66-79kW (90-107PS)	TD20914
Clio II 1.6 16V	09/98→	K4M 744 Euro 4	4cyl. 1598cc	79kW (107PS)	TD19674
Clio II 1.6 16V	09/98→	K4M 745	4cyl. 1598cc	79kW (107PS)	TD19675
Clio II 1.6 16V Clio II 1.6 Hi-Flex Clio III 1.6 Hi-Flex	09/98→ 01/05→02/10 05/05→02/10	K4M 748	4cyl. 1598cc	79-81kW (107-109PS)	TD11567
Kangoo 1.6 16V Kangoo 1.6 16V 4x4, Kangoo Express 1.6 16V, Kangoo Express 1.6 16V 4x4	06/01→ 10/01→	K4M 752	4cyl. 1598cc	79-81kW (107-109PS)	TD16370
Kangoo 1.6 16V Kangoo 1.6 16V 4x4, Kangoo Express 1.6 16V 4x4	06/01→ 10/01→	K4M 753	4cyl. 1598cc	70kW (95PS)	TD17494





Megane II 1.6 16V		11/02→	K4M 760			
Megane II Coupé-Cabriolet 1.6		09/03→		4cyl.		
Megane II Coupé-Cabriolet 1.6 16V		01/06→	1598cc		79-81kW (107-109PS)	
Megane II Estate 1.6		08/03→				
Megane II Estate 1.6 16V		01/06→				
Megane II Saloon 1.6		09/03→				
Megane III Hatchback 1.6 16V		11/08→				TD16532
Modus / Grand Modus 1.6		12/04→	K4M 790			
				4cyl.		
			1598cc		82kW (111PS)	
						TD18898
Megane II Coupé-Cabriolet 1.6 16V, Megane II Estate 1.6 16V, Megane II Saloon 1.6 16V		01/06→	K4M D 812			
				4cyl.		
			1598cc		82kW (111PS)	
						TD21107
08-104200-00	STD	79.50	1.500		001 IF CR P	KV1
08-104207-00	0.50mm		1.500		026 P	STD
[R60240]			2.500		712 CR	ST
08-105200-00	STD	79.50	1.200		001 NT	ST
08-105207-00	0.50mm		1.500		026 P	STD
[R60660]			2.500		712 CR	ST
Kangoo / Grand Kangoo 1.6 16V		02/08→	K4M 830 Euro 4			
Kangoo Be Bop 1.6		02/09→		4cyl.		
Kangoo Express 1.6 16V		02/08→	1598cc		78kW (106PS)	
						TD23581
Kangoo / Grand Kangoo 1.6 16V		02/08→	K4M 831 Euro 4			
				4cyl.		
			1598cc		79kW (107PS)	
						TD26526
Kangoo Express 1.6 16V LPG		02/08→	K4M 834 Euro 4			
				4cyl.		
			1598cc		72kW (98PS)	
						TD26128
Logan 1.4		09/04→	K7J			
Logan Estate 1.4		10/07→		4cyl.		
Sandero/Stepway 1.4		02/09→	1390cc		55kW (75PS)	
						TD23530
Logan 1.4		09/04→	K7J 710			
Logan Estate 1.4		10/07→		4cyl.		
Sandero/Stepway 1.4		02/09→	1390cc		55kW (75PS)	
						TD18138
Megane I 1.6 e		01/96→03/99	K7M 702			
Megane I Cabriolet 1.6 e		10/96→03/99		4cyl.		
Megane I Classic 1.6 e		09/96→03/99	1598cc		66kW (89PS)	
Megane I Coach 1.6 e		03/96→03/99				
Megane I Grandtour 1.6 e		03/99→08/03				
Megane Scenic 1.6 e		10/96→10/99				TD4876





Megane I 1.6 e	01/96→03/99	K7M 703				
Megane I Cabriolet 1.6 e	10/96→03/99		4cyl.			
Megane I Classic 1.6 e	09/96→03/99		1598cc	66kW (89PS)		
Megane I Coach 1.6 e	03/96→03/99					
Megane I Grandtour 1.6 e	03/99→08/03					
Megane Scenic 1.6 e	10/96→10/99					TD4877
Logan 1.6	09/04→	K7M 710				
Logan Estate 1.6	04/07→		4cyl.			
Sandero/Stepway 1.6	12/07→		1598cc	66kW (89PS)		TD18139
Megane I 1.6 i	01/96→03/99	K7M 720				
Megane I Classic 1.6 i	09/96→03/99		4cyl.			
Megane Scenic 1.6 i	01/97→09/99		1598cc	55kW (75PS)		TD4878
Clio II 1.6	09/98→05/05	K7M 744				
			4cyl.			
			1598cc	66kW (89PS)		TD14332
Clio II 1.6	09/98→05/05	K7M 745				
			4cyl.			
			1598cc	66kW (89PS)		TD14333
Kangoo 1.6	09/99→06/01	K7M 746				
Thalia 1.6	03/98→		4cyl.			
			1598cc	66kW (89PS)		TD20918
Megane I 1.6 e	01/96→03/99	K7M 790				
Megane I Classic 1.6 e	09/96→03/99		4cyl.			
			1598cc	66kW (89PS)		TD4879
08-104200-00	STD	79.50	1.500		001 IF CR P	KV1
08-104207-00	0.50mm		1.500		026 P	STD
[R60240]			2.500		712 CR	ST
Trafic Box 1.9 D, Trafic Bus 1.9 D	06/97→03/01	F8Q 606				21
			4cyl.			
			1870cc	40kW (54PS)		TD9690
			Diesel			
Megane I 1.9 D Eco	01/96→08/03	F8Q 620				
Megane I Classic 1.9 D	09/96→08/03		4cyl.			
			1870cc	47kW (64PS)		TD4867
			Diesel			
Clio II 1.9 D	09/98→05/05	F8Q 630				
Clio II Box 1.9 D	09/98→		4cyl.			
Kangoo D 65 1.9, Kangoo Express D 65 1.9	08/97→		1870cc	47kW (64PS)		TD9626
Thalia 1.9 D	02/98→05/01	Diesel				
Clio II 1.9 D, Clio II Box 1.9 D	02/00→05/01	F8Q 632				
Kangoo 1.9 RXED	09/99→06/01		4cyl.			
Kangoo D 65 1.9	08/97→		1870cc	47-48kW (64-65PS)		TD17431
Kangoo Express 1.9 D	09/99→06/03	Diesel				
Kangoo Express D 65 1.9	08/97→					





Clio II 1.9 D, Clio II Box 1.9 D	02/00→05/01	F8Q 636			
Kangoo 1.9 RXED	09/99→06/01		4cyl.		
Kangoo D 65 1.9	08/97→		1870cc	45kW (61PS)	
Kangoo Express 1.9 D	09/99→06/03	Diesel			
Kangoo Express D 65 1.9	08/97→				TD21227
Rapid Box 1.9 D	09/94→03/98	F8Q 640			
			4cyl.		
			1870cc	40kW (54PS)	
		Diesel			TD5510
Rapid Box 1.9 D	09/94→03/98	F8Q 644			
			4cyl.		
			1870cc	40-66kW (54-90PS)	
		Diesel			TD21146
Rapid Box 1.9 D	09/91→03/98	F8Q 646			
			4cyl.		
			1870cc	47-66kW (64-90PS)	
		Diesel			TD21252
Kangoo D 55 1.9, Kangoo Express D 55 1.9	08/97→	F8Q 662			
			4cyl.		
			1870cc	47kW (64PS)	
		Diesel			TD9625
Clio I 1.9 D	05/96→02/98	F8Q 676			
			4cyl.		
			1870cc	48kW (65PS)	
		Diesel			TD23895
Clio I 1.9 D	01/97→09/98	F8Q 678			
Clio I Box 1.9 RND	04/96→02/98		4cyl.		
			1870cc	48-40kW (65-54PS)	
		Diesel			TD20390
Rapid Box 1.9 D	09/94→03/98	F8Q 682			
			4cyl.		
			1870cc	48kW (65PS)	
		Diesel			TD16544
Clio I 1.9 D	05/96→02/98	F8Q 696			
			4cyl.		
			1870cc	40-48kW (54-65PS)	
		Diesel			TD21255
19 I 1.9 D	09/88→04/92	F8Q 706			
19 I Box 1.9 D	01/88→12/92		4cyl.		
19 I Chamade 1.9 D	10/89→04/92		1870cc	47-48kW (64-65PS)	
19 II Box 1.9 D	03/92→12/95	Diesel			TD3287
21 1.9 D	09/89→01/94	F8Q 710			
21 Box 1.9 D	06/86→08/94		4cyl.		
21 Estate 1.9 D	03/86→08/94		1870cc	47kW (64PS)	
21 Saloon 1.9 D	08/89→10/93	Diesel			TD3288
Clio I 1.9 D, Clio I Box 1.9 D	01/91→09/98	F8Q 714			
			4cyl.		
			1870cc	47-48kW (64-65PS)	
		Diesel			TD3289
Rapid Box 1.9 D	09/91→03/98	F8Q 722			
			4cyl.		
			1870cc	47-48kW (64-67PS)	
		Diesel			TD3290
Rapid Box 1.9 D	09/91→03/98	F8Q 724			
			4cyl.		
			1870cc	47-48kW (64-67PS)	
		Diesel			TD3291





Clio I 1.9 D, Clio I Box 1.9 D		01/91→09/98	F8Q 730	4cyl. 1870cc	47-48kW (64-65PS)	Diesel	TD4868		
Clio I 1.9 D, Clio I Box 1.9 D		01/91→09/98	F8Q 732	4cyl. 1870cc	47-48kW (64-65PS)	Diesel	TD4869		
19 I 1.9 D		09/88→04/92	F8Q 742	4cyl. 1870cc	47-48kW (64-65PS)	Diesel	TD3295		
19 I Box 1.9 D		01/88→12/92							
19 I Chamade 1.9 D		10/89→04/92							
19 II 1.9 D		04/92→12/95							
19 II Box 1.9 D		03/92→12/95							
19 II Chamade 1.9 D		04/92→12/95							
19 1.9 D		05/92→12/01	F8Q 764	4cyl. 1870cc	47kW (64PS)	Diesel	TD3297		
Rapid Box 1.9 D		09/91→03/98	F8Q 774	4cyl. 1870cc	47-48kW (64-67PS)	Diesel	TD3298		
Rapid Box 1.9 D		09/91→03/98	F8Q 776	4cyl. 1870cc	47-48kW (64-67PS)	Diesel	TD3299		
08-336500-00	STD	80.00	2.000		001 MO P		KV1		
08-336505-00	0.25mm					005 IFU P		IKA	
08-336507-00	0.50mm				2.000		231 CR P		STD
08-336510-00	0.80mm				3.000				
[R66330]									
19 I 1.9 DT		09/90→04/92	F8Q 610	4cyl. 1870cc	69-66kW (94-90PS)	Diesel Turbo	TD19666		
Rapid 1.9 D		04/97→09/97	F8Q 648	4cyl. 1870cc	66kW (89PS)	Diesel Turbo	TD21251		
19 I Chamade 1.9 TD		09/90→04/92	F8Q 740	4cyl. 1870cc	66-68kW (90-93PS)	Diesel Turbo	TD3294		
19 II Box 1.9 dT		03/92→12/95							
19 II 1.9 dT		04/92→12/95	F8Q 744	4cyl. 1870cc	66kW (89PS)	Diesel Turbo	TD3296		
19 II Chamade 1.9 D		05/92→11/95							
19 II Chamade 1.9 dT		04/92→12/95							
Megane I 1.9 dT			F8Q 768	4cyl. 1870cc	66kW (89PS)	Diesel Turbo	TD19234		

22





Megane I 1.9 D		04/96→02/01	F8Q 784			
Megane I 1.9 dT		01/96→08/03		4cyl.		
Megane I 1.9 TDI,		09/96→08/03		1870cc	66-69kW (90-94PS)	
Megane I Classic 1.9 dT,			Diesel	Turbo		
Megane I Classic 1.9 TDI						
Megane Scenic 1.9 dT		01/97→09/99				TD4870
Megane I 1.9 dT		01/96→08/03	F8Q 785			
Megane I Classic 1.9 dT		09/96→08/03		4cyl.		
Megane Scenic 1.9 dT		01/97→09/99		1870cc	68-70kW (92-95PS)	
			Diesel	Turbo		TD22363
Megane I 1.9 dT		01/96→08/03	F8Q 786			
Megane I Classic 1.9 dT		09/96→08/03		4cyl.		
Megane Scenic 1.9 dT		01/97→09/99		1870cc	66kW (89PS)	
			Diesel	Turbo		TD16352
08-103500-00	STD	80.00	2.500		001 IF CK P	KV1
08-103507-00	0.50mm		2.000		005 IFU NT	IKA
[R67500]			3.000		231 CR P	GOE13
08-105100-00	STD	80.00	2.000		001 IF CK P	KV1
08-105107-00	0.50mm		2.000		005 IFU P	IKA
[R60270]			3.000		231 CR P	STD
08-111800-00	STD	80.00	2.500		008 P PS	KV1
08-111807-00	0.50mm		2.000		005 IFU P	IKA
→01/1997			3.000		231 CR P	STD
[R60500]						
Laguna II 1.9 dCi,			F9Q 650			
Laguna II Grandtour 1.9 dCi,				4cyl.		23
Megane II 1.9 dCi				1870cc	88kW (120PS)	
			Diesel	Turbo Intercooled		TD21223
Laguna II 1.9 dCi,		03/04→	F9Q 664			
Laguna II Grandtour 1.9 dCi				4cyl.		
				1870cc	68kW (92PS)	
			Diesel	Turbo Intercooled		TD19677
Laguna II 1.9 dCi,		03/01→	F9Q 670			
Laguna II Grandtour 1.9 dCi				4cyl.		
				1870cc	88kW (120PS)	
			Diesel	Turbo Intercooled		TD21224
Laguna II 1.9 dCi,		03/01→	F9Q 674			
Laguna II Grandtour 1.9 dCi				4cyl.		
				1870cc	82kW (111PS)	
			Diesel	Turbo Intercooled		TD21225
Laguna II 1.9 dCi,		03/01→	F9Q 750			
Laguna II Grandtour 1.9 dCi				4cyl.		
				1870cc	55-88kW (75-120PS)	
			Diesel	Turbo Intercooled		TD17028
Laguna II 1.9 dCi		03/01→	F9Q 756			
Laguna II Grandtour 1.9 dCi				4cyl.		
				1870cc	88kW (120PS)	
			Diesel	Turbo Intercooled		TD17064



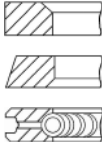

Laguna II 1.9 dCi, Laguna II Grandtour 1.9 dCi	01/05→	F9Q 758	4cyl. 1870cc 96kW (131PS)	Diesel Turbo Intercooled	TD19678
Laguna II 1.9 dCi, Laguna II Grandtour 1.9 dCi	05/05→	F9Q 759	4cyl. 1870cc 96kW (131PS)	Diesel Turbo Intercooled	TD19679
Megane II 1.9 dCi Megane II Coupé-Cabriolet 1.9 dCi Megane II Estate 1.9 dCi Megane II Saloon 1.9 dCi	11/02→ 09/03→ 08/03→ 09/03→	F9Q 800	4cyl. 1870cc 55-88kW (75-120PS)	Diesel Turbo Intercooled	TD16535
Megane II 1.9 dCi Megane II Estate 1.9 dCi Megane II Saloon 1.9 dCi	11/02→ 03/04→ 09/03→	F9Q 808	4cyl. 1870cc 66-75kW (90-102PS)	Diesel Turbo Intercooled	TD21147
Grand Scénic II 1.9 dCi Scénic II 1.9 D Scénic II 1.9 dCi	04/04→ 06/06→ 06/03→	F9Q 812	4cyl. 1870cc 88kW (120PS)	Diesel Turbo Intercooled	TD20392
Grand Scénic II 1.9 dCi Megane II 1.9 dCi Megane II Coupé-Cabriolet 1.9 dCi Megane II Saloon 1.9 dCi, Scénic II 1.9 dCi	05/05→ 11/02→ 09/03→ 05/05→	F9Q 816	4cyl. 1870cc 81-96kW (110-131PS)	Diesel Turbo Intercooled	TD22184
Grand Scénic II 1.9 dCi Megane II 1.9 dCi Megane II Coupé-Cabriolet 1.9 dCi Megane II Estate 1.9 dCi, Megane II Saloon 1.9 dCi, Scénic II 1.9 dCi	05/05→ 11/02→ 09/03→ 05/05→	F9Q 818	4cyl. 1870cc 81-96kW (110-131PS)	Diesel Turbo Intercooled	TD22185
Espace IV 1.9 dCi	11/02→	F9Q 820	4cyl. 1870cc 88kW (120PS)	Diesel Turbo Intercooled	TD18287
Espace IV 1.9 dCi	11/02→	F9Q 826	4cyl. 1870cc 88kW (120PS)	Diesel Turbo Intercooled	TD18288
08-422300-00 08-422307-00	STD 0.50mm	80.00	2.500 2.000 3.000	 001 IF MO P 005 IFU P 231 CR P	KV1 IKA STD
Laguna Grandtour 1.9 dTi, Laguna I 1.9 dTi	10/97→03/01	F9Q 710	4cyl. 1870cc 74kW (100PS)	Diesel Turbo Intercooled	TD16190
Laguna Grandtour 1.9 dTi, Laguna I 1.9 dTi	10/97→03/01	F9Q 717	4cyl. 1870cc 72-75kW (98-102PS)	Diesel Turbo Intercooled	TD21136
Laguna Grandtour 1.9 dCi, Laguna I 1.9 dCi Laguna II 1.9 dCi, Laguna II Grandtour 1.9 dCi	09/99→03/01 03/01→	F9Q 718	4cyl. 1870cc 72kW (98PS)	Diesel Turbo Intercooled	TD16192

24





Megane I 1.9 dTi, Megane I Classic 1.9 dTi Megane Scenic 1.9 dTi	03/97→02/01 04/97→09/99	F9Q 730	4cyl. 1870cc 72kW (98PS)	Diesel Turbo Intercooled	TD11427
Megane I 1.9 dCi Megane I Classic 1.9 dCi, Megane I Coach 1.9 dCi, Megane I Grandtour 1.9 dCi Scénic I 1.9 dCi Scénic I 1.9 dCi RX4	03/99→08/03 02/01→08/03 09/99→08/03 12/02→08/03	F9Q 732	4cyl. 1870cc 72kW (98PS)	Diesel Turbo Intercooled	TD16347
Megane I 1.9 dCi Megane I Classic 1.9 dCi Megane I Coach 1.9 dCi, Megane I Grandtour 1.9 dCi Scénic I 1.9 dCi	02/01→08/03 03/99→08/03 02/01→08/03 09/99→08/03	F9Q 733	4cyl. 1870cc 79-88kW (107-120PS)	Diesel Turbo Intercooled	TD16363
Megane I 1.9 dTi, Megane I Classic 1.9 dTi, Megane I Coach 1.9 dTi Megane Scenic 1.9 dTi Scénic I 1.9 dTi	03/97→02/01 04/97→09/99 09/99→08/03	F9Q 734	4cyl. 1870cc 72kW (98PS)	Diesel Turbo Intercooled	TD11428
Megane I 1.9 dTi, Megane I Classic 1.9 dTi, Megane I Coach 1.9 dTi Megane I Grandtour 1.9 dTi Scénic I 1.9 dTi	03/97→02/01 03/99→02/01 09/99→08/03	F9Q 736	4cyl. 1870cc 72kW (98PS)	Diesel Turbo Intercooled	TD16354
Megane I 1.9 DCi Megane I Classic 1.9 dCi, Megane I Grandtour 1.9 dCi	03/99→08/03 02/01→08/03	F9Q 738	4cyl. 1870cc 74-79kW (101-107PS)	Diesel Turbo Intercooled	TD21137
Scénic I 1.9 dCi RX4	11/00→08/03	F9Q 740	4cyl. 1870cc 72kW (98PS)	Diesel Turbo Intercooled	TD16341
Megane I 1.9 dTi, Megane I Classic 1.9 dTi, Megane I Grandtour 1.9 dTi, Scénic I 1.9 dTi	02/01→08/03	F9Q 744	4cyl. 1870cc 59kW (80PS)	Diesel Turbo Intercooled	TD16361
Scénic I 1.9 dCi RX4	12/02→08/03	F9Q 748	4cyl. 1870cc 75-79kW (102-107PS)	Diesel Turbo Intercooled	TD21138
Laguna II 1.9 dCi, Laguna II Grandtour 1.9 dCi	06/01→	F9Q 752	4cyl. 1870cc 74kW (100PS)	Diesel Turbo Intercooled	TD21139
Laguna II 1.9 dCi, Laguna II Grandtour 1.9 dCi	03/01→	F9Q 754	4cyl. 1870cc 74-79kW (101-107PS)	Diesel Turbo Intercooled	TD20841
Trafic II Box 1.9 dCi, Trafic II Box 1.9 dCi 100, Trafic II Box 1.9 dCi 80, Trafic II Bus 1.9 dCi 100, Trafic II Platform/Chassis 1.9 dCi 100	03/01→	F9Q 760	4cyl. 1870cc 74kW (100PS)	Diesel Turbo Intercooled	TD16529





Trafic II Box 1.9 dCi	04/01→07/03	F9Q 762					
Trafic II Box 1.9 dCi 80	03/01→		4cyl.				
Trafic II Bus 1.9 dCi	04/01→07/03		1870cc	60kW (81PS)			
Trafic II Bus 1.9 dCi 80	03/01→	Diesel	Turbo Intercooled				
Trafic II Platform/Chassis 1.9 dCi	09/01→07/03						
Trafic II Platform/Chassis 1.9 dCi 80	03/01→						TD18691
Master II Box 1.9 dTi,	09/00→	F9Q 770					
Master II Bus 1.9 dTi			4cyl.				
			1870cc	59kW (80PS)			
		Diesel	Turbo Intercooled				TD15688
Master II Box 1.9 dCi 80,	11/01→	F9Q 772					
Master II Bus 1.9 dCi 80			4cyl.				
			1870cc	60kW (81PS)			
		Diesel	Turbo Intercooled				TD16304
Master II Box 1.9 dCi 80,	11/01→	F9Q 774					
Master II Bus 1.9 dCi 80			4cyl.				
			1870cc	60kW (81PS)			
		Diesel	Turbo Intercooled				TD19370
Clio II 1.9 dTi	12/99→05/05	F9Q 780					
Clio II Box 1.9 DTi	02/00→05/01		4cyl.				
Kangoo 1.9 dTi, Kangoo Express 1.9 dTi	02/00→		1870cc	72kW (98PS)			
		Diesel	Turbo Intercooled				TD16339
Kangoo 1.9 dCi 4x4	10/01→	F9Q 782					
Kangoo Express 1.9 dCi	07/03→		4cyl.				
Kangoo Express 1.9 dCi 4x4	10/01→		1870cc	59kW (80PS)			
		Diesel	Turbo Intercooled				TD17498
Kangoo 1.9 dCi 4x4	10/01→	F9Q 790					
Kangoo Express 1.9 dCi	07/03→		4cyl.				
Kangoo Express 1.9 dCi 4x4	10/01→		1870cc	59kW (80PS)			
		Diesel	Turbo Intercooled				TD16358
08-101500-00	STD	80.00	2.500		001 IF P		KV1
08-101507-00	0.50mm		2.000		005 IFU P		IKA
→01/2000			3.000		231 CR P		STD
[R60260]							
08-113700-00	STD	80.00	2.500		001 IF CK P		KV1
01/2000→			2.000		005 IFU P		IKA
			3.000		231 CR P		STD
Trafic Box 1.7	08/92→08/94	F1N 720					
			4cyl.				
			1721cc	50kW (68PS)			
							25
							TD3216
Trafic Platform/Chassis 1.7	06/86→08/94	F1N 722					
			4cyl.				
			1721cc	50kW (68PS)			
							TD3217
Trafic Box 1.7, Trafic Bus 1.7	06/86→08/94	F1N 724					
			4cyl.				
			1721cc	50kW (68PS)			
							TD3218





9 1.7 11 1.7	09/84→12/88 10/83→12/87	F2N 700	4cyl. 1721cc	59kW (80PS)	TD3219
9 1.7 11 1.7	09/84→12/88 10/83→12/87	F2N 704	4cyl. 1721cc	59kW (80PS)	TD3220
9 1.7, 11 1.7	10/86→12/88	F2N 708	4cyl. 1721cc	65kW (88PS)	TD3221
9 1.7, 11 1.7 21 Box 1.7 21 Estate 1.7 21 Saloon 1.7	10/86→12/88 06/86→04/95 10/86→12/88 03/86→03/93	F2N 710	4cyl. 1721cc	65kW (88PS)	TD3222
21 1.7	07/89→05/93	F2N 711	4cyl. 1721cc	65kW (88PS)	TD3223
21 1.7 21 Estate 1.7 21 Saloon 1.7	07/89→05/93 06/86→03/93 03/86→12/87	F2N 712	4cyl. 1721cc	55kW (75PS)	TD3224
21 1.7 21 Estate 1.7 21 Saloon 1.7	07/89→05/93 06/86→03/93 03/86→12/87	F2N 716	4cyl. 1721cc	56kW (76PS)	TD3226
19 I Chamade 1.7 19 II Chamade 1.7	09/88→12/92 01/93→08/95	F2N 720	4cyl. 1721cc	65-68kW (88-92PS)	TD4862
19 I Chamade 1.7 19 II Chamade 1.7	09/88→12/92 01/93→08/95	F2N 721	4cyl. 1721cc	68kW (92PS)	TD3228
19 I Chamade 1.7 19 II Chamade 1.7	09/88→12/92 01/93→08/95	F2N 722	4cyl. 1721cc	66-69kW (90-94PS)	TD3229
19 I Cabriolet 1.7	07/91→04/92	F2N 724	4cyl. 1721cc	55-56kW (75-76PS)	TD3230
19 I 1.7		F2N 726	4cyl. 1721cc	68kW (92PS)	TD3231
19 I Chamade 1.7		F2N 727	4cyl. 1721cc	68kW (92PS)	TD3232
19 I 1.7		F2N 728	4cyl. 1721cc	55kW (75PS)	TD3233





9 1.7, 11 1.7	10/86→12/88	F2N 730	4cyl. 1721cc	54-55kW (73-75PS)	TD3234
11 1.7	06/87→12/88	F2N 732	4cyl. 1721cc	64kW (87PS)	TD3235
Super 5 1.7	06/87→03/95	F2N 740	4cyl. 1721cc	64-66kW (87-90PS)	TD3236
11 1.7 Super 5 1.7	06/87→12/88 06/87→03/95	F2N 742	4cyl. 1721cc	64-66kW (87-90PS)	TD4861
21 Estate 1.7 21 Saloon 1.7	06/86→12/89 07/86→02/94	F2N 750	4cyl. 1721cc	54kW (73PS)	TD3238
21 Estate 1.7, 21 Saloon 1.7	06/87→04/89	F2N 752	4cyl. 1721cc	64kW (87PS)	TD3239
21 1.7	07/89→05/93	F2N 753	4cyl. 1721cc	60-66kW (82-90PS)	TD22362
21 1.7	07/89→05/93	F2N 754	4cyl. 1721cc	65kW (88PS)	TD3240
21 1.7	07/89→05/93	F2N 758	4cyl. 1721cc	56-66kW (76-90PS)	TD3241
Clio I 1.7	01/91→12/93	F2N 770	4cyl. 1721cc	66-68kW (90-92PS)	TD3242
		F2N 783	4cyl. 1721cc	65kW (88PS)	TD3243
21 1.7	07/89→05/93	F2N 786	4cyl. 1721cc	59kW (80PS)	TD3244
9 1.7, 11 1.7	10/86→12/88	F2N 796	4cyl. 1721cc	59kW (80PS)	TD3245
9 1.7, 11 1.7	10/86→12/88	F2N 797	4cyl. 1721cc	59kW (80PS)	TD3246





9 1.7, 11 1.7	10/86→12/88	F2N 798	4cyl. 1721cc	65kW (88PS)	TD3247
Super 5 1.7 i	10/86→08/91	F3N 702	4cyl. 1721cc	68-69kW (92-94PS)	TD3249
9 1.7, 11 1.7	06/87→12/88	F3N 708	4cyl. 1721cc	69kW (93PS)	TD3250
Super 5 1.7	10/86→03/95	F3N 716	4cyl. 1721cc	54-55kW (73-75PS)	TD3251
Super 5 1.7	10/86→03/95	F3N 717	4cyl. 1721cc	54-55kW (73-75PS)	TD3252
9 1.7 11 1.7	10/86→12/88 10/84→12/88	F3N 718	4cyl. 1721cc	54-55kW (73-75PS)	TD4863
21 1.7 21 Estate 1.7 21 Saloon 1.7 Super 5 1.7 i	09/89→06/94 06/86→12/93 03/86→02/94 10/86→08/91	F3N 722	4cyl. 1721cc	66-70kW (90-95PS)	TD3254
21 1.7 21 Estate 1.7 21 Saloon 1.7	09/89→06/94 06/86→12/93 03/86→02/94	F3N 723	4cyl. 1721cc	66-70kW (90-95PS)	TD3255
21 1.7 21 Estate 1.7 21 Saloon 1.7	07/89→05/93 05/88→06/93 07/86→02/94	F3N 726	4cyl. 1721cc	54kW (73PS)	TD3256
19 I 1.7 19 I Chamade 1.7 19 II 1.7, 19 II Chamade 1.7	09/88→04/92 10/89→04/92 04/92→12/95	F3N 740	4cyl. 1721cc	54-55kW (73-75PS)	TD3257
19 I 1.7 19 I Chamade 1.7 19 II 1.7, 19 II Chamade 1.7	09/88→04/92 10/89→04/92 04/92→12/95	F3N 741	4cyl. 1721cc	54-55kW (73-75PS)	TD3258
19 I 1.7 19 I Cabriolet 1.7 19 I Chamade 1.7 19 II Cabriolet 1.7 19 II Chamade 1.7	09/88→04/92 07/91→04/92 07/88→04/92 04/92→09/93 04/92→12/95	F3N 742	4cyl. 1721cc	66-70kW (90-95PS)	TD3259
19 I 1.7 19 I Cabriolet 1.7 19 I Chamade 1.7 19 II 1.7 19 II Cabriolet 1.7 19 II Chamade 1.7	09/88→04/92 07/91→04/92 07/88→04/92 04/92→12/95 04/92→09/93 04/92→12/95	F3N 743	4cyl. 1721cc	66kW (89PS)	TD3260





19 I Chamade 1.7			08/88→12/92	F3N 746				
19 II 1.7			05/92→09/94		4cyl.			
					1721cc	66-80kW (90-109PS)	TD3261	
08-335100-00	STD	81.00	1.750		001 IF MO P		IKA	
08-335105-00	0.25mm		2.000		026 P		STD	
08-335107-00	0.50mm		3.000		712 CR		ST	
[R66260]								
19 I Chamade 1.8 16V			06/89→08/90	F7P 700			26	
					4cyl.			
					1763cc	101kW (137PS)	TD3277	
19 I 1.8 16V			06/89→04/92	F7P 704				
19 I Cabriolet 1.8 16V			07/91→04/92		4cyl.			
19 I Chamade 1.8 16V			10/89→04/92		1763cc	101kW (137PS)		
19 II 1.8 16V			04/92→12/95					
19 II Cabriolet 1.8 16V			04/92→06/96					
19 II Chamade 1.8 16V			04/92→12/95				TD3278	
Clio I 1.8 16V				F7P 720				
					4cyl.			
					1763cc	101kW (137PS)	TD3279	
Clio I 1.8 16V			01/91→03/96	F7P 722				
					4cyl.			
					1763cc	101kW (137PS)	TD3280	
08-336600-00	STD	82.00	1.500		001 IF MO P		KV1	
[R66280]				1.500		005 IFU P		STD
				3.000		236 P		STD
Laguna Grandtour 1.8			09/95→03/01	F3P 670			27	
Laguna I 1.8			08/95→03/01		4cyl.			
					1794cc	66kW (89PS)	TD5541	
Laguna Grandtour 1.8			09/95→03/01	F3P 678				
Laguna I 1.8			08/95→03/01		4cyl.			
					1794cc	66kW (89PS)	TD5542	
Clio I 1.8			01/91→09/98	F3P 710				
					4cyl.			
					1794cc	70kW (95PS)	TD3267	
Clio I 1.8 Rsi			01/93→08/95	F3P 712				
					4cyl.			
					1794cc	70kW (95PS)	TD3268	
Clio I 1.8			01/91→09/98	F3P 714				
					4cyl.			
					1794cc	70kW (95PS)	TD3269	











Laguna Grandtour 1.8 Laguna I 1.8	09/95→03/01 11/93→03/01	F3P 720	4cyl. 1794cc	66-69kW (90-94PS)	TD3270
Laguna Grandtour 1.8 Laguna I 1.8	09/95→03/01 11/93→03/01	F3P 724	4cyl. 1794cc	66-69kW (90-94PS)	TD3271
Clio I 1.8	08/94→09/98	F3P 754	4cyl. 1794cc	70kW (95PS)	TD5523
Clio I 1.8	08/90→09/98	F3P 755	4cyl. 1794cc	70kW (95PS)	TD3272
Clio I 1.8 Rsi	08/95→09/98	F3P 758	4cyl. 1794cc	70kW (95PS)	TD3273
Laguna Grandtour 2.0 Laguna I 2.0	09/95→03/01 11/93→03/01	F3R 722	4cyl. 1998cc	70kW (95PS)	TD3275
Laguna Grandtour 2.0 Laguna I 2.0	09/95→03/01 11/93→03/01	F3R 723	4cyl. 1998cc	70kW (95PS)	TD3276
Espace III 2.0	11/96→10/00	F3R 728	4cyl. 1998cc	84kW (114PS)	TD16177
Espace III 2.0	11/96→10/00	F3R 729	4cyl. 1998cc	84kW (114PS)	TD16178
Megane I 2.0 i Megane I Cabriolet 2.0 Megane I Classic 2.0 i Megane I Coach 2.0 i Megane Scenic 2.0 i Megane Scenic 2.0 RXE 4x4	01/96→08/03 04/97→08/03 09/96→08/03 03/96→08/03 01/97→09/99 05/97→10/99	F3R 750	4cyl. 1998cc	84kW (114PS)	TD4865

08-337400-00	STD	82.70	1.500		001 IW P PS	KV1
[R67580]			1.750		005 IFU P	STD
			3.000		231 CR P	STD



Clio I Williams		01/94→09/98	F7R 700	4cyl. 1998cc	108-110kW (147-150PS)	28
TD3281						
Megane I 2.0 16V		07/96→08/03	F7R 710	4cyl. 1998cc	108-110kW (147-150PS)	
Megane I Cabriolet 2.0 16V		10/96→11/99				
Megane I Coach 2.0 16V		03/96→11/99				
Sport Spider 2.0		12/95→08/96				
Sport Spider 2.0 16V		03/95→10/99				TD4866
Megane I 2.0 16V		07/96→08/03	F7R 714	4cyl. 1998cc	108kW (147PS)	
Megane I Cabriolet 2.0 16V		10/96→11/99				
Megane I Coach 2.0 16V		03/96→11/99				TD16278
08-337700-00	STD	82.70	1.200	 001 IF NT		ST
[R67450]			1.500	 026 P		F12/F14
			2.500	 231 CR P		STD
Laguna Grandtour 2.0 16V		09/95→03/01	N7Q 700	4cyl. 1948cc	102kW (139PS)	29
TD5529						
Laguna I 2.0		06/95→02/01				
Laguna I 2.0 16V		06/95→03/01				
Laguna Grandtour 2.0 16V		09/95→03/01	N7Q 704	4cyl. 1948cc	102kW (139PS)	
Laguna I 2.0		06/95→02/01				
Laguna I 2.0 16V		06/95→03/01				TD5530
Safrane II 2.0 16V		07/96→12/00	N7Q 710	4cyl. 1948cc	100kW (136PS)	
TD5547						
Safrane II 2.0 16V		07/96→12/00	N7Q 711	4cyl. 1948cc	100kW (136PS)	
TD5548						
08-104500-00	STD	83.00	1.200	 005 NT		ST
[R66760]			1.500	 026 P		STD
			2.500	 712 CR		ST
Grand Scénic III 2.0 dCi		04/09→	M9R 610	4cyl. 1995cc	118kW (160PS)	30
TD23557						
Megane CC 2.0 dCi		06/10→				
Megane III Coupe 2.0 dCi,		04/09→	Diesel	Turbo Intercooled		
Megane III Grandtour 2.0 dCi,						
Megane III Hatchback 2.0 dCi,						
Scénic III 2.0 dCi						
Grand Scénic III 2.0 dCi		02/09→	M9R 615	4cyl. 1995cc	110kW (150PS)	
Megane III Coupe 2.0 dCi		04/09→				
Megane III Grandtour 2.0 dCi,		10/10→	Diesel	Turbo Intercooled		
Megane III Hatchback 2.0 dCi						
Scénic III 2.0 dCi		02/09→				TD23559
Grand Scénic II 2.0 dCi,		09/05→	M9R 700	4cyl. 1995cc	110kW (150PS)	
Megane II 2.0 dCi,			Diesel	Turbo Intercooled		
Megane II Coupé-Cabriolet 2.0 dCi,						
Megane II Estate 2.0 dCi,						
Megane II Saloon 2.0 dCi,						
Scénic II 2.0 dCi						TD20708





Grand Scénic II 2.0 dCi, Scénic II 2.0 dCi	09/05→	M9R 721	4cyl. 1995cc 110kW (150PS)	Diesel Turbo Intercooled	TD23502
Grand Scénic II 2.0 dCi, Megane II 2.0 dCi, Megane II Coupé-Cabriolet 2.0 dCi, Megane II Estate 2.0 dCi, Megane II Saloon 2.0 dCi, Scénic II 2.0 dCi	09/05→	M9R 722	4cyl. 1995cc 110kW (150PS)	Diesel Turbo Intercooled	TD23503
Megane II 2.0 dCi	01/07→	M9R 724	4cyl. 1995cc 127kW (173PS)	Diesel Turbo Intercooled	TD22195
Espace IV 2.0 dCi Laguna II 2.0 dCi, Laguna II Grandtour 2.0 dCi	01/06→ 08/05→	M9R 740	4cyl. 1995cc 110kW (150PS)	Diesel Turbo Intercooled	TD19680
Laguna III 2.0 dCi, Laguna III Grandtour 2.0 dCi	10/07→	M9R 742	4cyl. 1995cc 110kW (150PS)	Diesel Turbo Intercooled	TD23504
Laguna III 2.0 dCi, Laguna III Grandtour 2.0 dCi	10/07→	M9R 744	4cyl. 1995cc 110kW (150PS)	Diesel Turbo Intercooled	TD23505
Laguna III 2.0 dCi, Laguna III Grandtour 2.0 dCi	10/07→	M9R 746	4cyl. 1995cc 110kW (150PS)	Diesel Turbo Intercooled	TD23506
Laguna III 2.0 dCi, Laguna III Grandtour 2.0 dCi	10/07→	M9R 748	4cyl. 1995cc 110kW (150PS)	Diesel Turbo Intercooled	TD23507
Espace IV 2.0 dCi	01/06→	M9R 750	4cyl. 1995cc 110kW (150PS)	Diesel Turbo Intercooled	TD23508
Espace IV 2.0 dCi, Laguna II 2.0 dCi, Laguna II Grandtour 2.0 dCi Vel Satis 2.0 dCi	01/06→ 08/05→	M9R 760	4cyl. 1995cc 110kW (150PS)	Diesel Turbo Intercooled	TD19681
Espace IV 2.0 dCi	01/06→	M9R 761	4cyl. 1995cc 127kW (173PS)	Diesel Turbo Intercooled	TD23899
Espace IV 2.0 dCi, Vel Satis 2.0 dCi	01/06→	M9R 762	4cyl. 1995cc 127kW (173PS)	Diesel Turbo Intercooled	TD23900
Espace IV 2.0 dCi, Vel Satis 2.0 dCi	01/06→	M9R 763	4cyl. 1995cc 127kW (173PS)	Diesel Turbo Intercooled	TD23901





Trafic II Box 2.0 dCi 115, Trafic II Box 2.0 dCi 90, Trafic II Bus 2.0 dCi 115, Trafic II Platform/Chassis 2.0 dCi 115, Trafic II Platform/Chassis 2.0 dCi 90	08/06→	M9R 780 Euro 4 4cyl. 1995cc 84-66kW (114-90PS) Diesel Turbo Intercooled	TD19714
Trafic II Box 2.0 dCi 115, Trafic II Box 2.0 dCi 90, Trafic II Bus 2.0 dCi 115, Trafic II Bus 2.0 dCi 90, Trafic II Platform/Chassis 2.0 dCi 115, Trafic II Platform/Chassis 2.0 dCi 90	08/06→	M9R 782 4cyl. 1995cc 66kW (89PS) Diesel Turbo Intercooled	TD23109
Trafic II Box 2.0 dCi 115, Trafic II Bus 2.0 dCi 115, Trafic II Platform/Chassis 2.0 dCi 115	08/06→	M9R 786 Euro 4 4cyl. 1995cc 66kW (89PS) Diesel Turbo Intercooled	TD24966
Laguna Coupe 2.0 dCi Laguna III 2.0 dCi, Laguna III Grandtour 2.0 dCi	09/08→ 01/08→	M9R 800 4cyl. 1995cc 127kW (173PS) Diesel Turbo Intercooled	TD22196
Espace IV 2.0 dCi Laguna Coupe 2.0 dCi Laguna III 2.0 dCi, Laguna III Grandtour 2.0 dCi	01/06→ 09/08→ 10/07→	M9R 802 4cyl. 1995cc 96kW (131PS) Diesel Turbo Intercooled	TD22197
Laguna Coupe 2.0 dCi Laguna III 2.0 dCi, Laguna III Grandtour 2.0 dCi	09/08→ 01/08→	M9R 809 4cyl. 1995cc 127kW (173PS) Diesel Turbo Intercooled	TD22198
Laguna Coupe 2.0 dCi GT, Laguna III 2.0 dCi GT, Laguna III Grandtour 2.0 dCi GT	03/08→	M9R 816 4cyl. 1995cc 127-132kW (173-180PS) Diesel Turbo Intercooled	TD22199
Koleos 2.0 dCi, Koleos 2.0 dCi 4x4	09/08→	M9R 830 4cyl. 1995cc 127kW (173PS) Diesel Turbo Intercooled	TD22206
Koleos 2.0 dCi, Koleos 2.0 dCi 4x4	09/08→	M9R 832 4cyl. 1995cc 110kW (150PS) Diesel Turbo Intercooled	TD22207
Grand Scenic 2.0 dCi	09/05→	M9R A 700 Euro 4 4cyl. 1995cc 110kW (150PS) Diesel Turbo Intercooled	TD19684
Scenic 2.0 dCi	09/05→	M9R B 721 Euro 4 4cyl. 1995cc 110kW (150PS) Diesel Turbo Intercooled	TD19685
Laguna III 2.0 dCi	10/07→	M9Ra 742 Euro 4 4cyl. 1995cc 96-110kW (131-150PS) Diesel Turbo Intercooled	TD20818

08-422000-00	STD	84.00	2.500		007 MOL P	KV1
08-422007-00	0.50mm		2.000		005 IFU MOL P	GOE12
			2.000		231 CR P	GOE12



Master III Box 2.3 dCi FWD	02/10→	M9T 670 Euro 5			31
Master III Bus 2.3 dCi 100 FWD,	02/11→	4cyl.			
Master III Bus 2.3 dCi 125 FWD		2298cc	74-92kW (101-125PS)		
Master III Platform/Chassis 2.3 dCi FWD	02/10→	Diesel	Turbo Intercooled		TD24269
Master III Box 2.3 dCi FWD	02/10→	M9T 672 Euro 5			
Master III Bus 2.3 dCi 100 FWD,	02/11→	4cyl.			
Master III Bus 2.3 dCi 125 FWD		2298cc	74-92kW (101-125PS)		
Master III Platform/Chassis 2.3 dCi FWD	02/10→	Diesel	Turbo Intercooled		TD25154
Master III Box 2.3 dCi FWD	02/10→	M9T 676 Euro 4			
Master III Bus 2.3 dCi 100 FWD,	02/11→	4cyl.			
Master III Bus 2.3 dCi 125 FWD		2298cc	74-92kW (101-125PS)		
Master III Platform/Chassis 2.3 dCi FWD	02/10→	Diesel	Turbo Intercooled		TD24268
Master III Box 2.3 dCi FWD,	02/10→	M9T 678			
Master III Platform/Chassis 2.3 dCi FWD		4cyl.			
		2298cc	107kW (146PS)		
		Diesel	Turbo Intercooled		TD25158
Master III Box 2.3 dCi FWD	02/10→	M9T 680			
Master III Bus 2.3 dCi FWD	02/11→	4cyl.			
Master III Platform/Chassis 2.3 dCi FWD	02/10→	2298cc	107kW (146PS)		
		Diesel	Turbo Intercooled		TD24295
Master III Box 2.3 dCi [RWD],	02/10→	M9T 686 Euro 5			
Master III Platform/		4cyl.			
Chassis 2.3 dCi [RWD]		2298cc	92kW (125PS)		
		Diesel	Turbo		TD25151
Master III Box 2.3 dCi [RWD],	02/10→	M9T 690 Euro 5			
Master III Platform/		4cyl.			
Chassis 2.3 dCi [RWD]		2298cc	92kW (125PS)		
		Diesel	Turbo Intercooled		TD24270
Master III Box 2.3 dCi [RWD],	02/10→	M9T 692 Euro 4			
Master III Platform/		4cyl.			
Chassis 2.3 dCi [RWD]		2298cc	92kW (125PS)		
		Diesel	Turbo Intercooled		TD24271
Master III Box 2.3 dCi [RWD],	02/10→	M9T 694 Euro 4			
Master III Box 2.3 dCi FWD,		4cyl.			
Master III Platform/		2298cc	107kW (146PS)		
Chassis 2.3 dCi [RWD]		Diesel	Turbo Intercooled		TD24272
Master III Box 2.3 dCi [RWD],	02/10→	M9T 696 Euro 4			
Master III Box 2.3 dCi FWD,		4cyl.			
Master III Platform/		2298cc	92-107kW (125-146PS)		
Chassis 2.3 dCi [RWD]		Diesel	Turbo		TD25150
Master III Box 2.3 dCi [RWD],	02/10→	M9T 698 Euro 5			
Master III Box 2.3 dCi FWD,		4cyl.			
Master III Platform/		2298cc	107kW (146PS)		
Chassis 2.3 dCi [RWD]		Diesel	Turbo Intercooled		TD24273

08-435200-00
08-435207-00

STD
0.50mm

85.00

2.500
2.000
2.000



007 GDC P

KV1



005 IF MO P

GOE13



231 CR P

GOE13





20 2.1 Diesel		10/80→12/83	852		4cyl. 2068cc	47kW (64PS)	32
					Diesel		TD3077
18 2.1 Diesel, 18 Box 2.1 Diesel 18 Variable 2.1 Diesel		11/81→07/86 11/80→07/86	852 710		4cyl. 2068cc	49kW (67PS)	
					Diesel		TD3078
Trafic Bus 2.1 D Trafic Platform/Chassis 2.1 D Trafic Platform/Chassis 2.1 D [RWD]		05/89→06/94 03/80→04/89 05/89→06/94	852 720		4cyl. 2068cc	43-44kW (58-60PS)	
					Diesel		TD3079
Trafic Box 2.1 D Trafic Box 2.1 D 4x4 Trafic Bus 2.1 D Trafic Bus 2.1 D 4x4 Trafic Platform/Chassis 2.1 D Trafic Platform/Chassis 2.1 D 4x4		09/80→06/94 11/86→04/89 03/80→06/94 05/85→02/89 07/80→04/85 05/85→02/89	852 750		4cyl. 2068cc	43-44kW (58-60PS)	
					Diesel		TD3080
08-334700-10	STD	86.00	2.000		001 IF MO P		KV1
08-334704-10	0.20mm				005 IF P		STD
08-334707-10	0.50mm		2.000		231 CR P		STD
[R66340]			4.000				
18 2.1 TD		03/86→03/92	J8S 120		4cyl. 2068cc	65-66kW (88-90PS)	33
					Diesel		TD3383
Master		09/80→	J8S 232 (852.232)		4cyl. 2068cc	43kW (58PS)	
					Diesel		TD3384
18 2.1		03/86→03/92	J8S 234		4cyl. 2068cc	57kW (77PS)	
					Diesel		TD3385
Espace I 2.1 TD		10/84→12/90	J8S 240		4cyl. 2068cc	65kW (88PS)	
					Diesel	Turbo Intercooled	TD3386
Espace 2.1TD			J8S 604		4cyl. 2068cc	65kW (88PS)	
					Diesel	Turbo	TD3389
Espace II 2.1 TD		01/91→10/96	J8S 610		4cyl. 2068cc	65kW (88PS)	
					Diesel	Turbo Intercooled	TD3390
Espace II 2.1 TD		11/94→10/96	J8S 612		4cyl. 2068cc	66kW (89PS)	
					Diesel	Turbo Intercooled	TD5525
20 2.1 TD 30 2.1 Turbo-D		01/82→12/83 02/82→03/86	J8S 702		4cyl. 2068cc	63kW (86PS)	
					Diesel	Turbo	TD3382











25 2.1 Turbo-D	04/84→12/92	J8S 708	4cyl. 2068cc	63kW (86PS)	Diesel	Turbo Intercooled	TD3393
21 2.1 Turbo-D	09/89→06/94	J8S 714	4cyl. 2068cc	65kW (88PS)	Diesel	Turbo	TD3395
21 Estate 2.1 Turbo-D	10/86→11/93						
21 Saloon 2.1 Turbo-D	03/86→06/94						
25 2.1 Turbo-D	04/84→12/92	J8S 738	4cyl. 2068cc	63kW (86PS)	Diesel	Turbo Intercooled	TD3397
21 2.1 TD	07/86→03/93	J8S 742	4cyl. 2068cc	65kW (88PS)	Diesel	Turbo	TD3399
21 2.1 TD	07/86→03/93	J8S 746	4cyl. 2068cc	65kW (88PS)	Diesel	Turbo	TD3400
Safrane I 2.1 dT	11/93→07/96	J8S 760	4cyl. 2068cc	65-66kW (88-90PS)	Diesel	Turbo	TD3401
Espace II 2.1 RTDT Quadra	01/91→05/92	J8S 772	4cyl. 2068cc	65kW (88PS)	Diesel	Turbo Intercooled	TD3402
Espace II 2.1 TD	01/91→10/96						
Espace I 2.1 TD	10/84→12/90	J8S 774	4cyl. 2068cc	65kW (88PS)	Diesel	Turbo Intercooled	TD3403
Espace II 2.1 TD	01/91→10/96	J8S 776	4cyl. 2068cc	65kW (88PS)	Diesel	Turbo Intercooled	TD3404
Espace II 2.1 TD	01/91→10/96	J8S 778	4cyl. 2068cc	65kW (88PS)	Diesel	Turbo	TD3405
21 2.1 Turbo-D	09/89→06/94	J8S 786 (KAT)	4cyl. 2068cc	65kW (88PS)	Diesel	Turbo	TD3407
21 Estate 2.1 Turbo-D	10/86→11/93						
21 Saloon 2.1 Turbo-D	03/86→06/94						
21 2.1 Turbo-D	09/89→06/94	J8S 788	4cyl. 2068cc	65kW (88PS)	Diesel	Turbo	TD3408
21 Estate 2.1 Turbo-D	10/86→11/93						
21 Saloon 2.1 Turbo-D	03/86→06/94						
Espace 2.1	01/84→10/96	J8S 814	4cyl. 2068cc	65kW (88PS)	Diesel	Turbo Intercooled	TD21257











Espace II 2.1 TD		01/91→10/96	J8S 890	4cyl. 2068cc	65kW (88PS)	
			Diesel	Turbo		TD21258
08-335400-00	STD	86.00	2.500		008 P PS	KV1
→12/1990			2.500		023 P	STD
[R66420]			4.000		231 CR P	STD
08-337000-00	STD	86.00	2.500		008 IF P PS	KV1
01/1991→			2.500		005 IFU P	F12/F14
[R66430]			3.000		231 CR P	STD
Master I Box 28-35 2.1 D		08/80→07/98	J8S 330	4cyl. 2068cc	44kW (60PS)	34
Master I Bus 2.1 D		11/89→04/95				
Master I Bus 28-35 2.1 D		08/80→07/98				
Master I Platform/Chassis 2.1 D		11/89→07/93	Diesel	Turbo		TD3387
21 2.1 D		09/89→12/92	J8S 600	4cyl. 2068cc	53kW (72PS)	
21 Estate 2.1 D		08/89→12/92				
21 Saloon 2.1 D		05/89→06/94	Diesel	Turbo		TD3388
21 2.1 D		07/89→05/93	J8S 704	4cyl. 2068cc	48-49kW (65-67PS)	
21 Box 2.1 D		06/86→08/94				
21 Estate 2.1 D		10/86→09/90	Diesel	Turbo		
21 Estate 2.1 D 4x4		10/88→05/92				
21 Saloon 2.1 D		03/86→12/89				
21 Saloon 2.1 TD		04/86→06/89				TD3391
25 2.1 Diesel		04/84→05/89	J8S 706	4cyl. 2068cc	46kW (63PS)	
			Diesel	Turbo		TD3392
18 2.1 TD		11/81→07/86	J8S 712	4cyl. 2068cc	65kW (88PS)	
Fuego 2.1 TD		08/82→10/85				
			Diesel	Turbo		TD3394
25 2.1 Diesel		06/89→12/92	J8S 736	4cyl. 2068cc	51kW (69PS)	
			Diesel	Turbo		TD3396
21 2.1 D		09/89→12/92	J8S 740	4cyl. 2068cc	53kW (72PS)	
21 Estate 2.1 D		08/89→12/92				
21 Saloon 2.1 D		05/89→06/94	Diesel	Turbo		TD3398
Trafic Box 2.1 D, Trafic Bus 2.1 D, Trafic Platform/Chassis 2.1 D [RWD]		06/94→10/97	J8S 758	4cyl. 2068cc	47kW (64PS)	
			Diesel	Turbo		TD5565
21 2.1 D		07/89→06/94	J8S 784	4cyl. 2068cc	51kW (69PS)	
21 Estate 2.1 D		02/92→09/95				
21 Saloon 2.1 D		10/92→06/94	Diesel	Turbo		TD3406





18 2.1 TD				J8S 852			
				4cyl.			
				2068cc		63kW (86PS)	
				Diesel		TD3081	
08-337100-00	STD	86.00	2.250		001 IF P PS	KV1	
[R66340]	2.000			005 IFU P	F12/F14		
	3.000			231 CR P	STD		
Laguna Grandtour 2.2 D		09/95→03/01		G8T 706			
Laguna I 2.2 D		11/93→03/01		4cyl.			
				2188cc		61kW (82PS)	
				Diesel		TD3301	
Laguna Grandtour 2.2 D		09/95→03/01		G8T 752			
Laguna I 2.2 D		11/93→03/01		4cyl.			
				2188cc		61kW (82PS)	
				Diesel		TD4872	
Laguna Grandtour 2.2 D		09/95→03/01		G8T 790			
Laguna I 2.2 D		11/93→03/01		4cyl.			
				2188cc		61kW (82PS)	
				Diesel		TD4873	
Laguna Grandtour 2.2 D		09/95→03/01		G8T 792			
Laguna I 2.2 D		11/93→03/01		4cyl.			
				2188cc		61kW (82PS)	
				Diesel		TD18886	
Laguna Grandtour 2.2 D		09/95→03/01		G8T 794			
Laguna I 2.2 D		11/93→03/01		4cyl.			
				2188cc		61kW (82PS)	
				Diesel		TD4874	
08-101600-00	STD	87.00	2.500		001 IF MO P	KV1	
[R60390]	1.750			005 P	IKA		
	2.500			231 CR P	STD		



Espace III 2.2 12V TD		11/96→10/00	G8T 714		4cyl. 2188cc 83kW (113PS) Turbo Intercooled	36 TD16308
Espace III 2.2 12V TD Espace III 2.2 D		11/96→10/00 11/97→01/00	G8T 716		4cyl. 2188cc 83kW (113PS) Turbo Intercooled	TD16309
Safrane II 2.2 dT		07/96→12/00	G8T 740		4cyl. 2188cc 83kW (113PS) Turbo Intercooled	TD3300
Espace III 2.2 12V TD Laguna Grandtour 2.2 dT, Laguna I 2.2 dT		11/96→10/00 03/96→03/01	G8T 760		4cyl. 2188cc 83kW (113PS) Turbo Intercooled	TD4871
08-118700-00 →12/1998 [R60630]	STD	87.00	3.500 1.750 2.500	 008 IF P PS  005 IFU NT  231 CR P	KV1 IKA STD	
08-118800-00 01/1999→ [R60640]	STD	87.00	3.000 1.750 2.500	 001 IF P PS  005 IFU NT  231 CR P	KV1 IKA STD	
Laguna II 2.2 dCi, Laguna II Grandtour 2.2 dCi, Vel Satis 2.2 dCi		04/04→	G9T 600 Euro 4		4cyl. 2188cc 110kW (150PS) Diesel Turbo Intercooled	37 TD19667
Laguna II 2.2 dCi		05/05→	G9T 605 Euro 4		4cyl. 2188cc 110kW (150PS) Diesel Turbo Intercooled	TD19682
Vel Satis 2.2 dCi		09/04→	G9T 606 Euro 4		4cyl. 2188cc 102kW (139PS) Diesel Turbo Intercooled	TD21209
Vel Satis 2.2 dCi		09/04→	G9T 607		4cyl. 2188cc 102-110kW (139-150PS) Diesel Turbo Intercooled	TD23896
Espace III 2.2 dCi		10/00→10/02	G9T 642		4cyl. 2188cc 110kW (150PS) Diesel Turbo Intercooled	TD23177
Espace IV 2.2 dCi		02/06→	G9T 645 Euro 4		4cyl. 2188cc 102kW (139PS) Diesel Turbo Intercooled	TD21198
Laguna II 2.2 dCi Vel Satis 2.2 dCi		10/01→ 09/04→	G9T 700		4cyl. 2188cc 110kW (150PS) Diesel Turbo Intercooled	TD20978





Laguna II 2.2 dCi, Laguna II Grandtour 2.2 dCi Vel Satis 2.2 dCi	10/01→ 06/02→	G9T 702	4cyl. 2188cc	95-110kW (130-150PS)	Diesel Turbo Intercooled	TD16288
Vel Satis 2.2 dCi	06/02→	G9T 703	4cyl. 2188cc	110kW (150PS)	Diesel Turbo Intercooled	TD16377
Laguna II 2.2 dCi	10/01→	G9T 704	4cyl. 2188cc	110kW (150PS)	Diesel Turbo Intercooled	TD20975
Laguna II 2.2 dCi, Laguna II Grandtour 2.2 dCi	05/05→	G9T 706	4cyl. 2188cc	102-110kW (139-150PS)	Diesel Turbo Intercooled	TD20976
Laguna II 2.2 dCi, Laguna II Grandtour 2.2 dCi	05/05→	G9T 707	4cyl. 2188cc	102-110kW (139-150PS)	Diesel Turbo Intercooled	TD20977
Espace III 2.2 dCi	07/00→10/02	G9T 710	4cyl. 2188cc	95-110kW (130-150PS)	Diesel Turbo Intercooled	TD16310
Avantime 2.2 dCi	05/02→05/03	G9T 712	4cyl. 2188cc	110kW (150PS)	Diesel Turbo Intercooled	TD18298
Master II Box 2.2 dCi 90, Master II Bus 2.2 dCi 90, Master II Platform/Chassis 2.2 dCi 90	09/00→	G9T 720	4cyl. 2188cc	66kW (89PS)	Diesel Turbo Intercooled	TD14928
Master II Box 2.2 dCi 90, Master II Bus 2.2 dCi 90, Master II Platform/Chassis 2.2 dCi 90	09/00→	G9T 722	4cyl. 2188cc	66kW (89PS)	Diesel Turbo Intercooled	TD16302
Espace IV 2.2 dCi	11/02→	G9T 742	4cyl. 2188cc	110kW (150PS)	Diesel Turbo Intercooled	TD17062
Espace IV 2.2 dCi	11/02→	G9T 743	4cyl. 2188cc	110kW (150PS)	Diesel Turbo Intercooled	TD17063
Master II Box 2.2 dCi 90, Master II Bus 2.2 dCi 90, Master II Platform/Chassis 2.2 dCi 90	09/00→	G9T 750	4cyl. 2188cc	66kW (89PS)	Diesel Turbo Intercooled	TD19088

08-127400-00	STD	87.00	3.000		007 P PS	KV1
08-127407-00	0.50mm		1.750		005 IFU P	IKA
[R66780]			2.500		236 P	IKA



Laguna Grandtour 3.0 24V, Laguna I 3.0 24V			03/97→03/01	L7X 700	V6cyl. 2946cc	140kW (190PS)	38	TD16207
Laguna Grandtour 3.0 24V, Laguna I 3.0 24V			03/97→03/01	L7X 701	V6cyl. 2946cc	140kW (190PS)		TD16208
Safrane II 2.9 24V			03/99→12/00	L7X 713	6cyl. 2946cc	140kW (190PS)		TD17251
08-104700-00	STD	87.00	1.500		001 P PS			KV1
			1.500		026 P			STD
			3.000		231 CR P			GOE13
30 2.6			02/75→08/78	112	6cyl. 2664cc	92-96kW (125-131PS)	39	TD3410
25 2.7 V6 Injection			04/84→08/89	Z7V 708	6cyl. 2664cc	104kW (141PS)		TD3441
25 2.7 V6 Injection			04/84→08/89	Z7V 709	6cyl. 2664cc	104kW (141PS)		TD3442
25 2.7 V6 Injection			04/84→08/89	Z7V 711	6cyl. 2664cc	104kW (141PS)		TD3443
R30 TS R30 TX			01/75→12/84 01/78→12/84	Z7V-140	V6cyl. 2664cc			FM3234
08-316900-00	STD	88.00	1.500		001 IF CR P			IKA
08-316907-00	0.50mm		2.000		026 P			STD
[R66110]			4.000		712 CR			ST
Master I Box 2.0 Master I Platform/Chassis 28-35 2.0			06/85→10/89 10/82→09/86	829 730	4cyl. 1995cc	81kW (110PS)	40	TD3045
Master I Box 28-35 2.0 Master I Bus 28-35 2.0 Master I Platform/Chassis 2.0			08/80→10/86 08/80→09/86 07/80→06/85	829 731	4cyl. 1995cc	81kW (110PS)		TD3046
20 2.0			10/77→10/80	829.01	4cyl. 1995cc	76-80kW (103-109PS)		TD21390





20 2.2	10/80→12/83	851 700	4cyl. 2165cc	85kW (116PS)	TD3076
Master I Platform/Chassis 2.0	11/89→12/95	J5R 716	4cyl.		
Trafic Box 2.0	05/85→08/90		4cyl.		
Trafic Box 2.0 4x4, Trafic Bus 2.0, Trafic Bus 2.0 4x4	06/86→04/89		1995cc	59-62kW (80-84PS)	
Trafic Platform/Chassis 2.0 4x4	05/85→02/89				TD3302
Master I Box 28-35 2.0, Master I Bus 28-35 2.0	10/86→07/98	J5R 718	4cyl.		
Master I Platform/Chassis 2.0	11/89→07/93		1995cc	57-60kW (78-82PS)	TD3303
Trafic Box 2.0, Trafic Box 2.0 4x4, Trafic Bus 2.0, Trafic Bus 2.0 4x4	06/86→04/89	J5R 722	4cyl.		
			1995cc	59kW (80PS)	TD3304
Trafic Box 2.0, Trafic Box 2.0 4x4	06/86→04/89	J5R 726	4cyl.		
Trafic Bus 2.0	06/86→08/90		4cyl.		
Trafic Bus 2.0 4x4	06/86→04/89		1995cc	59kW (80PS)	
Trafic Platform/Chassis 2.0	03/80→12/91				
Trafic Platform/Chassis 2.0 [RWD]	05/89→10/97				TD3305
Master I Box 2.0, Master I Bus 2.0	06/85→10/89	J5R 728	4cyl.		
Master I Platform/Chassis 2.0	11/89→12/95		4cyl.		
Master I Platform/Chassis 28-35 2.0	10/86→07/98		1995cc	58kW (79PS)	TD3306
Espace I 2.0	07/84→12/90	J6R 234	4cyl.		
			1995cc	79-81kW (107-110PS)	TD3308
Espace I 2.0	07/84→12/90	J6R 236	4cyl.		
			1995cc	80kW (108PS)	TD3309
25 2.0	04/84→12/92	J6R 706	4cyl.		
			1995cc	74kW (100PS)	TD3310
25 2.0	04/84→12/92	J6R 707	4cyl.		
			1995cc	74kW (100PS)	TD3311
Fuego 2.0 TX/GTX	10/80→10/85	J6R 710	4cyl.		
			1995cc	81kW (110PS)	TD3312
Fuego 2.0 TX/GTX	10/80→10/85	J6R 712	4cyl.		
			1995cc	81kW (110PS)	TD3314
Fuego 2.0 TX/GTX	10/80→10/85	J6R 713	4cyl.		
			1995cc	81kW (110PS)	TD3315





Fuego 2.0 TX/GTX	10/80→10/85	J6R 715	4cyl. 1995cc	81kW (110PS)	TD3319
18 2.0	05/82→07/86	J6R 716	4cyl. 1995cc	77kW (105PS)	TD5064
18 Variable 2.0	10/81→07/86				
18 Variable 2.0 4x4	05/83→12/86				
21 Estate 2.0	06/91→05/93	J6R 758	4cyl. 1995cc	75kW (102PS)	TD3324
21 Saloon 2.0	03/86→10/93				
21 Estate 2.0	06/91→05/93	J6R 759	4cyl. 1995cc	75kW (102PS)	TD3325
21 Saloon 2.0	03/86→10/93				
25 2.0	04/84→12/92	J6R 760	4cyl. 1995cc	74kW (100PS)	TD3326
25 2.0	04/84→12/92	J6R 762	4cyl. 1995cc	74kW (100PS)	TD3327
21 Estate 2.0	06/91→05/93	J6R 792	4cyl. 1995cc	75kW (102PS)	TD3329
21 Saloon 2.0	03/86→10/93				
21 Saloon 2.0	03/86→10/93	J6R 793	4cyl. 1995cc	75kW (102PS)	TD3330
25 2.0	03/87→12/93	J7R 722	4cyl. 1995cc	88kW (120PS)	TD3335
25 2.0	03/87→12/93	J7R 723	4cyl. 1995cc	88kW (120PS)	TD3336
21 2.0	02/90→10/92	J7R 740	4cyl. 1995cc	99-100kW (134-136PS)	TD3344
21 2.0 4x4	09/90→10/92				
21 2.0 TXi	07/89→05/93				
21 Estate 2.0	06/90→02/94				
21 Saloon 2.0	02/90→06/94				
21 Saloon 2.0 4x4	12/89→02/94				
21 2.0	09/89→12/93	J7R 746	4cyl. 1995cc	88kW (120PS)	TD3345
21 Estate 2.0	03/86→12/93				
21 Estate 2.0 4x4	03/89→12/93				
21 Saloon 2.0	03/86→12/93				
21 2.0	09/89→12/93	J7R 747	4cyl. 1995cc	88kW (120PS)	TD3346
21 Estate 2.0	03/86→12/93				
21 Estate 2.0 4x4	03/89→12/93				
21 Saloon 2.0	03/86→12/93				





21 2.0	07/89→06/92	J7R 751			
21 Estate 2.0	06/86→06/92		4cyl.		
21 Saloon 2.0	03/86→06/89		1995cc	85kW (116PS)	
					TD3348
21 Saloon 2.0 Turbo	04/87→03/90	J7R 752			
21 Saloon 2.0 Turbo 4x4	08/89→10/93		4cyl.		
			1995cc	129kW (175PS)	
				Turbo	TD3349
Espace I 2.0 i	01/89→12/90	J7R 760			
Espace I 2.0 i Quadra	03/88→12/92		4cyl.		
			1995cc	87-88kW (118-120PS)	
					TD3352
Espace II 2.0	01/91→10/96	J7R 768			
			4cyl.		
			1995cc	76kW (103PS)	
					TD3353
25 2.2	04/84→12/89	J7T 706			
			4cyl.		
			2165cc	89kW (121PS)	
					TD3355
25 2.2	04/84→12/89	J7T 714			
			4cyl.		
			2165cc	89-91kW (121-124PS)	
					TD3358
25 2.2	04/84→12/89	J7T 715			
			4cyl.		
			2165cc	89-91kW (121-124PS)	
					TD3359
25 2.2	04/84→12/89	J7T 730			
			4cyl.		
			2165cc	91kW (124PS)	
					TD3364
25 2.2	04/84→12/89	J7T 731			
			4cyl.		
			2165cc	91kW (124PS)	
					TD3365
25 2.2	09/86→12/92	J7T 732			
			4cyl.		
			2165cc	79kW (107PS)	
					TD3366
25 2.2	09/86→12/92	J7T 733			
			4cyl.		
			2165cc	79kW (107PS)	
					TD3367
21 2.2	09/89→06/94	J7T 754			
21 2.2 4x4	07/90→06/94		4cyl.		
21 Estate 2.2	06/86→11/93		2165cc	79kW (107PS)	
21 Estate 2.2 4x4	06/86→12/93				
21 Saloon 2.2	07/86→02/94				
21 Saloon 2.2 4x4	07/90→02/94				TD3370
21 2.2	07/89→06/94	J7T 755			
21 2.2 4x4	07/90→06/94		4cyl.		
21 Estate 2.2	06/86→11/93		2165cc	79kW (107PS)	
21 Estate 2.2 4x4	06/86→12/93				
21 Saloon 2.2	04/86→02/94				
21 Saloon 2.2 4x4	07/90→02/94				TD3371





Espace I 2.2			07/86→12/90	J7T 770				
Espace I 2.2 Quadra			01/88→12/90		4cyl.	2165cc	79-81kW (107-110PS)	TD3377
Trafic Box 2.2, Trafic Box 2.2 4x4,			05/89→06/94	J7T 780				
Trafic Bus 2.2, Trafic Bus 2.2 4x4,					4cyl.	2165cc	70kW (95PS)	TD3380
Trafic Platform/Chassis 2.2								
Master I Box 30 2.2, Master I Bus 30 2.2			08/80→07/98	J7T 782				
					4cyl.	2165cc	67-69kW (91-94PS)	TD3381
08-334400-00	STD	88.00	1.750		001 IF MO P			IKA
→08/1989			2.000		026 P			STD
[R66300]			4.000		712 CR			ST
08-336300-00	STD	88.00	1.500		001 IF MO P			IKA
09/1989→			1.750		026 P			STD
			3.000		712 CR			ST
21 Saloon 2.0 Turbo,			02/90→10/92	J7R 756				
21 Saloon 2.0 Turbo 4x4					4cyl.	1995cc	119kW (162PS)	41 TD3351
					Turbo			
Trafic Box 2.2, Trafic Box 2.2 4x4,			06/94→10/97	J7T 600				
Trafic Bus 2.2, Trafic Bus 2.2 4x4			09/94→04/98		4cyl.	2165cc	74kW (100PS)	TD5563
Trafic Platform/Chassis 2.2,								
Trafic Platform/Chassis 2.2 4x4								
Safrane I 2.2			04/92→07/96	J7T 760				
					4cyl.	2165cc	101kW (137PS)	TD3373
Safrane I 2.2			04/92→07/96	J7T 761				
					4cyl.	2165cc	101kW (137PS)	TD3374
Safrane I 2.2			04/92→07/96	J7T 762				
					4cyl.	2165cc	79-81kW (107-110PS)	TD3375
Espace II 2.2			01/91→10/96	J7T 772				
Espace II 2.2 4x4			03/91→12/96		4cyl.	2165cc	79-81kW (107-110PS)	TD3378
Espace II 2.2			01/91→10/96	J7T 776				
					4cyl.	2165cc	79-81kW (107-110PS)	TD3379
08-336300-00	STD	88.00	1.500		001 IF MO P			IKA
			1.750		026 P			STD
			3.000		712 CR			ST



Trafic II Box 2.5 dCi 145	08/06→	G9U 630 Euro 4								42
Trafic II Bus 2.5 dCi 115	02/08→		4cyl.							
Trafic II Bus 2.5 dCi 145	08/06→			2464cc	84kW (114PS)					
Trafic II Platform/Chassis 2.5 dCi	08/07→	Diesel								
Trafic II Platform/Chassis 2.5 dCi 145	08/06→			Turbo Intercooled					TD19713	

Master II Box 2.5 dCi, Master II Bus 2.5 dCi, Master II Platform/Chassis 2.5 dCi	08/06→	G9U 632 Euro 4								
			4cyl.							
				2464cc	88-107kW (120-146PS)					
		Diesel								
				Turbo Intercooled					TD21013	

Master II Box 2.5 dCi, Master II Bus 2.5 dCi, Master II Platform/Chassis 2.5 dCi	08/06→	G9U 650 Euro 4								
			4cyl.							
				2464cc	74-88kW (101-120PS)					
		Diesel								
				Turbo Intercooled					TD21011	

08-137500-00	STD	89.00	3.000		007 MO P			KV1
08-137507-00	0.50mm		1.750		005 IFU P			STD
[R66720]			2.500		236 P			GOE12

Master II Box 2.5 dCi 120, Master II Bus 2.5 dCi 120, Master II Platform/Chassis 2.5 dCi 120	10/01→	G9U 720 Euro 3								43
			4cyl.							
				2463cc	85kW (116PS)					
		Diesel								
				Turbo Intercooled					TD16303	

Master II Box 2.5 dCi 120	10/01→	G9U 724 Euro 3								
			4cyl.							
				2463cc	84kW (114PS)					
		Diesel								
				Turbo Intercooled					TD19366	

Trafic II Box 2.5 dCi 135	05/03→	G9U 730 Euro 3								
Trafic II Box 2.5 DTi	03/03→07/03		4cyl.							
Trafic II Bus 2.5 dCi 135	05/03→			2464cc	99kW (135PS)					
Trafic II Bus 2.5 DTi	03/03→07/03	Diesel								
Trafic II Platform/Chassis 2.5 dCi 135	03/01→			Turbo Intercooled					TD18275	

Master II Box 2.5 dCi, Master II Bus 2.5 dCi, Master II Platform/Chassis 2.5 dCi	01/04→	G9U 750 Euro 3								
			4cyl.							
				2463cc	84kW (114PS)					
		Diesel								
				Turbo Intercooled					TD19359	

Master II Box 2.5 dCi	08/06→	G9U 754 Euro 3								
Master II Box 2.5 dCi 100	10/03→		4cyl.							
Master II Box 2.5 dCi 120	10/01→			2463cc	73kW (99PS)					
Master II Bus 2.5 dCi	08/06→	Diesel								
Master II Bus 2.5 dCi 100	10/03→			Turbo Intercooled						
Master II Bus 2.5 dCi 120	10/01→									
Master II Platform/Chassis 2.5 dCi	08/06→									
Master II Platform/Chassis 2.5 dCi 100	10/03→									
Master II Platform/Chassis 2.5 dCi 120	10/01→								TD19085	

08-137500-10	STD	89.00	2.500		001 IF MO P			KV1
08-137507-10	0.50mm		1.750		005 IFU P			F12/F14
			2.500		231 CR P			GOE12



25 2.5 V6 Turbo		01/90→12/92	Z7U 700	6cyl. 2458cc Turbo	151kW (205PS)	44 TD3437
25 2.4 V6 Turbo		10/84→05/90	Z7U 702	6cyl. 2458cc Turbo	133kW (181PS)	TD3438
08-321600-00	STD	91.00	1.750	001 MO P	KV1	
			2.000	005 IF P	STD	
			4.000	231 CR	STD	
25 2.8 V6		06/87→02/90	Z7W 700	6cyl. 2849cc	115kW (156PS)	45 TD3444
25 2.8 V6 Injection		06/86→02/88	Z7W 702	6cyl. 2849cc	100kW (136PS)	TD3446
25 2.8 V6 Injection		06/87→12/92	Z7W 706	6cyl. 2849cc	110-112kW (150-153PS)	TD3447
25 2.8 V6 Injection		06/87→12/92	Z7W 707	6cyl. 2849cc	110-112kW (150-153PS)	TD3448
08-408800-00	STD	91.00	1.500	001 IF CR P	IKA	
			2.000	026 P	STD	
			4.000	712 CR	ST	
Master 2.5D		09/89→12/93	8140.07.2700	4cyl. 2499cc Diesel	55kW (75PS)	46 TD22385
Master B80			8140.07.2701 (Sofim), 8140.07.2710	4cyl. 2499cc Diesel	55kW (75PS)	FM9101
Messenger B80		09/90→06/99	8140.07.2530	4cyl. 2499cc Diesel	55kW (75PS)	TD3417
Master 2.5D		09/89→	8140.07.3700 Euro 1	4cyl. 2499cc Diesel	55kW (75PS)	TD22386
Trafic Box 2.5 D, Trafic Box 2.5 D 4x4, Trafic Bus 2.5 D		05/89→03/01	8140.67.2580 Euro 2	4cyl. 2499cc Diesel	55kW (75PS)	TD3433
Trafic Bus 2.5 D 4x4		08/89→03/01				





Master 2.5 D		09/89→12/93	8140-07 (Sofim)			
			4cyl.			
			2499cc		55kW (75PS)	
			Diesel			TD8524
08-425000-00	STD	93.00	3.000		008 CR P	KV1
08-425008-00	0.60mm		2.000		026 P	F12/F14
[R47250]			3.000		231 CR P	STD
B Box Body / Estate 90		04/86→09/90	8140.21.235 IDS			47
B Platform/Chassis 90		04/86→09/90	4cyl.			
			2445cc		68-71kW (92-96PS)	
			Diesel		Turbo	TD3418
Master 2.5 TD, Master I Box 28-35 2.5 TD		08/89→07/98	8140.27 (Sofim)			
			4cyl.			
			2499cc		78kW (106PS)	
			Diesel		Turbo	TD8529
Master 2.5 TD, Master I Box 28-35 2.5 TD		08/89→07/98	8140.27.2565 (Sofim)			
			4cyl.			
			2499cc		78kW (106PS)	
			Diesel			TD12197
Master 2.5D		10/93→08/95	8140.27.2565 (Sofim)			
Master 2.5D Dist. Catena		09/95→08/96	4cyl.			
			2499cc			
			Diesel		Turbo	FM39101
Master 2.5 TD, Master I Box 28-35 2.5 TD		08/89→07/98	8140.27.2582			
			4cyl.			
			2499cc		92kW (125PS)	
			Diesel		Turbo	TD3424
Master 2.5 TD, Master I Box 28-35 2.5 TD		08/89→07/98	8140.27.2585			
			4cyl.			
			2499cc		78kW (106PS)	
			Diesel		Turbo	TD12195
Master 2.5TD		09/80→00/93	8140.27.2700			
			4cyl.			
			2499cc		68-76kW (92-103PS)	
			Diesel		Turbo	TD21392
08-245200-00	STD	93.00	3.000		008 CR P	KV1
08-245208-00	0.60mm		2.000		005 P	F12/F14
[R47080]			3.000		231 CR P	STD
Master 2.5TD		01/94→09/97	8140.27.2560			48
			4cyl.			
			2499cc		69kW (93PS)	
			Diesel		Turbo	TD8623
Master 2.5TD		01/94→09/97	8140.47.2535			
			4cyl.			
			2499cc		85kW (116PS)	
			Diesel		Turbo Intercooled	TD3426
Master 2.5TD		09/80→	8140.47.2700 Euro 1			
			4cyl.			
			2499cc		85kW (116PS)	
			Diesel		Turbo Intercooled	TD22395





Master 2.5TD				09/80→	8140.47.2721 Euro 1	4cyl. 2499cc 85kW (116PS)	Diesel Turbo Intercooled	TD22396
Master 2.5TD				09/80→	8140.47.2785 Euro 1	4cyl. 2499cc 85kW (116PS)	Diesel Turbo Intercooled	TD22397
Messenger B120.35					8140.47.2530	4cyl. 2499cc 85kW (116PS)	Diesel Turbo Intercooled	TD8533
Master I Box 35 2.5 TD, Master I Bus 35 2.5 TD				08/89→07/98	S9U 714	4cyl. 2499cc 69kW (93PS)	Diesel Turbo	TD12732
08-520200-00	STD	93.00	3.000		008 CR			KV1
[R49350]			2.000		005 IWU P			F12/F14
			3.000		231 CR P			STD
Master I Box 28-35 2.4 D, Master I Bus 28-35 2.4 D				08/80→08/89	8140.61.2300	4cyl. 2445cc 52kW (71PS)	Diesel	49 TD3429
Master I Platform/Chassis 28-35 2.5 D				09/80→07/98				
Trafic Platform/Chassis 2.5 D				03/80→03/01	8140.61.240 (Sofim)	4cyl. 2445cc 51kW (69PS)	Diesel	TD12871
Trafic Platform/Chassis 2.5 D				03/80→03/01	S8U 720	4cyl. 2445cc 51kW (69PS)	Diesel	TD3413
Trafic Platform/Chassis 2.5 D				03/80→03/01	S8U 722	4cyl. 2445cc 51kW (69PS)	Diesel	TD3414
Master I Box 2.4 D				07/83→12/92	S8U 730	4cyl. 2445cc 52kW (71PS)	Diesel	TD12873
Master I Platform/Chassis 2.4 D				08/93→02/98				
Master I Box 2.4 D				07/80→06/83	S8U 731	4cyl. 2445cc 52kW (71PS)	Diesel	TD12730
Master I Box 28-35 2.4 D				08/80→08/89				
Master I Bus 2.4 D				09/86→10/89				
Master I Bus 28-35 2.4 D				08/80→08/89				
Master I Platform/Chassis 28-35 2.5 D				09/80→07/98				TD12730





Master 2.4 D			01/94→09/97	S8U 748			
					4cyl.		
					2445cc	55kW (75PS)	
				Diesel			TD12735
08-147300-10 →05/1981	STD	93.00	2.000		001 MOL P		KV1
			2.000		005 IF P		STD
			4.000		231 CR P		STD
08-214400-10 →05/1981	STD	93.00	2.000		001 CR P		KV1
[R60960]			2.000		005 IF P		STD
			4.000		231 CR P		STD
08-214500-10 08-214508-10 06/1981→	STD 0.60mm	93.00	3.000		001 CR P		KV1
[R47010]			2.000		005 IF P		STD
			4.000		231 CR P		STD
Traffic Box 2.5 D, Traffic Box 2.5 D 4x4,			05/89→03/01	8140.67.2500			50
Traffic Bus 2.5 D					4cyl.		
Traffic Bus 2.5 D 4x4			08/89→03/01		2499cc	55kW (75PS)	
				Diesel			TD3431
Traffic Box 2.5 D, Traffic Bus 2.5 D			05/89→03/01	8140.67.2550			
Traffic Bus 2.5 D 4x4			08/89→03/01		4cyl.		
					2499cc	55kW (75PS)	
				Diesel			TD12872
Master I Box 28-35 2.5 D,			08/89→07/98	S8U 742			
Master I Bus 28-35 2.5 D					4cyl.		
Master I Platform/Chassis 2.5 D			07/80→10/89		2499cc	55kW (75PS)	
				Diesel			TD5442
Traffic Box 2.5 D			03/89→03/01	S8U 750			
Traffic Box 2.5 D 4x4			05/89→03/01		4cyl.		
Traffic Bus 2.5 D			03/89→03/01		2499cc	55kW (75PS)	
Traffic Bus 2.5 D 4x4			08/89→03/01	Diesel			
Traffic Platform/Chassis 2.5 D,			03/89→08/94				
Traffic Platform/Chassis 2.5 D 4x4							TD5566
Traffic Box 2.5 D, Traffic Box 2.5 D 4x4,			05/89→03/01	S8U 752			
Traffic Bus 2.5 D					4cyl.		
Traffic Bus 2.5 D 4x4			08/89→03/01		2499cc	55kW (75PS)	
				Diesel			TD5567
Traffic Box 2.5 D, Traffic Bus 2.5 D			05/89→03/01	S8U 758			
Traffic Bus 2.5 D 4x4			08/89→03/01		4cyl.		
Traffic Platform/Chassis 2.5 D			09/94→03/01		2499cc	55kW (75PS)	
Traffic Platform/Chassis 2.5 D 4x4			09/94→01/99	Diesel			TD9689
Traffic Platform/Chassis 2.5 D			05/98→03/01	S8U 780			
					4cyl.		
					2499cc	55kW (75PS)	
				Diesel			TD16328
08-783300-00 08-783308-00	STD 0.60mm	93.00	3.000		001 CR P		KV1
[R47100]			2.000		026 P		STD
			3.000		231 CR P		STD



Master II Box 2.8 dTI, Master II Bus 2.8 dTI, Master II Platform/Chassis 2.8 dTI	07/98→10/01	S9W 700/S9W 702 4cyl. 2799cc 84kW (114PS)	51
		Diesel Turbo	TD13408

Part Number	Spec	Price	Thickness	Image	Code	Part Name
08-122200-00	STD	94.40	2.500		008 CK P	KV1
08-122208-00 eng.2572280→	0.60mm		2.000		005 P	IKA
[R60070]			2.500		231 CR P	GOE12
08-854700-00	STD	94.40	3.000		008 CR	GOE12
08-854708-00 →eng.2572279	0.60mm		2.000		005 IWU P	GOE12
[R49690]			3.000		231 CR	GOE12

ENGINE INDEX

Motorverzeichnis • Index de moteur • Índice de Motor
Indeks silnika • Модель двигателя • دليل المحرك



CCM



9

797	Diesel	5453	6	102.00	6
797-20	Diesel	5490	6	102.00	6
797-21	Diesel	5453	6	102.00	6
797-26	Diesel	5490	6	102.00	6
798	Diesel	5490	6	102.00	7
798-10	Diesel	5490	6	102.00	7
798-20	Diesel	5490	6	102.00	7
8140.07.2585 Euro 1	Diesel	2499	4	93.00	1
8140.23.2585 Euro 2 (Sofim)	Diesel	2800	4	94.40	4
8140.43.2585 Euro 2 (Sofim)	Diesel	2800	4	94.40	4
8140.43.3700 Euro 2	Diesel	2798	4	94.40	4
8140.43.C.2586	Diesel	2800	4	94.40	4
8140.43.C.3586 Euro 3	Diesel	2800	4	94.40	4
8140.43.C.3588 Euro 3	Diesel	2800	4	94.40	4
8140.43.S.2585 Euro 2	Diesel	2800	4	94.40	4
8140.43.S.3585 Euro 3	Diesel	2800	4	94.40	4
8140.43N.3585 Euro 3	Diesel	2798	4	94.40	4
8140.47.2530 IDR (Sofim)	Diesel	2499	4	93.00	2
8140.47.2585 Euro 1	Diesel	2499	4	93.00	2
8140.47.2590 Euro 1	Diesel	2499	4	93.00	2
8140.61.235	Diesel	2445	4	93.00	3
8140.63.2585 Euro 2	Diesel	2798	4	94.40	5
8140.67.2585 Euro 2	Diesel	2499	4	93.00	1
DCI 6 W Euro 3	Diesel	6177	6	102.00	8
dCi 11-270 Euro 3	Diesel	11100	6	123.00	15
dCi 11C Euro 3	Diesel	11100	6	123.00	15
dCi 11E Euro 3	Diesel	11100	6	123.00	15
dCi 11G Euro 3	Diesel	11100	6	123.00	15
DXi 5	Diesel	4800	5	108.00	10
DXi 7	Diesel	7200	5	108.00	10
DXi 11	Diesel	10800	6	123.00	16
DXi 13 Euro 4	Diesel	12800	6	131.00	18
M 520	Diesel	7917	5	120.00	11
M 620 Z 3	Diesel	9500	6	120.00	11
M 635.40AD	Diesel	12000	6	135.00	19
M 635.40AP	Diesel	12000	6	135.00	19
M 635.40C	Diesel	12000	6	135.00	19
M 635.40CD	Diesel	12000	6	135.00	19
M 635.40CP	Diesel	12000	6	135.00	19
M 635.40CZ	Diesel	12000	6	135.00	19
M 635.40ET	Diesel	12000	6	135.00	19
M 635T	Diesel	12000	6	135.00	19
MD 06.35.40	Diesel	12000	6	135.00	19
MD042030 (M420X30)	Diesel	5880	4	120.00	11
MD052040 (MDU44M/45M/46M)	Diesel	7917	5	120.00	11
MDR 06.35.40	Diesel	12000	6	135.00	19
MDS 06.35.40	Diesel	12024	6	135.00	19
MDX 16M/24M/26M/44M/46M	Diesel	6328	4	120.00	11
MH 520	Diesel	7900	5	120.00	11
MH 620, MH620	Diesel	9500	6	120.00	11
MID 06.20.30	Diesel	8820	6	120.00	12
MID 06.20.30 C	Diesel	8820	6	120.00	13
MID 06.20.30 D	Diesel	8820	6	120.00	13
MID 06.20.30 G	Diesel	8820	6	120.00	13
MID 06.20.30 H	Diesel	8820	6	120.00	13
MID 06.20.45	Diesel	9840	6	120.00	14
MIDR 04.02.26 A/4 Euro 2	Diesel	4120	4	102.00	9
MIDR 04.02.26 B/4 Euro 2	Diesel	4120	4	102.00	9
MIDR 06.02.12	Diesel	5491	6	102.00	9
MIDR 06.02.12 B	Diesel	5490	6	102.00	9

Motorverzeichnis • Index de moteur • Índice de Motor
Indeks silnika • Модель двигателя • دليل المحرك

ENGINE INDEX



CCM

x



9

MIDR 06.02.12 C	Diesel	5490	6	102.00	9
MIDR 06.02.12 D	Diesel	5490	6	102.00	9
MIDR 06.02.26	Diesel	6177	6	102.00	9
MIDR 06.02.26 D	Diesel	6177	6	102.00	9
MIDR 06.02.26 H	Diesel	6177	6	102.00	9
MIDR 06.02.26 Q	Diesel	6177	6	102.00	9
MIDR 06.02.26 U Euro 1	Diesel	6177	6	102.00	9
MIDR 06.02.26 U/4 Euro 2	Diesel	6177	6	102.00	9
MIDR 06.02.26 V Euro 1	Diesel	6177	6	102.00	9
MIDR 06.02.26 V/4 Euro 2	Diesel	6177	6	102.00	9
MIDR 06.02.26 V/41 Euro 2	Diesel	6177	6	102.00	9
MIDR 06.02.26 W Euro 1	Diesel	6177	6	102.00	9
MIDR 06.02.26 W/4 Euro 2	Diesel	6177	6	102.00	9
MIDR 06.02.26 X Euro 1	Diesel	6177	6	102.00	9
MIDR 06.02.26 Y/41 Euro 2	Diesel	6177	6	102.00	9
MIDR 06.20.30 A	Diesel	8820	6	120.00	13
MIDR 06.20.30 B	Diesel	8820	6	120.00	13
MIDR 06.20.30 C	Diesel	8820	6	120.00	13
MIDR 06.20.45	Diesel	9771	6	120.00	14
MIDR 06.20.45 A	Diesel	9839	6	120.00	13
MIDR 06.20.45 A2	Diesel	9840	6	120.00	14
MIDR 06.20.45 B3 Euro 1	Diesel	9839	6	120.00	14
MIDR 06.20.45 C	Diesel	9840	6	120.00	13
MIDR 06.20.45 C/4 Euro 2	Diesel	9839	6	120.00	14
MIDR 06.20.45 D	Diesel	9839	6	120.00	14
MIDR 06.20.45 D/41 Euro 2	Diesel	9839	6	120.00	14
MIDR 06.20.45 D3 Euro 1	Diesel	9839	6	120.00	14
MIDR 06.20.45 E	Diesel	9839	6	120.00	14
MIDR 06.20.45 E/41 Euro 2	Diesel	9839	6	120.00	14
MIDR 06.20.45 E2 Euro 1	Diesel	9839	6	120.00	14
MIDR 06.20.45 F3	Diesel	9840	6	120.00	14
MIDR 06.20.45 H	Diesel	9839	6	120.00	14
MIDR 06.20.45 I3	Diesel	9840	6	120.00	14
MIDR 06.20.45 I41 Euro 2	Diesel	9840	6	120.00	14
MIDR 06.20.45 J3	Diesel	9800	6	120.00	14
MIDR 06.20.45 K	Diesel	9840	6	120.00	14
MIDR 06.20.45 L	Diesel	9840	6	120.00	14
MIDR 06.20.45 M	Diesel	9840	6	120.00	14
MIDR 06.20.45 M3	Diesel	9840	6	120.00	14
MIDR 06.20.45 M41 Euro 2	Diesel	9839	6	120.00	14
MIDR 06.23.56 A/3 Euro 2	Diesel	11100	6	123.00	15
MIDR 06.23.56 A/41 Euro 2	Diesel	11100	6	123.00	15
MIDR 06.23.56 B/41 Euro 2	Diesel	11100	6	123.00	15
MIDR 06.24.65 A/42 Euro 2	Diesel	12000	6	124.00	17
MIDR 06.24.65 B/42 Euro 2	Diesel	12000	6	124.00	17
MIDR 06.24.65 C/42 Euro 2	Diesel	12000	6	124.00	17
MIDR 06.35.40	Diesel	12000	6	135.00	20
MIDR 06.35.40 C	Diesel	11941	6	135.00	20
MIDR 06.35.40 G	Diesel	12024	6	135.00	21
MIDR 06.35.40 H	Diesel	11941	6	135.00	21
MIDR 06.35.40 J/3 Euro 1	Diesel	12024	6	135.00	21
MIDR 06.35.40 J1 Euro 1	Diesel	12024	6	135.00	21
MIDR 06.35.40 L1	Diesel	12024	6	135.00	21
MIDR 06.35.40 M3 Euro 1	Diesel	12024	6	135.00	21
MIDR 06.35.40 N/3 Euro 1	Diesel	12024	6	135.00	21
MIDR 06.35.40 P/41 Euro 2	Diesel	12024	6	135.00	21
MIDS 06.02.12	Diesel	5490	6	102.00	9
MIDS 06.02.12 B	Diesel	5453	6	102.00	9
MIDS 06.02.12 C	Diesel	5490	6	102.00	9
MIDS 06.02.12 D/3	Diesel	5490	6	102.00	9

ENGINE INDEX

Motorverzeichnis • Index de moteur • Índice de Motor
Indeks silnika • Модель двигателя • دليل المحرك



CCM

x



9

MIDS 06.20.30	Diesel	8821	6	120.00	12
MIDS 06.20.30 B	Diesel	8820	6	120.00	12
MIDS 06.20.30 D	Diesel	8820	6	120.00	12
MIDS 06.20.30 E	Diesel	8820	6	120.00	13
MIDS 06.20.30 K	Diesel	8820	6	120.00	13
MIDS 06.20.30 N	Diesel	8820	6	120.00	12
MIDS 06.20.45	Diesel	9839	6	120.00	14
MIDS 06.20.45 B	Diesel	9839	6	120.00	14
MIDS 06.20.45 D	Diesel	9840	6	120.00	14
MIDS 06.20.45 F	Diesel	9840	6	120.00	14
MIDS 06.20.45 J	Diesel	9840	6	120.00	14
MIDS 06.20.45 J3	Diesel	9840	6	120.00	14
MIDS 06.35.40	Diesel	12000	6	135.00	22
MIDS 06.35.40 D	Diesel	12024	6	135.00	22
MIHR 06.20.45 A41 Euro 2	Diesel	9839	6	120.00	14
MIP 06.20.30	Diesel	8820	6	120.00	13
MIPR 06.20.45 A	Diesel	9840	6	120.00	14
MIPR 06.20.45 A3	Diesel	9840	6	120.00	14
MIPR 06.20.45 B3	Diesel	9840	6	120.00	13
MIPR 06.20.45 C3	Diesel	9840	6	120.00	13
MIPS 06.20.30	Diesel	8820	6	120.00	12
MIPS 06.20.45	Diesel	9840	6	120.00	14
MIPS 06.20.45 A	Diesel	9840	6	120.00	14
MIPS 06.20.45 B	Diesel	9840	6	120.00	14
MIPS 06.20.45 C	Diesel	9840	6	120.00	14
MIV 08 35 30	Diesel	11886	V8	135.00	19
MIVR 08.35.30 C	Diesel	14886	8	135.00	23
MIVR 08.35.30 G	Diesel	14886	8	135.00	23
MIVR 08.35.30 H	Diesel	14886	8	135.00	23
MIVS 08.35.30	Diesel	14886	8	135.00	23
MIVS 08.35.30 F	Diesel	14886	8	135.00	23
S8U 748	Diesel	2445	4	93.00	3
S9W 700	Diesel	2799	4	94.40	4



1

8140.07.2585 Euro 1		4cyl.	2499cc	55kW (75PS)	Diesel	TD12192
8140.67.2585 Euro 2		4cyl.	2499cc	55-63kW (75-86PS)	Diesel	TD12193
08-425000-00	STD	93.00	3.000		008 CR P	KV1
08-425008-00	0.60mm				026 P	F12/F14
[R47250]			3.000		231 CR P	STD

2

8140.47.2530 IDR (Sofim)		4cyl.	2499cc	85kW (116PS)	Diesel Turbo	TD3425
8140.47.2585 Euro 1		4cyl.	2499cc	85kW (116PS)	Diesel Turbo Intercooled	TD3428
8140.47.2590 Euro 1		4cyl.	2499cc	85kW (116PS)	Diesel Turbo Intercooled	TD12199
08-520200-00	STD	93.00	3.000		008 CR	KV1
[R49350]			2.000		005 IWU P	F12/F14
			3.000		231 CR P	STD

3

8140.61.235		4cyl.	2445cc	53kW (72PS)	Diesel	TD3430
S8U 748		4cyl.	2445cc	55kW (75PS)	Diesel	TD12735
08-147300-10	STD	93.00	2.000		001 MOL P	KV1
→05/1981			2.000		005 IF P	STD
			4.000		231 CR P	STD
08-214400-10	STD	93.00	2.000		001 CR P	KV1
→05/1981			2.000		005 IF P	STD
[R60960]			4.000		231 CR P	STD
08-214500-10	STD	93.00	3.000		001 CR P	KV1
08-214508-10	0.60mm		2.000		005 IF P	STD
06/1981→			4.000		231 CR P	STD
[R47010]						



4

8140.23.2585 Euro 2 (Sofim)	4cyl.	2800cc	78kW (106PS)	Diesel	Turbo Intercooled	TD12194
8140.43.2585 Euro 2 (Sofim)	4cyl.	2800cc	90kW (122PS)	Diesel	Turbo Intercooled	TD12198
8140.43.3700 Euro 2	4cyl.	2798cc	85kW (116PS)	Diesel	Turbo Intercooled	TD22394
8140.43.C.2586	4cyl.	2800cc	78kW (106PS)	Diesel	Turbo Intercooled	TD14090
8140.43.C.3586 Euro 3	4cyl.	2800cc	78kW (106PS)	Diesel	Turbo Intercooled	TD17194
8140.43.C.3588 Euro 3	4cyl.	2800cc	78kW (106PS)	Diesel	Turbo Intercooled	TD17195
8140.43.S.2585 Euro 2	4cyl.	2800cc	92kW (125PS)	Diesel	Turbo Intercooled	TD14091
8140.43.S.3585 Euro 3	4cyl.	2800cc	92kW (125PS)	Diesel	Turbo Intercooled	TD17196
8140.43N.3585 Euro 3	4cyl.	2798cc	107kW (146PS)	Diesel	Turbo Intercooled	TD17197
S9W 700	4cyl.	2799cc	84kW (114PS)	Diesel	Turbo Intercooled	TD19362

08-122200-00	STD	94.40	2.500		008 CK P	KV1
08-122208-00	0.60mm		2.000		005 P	IKA
eng.2572280→			2.500		231 CR P	GOE12
[R60070]						
08-854700-00	STD	94.40	3.000		008 CR	GOE12
08-854708-00	0.60mm		2.000		005 IWU P	GOE12
→eng.2572279			3.000		231 CR	GOE12
[R49690]						





5

8140.63.2585 Euro 2	4cyl.	2798cc	63kW (86PS)	Diesel	Turbo Intercooled	TD14089
08-108200-00	STD	94.40	3.000		008 CR P	KV1
08-108208-00	0.60mm		2.000		026 P	STD
[R60060]			2.500		231 CR P	STD



6

797	6cyl.	5453cc	96-97kW (130-132PS)	Diesel		TD8610
797-20	6cyl.	5490cc	96-98kW (130-133PS)	Diesel		TD8607
797-21	6cyl.	5453cc	76kW (103PS)	Diesel		TD8658
797-26	6cyl.	5490cc	98kW (133PS)	Diesel		TD8593
08-346500-10	STD	102.00	3.000		008 CR P	IKA
[R60820]			2.500		001 IF P	STD
			5.000		231 CR P	STD

7

798		6cyl.	5490cc	110kW (150PS)	Diesel Turbo	TD8613
798-10		6cyl.	5490cc	113kW (154PS)	Diesel Turbo	TD6210
798-20		6cyl.	5490cc	113kW (154PS)	Diesel Turbo	TD8606
08-347900-10	STD	102.00	3.000		008 CR P	KV1
[R60800]			2.500		001 IF MO	STD
			2.500		005 IW	STD
			5.000		231 CR P	STD

8

DCI 6 W Euro 3		6cyl.	6177cc	158kW (215PS)	Diesel Turbo Intercooled	TD17338
08-435000-00	STD	102.00	3.500		008 IF CK	KV1
			2.500		005 IFU CR	STD
			4.000		231 CR	STD

9

MIDR 04.02.26 A/4 Euro 2		4cyl.	4120cc	100kW (136PS)	Diesel Turbo Intercooled	TD14509
MIDR 04.02.26 B/4 Euro 2		4cyl.	4120cc	110kW (150PS)	Diesel Turbo Intercooled	TD14510
MIDR 06.02.12		6cyl.	5491cc	128-134kW (173-182PS)	Diesel Turbo Intercooled	TD8547
MIDR 06.02.12 B		6cyl.	5490cc	117kW (159PS)	Diesel Turbo Intercooled	TD8644
MIDR 06.02.12 C		6cyl.	5490cc	121-133kW (170-181PS)	Diesel Turbo Intercooled	TD5985
MIDR 06.02.12 D		6cyl.	5490cc	127-134kW (172-182PS)	Diesel Turbo Intercooled	TD8583
MIDR 06.02.26		6cyl.	6177cc	159kW (216PS)	Diesel Turbo Intercooled	TD14049
MIDR 06.02.26 D		6cyl.	6177cc	166kW (226PS)	Diesel Turbo Intercooled	TD5862
MIDR 06.02.26 H		6cyl.	6177cc	133-144kW (181-196PS)	Diesel Turbo Intercooled	TD5645
MIDR 06.02.26 Q		6cyl.	6177cc	137-140kW (186-190PS)	Diesel Turbo	TD8584
MIDR 06.02.26 U Euro 1		6cyl.	6177cc	110kW (150PS)	Diesel Turbo Intercooled	TD8616
MIDR 06.02.26 U/4 Euro 2		6cyl.	6177cc	110kW (150PS)	Diesel Turbo Intercooled	TD12208
MIDR 06.02.26 V Euro 1		6cyl.	6177cc	129-132kW (175-180PS)	Diesel Turbo Intercooled	TD8618
MIDR 06.02.26 V/4 Euro 2		6cyl.	6177cc	132kW (180PS)	Diesel Turbo Intercooled	TD14508
MIDR 06.02.26 V/41 Euro 2		6cyl.	6177cc	132kW (180PS)	Diesel Turbo Intercooled	TD12248
MIDR 06.02.26 W Euro 1		6cyl.	6177cc	151kW (205PS)	Diesel Turbo Intercooled	TD8587
MIDR 06.02.26 W/4 Euro 2		6cyl.	6177cc	154kW (210PS)	Diesel Turbo Intercooled	TD14511
MIDR 06.02.26 X Euro 1		6cyl.	6177cc	166kW (226PS)	Diesel Turbo Intercooled	TD8536
MIDR 06.02.26 Y/41 Euro 2		6cyl.	6177cc	184kW (250PS)	Diesel Turbo Intercooled	TD8639
MIDS 06.02.12		6cyl.	5490cc	107kW (146PS)	Diesel Turbo	TD8545
MIDS 06.02.12 B		6cyl.	5453cc	113-117kW (154-159PS)	Diesel Turbo	TD8608





MIDS 06.02.12 C		6cyl.	5490cc	97-103kW (132-140PS)	Diesel	Turbo	TD8615
MIDS 06.02.12 D/3		6cyl.	5490cc	110kW (150PS)	Diesel	Turbo	TD14068
08-335800-00 →02/1993 [R60830]	STD	102.00	3.000		008 P PS		KV1
			2.500		005 IF CR P		STD
			5.000		231 CR P		STD
08-522900-00 03/1993→ [R60840]	STD	102.00	3.500		008 MO		KV1
			2.500		005 CR		GOE13
			4.000		231 CR		GOE13

10







DXi 5		5cyl.	4800cc	118-162kW (160-220PS)	Diesel	Turbo Intercooled	TD19015
DXi 7		5cyl.	7200cc	177-247kW (240-340PS)	Diesel	Turbo Intercooled	TD19016
08-430000-00	STD	108.00	3.000		008 CK		KV1
			2.000		005 IFU		F12/F14
			3.500		231 CR		

11



M 520		5cyl.	7917cc	108-110kW (147-150PS)	Diesel		TD8614
M 620 Z 3		6cyl.	9500cc	132kW (180PS)	Diesel		TD8600
MD042030 (M420X30)		4cyl.	5880cc		Diesel		FM4366
MD052040 (MDU44M/45M/46M)		5cyl.	7917cc		Diesel		FM4399
MDX 16M/24M/26M/44M/46M		4cyl.	6328cc		Diesel		FM4363
MH 520		5cyl.	7900cc		Diesel		FM4376
MH 620, MH620		6cyl.	9500cc		Diesel		FM4378
08-125800-00 [R60710]	STD	120.00	3.250		008 CR P		KV1
			3.000		001 IF P		STD
			3.000		023 P		STD
			6.000		231 CR P		STD



12

MID 06.20.30		6cyl.	8820cc	104kW (141PS)	Diesel		TD26707
MIDS 06.20.30		6cyl.	8821cc	169kW (230PS)	Diesel	Turbo	TD8595
MIDS 06.20.30 B		6cyl.	8820cc	159kW (216PS)	Diesel	Turbo	TD8599
MIDS 06.20.30 D		6cyl.	8820cc	169kW (230PS)	Diesel	Turbo	TD8604
MIDS 06.20.30 N		6cyl.	8820cc	153kW (208PS)	Diesel	Turbo	TD8535
MIPS 06.20.30		6cyl.	8820cc	166kW (226PS)	Diesel	Turbo	TD8626
08-131500-10	STD	120.00	3.250		008 CR P		KV1
[R60750]			3.000		001 IW CR P		STD
			4.000		231 CR P		STD
08-132000-10	STD	120.00	3.250		008 CR P		KV1
[R60760]			3.000		001 IW CR P		STD
			3.000		005 IF P		STD
			4.000		231 CR P		STD

13

MID 06.20.30 C		6cyl.	8820cc	135-141kW (184-192PS)	Diesel	Turbo Intercooled	TD12249	
MID 06.20.30 D		6cyl.	8820cc	135-141kW (184-192PS)	Diesel		TD12250	
MID 06.20.30 G		6cyl.	8820cc	141kW (192PS)	Diesel		TD8598	
MID 06.20.30 H		6cyl.	8820cc	141kW (192PS)	Diesel		TD12255	
MIDR 06.20.30 A		6cyl.	8820cc	194kW (264PS)	Diesel	Turbo Intercooled	TD8603	
MIDR 06.20.30 B		6cyl.	8820cc	146-158kW (199-215PS)	Diesel	Turbo Intercooled	TD5646	
MIDR 06.20.30 C		6cyl.	8820cc	146-158kW (199-215PS)	Diesel	Turbo Intercooled	TD5987	
MIDR 06.20.45 A		6cyl.	9839cc	192kW (261PS)	Diesel	Turbo Intercooled	TD8591	
MIDR 06.20.45 C		6cyl.	9840cc	206-210kW (280-285PS)	Diesel	Turbo Intercooled	TD8580	
MIDS 06.20.30 E		6cyl.	8820cc	159kW (216PS)	Diesel	Turbo Intercooled	TD12256	
MIDS 06.20.30 K		6cyl.	8820cc	158kW (215PS)	Diesel	Turbo Intercooled	TD7557	
MIP 06.20.30		6cyl.	8820cc	141-158kW (192-215PS)	Diesel	Turbo Intercooled	TD8627	
MIPR 06.20.45 B3		6cyl.	9840cc	186kW (253PS)	Diesel	Turbo Intercooled	TD8628	
MIPR 06.20.45 C3		6cyl.	9840cc	152kW (207PS)	Diesel	Turbo Intercooled	TD8629	
08-131500-10	STD	120.00	3.250		008 CR P		KV1	
[R60750]				3.000		001 IW CR P		STD
				4.000		231 CR P		STD



14

MID 06.20.45	6cyl.	9840cc	152kW (207PS)	Diesel		TD8534
MIDR 06.20.45	6cyl.	9771cc	214-222kW (291-302PS)	Diesel	Turbo Intercooled	TD8414
MIDR 06.20.45 A2	6cyl.	9840cc	202kW (275PS)	Diesel	Turbo Intercooled	TD8579
MIDR 06.20.45 B3 Euro 1	6cyl.	9839cc	195kW (265PS)	Diesel	Turbo Intercooled	TD8592
MIDR 06.20.45 C/4 Euro 2	6cyl.	9839cc	188kW (256PS)	Diesel	Turbo Intercooled	TD17421
MIDR 06.20.45 D	6cyl.	9839cc	210-222kW (286-302PS)	Diesel	Turbo Intercooled	TD8538
MIDR 06.20.45 D/41 Euro 2	6cyl.	9839cc	219kW (298PS)	Diesel	Turbo Intercooled	TD8641
MIDR 06.20.45 D3 Euro 1	6cyl.	9839cc	222kW (302PS)	Diesel	Turbo Intercooled	TD8539
MIDR 06.20.45 E	6cyl.	9839cc	240-249kW (326-339PS)	Diesel	Turbo Intercooled	TD5860
MIDR 06.20.45 E/41 Euro 2	6cyl.	9839cc	249kW (339PS)	Diesel	Turbo Intercooled	TD8642
MIDR 06.20.45 E2 Euro 1	6cyl.	9839cc	249kW (339PS)	Diesel	Turbo Intercooled	TD8540
MIDR 06.20.45 F3	6cyl.	9840cc	144kW (196PS)	Diesel	Turbo Intercooled	TD8646
MIDR 06.20.45 H	6cyl.	9839cc	227-240kW (310-326PS)	Diesel	Turbo Intercooled	TD6209
MIDR 06.20.45 I3	6cyl.	9840cc	191kW (260PS)	Diesel	Turbo Intercooled	TD12190
MIDR 06.20.45 I41 Euro 2	6cyl.	9840cc	188kW (256PS)	Diesel	Turbo Intercooled	TD12191
MIDR 06.20.45 J3	6cyl.	9800cc	168kW (228PS)	Diesel	Turbo Intercooled	TD12204
MIDR 06.20.45 K	6cyl.	9840cc	177kW (240PS)	Diesel	Turbo Intercooled	TD7550
MIDR 06.20.45 L	6cyl.	9840cc	177kW (240PS)	Diesel	Turbo Intercooled	TD7551
MIDR 06.20.45 M	6cyl.	9840cc	236kW (321PS)	Diesel	Turbo Intercooled	TD8581
MIDR 06.20.45 M3	6cyl.	9840cc	250kW (340PS)	Diesel	Turbo Intercooled	TD8582
MIDR 06.20.45 M41 Euro 2	6cyl.	9839cc	250kW (340PS)	Diesel	Turbo Intercooled	TD21231
MIDS 06.20.45	6cyl.	9839cc	192-202kW (261-275PS)	Diesel	Turbo Intercooled	TD8633
MIDS 06.20.45 B	6cyl.	9839cc	192-202kW (260-275PS)	Diesel	Turbo Intercooled	TD8537
MIDS 06.20.45 D	6cyl.	9840cc	129kW (175PS)	Diesel	Turbo Intercooled	TD8647
MIDS 06.20.45 F	6cyl.	9840cc	144kW (196PS)	Diesel	Turbo Intercooled	TD8648
MIDS 06.20.45 J	6cyl.	9840cc	161kW (220PS)	Diesel	Turbo Intercooled	TD8588
MIDS 06.20.45 J3	6cyl.	9840cc	168kW (228PS)	Diesel	Turbo Intercooled	TD8589
MIHR 06.20.45 A41 Euro 2	6cyl.	9839cc	185kW (252PS)	Diesel	Turbo Intercooled	TD21269
MIPR 06.20.45 A	6cyl.	9840cc	210kW (286PS)	Diesel	Turbo Intercooled	TD8634
MIPR 06.20.45 A3	6cyl.	9840cc	222kW (302PS)	Diesel	Turbo Intercooled	TD8635
MIPS 06.20.45	6cyl.	9840cc	137-186kW (186-253PS)	Diesel	Turbo Intercooled	TD8630
MIPS 06.20.45 A	6cyl.	9840cc	129kW (175PS)	Diesel	Turbo Intercooled	TD8631
MIPS 06.20.45 B	6cyl.	9840cc	176kW (239PS)	Diesel	Turbo Intercooled	TD8636
MIPS 06.20.45 C	6cyl.	9840cc	144kW (196PS)	Diesel	Turbo Intercooled	TD8632

08-337500-00 01/1992→ [R66700]	STD	120.00	3.500		008 CK P	KV1
			3.000		001 IW CR P	STD
			4.000		231 CR P	STD



15

dCi 11-270 Euro 3		6cyl.	11100cc	195kW (265PS)	Diesel	Turbo Intercooled	TD16876
dCi 11C Euro 3		6cyl.	11100cc	303kW (412PS)	Diesel	Turbo Intercooled	TD16880
dCi 11E Euro 3		6cyl.	11100cc	266kW (362PS)	Diesel	Turbo Intercooled	TD16879
dCi 11G Euro 3		6cyl.	11100cc	230kW (313PS)	Diesel	Turbo Intercooled	TD16878
MIDR 06.23.56 A/3 Euro 2		6cyl.	11100cc	255kW (347PS)	Diesel	Turbo Intercooled	TD17528
MIDR 06.23.56 A/41 Euro 2		6cyl.	11100cc	280kW (381PS)	Diesel	Turbo Intercooled	TD8643
MIDR 06.23.56 B/41 Euro 2		6cyl.	11100cc	288kW (392PS)	Diesel	Turbo Intercooled	TD12207
08-135500-00	STD	123.00	3.500		008 MOL P		KV1
[R66710]			3.000		005 IF CR P		GOE13
			4.000		231 CR P		GOE13
08-135500-10	STD	123.00	3.500		008 IW CK		KV1
			3.000		005 IF CR		GOE13
			4.000		231 CR		GOE13

16

DXi 11		6cyl.	10800cc	272kW (370PS)	Diesel		TD19017
08-438800-00	STD	123.00	3.500		008 IF PVD		ST
			2.500		005 IFU NT		ST
			3.000		231 NT		ST

17

MIDR 06.24.65 A/42 Euro 2		6cyl.	12000cc	287kW (390PS)	Diesel	Turbo Intercooled	TD12148
MIDR 06.24.65 B/42 Euro 2		6cyl.	12000cc	316kW (430PS)	Diesel	Turbo Intercooled	TD12188
MIDR 06.24.65 C/42 Euro 2		6cyl.	12000cc	346kW (471PS)	Diesel	Turbo Intercooled	TD12189
08-429600-00		124.00	3.150		008 MOL P		KV1
			2.362		005 IF CR P		STD
			4.724		231 CR P		STD

18

DXi 13 Euro 4		6cyl.	12800cc	339kW (461PS)	Diesel	Turbo Intercooled	TD19084
08-434400-00	STD	131.00	3.500		008 IF NT PVD		ST
			2.500		005 IFU NT		ST
			3.000		231 NT		ST



19

M 635.40AD	6cyl.	12000cc		Diesel		FM258766
M 635.40AP	6cyl.	12000cc		Diesel		FM18766
M 635.40C	6cyl.	12000cc		Diesel		FM268766
M 635.40CD	6cyl.	12000cc		Diesel		FM278766
M 635.40CP	6cyl.	12000cc		Diesel		FM288766
M 635.40CZ	6cyl.	12000cc		Diesel		FM298766
M 635.40ET	6cyl.	12000cc		Diesel		FM308766
M 635T	6cyl.	12000cc		Diesel		FM318766
MD 06.35.40	6cyl.	12000cc		Diesel		FM348766
MDR 06.35.40	6cyl.	12000cc		Diesel		FM28766
MDS 06.35.40	6cyl.	12024cc	177kW (240PS)	Diesel	Turbo Intercooled	TD8668
MIV 08 35 30	V8cyl.	11886cc		Diesel		FM8701

08-132100-10	STD	135.00	3.500		008 CR P	KV1
			3.000		005 IF	STD
			3.000		005 IF	STD
			6.000		231 CR P	STD

20

MIDR 06.35.40	6cyl.	12000cc	235kW (320PS)	Diesel	Turbo Intercooled	TD19965
MIDR 06.35.40 C	6cyl.	11941cc	224-228kW (305-310PS)	Diesel	Turbo Intercooled	TD8645

08-702300-00	STD	135.00	3.500		008 CR P	KV1
			3.000		005 IF P	STD
			4.000		231 CR P	STD

[R60730]

21



MIDR 06.35.40 G	6cyl.	12024cc	243-259kW (330-352PS)	Diesel	Turbo Intercooled	TD12202
MIDR 06.35.40 H	6cyl.	11941cc	264-275kW (359-374PS)	Diesel	Turbo Intercooled	TD8516
MIDR 06.35.40 J/3 Euro 1	6cyl.	12024cc	305kW (415PS)	Diesel	Turbo Intercooled	TD8519
MIDR 06.35.40 J1 Euro 1	6cyl.	12024cc	314kW (427PS)	Diesel	Turbo Intercooled	TD8653
MIDR 06.35.40 L1	6cyl.	12024cc	283kW (385PS)	Diesel	Turbo Intercooled	TD8517
MIDR 06.35.40 M3 Euro 1	6cyl.	12024cc	236kW (321PS)	Diesel	Turbo Intercooled	TD8543
MIDR 06.35.40 N/3 Euro 1	6cyl.	12024cc	283kW (385PS)	Diesel	Turbo Intercooled	TD8518
MIDR 06.35.40 P/41 Euro 2	6cyl.	12024cc	305kW (415PS)	Diesel	Turbo Intercooled	TD12187

08-335900-00	STD	135.00	4.000		008 MOL P	KV1
			3.000		005 IF P	STD
			4.000		231 CR P	STD





[R60740]



22

MIDS 06.35.40		6cyl.	12000cc		Diesel		FM398766
MIDS 06.35.40 D		6cyl.	12024cc	208kW (283PS)	Diesel	Turbo	TD8542
08-335300-00	STD	135.00	3.500		008 CR P		KV1
[R60720]			3.000		005 IF P		IKA
			6.000		231 CR P		STD

23

MIVR 08.35.30 C		8cyl.	14886cc	286-296kW (389-402PS)	Diesel	Turbo Intercooled	TD8652
MIVR 08.35.30 G		8cyl.	14886cc	310kW (422PS)	Diesel	Turbo Intercooled	TD8654
MIVR 08.35.30 H		8cyl.	14886cc	299-302kW (407-412PS)	Diesel	Turbo Intercooled	TD8655
MIVS 08.35.30		8cyl.	14886cc	267-268kW (363-364PS)	Diesel	Turbo	TD8602
MIVS 08.35.30 F		8cyl.	14886cc	268kW (365PS)	Diesel	Turbo	TD8651
08-132200-10	STD	135.00	3.500		008 CR P		KV1
[R67520]			3.000		005 IF		STD
			3.000		005 IF		STD
			4.000		231 CR P		STD

MODEL INDEX

Modelverzeichnis • Index de modele • Índice de Modelo
Indeks modelu • Модель автомобиля • دليل الموديل



CCM

x



9

09/99→06/01	25 1.1	11 K4F	Petrol	1120	4	3
01/04→05/05	25 1.1 16V	11 K4F	Petrol	1120	4	3
10/99→05/05	25 1.4 16V	14 K4F	Petrol	1396	4	3
10/99→05/05	25 1.4 16V	14 K4M	Petrol	1396	4	3
10/99→05/05	25 1.6 16V	16 K4F (K Series)	Petrol	1588	4	6
10/99→05/05	25 1.8 16V	18 K4F (K Series)	Petrol	1796	4	6
02/00→05/05	25 1.8 16V	18 K4K (VVC)	Petrol	1796	4	6
10/99→05/05	25 2.0 iDT	20 T2N (L Series)	Diesel	1994	4	11
02/00→05/05	45 1.4	14 K4F	Petrol	1396	4	3
02/00→05/05	45 1.6	16 K4F (K Series)	Petrol	1588	4	6
02/00→05/05	45 1.8	18 K4F (K Series)	Petrol	1796	4	6
02/00→05/05	45 2.0 iDT	20 T2N (L Series)	Diesel	1994	4	11
02/00→05/05	45 Saloon 1.4	14 K4F	Petrol	1396	4	3
02/00→05/05	45 Saloon 1.6	16 K4F (K Series)	Petrol	1588	4	6
02/00→05/05	45 Saloon 1.8	18 K4F (K Series)	Petrol	1796	4	6
02/00→05/05	45 Saloon 2.0 iDT	20 T2N (L Series)	Diesel	1994	4	11
02/99→05/05	75 1.8	18 K4F (K Series)	Petrol	1796	4	6
02/99→05/05	75 2.0 CDT	M 47 R	Diesel	1951	4	10
10/01→05/05	75 2.5 V6	25 K4F	Petrol	2497	V6	7
02/99→10/01	75 2.5 V6	KV 6	Petrol	2497	V6	7
08/01→05/05	75 Tourer 1.8	18 K4F (K Series)	Petrol	1796	4	6
08/01→05/05	75 Tourer 2.0 CDT	M 47 R	Diesel	1951	4	10
08/01→05/05	75 Tourer 2.5 V6	KV 6	Petrol	2497	V6	7
01/58→12/62	80 Mk II	2286	Petrol	2286	4	14
01/58→12/62	80 P4	2286	Petrol	2286	4	14
03/90→12/98	100 / Metro 111 C/L/S	11 K2D	Petrol	1120	4	3
10/92→12/94	100 / Metro 114 D	TUD3	Diesel	1360	4	4
10/94→10/95	100 / Metro 114 GSi	14 K4F	Petrol	1396	4	3
03/90→08/91	100 / Metro 114 GTI 16V	14 K4C	Petrol	1396	4	3
03/90→08/91	100 / Metro 114 GTI 16V	14 K4D	Petrol	1396	4	3
08/91→12/98	100 / Metro 114 GTI 16V	14 K4F	Petrol	1396	4	3
03/90→12/98	100 / Metro 114 GTI/GT 16V CAT	14 K4C	Petrol	1396	4	3
03/90→12/98	100 / Metro 114 GTI/GT 16V CAT	14 K4D	Petrol	1396	4	3
03/90→12/98	100 / Metro 114 S/L/GTA	14 K2A	Petrol	1396	4	3
03/90→12/98	100 / Metro 114 S/L/GTA	14 K2D	Petrol	1396	4	3
12/94→12/98	100 / Metro 115 D	TUD5	Diesel	1527	4	5
04/94→10/97	100 Convertible 111	11 K2D	Petrol	1120	4	3
04/94→10/97	100 Convertible 114	14 K2A	Petrol	1396	4	3
04/94→10/97	100 Convertible 114	14 K2D	Petrol	1396	4	3
03/97→10/98	100 Convertible 114	14 K4F	Petrol	1396	4	3
01/98→03/00	200 211	11 K2D	Petrol	1120	4	3
11/95→03/00	200 214 i	14 K2F	Petrol	1396	4	3
11/95→03/00	200 214 Si	14 K4F	Petrol	1396	4	3
11/95→03/00	200 216 Si	16 K4F (K Series)	Petrol	1588	4	6
11/95→03/00	200 218 K Vi	18 K4K (VVC)	Petrol	1796	4	6
08/99→03/00	200 218 Si	18 K4F (K Series)	Petrol	1796	4	6
11/95→03/00	200 220 D/SD	20 T2R (L Series)	Diesel	1994	4	11
11/95→03/00	200 220 SDi	20 T2N (L Series)	Diesel	1994	4	11
05/94→06/99	200 Coupe 220 GSi	20 T4H	Petrol	1994	4	12
09/93→10/95	200 Hatchback 214	14 K2A	Petrol	1396	4	3
09/93→10/95	200 Hatchback 214	14 K2D	Petrol	1396	4	3
01/90→10/95	200 Hatchback 214 GSi/Si	14 K4C	Petrol	1396	4	3
12/92→10/95	200 Hatchback 214 GSi/Si	14 K4F	Petrol	1396	4	3
10/89→10/95	200 Hatchback 214 Si/Gsi	14 K4C	Petrol	1396	4	3
10/89→10/95	200 Hatchback 214 Si/Gsi	14 K4D	Petrol	1396	4	3
09/91→10/95	200 Hatchback 218 TD	XUD 7TE	Diesel	1769	4	8
01/93→10/95	200 Hatchback 220 GTi	20 T4H	Petrol	1994	4	12
01/91→12/96	218 D	XUD9/A/B/L/Y	Diesel	1905	4	9
03/96→12/99	400 414	14 K2F	Petrol	1396	4	3
01/93→04/95	400 414	14 K4C	Petrol	1396	4	3



CCM

x



9

04/90→04/95	400 414 GSI/SI	14 K4C	Petrol	1396	4	3
04/90→04/95	400 414 GSI/SI	14 K4D	Petrol	1396	4	3
01/93→04/95	400 414 GSI/SI CAT	14 K4F	Petrol	1396	4	3
05/95→03/00	400 414 Si	14 K4F	Petrol	1396	4	3
05/95→03/00	400 416 Si	16 K4F (K Series)	Petrol	1588	4	6
09/91→04/95	400 418 TD	XUD 7TE	Diesel	1769	4	8
11/95→03/00	400 420 D	20 T2R (L Series)	Diesel	1994	4	11
05/95→03/00	400 420 Di	20 T2N (L Series)	Diesel	1994	4	11
01/93→04/95	400 420 GSI/SLI/GTI/Vite	20 T4H	Petrol	1994	4	12
12/95→03/00	400 420 Si Lux	20 T4H	Petrol	1994	4	12
03/96→12/97	400 Hatchback 414	14 K2F	Petrol	1396	4	3
05/95→03/00	400 Hatchback 414 Si	14 K4F	Petrol	1396	4	3
05/95→03/00	400 Hatchback 416 Si	16 K4F (K Series)	Petrol	1588	4	6
11/95→03/00	400 Hatchback 420 D	20 T2R (L Series)	Diesel	1994	4	11
05/95→03/00	400 Hatchback 420 Di	20 T2N (L Series)	Diesel	1994	4	11
12/95→03/00	400 Hatchback 420 Si Lux	20 T4H	Petrol	1994	4	12
06/96→11/98	400 Tourer 1.8 i	18 K4K (VVC)	Petrol	1796	4	6
09/93→11/98	400 Tourer 1.8 TD	XUD 7TE	Diesel	1769	4	8
05/94→11/98	400 Tourer 2.0 i	20 T4H	Petrol	1994	4	12
01/92→12/96	418 D	XUD9/A/B/L/Y	Diesel	1905	4	9
01/92→12/96	418 SD	XUD9/A/B/L/Y	Diesel	1905	4	9
01/92→12/96	418 SLD	XUD9/A/B/L/Y	Diesel	1905	4	9
12/94→02/99	600 620 Sdi	20 T2N (L Series)	Diesel	1994	4	11
01/92→02/99	800 820 I/SI	20 T4H	Petrol	1994	4	12
01/90→02/99	800 825 D/SD	492 4 SHIRG	Diesel	2500	4	15
04/96→02/99	800 825 Si Lux	25 K4F	Petrol	2497	V6	7
09/93→02/99	800 Coupe 825 SD	492 4 SHIRG	Diesel	2500	4	15
04/96→02/99	800 Coupe 825 Si	25 K4F	Petrol	2497	V6	7
08/87→09/88	800 Hatchback 2.0	20 T4H	Petrol	1994	4	12
02/96→10/98	800 Hatchback 2.5	25 K4F	Petrol	2497	V6	7
02/96→10/98	800 Hatchback 2.5 Si	25 K4F	Petrol	2497	V6	7
01/93→02/99	800 Hatchback 820 I/SI	20 T4H	Petrol	1994	4	12
01/92→02/99	800 Hatchback 825 D/SD	492 4 SHIRG	Diesel	2500	4	15
06/76→10/86	2000- 3500	38 A	Petrol	3528	V8	13
06/76→10/86	2000- 3500	39 A	Petrol	3528	V8	13
05/82→10/86	2000-3500 Hatchback 2400 TD	HR 492 HT	Diesel	2393	4	15
10/82→10/86	2000-3500 Hatchback 3500 Vitesse	30 A	Petrol	3528	V8	13
10/82→10/86	2000-3500 Hatchback 3500 Vitesse	31 A	Petrol	3528	V8	13
01/77→12/86	3500	3.5L Carburettor	Petrol	3528	V8	13
01/77→12/86	3500 S	3.5L Carburettor	Petrol	3528	V8	13
01/77→12/86	3500 SE	3.5L Carburettor	Petrol	3528	V8	13
01/77→12/86	3500 Vanden Plas	3.5L Carburettor	Petrol	3528	V8	13
04/90→11/99	Cabriolet 214 1.4	14 K4C	Petrol	1396	4	3
01/92→11/99	Cabriolet 214 1.4	14 K4D	Petrol	1396	4	3
01/93→11/99	Cabriolet 214 1.4i 16V	14 K4F	Petrol	1396	4	3
01/96→11/99	Cabriolet 216 1.6i 16V	16 K4F (K Series)	Petrol	1588	4	6
03/96→11/99	Coupe 1.6 16 V	16 K4F (K Series)	Petrol	1588	4	6
03/96→11/99	Coupe 1.8 16 V	18 K4K (VVC)	Petrol	1796	4	6
	Maestro 1.3	A+ Series (12 H)	Petrol	1275	4	2
	Mini 1.3 Cooper	A+ Series (12 H)	Petrol	1275	4	2
01/92→06/93	Mini 1000	A+ Series (99H)	Petrol	998	4	1
10/92→11/00	Mini 1300	12 A2B	Petrol	1275	4	2
01/91→12/91	Mini 1300	A Series (12 A2A)	Petrol	1275	4	2
01/92→11/00	Mini 1300	A Series (12 A2L)	Petrol	1275	4	2
01/92→04/95	Mini 1300	A+ Series (12 A2D)	Petrol	1275	4	2
01/92→11/00	Mini 1300	A+ Series (12 A2E)	Petrol	1275	4	2
06/91→02/94	Mini 1300 / Cooper	A Series (12 A2A)	Petrol	1275	4	2
02/98→05/01	Mini Convertible 1.3 S	A Series (12 A2L)	Petrol	1275	4	2
09/92→04/95	Mini Convertible 1300	A+ Series (12 A2E)	Petrol	1275	4	2
08/81→09/90	Range Rover Vogue	11 D	Petrol	3528	V8	13

MODEL INDEX

Modelverzeichnis • Index de modele • Índice de Modelo
Indeks modelu • Модель автомобиля • دليل الموديل



CCM

x



9

10/85→09/90	Range Rover Vogue	24 D	Petrol	3528	V8	13
10/85→09/90	Range Rover Vogue	25 D	Petrol	3528	V8	13
08/81→09/90	Range Rover Vogue	31 D	Petrol	3528	V8	13
08/03→05/05	Streetwise 1.4	14 K4F	Petrol	1396	4	3
08/03→05/05	Streetwise 1.4	14 K4M	Petrol	1396	4	3
01/04→05/05	Streetwise 1.6	16 K4F (K Series)	Petrol	1588	4	6
08/03→05/05	Streetwise 1.8	18 K4F (K Series)	Petrol	1796	4	6
08/03→05/05	Streetwise 2.0 TD	20 T2N (L Series)	Diesel	1994	4	11
01/84→12/86	V8 S Vanden Plas Auto	3.5L EFi	Petrol	3528	V8	13
01/82→12/86	Vitesse 3500	3.5L EFi	Petrol	3528	V8	13

ENGINE INDEX

Motorverzeichnis • Index de moteur • Índice de Motor
Indeks silnika • Модель двигателя • دليل المحرك



CCM

x



9

3.5L Carburettor	Petrol	3528	V8	88.86	13
3.5L EFi	Petrol	3528	V8	88.86	13
11 D	Petrol	3528	V8	88.86	13
11 K2D	Petrol	1120	4	75.00	3
11 K4F	Petrol	1120	4	75.00	3
12 A2B	Petrol	1275	4	70.62	2
14 K2A	Petrol	1396	4	75.00	3
14 K2D	Petrol	1396	4	75.00	3
14 K2F	Petrol	1396	4	75.00	3
14 K4C	Petrol	1396	4	75.00	3
14 K4D	Petrol	1396	4	75.00	3
14 K4F	Petrol	1396	4	75.00	3
14 K4M	Petrol	1396	4	75.00	3
16 K4F (K Series)	Petrol	1588	4	80.00	6
18 K4F (K Series)	Petrol	1796	4	80.00	6
18 K4K (VVC)	Petrol	1796	4	80.00	6
20 T2N (L Series)	Diesel	1994	4	84.45	11
20 T2R (L Series)	Diesel	1994	4	84.45	11
20 T4H	Petrol	1994	4	84.45	12
24 D	Petrol	3528	V8	88.86	13
25 D	Petrol	3528	V8	88.86	13
25 K4F	Petrol	2497	V6	80.00	7
30 A	Petrol	3528	V8	88.86	13
31 A	Petrol	3528	V8	88.86	13
31 D	Petrol	3528	V8	88.86	13
38 A	Petrol	3528	V8	88.86	13
39 A	Petrol	3528	V8	88.86	13
492 4 SHIRG	Diesel	2500	4	92.00	15
2286	Petrol	2286	4	90.47	14
A Series (12 A2A)	Petrol	1275	4	70.62	2
A Series (12 A2L)	Petrol	1275	4	70.62	2
A+ Series (12 A2D)	Petrol	1275	4	70.62	2
A+ Series (12 A2E)	Petrol	1275	4	70.62	2
A+ Series (12 H)	Petrol	1275	4	70.62	2
A+ Series (99H)	Petrol	998	4	64.56	1
HR 492 HT	Diesel	2393	4	92.00	15
KV 6	Petrol	2497	V6	80.00	7
M 47 R	Diesel	1951	4	84.00	10
TUD3	Diesel	1360	4	75.00	4
TUD5	Diesel	1527	4	77.00	5
XUD 7TE	Diesel	1769	4	80.00	8
XUD9/A/B/L/Y	Diesel	1905	4	83.00	9



Mini 1000		01/92→06/93		A+ Series (99H)		4cyl. 998cc 30kW (41PS)		1	
								TD3483	
08-522400-00	STD	64.56	1.588		001 P	F12/F14			
08-522407-00	.020				005 P	STD			
08-522411-00	.040			1.588		005 P	STD		
08-522414-00	.060			1.588		005 P	STD		
01/1980→12/1985				1.588		005 P	STD		
[R33636]			4.000		231 CR P	STD			
08-524300-10	STD	64.56	1.500		001 CK P	KV1			
08-524307-10	.020			1.500		005 P	GOE12		
08-524311-10	.040			1.500		005 P	GOE12		
08-524314-10	.060			3.000		231 P	GOE12		
01/1986→06/1992				3.000		231 P	GOE12		
Mini 1300		10/92→11/00		12 A2B		4cyl. 1275cc 37kW (50PS)		2	
								TD4880	
Mini 1300		01/91→12/91		A Series (12 A2A)		4cyl. 1275cc 45kW (61PS)		TD9490	
Mini 1300 / Cooper		06/91→02/94							
Mini 1300		01/92→11/00		A Series (12 A2L)		4cyl. 1275cc 45kW (61PS)		TD9489	
Mini Convertible 1.3 S		02/98→05/01							
Mini 1300		01/92→04/95		A+ Series (12 A2D)		4cyl. 1275cc 39kW (53PS)		TD3473	
Mini 1300		01/92→11/00		A+ Series (12 A2E)		4cyl. 1275cc 46kW (63PS)		TD3487	
Mini Convertible 1300		09/92→04/95							
Maestro 1.3, Mini 1.3 Cooper				A+ Series (12 H)		4cyl. 1275cc 47kW (64PS)		TD22364	
08-521700-00	STD	70.62	1.488		001 P	IKA			
08-521707-00	.020			1.488		026 P	STD		
08-521711-00	.040			4.000		231 P	STD		
08-521714-00	.060			1.500		001 NT	KV1		
[R35960]				1.500		026 P	GOE12		
08-524100-00	STD	70.62	1.500		026 P	GOE12			
08-524107-00	.020			1.500		026 P	GOE12		
08-524111-00	.040			3.000		231 P	GOE12		
08-524114-00	.060			3.000		231 P	GOE12		
[R41570]				3.000		231 P	GOE12		



100 / Metro 111 C/L/S 100 Convertible 111 200 211	03/90→12/98 04/94→10/97 01/98→03/00	11 K2D	4cyl. 1120cc	44kW (60PS)	3 TD4884
25 1.1 25 1.1 16V	09/99→06/01 01/04→05/05	11 K4F	4cyl. 1120cc	55kW (75PS)	TD18365
100 / Metro 114 S/L/GTA 100 Convertible 114 200 Hatchback 214	03/90→12/98 04/94→10/97 09/93→10/95	14 K2A	4cyl. 1396cc	55kW (75PS)	TD3477
100 / Metro 114 S/L/GTA 100 Convertible 114 200 Hatchback 214	03/90→12/98 04/94→10/97 09/93→10/95	14 K2D	4cyl. 1396cc	55kW (75PS)	TD3478
200 214 i 400 414 400 Hatchback 414	11/95→03/00 03/96→12/99 03/96→12/97	14 K2F	4cyl. 1396cc	55kW (75PS)	TD9499
100 / Metro 114 GTI 16V 100 / Metro 114 GTI/GT 16V CAT 200 Hatchback 214 GSi/Si 200 Hatchback 214 Si/Gsi 400 414 400 414 GSI/SI Cabriolet 214 1.4	03/90→08/91 03/90→12/98 01/90→10/95 10/89→10/95 01/93→04/95 04/90→04/95 04/90→11/99	14 K4C	4cyl. 1396cc	66-70kW (90-95PS)	TD3480
100 / Metro 114 GTI 16V 100 / Metro 114 GTI/GT 16V CAT 200 Hatchback 214 Si/Gsi 400 414 GSI/SI Cabriolet 214 1.4	03/90→08/91 03/90→12/98 10/89→10/95 04/90→04/95 01/92→11/99	14 K4D	4cyl. 1396cc	75-77kW (102-105PS)	TD3488
25 1.4 16V 45 1.4, 45 Saloon 1.4 100 / Metro 114 GSi 100 / Metro 114 GTI 16V 100 Convertible 114 200 214 Si 200 Hatchback 214 GSi/Si 400 414 GSI/SI CAT 400 414 Si, 400 Hatchback 414 Si Cabriolet 214 1.4i 16V Streetwise 1.4	10/99→05/05 02/00→05/05 10/94→10/95 08/91→12/98 03/97→10/98 11/95→03/00 12/92→10/95 01/93→04/95 05/95→03/00 01/93→11/99 08/03→05/05	14 K4F	4cyl. 1396cc	76kW (103PS)	TD3481
25 1.4 16V Streetwise 1.4	10/99→05/05 08/03→05/05	14 K4M	4cyl. 1396cc	62kW (84PS)	TD18231

08-520500-00 01/1995→ [R49650]	STD	75.00	1.000		001	ST
			1.200		026	F12/F14
			2.000		712 NT	ST



100 / Metro 114 D		10/92→12/94	TUD3	4cyl. 1360cc	38kW (52PS)	4
			Diesel			TD12127
08-154500-00 →12/1992 <i>[R60980]</i>	STD	75.00	2.250	001 IF P PS		KV1
			1.750	005 P		IKA
			3.000	231 CR P		STD
100 / Metro 115 D		12/94→12/98	TUD5	4cyl. 1527cc	42kW (57PS)	5
			Diesel			TD3490
08-325800-00 08-325806-00 <i>[R49960]</i>	STD 0.40mm	77.00	2.000	001 CK P		KV1
			1.750	005 P		STD
			3.000	231 CR P		STD
25 1.6 16V 45 1.6, 45 Saloon 1.6 200 216 Si 400 416 Si, 400 Hatchback 416 Si Cabriolet 216 1.6i 16V Coupe 1.6 16 V Streetwise 1.6			10/99→05/05 02/00→05/05 11/95→03/00 05/95→03/00 01/96→11/99 03/96→11/99 01/04→05/05	16 K4F (K Series) 4cyl. 1588cc	81kW (110PS)	6
						TD9358
25 1.8 16V 45 1.8, 45 Saloon 1.8 200 218 Si Streetwise 1.8			10/99→05/05 02/00→05/05 08/99→03/00 08/03→05/05	18 K4F (K Series) 4cyl. 1796cc	87kW (118PS)	
						TD9483
75 1.8 75 Tourer 1.8			02/99→05/05 08/01→05/05	18 K4F (K Series) 4cyl. 1796cc	88kW (120PS)	
						TD11607
25 1.8 16V 200 218 K Vi 400 Tourer 1.8 i Coupe 1.8 16 V			02/00→05/05 11/95→03/00 06/96→11/98 03/96→11/99	18 K4K (VVC) 4cyl. 1796cc	107-110kW (146-150PS)	
						TD3500
08-522700-00 <i>[R49540]</i>	STD	80.00	1.000	001 CR		ST
			1.200	026 P		STD
			2.000	712 CR		ST
75 2.5 V6 800 825 Si Lux, 800 Coupe 825 Si 800 Hatchback 2.5, 800 Hatchback 2.5 Si			10/01→05/05 04/96→02/99 02/96→10/98	25 K4F V6cyl. 2497cc	130kW (177PS)	7
						TD9492
75 2.5 V6 75 Tourer 2.5 V6			02/99→10/01 08/01→05/05	KV 6 V6cyl. 2497cc	129kW (175PS)	
						TD11608
08-521600-00 <i>[R49740]</i>	STD	80.00	1.200	001 CR		STD
			1.500	026		STD
			2.500	712 CR		ST



200 Hatchback 218 TD	09/91→10/95	XUD 7TE		8
400 418 TD	09/91→04/95	4cyl.		
400 Tourer 1.8 TD	09/93→11/98	1769cc	66kW (89PS)	
		Diesel	Turbo	TD3504

08-323600-00	STD	80.00	3.000		008 MOL P	KV1
08-323607-00	0.50mm		2.000		005 P	STD
[R49910]			3.000		231 CR P	STD

218 D	01/91→12/96	XUD9/A/B/L/Y		9
418 D, 418 SD, 418 SLD	01/92→12/96	4cyl.		
		1905cc		
		Diesel		FM3219

08-152000-00	STD	83.00	2.000		001 CR P	KV1
08-152003-00	0.125mm		2.000		005 P	STD
08-152007-00	0.50mm		2.000		231 CR P	STD
08-152010-00	0.80mm		3.000			
08-152011-00	1.00mm		3.000			
[R66390]						

75 2.0 CDT	02/99→05/05	M 47 R		10
75 Tourer 2.0 CDT	08/01→05/05	4cyl.		
		1951cc	85kW (116PS)	
		Diesel	Turbo Intercooled	TD11609

08-114400-00	STD	84.00	3.000		008 CK P	KV1
08-114405-00	0.25mm		2.000		026 P	STD
[R60220]			3.000		231 CR P	STD
08-114400-10	STD	84.00	3.000		008 CK P	KV1
01/2001→			2.000		026 P	STD
			3.000		231 NT	ST

25 2.0 iDT	10/99→05/05	20 T2N (L Series)		11
45 2.0 iDT, 45 Saloon 2.0 iDT	02/00→05/05	4cyl.		
200 220 SDi	11/95→03/00	1994cc	74-83kW (101-113PS)	
400 420 Di, 400 Hatchback 420 Di	05/95→03/00	Diesel	Turbo Intercooled	TD9496
600 620 Sdi	12/94→02/99			
Streetwise 2.0 TD	08/03→05/05			

200 220 D/SD, 400 420 D,	11/95→03/00	20 T2R (L Series)		11
400 Hatchback 420 D		4cyl.		
		1994cc	63kW (86PS)	
		Diesel	Turbo	TD9497

08-119800-00	STD	84.45	3.000		008 IF PS	KV1
08-119807-00	0.50mm		2.000		026 P	F12/F14
→eng.10P13888B			3.000		231 CR	STD
[R49390]						



200 Coupe 220 GSi			05/94→06/99	20 T4H				12
200 Hatchback 220 GTi			01/93→10/95		4cyl.			
400 420 GSi/SLI/GTi/Vite			01/93→04/95		1994cc	100kW (136PS)		
400 420 Si Lux, 400 Hatchback 420 Si Lux			12/95→03/00					
400 Tourer 2.0 i			05/94→11/98					
800 820 I/Si			01/92→02/99					
800 Hatchback 2.0			08/87→09/88					
800 Hatchback 820 I/Si			01/93→02/99				TD3479	
08-524600-00	STD	84.45	1.200		001 NT		ST	
08-524607-00	.020		1.500		026 P		IKA	
[R45290]			3.000		231 P		GOE12	
Range Rover Vogue			08/81→09/90	11 D				13
					V8cyl.	3528cc	93kW (126PS)	
Range Rover Vogue			10/85→09/90	24 D				13
					V8cyl.	3528cc	120kW (163PS)	
Range Rover Vogue			10/85→09/90	25 D				13
					V8cyl.	3528cc	120kW (163PS)	
3500, 3500 S, 3500 SE, 3500 Vanden Plas			01/77→12/86	3.5L Carburettor				13
					V8cyl.	3528cc		
V8 S Vanden Plas Auto			01/84→12/86	3.5L EFi				13
Vitesse 3500			01/82→12/86		V8cyl.	3528cc		
2000-3500 Hatchback 3500 Vitesse			10/82→10/86	30 A				13
					V8cyl.	3528cc	120kW (163PS)	
2000-3500 Hatchback 3500 Vitesse			10/82→10/86	31 A				13
					V8cyl.	3528cc	120kW (163PS)	
Range Rover Vogue			08/81→09/90	31 D				13
					V8cyl.	3528cc	93kW (126PS)	
2000- 3500			06/76→10/86	38 A				13
					V8cyl.	3528cc	93kW (126PS)	
2000- 3500			06/76→10/86	39 A				13
					V8cyl.	3528cc	93kW (126PS)	
08-520100-00	STD	88.86	1.588		001 CR P		KV1	
08-520107-00	.020		1.588		005 IW P		GOE12	
[R29296]			4.737		031 P		GOE12	



80 Mk II, 80 P4	01/58→12/62	2286	4cyl. 2286cc	14
FM1533				

08-263100-00	STD	90.47	1.790		001 IF CR P	STD
08-263107-00	.020		1.790		026 P	STD
<i>[R11686V1]</i>			4.747		236 P	STD

800 825 D/SD	01/90→02/99	492 4 SHIRG	4cyl. 2500cc	87kW (118PS)	15
800 Coupe 825 SD	09/93→02/99				
800 Hatchback 825 D/SD	01/92→02/99				
Diesel					TD3502

2000-3500 Hatchback 2400 TD	05/82→10/86	HR 492 HT	4cyl. 2393cc	67kW (91PS)	
Diesel Turbo					TD22366

08-110100-00	STD	92.00	2.500		008 CR P	KV1
<i>[R47730]</i>			2.000		026 P	STD
			4.000		231 CR P	STD



CCM

x



9

01/00→	9-3	X 22DTR	Diesel	2172	4	7
01/04→	9-3 1.8 i	Z18XE	Petrol	1796	4	2
09/04→	9-3 1.9 TiD	Z19DT	Diesel	1910	4	5
09/04→	9-3 1.9 TiD	Z19DTH	Diesel	1910	4	4
02/98→09/02	9-3 2.0 i	B204I	Petrol	1985	4	10
10/98→09/02	9-3 2.0 Turbo	B204E	Petrol	1985	4	10
02/98→09/02	9-3 2.0 Turbo	B204L	Petrol	1985	4	10
02/98→11/00	9-3 2.2 TiD	D223L	Diesel	2171	4	7
09/02→	9-3 2.2 TiD	D223L	Diesel	2171	4	7
11/00→09/02	9-3 2.2 TiD	D223L	Diesel	2171	4	7
02/98→09/02	9-3 2.3 i	B234I	Petrol	2290	4	10
02/98→08/03	9-3 Cabriolet 2.0 i	B204I	Petrol	1985	4	10
10/98→08/03	9-3 Cabriolet 2.0 Turbo	B204E	Petrol	1985	4	10
02/98→08/03	9-3 Cabriolet 2.0 Turbo	B204L	Petrol	1985	4	10
02/98→08/03	9-3 Cabriolet 2.3 i	B234I	Petrol	2290	4	10
01/06→	9-3 Convertible 1.9 TiD	Z19DTH	Diesel	1910	4	4
03/05→	9-3 Estate 1.8 i	Z18XE	Petrol	1796	4	2
03/05→	9-3 Estate 1.9 TiD	Z 19 DTJ	Diesel	1910	4	4
03/05→	9-3 Estate 1.9 TiD	Z19DTH	Diesel	1910	4	4
05/10→	9-5 1.6 Turbo	A 16 LET Euro 5	Petrol	1598	4	1
01/06→	9-5 1.9 TiD	Z19DTH	Diesel	1910	4	4
05/10→	9-5 2.0 TiD	A 20 DTH Euro 5	Diesel	1956	4	6
05/10→	9-5 2.0 TTiD	A 20 DTR Euro 5	Diesel	1956	4	6
05/10→	9-5 2.0 TTiD XWD	A 20 DTR Euro 5	Diesel	1956	4	6
03/02→	9-5 2.2 TiD	D223L	Diesel	2171	4	7
01/06→	9-5 Estate 1.9 TiD	Z19DTH	Diesel	1910	4	4
03/02→	9-5 Estate 2.2 TiD	D223L	Diesel	2171	4	7
08/84→08/87	90 2.0	B 20 I	Petrol	1985	4	9
01/73→12/74	97 Sonett	EV17L	Petrol	1699	V4	11
09/74→12/78	99 2.0 EMS	B 20 I	Petrol	1985	4	9
09/74→12/84	99 2.0 GL	B 20 C	Petrol	1985	4	9
09/74→12/84	99 2.0 GL	B 20 I	Petrol	1985	4	9
01/81→12/84	99 Combi Coupe 2.0 i	BI 20	Petrol	1985	4	9
01/86→	900	B234	Petrol	2290	4	10
07/82→12/88	900 I 2.0 c	B201XC	Petrol	1985	4	9
01/79→12/80	900 I 2.0 EMS	BI 20	Petrol	1985	4	9
11/80→08/90	900 I 2.0 i	BI 20	Petrol	1985	4	9
09/79→12/88	900 I Combi Coupe 2.0 c	B201XC	Petrol	1985	4	9
09/78→08/79	900 I Combi Coupe 2.0 EMS	BI 20	Petrol	1985	4	9
11/80→12/88	900 I Combi Coupe 2.0 i	BI 20	Petrol	1985	4	9
07/93→02/98	900 II 2.0 -16 Turbo	B204L	Petrol	1985	4	10
08/94→02/98	900 II 2.0 i	B204I	Petrol	1985	4	10
07/93→02/98	900 II 2.3 -16	B234I	Petrol	2290	4	10
07/93→02/98	900 II 2.5 -24 V6	B258I	Petrol	2498	V6	3
12/93→02/98	900 II Convertible 2.0 -16 Turbo	B204L	Petrol	1985	4	10
12/93→02/98	900 II Convertible 2.0 i	B204I	Petrol	1985	4	10
12/93→02/98	900 II Convertible 2.3 -16	B234I	Petrol	2290	4	10
12/93→02/98	900 II Convertible 2.5 -24 V6	B258I	Petrol	2498	V6	3
12/93→02/98	900 II Coupe 2.0 -16 Turbo	B204L	Petrol	1985	4	10
08/94→02/98	900 II Coupe 2.0 i	B204I	Petrol	1985	4	10
12/93→02/98	900 II Coupe 2.3 -16	B234I	Petrol	2290	4	10
12/93→02/98	900 II Coupe 2.5 -24 V6	B258I	Petrol	2498	V6	3
09/93→12/98	9000 2.0 -16 CD	B204E	Petrol	1985	4	10
09/93→12/98	9000 2.0 -16 CD	B204I	Petrol	1985	4	10
09/92→12/98	9000 2.0 -16 Turbo CD	B204E	Petrol	1985	4	10
09/89→08/90	9000 2.0 Carlsson	B204L	Petrol	1985	4	10
10/89→01/92	9000 2.3	B234I	Petrol	2290	4	10
09/90→10/98	9000 2.3	B234R	Petrol	2290	4	10
08/89→12/98	9000 2.3 -16 CD	B234I	Petrol	2290	4	10
07/90→12/98	9000 2.3 -16 CD Turbo	B234L	Petrol	2290	4	10

MODEL INDEX

Modelverzeichnis • Index de modele • Índice de Modelo
Indeks modelu • Модель автомобиля • دليل المحرك



CCM

x



9

09/93→12/98	9000 2.3 -16 CDE	B234I	Petrol	2290	4	10
09/93→12/98	9000 2.3 -16 CDE Eco-Power	B234E	Petrol	2290	4	10
09/90→08/93	9000 2.3 -16 Turbo	B234L	Petrol	2290	4	10
07/94→12/98	9000 3.0 -24 V6 CD/CDE	B308I	Petrol	2962	V6	8
01/91→	9000 CS 2.3-16 Turbo	B234	Petrol	2290	4	10
09/93→12/98	9000 Hatchback 2.0 -16 CS	B204I	Petrol	1985	4	10
09/93→12/98	9000 Hatchback 2.0 -16 ND Turbo	B204E	Petrol	1985	4	10
01/90→12/93	9000 Hatchback 2.3	B234I	Petrol	2290	4	10
02/93→12/98	9000 Hatchback 2.3 -16 Aero CS	B234R	Petrol	2290	4	10
09/89→12/98	9000 Hatchback 2.3 -16 CS	B234I	Petrol	2290	4	10
09/93→12/98	9000 Hatchback 2.3 -16 CSE	B234I	Petrol	2290	4	10
09/93→12/98	9000 Hatchback 2.3 -16 CSE Eco Power	B234E	Petrol	2290	4	10
09/90→12/98	9000 Hatchback 2.3 -16 Turbo	B234L	Petrol	2290	4	10
09/93→12/98	9000 Hatchback 2.3 -16 Turbo CSE	B234L	Petrol	2290	4	10
07/94→12/98	9000 Hatchback 3.0 -24 V6 CS/CSE	B308I	Petrol	2962	V6	8
01/91→	9000 S 2.3-16 Turbo	B234	Petrol	2290	4	10
01/91→	9000 SE 2.3-16 Turbo CD Turbo 16v	B234	Petrol	2290	4	10

ENGINE INDEX

Motorverzeichnis • Index de moteur • Índice de Motor
Indeks silnika • Модель двигателя • دليل المحرك



CCM

x



9

A 16 LET Euro 5	Petrol	1598	4	79.00	1
A 20 DTH Euro 5	Diesel	1956	4	83.00	6
A 20 DTR Euro 5	Diesel	1956	4	83.00	6
B 20 C	Petrol	1985	4	90.00	9
B 20 I	Petrol	1985	4	90.00	9
B201XC	Petrol	1985	4	90.00	9
B204E	Petrol	1985	4	90.00	10
B204I	Petrol	1985	4	90.00	10
B204L	Petrol	1985	4	90.00	10
B234	Petrol	2290	4	90.00	10
B234E	Petrol	2290	4	90.00	10
B234I	Petrol	2290	4	90.00	10
B234L	Petrol	2290	4	90.00	10
B234R	Petrol	2290	4	90.00	10
B258I	Petrol	2498	V6	81.60	3
B308I	Petrol	2962	V6	86.00	8
BI 20	Petrol	1985	4	90.00	9
D223L	Diesel	2171	4	84.00	7
EV17L	Petrol	1699	V4	90.00	11
X 22DTR	Diesel	2172	4	84.00	7
Z 19 DTJ	Diesel	1910	4	82.00	4
Z18XE	Petrol	1796	4	80.50	2
Z19DT	Diesel	1910	4	82.00	5
Z19DTH	Diesel	1910	4	82.00	4



9-5 1.6 Turbo		05/10→	A 16 LET Euro 5		1	
				4cyl.		
				1598cc	132kW (180PS)	
				Turbo Intercooled		TD24444
08-435500-00	STD	79.00	1.200		001 NT	ST
08-435507-00	0.50mm		1.200		026 P	GOE13
			2.000		712 NT	ST
9-3 1.8 i		01/04→	Z18XE		2	
9-3 Estate 1.8 i		03/05→		4cyl.		
				1796cc	90kW (122PS)	
						TD18079
08-141200-00	STD	80.50	1.200		001 NT	ST
08-141207-00	0.50mm		1.200		005 P	GOE12
			2.000		712 CR	ST
900 II 2.5 -24 V6		07/93→02/98	B258I		3	
900 II Convertible 2.5 -24 V6,		12/93→02/98		V6cyl.		
900 II Coupe 2.5 -24 V6				2498cc	125kW (170PS)	
						TD3526
08-307700-00	STD	81.60	1.500		001 MO P	IKA
08-307707-00	0.50mm		1.500		026 P	STD
08-307711-00	1.00mm		3.000		712 CR	ST
<i>[R49600]</i>						
9-3 Estate 1.9 TiD		03/05→	Z 19 DTJ		4	
				4cyl.		
				1910cc	88kW (120PS)	
				Diesel	Turbo Intercooled	TD24819
9-3 1.9 TiD		09/04→	Z19DTH		5	
9-3 Convertible 1.9 TiD		01/06→		4cyl.		
9-3 Estate 1.9 TiD		03/05→		1910cc	110kW (150PS)	
9-5 1.9 TiD,9-5 Estate 1.9 TiD		01/06→		Diesel	Turbo Intercooled	TD18084
08-146100-00	STD	82.00	2.000		001 CK P	KV1
08-146106-00	0.40mm		2.000		023 IWU P	F12/F14
08-146108-00	0.60mm		2.000		231 CK P	GOE12
<i>[R67925]</i>						
9-3 1.9 TiD		09/04→	Z19DT		5	
				4cyl.		
				1910cc	88kW (120PS)	
				Diesel	Turbo Intercooled	TD18086
08-124000-00	STD	82.00	2.000		001 CK P	KV1
08-124006-00	0.40mm		2.000		026 P	F12/F14
08-124008-00	0.60mm		2.000		231 CR P	GOE12
<i>[R60580]</i>						



9-5 2.0 TiD		05/10→	A 20 DTH Euro 5		4cyl.		6
			1956cc		118kW (160PS)		
			Diesel		Turbo Intercooled		TD24003
9-5 2.0 TTiD,9-5 2.0 TTiD XWD		05/10→	A 20 DTR Euro 5		4cyl.		7
			1956cc		140kW (190PS)		
			Diesel		Bi-Turbo Intercooled		TD24442
08-436500-00	STD	83.00	1.500		001 GDC P		KV4
08-436506-00	0.40mm		1.500		050 P		F12/F14
			2.000		231 LKZ CK P		GOE13
9-3 2.2 TiD		02/98→	D223L		4cyl.		8
9-5 2.2 TiD,9-5 Estate 2.2 TiD		03/02→	2171cc		85-92kW (115-125PS)		
			Diesel		Turbo Intercooled		TD18087
9-3		01/00→	X 22DTR		4cyl.		9
			2172cc		92kW (125PS)		
			Diesel		Turbo Intercooled		FM25624
08-126000-00	STD	84.00	1.750		001 CK P		KV1
08-126007-00	0.50mm		1.750		005 P		IKA
[R60610]			3.000		231 CR P		GOE12
9000 3.0 -24 V6 CD/CDE, 9000 Hatchback 3.0 -24 V6 CS/CSE		07/94→12/98	B308I		V6cyl.		8
			2962cc		155kW (211PS)		
							TD5373
08-306800-00	STD	86.00	1.500		001 IF CR P		IKA
08-306807-00	0.50mm		1.500		005 IF P		STD
08-306811-00	1.00mm		3.000		712 CR		ST
							[R43290]
99 2.0 GL		09/74→12/84	B 20 C		4cyl.		9
			1985cc		74kW (100PS)		
							TD3506
90 2.0		08/84→08/87	B 20 I		4cyl.		9
99 2.0 EMS		09/74→12/78	1985cc		74-87kW (100-118PS)		
99 2.0 GL		09/74→12/84					
							TD3507
900 I 2.0 c		07/82→12/88	B201XC		4cyl.		9
900 I Combi Coupe 2.0 c		09/79→12/88	1985cc		74kW (100PS)		
							TD3508





99 Combi Coupe 2.0 i	01/81→12/84	BI 20				
900 I 2.0 EMS	01/79→12/80		4cyl.			
900 I 2.0 i	11/80→08/90		1985cc	85kW (116PS)		
900 I Combi Coupe 2.0 EMS	09/78→08/79					
900 I Combi Coupe 2.0 i	11/80→12/88					TD3528
08-347000-00	STD	90.00	1.750		001 IF CR P	IKA
[R26596]			2.000		026 P	STD
			4.000		712 CR	ST
9-3 2.0 Turbo	10/98→09/02	B204E				10
9-3 Cabriolet 2.0 Turbo	10/98→08/03		4cyl.			
9000 2.0 -16 CD	09/93→12/98		1985cc	108-113kW (147-154PS)		
9000 2.0 -16 Turbo CD	09/92→12/98		Turbo			
9000 Hatchback 2.0 -16 ND Turbo	09/93→12/98					TD5372
9-3 2.0 i	02/98→09/02	B204I				
9-3 Cabriolet 2.0 i	02/98→08/03		4cyl.			
900 II 2.0 i	08/94→02/98		1985cc	96kW (131PS)		
900 II Convertible 2.0 i	12/93→02/98					
900 II Coupe 2.0 i	08/94→02/98					
9000 2.0 -16 CD,	09/93→12/98					
9000 Hatchback 2.0 -16 CS						TD3518
9-3 2.0 Turbo	02/98→09/02	B204L				
9-3 Cabriolet 2.0 Turbo	02/98→08/03		4cyl.			
900 II 2.0 -16 Turbo	07/93→02/98		1985cc	136kW (185PS)		
900 II Convertible 2.0 -16 Turbo,	12/93→02/98		Turbo Intercooled			
900 II Coupe 2.0 -16 Turbo						
9000 2.0 Carlsson	09/89→08/90					TD5369
900	01/86→	B234				
9000 CS 2.3-16 Turbo,	01/91→		4cyl.			
9000 S 2.3-16 Turbo,			2290cc	120-143kW (163-194PS)		
9000 SE 2.3-16 Turbo,CD Turbo 16v			Turbo			FM5240
9000 2.3 -16 CDE Eco-Power,	09/93→12/98	B234E				
9000 Hatchback 2.3 -16 CSE Eco Power			4cyl.			
			2290cc	125kW (170PS)		
						TD3522
9-3 2.3 i	02/98→09/02	B234I				
9-3 Cabriolet 2.3 i	02/98→08/03		4cyl.			
900 II 2.3 -16	07/93→02/98		2290cc	110kW (150PS)		
900 II Convertible 2.3 -16,	12/93→02/98					
900 II Coupe 2.3 -16						
9000 2.3	10/89→01/92					
9000 2.3 -16 CD	08/89→12/98					
9000 2.3 -16 CDE	09/93→12/98					
9000 Hatchback 2.3	01/90→12/93					
9000 Hatchback 2.3 -16 CS	09/89→12/98					
9000 Hatchback 2.3 -16 CSE	09/93→12/98					TD3523
9000 2.3 -16 CD Turbo	07/90→12/98	B234L				
9000 2.3 -16 Turbo	09/90→08/93		4cyl.			
9000 Hatchback 2.3 -16 Turbo	09/90→12/98		2290cc	143-147kW (195-200PS)		
9000 Hatchback 2.3 -16 Turbo CSE	09/93→12/98		Turbo			TD3525





9000 2.3	09/90→10/98	B234R	4cyl.	
9000 Hatchback 2.3 -16 Aero CS	02/93→12/98		2290cc	162-165kW (220-225PS)
			Turbo	TD3524

08-963300-00	STD	90.00	1.750		001 IW CR P	KV1
			2.000		026 P	STD
			3.000		712 CR	ST

97 Sonett	01/73→12/74	EV17L	V4cyl.	1699cc	11
					FM2425

08-204500-00	STD	90.00	2.000		001 IF MO P	IKA
			3.000		026 P	STD
			4.000		712 CR	ST



1

1000.3 A			3cyl.	3117cc		Diesel		FM4153
1000.4 A			4cyl.	4000cc		Diesel		FM4154
1000.4 A1			4cyl.	4000cc		Diesel Turbo Intercooled		FM4155
08-523200-00	STD	105.00		3.000		001 IF CR P		IKA
[R47680]				2.500		005 P		GOE12
				4.000		231 CR P		GOE12

2

1052			2cyl.	2078cc		Diesel		FM4148
1053			3cyl.	3117cc		Diesel		FM4121
1054			4cyl.	4155cc		Diesel		FM4149
1054 P			4cyl.	4156cc		Diesel		FM9146
1055			5cyl.	5195cc		Diesel		FM9150
1055 P			5cyl.	5195cc		Diesel		FM4124
1056 P			6cyl.	6234cc		Diesel		FM4125
1056/L			6cyl.	6234cc		Diesel		FM9147
08-523300-00	STD	105.00		2.500		001 IF CR P		GOE12
08-523307-00	0.50mm			2.500		005 P		GOE12
[R47650]				2.500		026 P		GOE12
				5.000		231 CR P		GOE12

ENGINE INDEX

Motorverzeichnis • Index de moteur • Índice de Motor
Indeks silnika • Модель двигателя • دليل المحرك



CCM

x



9

15.5W37 W31 (Air Compressor), 15W37 WB15 (Air Compressor)	Petrol		2	75.00	1
D 5	Diesel	5191	4	115.00	2
D 8	Diesel	7800	6	115.00	3
D 11 LB18	Diesel	11020	6	127.00	7
D 11 R 23	Diesel	11022	6	127.00	8
D/DS 14	Diesel	14181	V8	127.00	7
DC 9.01 Euro 3	Diesel	9000	6	115.00	4
DC 9.02 Euro 3	Diesel	9000	6	115.00	4
DC 9.03 Euro 3	Diesel	9000	6	115.00	4
DC 9.04 Euro 3	Diesel	9000	6	115.00	4
DC 9.05 Euro 3	Diesel	9000	6	115.00	4
DC 9.06	Diesel	9000	6	115.00	4
DC 9.20 Euro 3	Diesel	8867	5	127.00	10
DC 11.01 Euro 3	Diesel	10600	6	127.00	9
DC 11.02 Euro 3	Diesel	10600	6	127.00	9
DC 11.03 Euro 3	Diesel	10600	6	127.00	9
DC 11.04 Euro 3	Diesel	10600	6	127.00	9
DC 11.07 Euro 2	Diesel	10600	6	127.00	9
DC 11.08 Euro 3	Diesel	10600	6	127.00	9
DC 11.09 Euro 3	Diesel	10600	6	127.00	9
DC 12.01 Euro 3	Diesel	11700	6	127.00	9
DC 12.02 Euro 2	Diesel	11700	6	127.00	9
DC 12.03 Euro 3	Diesel	11700	6	127.00	9
DC 12.09 Euro 3	Diesel	11700	6	127.00	9
DC 12.14 Euro 3	Diesel	11716	6	127.00	10
DC 16.01 Euro 3	Diesel	15600	V8	127.00	9
DC 16.02 Euro 3	Diesel	15600	V8	127.00	9
DC 16.04 Euro 3	Diesel	15600	V8	127.00	10
DN 8.01	Diesel	7800	6	115.00	5
DN 9.01	Diesel	8500	6	115.00	5
DN 11.01	Diesel	11020	6	127.00	8
DN 11.01 B10	Diesel	11000	6	127.00	8
DN 11.01 C 09	Diesel	11020	6	127.00	8
DN 11.04 B10	Diesel	11000	6	127.00	8
DN 11.04 C 01	Diesel	11000	6	127.00	8
DN 11.06	Diesel	11020	6	127.00	8
DN 11.06 C	Diesel	11020	6	127.00	8
DN 11.07	Diesel	11022	6	127.00	8
DN 11.08	Diesel	11022	6	127.00	8
DN 11.08 B01	Diesel	11020	6	127.00	8
DS 5	Diesel	5191	4	115.00	2
DS 8	Diesel	7800	6	115.00	3
DS 8 LB03	Diesel	7800	6	115.00	5
DS 8 LB04	Diesel	7800	6	115.00	5
DS 8 LB09-LB14	Diesel	7800	6	115.00	5
DS 8.01	Diesel	7800	6	115.00	5
DS 8.05	Diesel	7800	6	115.00	5
DS 8.06	Diesel	7800	6	115.00	5
DS 9.01	Diesel	8475	6	115.00	6
DS 9.02	Diesel	8475	6	115.00	6
DS 9.05	Diesel	8475	6	115.00	6
DS 9.06	Diesel	8475	6	115.00	6
DS 9.08	Diesel	8475	6	115.00	6
DS 11	Diesel	11022	6	127.00	11
DS 11 / D11	Diesel	11022	6	127.00	12
DS 11 Agr/Ind 1978>	Diesel	11022	6	127.00	13
DS 11 LB21 / LB23 / LB24 / LB26	Diesel	11020	6	127.00	7
DS 11.01	Diesel	11022	6	127.00	8
DS 11.01 B 06	Diesel	11022	6	127.00	8
DS 11.02	Diesel	11022	6	127.00	8



CCM

x



9

DS 11.14	Diesel	11022	6	127.00	8
DS 11.15	Diesel	11022	6	127.00	8
DS 11.15 B	Diesel	11022	6	127.00	8
DS 11.18	Diesel	11022	6	127.00	8
DS 11.22	Diesel	11022	6	127.00	11
DS 11.23	Diesel	11022	6	127.00	11
DS 11.34	Diesel	11020	6	127.00	11
DS 11.71	Diesel	11020	6	127.00	11
DS 11.71 C	Diesel	11020	6	127.00	11
DS 11.72	Diesel	11022	6	127.00	11
DS 11.73	Diesel	11020	6	127.00	11
DS 11.74	Diesel	11020	6	127.00	11
DS 11.75	Diesel	11020	6	127.00	11
DS 11.78	Diesel	11020	6	127.00	9
DS 14	Diesel	14181	V8	127.00	14
DS 14 LB 05	Diesel	14200	V8	127.00	14
DS 14 LB 08	Diesel	14200	V8	127.00	14
DS 14.01	Diesel	14190	V8	127.00	14
DS 14.01 L 01	Diesel	14200	V8	127.00	14
DS 14.02	Diesel	14190	V8	127.00	14
DS 14.06	Diesel	14190	V8	127.00	14
DS 14.06 L01 / L02 / L03	Diesel	14200	V8	127.00	14
DS 14.07	Diesel	14190	V8	127.00	14
DS 14.07 L01, DS 14.07 L02	Diesel	14200	V8	127.00	14
DS 801 LB14, DS 801 LB15, DS 801 LB16	Diesel	7800	6	115.00	5
DSC 9.01	Diesel	8475	6	115.00	6
DSC 9.02	Diesel	8475	6	115.00	6
DSC 9.07 Euro 1	Diesel	8475	6	115.00	6
DSC 9.08 Euro 1	Diesel	8475	6	115.00	6
DSC 9.09 Euro 2	Diesel	8475	6	115.00	6
DSC 9.10 Euro 1	Diesel	8475	6	115.00	6
DSC 9.11 Euro 2	Diesel	9000	6	115.00	4
DSC 9.12 Euro 2	Diesel	9000	6	115.00	4
DSC 9.13 Euro 2	Diesel	9000	6	115.00	4
DSC 9.15 Euro 2	Diesel	9000	6	115.00	4
DSC 11	Diesel	11020	6	127.00	11
DSC 11.01	Diesel	11020	6	127.00	8
DSC 11.02	Diesel	11022	6	127.00	11
DSC 11.04	Diesel	11020	6	127.00	11
DSC 11.04 C01	Diesel	11020	6	127.00	11
DSC 11.08	Diesel	11020	6	127.00	11
DSC 11.10	Diesel	11020	6	127.00	11
DSC 11.12	Diesel	11020	6	127.00	11
DSC 11.13	Diesel	11020	6	127.00	11
DSC 11.16	Diesel	11020	6	127.00	11
DSC 11.17	Diesel	11020	6	127.00	11
DSC 11.18	Diesel	11020	6	127.00	11
DSC 11.21 Euro 1	Diesel	11020	6	127.00	11
DSC 11.22	Diesel	11020	6	127.00	11
DSC 11.23 Euro 1	Diesel	11020	6	127.00	11
DSC 11.24 Euro 2	Diesel	11020	6	127.00	9
DSC 11.25	Diesel	11020	6	127.00	9
DSC 11.27 C02	Diesel	11020	6	127.00	9
DSC 11.35	Diesel	11020	6	127.00	11
DSC 11.36	Diesel	11020	6	127.00	11
DSC 11.39 Euro 1	Diesel	11020	6	127.00	11
DSC 11.70	Diesel	11020	6	127.00	11
DSC 11.70 N Euro 2, DSC 11.70 S Euro 2	Diesel	11020	6	127.00	11
DSC 11.71	Diesel	11020	6	127.00	11
DSC 11.74 Euro 1	Diesel	11020	6	127.00	11

ENGINE INDEX

Motorverzeichnis • Index de moteur • Índice de Motor
Indeks silnika • Модель двигателя • دليل المحرك



CCM

x



9

DSC 11.75 Euro 1	Diesel	11020	6	127.00	11
DSC 11.79 Euro 2	Diesel	11000	6	127.00	11
DSC 11.81	Diesel	11020	6	127.00	11
DSC 12.01 Euro 2	Diesel	11700	6	127.00	9
DSC 12.02 Euro 2	Diesel	11700	6	127.00	9
DSC 12.03 Euro 2	Diesel	11700	6	127.00	9
DSC 12.05 Euro 3	Diesel	11700	6	127.00	9
DSC 14	Diesel	14181	V8	127.00	15
DSC 14.01	Diesel	14190	V8	127.00	14
DSC 14.02	Diesel	14190	V8	127.00	14
DSC 14.03	Diesel	14190	V8	127.00	11
DSC 14.04	Diesel	14190	V8	127.00	11
DSC 14.05	Diesel	14190	V8	127.00	11
DSC 14.06	Diesel	14190	V8	127.00	11
DSC 14.07 L 01	Diesel	14200	V8	127.00	14
DSC 14.08 Euro 1	Diesel	14190	V8	127.00	11
DSC 14.09 Euro 1	Diesel	14190	V8	127.00	11
DSC 14.10 Euro 1	Diesel	14190	V8	127.00	11
DSC 14.13 Euro 2	Diesel	14200	V8	127.00	9
DSC 14.16 Euro 1	Diesel	14190	V8	127.00	11
DSC 16.02 Euro 3	Diesel	15600	V8	127.00	9
DSI 8.01	Diesel	7800	6	115.00	5
DSI 8.01 L01, DSI 8.01 L04	Diesel	7800	6	115.00	5
DSI 11.01	Diesel	11020	6	127.00	8
DSI 12.40	Diesel	11700	6	127.00	9
DSI 14.47	Diesel	14181	V8	127.00	11
DSI 14.50	Diesel	14181	V8	127.00	11
DSI 14.60	Diesel	14181	V8	127.00	11
DSI 14.61	Diesel	14181	V8	127.00	11
DSI 14.63	Diesel	14181	V8	127.00	11
DT 12.02 Euro 3	Diesel	11716	6	127.00	9
DT 12.03 Euro 4	Diesel	11716	6	127.00	16
DT 12.11 Euro 4	Diesel	11716	6	127.00	16
DT 12.12 Euro 4	Diesel	11716	6	127.00	16
DT 12.17 Euro 4	Diesel	11716	6	127.00	16
DTC 11.01 Euro 1	Diesel	11020	6	127.00	11
DTC 11.02 Euro 2	Diesel	11020	6	127.00	11



1

15.5W37 W31 (Air Compressor),		2cyl.					
15W37 WB15 (Air Compressor)							FM1846
08-990700-00	STD	75.00	2.385		005 P		STD
08-990705-00	0.25mm				026 P		STD
08-990707-00	0.50mm		2.385		032 P		STD
<i>[R32840]</i>			3.947				STD

2

D 5		4cyl.	5191cc	81kW (110PS)	Diesel		TD8832
DS 5		4cyl.	5191cc	96kW (131PS)	Diesel		TD8833
08-343500-10	STD	115.00	3.000		001 CR P		IKA
			3.000		001 IF P		STD
			3.000		023 P		STD
			6.000		231		STD
			6.000		030 P		STD



3

D 8		6cyl.	7800cc	115-120kW (157-163PS)	Diesel		TD8795
DS 8		6cyl.	7800cc	154-160kW (210-218PS)	Diesel Turbo		TD8796
08-343500-10	STD	115.00	3.000		001 CR P		IKA
			3.000		001 IF P		STD
			3.000		023 P		STD
			6.000		231		STD
			6.000		030 P		STD
08-961000-00	STD		115.00	2.385		001 MOL P	
		2.385			005 P		STD
<i>[R43750]</i>		4.747			231 CR P		STD





4

DC 9.01 Euro 3	6cyl.	9000cc	169kW (230PS)	Diesel	Turbo Intercooled	TD15408
DC 9.02 Euro 3	6cyl.	9000cc	191kW (260PS)	Diesel	Turbo Intercooled	TD15411
DC 9.03 Euro 3	6cyl.	9000cc	221kW (300PS)	Diesel	Turbo Intercooled	TD15413
DC 9.04 Euro 3	6cyl.	9000cc	169kW (230PS)	Diesel	Turbo Intercooled	TD15410
DC 9.05 Euro 3	6cyl.	9000cc	191kW (260PS)	Diesel	Turbo Intercooled	TD15412
DC 9.06	6cyl.	9000cc	221kW (300PS)	Diesel	Turbo Intercooled	TD15414
DSC 9.11 Euro 2	6cyl.	9000cc	162kW (220PS)	Diesel	Turbo Intercooled	TD8854
DSC 9.12 Euro 2	6cyl.	9000cc	191kW (260PS)	Diesel	Turbo Intercooled	TD8855
DSC 9.13 Euro 2	6cyl.	9000cc	228kW (310PS)	Diesel	Turbo Intercooled	TD8853
DSC 9.15 Euro 2	6cyl.	9000cc	228kW (310PS)	Diesel	Turbo Intercooled	TD12608

08-109200-00	STD	115.00	3.160		008 IW CK P	KV1
[R60490]			2.385		005 P	STD
			3.500		231 CR P	STD

5



DN 8.01	6cyl.	7800cc	123kW (167PS)	Diesel		TD8838
DN 9.01	6cyl.	8500cc	150kW (204PS)	Diesel	Turbo	TD8843
DS 8 LB03	6cyl.	7800cc	155kW (211PS)	Diesel	Turbo	FM5206
DS 8 LB04	6cyl.	7800cc	155kW (211PS)	Diesel	Turbo	FM5305
DS 8 LB09-LB14	6cyl.	7800cc	140-148kW (190-202PS)	Diesel	Turbo	FM3818
DS 8.01	6cyl.	7800cc	154-170kW (209-231PS)	Diesel	Turbo	TD8842
DS 8.05	6cyl.	7800cc	155kW (211PS)	Diesel	Turbo	TD8839
DS 8.06	6cyl.	7800cc	140kW (190PS)	Diesel	Turbo	TD8840
DS 801 LB14, DS 801 LB15, DS 801 LB16	6cyl.	7800cc	120kW (163PS)	Diesel	Turbo	FM5017
DSI 8.01	6cyl.	7800cc	178kW (242PS)	Diesel	Turbo Intercooled	TD8841
DSI 8.01 L01, DSI 8.01 L04	6cyl.	7800cc	170kW (231PS)	Diesel	Turbo Intercooled	FM5023

08-961000-00	STD	115.00	2.385		001 MOL P	IKA
[R43750]			2.385		005 P	STD
			4.747		231 CR P	STD







6

DS 9.01	6cyl.	8475cc	180-185kW (245-252PS)	Diesel	Turbo	TD8844
DS 9.02	6cyl.	8475cc	162-180kW (220-245PS)	Diesel	Turbo	TD8845
DS 9.05	6cyl.	8475cc	167-187kW (220-246PS)	Diesel	Turbo	TD8846
DS 9.06	6cyl.	8475cc	167kW (227PS)	Diesel	Turbo	TD8847
DS 9.08	6cyl.	8475cc	150kW (204PS)	Diesel	Turbo	TD8850
DSC 9.01	6cyl.	8475cc	202kW (275PS)	Diesel	Turbo Intercooled	TD8848
DSC 9.02	6cyl.	8475cc	207kW (282PS)	Diesel	Turbo Intercooled	TD8849
DSC 9.07 Euro 1	6cyl.	8475cc	185kW (252PS)	Diesel	Turbo Intercooled	TD8851
DSC 9.08 Euro 1	6cyl.	8475cc	208kW (283PS)	Diesel	Turbo Intercooled	TD8810
DSC 9.09 Euro 2	6cyl.	8475cc	184kW (250PS)	Diesel	Turbo Intercooled	TD13068
DSC 9.10 Euro 1	6cyl.	8475cc	162kW (220PS)	Diesel	Turbo Intercooled	TD8852

08-960900-00	STD	115.00	3.160		008 IW CR P	KV1
[R43450]			2.385		005 IW P	STD
			4.747		231 CR P	STD

7

D 11 LB18, 20, 22, 24, 26	6cyl.	11020cc	149kW (203PS)	Diesel		FM1584
D/DS 14	V8cyl.	14181cc	202kW (275PS)	Diesel		TD8804
DS 11 LB21 / LB23 / LB24 / LB26	6cyl.	11020cc	203-245kW (276-333PS)	Diesel	Turbo	FM5092

08-348000-10	STD	127.00	2.385		001 IW MOL P	KV1
[R34330]			2.385		001 IF P	STD
			2.385		023 P	STD
			4.747		231 CR P	STD



8

D 11 R 23	6cyl.	11022cc	143kW (195PS)	Diesel		TD8805
DN 11.01	6cyl.	11020cc	149-153kW (203-208PS)	Diesel		TD8806
DN 11.01 B10	6cyl.	11000cc	155kW (211PS)	Diesel		TD5872
DN 11.01 C 09	6cyl.	11020cc	158kW (215PS)	Diesel		TD8836
DN 11.04 B10	6cyl.	11000cc	155kW (211PS)	Diesel		TD6220
DN 11.04 C 01	6cyl.	11000cc	158kW (215PS)	Diesel		TD8837
DN 11.06	6cyl.	11020cc	134kW (182PS)	Diesel		TD8875
DN 11.06 C	6cyl.	11020cc	143-149kW (194-203PS)	Diesel		TD8817
DN 11.07	6cyl.	11022cc	139kW (188PS)	Diesel		TD8808
DN 11.08	6cyl.	11022cc	150kW (204PS)	Diesel		TD8886
DN 11.08 B01	6cyl.	11020cc	149kW (203PS)	Diesel		TD8889
DS 11.01	6cyl.	11022cc	184-202kW (250-275PS)	Diesel	Turbo	TD5874
DS 11.01 B 06	6cyl.	11022cc	184-213kW (250-290PS)	Diesel	Turbo	TD8799
DS 11.02	6cyl.	11022cc	206-245kW (280-333PS)	Diesel	Turbo Intercooled	TD8864
DS 11.14	6cyl.	11022cc	206-245kW (280-333PS)	Diesel	Turbo Intercooled	TD6222
DS 11.15	6cyl.	11022cc	224-245kW (305-333PS)	Diesel	Turbo Intercooled	TD8803
DS 11.15 B	6cyl.	11022cc	224kW (305PS)	Diesel	Turbo Intercooled	TD8801
DS 11.18	6cyl.	11022cc	254kW (345PS)	Diesel	Turbo Intercooled	TD8857
DSC 11.01	6cyl.	11020cc	230kW (313PS)	Diesel	Turbo Intercooled	TD8811
DSI 11.01	6cyl.	11020cc	191kW (260PS)	Diesel	Turbo	TD8874

08-121100-00	STD	127.00	2.385		001 MOL	IKA
			2.385		005 IW	STD
			4.747		231 CR	STD
08-961900-00	STD	127.00	2.385		001 CR P	IKA
			2.385		005 IW P	STD
			4.747		231 CR P	STD
08-990500-00	STD	127.00	2.385		001 MOL P	IKA
			2.385		005 IW P	STD
			4.747		231 CR P	STD

[R34160V1]





9

DC 11.01 Euro 3	6cyl.	10600cc	250kW (340PS)	Diesel	Turbo Intercooled	TD12769
DC 11.02 Euro 3	6cyl.	10600cc	280kW (381PS)	Diesel	Turbo Intercooled	TD12772
DC 11.03 Euro 3	6cyl.	10600cc	250kW (340PS)	Diesel	Turbo Intercooled	TD15415
DC 11.04 Euro 3	6cyl.	10600cc	280kW (381PS)	Diesel	Turbo Intercooled	TD15416
DC 11.07 Euro 2	6cyl.	10600cc	237kW (322PS)	Diesel	Turbo Intercooled	TD21005
DC 11.08 Euro 3	6cyl.	10600cc	250kW (340PS)	Diesel	Turbo Intercooled	TD17451
DC 11.09 Euro 3	6cyl.	10600cc	279kW (380PS)	Diesel	Turbo Intercooled	TD17452
DC 12.01 Euro 3	6cyl.	11700cc	309kW (420PS)	Diesel	Turbo Intercooled	TD15418
DC 12.02 Euro 2	6cyl.	11700cc	265kW (360PS)	Diesel	Turbo Intercooled	TD21080
DC 12.03 Euro 3	6cyl.	11700cc	308kW (420PS)	Diesel	Turbo Intercooled	TD16852
DC 12.09 Euro 3	6cyl.	11700cc	309kW (420PS)	Diesel	Turbo Intercooled	TD22367
DC 16.01 Euro 3	V8cyl.	15600cc	426kW (580PS)	Diesel	Turbo Intercooled	TD15429
DC 16.02 Euro 3	V8cyl.	15600cc	353kW (480PS)	Diesel	Turbo Intercooled	TD15428
DS 11.78	6cyl.	11020cc	200kW (272PS)	Diesel	Turbo Intercooled	TD8822
DSC 11.24 Euro 2	6cyl.	11020cc	191kW (260PS)	Diesel	Turbo Intercooled	TD8870
DSC 11.25	6cyl.	11020cc	200kW (272PS)	Diesel	Turbo Intercooled	FM15083
DSC 11.27 C02	6cyl.	11020cc	180-200kW (245-272PS)	Diesel	Turbo Intercooled	TD8871
DSC 12.01 Euro 2	6cyl.	11700cc	294kW (400PS)	Diesel	Turbo Intercooled	TD8892
DSC 12.02 Euro 2	6cyl.	11700cc	265kW (360PS)	Diesel	Turbo Intercooled	TD8893
DSC 12.03 Euro 2	6cyl.	11700cc	265-325kW (360-442PS)	Diesel	Turbo Intercooled	TD22371
DSC 12.05 Euro 3	6cyl.	11700cc	309kW (420PS)	Diesel	Turbo Intercooled	TD12870
DSC 14.13 Euro 2	V8cyl.	14200cc	390kW (530PS)	Diesel	Turbo Intercooled	TD8911
DSC 16.02 Euro 3	V8cyl.	15600cc	353-426kW (480-579PS)	Diesel	Turbo Intercooled	FM3692
DSI 12.40	6cyl.	11700cc	269-313kW (366-426PS)	Diesel	Turbo Intercooled	FM33880
DT 12.02 Euro 3	6cyl.	11716cc	345kW (470PS)	Diesel	Turbo Intercooled	TD16495

08-112100-00	STD	127.00	3.500		008 IW MOL P	KV1
			2.385		005 IW P	STD
			3.500		231 CR P	STD
08-143600-00	STD	127.00	3.500		008 IW CR P	KV1
			2.385		005 IW P	STD
			3.500		231 CR P	STD
08-143600-10	STD	127.00	3.500		008 IW CK P	KV1
			2.385		005 IW P	GOE13
			3.500		231 CR	STD

10

DC 12.14 Euro 3		6cyl.	11716cc	309kW (420PS)	Diesel	Turbo Intercooled	TD17453
DC 16.04 Euro 3		V8cyl.	15600cc	368kW (500PS)	Diesel	Turbo Intercooled	TD17457
DC 9.20 Euro 3		5cyl.	8867cc	198-199kW (269-271PS)	Diesel	Turbo Intercooled	TD21006
08-143600-10	STD		127.00	3.500		008 IW CK P	KV1
				2.385		005 IW P	GOE13
				3.500		231 CR	STD

11

DS 11		6cyl.	11022cc	184-202kW (250-275PS)	Diesel	Turbo	TD8798
DS 11.22		6cyl.	11022cc	280kW (381PS)	Diesel	Turbo	TD7436
DS 11.23		6cyl.	11022cc	266kW (362PS)	Diesel	Turbo	TD7180
DS 11.34		6cyl.	11020cc	228kW (310PS)	Diesel	Turbo	TD8869
DS 11.71		6cyl.	11020cc	189kW (256PS)	Diesel	Turbo	TD8873
DS 11.71 C		6cyl.	11020cc	189kW (256PS)	Diesel	Turbo	TD5878
DS 11.72		6cyl.	11022cc	230kW (313PS)	Diesel	Turbo	TD8858
DS 11.73		6cyl.	11020cc	228-230kW (310-313PS)	Diesel	Turbo	TD8859
DS 11.74		6cyl.	11020cc	194kW (264PS)	Diesel	Turbo	TD8820
DS 11.75		6cyl.	11020cc	228-230kW (310-313PS)	Diesel	Turbo	TD8821
DSC 11		6cyl.	11020cc	220kW (299PS)	Diesel	Turbo Intercooled	FM15084
DSC 11.02		6cyl.	11022cc	267kW (363PS)	Diesel	Turbo Intercooled	TD8860
DSC 11.04		6cyl.	11020cc	189-245kW (257-333PS)	Diesel	Turbo Intercooled	TD8868
DSC 11.04 C01		6cyl.	11020cc	189-245kW (257-333PS)	Diesel	Turbo Intercooled	FM5036
DSC 11.08		6cyl.	11020cc	228kW (310PS)	Diesel	Turbo Intercooled	TD8823
DSC 11.10		6cyl.	11020cc	280kW (381PS)	Diesel	Turbo Intercooled	TD8877
DSC 11.12		6cyl.	11020cc	227-260kW (310-354PS)	Diesel	Turbo Intercooled	TD8861
DSC 11.13		6cyl.	11020cc	267kW (363PS)	Diesel	Turbo Intercooled	TD8878
DSC 11.16		6cyl.	11020cc	239kW (325PS)	Diesel	Turbo Intercooled	TD8879
DSC 11.17		6cyl.	11020cc	237kW (322PS)	Diesel	Turbo Intercooled	TD8880
DSC 11.18		6cyl.	11020cc	267kW (363PS)	Diesel	Turbo Intercooled	TD8826
DSC 11.21 Euro 1		6cyl.	11020cc	235-266kW (320-362PS)	Diesel	Turbo Intercooled	TD8812
DSC 11.22		6cyl.	11020cc	280kW (381PS)	Diesel	Turbo Intercooled	TD8813
DSC 11.23 Euro 1		6cyl.	11020cc	266kW (362PS)	Diesel	Turbo Intercooled	TD8814
DSC 11.35		6cyl.	11020cc	235-266kW (320-362PS)	Diesel	Turbo Intercooled	TD8815
DSC 11.36		6cyl.	11020cc	235-266kW (320-362PS)	Diesel	Turbo Intercooled	TD8816
DSC 11.39 Euro 1		6cyl.	11020cc	258kW (351PS)	Diesel	Turbo Intercooled	TD8882
DSC 11.70		6cyl.	11020cc	280kW (381PS)	Diesel	Turbo Intercooled	TD8884
DSC 11.70 N Euro 2, DSC 11.70 S Euro 2		6cyl.	11020cc	280kW (381PS)	Diesel	Turbo Intercooled	FM35084
DSC 11.71		6cyl.	11020cc	235-266kW (320-362PS)	Diesel	Turbo Intercooled	TD8872
DSC 11.74 Euro 1		6cyl.	11020cc	235-266kW (320-362PS)	Diesel	Turbo Intercooled	TD22369
DSC 11.75 Euro 1		6cyl.	11020cc	235-266kW (320-362PS)	Diesel	Turbo Intercooled	TD22370
DSC 11.79 Euro 2		6cyl.	11000cc	250kW (340PS)	Diesel	Turbo Intercooled	TD12768
DSC 11.81		6cyl.	11020cc	305kW (415PS)	Diesel	Turbo Intercooled	TD17286
DSC 14.03		V8cyl.	14190cc	320-346kW (435-470PS)	Diesel	Turbo Intercooled	TD8906





DSC 14.04	V8cyl.	14190cc	346kW (471PS)	Diesel	Turbo Intercooled	TD8907
DSC 14.05	V8cyl.	14190cc	290kW (394PS)	Diesel	Turbo Intercooled	TD8900
DSC 14.06	V8cyl.	14190cc	309kW (420PS)	Diesel	Turbo Intercooled	TD8901
DSC 14.08 Euro 1	V8cyl.	14190cc	309-331kW (420-450PS)	Diesel	Turbo Intercooled	TD8908
DSC 14.09 Euro 1	V8cyl.	14190cc	368kW (500PS)	Diesel	Turbo Intercooled	TD8909
DSC 14.10 Euro 1	V8cyl.	14190cc	333-346kW (453-471PS)	Diesel	Turbo Intercooled	TD8910
DSC 14.16 Euro 1	V8cyl.	14190cc	368kW (500PS)	Diesel	Turbo Intercooled	TD8912
DSI 14.47	V8cyl.	14181cc	341kW (464PS)	Diesel	Turbo Intercooled	TD19149
DSI 14.50	V8cyl.	14181cc	341kW (464PS)	Diesel	Turbo Intercooled	TD19150
DSI 14.60	V8cyl.	14181cc	341kW (464PS)	Diesel	Turbo Intercooled	TD19151
DSI 14.61	V8cyl.	14181cc	341kW (464PS)	Diesel	Turbo Intercooled	TD19152
DSI 14.63	V8cyl.	14181cc	341kW (464PS)	Diesel	Turbo Intercooled	TD19153
DTC 11.01 Euro 1	6cyl.	11020cc	295kW (401PS)	Diesel	Turbo Intercooled	TD8883
DTC 11.02 Euro 2	6cyl.	11020cc	295kW (401PS)	Diesel	Turbo Intercooled	TD8885

08-121200-00	STD	127.00	3.500		008 IW CR	KV1
			2.385		005 IW	STD
			4.747		231 CR	STD
08-962000-00	STD	127.00	3.500		008 IW CR P	KV1
			2.385		005 IW P	STD
			4.747		231 CR P	STD

12

DS 11 / D11	6cyl.	11022cc	140-149kW (190-203PS)	Diesel	TD8794	
08-347100-10 01/1962→08/1973	STD	127.00	2.385		001 IW MOL P	KV1
			2.385		001 IF P	STD
			2.385		023 P	STD
			6.335		231 CR P	STD
08-348000-10 09/1973→	STD	127.00	2.385		001 IW MOL P	KV1
			2.385		001 IF P	STD
			2.385		023 P	STD
			4.747		231 CR P	STD



13

DS 11 Agr/Ind 1978>		6cyl.	11022cc	184-202kW (250-275PS)	Diesel	Turbo	FM5198
08-526900-00	STD	127.00	3.175		008 IW		KV1
[R45020]	2.381			005 IW		STD	
	2.381			005 IW		STD	
	4.762			231		STD	

14

DS 14		V8cyl.	14181cc	257kW (350PS)	Diesel	Turbo	TD8835
DS 14 LB 05		V8cyl.	14200cc	257kW (350PS)	Diesel	Turbo	TD8894
DS 14 LB 08		V8cyl.	14200cc	276kW (375PS)	Diesel	Turbo	TD8895
DS 14.01		V8cyl.	14190cc	283-293kW (385-398PS)	Diesel	Turbo	TD8902
DS 14.01 L 01		V8cyl.	14200cc	276kW (375PS)	Diesel	Turbo	TD8903
DS 14.02		V8cyl.	14190cc	309-320kW (420-435PS)	Diesel	Turbo	TD22368
DS 14.06		V8cyl.	14190cc	285-291kW (388-396PS)	Diesel	Turbo	TD8896
DS 14.06 L01 / L02 / L03		V8cyl.	14200cc	276-291kW (375-396PS)	Diesel	Turbo	TD8904
DS 14.07		V8cyl.	14190cc	293kW (398PS)	Diesel	Turbo	TD8897
DS 14.07 L01, DS 14.07 L02		V8cyl.	14200cc	276kW (375PS)	Diesel	Turbo	FM5086
DSC 14.01		V8cyl.	14190cc	309kW (420PS)	Diesel	Turbo Intercooled	TD8898
DSC 14.02		V8cyl.	14190cc	301kW (409PS)	Diesel	Turbo Intercooled	TD8899
DSC 14.07 L 01		V8cyl.	14200cc	298kW (405PS)	Diesel	Turbo Intercooled	TD8905
08-960800-00	STD	127.00	3.160		008 IW CR P		KV1
[R43470]	2.385			005 IW P		STD	
	4.747			231 CR P		STD	

15

DSC 14 Industrial		V8cyl.	14181cc		Diesel	Turbo Intercooled	FM3866
08-962100-00	STD	127.00	3.500		008 IW MO P		KV1
			2.385		005 IW P		STD
			4.747		231 CR P		STD

☐ Industrial applications only
☐ Nür zum Einbau in Industriemotoren
☐ Application industrie seulement
☐ Aplicaciones industry solamente

16

DT 12.03 Euro 4		6cyl.	11716cc	345kW (470PS)	Diesel	Turbo Intercooled	TD18648
DT 12.11 Euro 4		6cyl.	11716cc	309kW (420PS)	Diesel	Turbo Intercooled	TD17454
DT 12.12 Euro 4		6cyl.	11716cc	309kW (420PS)	Diesel	Turbo Intercooled	TD18646
DT 12.17 Euro 4		6cyl.	11716cc	353kW (480PS)	Diesel	Turbo Intercooled	TD20878
08-437600-00	STD	127.00	3.500		008 IW CK		KV1
			2.385		005 IW CR		F12/F14
			3.500		231 CK		GOE13



CCM

x



9

04/72→12/82	127 0.9	A112 A5.000	Petrol	903	4	1
03/82→01/85	131 1.6	132 BB OA O	Petrol	1592	4	18
06/78→12/85	131 2.0	131 C4.000	Petrol	1756	4	32
06/78→12/85	131 2.0	131 C4.000	Petrol	1995	4	32
06/78→12/86	131 2.4 Diesel	8144.61	Diesel	2445	4	34
	131 E 1600	132A/B./A9.000-828	Petrol	1592	4	18
05/79→12/82	132 2.2 D	OM 615.912	Diesel	2197	4	33
06/10→	Alhambra 1.4 TSI	CAVA	Petrol	1390	4	12
06/10→	Alhambra 1.4 TSI	CNWB	Petrol	1390	4	12
06/10→	Alhambra 1.4 TSI	CTHA	Petrol	1390	4	12
10/97→03/10	Alhambra 1.8 T 20V	AJH	Petrol	1781	4	22
10/97→03/10	Alhambra 1.8 T 20V	AWC	Petrol	1781	4	22
04/96→03/10	Alhambra 1.9 TDI	1Z	Diesel	1896	4	15
08/96→06/00	Alhambra 1.9 TDI	AFN	Diesel	1896	4	15
04/96→03/10	Alhambra 1.9 TDI	AHU	Diesel	1896	4	15
04/96→03/10	Alhambra 1.9 TDI	ANU	Diesel	1896	4	15
05/05→05/07	Alhambra 1.9 TDI	ARL	Diesel	1896	4	15
11/02→11/08	Alhambra 1.9 TDI	ASZ	Diesel	1896	4	15
06/00→03/10	Alhambra 1.9 TDI	AUY	Diesel	1896	4	15
08/96→06/00	Alhambra 1.9 TDI	AVG	Diesel	1896	4	15
05/05→05/07	Alhambra 1.9 TDI	BTB	Diesel	1896	4	16
06/00→03/10	Alhambra 1.9 TDI	BVK	Diesel	1896	4	16
06/00→03/10	Alhambra 1.9 TDI 4motion	AUY	Diesel	1896	4	15
06/00→03/10	Alhambra 1.9 TDI 4motion	BVK	Diesel	1896	4	16
06/05→11/08	Alhambra 1.9 Tdi 4x4	ASZ	Diesel	1896	4	15
04/96→03/10	Alhambra 2.0 i	ADY	Petrol	1984	4	28
04/96→03/10	Alhambra 2.0 i	ATM	Petrol	1984	4	28
11/05→03/10	Alhambra 2.0 TDI	BRT	Diesel	1968	4	26
06/10→05/11	Alhambra 2.0 TDI	CFFA	Diesel	1968	4	27
06/10→	Alhambra 2.0 TDI	CFFB	Diesel	1968	4	27
05/11→	Alhambra 2.0 TDI	CFFE	Diesel	1968	4	27
06/10→	Alhambra 2.0 TDI	CFGB	Diesel	1968	4	27
11/12→	Alhambra 2.0 TDI	CFGC	Diesel	1968	4	27
05/11→	Alhambra 2.0 TDI All-wheel Drive	CFFB	Diesel	1968	4	27
06/00→03/10	Alhambra 2.8 V6	AUE	Petrol	2792	V6	23
06/00→03/10	Alhambra 2.8 V6	AYL	Petrol	2792	V6	23
06/00→03/10	Alhambra 2.8 V6 4motion	AUE	Petrol	2792	V6	23
06/00→03/10	Alhambra 2.8 V6 4motion	AYL	Petrol	2792	V6	23
05/06→	Altea 1.4 16V	BXW	Petrol	1390	4	11
05/06→	Altea 1.4 16V	CGGB	Petrol	1390	4	11
11/07→	Altea 1.4 TSI	CAXC	Petrol	1390	4	13
03/04→	Altea 1.6	BGU	Petrol	1595	4	24
03/04→	Altea 1.6	BSE	Petrol	1595	4	24
03/04→	Altea 1.6	BSF	Petrol	1595	4	24
03/04→	Altea 1.6	CCSA	Petrol	1595	4	24
11/10→	Altea 1.6 TDI	CAYB	Diesel	1598	4	17
10/09→	Altea 1.6 TDI	CAYC	Diesel	1598	4	17
04/04→	Altea 1.9 TDI	BJB	Diesel	1896	4	16
04/04→	Altea 1.9 TDI	BKC	Diesel	1896	4	16
04/04→	Altea 1.9 TDI	BLS	Diesel	1896	4	16
04/04→	Altea 1.9 TDI	BXE	Diesel	1896	4	16
08/09→	Altea 1.9 TDI	BXF	Diesel	1896	4	16
05/04→03/09	Altea 2.0 FSI	BLR	Petrol	1984	4	29
05/04→03/09	Altea 2.0 FSI	BLY	Petrol	1984	4	29
05/04→03/09	Altea 2.0 FSI	BVY	Petrol	1984	4	29
05/04→03/09	Altea 2.0 FSI	BVZ	Petrol	1984	4	29
03/04→05/09	Altea 2.0 TDI	AZV	Diesel	1968	4	26
11/05→	Altea 2.0 TDI	BMM	Diesel	1968	4	26
03/06→	Altea 2.0 TDI	BMN	Diesel	1968	4	26
03/06→	Altea 2.0 TDI	CEGA	Diesel	1968	4	27

MODEL INDEX

Modelverzeichnis • Index de modele • Índice de Modelo
Indeks modelu • Модель автомобиля • دليل الموديل



CCM

x



9

03/04→	Altea 2.0 TDI 16V	BKD	Diesel	1968	4	26
03/04→	Altea 2.0 TDI 16V	CFHC	Diesel	1968	4	27
04/06→05/09	Altea 2.0 TFSI	BWA	Petrol	1984	4	29
10/06→	Altea XL 1.4 16V	BXW	Petrol	1390	4	11
10/06→	Altea XL 1.4 16V	CGGB	Petrol	1390	4	11
11/07→	Altea XL 1.4 TSI	CAXC	Petrol	1390	4	13
10/06→	Altea XL 1.6	BSE	Petrol	1595	4	24
10/06→	Altea XL 1.6	BSF	Petrol	1595	4	24
10/06→	Altea XL 1.6	CCSA	Petrol	1595	4	24
10/06→	Altea XL 1.6 Multifuel	CCSA	Petrol	1595	4	24
11/10→	Altea XL 1.6 TDI	CAYB	Diesel	1598	4	17
10/09→	Altea XL 1.6 TDI	CAYC	Diesel	1598	4	17
10/06→	Altea XL 1.9 TDI	BKC	Diesel	1896	4	16
10/06→	Altea XL 1.9 TDI	BLS	Diesel	1896	4	16
10/06→	Altea XL 1.9 TDI	BXE	Diesel	1896	4	16
08/09→	Altea XL 1.9 TDI	BXF	Diesel	1896	4	16
10/06→03/09	Altea XL 2.0 FSI	BVY	Petrol	1984	4	29
10/06→03/09	Altea XL 2.0 FSI	BVZ	Petrol	1984	4	29
11/06→03/09	Altea XL 2.0 TDI	AZV	Diesel	1968	4	26
10/06→	Altea XL 2.0 TDI	BMM	Diesel	1968	4	26
06/07→	Altea XL 2.0 TDI	BMN	Diesel	1968	4	26
06/07→	Altea XL 2.0 TDI	CEGA	Diesel	1968	4	27
10/06→	Altea XL 2.0 TDI 16V	BKD	Diesel	1968	4	26
10/06→	Altea XL 2.0 TDI 16V	CFHC	Diesel	1968	4	27
10/10→	Altea XL 2.0 TDI 16V 4x4	CFHC	Diesel	1968	4	27
06/07→	Altea XL 2.0 TDI 4x4	BMM	Diesel	1968	4	26
06/07→	Altea XL 2.0 TDI 4x4	BMN	Diesel	1968	4	26
06/07→	Altea XL 2.0 TDI 4x4	CEGA	Diesel	1968	4	27
06/07→	Altea XL 2.0 TDI 4x4	CFJA	Diesel	1968	4	27
06/07→05/09	Altea XL 2.0 TFSI 4x4	BWA	Petrol	1984	4	29
05/97→06/04	Arosa 1.0	AER	Petrol	999	4	2
05/97→06/04	Arosa 1.0	ALD	Petrol	999	4	2
05/97→06/04	Arosa 1.0	ALL	Petrol	999	4	2
05/97→06/04	Arosa 1.0	ANV	Petrol	999	4	2
05/97→06/04	Arosa 1.0	AUC	Petrol	999	4	2
05/97→06/04	Arosa 1.4	AEX	Petrol	1391	4	8
05/97→06/04	Arosa 1.4	AKK	Petrol	1390	4	9
05/97→06/04	Arosa 1.4	AKV	Petrol	1391	4	8
05/97→06/04	Arosa 1.4	ANW	Petrol	1390	4	9
05/97→06/04	Arosa 1.4	APQ	Petrol	1391	4	8
05/97→06/04	Arosa 1.4	AUD	Petrol	1390	4	9
01/00→06/04	Arosa 1.4 16V	AFK	Petrol	1390	4	9
01/00→06/04	Arosa 1.4 16V	ANM	Petrol	1390	4	9
01/00→06/04	Arosa 1.4 16V	AQQ	Petrol	1390	4	9
01/00→06/04	Arosa 1.4 16V	AUB	Petrol	1390	4	9
01/00→06/04	Arosa 1.4 TDI	AMF	Diesel	1422	3	15
08/97→06/04	Arosa 1.7 SDI	AKU	Diesel	1716	4	15
06/99→10/02	Cordoba 1.0	ALD	Petrol	999	4	2
06/99→10/02	Cordoba 1.0	ANV	Petrol	999	4	2
06/99→10/02	Cordoba 1.0	AUC	Petrol	999	4	2
09/96→06/99	Cordoba 1.0 i	AER	Petrol	999	4	2
10/02→06/06	Cordoba 1.2	AZQ	Petrol	1198	3	8
02/93→08/94	Cordoba 1.3	2G	Petrol	1272	4	5
02/93→08/94	Cordoba 1.3	AAV	Petrol	1272	4	5
06/99→10/02	Cordoba 1.4	AKK	Petrol	1390	4	9
06/99→10/02	Cordoba 1.4	ANW	Petrol	1390	4	9
12/97→04/99	Cordoba 1.4	ANX	Petrol	1390	4	8
06/99→10/02	Cordoba 1.4	AUD	Petrol	1390	4	9
02/00→10/02	Cordoba 1.4 16V	ANM	Petrol	1390	4	9
05/00→10/02	Cordoba 1.4 16V	APE	Petrol	1390	4	9



CCM

x



02/00→10/02	Cordoba 1.4 16V	AQQ	Petrol	1390	4	9
05/00→10/02	Cordoba 1.4 16V	AUA	Petrol	1390	4	9
02/00→11/09	Cordoba 1.4 16V	AUB	Petrol	1390	4	9
09/02→12/07	Cordoba 1.4 16V	BBY	Petrol	1390	4	9
10/02→11/09	Cordoba 1.4 16V	BBZ	Petrol	1390	4	9
09/02→12/07	Cordoba 1.4 16V	BKY	Petrol	1390	4	11
05/06→11/09	Cordoba 1.4 16V	BXW	Petrol	1390	4	11
06/94→06/99	Cordoba 1.4 i	ABD	Petrol	1390	4	6
06/94→06/99	Cordoba 1.4 i	AEX	Petrol	1391	4	8
06/94→06/99	Cordoba 1.4 i	AKV	Petrol	1391	4	8
06/94→06/99	Cordoba 1.4 i	APQ	Petrol	1391	4	8
09/96→06/99	Cordoba 1.4 i 16V	AFH	Petrol	1390	4	9
10/02→12/05	Cordoba 1.4 TDI	AMF	Diesel	1422	3	15
06/05→11/09	Cordoba 1.4 TDI	BMS	Diesel	1422	3	15
05/05→11/09	Cordoba 1.4 TDI	BNM	Diesel	1422	3	15
06/05→11/09	Cordoba 1.4 TDI	BNV	Diesel	1422	3	15
06/99→10/02	Cordoba 1.6	AEH	Petrol	1595	4	21
06/99→10/02	Cordoba 1.6	AKL	Petrol	1595	4	21
06/99→10/02	Cordoba 1.6	ALM	Petrol	1598	4	8
06/99→10/02	Cordoba 1.6	APF	Petrol	1595	4	21
06/99→10/02	Cordoba 1.6	AUR	Petrol	1595	4	21
05/94→06/99	Cordoba 1.6 i	1F	Petrol	1595	4	19
02/93→06/99	Cordoba 1.6 i	ABU	Petrol	1598	4	7
02/93→06/99	Cordoba 1.6 i	AEE	Petrol	1598	4	8
07/96→10/99	Cordoba 1.6 i	AFT	Petrol	1595	4	21
07/96→10/99	Cordoba 1.6 i	AKL	Petrol	1595	4	21
02/93→06/99	Cordoba 1.6 i	ALM	Petrol	1598	4	8
07/97→06/99	Cordoba 1.7 SDI	AKU	Diesel	1716	4	15
02/93→06/99	Cordoba 1.8 i	ABS	Petrol	1781	4	20
02/93→06/99	Cordoba 1.8 i	ACC	Petrol	1781	4	19
02/93→06/99	Cordoba 1.8 i	ADZ	Petrol	1781	4	20
07/00→10/02	Cordoba 1.8 T 20V Cupra	AQX	Petrol	1781	4	22
07/00→10/02	Cordoba 1.8 T 20V Cupra	AYP	Petrol	1781	4	22
02/93→08/96	Cordoba 1.9 D	1Y	Diesel	1896	4	14
	Cordoba 1.9 D	AEF	Diesel	1896	4	14
08/96→06/99	Cordoba 1.9 SDI	AEY	Diesel	1896	4	15
06/99→10/02	Cordoba 1.9 SDI	AGP	Diesel	1896	4	15
06/99→10/02	Cordoba 1.9 SDI	AQM	Diesel	1896	4	15
09/02→11/09	Cordoba 1.9 SDI	ASY	Diesel	1896	4	15
02/93→08/96	Cordoba 1.9 TD	AAZ	Diesel	1896	4	14
08/96→06/99	Cordoba 1.9 TDI	1Z	Diesel	1896	4	15
03/97→06/99	Cordoba 1.9 TDI	AFN	Diesel	1896	4	15
06/99→10/02	Cordoba 1.9 TDI	AGR	Diesel	1896	4	15
08/96→10/02	Cordoba 1.9 TDI	AHU	Diesel	1896	4	15
06/99→10/02	Cordoba 1.9 TDI	ALH	Diesel	1896	4	15
06/99→10/02	Cordoba 1.9 TDI	ASK	Diesel	1896	4	15
06/99→10/02	Cordoba 1.9 TDI	ASV	Diesel	1896	4	15
10/02→11/09	Cordoba 1.9 TDI	ASZ	Diesel	1896	4	15
09/02→11/09	Cordoba 1.9 TDI	ATD	Diesel	1896	4	15
09/02→11/09	Cordoba 1.9 TDI	AXR	Diesel	1896	4	15
10/02→11/09	Cordoba 1.9 TDI	BLT	Diesel	1896	4	16
09/02→11/09	Cordoba 1.9 TDI	BMT	Diesel	1896	4	16
09/02→11/09	Cordoba 2.0	AZL	Petrol	1984	4	28
09/02→11/09	Cordoba 2.0	BBX	Petrol	1984	4	28
02/93→06/99	Cordoba 2.0 i	2E	Petrol	1984	4	28
02/93→06/99	Cordoba 2.0 i	AGG	Petrol	1984	4	28
08/96→06/99	Cordoba 2.0 i 16V	ABF	Petrol	1984	4	28
06/99→12/02	Cordoba Vario 1.4	AKK	Petrol	1390	4	9
06/99→12/02	Cordoba Vario 1.4	ANW	Petrol	1390	4	9
06/99→12/02	Cordoba Vario 1.4	AUD	Petrol	1390	4	9

MODEL INDEX

Modelverzeichnis • Index de modele • Índice de Modelo
Indeks modelu • Модель автомобиля • دليل الموديل



CCM

x



9

06/99→12/02	Cordoba Vario 1.4 16V	APE	Petrol	1390	4	9
06/99→12/02	Cordoba Vario 1.4 16V	AUA	Petrol	1390	4	9
09/96→06/99	Cordoba Vario 1.4 i	AEX	Petrol	1391	4	8
09/96→06/99	Cordoba Vario 1.4 i	AKV	Petrol	1391	4	8
09/96→06/99	Cordoba Vario 1.4 i	APQ	Petrol	1391	4	8
06/99→12/02	Cordoba Vario 1.6	AEH	Petrol	1595	4	21
06/99→12/02	Cordoba Vario 1.6	AKL	Petrol	1595	4	21
06/99→12/02	Cordoba Vario 1.6	ALM	Petrol	1598	4	8
06/99→12/02	Cordoba Vario 1.6	APF	Petrol	1595	4	21
06/99→12/02	Cordoba Vario 1.6	AUR	Petrol	1595	4	21
05/97→06/99	Cordoba Vario 1.6 i	1F	Petrol	1595	4	19
09/96→06/99	Cordoba Vario 1.6 i	AEE	Petrol	1598	4	8
09/96→06/99	Cordoba Vario 1.6 i	AFT	Petrol	1595	4	21
09/96→06/99	Cordoba Vario 1.6 i	ALM	Petrol	1598	4	8
07/97→06/99	Cordoba Vario 1.7 SDI	AKU	Diesel	1716	4	15
09/96→06/99	Cordoba Vario 1.9 SDI	AEY	Diesel	1896	4	15
06/99→12/02	Cordoba Vario 1.9 SDI	AGP	Diesel	1896	4	15
06/99→12/02	Cordoba Vario 1.9 SDI	AQM	Diesel	1896	4	15
08/96→06/99	Cordoba Vario 1.9 TDI	1Z	Diesel	1896	4	15
07/97→06/99	Cordoba Vario 1.9 TDI	AFN	Diesel	1896	4	15
06/99→12/02	Cordoba Vario 1.9 TDI	AGR	Diesel	1896	4	15
08/96→06/99	Cordoba Vario 1.9 TDI	AHU	Diesel	1896	4	15
06/99→12/02	Cordoba Vario 1.9 TDI	ALH	Diesel	1896	4	15
06/99→12/02	Cordoba Vario 1.9 TDI	ASK	Diesel	1896	4	15
06/99→12/02	Cordoba Vario 1.9 TDI	ASV	Diesel	1896	4	15
03/09→09/10	Exeo 1.6	ALZ	Petrol	1595	4	24
12/08→	Exeo 2.0 TDI	CAGA	Diesel	1968	4	27
12/08→	Exeo 2.0 TDI	CAGC	Diesel	1968	4	27
02/09→	Exeo 2.0 TDI	CAHA	Diesel	1968	4	27
12/08→	Exeo 2.0 TDI	CBDB	Diesel	1968	4	27
02/09→	Exeo 2.0 TDI	CGLB	Diesel	1968	4	27
12/08→	Exeo 2.0 TDI	CJCA	Diesel	1968	4	27
12/08→	Exeo 2.0 TDI	CJCC	Diesel	1968	4	27
06/09→09/10	Exeo ST 1.6	ALZ	Petrol	1595	4	24
05/09→	Exeo ST 2.0 TDI	CAGA	Diesel	1968	4	27
07/09→	Exeo ST 2.0 TDI	CAGC	Diesel	1968	4	27
05/09→	Exeo ST 2.0 TDI	CAHA	Diesel	1968	4	27
05/09→	Exeo ST 2.0 TDI	CBDB	Diesel	1968	4	27
05/09→	Exeo ST 2.0 TDI	CGLB	Diesel	1968	4	27
05/09→	Exeo ST 2.0 TDI	CJCA	Diesel	1968	4	27
07/09→	Exeo ST 2.0 TDI	CJCC	Diesel	1968	4	27
03/84→12/86	Fura 0.9	100 GL.7000	Petrol	903	4	1
01/82→06/86	Fura 0.9	100 GL3	Petrol	903	4	1
03/84→12/86	Fura 0.9	1000 GL.7000	Petrol	903	4	1
08/86→05/93	Ibiza I 0.9	146 A.000	Petrol	903	4	1
11/84→12/93	Ibiza I 1.2	021 A.1000	Petrol	1193	4	3
11/84→05/93	Ibiza I 1.5	021 A.2000	Petrol	1461	4	30
06/84→05/93	Ibiza I 1.7 D	022 A .5000 (138B6.000)	Diesel	1714	4	31
03/93→09/96	Ibiza II 1.0	AAU	Petrol	1043	4	6
09/96→08/99	Ibiza II 1.0 i	AER	Petrol	999	4	2
03/93→08/99	Ibiza II 1.3 i	2G	Petrol	1272	4	5
03/93→08/99	Ibiza II 1.3 i	AAV	Petrol	1272	4	5
12/97→04/99	Ibiza II 1.4	ANX	Petrol	1390	4	8
09/93→08/99	Ibiza II 1.4 i	ABD	Petrol	1390	4	6
09/93→08/99	Ibiza II 1.4 i	AEX	Petrol	1391	4	8
09/93→08/99	Ibiza II 1.4 i	AKV	Petrol	1391	4	8
09/93→08/99	Ibiza II 1.4 i	APQ	Petrol	1391	4	8
06/97→08/99	Ibiza II 1.4 i 16V	AFH	Petrol	1390	4	9
09/94→06/99	Ibiza II 1.6 i	1F	Petrol	1595	4	19
03/93→08/99	Ibiza II 1.6 i	ABU	Petrol	1598	4	7



CCM

x



9

03/93→08/99	Ibiza II 1.6 i	AEE	Petrol	1598	4	8
04/96→08/99	Ibiza II 1.6 i	AFT	Petrol	1595	4	21
03/93→08/99	Ibiza II 1.6 i	ALM	Petrol	1598	4	8
03/93→08/99	Ibiza II 1.8 i	ABS	Petrol	1781	4	20
03/93→08/99	Ibiza II 1.8 i	ACC	Petrol	1781	4	19
03/93→08/99	Ibiza II 1.8 i	ADZ	Petrol	1781	4	20
04/93→08/96	Ibiza II 1.9 D	1Y	Diesel	1896	4	14
	Ibiza II 1.9 D	AEF	Diesel	1896	4	14
08/96→08/99	Ibiza II 1.9 SDI	AEY	Diesel	1896	4	15
03/93→08/96	Ibiza II 1.9 TD	AAZ	Diesel	1896	4	14
08/96→08/99	Ibiza II 1.9 TDI	1Z	Diesel	1896	4	15
02/97→08/99	Ibiza II 1.9 TDI	AFN	Diesel	1896	4	15
08/96→08/99	Ibiza II 1.9 TDI	AHU	Diesel	1896	4	15
03/93→08/99	Ibiza II 2.0 i	2E	Petrol	1984	4	28
03/93→08/99	Ibiza II 2.0 i	AGG	Petrol	1984	4	28
08/96→08/99	Ibiza II 2.0 i 16V	ABF	Petrol	1984	4	28
08/99→02/02	Ibiza III 1.0	ALD	Petrol	999	4	2
08/99→02/02	Ibiza III 1.0	ANV	Petrol	999	4	2
08/99→02/02	Ibiza III 1.0	AUC	Petrol	999	4	2
08/99→02/02	Ibiza III 1.4	AKK	Petrol	1390	4	9
08/99→02/02	Ibiza III 1.4	ANW	Petrol	1390	4	9
08/99→02/02	Ibiza III 1.4	AUD	Petrol	1390	4	9
08/99→02/02	Ibiza III 1.4 16V	ANM	Petrol	1390	4	9
05/00→02/02	Ibiza III 1.4 16V	APE	Petrol	1390	4	9
08/99→02/02	Ibiza III 1.4 16V	AQQ	Petrol	1390	4	9
05/00→02/02	Ibiza III 1.4 16V	AUA	Petrol	1390	4	9
08/99→02/02	Ibiza III 1.4 16V	AUB	Petrol	1390	4	9
08/99→02/02	Ibiza III 1.6	AEH	Petrol	1595	4	21
08/99→02/02	Ibiza III 1.6	AKL	Petrol	1595	4	21
08/99→02/02	Ibiza III 1.6	ALM	Petrol	1598	4	8
08/99→02/02	Ibiza III 1.6	APF	Petrol	1595	4	21
08/99→02/02	Ibiza III 1.6	AUR	Petrol	1595	4	21
07/00→02/02	Ibiza III 1.8 T 20V Cupra	AQX	Petrol	1781	4	22
07/00→02/02	Ibiza III 1.8 T 20V Cupra	AYP	Petrol	1781	4	22
08/99→02/02	Ibiza III 1.9 SDI	AGP	Diesel	1896	4	15
08/99→02/02	Ibiza III 1.9 SDI	AQM	Diesel	1896	4	15
08/99→02/02	Ibiza III 1.9 TDI	AGR	Diesel	1896	4	15
08/99→02/02	Ibiza III 1.9 TDI	ALH	Diesel	1896	4	15
08/99→02/02	Ibiza III 1.9 TDI	ASK	Diesel	1896	4	15
08/99→02/02	Ibiza III 1.9 TDI	ASV	Diesel	1896	4	15
02/02→06/06	Ibiza IV 1.2	AZQ	Petrol	1198	3	8
02/02→11/09	Ibiza IV 1.4 16V	AUB	Petrol	1390	4	9
02/02→12/07	Ibiza IV 1.4 16V	BBY	Petrol	1390	4	9
02/02→11/09	Ibiza IV 1.4 16V	BBZ	Petrol	1390	4	9
02/02→12/07	Ibiza IV 1.4 16V	BKY	Petrol	1390	4	11
05/06→11/09	Ibiza IV 1.4 16V	BXW	Petrol	1390	4	11
05/02→12/05	Ibiza IV 1.4 TDI	AMF	Diesel	1422	3	15
06/05→11/09	Ibiza IV 1.4 TDI	BMS	Diesel	1422	3	15
05/05→11/09	Ibiza IV 1.4 TDI	BNM	Diesel	1422	3	15
06/05→11/09	Ibiza IV 1.4 TDI	BNV	Diesel	1422	3	15
02/02→12/05	Ibiza IV 1.9 SDI	ASY	Diesel	1896	4	15
02/02→11/09	Ibiza IV 1.9 TDI	ASZ	Diesel	1896	4	15
02/02→11/09	Ibiza IV 1.9 TDI	ATD	Diesel	1896	4	15
02/02→11/09	Ibiza IV 1.9 TDI	AXR	Diesel	1896	4	15
02/02→11/09	Ibiza IV 1.9 TDI	BLT	Diesel	1896	4	16
02/02→11/09	Ibiza IV 1.9 TDI	BMT	Diesel	1896	4	16
03/04→02/08	Ibiza IV 1.9 TDI Cupra R	BPX	Diesel	1896	4	16
03/04→02/08	Ibiza IV 1.9 TDI Cupra R	BUK	Diesel	1896	4	16
04/02→11/09	Ibiza IV 2.0	AZL	Petrol	1984	4	28
04/02→11/09	Ibiza IV 2.0	BBX	Petrol	1984	4	28

MODEL INDEX

Modelverzeichnis • Index de modele • Índice de Modelo
Indeks modelu • Модель автомобиля • دليل الموديل



CCM

x



9

05/10→	Ibiza V 1.2 TDI	CFWA	Diesel	1199	3	17
03/08→	Ibiza V 1.4	BXW	Petrol	1390	4	11
03/08→	Ibiza V 1.4	CGGB	Petrol	1390	4	11
07/08→06/10	Ibiza V 1.4 TDI	BMS	Diesel	1422	3	15
06/09→	Ibiza V 1.4 TSI	CAVF	Petrol	1390	4	12
05/10→06/10	Ibiza V 1.6 TDI	CAYA	Diesel	1598	4	17
05/09→	Ibiza V 1.6 TDI	CAYB	Diesel	1598	4	17
05/09→	Ibiza V 1.6 TDI	CAYC	Diesel	1598	4	17
05/09→	Ibiza V 1.6 TDI	CLNA	Diesel	1598	4	17
03/08→06/10	Ibiza V 1.9 TDI	BLS	Diesel	1896	4	16
07/08→06/10	Ibiza V 1.9 TDI	BXJ	Diesel	1896	4	16
01/10→	Ibiza V 2.0 TDI	CFHD	Diesel	1968	4	27
05/10→	Ibiza V Sportcoupe 1.2 TDI	CFWA	Diesel	1199	3	17
07/08→	Ibiza V Sportcoupe 1.4	BXW	Petrol	1390	4	11
07/08→	Ibiza V Sportcoupe 1.4	CGGB	Petrol	1390	4	11
07/08→06/10	Ibiza V Sportcoupe 1.4 TDI	BMS	Diesel	1422	3	15
06/09→	Ibiza V Sportcoupe 1.4 TSI	CAVF	Petrol	1390	4	12
06/09→	Ibiza V Sportcoupe 1.4 TSI Cupra	CAVE	Petrol	1390	4	12
06/09→	Ibiza V Sportcoupe 1.4 TSI Cupra	CTHE	Petrol	1390	4	12
05/10→06/10	Ibiza V Sportcoupe 1.6 TDI	CAYA	Diesel	1598	4	17
05/09→	Ibiza V Sportcoupe 1.6 TDI	CAYB	Diesel	1598	4	17
05/09→	Ibiza V Sportcoupe 1.6 TDI	CAYC	Diesel	1598	4	17
05/09→	Ibiza V Sportcoupe 1.6 TDI	CLNA	Diesel	1598	4	17
07/08→06/10	Ibiza V Sportcoupe 1.9 TDI	BLS	Diesel	1896	4	16
07/08→06/10	Ibiza V Sportcoupe 1.9 TDI	BXJ	Diesel	1896	4	16
01/10→	Ibiza V Sportcoupe 2.0 TDI	CFHD	Diesel	1968	4	27
04/10→	Ibiza V ST 1.2 TDI	CFWA	Diesel	1199	3	17
03/10→	Ibiza V ST 1.4	CGGB	Petrol	1390	4	11
02/12→	Ibiza V ST 1.4 TSI	CAVF	Petrol	1390	4	12
03/10→	Ibiza V ST 1.6 TDI	CAYB	Diesel	1598	4	17
03/10→	Ibiza V ST 1.6 TDI	CAYC	Diesel	1598	4	17
03/10→	Ibiza V ST 1.6 TDI	CLNA	Diesel	1598	4	17
04/00→06/03	Inca 1.4 16V	AUA	Petrol	1390	4	9
11/95→06/03	Inca 1.4 i	AEX	Petrol	1391	4	8
11/95→06/03	Inca 1.4 i	AKV	Petrol	1391	4	8
11/95→06/03	Inca 1.4 i	APQ	Petrol	1391	4	8
11/95→06/03	Inca 1.4 i	AUD	Petrol	1390	4	9
11/95→05/98	Inca 1.6 i	1F	Petrol	1595	4	19
06/97→09/00	Inca 1.6 i	AEE	Petrol	1598	4	8
06/97→09/00	Inca 1.6 i	ALM	Petrol	1598	4	8
09/96→06/03	Inca 1.7 D	AHB	Diesel	1716	4	15
11/95→06/03	Inca 1.9 D	1Y	Diesel	1896	4	14
	Inca 1.9 D	AEF	Diesel	1896	4	14
11/95→06/03	Inca 1.9 SDI	AEY	Diesel	1896	4	15
11/95→06/03	Inca 1.9 SDI	AYQ	Diesel	1896	4	15
09/96→06/03	Inca 1.9 TDI	ALH	Diesel	1896	4	15
11/99→06/06	Leon 1.4 16V	AHW	Petrol	1390	4	9
11/99→06/06	Leon 1.4 16V	APE	Petrol	1390	4	9
11/99→06/06	Leon 1.4 16V	AUA	Petrol	1390	4	9
11/99→06/06	Leon 1.4 16V	AXP	Petrol	1390	4	9
11/99→06/06	Leon 1.4 16V	BCA	Petrol	1390	4	10
06/06→	Leon 1.4 16V	BXW	Petrol	1390	4	11
06/06→	Leon 1.4 16V	CGGB	Petrol	1390	4	11
11/07→	Leon 1.4 TSI	CAXC	Petrol	1390	4	13
11/99→06/06	Leon 1.6	AEH	Petrol	1595	4	21
11/99→06/06	Leon 1.6	AKL	Petrol	1595	4	21
11/99→06/06	Leon 1.6	APF	Petrol	1595	4	21
10/05→06/06	Leon 1.6	BFQ	Petrol	1595	4	24
10/05→06/06	Leon 1.6	BGU	Petrol	1595	4	24
07/05→	Leon 1.6	BSE	Petrol	1595	4	24



CCM

x



07/05→	Leon 1.6	BSF	Petrol	1595	4	24
07/05→	Leon 1.6	CCSA	Petrol	1595	4	24
09/00→06/06	Leon 1.6 16 V	ATN	Petrol	1598	4	9
09/00→06/06	Leon 1.6 16 V	AUS	Petrol	1598	4	9
09/00→06/06	Leon 1.6 16 V	AZD	Petrol	1598	4	9
09/00→06/06	Leon 1.6 16 V	BCB	Petrol	1598	4	9
11/10→	Leon 1.6 TDI	CAYB	Diesel	1598	4	17
02/10→	Leon 1.6 TDI	CAYC	Diesel	1598	4	17
11/99→06/06	Leon 1.8 20V	AGN	Petrol	1781	4	22
11/99→06/06	Leon 1.8 20V	APG	Petrol	1781	4	22
11/99→06/06	Leon 1.8 20V T	APP	Petrol	1781	4	22
11/99→06/06	Leon 1.8 20V T	AUQ	Petrol	1781	4	22
11/99→06/06	Leon 1.8 20V T 4	AJQ	Petrol	1781	4	22
11/99→06/06	Leon 1.8 20V T 4	ARY	Petrol	1781	4	22
02/02→06/06	Leon 1.8 T Cupra R	AMK	Petrol	1781	4	25
07/03→06/06	Leon 1.8 T Cupra R	BAM	Petrol	1781	4	25
11/99→06/06	Leon 1.9 SDI	AQM	Diesel	1896	4	15
11/99→06/06	Leon 1.9 TDI	AGR	Diesel	1896	4	15
11/99→06/06	Leon 1.9 TDI	AHF	Diesel	1896	4	15
11/99→06/06	Leon 1.9 TDI	ALH	Diesel	1896	4	15
02/01→06/06	Leon 1.9 TDI	ARL	Diesel	1896	4	15
11/99→	Leon 1.9 TDI	ASV	Diesel	1896	4	15
05/03→06/06	Leon 1.9 TDI	ASZ	Diesel	1896	4	15
10/05→06/06	Leon 1.9 TDI	AXR	Diesel	1896	4	15
07/05→	Leon 1.9 TDI	BKC	Diesel	1896	4	16
07/05→	Leon 1.9 TDI	BLS	Diesel	1896	4	16
07/05→	Leon 1.9 TDI	BXE	Diesel	1896	4	16
06/07→	Leon 1.9 TDI	BXF	Diesel	1896	4	16
05/02→06/06	Leon 1.9 TDI Syncro	ARL	Diesel	1896	4	15
07/05→05/10	Leon 2.0 FSI	BLR	Petrol	1984	4	29
07/05→05/10	Leon 2.0 FSI	BLY	Petrol	1984	4	29
07/05→05/10	Leon 2.0 FSI	BVY	Petrol	1984	4	29
07/05→05/10	Leon 2.0 FSI	BVZ	Petrol	1984	4	29
07/05→05/10	Leon 2.0 TDI	AZV	Diesel	1968	4	26
10/05→	Leon 2.0 TDI	BMM	Diesel	1968	4	26
05/06→	Leon 2.0 TDI	BMN	Diesel	1968	4	26
05/06→	Leon 2.0 TDI	CEGA	Diesel	1968	4	27
05/06→	Leon 2.0 TDI	CFJA	Diesel	1968	4	27
07/05→	Leon 2.0 TDI 16V	BKD	Diesel	1968	4	26
07/05→	Leon 2.0 TDI 16V	CFHC	Diesel	1968	4	27
07/05→	Leon 2.0 TDI 16V	CLCB	Diesel	1968	4	27
05/05→03/09	Leon 2.0 TFSI	BWA	Petrol	1984	4	29
05/02→06/04	Leon 2.8	BDE	Petrol	2792	V6	23
02/01→06/06	Leon 2.8 Cupra 4	AUE	Petrol	2792	V6	23
11/84→12/93	Malaga 1.2	021 A.1000	Petrol	1193	4	3
05/85→12/93	Malaga 1.5	021 A.2000	Petrol	1461	4	30
10/86→12/93	Malaga 1.5 i CAT	021 A.2000	Petrol	1461	4	30
05/85→12/93	Malaga 1.7 D	022 A .5000 (138B6.000)	Diesel	1714	4	31
08/86→12/93	Marbella 0.8	08 NCA	Petrol	843	4	1
08/86→12/93	Marbella 0.8	100 GL.6000	Petrol	843	4	1
01/87→12/93	Marbella 0.9	100 GL.7000	Petrol	903	4	1
01/87→12/93	Marbella 0.9	1000 GL.7000	Petrol	903	4	1
01/90→11/96	Marbella 0.9 CAT	100 GL.7000	Petrol	903	4	1
01/90→11/96	Marbella 0.9 CAT	1000 GL.7000	Petrol	903	4	1
01/87→12/93	Marbella Box 0.8	08 NCA	Petrol	843	4	1
01/87→12/93	Marbella Box 0.8	100 GL.6000	Petrol	843	4	1
10/80→12/86	Panda 0.9	100 GL3	Petrol	903	4	1
	Pony / Excel Saloon 1.3	AEF	Diesel	1896	4	14
10/79→09/83	Ritmo 1.7 D	022 A .5000 (138B6.000)	Diesel	1714	4	31
08/83→12/86	Ronda 1.2	021 A.1000	Petrol	1193	4	3

MODEL INDEX

Modelverzeichnis • Index de modele • Índice de Modelo
Indeks modelu • Модель автомобиля • دليل الموديل



CCM

x



9

09/84→12/86	Ronda 1.5	021 A.2000	Petrol	1461	4	30
01/82→	Ronda 1.6	132A/B./A9.000-828	Petrol	1592	4	18
06/82→12/86	Ronda 1.7 Diesel	022 A .5000 (138B6.000)	Diesel	1714	4	31
03/90→12/94	Terra 1.3 D	MN	Diesel	1272	4	4
10/90→12/95	Terra 1.4 D	1W	Diesel	1398	4	4
03/90→02/92	Terra Box 1.3 D	MN	Diesel	1272	4	4
10/90→02/92	Terra Box 1.4 D	1W	Diesel	1398	4	4
05/91→03/99	Toledo I 1.6 i	1F	Petrol	1595	4	19
05/91→03/99	Toledo I 1.6 i	ABN	Petrol	1595	4	19
11/96→03/99	Toledo I 1.6 i	AFT	Petrol	1595	4	21
05/91→03/99	Toledo I 1.6 i	EZ	Petrol	1595	4	19
05/91→03/99	Toledo I 1.6i	HM	Petrol	1595	4	19
05/91→03/99	Toledo I 1.8 16V	KR	Petrol	1781	4	20
05/91→03/99	Toledo I 1.8 16V	PL	Petrol	1781	4	20
05/91→11/92	Toledo I 1.8 GT	KR	Petrol	1781	4	20
11/93→12/96	Toledo I 1.8 i	ABS	Petrol	1781	4	20
11/93→12/96	Toledo I 1.8 i	ACC	Petrol	1781	4	19
11/93→12/96	Toledo I 1.8 i	ADZ	Petrol	1781	4	20
05/91→12/96	Toledo I 1.8 i	RP	Petrol	1781	4	19
05/91→03/99	Toledo I 1.9 D	1Y	Diesel	1896	4	14
	Toledo I 1.9 D	AEF	Diesel	1896	4	14
05/91→03/99	Toledo I 1.9 TD	AAZ	Diesel	1896	4	14
08/95→03/99	Toledo I 1.9 TDI	1Z	Diesel	1896	4	15
11/96→03/99	Toledo I 1.9 TDI	AFN	Diesel	1896	4	15
08/95→03/99	Toledo I 1.9 TDI	AHU	Diesel	1896	4	15
05/91→03/99	Toledo I 2.0 i	2E	Petrol	1984	4	28
05/91→03/99	Toledo I 2.0 i	AGG	Petrol	1984	4	28
11/93→03/99	Toledo I 2.0 i 16V	ABF	Petrol	1984	4	28
07/99→05/06	Toledo II 1.4 16V	AHW	Petrol	1390	4	9
07/99→05/06	Toledo II 1.4 16V	APE	Petrol	1390	4	9
07/99→05/06	Toledo II 1.4 16V	AUA	Petrol	1390	4	9
07/99→05/06	Toledo II 1.4 16V	AXP	Petrol	1390	4	9
07/99→05/06	Toledo II 1.4 16V	BCA	Petrol	1390	4	10
04/99→09/00	Toledo II 1.6	AEH	Petrol	1595	4	21
04/99→09/00	Toledo II 1.6	AKL	Petrol	1595	4	21
04/99→09/00	Toledo II 1.6	APF	Petrol	1595	4	21
08/05→05/06	Toledo II 1.6	BFQ	Petrol	1595	4	24
09/00→05/06	Toledo II 1.6 16V	AUS	Petrol	1598	4	9
09/00→05/06	Toledo II 1.6 16V	AZD	Petrol	1598	4	9
09/00→05/06	Toledo II 1.6 16V	BCB	Petrol	1598	4	9
04/99→05/06	Toledo II 1.8 20V	AGN	Petrol	1781	4	22
04/99→05/06	Toledo II 1.8 20V	APG	Petrol	1781	4	22
05/01→05/06	Toledo II 1.8 20VT	APP	Petrol	1781	4	22
05/01→05/06	Toledo II 1.8 20VT	AUQ	Petrol	1781	4	22
11/99→06/04	Toledo II 1.9 SDI	AQM	Diesel	1896	4	15
04/99→05/06	Toledo II 1.9 TDI	AGR	Diesel	1896	4	15
04/99→05/06	Toledo II 1.9 TDI	AHF	Diesel	1896	4	15
04/99→05/06	Toledo II 1.9 TDI	ALH	Diesel	1896	4	15
10/00→05/06	Toledo II 1.9 TDI	ARL	Diesel	1896	4	15
04/99→05/06	Toledo II 1.9 TDI	ASV	Diesel	1896	4	15
05/03→05/06	Toledo II 1.9 TDI	ASZ	Diesel	1896	4	15
04/99→05/01	Toledo II 2.3 V5	AGZ	Petrol	2324	V5	23
05/01→05/06	Toledo II 2.3 V5 20V	AQN	Petrol	2324	V5	23
10/04→05/09	Toledo III 1.6	BGU	Petrol	1595	4	24
10/04→05/09	Toledo III 1.6	BSE	Petrol	1595	4	24
10/04→05/09	Toledo III 1.6	BSF	Petrol	1595	4	24
10/04→05/09	Toledo III 1.6	CCSA	Petrol	1595	4	24
10/04→05/09	Toledo III 1.9 TDI	BJB	Diesel	1896	4	16
10/04→05/09	Toledo III 1.9 TDI	BKC	Diesel	1896	4	16
10/04→05/09	Toledo III 1.9 TDI	BLS	Diesel	1896	4	16

Modelverzeichnis • Index de modele • Índice de Modelo
Indeks modelu • Модель автомобиля • دليل الموديل

MODEL INDEX



CCM

x



9

10/04→05/09	Toledo III 1.9 TDI	BXE	Diesel	1896	4	16
10/04→05/09	Toledo III 2.0 FSI	BLR	Petrol	1984	4	29
10/04→05/09	Toledo III 2.0 FSI	BLY	Petrol	1984	4	29
10/04→05/09	Toledo III 2.0 FSI	BVY	Petrol	1984	4	29
10/04→05/09	Toledo III 2.0 FSI	BVZ	Petrol	1984	4	29
09/04→05/09	Toledo III 2.0 TDI	AZV	Diesel	1968	4	26
11/05→05/09	Toledo III 2.0 TDI	BMM	Diesel	1968	4	26
01/06→05/09	Toledo III 2.0 TDI	BMN	Diesel	1968	4	26
01/06→05/09	Toledo III 2.0 TDI	CEGA	Diesel	1968	4	27
04/04→05/09	Toledo III 2.0 TDI 16V	BKD	Diesel	1968	4	26
11/05→05/09	Toledo III 2.0 TFSI	BWA	Petrol	1984	4	29
07/12→	Toledo IV 1.4 TSI	CAXA	Petrol	1390	4	13
07/12→	Toledo IV 1.6 TDI	CAYC	Diesel	1598	4	17
07/12→	Toledo IV 1.6 TDI	CLNA	Diesel	1598	4	17

Motorverzeichnis • Index de moteur • Índice de Motor
Indeks silnika • Модель двигателя • دليل المحرك

ENGINE INDEX



CCM

x



9

1F	Petrol	1595	4	81.00	19
1W	Diesel	1398	4	75.00	4
1Y	Diesel	1896	4	79.50	14
1Z	Diesel	1896	4	79.50	15
2E	Petrol	1984	4	82.50	28
2G	Petrol	1272	4	75.00	5
08 NCA	Petrol	843	4	65.00	1
021 A.1000	Petrol	1193	4	75.00	3
021 A.2000	Petrol	1461	4	83.00	30
022 A .5000 (138B6.000)	Diesel	1714	4	83.00	31
100 GL.6000	Petrol	843	4	65.00	1
100 GL.7000	Petrol	903	4	65.00	1
100 GL3	Petrol	903	4	65.00	1
131 C4.000	Petrol	1756	4	84.00	32
131 C4.000	Petrol	1995	4	84.00	32
132 BB OA O	Petrol	1592	4	80.00	18
132A/B./A9.000-828	Petrol	1592	4	80.00	18
146 A.000	Petrol	903	4	65.00	1
1000 GL.7000	Petrol	903	4	65.00	1
8144.61	Diesel	2445	4	93.00	34
A112 A5.000	Petrol	903	4	65.00	1
AAU	Petrol	1043	4	75.00	6
AAV	Petrol	1272	4	75.00	5
AAZ	Diesel	1896	4	79.50	14
ABD	Petrol	1390	4	75.00	6
ABF	Petrol	1984	4	82.50	28
ABN	Petrol	1595	4	81.00	19
ABS	Petrol	1781	4	81.00	20
ABU	Petrol	1598	4	76.50	7
ACC	Petrol	1781	4	81.00	19
ADY	Petrol	1984	4	82.50	28
ADZ	Petrol	1781	4	81.00	20
AEE	Petrol	1598	4	76.50	8
AEF	Diesel	1896	4	79.50	14
AEH	Petrol	1595	4	81.00	21
AER	Petrol	999	4	67.10	2

ENGINE INDEX

Motorverzeichnis • Index de moteur • Índice de Motor
Indeks silnika • Модель двигателя • دليل المحرك



CCM

x



9

AEX	Petrol	1391	4	76.50	8
AEY	Diesel	1896	4	79.50	15
AFH	Petrol	1390	4	76.50	9
AFK	Petrol	1390	4	76.50	9
AFN	Diesel	1896	4	79.50	15
AFT	Petrol	1595	4	81.00	21
AGG	Petrol	1984	4	82.50	28
AGN	Petrol	1781	4	81.00	22
AGP	Diesel	1896	4	79.50	15
AGR	Diesel	1896	4	79.50	15
AGZ	Petrol	2324	V5	81.00	23
AHB	Diesel	1716	4	79.50	15
AHF	Diesel	1896	4	79.50	15
AHU	Diesel	1896	4	79.50	15
AHW	Petrol	1390	4	76.50	9
AJH	Petrol	1781	4	81.00	22
AJQ	Petrol	1781	4	81.00	22
AKK	Petrol	1390	4	76.50	9
AKL	Petrol	1595	4	81.00	21
AKU	Diesel	1716	4	79.50	15
AKV	Petrol	1391	4	76.50	8
ALD	Petrol	999	4	67.10	2
ALH	Diesel	1896	4	79.50	15
ALL	Petrol	999	4	67.10	2
ALM	Petrol	1598	4	76.50	8
ALZ	Petrol	1595	4	81.00	24
AMF	Diesel	1422	3	79.50	15
AMK	Petrol	1781	4	81.00	25
ANM	Petrol	1390	4	76.50	9
ANU	Diesel	1896	4	79.50	15
ANV	Petrol	999	4	67.10	2
ANW	Petrol	1390	4	76.50	9
ANX	Petrol	1390	4	76.50	8
APE	Petrol	1390	4	76.50	9
APF	Petrol	1595	4	81.00	21
APG	Petrol	1781	4	81.00	22
APP	Petrol	1781	4	81.00	22
APQ	Petrol	1391	4	76.50	8
AQM	Diesel	1896	4	79.50	15
AQN	Petrol	2324	V5	81.00	23
AQQ	Petrol	1390	4	76.50	9
AQX	Petrol	1781	4	81.00	22
ARL	Diesel	1896	4	79.50	15
ARY	Petrol	1781	4	81.00	22
ASK	Diesel	1896	4	79.50	15
ASV	Diesel	1896	4	79.50	15
ASY	Diesel	1896	4	79.50	15
ASZ	Diesel	1896	4	79.50	15
ATD	Diesel	1896	4	79.50	15
ATM	Petrol	1984	4	82.50	28
ATN	Petrol	1598	4	76.50	9
AUA	Petrol	1390	4	76.50	9
AUB	Petrol	1390	4	76.50	9
AUC	Petrol	999	4	67.10	2
AUD	Petrol	1390	4	76.50	9
AUE	Petrol	2792	V6	81.00	23
AUQ	Petrol	1781	4	81.00	22
AUR	Petrol	1595	4	81.00	21
AUS	Petrol	1598	4	76.50	9
AUY	Diesel	1896	4	79.50	15

Motorverzeichnis • Index de moteur • Índice de Motor
Indeks silnika • Модель двигателя • دليل المحرك

ENGINE INDEX



CCM

x



9

AVG	Diesel	1896	4	79.50	15
AWC	Petrol	1781	4	81.00	22
AXP	Petrol	1390	4	76.50	9
AXR	Diesel	1896	4	79.50	15
AYL	Petrol	2792	V6	81.00	23
AYP	Petrol	1781	4	81.00	22
AYQ	Diesel	1896	4	79.50	15
AZD	Petrol	1598	4	76.50	9
AZL	Petrol	1984	4	82.50	28
AZQ	Petrol	1198	3	76.50	8
AZV	Diesel	1968	4	81.00	26
BAM	Petrol	1781	4	81.00	25
BBX	Petrol	1984	4	82.50	28
BBY	Petrol	1390	4	76.50	9
BBZ	Petrol	1390	4	76.50	9
BCA	Petrol	1390	4	76.50	10
BCB	Petrol	1598	4	76.50	9
BDE	Petrol	2792	V6	81.00	23
BFQ	Petrol	1595	4	81.00	24
BGU	Petrol	1595	4	81.00	24
BJB	Diesel	1896	4	79.50	16
BKC	Diesel	1896	4	79.50	16
BKD	Diesel	1968	4	81.00	26
BKY	Petrol	1390	4	76.50	11
BLR	Petrol	1984	4	82.50	29
BLS	Diesel	1896	4	79.50	16
BLT	Diesel	1896	4	79.50	16
BLY	Petrol	1984	4	82.50	29
BMM	Diesel	1968	4	81.00	26
BMN	Diesel	1968	4	81.00	26
BMS	Diesel	1422	3	79.50	15
BMT	Diesel	1896	4	79.50	16
BNM	Diesel	1422	3	79.50	15
BNV	Diesel	1422	3	79.50	15
BPX	Diesel	1896	4	79.50	16
BRT	Diesel	1968	4	81.00	26
BSE	Petrol	1595	4	81.00	24
BSF	Petrol	1595	4	81.00	24
BTB	Diesel	1896	4	79.50	16
BUK	Diesel	1896	4	79.50	16
BVK	Diesel	1896	4	79.50	16
BVY	Petrol	1984	4	82.50	29
BVZ	Petrol	1984	4	82.50	29
BWA	Petrol	1984	4	82.50	29
BXE	Diesel	1896	4	79.50	16
BXF	Diesel	1896	4	79.50	16
BXJ	Diesel	1896	4	79.50	16
BXW	Petrol	1390	4	76.50	11
CAGA	Diesel	1968	4	81.00	27
CAGC	Diesel	1968	4	81.00	27
CAHA	Diesel	1968	4	81.00	27
CAVA	Petrol	1390	4	76.50	12
CAVE	Petrol	1390	4	76.50	12
CAVF	Petrol	1390	4	76.50	12
CAXA	Petrol	1390	4	76.50	13
CAXC	Petrol	1390	4	76.50	13
CAYA	Diesel	1598	4	79.50	17
CAYB	Diesel	1598	4	79.50	17
CAYC	Diesel	1598	4	79.50	17
CBDB	Diesel	1968	4	81.00	27

ENGINE INDEX

Motorverzeichnis • Index de moteur • Índice de Motor
Indeks silnika • Модель двигателя • دليل المحرك



CCM

x



9

CCSA	Petrol	1595	4	81.00	24
CEGA	Diesel	1968	4	81.00	27
CFFA	Diesel	1968	4	81.00	27
CFFB	Diesel	1968	4	81.00	27
CFFE	Diesel	1968	4	81.00	27
CFGB	Diesel	1968	4	81.00	27
CFGC	Diesel	1968	4	81.00	27
CFHC	Diesel	1968	4	81.00	27
CFHD	Diesel	1968	4	81.00	27
CFJA	Diesel	1968	4	81.00	27
CFWA	Diesel	1199	3	79.50	17
CGGB	Petrol	1390	4	76.50	11
CGLB	Diesel	1968	4	81.00	27
CJCA	Diesel	1968	4	81.00	27
CJCC	Diesel	1968	4	81.00	27
CLCB	Diesel	1968	4	81.00	27
CLNA	Diesel	1598	4	79.50	17
CNWB	Petrol	1390	4	76.50	12
CTHA	Petrol	1390	4	76.50	12
CTHE	Petrol	1390	4	76.50	12
EZ	Petrol	1595	4	81.00	19
HM	Petrol	1595	4	81.00	19
KR	Petrol	1781	4	81.00	20
MN	Diesel	1272	4	75.00	4
OM 615.912	Diesel	2197	4	87.00	33
PL	Petrol	1781	4	81.00	20
RP	Petrol	1781	4	81.00	19



Marbella 0.8 Marbella Box 0.8	08/86→12/93 01/87→12/93	08 NCA	4cyl. 843cc	25kW (34PS)	1	TD3556
Marbella 0.8 Marbella Box 0.8	08/86→12/93 01/87→12/93	100 GL.6000	4cyl. 843cc	25kW (34PS)		TD3559
Fura 0.9 Marbella 0.9 Marbella 0.9 CAT	03/84→12/86 01/87→12/93 01/90→11/96	100 GL.7000	4cyl. 903cc	29kW (39PS)		TD3560
Fura 0.9 Panda 0.9	01/82→06/86 10/80→12/86	100 GL3	4cyl. 903cc	33kW (45PS)		TD3558
Fura 0.9 Marbella 0.9 Marbella 0.9 CAT	03/84→12/86 01/87→12/93 01/90→11/96	1000 GL.7000	4cyl. 903cc	29-32kW (39-44PS)		TD3561
Ibiza I 0.9	08/86→05/93	146 A.000	4cyl. 903cc	29-32kW (40-43PS)		TD9377
127 0.9	04/72→12/82	A112 A5.000	4cyl. 903cc	29-33kW (40-45PS)		TD20969
08-209800-00 08-209806-00 08-209808-00 <i>[R46550]</i>	STD 0.40mm 0.60mm	65.00	1.750 2.000 3.947	 	001 IF CR P 026 P 231 P	IKA STD STD
Arosa 1.0 Cordoba 1.0 i Ibiza II 1.0 i	05/97→06/04 09/96→06/99 09/96→08/99	AER	4cyl. 999cc	37kW (50PS)	2	TD5533
Arosa 1.0 Cordoba 1.0 Ibiza III 1.0	05/97→06/04 06/99→10/02 08/99→02/02	ALD	4cyl. 999cc	37kW (50PS)		TD13890
Arosa 1.0	05/97→06/04	ALL	4cyl. 999cc	37kW (50PS)		TD13891
Arosa 1.0 Cordoba 1.0 Ibiza III 1.0	05/97→06/04 06/99→10/02 08/99→02/02	ANV	4cyl. 999cc	37kW (50PS)		TD13888





Arosa 1.0			05/97→06/04	AUC				
Cordoba 1.0			06/99→10/02		4cyl.			
Ibiza III 1.0			08/99→02/02		999cc	37kW (50PS)		
TD16138								
08-101300-00	STD	67.10	1.000		001 NT			ST
08-101307-00	0.50mm		1.200		005 P			STD
[R66690]			2.000		236 P			GOE13
Ibiza I 1.2, Malaga 1.2			11/84→12/93	021 A.1000				
Ronda 1.2			08/83→12/86		4cyl.			
					1193cc	44-52kW (60-70PS)		
TD3553								
08-349200-00	STD	75.00	1.500		001 IF CR P			IKA
			1.750		026 P			STD
			4.000		712 CR			ST
Terra 1.4 D			10/90→12/95	1W				
Terra Box 1.4 D			10/90→02/92		4cyl.			
					1398cc	35kW (47PS)		
					Diesel			
TD9402								
Terra 1.3 D			03/90→12/94	MN				
Terra Box 1.3 D			03/90→02/92		4cyl.			
					1272cc	33kW (45PS)		
					Diesel			
TD9401								
08-991300-00	STD	75.00	1.750		001 CR P			KV1
08-991307-00	0.50mm		2.000		005 IFU CR P			F12/F14
			3.000		231 CR P			STD
Cordoba 1.3			02/93→08/94	2G				
Ibiza II 1.3 i			03/93→08/99		4cyl.			
					1272cc	40kW (54PS)		
TD3571								
Cordoba 1.3			02/93→08/94	AAV				
Ibiza II 1.3 i			03/93→08/99		4cyl.			
					1272cc	40kW (54PS)		
TD4893								
08-406200-00	STD	75.00	1.750		001 IF CR P			IKA
08-406207-00	0.50mm		2.000		026 P			STD
08-406211-00	1.00mm		3.000		231 CR P			STD
[R46160]								



Ibiza II 1.0		03/93→09/96	AAU	4cyl. 1043cc	33kW (45PS)	6	
							TD4892
Cordoba 1.4 i		06/94→06/99	ABD	4cyl. 1390cc	44kW (60PS)		
Ibiza II 1.4 i		09/93→08/99					TD3574
08-502200-00	STD	75.00	1.500		001 IF CR P		IKA
08-502207-00	0.50mm		1.500		005 P		STD
[R48010]			2.500		236 P		STD
Cordoba 1.6 i		02/93→06/99	ABU	4cyl. 1598cc	55kW (75PS)	7	
							TD4897
Ibiza II 1.6 i		03/93→08/99					
08-502400-00	STD	76.50	1.500		001 CR P		IKA
[R67010]			1.500		026 P		STD
			2.500		712 CR		ST
Cordoba 1.6 i		02/93→06/99	AEE	4cyl. 1598cc	55kW (75PS)	8	
							TD10867
Cordoba Vario 1.6 i		09/96→06/99					
Ibiza II 1.6 i		03/93→08/99					
Inca 1.6 i		06/97→09/00					
Arosa 1.4		05/97→06/04	AEX	4cyl. 1391cc	44kW (60PS)		
							TD5532
Cordoba 1.4 i		06/94→06/99					
Cordoba Vario 1.4 i		09/96→06/99					
Ibiza II 1.4 i		09/93→08/99					
Inca 1.4 i		11/95→06/03					
Arosa 1.4		05/97→06/04	AKV	4cyl. 1391cc	44kW (60PS)		
							TD12513
Cordoba 1.4 i		06/94→06/99					
Cordoba Vario 1.4 i		09/96→06/99					
Ibiza II 1.4 i		09/93→08/99					
Inca 1.4 i		11/95→06/03					
Cordoba 1.6		06/99→10/02	ALM	4cyl. 1598cc	55kW (75PS)		
							TD12949
Cordoba 1.6 i		02/93→06/99					
Cordoba Vario 1.6		06/99→12/02					
Cordoba Vario 1.6 i		09/96→06/99					
Ibiza II 1.6 i		03/93→08/99					
Ibiza III 1.6		08/99→02/02					
Inca 1.6 i		06/97→09/00					
Cordoba 1.4, Ibiza II 1.4		12/97→04/99	ANX	4cyl. 1390cc	44kW (60PS)		
							TD12514
Arosa 1.4		05/97→06/04	APQ	4cyl. 1391cc	44kW (60PS)		
							TD12515
Cordoba 1.4 i		06/94→06/99					
Cordoba Vario 1.4 i		09/96→06/99					
Ibiza II 1.4 i		09/93→08/99					
Inca 1.4 i		11/95→06/03					





Cordoba 1.2			10/02→06/06	AZQ				
Ibiza IV 1.2			02/02→06/06		3cyl.			
					1198cc	47kW (64PS)		
								TD16459
08-103100-00	STD	76.50	1.200		001 NT			ST
			1.500		005 P			STD
			2.500		236 P			STD
08-502800-00	STD	76.50	1.200		001 NT			ST
08-502807-00	0.50mm		1.500		026 P			STD
[R60280]			2.500		712 CR			ST
Cordoba 1.4 i 16V			09/96→06/99	AFH				
Ibiza II 1.4 i 16V			06/97→08/99		4cyl.			9
					1390cc	74kW (100PS)		
								TD5534
Arosa 1.4 16V			01/00→06/04	AFK				
					4cyl.			
					1390cc	74kW (100PS)		
								TD13893
Leon 1.4 16V			11/99→06/06	AHW				
Toledo II 1.4 16V			07/99→05/06		4cyl.			
					1390cc	55kW (75PS)		
								TD15529
Arosa 1.4			05/97→06/04	AKK				
Cordoba 1.4			06/99→10/02		4cyl.			
Cordoba Vario 1.4			06/99→12/02		1390cc	44kW (60PS)		
Ibiza III 1.4			08/99→02/02					TD13892
Arosa 1.4 16V			01/00→06/04	ANM				
Cordoba 1.4 16V			02/00→10/02		4cyl.			
Ibiza III 1.4 16V			08/99→02/02		1390cc	74kW (100PS)		
								TD13894
Arosa 1.4			05/97→06/04	ANW				
Cordoba 1.4			06/99→10/02		4cyl.			
Cordoba Vario 1.4			06/99→12/02		1390cc	44kW (60PS)		
Ibiza III 1.4			08/99→02/02					TD13274
Cordoba 1.4 16V			05/00→10/02	APE				
Cordoba Vario 1.4 16V			06/99→12/02		4cyl.			
Ibiza III 1.4 16V			05/00→02/02		1390cc	55kW (75PS)		
Leon 1.4 16V			11/99→06/06					
Toledo II 1.4 16V			07/99→05/06					TD13268
Arosa 1.4 16V			01/00→06/04	AQQ				
Cordoba 1.4 16V			02/00→10/02		4cyl.			
Ibiza III 1.4 16V			08/99→02/02		1390cc	74kW (100PS)		
								TD15528
Leon 1.6 16 V			09/00→06/06	ATN				
					4cyl.			
					1598cc	77kW (105PS)		
								TD15531





Cordoba 1.4 16V	05/00→10/02	AUA				
Cordoba Vario 1.4 16V	06/99→12/02		4cyl.			
Ibiza III 1.4 16V	05/00→02/02		1390cc	55kW (75PS)		
Inca 1.4 16V	04/00→06/03					
Leon 1.4 16V	11/99→06/06					
Toledo II 1.4 16V	07/99→05/06					TD16197
Arosa 1.4 16V	01/00→06/04	AUB				
Cordoba 1.4 16V	02/00→11/09		4cyl.			
Ibiza III 1.4 16V	08/99→02/02		1390cc	74kW (100PS)		
Ibiza IV 1.4 16V	02/02→11/09					TD16140
Arosa 1.4	05/97→06/04	AUD				
Cordoba 1.4	06/99→10/02		4cyl.			
Cordoba Vario 1.4	06/99→12/02		1390cc	44kW (60PS)		
Ibiza III 1.4	08/99→02/02					
Inca 1.4 i	11/95→06/03					TD16139
Leon 1.6 16 V	09/00→06/06	AUS				
Toledo II 1.6 16V	09/00→05/06		4cyl.			
			1598cc	77kW (105PS)		
						TD15788
Leon 1.4 16V	11/99→06/06	AXP				
Toledo II 1.4 16V	07/99→05/06		4cyl.			
			1390cc	55kW (75PS)		
						TD16134
Leon 1.6 16 V	09/00→06/06	AZD				
Toledo II 1.6 16V	09/00→05/06		4cyl.			
			1598cc	77kW (105PS)		
						TD16131
Cordoba 1.4 16V	09/02→12/07	BBY				
Ibiza IV 1.4 16V	02/02→12/07		4cyl.			
			1390cc	55kW (75PS)		
						TD16460
Cordoba 1.4 16V	10/02→11/09	BBZ				
Ibiza IV 1.4 16V	02/02→11/09		4cyl.			
			1390cc	74kW (100PS)		
						TD16541
Leon 1.6 16 V	09/00→06/06	BCB				
Toledo II 1.6 16V	09/00→05/06		4cyl.			
			1598cc	77kW (105PS)		
						TD16435

08-116100-00	STD	76.50	1.200		001 NT	ST
08-116107-00	0.50mm		1.500		005 P	STD
			2.500		712 CR	ST



Leon 1.4 16V	11/99→06/06	BCA	4cyl.	10
Toledo II 1.4 16V	07/99→05/06		1390cc 55kW (75PS)	
TD16434				

08-116100-00 08-116107-00	STD 0.50mm	76.50	1.200		001 NT	ST
			1.500		005 P	STD
			2.500		712 CR	ST
08-436900-00	STD	76.50	1.200		001 NT	ST
			1.200		005 P	GOE13
			2.000		712 CR	ST

Cordoba 1.4 16V	09/02→12/07	BKY	4cyl.	11
Ibiza IV 1.4 16V	02/02→12/07		1390cc 55kW (75PS)	
TD18750				

Altea 1.4 16V	05/06→	BXW	4cyl.	
Altea XL 1.4 16V	10/06→		1390cc 63kW (86PS)	
Cordoba 1.4 16V, Ibiza IV 1.4 16V	05/06→11/09			
Ibiza V 1.4	03/08→			
Ibiza V Sportcoupe 1.4	07/08→			
Leon 1.4 16V	06/06→			TD19427

Altea 1.4 16V	05/06→	CGGB	4cyl.	
Altea XL 1.4 16V	10/06→		1390cc 63kW (86PS)	
Ibiza V 1.4	03/08→			
Ibiza V Sportcoupe 1.4	07/08→			
Ibiza V ST 1.4	03/10→			
Leon 1.4 16V	06/06→			TD23136

08-436900-00	STD	76.50	1.200		001 NT	ST
			1.200		005 P	GOE13
			2.000		712 CR	ST

Alhambra 1.4 TSI	06/10→	CAVA	4cyl.	12
			1390cc 110kW (150PS)	
			Turbo & Supercharged	TD24449

Ibiza V Sportcoupe 1.4 TSI Cupra	06/09→	CAVE	4cyl.	
			1390cc 132kW (180PS)	
			Turbo & Supercharged	TD23095

Ibiza V 1.4 TSI,	06/09→	CAVF	4cyl.	
Ibiza V Sportcoupe 1.4 TSI			1390cc 110kW (150PS)	
Ibiza V ST 1.4 TSI	02/12→		Turbo & Supercharged	TD23096

Alhambra 1.4 TSI	06/10→	CNWB	4cyl.	
			1390cc 110kW (150PS)	
			Turbo & Supercharged	TD25702

Alhambra 1.4 TSI	06/10→	CTHA	4cyl.	
			1390cc 110kW (150PS)	
			Turbo & Supercharged	TD27527





Ibiza V Sportcoupe 1.4 TSI Cupra		06/09→	CTHE		4cyl. 1390cc 132kW (180PS) Turbo & Supercharged	TD26916
----------------------------------	--	--------	-------------	--	--	----------------

08-433900-00 08-433907-00	STD	76.50	1.200		001 NT	ST
	0.50mm		1.500		005 P	GOE13
			2.000		712 NT	ST

Toledo IV 1.4 TSI		07/12→	CAXA		4cyl. 1390cc 90kW (122PS) Turbo Intercooled	13 TD27223
-------------------	--	--------	-------------	--	--	-----------------------------

Altea 1.4 TSI, Altea XL 1.4 TSI, Leon 1.4 TSI		11/07→	CAXC		4cyl. 1390cc 92kW (125PS) Turbo Intercooled	TD20488
--	--	--------	-------------	--	--	----------------

08-429900-00 08-429907-00	STD	76.50	1.200		001 NT	ST
	0.50mm		1.200		005 P	GOE13
			2.000		712 NT	ST

Cordoba 1.9 D Ibiza II 1.9 D Inca 1.9 D Toledo I 1.9 D		02/93→08/96 04/93→08/96 11/95→06/03 05/91→03/99	1Y		4cyl. 1896cc 47kW (64PS)	14 TD4891
---	--	--	-----------	--	---	----------------------------

Cordoba 1.9 TD Ibiza II 1.9 TD Toledo I 1.9 TD		02/93→08/96 03/93→08/96 05/91→03/99	AAZ		4cyl. 1896cc 55kW (75PS) Diesel Turbo	TD4894
--	--	---	------------	--	--	---------------

Cordoba 1.9 D, Ibiza II 1.9 D, Inca 1.9 D, Pony / Excel Saloon 1.3, Toledo I 1.9 D			AEF		4cyl. 1896cc 47kW (64PS) Diesel	TD9373
---	--	--	------------	--	--	---------------

08-990100-00 08-990105-00 08-990107-00 08-990111-00	STD	79.50	1.750		001 CR P	KV1
	0.25mm		2.000		005 IFU P	STD
	0.50mm		3.000		231 CR P	STD
	1.00mm					

[R45120]

Alhambra 1.9 TDI Cordoba 1.9 TDI, Cordoba Vario 1.9 TDI Ibiza II 1.9 TDI Toledo I 1.9 TDI		04/96→03/10 08/96→06/99 08/96→08/99 08/95→03/99	1Z		4cyl. 1896cc 66kW (89PS) Diesel Turbo Intercooled	15 TD5527
--	--	--	-----------	--	--	----------------------------

Cordoba 1.9 SDI Cordoba Vario 1.9 SDI Ibiza II 1.9 SDI Inca 1.9 SDI		08/96→06/99 09/96→06/99 08/96→08/99 11/95→06/03	AEY		4cyl. 1896cc 47kW (64PS) Diesel	TD5535
--	--	--	------------	--	--	---------------

Alhambra 1.9 TDI Cordoba 1.9 TDI Cordoba Vario 1.9 TDI Ibiza II 1.9 TDI Toledo I 1.9 TDI		08/96→06/00 03/97→06/99 07/97→06/99 02/97→08/99 11/96→03/99	AFN		4cyl. 1896cc 81kW (110PS) Diesel Turbo Intercooled	TD5531
--	--	---	------------	--	---	---------------





Cordoba 1.9 SDI	06/99→10/02	AGP				
Cordoba Vario 1.9 SDI	06/99→12/02		4cyl.			
Ibiza III 1.9 SDI	08/99→02/02		1896cc	50kW (68PS)		
		Diesel				TD14808
Cordoba 1.9 TDI	06/99→10/02	AGR				
Cordoba Vario 1.9 TDI	06/99→12/02		4cyl.			
Ibiza III 1.9 TDI	08/99→02/02		1896cc	66kW (89PS)		
Leon 1.9 TDI	11/99→06/06	Diesel	Turbo Intercooled			
Toledo II 1.9 TDI	04/99→05/06					TD13278
Inca 1.7 D	09/96→06/03	AHB				
			4cyl.			
			1716cc	42kW (57PS)		
		Diesel				TD9403
Leon 1.9 TDI	11/99→06/06	AHF				
Toledo II 1.9 TDI	04/99→05/06		4cyl.			
			1896cc	81kW (110PS)		
		Diesel	Turbo Intercooled			TD12512
Alhambra 1.9 TDI	04/96→03/10	AHU				
Cordoba 1.9 TDI	08/96→10/02		4cyl.			
Cordoba Vario 1.9 TDI	08/96→06/99		1896cc	66kW (89PS)		
Ibiza II 1.9 TDI	08/96→08/99	Diesel	Turbo Intercooled			
Toledo I 1.9 TDI	08/95→03/99					TD5528
Arosa 1.7 SDI	08/97→06/04	AKU				
Cordoba 1.7 SDI, Cordoba Vario 1.7 SDI	07/97→06/99		4cyl.			
			1716cc	44kW (60PS)		
		Diesel				TD13896
Cordoba 1.9 TDI	06/99→10/02	ALH				
Cordoba Vario 1.9 TDI	06/99→12/02		4cyl.			
Ibiza III 1.9 TDI	08/99→02/02		1896cc	66kW (89PS)		
Inca 1.9 TDI	09/96→06/03	Diesel	Turbo Intercooled			
Leon 1.9 TDI	11/99→06/06					
Toledo II 1.9 TDI	04/99→05/06					TD13272
Arosa 1.4 TDI	01/00→06/04	AMF				
Cordoba 1.4 TDI	10/02→12/05		3cyl.			
Ibiza IV 1.4 TDI	05/02→12/05		1422cc	55kW (75PS)		
		Diesel	Turbo Intercooled			TD13895
Alhambra 1.9 TDI	04/96→03/10	ANU				
			4cyl.			
			1896cc	66kW (89PS)		
		Diesel	Turbo Intercooled			TD14911
Cordoba 1.9 SDI	06/99→10/02	AQM				
Cordoba Vario 1.9 SDI	06/99→12/02		4cyl.			
Ibiza III 1.9 SDI	08/99→02/02		1896cc	50kW (68PS)		
Leon 1.9 SDI	11/99→06/06	Diesel	Turbo Intercooled			
Toledo II 1.9 SDI	11/99→06/04					TD13271
Alhambra 1.9 TDI	05/05→05/07	ARL				
Leon 1.9 TDI	02/01→06/06		4cyl.			
Leon 1.9 TDI Syncro	05/02→06/06		1896cc	110kW (150PS)		
Toledo II 1.9 TDI	10/00→05/06	Diesel	Turbo Intercooled			TD15768
Cordoba 1.9 TDI	06/99→10/02	ASK				
Cordoba Vario 1.9 TDI	06/99→12/02		4cyl.			
Ibiza III 1.9 TDI	08/99→02/02		1896cc	81kW (110PS)		
		Diesel	Turbo Intercooled			TD13277





Cordoba 1.9 TDI	06/99→10/02	ASV				
Cordoba Vario 1.9 TDI	06/99→12/02		4cyl.			
Ibiza III 1.9 TDI	08/99→02/02		1896cc	81kW (110PS)		
Leon 1.9 TDI	11/99→	Diesel	Turbo Intercooled			
Toledo II 1.9 TDI	04/99→05/06					TD13273
Cordoba 1.9 SDI	09/02→11/09	ASY				
Ibiza IV 1.9 SDI	02/02→12/05		4cyl.			
		Diesel	1896cc	47kW (64PS)		TD16461
Alhambra 1.9 TDI	11/02→11/08	ASZ				
Alhambra 1.9 Tdi 4x4	06/05→11/08		4cyl.			
Cordoba 1.9 TDI	10/02→11/09		1896cc	96kW (131PS)		
Ibiza IV 1.9 TDI	02/02→11/09	Diesel	Turbo Intercooled			
Leon 1.9 TDI	05/03→06/06					
Toledo II 1.9 TDI	05/03→05/06					TD16463
Cordoba 1.9 TDI	09/02→11/09	ATD				
Ibiza IV 1.9 TDI	02/02→11/09		4cyl.			
		Diesel	1896cc	74kW (100PS)		TD16462
			Turbo Intercooled			
Alhambra 1.9 TDI, Alhambra 1.9 TDI 4motion	06/00→03/10	AUY				
			4cyl.			
		Diesel	1896cc	85kW (116PS)		TD14912
			Turbo Intercooled			
Alhambra 1.9 TDI	08/96→06/00	AVG				
			4cyl.			
		Diesel	1896cc	81kW (110PS)		TD23884
			Turbo Intercooled			
Cordoba 1.9 TDI	09/02→11/09	AXR				
Ibiza IV 1.9 TDI	02/02→11/09		4cyl.			
Leon 1.9 TDI	10/05→06/06		1896cc	74kW (100PS)		
		Diesel	Turbo Intercooled			TD18739
Inca 1.9 SDI	11/95→06/03	AYQ				
			4cyl.			
		Diesel	1896cc	47kW (64PS)		TD16198
Cordoba 1.4 TDI, Ibiza IV 1.4 TDI	06/05→11/09	BMS				
Ibiza V 1.4 TDI, Ibiza V Sportcoupe 1.4 TDI	07/08→06/10		3cyl.			
		Diesel	1422cc	59kW (80PS)		TD18727
			Turbo Intercooled			
Cordoba 1.4 TDI, Ibiza IV 1.4 TDI	05/05→11/09	BNM				
			3cyl.			
		Diesel	1422cc	51kW (69PS)		TD18726
			Turbo Intercooled			
Cordoba 1.4 TDI, Ibiza IV 1.4 TDI	06/05→11/09	BNV				
			3cyl.			
		Diesel	1422cc	59kW (80PS)		TD18738
			Turbo Intercooled			

08-114900-00	STD	79.50	1.750		001 CK P	KV1
08-114905-00	0.25mm				005 IFU P	STD
08-114907-00	0.50mm		2.000			
08-114911-00	1.00mm		3.000		231 CR P	STD

[R60370]



Altea 1.9 TDI Toledo III 1.9 TDI	04/04 → 10/04 →05/09	BJB	4cyl. 1896cc 77kW (105PS) Diesel Turbo Intercooled	16 TD17356
Altea 1.9 TDI Altea XL 1.9 TDI Leon 1.9 TDI Toledo III 1.9 TDI	04/04 → 10/06 → 07/05 → 10/04 →05/09	BKC	4cyl. 1896cc 77kW (105PS) Diesel Turbo Intercooled	TD17355
Altea 1.9 TDI Altea XL 1.9 TDI Ibiza V 1.9 TDI Ibiza V Sportcoupe 1.9 TDI Leon 1.9 TDI Toledo III 1.9 TDI	04/04 → 10/06 → 03/08 →06/10 07/08 →06/10 07/05 → 10/04 →05/09	BLS	4cyl. 1896cc 77kW (105PS) Diesel Turbo Intercooled	TD18268
Cordoba 1.9 TDI Ibiza IV 1.9 TDI	10/02 →11/09 02/02 →11/09	BLT	4cyl. 1896cc 96kW (131PS) Diesel Turbo Intercooled	TD20516
Cordoba 1.9 TDI Ibiza IV 1.9 TDI	09/02 →11/09 02/02 →11/09	BMT	4cyl. 1896cc 74kW (100PS) Diesel Turbo Intercooled	TD20495
Ibiza IV 1.9 TDI Cupra R	03/04 →02/08	BPX	4cyl. 1896cc 118kW (160PS) Diesel Turbo Intercooled	TD17640
Alhambra 1.9 TDI	05/05 →05/07	BTB	4cyl. 1896cc 110kW (150PS) Diesel Turbo Intercooled	TD20625
Ibiza IV 1.9 TDI Cupra R	03/04 →02/08	BUK	4cyl. 1896cc 118kW (160PS) Diesel Turbo Intercooled	TD22667
Alhambra 1.9 TDI, Alhambra 1.9 TDI 4motion	06/00 →03/10	BVK	4cyl. 1896cc 85kW (116PS) Diesel Turbo Intercooled	TD20515
Altea 1.9 TDI Altea XL 1.9 TDI Leon 1.9 TDI Toledo III 1.9 TDI	04/04 → 10/06 → 07/05 → 10/04 →05/09	BXE	4cyl. 1896cc 77kW (105PS) Diesel Turbo Intercooled	TD19819
Altea 1.9 TDI, Altea XL 1.9 TDI Leon 1.9 TDI	08/09 → 06/07 →	BXF	4cyl. 1896cc 66kW (89PS) Diesel Turbo Intercooled	TD20866





Ibiza V 1.9 TDI,		07/08→06/10		BXJ		4cyl.			
Ibiza V Sportcoupe 1.9 TDI						1896cc		66kW (89PS)	
				Diesel		Turbo Intercooled		TD20840	
08-114900-00	STD	79.50	1.750		001 CK P			KV1	
08-114905-00	0.25mm		2.000		005 IFU P			STD	
08-114907-00	0.50mm		3.000		231 CR P			STD	
08-114911-00	1.00mm								
<i>[R60370]</i>									
08-433000-00	STD	79.50	1.750		001 GDC P			KV4	
08-433007-00	0.50mm		2.000		005 IFU P			F12/F14	
01/2006→			3.000		231 LKZ CR P			GOE13	
with DPF									
Ibiza V 1.6 TDI,		05/10→06/10		CAYA		4cyl.			
Ibiza V Sportcoupe 1.6 TDI						1598cc		55kW (75PS)	
				Diesel		Turbo Intercooled		TD25762	
17									
Altea 1.6 TDI, Altea XL 1.6 TDI		11/10→		CAYB		4cyl.			
Ibiza V 1.6 TDI,		05/09→				1598cc		66kW (89PS)	
Ibiza V Sportcoupe 1.6 TDI				Diesel		Turbo Intercooled		TD22670	
Ibiza V ST 1.6 TDI		03/10→							
Leon 1.6 TDI		11/10→							
Altea 1.6 TDI, Altea XL 1.6 TDI		10/09→		CAYC		4cyl.			
Ibiza V 1.6 TDI,		05/09→				1598cc		77kW (105PS)	
Ibiza V Sportcoupe 1.6 TDI				Diesel		Turbo Intercooled		TD22671	
Ibiza V ST 1.6 TDI		03/10→							
Leon 1.6 TDI		02/10→							
Toledo IV 1.6 TDI		07/12→							
Ibiza V 1.2 TDI,		05/10→		CFWA		3cyl.			
Ibiza V Sportcoupe 1.2 TDI						1199cc		55kW (75PS)	
Ibiza V ST 1.2 TDI		04/10→		Diesel		Turbo Intercooled		TD23935	
Ibiza V 1.6 TDI,		05/09→		CLNA		4cyl.			
Ibiza V Sportcoupe 1.6 TDI						1598cc		77kW (105PS)	
Ibiza V ST 1.6 TDI		03/10→		Diesel		Turbo Intercooled		TD23934	
Toledo IV 1.6 TDI		07/12→							
08-432900-00	STD	79.50	1.750		001 GDC P			KV4	
08-432907-00	0.50mm		2.000		005 IFU P			F12/F14	
			3.000		231 LKZ CR P			STD	



131 1.6	03/82→01/85	132 BB OA O	4cyl.	1592cc	71-72kW (97-98PS)	18	TD22904
---------	-------------	-------------	-------	--------	-------------------	----	---------

131 E 1600 Ronda 1.6	01/82→	132A/B./A9.000-828	4cyl.	1592cc			FM544
-------------------------	--------	--------------------	-------	--------	--	--	-------

08-203100-00	STD	80.00	1.500		001 IF CR P	IKA		
08-203104-00	0.20mm				026 P		STD	
08-203106-00	0.40mm			2.000			026 P	STD
08-203108-00	0.60mm			3.947			232 P	STD
08-203110-00	0.80mm							
08-203111-00	1.00mm							
[R47750]								

Cordoba 1.6 i	05/94→06/99	1F	4cyl.	1595cc	53-55kW (72-75PS)	19	TD4890
Cordoba Vario 1.6 i	05/97→06/99						
Ibiza II 1.6 i	09/94→06/99						
Inca 1.6 i	11/95→05/98						
Toledo I 1.6 i	05/91→03/99						

Toledo I 1.6 i	05/91→03/99	ABN	4cyl.	1595cc	54-55kW (73-75PS)		TD17897
----------------	-------------	-----	-------	--------	-------------------	--	---------

Cordoba 1.8 i	02/93→06/99	ACC	4cyl.	1781cc	66kW (89PS)		TD18752
Ibiza II 1.8 i	03/93→08/99						
Toledo I 1.8 i	11/93→12/96						

Toledo I 1.6 i	05/91→03/99	EZ	4cyl.	1595cc	52-54kW (71-73PS)		TD4899
----------------	-------------	----	-------	--------	-------------------	--	--------

Toledo I 1.6i	05/91→03/99	HM	4cyl.	1595cc	38-55kW (52-75PS)		TD3590
---------------	-------------	----	-------	--------	-------------------	--	--------

Toledo I 1.8 i	05/91→12/96	RP	4cyl.	1781cc	66kW (89PS)		TD3596
----------------	-------------	----	-------	--------	-------------	--	--------







08-109700-00	STD	81.00	1.500		001 IF CR P	IKA	
08-109705-00	0.25mm				026 P		STD
08-109707-00	0.50mm			1.750			026 P
			3.000		231 CR P	STD	
[R48000]							

Cordoba 1.8 i	02/93→06/99	ABS	4cyl.	1781cc	66kW (89PS)	20	TD3576
Ibiza II 1.8 i	03/93→08/99						
Toledo I 1.8 i	11/93→12/96						

Cordoba 1.8 i	02/93→06/99	ADZ	4cyl.	1781cc	66kW (89PS)		TD9384
Ibiza II 1.8 i	03/93→08/99						
Toledo I 1.8 i	11/93→12/96						



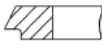

Toledo I 1.8 16V			05/91→03/99	KR				
Toledo I 1.8 GT			05/91→11/92		4cyl.	1781cc	98-102kW (133-139PS)	TD3591
Toledo I 1.8 16V			05/91→03/99	PL	4cyl.	1781cc	95kW (129PS)	TD3595
08-109400-10	STD	81.00	1.500		005 P PS			KV1
08-109407-10	0.50mm		1.750		026 P			STD
[R40850]			3.000		231 CR P			STD
Cordoba 1.6			06/99→10/02	AEH				21
Cordoba Vario 1.6			06/99→12/02		4cyl.			
Ibiza III 1.6			08/99→02/02		1595cc	74kW (100PS)		
Leon 1.6			11/99→06/06					
Toledo II 1.6			04/99→09/00				TD12488	
Cordoba 1.6 i			07/96→10/99	AFT				TD5536
Cordoba Vario 1.6 i			09/96→06/99		4cyl.			
Ibiza II 1.6 i			04/96→08/99		1595cc	74kW (100PS)		
Toledo I 1.6 i			11/96→03/99					
Cordoba 1.6			06/99→10/02	AKL				TD12509
Cordoba 1.6 i			07/96→10/99		4cyl.			
Cordoba Vario 1.6			06/99→12/02		1595cc	74kW (100PS)		
Ibiza III 1.6			08/99→02/02					
Leon 1.6			11/99→06/06					
Toledo II 1.6			04/99→09/00					
Cordoba 1.6			06/99→10/02	APF				TD13269
Cordoba Vario 1.6			06/99→12/02		4cyl.			
Ibiza III 1.6			08/99→02/02		1595cc	74kW (100PS)		
Leon 1.6			11/99→06/06					
Toledo II 1.6			04/99→09/00					
Cordoba 1.6			06/99→10/02	AUR				TD16200
Cordoba Vario 1.6			06/99→12/02		4cyl.			
Ibiza III 1.6			08/99→02/02		1595cc	74kW (100PS)		
08-105900-00	STD	81.00	1.200		001 NT			ST
08-105907-00	0.50mm		1.500		026 P			STD
[R60290]			2.000		712 CR			ST
Leon 1.8 20V			11/99→06/06	AGN				22
Toledo II 1.8 20V			04/99→05/06		4cyl.	1781cc	92kW (125PS)	
Leon 1.8 20V			11/99→06/06					TD12510
Alhambra 1.8 T 20V			10/97→03/10	AJH				TD17899
Leon 1.8 20V T 4			11/99→06/06		4cyl.	1781cc	110kW (150PS)	
Leon 1.8 20V T 4			11/99→06/06	AJQ				TD17899
Leon 1.8 20V T 4			11/99→06/06		4cyl.	1781cc	132kW (180PS)	TD16199
Leon 1.8 20V T 4			11/99→06/06					







Leon 1.8 20V Toledo II 1.8 20V	11/99→06/06 04/99→05/06	APG	4cyl. 1781cc	92kW (125PS)	TD15530	
Leon 1.8 20V T Toledo II 1.8 20VT	11/99→06/06 05/01→05/06	APP	4cyl. 1781cc	132kW (180PS) Turbo Intercooled	TD13270	
Cordoba 1.8 T 20V Cupra Ibiza III 1.8 T 20V Cupra	07/00→10/02 07/00→02/02	AQX	4cyl. 1781cc	115kW (156PS) Turbo Intercooled	TD13275	
Leon 1.8 20V T 4	11/99→06/06	ARY	4cyl. 1781cc	132kW (180PS) Turbo Intercooled	TD16136	
Leon 1.8 20V T Toledo II 1.8 20VT	11/99→06/06 05/01→05/06	AUQ	4cyl. 1781cc	132kW (180PS) Turbo Intercooled	TD16135	
Alhambra 1.8 T 20V	10/97→03/10	AWC	4cyl. 1781cc	110kW (150PS) Turbo Intercooled	TD14909	
Cordoba 1.8 T 20V Cupra Ibiza III 1.8 T 20V Cupra	07/00→10/02 07/00→02/02	AYP	4cyl. 1781cc	115kW (156PS) Turbo Intercooled	TD16201	
08-502900-00 08-502905-00 08-502907-00 [R60320]	STD 0.25mm 0.50mm 	81.00	1.500 1.750 2.000	 	001 CK P 026 P 231 CR P	KV1 GOE13 KV1
Toledo II 2.3 V5	04/99→05/01	AGZ	V5cyl. 2324cc	110kW (150PS)	23 TD12511	
Toledo II 2.3 V5 20V	05/01→05/06	AQN	V5cyl. 2324cc	125kW (170PS)	TD16163	
Alhambra 2.8 V6, Alhambra 2.8 V6 4motion Leon 2.8 Cupra 4	06/00→03/10 02/01→06/06	AUE	V6cyl. 2792cc	150kW (204PS)	TD16137	
Alhambra 2.8 V6, Alhambra 2.8 V6 4motion	06/00→03/10	AYL	V6cyl. 2792cc	150kW (204PS)	TD14910	





Leon 2.8			05/02→06/04	BDE	V6cyl. 2792cc	150kW (204PS)	TD18753
08-501900-00	STD	81.00	1.500		001 P PS		KV1
08-501907-00	0.50mm		1.750		026 P		STD
[R60300]			3.000		231 CR P		STD
Exeo 1.6			03/09→09/10	ALZ	4cyl. 1595cc	75kW (102PS)	24 TD22242
Exeo ST 1.6			06/09→09/10				
Leon 1.6			10/05→06/06	BFQ	4cyl. 1595cc	75kW (102PS)	TD20621
Toledo II 1.6			08/05→05/06				
Altea 1.6			03/04→	BGU	4cyl. 1595cc	75kW (102PS)	TD17352
Leon 1.6			10/05→06/06				
Toledo III 1.6			10/04→05/09				
Altea 1.6			03/04→	BSE	4cyl. 1595cc	75kW (102PS)	TD18245
Altea XL 1.6			10/06→				
Leon 1.6			07/05→				
Toledo III 1.6			10/04→05/09				
Altea 1.6			03/04→	BSF	4cyl. 1595cc	75kW (102PS)	TD18246
Altea XL 1.6			10/06→				
Leon 1.6			07/05→				
Toledo III 1.6			10/04→05/09				
Altea 1.6			03/04→	CCSA	4cyl. 1595cc	75kW (102PS)	TD20710
Altea XL 1.6, Altea XL 1.6 Multifuel			10/06→				
Leon 1.6			07/05→				
Toledo III 1.6			10/04→05/09				
08-148300-00	STD	81.00	1.000		001 NT		ST
			1.200		023 P		GOE13
			2.000		231 CR P		KV1
Leon 1.8 T Cupra R			02/02→06/06	AMK	4cyl. 1781cc	154kW (210PS) Turbo Intercooled	25 TD16436
Leon 1.8 T Cupra R			07/03→06/06	BAM	4cyl. 1781cc	165kW (224PS) Turbo Intercooled	TD17347
08-115900-00	STD	81.00	1.500		005 PS		ST
			1.750		026 P		GOE13
			2.000		231 CR P		KV1



Altea 2.0 TDI				03/04 → 05/09	AZV	4cyl. 1968cc 100kW (136PS)	Turbo Intercooled	TD18247
Altea XL 2.0 TDI				11/06 → 03/09				
Leon 2.0 TDI				07/05 → 05/10				
Toledo III 2.0 TDI				09/04 → 05/09				
Altea 2.0 TDI 16V				03/04 →	BKD	4cyl. 1968cc 103kW (140PS)	Turbo Intercooled	TD17357
Altea XL 2.0 TDI 16V				10/06 →				
Leon 2.0 TDI 16V				07/05 →				
Toledo III 2.0 TDI 16V				04/04 → 05/09				
Altea 2.0 TDI				11/05 →	BMM	4cyl. 1968cc 103kW (140PS)	Turbo Intercooled	TD18269
Altea XL 2.0 TDI				10/06 →				
Altea XL 2.0 TDI 4x4				06/07 →				
Leon 2.0 TDI				10/05 →				
Toledo III 2.0 TDI				11/05 → 05/09				
Altea 2.0 TDI				03/06 →	BMN	4cyl. 1968cc 125kW (170PS)	Turbo Intercooled	TD18977
Altea XL 2.0 TDI, Altea XL 2.0 TDI 4x4				06/07 →				
Leon 2.0 TDI				05/06 →				
Toledo III 2.0 TDI				01/06 → 05/09				
Alhambra 2.0 TDI				11/05 → 03/10	BRT	4cyl. 1968cc 103kW (140PS)	Turbo Intercooled	TD19388
08-139500-00	STD	81.00	1.750		001 CK P			
08-139507-00	0.50mm		2.000		005 IFU P		F12/F14	
			3.000		231 CR P		STD	
Exeo 2.0 TDI				12/08 →	CAGA	4cyl. 1968cc 105kW (143PS)	Turbo Intercooled	TD22243
Exeo ST 2.0 TDI				05/09 →				
Exeo 2.0 TDI				12/08 →	CAGC	4cyl. 1968cc 88kW (120PS)	Turbo Intercooled	TD22669
Exeo ST 2.0 TDI				07/09 →				
Exeo 2.0 TDI				02/09 →	CAHA	4cyl. 1968cc 125kW (170PS)	Turbo Intercooled	TD22244
Exeo ST 2.0 TDI				05/09 →				
Exeo 2.0 TDI				12/08 →	CBDB	4cyl. 1968cc 103kW (140PS)	Turbo Intercooled	TD24327
Exeo ST 2.0 TDI				05/09 →				
Altea 2.0 TDI				03/06 →	CEGA	4cyl. 1968cc 125kW (170PS)	Turbo Intercooled	TD22674
Altea XL 2.0 TDI, Altea XL 2.0 TDI 4x4				06/07 →				
Leon 2.0 TDI				05/06 →				
Toledo III 2.0 TDI				01/06 → 05/09				
Alhambra 2.0 TDI				06/10 → 05/11	CFFA	4cyl. 1968cc 100kW (136PS)	Turbo Intercooled	TD25404
Alhambra 2.0 TDI				06/10 →	CFFB	4cyl. 1968cc 103kW (140PS)	Turbo Intercooled	TD24450
Alhambra 2.0 TDI All-wheel Drive				05/11 →				





Alhambra 2.0 TDI	05/11→	CFFE	4cyl. 1968cc	85kW (116PS)	Diesel	Turbo Intercooled	TD25403
Alhambra 2.0 TDI	06/10→	CFGB	4cyl. 1968cc	125kW (170PS)	Diesel	Turbo Intercooled	TD24451
Alhambra 2.0 TDI	11/12→	CFGC	4cyl. 1968cc	130kW (177PS)	Diesel	Turbo	TD27529
Altea 2.0 TDI 16V	03/04→	CFHC	4cyl. 1968cc	103kW (140PS)	Diesel	Turbo Intercooled	TD24326
Altea XL 2.0 TDI 16V	10/06→						
Altea XL 2.0 TDI 16V 4x4	10/10→						
Leon 2.0 TDI 16V	07/05→						
Ibiza V 2.0 TDI, Ibiza V Sportcoupe 2.0 TDI	01/10→	CFHD	4cyl. 1968cc	105kW (143PS)	Diesel	Turbo Intercooled	TD23582
Altea XL 2.0 TDI 4x4	06/07→	CFJA	4cyl. 1968cc	125kW (170PS)	Diesel	Turbo Intercooled	TD24333
Leon 2.0 TDI	05/06→						
Exeo 2.0 TDI	02/09→	CGLB	4cyl. 1968cc	125kW (170PS)	Diesel	Turbo Intercooled	TD26498
Exeo ST 2.0 TDI	05/09→						
Exeo 2.0 TDI	12/08→	CJCA	4cyl. 1968cc	105kW (143PS)	Diesel	Turbo Intercooled	TD26497
Exeo ST 2.0 TDI	05/09→						
Exeo 2.0 TDI	12/08→	CJCC	4cyl. 1968cc	88kW (120PS)	Diesel	Turbo Intercooled	TD27013
Exeo ST 2.0 TDI	07/09→						
Leon 2.0 TDI 16V	07/05→	CLCB	4cyl. 1968cc	103kW (140PS)	Diesel	Turbo Intercooled	TD25102

08-432300-00 STD
08-432307-00 0.50mm

81.00

1.750

2.000

3.000



001 GDC P

KV4



005 IFU P

F12/F14



231 LKZ CR P

GOE13



08-432300-00 OE: 03L198151A

08-432300-00 OE: 03L198151A

08-432300-00 OE: 03L198151A















08-432300-00 OE: 03L198151A



Cordoba 2.0 i Ibiza II 2.0 i Toledo I 2.0 i	02/93→06/99 03/93→08/99 05/91→03/99	2E	4cyl. 1984cc	85kW (116PS)	28	TD3570
Cordoba 2.0 i 16V Ibiza II 2.0 i 16V Toledo I 2.0 i 16V	08/96→06/99 08/96→08/99 11/93→03/99	ABF	4cyl. 1984cc	110kW (150PS)		TD4895
Alhambra 2.0 i	04/96→03/10	ADY	4cyl. 1984cc	85kW (116PS)		TD9386
Cordoba 2.0 i Ibiza II 2.0 i Toledo I 2.0 i	02/93→06/99 03/93→08/99 05/91→03/99	AGG	4cyl. 1984cc	85kW (116PS)		TD5537
Alhambra 2.0 i	04/96→03/10	ATM	4cyl. 1984cc	85kW (116PS)		TD14908
Cordoba 2.0 Ibiza IV 2.0	09/02→11/09 04/02→11/09	AZL	4cyl. 1984cc	85kW (116PS)		TD17901
Cordoba 2.0 Ibiza IV 2.0	09/02→11/09 04/02→11/09	BBX	4cyl. 1984cc	85kW (116PS)		TD18446
08-501800-00 08-501807-00 <i>[R60310]</i>	STD 0.50mm	82.50	1.200 1.500 2.000	 	005 PS 005 IW P 231 CR P	KV1 STD KV1
Altea 2.0 FSI Leon 2.0 FSI Toledo III 2.0 FSI	05/04→03/09 07/05→05/10 10/04→05/09	BLR	4cyl. 1984cc	110kW (150PS)	29	TD17353
Altea 2.0 FSI Leon 2.0 FSI Toledo III 2.0 FSI	05/04→03/09 07/05→05/10 10/04→05/09	BLY	4cyl. 1984cc	110kW (150PS)		TD17354
Altea 2.0 FSI Altea XL 2.0 FSI Leon 2.0 FSI Toledo III 2.0 FSI	05/04→03/09 10/06→03/09 07/05→05/10 10/04→05/09	BVY	4cyl. 1984cc	110kW (150PS)		TD18266
Altea 2.0 FSI Altea XL 2.0 FSI Leon 2.0 FSI Toledo III 2.0 FSI	05/04→03/09 10/06→03/09 07/05→05/10 10/04→05/09	BVZ	4cyl. 1984cc	110kW (150PS)		TD18267





Altea 2.0 TFSI			04/06→05/09	BWA		
Altea XL 2.0 TFSI 4x4			06/07→05/09		4cyl.	
Leon 2.0 TFSI			05/05→03/09		1984cc	147kW (200PS)
Toledo III 2.0 TFSI			11/05→05/09		Turbo Intercooled	TD19424
08-435100-10	STD	82.50	1.200		001 NT PVD	ST
			1.500		026	GOE13
			2.000		231 CR	KV1
Ibiza I 1.5			11/84→05/93	021 A.2000		
Malaga 1.5			05/85→12/93		4cyl.	
Malaga 1.5 i CAT			10/86→12/93		1461cc	63-66kW (85-90PS)
Ronda 1.5			09/84→12/86			TD3554
08-349300-00	STD	83.00	1.500		001 IF CR P	IKA
			1.750		026 P	STD
			4.000		712 CR	ST
Ibiza I 1.7 D			06/84→05/93	022 A .5000 (138B6.000)		
Malaga 1.7 D			05/85→12/93		4cyl.	
Ritmo 1.7 D			10/79→09/83		1714cc	40-42kW (54-57PS)
Ronda 1.7 Diesel			06/82→12/86		Diesel	TD9391
08-215100-10	STD	83.00	2.500		008 MOL P	KV1
08-215108-10	0.60mm		2.000		026 P	STD
08-215110-10	0.80mm		4.000		231 CR P	STD
<i>[R47000]</i>						
131 2.0			06/78→12/85	131 C4.000		
					4cyl.	
					1995cc	83-85kW (113-116PS)
						TD21375
				132 B1.000		
					4cyl.	
					1756cc	77-82kW (105-112PS)
						TD21376
08-207600-00	STD	84.00	1.500		001 IF CR P	IKA
08-207604-00	0.20mm		2.000		026 P	STD
08-207606-00	0.40mm		3.947		712 CR	ST
08-207608-00	0.60mm					
<i>[R28906]</i>						
08-215300-10	STD	84.00	1.500		001 IF CR P	KV1
08-215306-10	0.40mm		2.000		026 P	STD
08-215308-10	0.60mm		3.947		232 P	STD
<i>[R46970]</i>						



132 2.2 D	05/79→12/82	OM 615.912		33
			4cyl. 2197cc 44kW (60PS)	
		Diesel		TD21374

08-170600-10	STD	87.00	3.000		001 IW MOL P	KV1	
08-170607-10	0.50mm					001 IF P	F12/F14
08-170611-10	1.00mm					231 CR P	STD
10/1967→08/1973			4.000				
08-170700-10	STD	87.00	2.000		001 IF CR P	KV1	
08-170707-10	0.50mm					001 IF P	F12/F14
08-170711-10	1.00mm					231 CR P	STD
09/1973→12/1985						4.000	
[R66580]							

131 2.4 Diesel	06/78→12/86	8144.61		34
			4cyl. 2445cc 53kW (72PS)	
		Diesel		TD3597

08-214400-10	STD	93.00	2.000		001 CR P	KV1	
[R60960]						005 IF P	STD
						231 CR P	STD
4.000							
08-214500-10	STD	93.00	3.000		001 CR P	KV1	
08-214508-10	0.60mm					005 IF P	STD
[R47010]						231 CR P	STD
					4.000		



CCM

x



9

08/76→08/83	105	742.10	Petrol	1046	4	1
08/76→12/90	105	742.10	Petrol	1046	4	1
10/83→12/90	105	742.10	Petrol	1046	4	1
02/83→12/90	105	742.12 X	Petrol	1174	4	3
08/76→12/90	105	742.12 X	Petrol	1174	4	3
08/76→08/83	120 1.0 105 S, L	742.10	Petrol	1046	4	1
08/76→12/90	120 1.0 105 S, L, GL	742.10	Petrol	1046	4	1
10/83→12/90	120 1.0 105 S, L, LS	742.10	Petrol	1046	4	1
02/83→12/90	120 1.2 120 GLS	742.12 X	Petrol	1174	4	3
08/76→12/90	120 1.2 120 LS	742.12 X	Petrol	1174	4	3
05/88→10/91	130 GL	135/8	Petrol	1280	4	4
02/85→10/91	130 L, GL	742.13	Petrol	1280	4	4
01/67→	1100MB Deluxe	1100MB	Petrol	1107	4	2
01/67→12/77	1100MB Mk II	1100MB	Petrol	1107	4	2
01/03→03/08	Fabia 1.2	AZQ	Petrol	1198	3	6
05/10→	Fabia 1.2 TDI	CFWA	Diesel	1199	3	17
01/07→	Fabia 1.4	BXW	Petrol	1390	4	9
01/07→	Fabia 1.4	CDDA	Petrol	1390	4	9
01/07→	Fabia 1.4	CGGB	Petrol	1390	4	9
12/99→03/08	Fabia 1.4 16V	AUA	Petrol	1390	4	7
12/99→03/08	Fabia 1.4 16V	AUB	Petrol	1390	4	7
12/99→03/08	Fabia 1.4 16V	BBY	Petrol	1390	4	7
12/99→03/08	Fabia 1.4 16V	BBZ	Petrol	1390	4	7
12/99→03/08	Fabia 1.4 16V	BKY	Petrol	1390	4	9
04/03→03/08	Fabia 1.4 TDI	AMF	Diesel	1422	3	14
01/07→	Fabia 1.4 TDI	BMS	Diesel	1422	3	14
10/05→	Fabia 1.4 TDI	BNM	Diesel	1422	3	14
10/05→	Fabia 1.4 TDI	BNV	Diesel	1422	3	14
05/10→	Fabia 1.4 TSI	CAVE	Petrol	1390	4	11
05/10→	Fabia 1.4 TSI	CTHE	Petrol	1390	4	11
04/10→	Fabia 1.6 TDI	CAYA	Diesel	1598	4	17
03/10→	Fabia 1.6 TDI	CAYB	Diesel	1598	4	17
03/10→	Fabia 1.6 TDI	CAYC	Diesel	1598	4	17
03/10→	Fabia 1.6 TDI	CLNA	Diesel	1598	4	17
12/99→03/08	Fabia 1.9 SDI	ASY	Diesel	1896	4	14
01/00→03/08	Fabia 1.9 TDI	ATD	Diesel	1896	4	14
01/00→03/08	Fabia 1.9 TDI	AXR	Diesel	1896	4	14
04/07→	Fabia 1.9 TDI	BLS	Diesel	1896	4	15
04/07→	Fabia 1.9 TDI	BSW	Diesel	1896	4	15
06/03→03/08	Fabia 1.9 TDI RS	ASZ	Diesel	1896	4	14
06/03→03/08	Fabia 1.9 TDI RS	BLT	Diesel	1896	4	15
12/99→03/08	Fabia 2.0	AQY	Petrol	1984	4	23
12/99→03/08	Fabia 2.0	AZL	Petrol	1984	4	23
01/03→12/07	Fabia Combi 1.2	AZQ	Petrol	1198	3	6
05/10→	Fabia Combi 1.2 TDI	CFWA	Diesel	1199	3	17
10/07→	Fabia Combi 1.4	BXW	Petrol	1390	4	9
10/07→	Fabia Combi 1.4	CDDA	Petrol	1390	4	9
10/07→	Fabia Combi 1.4	CGGB	Petrol	1390	4	9
05/00→12/07	Fabia Combi 1.4 16V	AUA	Petrol	1390	4	7
04/00→12/07	Fabia Combi 1.4 16V	AUB	Petrol	1390	4	7
05/00→12/07	Fabia Combi 1.4 16V	BBY	Petrol	1390	4	7
04/00→12/07	Fabia Combi 1.4 16V	BBZ	Petrol	1390	4	7
05/00→12/07	Fabia Combi 1.4 16V	BKY	Petrol	1390	4	9
04/06→12/07	Fabia Combi 1.4 16V	BUD	Petrol	1390	4	9
04/03→12/07	Fabia Combi 1.4 TDI	AMF	Diesel	1422	3	14
10/07→	Fabia Combi 1.4 TDI	BMS	Diesel	1422	3	14
10/05→	Fabia Combi 1.4 TDI	BNM	Diesel	1422	3	14
10/05→	Fabia Combi 1.4 TDI	BNV	Diesel	1422	3	14
05/10→	Fabia Combi 1.4 TSI	CAVE	Petrol	1390	4	11
05/10→	Fabia Combi 1.4 TSI	CTHE	Petrol	1390	4	11

MODEL INDEX

 Modelverzeichnis • Index de modele • Índice de Modelo
 Indeks modelu • Модель автомобиля • دليل الموديل

CCM
x

9

04/10→	Fabia Combi 1.6 TDI	CAYA	Diesel	1598	4	17
03/10→	Fabia Combi 1.6 TDI	CAYB	Diesel	1598	4	17
03/10→	Fabia Combi 1.6 TDI	CAYC	Diesel	1598	4	17
04/00→12/07	Fabia Combi 1.9 SDI	ASY	Diesel	1896	4	14
04/00→12/07	Fabia Combi 1.9 TDI	ATD	Diesel	1896	4	14
04/00→12/07	Fabia Combi 1.9 TDI	AXR	Diesel	1896	4	14
10/07→	Fabia Combi 1.9 TDI	BLS	Diesel	1896	4	15
10/07→	Fabia Combi 1.9 TDI	BSW	Diesel	1896	4	15
04/00→12/07	Fabia Combi 2.0	AZL	Petrol	1984	4	23
	Fabia I	CLPA	Petrol	1390	4	9
01/03→12/07	Fabia Praktik 1.2	AZQ	Petrol	1198	3	6
10/05→12/07	Fabia Praktik 1.4 TDI	BNM	Diesel	1422	3	14
07/01→12/07	Fabia Praktik 1.9 SDI	ASY	Diesel	1896	4	14
01/03→12/07	Fabia Saloon 1.2	AZQ	Petrol	1198	3	6
10/99→12/07	Fabia Saloon 1.4 16V	AUA	Petrol	1390	4	7
12/99→12/07	Fabia Saloon 1.4 16V	AUB	Petrol	1390	4	7
10/99→12/07	Fabia Saloon 1.4 16V	BBY	Petrol	1390	4	7
12/99→12/07	Fabia Saloon 1.4 16V	BBZ	Petrol	1390	4	7
10/99→12/07	Fabia Saloon 1.4 16V	BKY	Petrol	1390	4	9
04/06→12/07	Fabia Saloon 1.4 16V	BUD	Petrol	1390	4	9
04/03→12/07	Fabia Saloon 1.4 TDI	AMF	Diesel	1422	3	14
10/05→12/07	Fabia Saloon 1.4 TDI	BNM	Diesel	1422	3	14
10/05→12/07	Fabia Saloon 1.4 TDI	BNV	Diesel	1422	3	14
11/99→12/07	Fabia Saloon 1.9 SDI	ASY	Diesel	1896	4	14
01/00→12/07	Fabia Saloon 1.9 TDI	ATD	Diesel	1896	4	14
01/00→12/07	Fabia Saloon 1.9 TDI	AXR	Diesel	1896	4	14
12/99→12/07	Fabia Saloon 2.0	AZL	Petrol	1984	4	23
01/94→09/94	Favorit 1.3	136B	Petrol	1289	4	5
10/90→09/94	Favorit 1.3 135	781.135	Petrol	1289	4	5
01/90→09/94	Favorit 1.3 135 X, LX, GLX	781.135E	Petrol	1289	4	5
05/89→09/94	Favorit 1.3 135L	781.135	Petrol	1289	4	5
01/94→06/95	Favorit Forman 1.3	136B	Petrol	1289	4	5
12/91→06/95	Favorit Forman 1.3	781.135	Petrol	1289	4	5
09/91→06/95	Favorit Forman 1.3	781.135E	Petrol	1289	4	5
12/92→06/97	Favorit Pickup 1.3	136B	Petrol	1289	4	5
12/92→06/97	Favorit Pickup 1.3	781.135	Petrol	1289	4	5
10/94→03/98	Felicia I 1.3	136B	Petrol	1289	4	5
10/94→03/98	Felicia I 1.3	AMG	Petrol	1289	4	5
08/95→03/98	Felicia I 1.6 LX	AEE	Petrol	1598	4	6
10/95→03/98	Felicia I 1.9 D	AEF	Diesel	1896	4	13
08/95→03/98	Felicia I Estate 1.3 LX	AMG	Petrol	1289	4	5
08/95→03/98	Felicia I Estate 1.3 LXI	136B	Petrol	1289	4	5
08/95→03/98	Felicia I Estate 1.6 GLX	AEE	Petrol	1598	4	6
10/95→03/98	Felicia I Estate 1.9 D	AEF	Diesel	1896	4	13
06/97→04/02	Felicia I Fun 1.3	136B	Petrol	1289	4	5
06/97→04/02	Felicia I Fun 1.6	AEE	Petrol	1598	4	6
06/97→04/02	Felicia I Fun 1.9 D	AEF	Diesel	1896	4	13
01/98→06/01	Felicia II 1.3	AMG	Petrol	1289	4	5
01/98→06/01	Felicia II 1.6	AEE	Petrol	1598	4	6
01/98→06/01	Felicia II 1.9 D	AEF	Diesel	1896	4	13
01/98→06/01	Felicia II Estate 1.6	AEE	Petrol	1598	4	6
01/98→06/01	Felicia II Estate 1.9 D	AEF	Diesel	1896	4	13
05/04→05/06	Octavia 1.4	BCA	Petrol	1390	4	8
06/04→	Octavia 1.4	BUD	Petrol	1390	4	9
06/04→	Octavia 1.4	CGGA	Petrol	1390	4	9
09/00→12/10	Octavia 1.4 16V	AXP	Petrol	1390	4	7
09/00→12/10	Octavia 1.4 16V	BCA	Petrol	1390	4	8
11/08→	Octavia 1.4 TSI	CAXA	Petrol	1390	4	10
09/96→09/04	Octavia 1.6	AEE	Petrol	1598	4	6
02/97→12/07	Octavia 1.6	AEH	Petrol	1595	4	19



CCM

x



9

02/97→12/07	Octavia 1.6	AKL	Petrol	1595	4	19
11/00→12/10	Octavia 1.6	AVU	Petrol	1595	4	20
11/00→12/10	Octavia 1.6	BFQ	Petrol	1595	4	20
06/04→	Octavia 1.6	BGU	Petrol	1595	4	20
06/04→	Octavia 1.6	BSE	Petrol	1595	4	20
06/04→	Octavia 1.6	BSF	Petrol	1595	4	20
06/04→	Octavia 1.6	CCSA	Petrol	1595	4	20
02/04→10/08	Octavia 1.6 FSI	BLF	Petrol	1598	4	10
01/08→	Octavia 1.6 MultiFuel	CCSA	Petrol	1595	4	20
06/09→	Octavia 1.6 TDI	CAYC	Diesel	1598	4	17
	Octavia 1.8	ADR	Petrol	1781	4	18
09/96→07/00	Octavia 1.8	AGN	Petrol	1781	4	18
08/97→12/10	Octavia 1.8 T	AGU	Petrol	1781	4	18
08/97→12/10	Octavia 1.8 T	ARX	Petrol	1781	4	18
08/97→12/10	Octavia 1.8 T	ARZ	Petrol	1781	4	18
08/97→12/10	Octavia 1.8 T	AUM	Petrol	1781	4	18
05/01→05/06	Octavia 1.8 T 4x4	ARX	Petrol	1781	4	18
	Octavia 1.9 SDI	AEY	Diesel	1896	4	14
06/97→12/03	Octavia 1.9 SDI	AGP	Diesel	1896	4	14
06/97→12/03	Octavia 1.9 SDI	AQM	Diesel	1896	4	14
09/96→03/10	Octavia 1.9 TDI	AGR	Diesel	1896	4	14
08/97→01/06	Octavia 1.9 TDI	AHF	Diesel	1896	4	14
09/96→03/10	Octavia 1.9 TDI	ALH	Diesel	1896	4	14
08/97→01/06	Octavia 1.9 TDI	ASV	Diesel	1896	4	14
09/02→09/04	Octavia 1.9 TDI	ASZ	Diesel	1896	4	14
10/05→12/10	Octavia 1.9 TDI	AXR	Diesel	1896	4	14
06/04→12/10	Octavia 1.9 TDI	BJB	Diesel	1896	4	15
06/04→12/10	Octavia 1.9 TDI	BKC	Diesel	1896	4	15
06/04→12/10	Octavia 1.9 TDI	BLS	Diesel	1896	4	15
06/04→12/10	Octavia 1.9 TDI	BXE	Diesel	1896	4	15
04/99→05/07	Octavia 2.0	AEG	Petrol	1984	4	23
04/99→05/07	Octavia 2.0	APK	Petrol	1984	4	23
04/99→05/07	Octavia 2.0	AQY	Petrol	1984	4	23
04/99→05/07	Octavia 2.0	AZH	Petrol	1984	4	23
04/99→05/07	Octavia 2.0	AZJ	Petrol	1984	4	23
11/04→	Octavia 2.0 FSI	BLR	Petrol	1984	4	24
11/04→	Octavia 2.0 FSI	BLY	Petrol	1984	4	24
11/04→	Octavia 2.0 FSI	BVY	Petrol	1984	4	24
11/04→	Octavia 2.0 FSI	BVZ	Petrol	1984	4	24
10/05→	Octavia 2.0 RS	BWA	Petrol	1984	4	24
02/04→05/10	Octavia 2.0 TDI	AZV	Diesel	1968	4	21
11/05→	Octavia 2.0 TDI	BMM	Diesel	1968	4	21
03/10→	Octavia 2.0 TDI	CFHF	Diesel	1968	4	22
03/10→	Octavia 2.0 TDI	CLCA	Diesel	1968	4	22
02/04→	Octavia 2.0 TDI 16V	BKD	Diesel	1968	4	21
02/04→	Octavia 2.0 TDI 16V	CFHC	Diesel	1968	4	22
02/04→	Octavia 2.0 TDI 16V	CLCB	Diesel	1968	4	22
04/06→	Octavia 2.0 TDI RS	BMN	Diesel	1968	4	21
04/06→	Octavia 2.0 TDI RS	CEGA	Diesel	1968	4	22
05/04→05/06	Octavia Combi 1.4	BCA	Petrol	1390	4	8
05/06→	Octavia Combi 1.4	BUD	Petrol	1390	4	9
05/06→	Octavia Combi 1.4	CGGA	Petrol	1390	4	9
08/00→12/10	Octavia Combi 1.4 16V	AXP	Petrol	1390	4	7
08/00→12/10	Octavia Combi 1.4 16V	BCA	Petrol	1390	4	8
11/08→	Octavia Combi 1.4 TSI	CAXA	Petrol	1390	4	10
07/98→09/04	Octavia Combi 1.6	AEE	Petrol	1598	4	6
07/98→12/07	Octavia Combi 1.6	AEH	Petrol	1595	4	19
07/98→12/07	Octavia Combi 1.6	AKL	Petrol	1595	4	19
09/00→12/10	Octavia Combi 1.6	AVU	Petrol	1595	4	20
09/00→12/10	Octavia Combi 1.6	BFQ	Petrol	1595	4	20

MODEL INDEX

 Modelverzeichnis • Index de modele • Índice de Modelo
 Indeks modelu • Модель автомобиля • دليل الموديل

CCM
x

9

09/04→	Octavia Combi 1.6	BGU	Petrol	1595	4	20
09/04→	Octavia Combi 1.6	BSE	Petrol	1595	4	20
09/04→	Octavia Combi 1.6	BSF	Petrol	1595	4	20
09/04→	Octavia Combi 1.6	CCSA	Petrol	1595	4	20
02/04→10/08	Octavia Combi 1.6 FSI	BLF	Petrol	1598	4	10
01/08→	Octavia Combi 1.6 MultiFuel	CCSA	Petrol	1595	4	20
06/09→	Octavia Combi 1.6 TDI	CAYC	Diesel	1598	4	17
06/09→	Octavia Combi 1.6 TDI 4x4	CAYC	Diesel	1598	4	17
07/98→07/00	Octavia Combi 1.8 20V	AGN	Petrol	1781	4	18
07/98→12/10	Octavia Combi 1.8 T	AGU	Petrol	1781	4	18
07/98→12/10	Octavia Combi 1.8 T	ARX	Petrol	1781	4	18
07/98→12/10	Octavia Combi 1.8 T	ARZ	Petrol	1781	4	18
07/98→12/10	Octavia Combi 1.8 T	AUM	Petrol	1781	4	18
05/01→05/06	Octavia Combi 1.8 T 4x4	ARX	Petrol	1781	4	18
07/98→12/03	Octavia Combi 1.9 SDI	AGP	Diesel	1896	4	14
07/98→12/03	Octavia Combi 1.9 SDI	AQM	Diesel	1896	4	14
07/98→03/10	Octavia Combi 1.9 TDI	AGR	Diesel	1896	4	14
07/98→01/06	Octavia Combi 1.9 TDI	AHF	Diesel	1896	4	14
07/98→03/10	Octavia Combi 1.9 TDI	ALH	Diesel	1896	4	14
07/98→01/06	Octavia Combi 1.9 TDI	ASV	Diesel	1896	4	14
09/02→09/04	Octavia Combi 1.9 TDI	ASZ	Diesel	1896	4	14
08/00→12/10	Octavia Combi 1.9 TDI	ATD	Diesel	1896	4	14
08/00→12/10	Octavia Combi 1.9 TDI	AXR	Diesel	1896	4	14
09/04→12/10	Octavia Combi 1.9 TDI	BJB	Diesel	1896	4	15
09/04→12/10	Octavia Combi 1.9 TDI	BKC	Diesel	1896	4	15
09/04→12/10	Octavia Combi 1.9 TDI	BLS	Diesel	1896	4	15
09/04→12/10	Octavia Combi 1.9 TDI	BXE	Diesel	1896	4	15
11/99→02/06	Octavia Combi 1.9 TDI 4x4	AGR	Diesel	1896	4	14
09/00→01/06	Octavia Combi 1.9 TDI 4x4	ATD	Diesel	1896	4	14
11/04→12/10	Octavia Combi 1.9 TDI 4x4	BKC	Diesel	1896	4	15
11/04→12/10	Octavia Combi 1.9 TDI 4x4	BLS	Diesel	1896	4	15
11/04→12/10	Octavia Combi 1.9 TDI 4x4	BXE	Diesel	1896	4	15
04/99→05/07	Octavia Combi 2.0	AEG	Petrol	1984	4	23
04/99→05/07	Octavia Combi 2.0	APK	Petrol	1984	4	23
04/99→05/07	Octavia Combi 2.0	AQY	Petrol	1984	4	23
04/99→05/07	Octavia Combi 2.0	AZH	Petrol	1984	4	23
04/99→05/07	Octavia Combi 2.0	AZJ	Petrol	1984	4	23
08/00→09/04	Octavia Combi 2.0 4x4	AZH	Petrol	1984	4	23
08/00→09/04	Octavia Combi 2.0 4x4	AZJ	Petrol	1984	4	23
11/04→	Octavia Combi 2.0 FSI	BLR	Petrol	1984	4	24
11/04→	Octavia Combi 2.0 FSI	BLY	Petrol	1984	4	24
11/04→	Octavia Combi 2.0 FSI	BVY	Petrol	1984	4	24
11/04→	Octavia Combi 2.0 FSI	BVZ	Petrol	1984	4	24
11/04→	Octavia Combi 2.0 FSI 4x4	BLX	Petrol	1984	4	24
11/04→	Octavia Combi 2.0 FSI 4x4	BVX	Petrol	1984	4	24
10/05→	Octavia Combi 2.0 RS	BWA	Petrol	1984	4	24
11/05→	Octavia Combi 2.0 TDI	BMM	Diesel	1968	4	21
03/10→	Octavia Combi 2.0 TDI	CFHF	Diesel	1968	4	22
03/10→	Octavia Combi 2.0 TDI	CLCA	Diesel	1968	4	22
02/04→05/10	Octavia Combi 2.0 TDI 16V	AZV	Diesel	1968	4	21
02/04→	Octavia Combi 2.0 TDI 16V	BKD	Diesel	1968	4	21
02/04→	Octavia Combi 2.0 TDI 16V	CFHC	Diesel	1968	4	22
02/04→	Octavia Combi 2.0 TDI 16V	CLCB	Diesel	1968	4	22
05/10→	Octavia Combi 2.0 TDI 16V 4x4	CFHC	Diesel	1968	4	22
07/06→	Octavia Combi 2.0 TDI 4x4	BMM	Diesel	1968	4	21
05/11→	Octavia Combi 2.0 TDI 4x4	CFHF	Diesel	1968	4	22
04/06→	Octavia Combi 2.0 TDI RS	BMN	Diesel	1968	4	21
04/06→	Octavia Combi 2.0 TDI RS	CEGA	Diesel	1968	4	22
08/02→01/06	Octavia Combi RS 1.8 T	AUQ	Petrol	1781	4	18
05/01→01/06	Octavia RS 1.8 T	AUQ	Petrol	1781	4	18

CCM
x

9

03/85→08/88	Rapid 1.3	742.13	Petrol	1280	4	4
09/84→12/90	Rapid 1.3 S	135/8	Petrol	1280	4	4
07/12→	Rapid 1.4 TSI	CAXA	Petrol	1390	4	10
08/13→	Rapid 1.6 TDI	CAYB	Diesel	1598	4	17
07/12→	Rapid 1.6 TDI	CAYC	Diesel	1598	4	17
03/10→	Roomster 1.2 TDI	CFWA	Diesel	1199	3	17
09/06→	Roomster 1.4	BXW	Petrol	1390	4	9
09/06→	Roomster 1.4	CDDA	Petrol	1390	4	9
09/06→	Roomster 1.4	CGGB	Petrol	1390	4	9
09/06→03/10	Roomster 1.4 TDI	BMS	Diesel	1422	3	14
07/06→03/10	Roomster 1.4 TDI	BNM	Diesel	1422	3	14
09/06→03/10	Roomster 1.4 TDI	BNV	Diesel	1422	3	14
03/10→	Roomster 1.6 TDI	CAYB	Diesel	1598	4	17
03/10→	Roomster 1.6 TDI	CAYC	Diesel	1598	4	17
03/06→05/06	Roomster 1.9 TDI	AXR	Diesel	1896	4	14
09/06→03/10	Roomster 1.9 TDI	BLS	Diesel	1896	4	15
09/06→03/10	Roomster 1.9 TDI	BSW	Diesel	1896	4	15
03/10→	Roomster Praktik 1.2 TDI	CFWA	Diesel	1199	3	17
03/07→	Roomster Praktik 1.4	BXW	Petrol	1390	4	9
03/07→	Roomster Praktik 1.4	CGGB	Petrol	1390	4	9
03/07→03/10	Roomster Praktik 1.4 TDI	BMS	Diesel	1422	3	14
03/07→03/10	Roomster Praktik 1.4 TDI	BNM	Diesel	1422	3	14
03/07→03/10	Roomster Praktik 1.4 TDI	BNV	Diesel	1422	3	14
03/10→	Roomster Praktik 1.6 TDI	CAYB	Diesel	1598	4	17
01/65→12/71	S100	1000MB	Petrol	988	4	1
01/65→12/71	S100 L	1000MB	Petrol	988	4	1
01/69→12/77	S110 LS	1100MB	Petrol	1107	4	2
01/69→12/77	S110 R	1100MB	Petrol	1107	4	2
01/69→12/77	S110L	1100MB	Petrol	1107	4	2
01/67→12/81	S120 Rapid	1200MB	Petrol	1174	4	3
07/08→	Superb 1.4 TSI	CAXC	Petrol	1390	4	10
09/10→	Superb 1.6 TDI	CAYC	Diesel	1598	4	17
12/01→03/08	Superb 1.8 T	AWT	Petrol	1781	4	18
08/02→10/05	Superb 1.9 TDI	AVB	Diesel	1896	4	14
12/01→03/08	Superb 1.9 TDI	AVF	Diesel	1896	4	14
12/01→03/08	Superb 1.9 TDI	AWX	Diesel	1896	4	14
03/08→	Superb 1.9 TDI	BLS	Diesel	1896	4	15
01/07→03/08	Superb 1.9 TDI	BPZ	Diesel	1896	4	16
10/05→05/07	Superb 1.9 TDI	BSV	Diesel	1896	4	16
03/08→	Superb 1.9 TDI	BXE	Diesel	1896	4	15
12/01→03/08	Superb 2.0	AZM	Petrol	1984	4	23
03/08→	Superb 2.0 TDI	BMP	Diesel	1968	4	21
10/05→03/08	Superb 2.0 TDI	BSS	Diesel	1968	4	21
07/08→	Superb 2.0 TDI	CBBB	Diesel	1968	4	22
07/08→	Superb 2.0 TDI	CFGB	Diesel	1968	4	22
01/09→	Superb 2.0 TDI 16V	BKD	Diesel	1968	4	21
01/09→	Superb 2.0 TDI 16V	CFFB	Diesel	1968	4	22
01/09→	Superb 2.0 TDI 16V	CLJA	Diesel	1968	4	22
11/10→	Superb 2.0 TDI 16V 4x4	CFFB	Diesel	1968	4	22
09/08→	Superb 2.0 TDI 4x4	CBBB	Diesel	1968	4	22
09/08→	Superb 2.0 TDI 4x4	CFGB	Diesel	1968	4	22
12/01→08/03	Superb 2.5 TDI	AYM	Diesel	2496	V6	12
06/03→03/08	Superb 2.5 TDI	BDG	Diesel	2496	V6	12
12/01→03/08	Superb 2.8 V6	AMX	Petrol	2771	V6	23
06/02→03/08	Superb 2.8 V6	BBG	Petrol	2771	V6	23
10/09→	Superb Estate 1.4 TSI	CAXC	Petrol	1390	4	10
09/10→	Superb Estate 1.6 TDI	CAYC	Diesel	1598	4	17
10/09→11/10	Superb Estate 1.9 TDI	BLS	Diesel	1896	4	15
10/09→11/10	Superb Estate 1.9 TDI	BXE	Diesel	1896	4	15
10/09→03/10	Superb Estate 2.0 TDI	BMP	Diesel	1968	4	21

MODEL INDEX

Modelverzeichnis • Index de modele • Índice de Modelo
Indeks modelu • Модель автомобиля • دليل الموديل



CCM

x



9

10/09→	Superb Estate 2.0 TDI	CBBB	Diesel	1968	4	22
10/09→	Superb Estate 2.0 TDI	CFGB	Diesel	1968	4	22
10/09→	Superb Estate 2.0 TDI 16V	BKD	Diesel	1968	4	21
10/09→	Superb Estate 2.0 TDI 16V	CFFB	Diesel	1968	4	22
10/09→	Superb Estate 2.0 TDI 16V	CLJA	Diesel	1968	4	22
11/10→	Superb Estate 2.0 TDI 16V 4x4	CFFB	Diesel	1968	4	22
10/09→	Superb Estate 2.0 TDI 4x4	CBBB	Diesel	1968	4	22
10/09→	Superb Estate 2.0 TDI 4x4	CFGB	Diesel	1968	4	22
06/10→	Yeti 1.4 TSI	CAXA	Petrol	1390	4	10
11/10→	Yeti 1.6 TDI	CAYC	Diesel	1598	4	17
11/09→	Yeti 2.0 TDI	CFHA	Diesel	1968	4	22
11/11→	Yeti 2.0 TDI	CFHC	Diesel	1968	4	22
11/09→	Yeti 2.0 TDI	CLCA	Diesel	1968	4	22
05/09→	Yeti 2.0 TDI 4x4	CBDB	Diesel	1968	4	22
11/09→	Yeti 2.0 TDI 4x4	CEGA	Diesel	1968	4	22
05/09→	Yeti 2.0 TDI 4x4	CFHC	Diesel	1968	4	22
11/09→	Yeti 2.0 TDI 4x4	CFHF	Diesel	1968	4	22
11/09→	Yeti 2.0 TDI 4x4	CFJA	Diesel	1968	4	22
05/09→	Yeti 2.0 TDI 4x4	CLCB	Diesel	1968	4	22

Motorverzeichnis • Index de moteur • Índice de Motor
Indeks silnika • Модель двигателя • دليل المحرك

ENGINE INDEX



CCM



9

135/8	Petrol	1280	4	75.50	4
136B	Petrol	1289	4	75.50	5
742.10	Petrol	1046	4	68.00	1
742.12 X	Petrol	1174	4	72.00	3
742.13	Petrol	1280	4	75.50	4
781.135	Petrol	1289	4	75.50	5
781.135E	Petrol	1289	4	75.50	5
1000MB	Petrol	988	4	68.00	1
1100MB	Petrol	1107	4	72.00	2
1200MB	Petrol	1174	4	72.00	3
ADR	Petrol	1781	4	81.00	18
AEE	Petrol	1598	4	76.50	6
AEF	Diesel	1896	4	79.50	13
AEG	Petrol	1984	4	82.50	23
AEH	Petrol	1595	4	81.00	19
AEY	Diesel	1896	4	79.50	14
AGN	Petrol	1781	4	81.00	18
AGP	Diesel	1896	4	79.50	14
AGR	Diesel	1896	4	79.50	14
AGU	Petrol	1781	4	81.00	18
AHF	Diesel	1896	4	79.50	14
AKL	Petrol	1595	4	81.00	19
ALH	Diesel	1896	4	79.50	14
AMF	Diesel	1422	3	79.50	14
AMG	Petrol	1289	4	75.50	5
AMX	Petrol	2771	V6	82.50	23
APK	Petrol	1984	4	82.50	23
AQM	Diesel	1896	4	79.50	14
AQY	Petrol	1984	4	82.50	23
ARX	Petrol	1781	4	81.00	18
ARZ	Petrol	1781	4	81.00	18
ASV	Diesel	1896	4	79.50	14
ASY	Diesel	1896	4	79.50	14
ASZ	Diesel	1896	4	79.50	14
ATD	Diesel	1896	4	79.50	14
AUA	Petrol	1390	4	76.50	7
AUB	Petrol	1390	4	76.50	7
AUM	Petrol	1781	4	81.00	18
AUQ	Petrol	1781	4	81.00	18
AVB	Diesel	1896	4	79.50	14
AVF	Diesel	1896	4	79.50	14
AVU	Petrol	1595	4	81.00	20
AWT	Petrol	1781	4	81.00	18
AWX	Diesel	1896	4	79.50	14
AXP	Petrol	1390	4	76.50	7
AXR	Diesel	1896	4	79.50	14
AYM	Diesel	2496	V6	78.30	12
AZH	Petrol	1984	4	82.50	23
AZJ	Petrol	1984	4	82.50	23
AZL	Petrol	1984	4	82.50	23
AZM	Petrol	1984	4	82.50	23
AZQ	Petrol	1198	3	76.50	6
AZV	Diesel	1968	4	81.00	21
BBG	Petrol	2771	V6	82.50	23
BBY	Petrol	1390	4	76.50	7
BBZ	Petrol	1390	4	76.50	7
BCA	Petrol	1390	4	76.50	8
BDG	Diesel	2496	V6	78.30	12
BFQ	Petrol	1595	4	81.00	20
BGU	Petrol	1595	4	81.00	20

ENGINE INDEX

Motorverzeichnis • Index de moteur • Índice de Motor
Indeks silnika • Модель двигателя • دليل المحرك



CCM



9

BJB	Diesel	1896	4	79.50	15
BKC	Diesel	1896	4	79.50	15
BKD	Diesel	1968	4	81.00	21
BKY	Petrol	1390	4	76.50	9
BLF	Petrol	1598	4	76.50	10
BLR	Petrol	1984	4	82.50	24
BLS	Diesel	1896	4	79.50	15
BLT	Diesel	1896	4	79.50	15
BLX	Petrol	1984	4	82.50	24
BLY	Petrol	1984	4	82.50	24
BMM	Diesel	1968	4	81.00	21
BMN	Diesel	1968	4	81.00	21
BMP	Diesel	1968	4	81.00	21
BMS	Diesel	1422	3	79.50	14
BNM	Diesel	1422	3	79.50	14
BNV	Diesel	1422	3	79.50	14
BPZ	Diesel	1896	4	79.50	16
BSE	Petrol	1595	4	81.00	20
BSF	Petrol	1595	4	81.00	20
BSS	Diesel	1968	4	81.00	21
BSV	Diesel	1896	4	79.50	16
BSW	Diesel	1896	4	79.50	15
BUD	Petrol	1390	4	76.50	9
BVX	Petrol	1984	4	82.50	24
BVY	Petrol	1984	4	82.50	24
BVZ	Petrol	1984	4	82.50	24
BWA	Petrol	1984	4	82.50	24
BXE	Diesel	1896	4	79.50	15
BXW	Petrol	1390	4	76.50	9
CAVE	Petrol	1390	4	76.50	11
CAXA	Petrol	1390	4	76.50	10
CAXC	Petrol	1390	4	76.50	10
CAYA	Diesel	1598	4	79.50	17
CAYB	Diesel	1598	4	79.50	17
CAYC	Diesel	1598	4	79.50	17
CBBB	Diesel	1968	4	81.00	22
CBDB	Diesel	1968	4	81.00	22
CCSA	Petrol	1595	4	81.00	20
CDDA	Petrol	1390	4	76.50	9
CEGA	Diesel	1968	4	81.00	22
CFFB	Diesel	1968	4	81.00	22
CFGB	Diesel	1968	4	81.00	22
CFHA	Diesel	1968	4	81.00	22
CFHC	Diesel	1968	4	81.00	22
CFHF	Diesel	1968	4	81.00	22
CFJA	Diesel	1968	4	81.00	22
CFWA	Diesel	1199	3	79.50	17
CGGA	Petrol	1390	4	76.50	9
CGGB	Petrol	1390	4	76.50	9
CLCA	Diesel	1968	4	81.00	22
CLCB	Diesel	1968	4	81.00	22
CLJA	Diesel	1968	4	81.00	22
CLNA	Diesel	1598	4	79.50	17
CLPA	Petrol	1390	4	76.50	9
CTHE	Petrol	1390	4	76.50	11



S100, S100 L	01/65→12/71	1000MB	4cyl. 988cc	1
FM2091				

105, 120 1.0 105 S, L	08/76→12/90	742.10	4cyl.	32-34kW (44-46PS)	TD3608
105, 120 1.0 105 S, L, GL	08/76→08/83		1046cc		
105, 120 1.0 105 S, L, LS	10/83→12/90				

08-348700-00	STD	68.00	2.000		005 IF P	IKA
			2.000		026 P	STD
			4.000		712 CR	ST

1100MB Deluxe	01/67→	1100MB	4cyl.	2
1100MB Mk II	01/67→12/77		1107cc	FM2095
S110 LS, S110 R, S110L	01/69→12/77			

08-344800-00	STD	72.00	2.000		001 IF CR P	IKA
			2.000		026 P	STD
			2.000		026 P	STD
			4.000		236 P	STD

S120 Rapid	01/67→12/81	1200MB	4cyl. 1174cc	3
FM1605				

105, 120 1.2 120 GLS	02/83→12/90	742.12 X	4cyl.	43kW (58PS)	TD5346
105, 120 1.2 120 LS	08/76→12/90		1174cc		

08-348600-00	STD	72.00	2.000		001 IF CR P	IKA
			2.000		026 P	STD
			4.000		236 P	STD

130 GL	05/88→10/91	135/8	4cyl.	4	
Rapid 1.3 S	09/84→12/90		1280cc	43kW (58PS)	TD5348

130 L, GL	02/85→10/91	742.13	4cyl.	45kW (61PS)	TD4900
Rapid 1.3	03/85→08/88		1280cc		

08-349700-00	STD	75.50	2.000		001 IF CR P	IKA
01/1985→12/1988			2.000		026 P	STD
			4.000		712 CR	ST



Favorit 1.3		01/94→09/94	136B				5
Favorit Forman 1.3		01/94→06/95		4cyl.			
Favorit Pickup 1.3		12/92→06/97		1289cc	50kW (68PS)		
Felicia I 1.3		10/94→03/98					
Felicia I Estate 1.3 LXI		08/95→03/98					
Felicia I Fun 1.3		06/97→04/02					TD13390
Favorit 1.3 135		10/90→09/94	781.135				TD5347
Favorit 1.3 135L		05/89→09/94		4cyl.			
Favorit Forman 1.3		12/91→06/95		1289cc	40-50kW (54-68PS)		
Favorit Pickup 1.3		12/92→06/97					
Favorit 1.3 135 X, LX, GLX		01/90→09/94	781.135E				TD13389
Favorit Forman 1.3		09/91→06/95		4cyl.			
				1289cc	40-50kW (54-68PS)		
Felicia I 1.3		10/94→03/98	AMG				TD13828
Felicia I Estate 1.3 LX		08/95→03/98		4cyl.			
Felicia II 1.3		01/98→06/01		1289cc	40kW (54PS)		
08-962600-00	STD	75.50	1.500		001 IF CR P		IKA
			1.500		005 IF P		STD
			3.000		712 CR		ST
Felicia I 1.6 LX,		08/95→03/98	AEE				6
Felicia I Estate 1.6 GLX				4cyl.			
Felicia I Fun 1.6		06/97→04/02		1598cc	55kW (75PS)		
Felicia II 1.6, Felicia II Estate 1.6		01/98→06/01					
Octavia 1.6		09/96→09/04					
Octavia Combi 1.6		07/98→09/04					TD13394
Fabia 1.2		01/03→03/08	AZQ				TD17070
Fabia Combi 1.2, Fabia Praktik 1.2,		01/03→12/07		3cyl.			
Fabia Saloon 1.2				1198cc	47kW (64PS)		
08-103100-00	STD	76.50	1.200		001 NT		ST
			1.500		005 P		STD
			2.500		236 P		STD
08-502800-00	STD	76.50	1.200		001 NT		ST
08-502807-00	0.50mm		1.500		026 P		STD
[R60280]			2.500		712 CR		ST
Fabia 1.4 16V		12/99→03/08	AUA				7
Fabia Combi 1.4 16V		05/00→12/07		4cyl.			
Fabia Saloon 1.4 16V		10/99→12/07		1390cc	55kW (75PS)		
							TD15374
Fabia 1.4 16V		12/99→03/08	AUB				TD15375
Fabia Combi 1.4 16V		04/00→12/07		4cyl.			
Fabia Saloon 1.4 16V		12/99→12/07		1390cc	74kW (100PS)		
Octavia 1.4 16V		09/00→12/10	AXP				TD16050
Octavia Combi 1.4 16V		08/00→12/10		4cyl.			
				1390cc	55kW (75PS)		





Fabia 1.4 16V			12/99→03/08	BBY				
Fabia Combi 1.4 16V			05/00→12/07		4cyl.			
Fabia Saloon 1.4 16V			10/99→12/07		1390cc	55kW (75PS)		TD17471
Fabia 1.4 16V			12/99→03/08	BBZ				
Fabia Combi 1.4 16V			04/00→12/07		4cyl.			
Fabia Saloon 1.4 16V			12/99→12/07		1390cc	74kW (100PS)		TD17472
08-116100-00	STD	76.50	1.200		001 NT			ST
08-116107-00	0.50mm		1.500		005 P			STD
			2.500		712 CR			ST
Octavia 1.4			05/04→05/06	BCA				8
Octavia 1.4 16V			09/00→12/10		4cyl.			
Octavia Combi 1.4			05/04→05/06		1390cc	55kW (75PS)		
Octavia Combi 1.4 16V			08/00→12/10				TD17495	
08-116100-00	STD	76.50	1.200		001 NT			ST
08-116107-00	0.50mm		1.500		005 P			STD
			2.500		712 CR			ST
08-436900-00	STD	76.50	1.200		001 NT			ST
			1.200		005 P			GOE13
			2.000		712 CR			ST
Fabia 1.4 16V			12/99→03/08	BKY				9
Fabia Combi 1.4 16V			05/00→12/07		4cyl.			
Fabia Saloon 1.4 16V			10/99→12/07		1390cc	55kW (75PS)	TD18696	
Fabia Combi 1.4 16V, Fabia Saloon 1.4 16V			04/06→12/07	BUD				
Octavia 1.4			06/04→		4cyl.			
Octavia Combi 1.4			05/06→		1390cc	59kW (80PS)		TD20190
Fabia 1.4			01/07→	BXW				
Fabia Combi 1.4			10/07→		4cyl.			
Roomster 1.4			09/06→		1390cc	63kW (86PS)		
Roomster Praktik 1.4			03/07→					TD19089
Fabia 1.4			01/07→	CDDA				
Fabia Combi 1.4			10/07→		4cyl.			
Roomster 1.4			09/06→		1390cc	63kW (86PS)		TD26495
Octavia 1.4			06/04→	CGGA				
Octavia Combi 1.4			05/06→		4cyl.			
					1390cc	59kW (80PS)		TD24838
Fabia 1.4			01/07→	CGGB				
Fabia Combi 1.4			10/07→		4cyl.			
Roomster 1.4			09/06→		1390cc	63kW (86PS)		
Roomster Praktik 1.4			03/07→					TD24980





Fabia I				CLPA		4cyl. 1390cc 63kW (86PS)		TD26496	
08-436900-00	STD	76.50	1.200		001 NT			ST	
			1.200		005 P			GOE13	
			2.000		712 CR			ST	
Octavia 1.6 FSI, Octavia Combi 1.6 FSI		02/04→10/08		BLF		4cyl. 1598cc 85kW (116PS)		10 TD17501	
Octavia 1.4 TSI, Octavia Combi 1.4 TSI		11/08→		CAXA		4cyl. 1390cc 90kW (122PS)		TD21592	
Rapid 1.4 TSI		07/12→				Turbo Intercooled			
Yeti 1.4 TSI		06/10→							
Superb 1.4 TSI		07/08→		CAXC		4cyl. 1390cc 92kW (125PS)		TD22677	
Superb Estate 1.4 TSI		10/09→				Turbo Intercooled			
08-429900-00	STD	76.50	1.200		001 NT			ST	
08-429907-00	0.50mm		1.200		005 P			GOE13	
			2.000		712 NT			ST	
Fabia 1.4 TSI, Fabia Combi 1.4 TSI		05/10→		CAVE		4cyl. 1390cc 132kW (180PS)		11 TD24217	
						Turbo & Supercharged			
Fabia 1.4 TSI, Fabia Combi 1.4 TSI		05/10→		CTHE		4cyl. 1390cc 132kW (180PS)		TD27361	
						Turbo & Supercharged			
08-433900-00	STD	76.50	1.200		001 NT			ST	
08-433907-00	0.50mm		1.500		005 P			GOE13	
			2.000		712 NT			ST	
Superb 2.5 TDI		12/01→08/03		AYM		V6cyl. 2496cc 114kW (155PS)		12 TD16404	
						Diesel Turbo Intercooled			
Superb 2.5 TDI		06/03→03/08		BDG		V6cyl. 2496cc 120kW (163PS)		TD17350	
						Diesel Turbo Intercooled			
08-103000-00	STD	78.30	1.750		001 CK P			KV1	
08-103007-00	0.50mm		2.000		005 IFU P			IKA	
<i>[R66900]</i>			3.000		231 CR P			STD	



Felicia I 1.9 D, Felicia I Estate 1.9 D		10/95→03/98	AEF		4cyl. 1896cc	47kW (64PS)	TD13395
Felicia I Fun 1.9 D		06/97→04/02					
Felicia II 1.9 D, Felicia II Estate 1.9 D		01/98→06/01	Diesel				
08-990100-00	STD	79.50	1.750		001 CR P		KV1
08-990105-00	0.25mm				005 IFU P		STD
08-990107-00	0.50mm		2.000				
08-990111-00	1.00mm		3.000		231 CR P		STD
[R45120]							
Octavia 1.9 SDI			AEY		4cyl. 1896cc	47kW (64PS)	TD18729
			Diesel				
Octavia 1.9 SDI		06/97→12/03	AGP		4cyl. 1896cc	50kW (68PS)	TD16424
Octavia Combi 1.9 SDI		07/98→12/03	Diesel				
Octavia 1.9 TDI		09/96→03/10	AGR		4cyl. 1896cc	66kW (89PS)	TD17905
Octavia Combi 1.9 TDI		07/98→03/10	Diesel				
Octavia Combi 1.9 TDI 4x4		11/99→02/06			Turbo Intercooled		
Octavia 1.9 TDI		08/97→01/06	AHF		4cyl. 1896cc	81kW (110PS)	TD17910
Octavia Combi 1.9 TDI		07/98→01/06	Diesel				
Octavia 1.9 TDI		09/96→03/10	ALH		4cyl. 1896cc	66kW (89PS)	TD16090
Octavia Combi 1.9 TDI		07/98→03/10	Diesel				
Fabia 1.4 TDI		04/03→03/08	AMF		3cyl. 1422cc	55kW (75PS)	TD17348
Fabia Combi 1.4 TDI, Fabia Saloon 1.4 TDI		04/03→12/07	Diesel				
Octavia 1.9 SDI		06/97→12/03	AQM		4cyl. 1896cc	50kW (68PS)	TD16089
Octavia Combi 1.9 SDI		07/98→12/03	Diesel				
Octavia 1.9 TDI		08/97→01/06	ASV		4cyl. 1896cc	81kW (110PS)	TD16091
Octavia Combi 1.9 TDI		07/98→01/06	Diesel				
Fabia 1.9 SDI		12/99→03/08	ASY		4cyl. 1896cc	47kW (64PS)	TD15376
Fabia Combi 1.9 SDI		04/00→12/07	Diesel				
Fabia Praktik 1.9 SDI		07/01→12/07					
Fabia Saloon 1.9 SDI		11/99→12/07					
Fabia 1.9 TDI RS		06/03→03/08	ASZ		4cyl. 1896cc	96kW (131PS)	TD17036
Octavia 1.9 TDI, Octavia Combi 1.9 TDI		09/02→09/04	Diesel				
Fabia 1.9 TDI		01/00→03/08	ATD		4cyl. 1896cc	74kW (100PS)	TD15377
Fabia Combi 1.9 TDI		04/00→12/07	Diesel				
Fabia Saloon 1.9 TDI		01/00→12/07					
Octavia Combi 1.9 TDI		08/00→12/10					
Octavia Combi 1.9 TDI 4x4		09/00→01/06					





Superb 1.9 TDI	08/02→10/05	AVB	4cyl. 1896cc 74kW (100PS)	Diesel	Turbo Intercooled	TD17037	
Superb 1.9 TDI	12/01→03/08	AVF	4cyl. 1896cc 96kW (131PS)	Diesel	Turbo Intercooled	TD18239	
Superb 1.9 TDI	12/01→03/08	AWX	4cyl. 1896cc 96kW (131PS)	Diesel	Turbo Intercooled	TD16403	
Fabia 1.9 TDI	01/00→03/08	AXR	4cyl. 1896cc 74kW (100PS)	Diesel	Turbo Intercooled	TD20195	
Fabia Combi 1.9 TDI	04/00→12/07						
Fabia Saloon 1.9 TDI	01/00→12/07						
Octavia 1.9 TDI	10/05→12/10						
Octavia Combi 1.9 TDI	08/00→12/10						
Roomster 1.9 TDI	03/06→05/06						
Fabia 1.4 TDI	01/07→	BMS	3cyl. 1422cc 59kW (80PS)	Diesel	Turbo Intercooled	TD19092	
Fabia Combi 1.4 TDI	10/07→						
Roomster 1.4 TDI	09/06→03/10						
Roomster Praktik 1.4 TDI	03/07→03/10						
Fabia 1.4 TDI, Fabia Combi 1.4 TDI	10/05→	BNM	3cyl. 1422cc 51kW (69PS)	Diesel	Turbo Intercooled	TD18740	
Fabia Praktik 1.4 TDI,	10/05→12/07						
Fabia Saloon 1.4 TDI							
Roomster 1.4 TDI	07/06→03/10						
Roomster Praktik 1.4 TDI	03/07→03/10						
Fabia 1.4 TDI, Fabia Combi 1.4 TDI	10/05→	BNV	3cyl. 1422cc 59kW (80PS)	Diesel	Turbo Intercooled	TD18741	
Fabia Saloon 1.4 TDI	10/05→12/07						
Roomster 1.4 TDI	09/06→03/10						
Roomster Praktik 1.4 TDI	03/07→03/10						
08-114900-00	STD	79.50	1.750		001 CK P	KV1	
08-114905-00	0.25mm						
08-114907-00	0.50mm		2.000		005 IFU P	STD	
08-114911-00	1.00mm		3.000		231 CR P	STD	
[R60370]							
Octavia 1.9 TDI	06/04→12/10	BJB	4cyl. 1896cc 77kW (105PS)	Diesel	Turbo Intercooled	TD17499	15
Octavia Combi 1.9 TDI	09/04→12/10						
Octavia 1.9 TDI	06/04→12/10	BKC	4cyl. 1896cc 77kW (105PS)	Diesel	Turbo Intercooled	TD17497	
Octavia Combi 1.9 TDI	09/04→12/10						
Octavia Combi 1.9 TDI 4x4	11/04→12/10						
Fabia 1.9 TDI	04/07→	BLS	4cyl. 1896cc 77kW (105PS)	Diesel	Turbo Intercooled	TD19091	
Fabia Combi 1.9 TDI	10/07→						
Octavia 1.9 TDI	06/04→12/10						
Octavia Combi 1.9 TDI	09/04→12/10						
Octavia Combi 1.9 TDI 4x4	11/04→12/10						
Roomster 1.9 TDI	09/06→03/10						
Superb 1.9 TDI	03/08→						
Superb Estate 1.9 TDI	10/09→11/10						
Fabia 1.9 TDI RS	06/03→03/08	BLT	4cyl. 1896cc 96kW (131PS)	Diesel	Turbo Intercooled	TD20517	





Fabia 1.9 TDI			04/07→		BSW			
Fabia Combi 1.9 TDI			10/07→			4cyl.		
Roomster 1.9 TDI			09/06→03/10			1896cc	77kW (105PS)	
					Diesel	Turbo Intercooled		TD20004
Octavia 1.9 TDI			06/04→12/10		BXE			
Octavia Combi 1.9 TDI			09/04→12/10			4cyl.		
Octavia Combi 1.9 TDI 4x4			11/04→12/10			1896cc	77kW (105PS)	
Superb 1.9 TDI			03/08→		Diesel	Turbo Intercooled		
Superb Estate 1.9 TDI			10/09→11/10					TD20513
08-114900-00	STD	79.50	1.750		001 CK P			KV1
08-114905-00	0.25mm		2.000		005 IFU P			STD
08-114907-00	0.50mm		3.000		231 CR P			STD
08-114911-00	1.00mm							
[R60370]								
08-433000-00	STD	79.50	1.750		001 GDC P			KV4
08-433007-00	0.50mm		2.000		005 IFU P			F12/F14
01/2006→			3.000		231 LKZ CR P			GOE13
with DPF								
Superb 1.9 TDI			01/07→03/08		BPZ			16
						4cyl.		
						1896cc	85kW (116PS)	
					Diesel	Turbo Intercooled		TD20205
Superb 1.9 TDI			10/05→05/07		BSV			
						4cyl.		
						1896cc	77kW (105PS)	
					Diesel	Turbo Intercooled		TD20206
08-433000-00	STD	79.50	1.750		001 GDC P			KV4
08-433007-00	0.50mm		2.000		005 IFU P			F12/F14
with DPF			3.000		231 LKZ CR P			GOE13
Fabia 1.6 TDI, Fabia Combi 1.6 TDI			04/10→		CAYA			17
						4cyl.		
						1598cc	55kW (75PS)	
					Diesel	Turbo Intercooled		TD24216
Fabia 1.6 TDI, Fabia Combi 1.6 TDI			03/10→		CAYB			
Rapid 1.6 TDI			08/13→			4cyl.		
Roomster 1.6 TDI,			03/10→			1598cc	66kW (89PS)	
Roomster Praktik 1.6 TDI					Diesel	Turbo Intercooled		TD23929
Fabia 1.6 TDI, Fabia Combi 1.6 TDI			03/10→		CAYC			
Octavia 1.6 TDI, Octavia Combi 1.6 TDI,			06/09→			4cyl.		
Octavia Combi 1.6 TDI 4x4						1598cc	77kW (105PS)	
Rapid 1.6 TDI			07/12→		Diesel	Turbo Intercooled		
Roomster 1.6 TDI			03/10→					
Superb 1.6 TDI, Superb Estate 1.6 TDI			09/10→					
Yeti 1.6 TDI			11/10→					TD22678
Fabia 1.2 TDI, Fabia Combi 1.2 TDI			05/10→		CFWA			
Roomster 1.2 TDI,			03/10→			3cyl.		
Roomster Praktik 1.2 TDI						1199cc	55kW (75PS)	
					Diesel	Turbo Intercooled		TD24261





Fabia 1.6 TDI		03/10→	CLNA		4cyl. 1598cc 77kW (105PS)	
			Diesel Turbo Intercooled			TD25764
08-432900-00	STD	79.50	1.750		001 GDC P	KV4
08-432907-00	0.50mm		2.000		005 IFU P	F12/F14
			3.000		231 LKZ CR P	STD
Octavia 1.8			ADR		4cyl. 1781cc 92kW (125PS)	18 TD20805
Octavia 1.8		09/96→07/00	AGN		4cyl. 1781cc 92kW (125PS)	TD17903
Octavia Combi 1.8 20V		07/98→07/00				
Octavia 1.8 T		08/97→12/10	AGU		4cyl. 1781cc 110kW (150PS)	TD13396
Octavia Combi 1.8 T		07/98→12/10			Turbo Intercooled	
Octavia 1.8 T		08/97→12/10	ARX		4cyl. 1781cc 110kW (150PS)	TD16069
Octavia 1.8 T 4x4		05/01→05/06			Turbo Intercooled	
Octavia Combi 1.8 T		07/98→12/10				
Octavia Combi 1.8 T 4x4		05/01→05/06				
Octavia 1.8 T		08/97→12/10	ARZ		4cyl. 1781cc 110kW (150PS)	TD16030
Octavia Combi 1.8 T		07/98→12/10			Turbo Intercooled	
Octavia 1.8 T		08/97→12/10	AUM		4cyl. 1781cc 110kW (150PS)	TD16070
Octavia Combi 1.8 T		07/98→12/10			Turbo Intercooled	
Octavia RS 1.8 T		05/01→01/06	AUQ		4cyl. 1781cc 132kW (180PS)	TD16279
Octavia Combi RS 1.8 T		08/02→01/06			Turbo Intercooled	
Superb 1.8 T		12/01→03/08	AWT		4cyl. 1781cc 110kW (150PS)	TD16365
					Turbo Intercooled	
08-502900-00	STD	81.00	1.500		001 CK P	KV1
08-502905-00	0.25mm		1.750		026 P	GOE13
08-502907-00	0.50mm		2.000		231 CR P	KV1
[R60320]						



Octavia 1.6			02/97→12/07	AEH						19
Octavia Combi 1.6			07/98→12/07		4cyl.					
					1595cc	74kW (100PS)				TD12950
Octavia 1.6			02/97→12/07	AKL						19
Octavia Combi 1.6			07/98→12/07		4cyl.					
					1595cc	74kW (100PS)				TD12951
08-105900-00	STD	81.00	1.200		001 NT				ST	
08-105907-00	0.50mm		1.500		026 P				STD	
[R60290]			2.000		712 CR				ST	
Octavia 1.6			11/00→12/10	AVU						20
Octavia Combi 1.6			09/00→12/10		4cyl.					
					1595cc	75kW (102PS)				TD16068
Octavia 1.6			11/00→12/10	BFQ						20
Octavia Combi 1.6			09/00→12/10		4cyl.					
					1595cc	75kW (102PS)				TD17912
Octavia 1.6			06/04→	BGU						20
Octavia Combi 1.6			09/04→		4cyl.					
					1595cc	75kW (102PS)				TD17496
Octavia 1.6			06/04→	BSE						20
Octavia Combi 1.6			09/04→		4cyl.					
					1595cc	75kW (102PS)				TD20898
Octavia 1.6			06/04→	BSF						20
Octavia Combi 1.6			09/04→		4cyl.					
					1595cc	75kW (102PS)				TD20899
Octavia 1.6			06/04→	CCSA						20
Octavia 1.6 MultiFuel			01/08→		4cyl.					
Octavia Combi 1.6			09/04→		1595cc	75kW (102PS)				
Octavia Combi 1.6 MultiFuel			01/08→							
08-148300-00	STD	81.00	1.000		001 NT				ST	
			1.200		023 P				GOE13	
			2.000		231 CR P				KV1	
Octavia 2.0 TDI,			02/04→05/10	AZV						21
Octavia Combi 2.0 TDI 16V					4cyl.					
					1968cc	100kW (136PS)				TD20909
				Diesel	Turbo Intercooled					
Octavia 2.0 TDI 16V,			02/04→	BKD						21
Octavia Combi 2.0 TDI 16V					4cyl.					
Superb 2.0 TDI 16V			01/09→		1968cc	103kW (140PS)				
Superb Estate 2.0 TDI 16V			10/09→	Diesel	Turbo Intercooled				TD17500	
Octavia 2.0 TDI, Octavia Combi 2.0 TDI			11/05→	BMM						21
Octavia Combi 2.0 TDI 4x4			07/06→		4cyl.					
					1968cc	103kW (140PS)				
				Diesel	Turbo Intercooled				TD19315	









Octavia 2.0 TDI RS, Octavia Combi 2.0 TDI RS		04/06→			BMN	4cyl. 1968cc 125kW (170PS)	
					Diesel	Turbo Intercooled	TD20735
Superb 2.0 TDI Superb Estate 2.0 TDI		03/08→ 10/09→03/10			BMP	4cyl. 1968cc 103kW (140PS)	
					Diesel	Turbo Intercooled	TD20945
Superb 2.0 TDI		10/05→03/08			BSS	4cyl. 1968cc 103kW (140PS)	
					Diesel	Turbo Intercooled	TD19317
08-139500-00	STD	81.00	1.750		001 CK P		
08-139507-00	0.50mm		2.000		005 IFU P		F12/F14
			3.000		231 CR P		STD
Superb 2.0 TDI Superb 2.0 TDI 4x4 Superb Estate 2.0 TDI, Superb Estate 2.0 TDI 4x4		07/08→ 09/08→ 10/09→			CBBB	4cyl. 1968cc 125kW (170PS)	22 TD20944
					Diesel	Turbo Intercooled	
Yeti 2.0 TDI 4x4		05/09→			CBDB	4cyl. 1968cc 103kW (140PS)	TD23586
					Diesel	Turbo Intercooled	
Octavia 2.0 TDI RS, Octavia Combi 2.0 TDI RS Yeti 2.0 TDI 4x4		04/06→ 11/09→			CEGA	4cyl. 1968cc 125kW (170PS)	TD20905
					Diesel	Turbo Intercooled	
Superb 2.0 TDI 16V Superb 2.0 TDI 16V 4x4 Superb Estate 2.0 TDI 16V Superb Estate 2.0 TDI 16V 4x4		01/09→ 11/10→ 10/09→ 11/10→			CFFB	4cyl. 1968cc 103kW (140PS)	TD23589
					Diesel	Turbo Intercooled	
Superb 2.0 TDI Superb 2.0 TDI 4x4 Superb Estate 2.0 TDI, Superb Estate 2.0 TDI 4x4		07/08→ 09/08→ 10/09→			CFGB	4cyl. 1968cc 125kW (170PS)	TD23591
					Diesel	Turbo Intercooled	
Yeti 2.0 TDI		11/09→			CFHA	4cyl. 1968cc 81kW (110PS)	TD23584
					Diesel	Turbo Intercooled	
Octavia 2.0 TDI 16V, Octavia Combi 2.0 TDI 16V Octavia Combi 2.0 TDI 16V 4x4 Yeti 2.0 TDI Yeti 2.0 TDI 4x4		02/04→ 05/10→ 11/11→ 05/09→			CFHC	4cyl. 1968cc 103kW (140PS)	TD23587
					Diesel	Turbo Intercooled	
Octavia 2.0 TDI, Octavia Combi 2.0 TDI Octavia Combi 2.0 TDI 4x4 Yeti 2.0 TDI 4x4		03/10→ 05/11→ 11/09→			CFHF	4cyl. 1968cc 81kW (110PS)	TD23585
					Diesel	Turbo Intercooled	
Yeti 2.0 TDI 4x4		11/09→			CFJA	4cyl. 1968cc 125kW (170PS)	TD23588
					Diesel	Turbo Intercooled	





Octavia 2.0 TDI, Octavia Combi 2.0 TDI Yeti 2.0 TDI	03/10→ 11/09→	CLCA	4cyl. 1968cc	81kW (110PS)	Diesel Turbo Intercooled	TD24839
Octavia 2.0 TDI 16V, Octavia Combi 2.0 TDI 16V Yeti 2.0 TDI 4x4	02/04→ 05/09→	CLCB	4cyl. 1968cc	103kW (140PS)	Diesel Turbo Intercooled	TD24598
Superb 2.0 TDI 16V Superb Estate 2.0 TDI 16V	01/09→ 10/09→	CLJA	4cyl. 1968cc	103kW (140PS)	Diesel Turbo Intercooled	TD23590

08-432300-00 ⓘ STD	81.00	1.750		001 GDC P	KV4
08-432307-00 0.50mm		2.000		005 IFU P	F12/F14
		3.000		231 LKZ CR P	GOE13
					

ⓘ 08-432300-00 OE: 03L198151A

Octavia 2.0, Octavia Combi 2.0	04/99→05/07	AEG	4cyl. 1984cc	85kW (116PS)		23	TD16280
Superb 2.8 V6	12/01→03/08	AMX	V6cyl. 2771cc	142kW (193PS)			TD16367
Octavia 2.0, Octavia Combi 2.0	04/99→05/07	APK	4cyl. 1984cc	85kW (116PS)			TD16031
Fabia 2.0 Octavia 2.0, Octavia Combi 2.0	12/99→03/08 04/99→05/07	AQY	4cyl. 1984cc	85kW (116PS)			TD13869
Octavia 2.0, Octavia Combi 2.0 Octavia Combi 2.0 4x4	04/99→05/07 08/00→09/04	AZH	4cyl. 1984cc	85kW (116PS)			TD16092
Octavia 2.0, Octavia Combi 2.0 Octavia Combi 2.0 4x4	04/99→05/07 08/00→09/04	AZJ	4cyl. 1984cc	85kW (116PS)			TD17466
Fabia 2.0 Fabia Combi 2.0 Fabia Saloon 2.0	12/99→03/08 04/00→12/07 12/99→12/07	AZL	4cyl. 1984cc	85kW (116PS)			TD16241
Superb 2.0	12/01→03/08	AZM	4cyl. 1984cc	85kW (116PS)			TD16366





Superb 2.8 V6		06/02→03/08	BBG	V6cyl. 2771cc		140kW (190PS)	TD18754
08-501800-00	STD	82.50	1.200		005 PS		KV1
08-501807-00	0.50mm		1.500		005 IW P		STD
[R60310]			2.000		231 CR P		KV1
Octavia 2.0 FSI, Octavia Combi 2.0 FSI		11/04→	BLR	4cyl. 1984cc		110kW (150PS)	24 TD18102
Octavia Combi 2.0 FSI 4x4		11/04→	BLX	4cyl. 1984cc		110kW (150PS)	TD20393
Octavia 2.0 FSI, Octavia Combi 2.0 FSI		11/04→	BLY	4cyl. 1984cc		110kW (150PS)	TD18101
Octavia Combi 2.0 FSI 4x4		11/04→	BVX	4cyl. 1984cc		110kW (150PS)	TD20394
Octavia 2.0 FSI, Octavia Combi 2.0 FSI		11/04→	BVY	4cyl. 1984cc		110kW (150PS)	TD20518
Octavia 2.0 FSI, Octavia Combi 2.0 FSI		11/04→	BVZ	4cyl. 1984cc		110kW (150PS)	TD20519
Octavia 2.0 RS, Octavia Combi 2.0 RS		10/05→	BWA	4cyl. 1984cc		147kW (200PS) Turbo Intercooled	TD20395
08-435100-10	STD	82.50	1.200		001 PVD NT		ST
			1.500		026		GOE13
			2.000		231 CR		KV1

Modelverzeichnis • Index de modele • Índice de Modelo
Indeks modelu • Модель автомобиля • دليل المركب

MODEL INDEX



CCM

x



9

03/00→01/04	Cabrio 0.6	M 160 E6AL B03	Petrol	599	3	1
01/01→01/04	Cabrio 0.6	M 160 E6AL B05	Petrol	599	3	1
01/03→01/04	Cabrio 0.7	M 160.910	Petrol	599	3	3
03/01→01/04	Cabrio 0.8 CDI	OM 660 DE 8LA	Diesel	799	3	2
07/98→01/04	City-Coupe 0.6	M 160 E6AL B03	Petrol	599	3	1
07/98→01/04	City-Coupe 0.6	M 160 E6AL B04	Petrol	599	3	1
01/01→01/04	City-Coupe 0.6	M 160 E6AL B05	Petrol	599	3	1
01/03→01/04	City-Coupe 0.7	M 160.910	Petrol	599	3	3
11/99→01/04	City-Coupe 0.8 CDI	OM 660 DE 8LA	Diesel	799	3	2
09/04→06/06	Forfour 1.5 CDI	OM 639.939 Euro 4	Diesel	1493	3	4
01/04→01/07	Fortwo cabrio 0.7	M 160.910	Petrol	599	3	3
01/04→01/07	Fortwo cabrio 0.8 CDI	OM 660 DE 8LA	Diesel	799	3	2
08/09→	Fortwo cabrio 0.8 CDi	OM 660.951	Diesel	799	3	2
01/07→	Fortwo cabrio 0.8 CDi	OM660.950	Diesel	799	3	2
01/04→01/07	Fortwo Coupe 0.7	M 160.910	Petrol	599	3	3
01/04→01/07	Fortwo Coupe 0.8 CDI	OM 660 DE 8LA	Diesel	799	3	2
08/09→	Fortwo Coupe 0.8 CDi	OM 660.951	Diesel	799	3	2
01/07→	Fortwo Coupe 0.8 CDi	OM660.950	Diesel	799	3	2
04/03→11/05	Roadster 0.7	M 160.922	Petrol	698	3	3
04/03→11/05	Roadster 0.7	M160.921	Petrol	698	3	3
12/03→11/05	Roadster 0.7 Brabus	M 160.923	Petrol	698	3	3
12/03→11/05	Roadster Coupe 0.7 Brabus	M 160.923	Petrol	698	3	3

Motorverzeichnis • Index de moteur • Índice de Motor
Indeks silnika • Модель двигателя • دليل المحرك

ENGINE INDEX



CCM

x



9

M 160 E6AL B03	Petrol	599	3	63.50	1
M 160 E6AL B04	Petrol	599	3	63.50	1
M 160 E6AL B05	Petrol	599	3	63.50	1
M 160.910	Petrol	599	3	66.50	3
M 160.922	Petrol	698	3	66.50	3
M 160.923	Petrol	698	3	66.50	3
M160.921	Petrol	698	3	66.50	3
OM 639.939 Euro 4	Diesel	1493	3	83.00	4
OM 660 DE 8LA	Diesel	799	3	65.50	2
OM 660.951	Diesel	799	3	65.50	2
OM660.950	Diesel	799	3	65.50	2



Cabrio 0.6			03/00→01/04		M 160 E6AL B03				1
City-Coupe 0.6			07/98→01/04		3cyl.	599cc	40kW (54PS)		
							Turbo Intercooled	TD22902	
City-Coupe 0.6			07/98→01/04		M 160 E6AL B04				1
					3cyl.	599cc	33kW (45PS)		
							Turbo Intercooled	TD22903	
Cabrio 0.6, City-Coupe 0.6			01/01→01/04		M 160 E6AL B05				1
					3cyl.	599cc	45kW (61PS)		
							Turbo Intercooled	TD22901	
08-136700-00	STD	63.50	1.200		001 CR			ST	
08-136705-00	0.25mm		1.500		005 P			GOE12	
08-136707-00	0.50mm		2.500		712 CR			ST	
<i>[R66860]</i>									
Cabrio 0.8 CDI			03/01→01/04		OM 660 DE 8LA				2
City-Coupe 0.8 CDI			11/99→01/04		3cyl.	799cc	30kW (41PS)		
Fortwo cabrio 0.8 CDI,			01/04→01/07		Diesel		Turbo Intercooled	TD22900	
Fortwo Coupe 0.8 CDI									
Fortwo cabrio 0.8 CDi,			08/09→		OM 660.951				2
Fortwo Coupe 0.8 CDi					3cyl.	799cc	40kW (54PS)		
					Diesel		Turbo Intercooled	TD24475	
Fortwo cabrio 0.8 CDi,			01/07→		OM660.950				2
Fortwo Coupe 0.8 CDi					3cyl.	799cc	33kW (45PS)		
					Diesel		Turbo Intercooled	TD20946	
08-140600-00	STD	65.50	1.500		001 CK P			KV1	
			1.500		005 IF P			F12/F14	
			2.500		231 CR P			GOE12	
Cabrio 0.7, City-Coupe 0.7			01/03→01/04		M 160.910				3
Fortwo cabrio 0.7, Fortwo Coupe 0.7			01/04→01/07		3cyl.	599cc	33-55kW (45-75PS)		
							Turbo Intercooled	TD26102	
Roadster 0.7			04/03→11/05		M 160.922				3
					3cyl.	698cc	45kW (61PS)		
							Turbo Intercooled	TD26301	
Roadster 0.7 Brabus,			12/03→11/05		M 160.923				3
Roadster Coupe 0.7 Brabus					3cyl.	698cc	74kW (100PS)		
							Turbo Intercooled	TD26104	
Roadster 0.7			04/03→11/05		M160.921				3
					3cyl.	698cc	45kW (61PS)		
							Turbo Intercooled	TD22100	
08-427100-00	STD	66.50	1.200		001 NT			ST	
08-427105-00	0.25mm		1.200		005 NT			ST	
08-427107-00	0.50mm		2.500		712 NT			ST	



Forfour 1.5 CDI

09/04→06/06

OM 639.939 Euro 4

4

3cyl.

1493cc 50-70kW (58-95PS)

Diesel Turbo Intercooled

TD23800

08-427500-00
08-427507-00

STD
0.50mm

83.00

2.000



001 IF CK

KV4

2.000



005 IFU P

F12/F14

2.000



231 LKZ CR P

GOE13



MODEL INDEX

Modelverzeichnis • Index de modele • Índice de Modelo
Indeks modelu • Модель автомобиля • دليل المحرك



CCM

x



9

03/07→	Actyon 2.3i 16V	M 161.974	Petrol	2295	4	3
07/97→	Chairman 2.3	M 111.970	Petrol	2295	4	3
07/97→	Chairman 3.2	M 111.974	Petrol	2295	4	3
07/97→	Chairman 3.2	M 104.992	Petrol	3199	6	2
10/92→05/95	Istana Box 2.9 D	OM 602.940	Diesel	2874	5	1
10/92→05/95	Istana Bus 2.9 TD	OM 602.940	Diesel	2874	5	1
01/97→	Korando	XD3 T, XD3 TE	Diesel	2498	4	4
05/97→	Korando 2.3	M 111.970	Petrol	2295	4	3
01/02→	Korando 2.3	M 161.970	Petrol	2295	4	3
12/96→	Korando 2.3 D	OM 601.940	Diesel	2299	4	1
12/97→	Korando 2.3i 16V	M 161.974	Petrol	2295	4	3
12/96→	Korando 2.9 D	MB-OM 662	Diesel	2874	5	1
	Korando 2.9 D	OM 661.940	Diesel	2299	4	1
	Korando 2.9 D	OM 662.940	Diesel	2874	5	1
06/97→	Korando 3.2	M 104.992	Petrol	3199	6	2
12/96→	Korando 3.2	M 104.995	Petrol	3199	6	2
01/02→	Korando Cabrio 2.3	M 161.970	Petrol	2295	4	3
11/97→	Korando Cabrio 2.9 D	MB-OM 662	Diesel	2874	5	1
	Korando Cabrio 2.9 D	OM 661.940	Diesel	2299	4	1
	Korando Cabrio 2.9 D	OM 662.940	Diesel	2874	5	1
06/97→	Korando Cabrio 3.2	M 104.992	Petrol	3199	6	2
01/99→	Korando Cabrio 3.2	M 104.995	Petrol	3199	6	2
01/10→	KYRON 2.3	M 161.970	Petrol	2295	4	3
01/06→	Kyron 2.3i 16V	M 161.974	Petrol	2295	4	3
10/96→	Musso 2.3	M 111.970	Petrol	2295	4	3
10/95→	Musso 2.3 D	OM 601.940	Diesel	2299	4	1
03/96→	Musso 2.9 D	MB-OM 662	Diesel	2874	5	1
	Musso 2.9 D	OM 661.940	Diesel	2299	4	1
	Musso 2.9 D	OM 662.940	Diesel	2874	5	1
06/96→	Musso 3.2	M 104.992	Petrol	3199	6	2
09/02→	Rexton 2.9 TD	OM 662.983	Diesel	2874	5	1

ENGINE INDEX

Motorverzeichnis • Index de moteur • Índice de Motor
Indeks silnika • Модель двигателя • دليل المحرك



CCM

x



9

M 104.992	Petrol	3199	6	89.90	2
M 104.995	Petrol	3199	6	89.90	2
M 111.970	Petrol	2295	4	90.90	3
M 111.974	Petrol	2295	4	90.90	3
M 161.970	Petrol	2295	4	90.90	3
M 161.974	Petrol	2295	4	90.90	3
MB-OM 662	Diesel	2874	5	89.00	1
OM 601.940	Diesel	2299	4	89.00	1
OM 602.940	Diesel	2874	5	89.00	1
OM 661.940	Diesel	2299	4	89.00	1
OM 662.940	Diesel	2874	5	89.00	1
OM 662.983	Diesel	2874	5	89.00	1
XD3 T, XD3 TE	Diesel	2498	4	94.00	4



Korando 2.9 D		12/96→	MB-OM 662		5cyl. 2874cc	72-73kW (98-99PS)	1
Korando Cabrio 2.9 D		11/97→					
Musso 2.9 D		03/96→					
			Diesel				TD9355
Korando 2.3 D		12/96→	OM 601.940		4cyl. 2299cc	57-59kW (77-80PS)	
Musso 2.3 D		10/95→					
			Diesel				TD3612
Istana Box 2.9 D, Istana Bus 2.9 TD		10/92→05/95	OM 602.940		5cyl. 2874cc	70kW (95PS)	
			Diesel	Turbo Intercooled			TD3613
Korando 2.9 D, Korando Cabrio 2.9 D, Musso 2.9 D			OM 661.940		4cyl. 2299cc	58kW (79PS)	
			Diesel				TD21373
Korando 2.9 D, Korando Cabrio 2.9 D, Musso 2.9 D			OM 662.940		5cyl. 2874cc	70kW (95PS)	
			Diesel	Turbo Intercooled			TD21372
Rexton 2.9 TD		09/02→	OM 662.983		5cyl. 2874cc	88kW (120PS)	
			Diesel	Turbo Intercooled			TD21371
08-743100-00	STD	89.00	2.500		001 IF CR P		KV1
08-743107-00	0.50mm		2.000		005 IF P		STD
08-743120-00	0.70mm		3.000		231 CR P		GOE12
[R45080]							
Chairman 3.2		07/97→	M 104.992		6cyl. 3199cc	162kW (220PS)	2
Korando 3.2, Korando Cabrio 3.2		06/97→					
Musso 3.2		06/96→					
							TD9357
Korando 3.2		12/96→	M 104.995		6cyl. 3199cc	154-156kW (209-212PS)	
Korando Cabrio 3.2		01/99→					
							TD9374
08-287500-00	STD	89.90	1.500		001 IF NT		ST
08-287505-00	0.25mm		1.750		026 P		STD
08-287507-00	0.50mm		3.000		231 CR P		STD
[R66600]							
Chairman 2.3		07/97→	M 111.970		4cyl. 2295cc	103-110kW (140-150PS)	3
Korando 2.3		05/97→					
Musso 2.3		10/96→					
							TD5544
Chairman 2.3		07/97→	M 111.974		4cyl. 2295cc	105-142kW (143-193PS)	
							TD19459
Korando 2.3, Korando Cabrio 2.3		01/02→	M 161.970		4cyl. 2295cc	103-107kW (140-146PS)	
KYRON 2.3		01/10→					
							TD22101





Actyon 2.3i 16V	03/07→	M 161.974		
Korando 2.3i 16V	12/97→		4cyl.	
Kyron 2.3i 16V	01/06→		2295cc	110kW (150PS)
TD22102				

08-109100-00	STD	90.90	1.500		001 IF NT	ST
08-109107-00	0.50mm		1.750		026	STD
[R66610]			3.000		231 NT	ST

Korando	01/97→	XD3 T, XD3 TE			4
			4cyl.		
			2498cc	58kW (79PS)	
			Diesel	Turbo	FM4386

08-320200-10	STD	94.00	3.000		008 MOL P	IKA
08-320204-10	0.20mm		2.000		005 P	IKA
08-320206-10	0.40mm		4.000		231 CR P	STD
08-320208-10	0.60mm					
08-320211-10	1.00mm					
[R66000]						

				XD3P		5
					4cyl.	
					2498cc	58-53kW (79-72PS)
				Diesel		TD19458

08-318700-10	STD	94.00	2.000		001 CR P	KV1
08-318704-10	0.20mm		2.000		005 IF P	STD
08-318706-10	0.40mm		4.000		231 CR P	STD
08-318707-10	0.50mm					
08-318708-10	0.60mm					
08-318710-10	0.80mm					
08-318711-10	1.00mm					
[R66140]						

Motorverzeichnis • Index de moteur • Índice de Motor
Indeks silnika • Модель двигателя • دليل المحرك

ENGINE INDEX



CCM

x



9

WD 208, WD 208	Diesel	1570	2	100.00	1
WD 308, WD 308	Diesel	2535	3	100.00	1
WD 308.40	Diesel	2356	3	100.00	1
WD 308.41	Diesel	2356	3	100.00	1
WD 308.45	Diesel	2356	3	100.00	1
WD 311, WD311	Diesel	2590	3	100.00	2
WD 408, WD 408	Diesel	3142	4	100.00	1
WD 408.40	Diesel	3140	4	100.00	1
WD 408.41	Diesel	3140	4	100.00	1
WD 408.42	Diesel	3140	4	100.00	1
WD 408.43	Diesel	3140	4	100.00	1
WD 411, WD411	Diesel	3465	4	100.00	2
WD 411.41	Diesel	3456	4	100.00	2
WD 411.42	Diesel	3456	4	100.00	2
WD 411.43	Diesel	3456	4	100.00	2
WD 411.44	Diesel	3456	4	100.00	2
WD 411.45	Diesel	3456	4	100.00	2
WD 411.46	Diesel	3456	4	100.00	2
WD 411.85	Diesel	3456	4	100.00	2
WD 411.86	Diesel	3456	4	100.00	2
WD 411.87	Diesel	3456	4	100.00	2
WD 611, WD611	Diesel	5184	6	100.00	2
WD 615.00	Diesel	9726	6	126.00	4
WD 615.20	Diesel	9726	6	126.00	4
WD 615.60	Diesel	9726	6	126.00	4
WD 615.61	Diesel	9726	6	126.00	4
WD 615.63	Diesel	9726	6	126.00	4
WD 615.64	Diesel	9726	6	126.00	4
WD 615.65	Diesel	9726	6	126.00	4
WD 615.67	Diesel	9726	6	126.00	4
WD 615.68	Diesel	9726	6	126.00	4
WD 615.69	Diesel	9726	6	126.00	4
WD 615.70	Diesel	9726	6	126.00	4
WD 615.71	Diesel	9726	6	126.00	4
WD 615.73	Diesel	9726	6	126.00	4
WD 615.74	Diesel	9726	6	126.00	4
WD 615.75	Diesel	9726	6	126.00	4
WD 615.77	Diesel	9726	6	126.00	4
WD 615.93	Diesel	9726	6	126.00	4
WD 1015, WD1015	Diesel	14955	10	126.00	3



1

WD 208, WD 208	2cyl.	1570cc	22kW (30PS)	Diesel	FM5578
WD 308, WD 308	3cyl.	2535cc	34-37kW (40-45PS)	Diesel	FM5579
WD 308.40	3cyl.	2356cc	31-34kW (42-46PS)	Diesel	TD28858
WD 308.41	3cyl.	2356cc	31-34kW (42-46PS)	Diesel	TD28859
WD 308.45	3cyl.	2356cc	31-34kW (42-46PS)	Diesel	TD28860
WD 408, WD 408	4cyl.	3142cc	52kW (71PS)	Diesel	FM5580
WD 408.40	4cyl.	3140cc	38-46kW (52-63PS)	Diesel	TD28862
WD 408.41	4cyl.	3140cc	38-46kW (52-63PS)	Diesel	TD28863
WD 408.42	4cyl.	3140cc	38-46kW (52-63PS)	Diesel	TD28864
WD 408.43	4cyl.	3140cc	38-46kW (52-63PS)	Diesel	TD28865

08-361900-00	STD	100.00	2.500		001 IF CR P	STD
			2.500		001 IF P	STD
			2.500		023 P	STD
			5.000		231 CR P	STD

2

WD 311, WD311	3cyl.	2590cc		Diesel	FM6191
WD 411, WD411	4cyl.	3465cc		Diesel	FM6192
WD 411.41	4cyl.	3456cc	43kW (58PS)	Diesel	TD28866
WD 411.42	4cyl.	3456cc	43kW (58PS)	Diesel	TD28867
WD 411.43	4cyl.	3456cc	43-47kW (58-64PS)	Diesel	TD28868
WD 411.44	4cyl.	3456cc	43-47kW (58-64PS)	Diesel	TD28869
WD 411.45	4cyl.	3456cc	47kW (64PS)	Diesel	TD28870
WD 411.46	4cyl.	3456cc	47kW (64PS)	Diesel	TD28871
WD 411.85	4cyl.	3456cc	51kW (69PS)	Diesel	TD28872
WD 411.86	4cyl.	3456cc	51kW (69PS)	Diesel	TD28873
WD 411.87	4cyl.	3456cc	59kW (80PS)	Diesel	TD28874
WD 611, WD611	6cyl.	5184cc		Diesel	FM6193

08-362000-00	STD	100.00	2.500		001 CR P	KV1
			2.500		005 IF P	STD
			4.000		231 CR P	STD

3

WD 1015, WD1015	10cyl.	14955cc		Diesel	FM6196
-----------------	--------	---------	--	--------	--------

08-362200-10	STD	126.00	3.500		008 IF MO P	KV1
			3.000		001 IF MO P	STD
			3.000		026	STD
			5.000		231 CR P	STD



4

WD 615.00	6cyl.	9726cc	148kW (201PS)	Diesel	Turbo	TD8990
WD 615.00	6cyl.	9726cc	148kW (201PS)	Diesel	Turbo	FM6197
WD 615.20	6cyl.	9726cc	148kW (201PS)	Diesel	Turbo	TD8991
WD 615.60	6cyl.	9726cc	191kW (260PS)	Diesel	Turbo	TD8993
WD 615.61	6cyl.	9726cc	191-198kW (260-269PS)	Diesel	Turbo	TD8994
WD 615.63	6cyl.	9726cc	204-206kW (278-280PS)	Diesel	Turbo Intercooled	TD8962
WD 615.64	6cyl.	9726cc	175-177kW (238-241PS)	Diesel	Turbo	TD8960
WD 615.65	6cyl.	9726cc	206kW (280PS)	Diesel	Turbo	TD8997
WD 615.67	6cyl.	9726cc	206kW (280PS)	Diesel	Turbo	TD5895
WD 615.68	6cyl.	9726cc	225-228kW (306-310PS)	Diesel	Turbo Intercooled	TD5883
WD 615.69	6cyl.	9726cc	206kW (280PS)	Diesel	Turbo	TD6242
WD 615.70	6cyl.	9726cc	191kW (260PS)	Diesel	Turbo	TD8995
WD 615.71	6cyl.	9726cc	191kW (260PS)	Diesel	Turbo	TD8996
WD 615.73	6cyl.	9726cc	204kW (277PS)	Diesel	Turbo	TD8963
WD 615.74	6cyl.	9726cc	175kW (238PS)	Diesel	Turbo	TD8961
WD 615.75	6cyl.	9726cc	206kW (280PS)	Diesel	Turbo	TD8998
WD 615.77	6cyl.	9726cc	206kW (280PS)	Diesel	Turbo	TD6311
WD 615.93	6cyl.	9726cc	206kW (280PS)	Diesel	Turbo	TD9005

08-362100-10	STD	126.00	3.500		008 IF MO P	KV1
			3.000		005	STD
			4.000		231 CR P	STD

MODEL INDEX

Modelverzeichnis • Index de modele • Índice de Modelo
Indeks modelu • Модель автомобиля • دليل المحرك



CCM

x



9

12/03→	Justy 1.3 TDI 16v	Z 13 DT	Diesel	1248	4	1
05/87→10/95	JUSTY I 1000	EF10	Petrol	997	3	5
11/84→06/89	JUSTY I 1000	EF10	Petrol	997	3	5
05/87→11/94	JUSTY I 1000 4WD	EF10	Petrol	997	3	5
11/84→12/90	JUSTY I 1000 4WD	EF10	Petrol	997	3	5
09/03→	Justy III 1.3	M13A	Petrol	1328	4	6
01/07→	Justy IV 1.0	1KR-FE Euro 4	Petrol	998	3	2
03/79→10/84	Leone I 1600	EA71	Petrol	1595	4	7
09/80→10/84	Leone I 1800 4WD	EA81	Petrol	1782	4	7
03/79→10/84	Leone I Estate 1600	EA71	Petrol	1595	4	7
03/79→10/84	Leone I Estate 1600 4WD	EA71	Petrol	1595	4	7
09/80→10/84	Leone I Estate 1800 4WD	EA81	Petrol	1782	4	7
09/80→10/84	Leone I Estate 1800 Super 4WD	EA81	Petrol	1782	4	7
03/79→10/84	Leone I Hatchback 1600	EA71	Petrol	1595	4	7
09/80→10/84	Leone I Hatchback 1800 4WD	EA81	Petrol	1782	4	7
09/80→10/84	Leone I Hatchback 1800 Turismo 4WD	EA81	Petrol	1782	4	7
06/85→07/90	Leone II 1.6	EA71	Petrol	1595	4	7
08/86→07/89	Leone II 1.8 GL	EA81	Petrol	1782	4	7
11/84→09/91	Leone II 1600	EA71	Petrol	1595	4	7
01/90→	Leone II 1600 4WD	EA71	Petrol	1595	4	7
01/90→	Leone II Estate 1600	EA71	Petrol	1595	4	7
01/87→01/89	Leone II Estate 1600 4WD	EA71	Petrol	1595	4	7
01/90→	Leone II Estate 1600 4WD	EA71	Petrol	1595	4	7
01/83→12/87	LIBERO Bus 1.0 4WD	EF10	Petrol	997	3	5
06/78→04/81	MV 1.6	EA71	Petrol	1595	4	7
05/81→08/86	MV 1.8	EA81	Petrol	1782	4	7
08/77→08/81	Rex I 550	EK23	Petrol	544	2	4
08/81→06/87	Rex II 550	EK23	Petrol	544	2	4
08/83→06/87	Rex II 550 4WD	EK23	Petrol	544	2	4
08/82→06/89	Rex II 700	EK42	Petrol	655	2	5
03/11→	Trezia 1.4 D	1ND-TV	Diesel	1364	4	3

Motorverzeichnis • Index de moteur • Índice de Motor
Indeks silnika • Модель двигателя • دليل المحرك

ENGINE INDEX



CCM

x



9

1KR-FE Euro 4	Petrol	998	3	71.00	2
1ND-TV	Diesel	1364	4	73.00	3
EA71	Petrol	1595	4	92.00	7
EA81	Petrol	1782	4	92.00	7
EF10	Petrol	997	3	78.00	5
EK23	Petrol	544	2	76.00	4
EK42	Petrol	655	2	78.00	5
M13A	Petrol	1328	4	78.00	6
Z 13 DT	Diesel	1248	4	69.60	1



Justy 1.3 TDI 16v		12/03→	Z 13 DT		4cyl. 1248cc 51kW (69PS)		1
				Diesel	Turbo Intercooled	TD21369	
08-137600-00	STD	69.60	2.000		001 CK P		KV1
08-137606-00	0.40mm		1.500		023 P		F12/F14
[R66830]			2.000		231 P		F12/F14
Justy IV 1.0		01/07→	1KR-FE Euro 4		3cyl. 998cc 50-51kW (68-70PS)		2
						TD26119	
08-439600-00	STD	71.00	1.000		001 IF CR		ST
			1.000		026		ST
			1.500		231 PVD		ST
Trezia 1.4 D		03/11→	1ND-TV		4cyl. 1364cc 55-66kW (75-90PS)		3
					Diesel	Turbo Intercooled	TD25016
08-898400-00	STD	73.00	1.500		001 NT		ST
08-898407-00	0.50mm		1.500		005 CR		STD
			3.000		231 NT		ST
Rex I 550		08/77→08/81	EK23		2cyl. 544cc 23kW (31PS)		4
Rex II 550		08/81→06/87					
Rex II 550 4WD		08/83→06/87					TD13168
08-962800-00	STD	76.00	1.500		001 CR P		IKA
[R40370]			1.500		026 P		STD
			2.800		236 P		STD
JUSTY I 1000		11/84→10/95	EF10		3cyl. 997cc 37-41kW (50-56PS)		5
JUSTY I 1000 4WD		11/84→11/94					
LIBERO Bus 1.0 4WD		01/83→12/87					TD3629
Rex II 700		08/82→06/89	EK42		2cyl. 655cc 27kW (37PS)		TD13171
08-960300-00	STD	78.00	1.200		001 CR P		KV1
			1.500		005 P		STD
			2.800		236 P		STD



Justy III 1.3	09/03→	M13A	4cyl. 1328cc	60-69kW (82-94PS)	6
					TD24894

08-440200-00	STD	78.00	1.200		001 IF NT	ST
			1.500		026 P	STD
			2.800		712 NT	ST

Leone I 1600, Leone I Estate 1600, Leone I Estate 1600 4WD, Leone I Hatchback 1600	03/79→10/84	EA71	4cyl. 1595cc	52-63kW (71-86PS)	7
Leone II 1.6	06/85→07/90				
Leone II 1600	11/84→09/91				
Leone II 1600 4WD, Leone II Estate 1600	01/90→				
Leone II Estate 1600 4WD	01/87→				
MV 1.6	06/78→04/81				TD11131

Leone I 1800 4WD, Leone I Estate 1800 4WD, Leone I Estate 1800 Super 4WD, Leone I Hatchback 1800 4WD, Leone I Hatchback 1800 Turismo 4WD	09/80→10/84	EA81	4cyl. 1782cc	59-60kW (80-82PS)	
Leone II 1.8 GL	08/86→07/89				
MV 1.8	05/81→08/86				TD3622

08-960500-00	STD	92.00	1.200		001 CR P	IKA	
			[R42210]	1.500		005 P	STD
				4.000		712 CR	ST



CCM

x



9

10/83→12/85	Alto I 0.8	F8A	Petrol	797	4	1
06/82→12/85	Alto I 0.8	F8B	Petrol	796	3	3
01/86→11/93	Alto II 0.8	F8B	Petrol	796	3	3
00/81→	Alto/Carry 600	F5A	Petrol	543	3	1
11/80→10/85	Carry Box 0.8	F8A	Petrol	797	4	1
03/98→07/03	Grand Vitara I 1.3	M13A	Petrol	1328	4	10
07/01→07/03	Grand Vitara I 2.0 HDI 110 16V	DW10ATED4 (RHW)	Diesel	1997	4	14
03/98→07/03	Grand Vitara I 2.0 TD	RF	Diesel	1998	4	15
08/06→	Grand Vitara II 1.3	M13A	Petrol	1328	4	10
10/00→09/03	Ignis 1.3	M13A	Petrol	1328	4	10
10/00→09/03	Ignis 1.3 4WD	M13A	Petrol	1328	4	10
09/03→	Ignis II 1.3	M13A	Petrol	1328	4	10
09/03→	Ignis II 1.3 4x4	M13A	Petrol	1328	4	10
09/03→	Ignis II 1.3 DDiS	Z 13 DT	Diesel	1248	4	4
02/01→	Jimny 1.3 16V	M13A	Petrol	1328	4	10
02/01→	Jimny 1.3 16V 4WD	M13A	Petrol	1328	4	10
08/05→	Jimny 1.3 16V 4x4	M13A	Petrol	1328	4	10
09/00→08/02	Jimny 1.3 4x4	M13A	Petrol	1328	4	10
12/03→	Jimny 1.5 DDiS 4WD	K9K 700	Diesel	1461	4	9
03/02→	Liana 1.3	M13A	Petrol	1328	4	10
01/80→01/84	LJ 80 0.8	F8A	Petrol	797	4	1
11/88→12/04	Samurai 1.0 All-wheel Drive	F10A	Petrol	970	4	2
11/88→12/04	Samurai 1.3	G13A	Petrol	1324	4	7
11/98→12/04	Samurai 1.9 TD	XUD9	Diesel	1905	4	12
09/81→12/88	SJ 410 1.0	F10A	Petrol	970	4	2
09/81→12/88	SJ 410 Cabrio 1.0	F10A	Petrol	970	4	2
09/84→08/90	SJ 413 1.3	G13A	Petrol	1324	4	7
01/08→	Splash 1.3 CDTI	Z13DTJ Euro 4	Diesel	1248	4	5
10/85→03/99	Super Carry Bus 1.0	F10A	Petrol	970	4	2
10/83→03/89	Swift I 1.0	G10	Petrol	993	3	7
10/83→03/89	Swift I 1.0	G10A	Petrol	993	3	7
02/85→12/89	Swift I 1.0 Turbo	G10T	Petrol	993	3	7
10/84→03/89	Swift I 1.3	G13A	Petrol	1324	4	7
08/85→03/89	Swift I 1.3 GTi/GXi	G13B	Petrol	1298	4	7
03/89→05/01	Swift II Hatchback 1.0	G10A	Petrol	993	3	7
03/89→05/01	Swift II Hatchback 1.0 i	G10A	Petrol	993	3	7
03/89→05/01	Swift II Hatchback 1.3	G13A	Petrol	1324	4	7
03/89→05/01	Swift II Hatchback 1.3 4WD	G13A	Petrol	1324	4	7
03/89→05/01	Swift II Hatchback 1.3 GTi	G13B	Petrol	1298	4	7
03/89→05/01	Swift II Saloon 1.3	G13A	Petrol	1324	4	7
02/05→	Swift III 1.3	M13A	Petrol	1328	4	10
02/05→	Swift III 1.3 4x4	M13A	Petrol	1328	4	10
08/05→	Swift III 1.3 DDiS	Z 13 DT	Diesel	1248	4	4
08/05→	Swift III 1.3 DDiS	Z13DTJ Euro 4	Diesel	1248	4	5
04/07→	SX4 1.6 DDiS	9HX Euro 4	Diesel	1560	4	8
07/09→	SX4 2.0 DDiS	D20AA Euro 5	Diesel	1956	4	11
07/09→	SX4 2.0 DDiS 4x4	D20AA Euro 5	Diesel	1956	4	11
08/96→03/98	Vitara 1.9 D	XUD9SD	Diesel	1905	4	13
12/94→03/98	Vitara 2.0 TD	RF	Diesel	1998	4	15
12/95→03/98	Vitara 2.0 TD Intercooler	RF	Diesel	1998	4	15
08/96→03/99	Vitara Cabrio 1.9 D	XUD9SD	Diesel	1905	4	13
07/03→08/05	Wagon R 1.0	G10A	Petrol	993	3	7
06/04→08/05	Wagon R 1.0	Z 10 XEP	Petrol	998	3	6
06/04→08/05	Wagon R 1.2	Z 12 XEP	Petrol	1229	4	6
08/01→	Wagon R+ 1.3	M13A	Petrol	1328	4	10
09/03→	Wagon R+ 1.3 4WD	M13A	Petrol	1328	4	10
09/03→	Wagon R+ 1.3 DDiS	Z 13 DT	Diesel	1248	4	4

ENGINE INDEX

Motorverzeichnis • Index de moteur • Índice de Motor
Indeks silnika • Модель двигателя • دليل المحرك



CCM

x



9

9HX Euro 4	Diesel	1560	4	75.00	8
D20AA Euro 5	Diesel	1956	4	83.00	11
DW10ATED4 (RHW)	Diesel	1997	4	85.00	14
F5A	Petrol	543	3	62.00	1
F8A	Petrol	797	4	62.00	1
F8B	Petrol	796	3	68.50	3
F10A	Petrol	970	4	65.50	2
G10	Petrol	993	3	74.00	7
G10A	Petrol	993	3	74.00	7
G10T	Petrol	993	3	74.00	7
G13A	Petrol	1324	4	74.00	7
G13B	Petrol	1298	4	74.00	7
K9K 700	Diesel	1461	4	76.00	9
M13A	Petrol	1328	4	78.00	10
RF	Diesel	1998	4	86.00	15
XUD9	Diesel	1905	4	83.00	12
XUD9SD	Diesel	1905	4	83.00	13
Z 10 XEP	Petrol	998	3	73.40	6
Z 12 XEP	Petrol	1229	4	73.40	6
Z 13 DT	Diesel	1248	4	69.60	4
Z13DTJ Euro 4	Diesel	1248	4	69.60	5



Alto/Carry 600		00/81→	F5A		3cyl. 543cc	22kW (30PS)	1
TD3652							

Alto I 0.8		10/83→12/85	F8A		4cyl.		
Carry Box 0.8		11/80→10/85			797cc	27-29kW (37-39PS)	
LJ 80 0.8		01/80→01/84					TD4910

08-960100-00 [R48510]	STD	62.00	1.500		001 CR P	IKA
			1.500		005 P	STD
			2.800		236 P	STD

Samurai 1.0 All-wheel Drive		11/88→12/04	F10A		4cyl.		2
SJ 410 1.0, SJ 410 Cabrio 1.0		09/81→12/88			970cc	30-33kW (41-45PS)	
Super Carry Bus 1.0		10/85→03/99					TD3650

08-960200-00 08-960207-00 [R41260]	STD 0.50mm	65.50	1.500		001 CR P	IKA
			1.500		026 P	STD
			2.800		236 P	STD

Alto I 0.8		06/82→12/85	F8B		3cyl.		3
Alto II 0.8		01/86→11/93			796cc	29kW (39PS)	
TD3655							

08-962900-00	STD	68.50	1.500		001 CR P	IKA
			1.500		026 P	STD
			2.800		231 CR P	STD

Ignis II 1.3 DDiS		09/03→	Z 13 DT		4cyl.		4
Swift III 1.3 DDiS		08/05→			1248cc	51kW (69PS)	
Wagon R+ 1.3 DDiS		09/03→					TD18265
					Diesel	Turbo Intercooled	

08-137600-00 08-137606-00 [R66830]	STD 0.40mm	69.60	2.000		001 CK P	KV1
			1.500		023 P	F12/F14
			2.000		231 P	F12/F14

Splash 1.3 CDTI		01/08→	Z13DTJ Euro 4		4cyl.		5
Swift III 1.3 DDiS		08/05→			1248cc	55kW (75PS)	
					Diesel	Turbo Intercooled	TD21665

08-425600-00 08-425606-00 08-425608-00	STD 0.40mm 0.60mm	69.60	2.000		001 CK P	KV4
			1.500		005 NT	F12/F14
			2.000		231 CR P	GOE13



Wagon R 1.0	06/04 → 08/05	Z 10 XEP	3cyl. 998cc	44kW (60PS)	6
					TD27099

Wagon R 1.2	06/04 → 08/05	Z 12 XEP	4cyl. 1229cc	59kW (80PS)	
					TD19903

08-429500-00	STD	73.40	1.200		001 NT	ST
08-429507-00	0.50mm		1.200		026 P	F12/F14
			2.000		712 CR	ST

Swift I 1.0	10/83 → 03/89	G10	3cyl. 993cc	37-40kW (50-54PS)	7
					TD18370

Swift I 1.0	10/83 → 03/89	G10A	3cyl. 993cc	37-40kW (50-54PS)	TD3658
Swift II Hatchback 1.0,	03/89 → 05/01				
Swift II Hatchback 1.0 i					
Wagon R 1.0	07/03 → 08/05				

Swift I 1.0 Turbo	02/85 → 12/89	G10T	3cyl. 993cc	52-59kW (71-80PS)	
					TD26633

Samurai 1.3	11/88 → 12/04	G13A	4cyl. 1324cc	44-54kW (60-73PS)	TD3659
SJ 413 1.3	09/84 → 08/90				
Swift I 1.3	10/84 → 03/89				
Swift II Hatchback 1.3,	03/89 → 05/01				
Swift II Hatchback 1.3 4WD,					
Swift II Saloon 1.3					

Swift I 1.3 GTi/GXi	08/85 → 03/89	G13B	4cyl. 1298cc	44-74kW (60-101PS)	TD4915
Swift II Hatchback 1.3 GTi	03/89 → 05/01				

08-961800-00	STD	74.00	1.200		001 CR P	KV1
08-961807-00	0.50mm		1.500		005 P	STD
<i>[R45830]</i>			2.800		236 P	STD

SX4 1.6 DDIS	04/07 →	9HX Euro 4	4cyl. 1560cc	66kW (89PS)	8
					TD21659
			Diesel	Turbo Intercooled	

08-424000-00	STD	75.00	3.000		008 CK P	KV1
08-424007-00	0.50mm		1.950		005 P	F12/F14
08-424008-00	0.60mm		2.500		231 LKZ CR P	GOE12



Jimny 1.5 DDiS 4WD		12/03→	K9K 700		4cyl. 1461cc 48-50kW (65-68PS)		9
					Diesel	Turbo Intercooled	TD21367
08-123400-00	STD	76.00	2.000		001 IF CK P		KV1
08-123407-00	0.50mm		2.000		005 IFU P		GOE13
[R60620]			2.500		231 NT		GOE13

Grand Vitara I 1.3		03/98→07/03	M13A		4cyl. 1328cc 60-69kW (82-94PS)		10
Grand Vitara II 1.3		08/06→					
Ignis 1.3, Ignis 1.3 4WD		10/00→09/03					
Ignis II 1.3, Ignis II 1.3 4x4		09/03→					
Jimny 1.3 16V, Jimny 1.3 16V 4WD		02/01→					
Jimny 1.3 16V 4x4		08/05→					
Jimny 1.3 4x4		09/00→08/02					
Liana 1.3		03/02→					
Swift III 1.3, Swift III 1.3 4x4		02/05→					
Wagon R+ 1.3		08/01→					
Wagon R+ 1.3 4WD		09/03→					TD17430
08-440200-00	STD	78.00	1.200		001 IF NT		ST
			1.500		026 P		STD
			2.800		712 NT		ST

SX4 2.0 DDiS, SX4 2.0 DDiS 4x4		07/09→	D20AA Euro 5		4cyl. 1956cc 99kW (135PS)		11
					Diesel	Turbo Intercooled	TD23550
08-436500-00	STD	83.00	1.500		001 GDC P		KV4
08-436506-00	0.40mm		1.500		050 P		F12/F14
			2.000		231 LKZ CK P		GOE13

Samurai 1.9 TD		11/98→12/04	XUD9		4cyl. 1905cc 46-55kW (63-75PS)		12
					Diesel	Turbo Intercooled	TD16375
08-152000-00	STD	83.00	2.000		001 CR P		KV1
08-152003-00	0.125mm		2.000		005 P		STD
08-152007-00	0.50mm		3.000		231 CR P		STD
08-152010-00	0.80mm						
08-152011-00	1.00mm						
[R66390]							



Vitara 1.9 D	08/96→03/98	XUD9SD							
Vitara Cabrio 1.9 D	08/96→03/99		4cyl.						13
			1905cc	55kW (75PS)					
		Diesel							TD22439

08-105500-00	STD	83.00	3.000		008 CK		KV1	
08-105507-00	0.50mm				005 IF NT		IKA	
08-105510-00	0.80mm			2.000				
01/1997→			3.000		231 CR P		STD	
[R60140]								
08-325500-00	STD	83.00	3.500		008 MOL P		KV1	
08-325507-00	0.50mm			2.000		005 P		STD
→12/1996				3.000		231 CR P		STD
[R49920]								

Grand Vitara I 2.0 HDI 110 16V	07/01→07/03	DW10ATED4 (RHW)							
			4cyl.						14
			1997cc	80kW (109PS)					
		Diesel	Turbo Intercooled						TD18270

08-114700-00	STD	85.00	3.500		008 CK P		KV1	
08-114708-00	0.60mm			2.000		005 IFU P		STD
[R60410]				3.000		231 CR P		STD

Grand Vitara I 2.0 TD	03/98→07/03	RF							
Vitara 2.0 TD	12/94→03/98		4cyl.						15
Vitara 2.0 TD Intercooler	12/95→03/98		1998cc	52-68kW (71-92PS)					
		Diesel	Turbo Intercooled						TD5444

08-283600-00	STD	86.00	2.000		001 CR P		KV1	
08-283607-00	0.50mm			2.000		005 IW P		STD
08-283611-00	1.00mm			4.000		231 CR P		STD
[R42580]								

CCM

x



01/69→12/79	1000 GLS	351	Petrol	1118	4	3
01/69→12/79	1000 Rallye	351	Petrol	1118	4	3
01/69→12/79	1000 Special	351	Petrol	1118	4	3
01/71→12/82	1100 ES	350S	Petrol	1118	4	3
01/73→	1100 Fourgonette VF1	350S	Petrol	1118	4	3
01/73→	1100 Fourgonette VF2	350S	Petrol	1118	4	3
01/73→	1100 Fourgonette VF3	350S	Petrol	1118	4	3
01/71→12/82	1100 GLS	350S	Petrol	1118	4	3
01/71→12/82	1100 L	350S	Petrol	1118	4	3
01/71→12/82	1100 LE	350S	Petrol	1118	4	3
01/71→12/82	1100 LS	350S	Petrol	1118	4	3
01/71→12/82	1100 LX	350S	Petrol	1118	4	3
01/63→12/70	1300	312	Petrol	1290	4	3
01/63→12/70	1301	312	Petrol	1290	4	3
01/82→	Express	U25/651	Diesel	2500	4	10
01/87→12/90	Express	U25/673	Diesel	2500	4	9
01/90→12/94	Express 290	M25/648	Diesel	2500	4	9
01/90→	Express 290	U25/651	Diesel	2500	4	10
01/90→	Express 290	U25/673	Diesel	2500	4	9
01/90→12/94	Express 310	M25/648	Diesel	2500	4	9
01/90→	Express 310	U25/651	Diesel	2500	4	10
01/90→	Express 310	U25/673	Diesel	2500	4	9
01/90→12/94	Express 350	M25/648	Diesel	2500	4	9
01/90→	Express 350	U25/651	Diesel	2500	4	10
01/90→	Express 350	U25/673	Diesel	2500	4	9
07/87→10/90	Express 1000 -1500 Bus 1.9 D	XUD9A	Diesel	1905	4	7
07/82→10/90	Express 1000 -1500 Bus 2.0	XN1TA	Petrol	1971	4	8
07/82→10/94	Express 1000 -1500 Platform/Chassis 2.0	XN1TA	Petrol	1971	4	8
07/87→10/90	Express 1000 -1800 Box 1.9 D	XUD9A	Diesel	1905	4	7
07/82→10/90	Express 1000 -1800 Box 2.0	XN1TA	Petrol	1971	4	8
01/89→12/90	Express 1400	M25/648	Diesel	2500	4	9
01/90→12/94	Express Sportsman	M25/648	Diesel	2500	4	9
01/90→	Express Sportsman	U25/651	Diesel	2500	4	10
01/90→	Express Sportsman	U25/673	Diesel	2500	4	9
02/78→01/80	Horizon 1.3	2G1	Petrol	1294	4	5
07/79→06/86	Horizon 1.4	Y1/Y2	Petrol	1442	4	5
07/79→06/86	Horizon 1.4	Y2	Petrol	1442	4	5
07/82→06/86	Horizon 1.9 Diesel	XUD9	Diesel	1905	4	7
01/74→03/78	Matra Bagheera 1.3	3G4/366	Petrol	1294	4	5
12/75→09/80	Matra Bagheera 1.4	6Y4	Petrol	1442	4	5
11/79→09/80	Matra Bagheera 1.4	Y2	Petrol	1442	4	5
11/81→01/86	Samba	XV 8	Petrol	954	4	1
11/81→01/86	Samba	XV5	Petrol	954	4	1
01/82→12/86	Samba	XY 6B	Petrol	1360	4	4
01/81→06/86	Samba 1.1	XW7	Petrol	1124	4	2
01/83→10/86	Samba 1.2 Rallye	XZ7R	Petrol	1219	4	4
06/83→10/86	Samba 1.4	150 D	Petrol	1351	4	4
01/81→06/86	Samba 1.4	XY7	Petrol	1360	4	4
01/81→06/86	Samba 1.4	XY8	Petrol	1360	4	4
01/83→10/86	Samba 1.4 Rallye	XY8	Petrol	1360	4	4
01/81→06/86	Samba Convertible 1.4	XY8	Petrol	1360	4	4
10/72→09/77	Simca 1000 1.3 Rallye 1	1G1 / 371	Petrol	1294	4	5
08/74→09/77	Simca 1000 1.3 Spezial	1G1 / 371	Petrol	1294	4	5
10/68→05/72	Simca 1100 Break/Tourisme 1.1	3E1	Petrol	1118	4	3
10/76→09/79	Simca 1100 Break/Tourisme 1.1	3E1A	Petrol	1118	4	3
10/76→01/80	Simca 1100 Break/Tourisme 1.1	E1/BTC	Petrol	1118	4	3
10/76→01/80	Simca 1100 Hatchback 1.1 LE, LX, GLS, ES	3E1	Petrol	1118	4	3
10/76→01/80	Simca 1100 Hatchback 1.1 LE, LX, GLS, ES	3E1A	Petrol	1118	4	3
11/73→09/77	Simca 1100 Hatchback 1.1 LS, GLS	E1/BTC	Petrol	1118	4	3
10/72→09/77	Simca 1100 Hatchback 1.3 Spezial TI	3G4/366	Petrol	1294	4	5

MODEL INDEX

Modelverzeichnis • Index de modele • Índice de Modelo
Indeks modelu • Модель автомобиля • دليل المحرك



CCM

x



9

02/80→06/81	Solara 1.6	J2	Flexfuel	1592	4	6
	Tagora 2.3 D	XD2	Diesel	2304	4	11
08/81→12/87	Tagora 2.3 Turbo Diesel	XD2S (U8)	Diesel	2304	4	12
08/81→10/83	Tagora 2.6	L6	Petrol	2664	6	8

ENGINE INDEX

Motorverzeichnis • Index de moteur • Índice de Motor
Indeks silnika • Модель двигателя • دليل المحرك



CCM

x



9

1G1 / 371	Petrol	1294	4	76.70	5
2G1	Petrol	1294	4	76.70	5
3E1	Petrol	1118	4	74.00	3
3E1A	Petrol	1118	4	74.00	3
3G4/366	Petrol	1294	4	76.70	5
6Y4	Petrol	1442	4	76.70	5
150 D	Petrol	1351	4	75.00	4
312	Petrol	1290	4	74.00	3
350S	Petrol	1118	4	74.00	3
351	Petrol	1118	4	74.00	3
E1/BTC	Petrol	1118	4	74.00	3
J2	Flexfuel	1592	4	80.60	6
L6	Petrol	2664	6	88.00	8
M25/648	Diesel	2500	4	93.00	9
U25/651	Diesel	2500	4	93.00	10
U25/673	Diesel	2500	4	93.00	9
XD2	Diesel	2304	4	94.00	11
XD2S (U8)	Diesel	2304	4	94.00	12
XN1TA	Petrol	1971	4	88.00	8
XUD9	Diesel	1905	4	83.00	7
XUD9A	Diesel	1905	4	83.00	7
XV 8	Petrol	954	4	70.00	1
XV5	Petrol	954	4	70.00	1
XW7	Petrol	1124	4	72.00	2
XY 6B	Petrol	1360	4	75.00	4
XY7	Petrol	1360	4	75.00	4
XY8	Petrol	1360	4	75.00	4
XZ7R	Petrol	1219	4	75.00	4
Y1/Y2	Petrol	1442	4	76.70	5
Y2	Petrol	1442	4	76.70	5



Samba	11/81→01/86	XV 8	4cyl. 954cc	33kW (45PS)	1
TD17983					

Samba	11/81→01/86	XV5	4cyl. 954cc	31-34kW (42-46PS)	2
TD17982					

08-317300-00	STD	70.00	2.000		001 IF CR P	STD
<i>[R66100]</i>			2.000		026 P	STD
			4.000		712 CR	ST

Samba 1.1	01/81→06/86	XW7	4cyl. 1124cc	37kW (50PS)	2
TD4927					

08-319400-00	STD	72.00	1.500		001 IF CR P	STD
<i>[R66090]</i>			2.000		026 P	STD
			4.000		712 CR	ST

1300, 1301	01/63→12/70	312	4cyl. 1290cc	37kW (50PS)	3
FM1595					

1100 ES	01/71→12/82	350S	4cyl. 1118cc	44kW (60PS)	3
1100 Fourgonette VF1,	01/73→				
1100 Fourgonette VF2,					
1100 Fourgonette VF3					
1100 GLS, 1100 L, 1100 LE, 1100 LX	01/71→12/82				FM4303

1000 GLS, 1000 Rallye, 1000 Special	01/69→12/79	351	4cyl. 1118cc	44kW (60PS)	3
FM4595					

Simca 1100 Break/Tourisme 1.1	10/68→05/72	3E1	4cyl. 1118cc	37-41kW (50-56PS)	3
Simca 1100 Hatchback 1.1 LE, LX, GLS, ES	10/76→01/80				TD3675

Simca 1100 Break/Tourisme 1.1	10/76→09/79	3E1A	4cyl. 1118cc	43-44kW (58-60PS)	3
Simca 1100 Hatchback 1.1 LE, LX, GLS, ES	10/76→01/80				TD5300

Simca 1100 Break/Tourisme 1.1	10/76→01/80	E1/BTC	4cyl. 1118cc	36-41kW (49-56PS)	3
Simca 1100 Hatchback 1.1 LS, GLS	11/73→09/77				TD3684

08-344500-00	STD	74.00	1.750		001 IF CR P	IKA
<i>[R66370]</i>			2.000		026 P	STD
			4.000		712 CR	ST



Samba 1.4	06/83→10/86	150 D	4cyl. 1351cc	44kW (60PS)	4	TD5291
Samba	01/82→12/86	XY 6B	4cyl. 1360cc	44-53kW (60-72PS)		TD17984
Samba 1.4	01/81→06/86	XY7	4cyl. 1360cc	53kW (72PS)		TD4928
Samba 1.4 Samba 1.4 Rallye Samba Convertible 1.4	01/81→06/86 01/83→10/86 01/81→06/86	XY8	4cyl. 1360cc	59kW (80PS)		TD4929
Samba 1.2 Rallye	01/83→10/86	XZ7R	4cyl. 1219cc	65kW (88PS)		TD5292

08-154400-00	STD	75.00	1.750		001 IF CR P	IKA
08-154407-00	0.50mm		2.000		026 P	STD
[R60880]			3.000		236 P	STD
08-334200-00	STD	75.00	1.750		001 IF CR P	IKA
08-334207-00	0.50mm		2.000		026 P	STD
[R66320]			4.000		712 CR	ST

Simca 1000 1.3 Rallye 1 Simca 1000 1.3 Spezial	10/72→09/77 08/74→09/77	1G1 / 371	4cyl. 1294cc	44kW (60PS)	5	TD5289
Horizon 1.3	02/78→01/80	2G1	4cyl. 1294cc	50kW (68PS)		TD3674
Matra Bagheera 1.3 Simca 1100 Hatchback 1.3 Spezial TI	01/74→03/78 10/72→09/77	3G4/366	4cyl. 1294cc	60-62kW (82-84PS)		TD5299
Matra Bagheera 1.4	12/75→09/80	6Y4	4cyl. 1442cc	62-66kW (84-90PS)		TD27242
Horizon 1.4	07/79→06/86	Y1/Y2	4cyl. 1442cc	51kW (69PS)		TD3697





Horizon 1.4			07/79→06/86	Y2				
Matra Bagheera 1.4			11/79→09/80		4cyl.			
					1442cc	61kW (82PS)		TD4930
08-346000-00	STD	76.70	1.750		001 IF CR P			IKA
[R66380]			2.000		026 P			STD
			4.000		712 CR			ST
Solara 1.6			02/80→06/81	J2				6
					4cyl.			
					1592cc	66kW (89PS)		TD4923
08-348200-00	STD	80.60	1.750		001 IF MO P			IKA
			2.000		026 P			STD
			4.000		712 CR			ST
Horizon 1.9 Diesel			07/82→06/86	XUD9				7
					4cyl.			
					1905cc	48kW (65PS)		TD4924
					Diesel			
Express 1000 -1500 Bus 1.9 D,			07/87→10/90	XUD9A				
Express 1000 -1800 Box 1.9 D					4cyl.			
					1905cc	51kW (69PS)		TD9014
					Diesel			
08-152000-00	STD	83.00	2.000		001 CR P			KV1
08-152003-00	0.125mm							
08-152007-00	0.50mm		2.000		005 P			STD
08-152010-00	0.80mm							
08-152011-00	1.00mm		3.000		231 CR P			STD
[R66390]								
Tagora 2.6			08/81→10/83	L6				8
					6cyl.			
					2664cc	122kW (166PS)		TD5287
Express 1000 -1500 Bus 2.0			07/82→10/90	XN1TA				
Express 1000 -1500 Platform/Chassis 2.0			07/82→10/94		4cyl.			
Express 1000 -1800 Box 2.0			07/82→10/90		1971cc	57-69kW (78-94PS)		TD9015
08-316900-00	STD	88.00	1.500		001 IF CR P			IKA
08-316907-00	0.50mm		2.000		026 P			STD
[R66110]			4.000		712 CR			ST



Express 1400 Express 290, Express 310, Express 350, Express Sportsman	01/89→12/90 01/90→12/94	M25/648	4cyl. 2500cc	70kW (95PS)	9
Diesel Turbo					FM4338

Express Express 290, Express 310, Express 350, Express Sportsman	01/87→12/90 01/90→	U25/673	4cyl. 2500cc	70kW (95PS)	
Diesel Turbo					FM3909

08-152900-00	STD	93.00	3.000		008 MOL P	KV1
[R60990]			2.000		001 IF CR P	STD
			4.000		231 CR P	STD

Express Express 290, Express 310, Express 350, Express Sportsman	01/82→ 01/90→	U25/651	4cyl. 2500cc	52kW (71PS)	10
Diesel					FM1427

08-147300-10 →07/1984	STD	93.00	2.000		001 MOL P	KV1
			2.000		005 IF P	STD
			4.000		231 CR P	STD
08-152700-00 08-152707-00 08/1984→	STD 0.50mm	93.00	2.500		001 MOL P	KV1
[R60970]			2.000		005 IF P	STD
			4.000		231 CR P	STD
08-214400-10 →07/1984	STD	93.00	2.000		001 CR P	KV1
[R60960]			2.000		005 IF P	STD
			4.000		231 CR P	STD

Tagora 2.3 D				XD2	4cyl. 2304cc	44-53kW (60-72PS)	11
Diesel							TD21365

08-318700-10	STD	94.00	2.000		001 CR P	KV1
08-318704-10	0.20mm				005 IF P	STD
08-318706-10	0.40mm		2.000			
08-318707-10	0.50mm				231 CR P	STD
08-318708-10	0.60mm		4.000			
08-318710-10	0.80mm					
08-318711-10	1.00mm					
[R66140]						

Tagora 2.3 Turbo Diesel	08/81→12/87	XD2S (U8)	4cyl. 2304cc	59kW (80PS)	12
Diesel Turbo					TD5288

08-320200-10	STD	94.00	3.000		008 MOL P	IKA
08-320204-10	0.20mm				005 P	IKA
08-320206-10	0.40mm		2.000			
08-320208-10	0.60mm				231 CR P	STD
08-320211-10	1.00mm		4.000			
[R66000]						

CCM
x

08/89→11/95	4 Runner 2.4 TD	2L-T	Diesel	2446	4	28
04/69→08/88	1000 1.0	2K	Petrol	993	4	4
04/69→08/88	1000 Box 1.0	2K	Petrol	993	4	4
06/01→04/05	Allion I 1.5	1NZ-FE	Petrol	1497	4	10
06/01→04/05	Allion I 1.8	1ZZ-FE	Petrol	1794	4	14
06/01→06/07	Allion I 1.8	2ZR-FE	Petrol	1798	4	15
06/01→06/07	Allion I 1.8 4WD	1ZZ-FE	Petrol	1794	4	14
06/01→06/07	Allion I 1.8 4WD	2ZR-FE	Petrol	1798	4	15
07/07→	Allion II 1.5	1NZ-FE	Petrol	1497	4	10
07/07→	Allion II 1.8	2ZR-FAE	Petrol	1798	4	15
07/07→	Allion II 1.8 4WD	2ZR-FAE	Petrol	1798	4	15
09/03→04/08	Alphard I 2.4	2AZ-FXE	Petrol	2362	4	25
09/03→04/08	Alphard I 2.4 Hybrid	2AZ-FXE	Petrol	2362	4	25
09/03→04/08	Alphard I 2.4 Hybrid 4WD	2AZ-FXE	Petrol	2362	4	25
12/11→	Alphard II 2.4 Hybrid	2AZ-FXE	Petrol	2362	4	25
11/00→09/11	Aurion 2.4 Hybrid	2AZ-FXE	Petrol	2362	4	25
03/07→	Auris 1.4 D-4D	1ND-TV	Diesel	1364	4	6
09/09→	Auris 1.5	1NZ-FE	Petrol	1497	4	10
09/09→	Auris 1.5 4WD	1NZ-FE	Petrol	1497	4	10
05/09→	Auris 1.6	1ZR-FAE	Petrol	1598	4	15
03/07→	Auris 1.6 VVTi	1ZR-FE	Petrol	1598	4	15
02/09→	Auris 1.8	2ZR-FAE	Petrol	1798	4	15
02/09→	Auris 1.8 4WD	2ZR-FAE	Petrol	1798	4	15
10/06→	Auris 1.8 VVTi	2ZR-FE	Petrol	1798	4	15
03/07→	Auris 2.2 D	2AD-FHV Euro 4	Diesel	2231	4	22
07/13→	Auris Touring Sports 1.4 D-4D	1ND-TV	Diesel	1364	4	6
07/13→	Auris Touring Sports 1.6	1ZR-FAE	Petrol	1598	4	15
03/07→	Auris Van Box 1.4 D-4D	1ND-TV	Diesel	1364	4	6
09/97→10/00	Avensis 1.6	4A-FE	Petrol	1587	4	17
10/00→11/08	Avensis 1.6 VVT-i	3ZZ-FE	Petrol	1598	4	14
04/03→11/08	Avensis 1.8	1ZZ-FE	Petrol	1794	4	14
10/00→02/03	Avensis 1.8 VVT-i	1ZZ-FE	Petrol	1794	4	14
09/02→02/03	Avensis 1.9 D	1CD-FTV	Diesel	1995	4	19
09/97→10/00	Avensis 2.0	3S-FE	Petrol	1998	4	23
10/99→11/08	Avensis 2.0 D-4D	1CD-FTV	Diesel	1995	4	19
07/05→11/08	Avensis 2.2 D-CAT	2AD-FHV Euro 4	Diesel	2231	4	22
02/09→	Avensis Estate 1.6	1ZR-FAE	Petrol	1598	4	15
04/03→11/08	Avensis Estate 1.6 VVT-i	3ZZ-FE	Petrol	1598	4	14
04/03→11/08	Avensis Estate 1.8	1ZZ-FE	Petrol	1794	4	14
02/09→	Avensis Estate 1.8	2ZR-FAE	Petrol	1798	4	15
04/03→11/08	Avensis Estate 2.0 D-4D	1CD-FTV	Diesel	1995	4	19
04/03→11/08	Avensis Estate 2.0 VVTi	1AZ FE	Petrol	1998	4	21
02/09→	Avensis Estate 2.2 D-4D	2AD-FHV Euro 4	Diesel	2231	4	22
07/05→11/08	Avensis Estate 2.2 D-CAT	2AD-FHV Euro 4	Diesel	2231	4	22
09/97→10/00	Avensis Liftback 1.6	4A-FE	Petrol	1587	4	17
10/00→02/03	Avensis Liftback 1.6 VVT-i	3ZZ-FE	Petrol	1598	4	14
10/00→02/03	Avensis Liftback 1.8 VVT-i	1ZZ-FE	Petrol	1794	4	14
09/97→10/00	Avensis Liftback 2.0	3S-FE	Petrol	1998	4	23
09/02→02/03	Avensis Liftback 2.0 D	1CD-FTV	Diesel	1995	4	19
10/99→02/03	Avensis Liftback 2.0 D-4D	1CD-FTV	Diesel	1995	4	19
02/09→	Avensis Saloon 1.6	1ZR-FAE	Petrol	1598	4	15
04/03→11/08	Avensis Saloon 1.6 VVT-i	3ZZ-FE	Petrol	1598	4	14
04/03→11/08	Avensis Saloon 1.8	1ZZ-FE	Petrol	1794	4	14
02/09→	Avensis Saloon 1.8	2ZR-FAE	Petrol	1798	4	15
04/03→11/08	Avensis Saloon 2.0 D-4D	1CD-FTV	Diesel	1995	4	19
04/03→11/08	Avensis Saloon 2.0 VVTi	1AZ FE	Petrol	1998	4	21
02/09→	Avensis Saloon 2.2 D-4D	2AD-FHV Euro 4	Diesel	2231	4	22
07/05→11/08	Avensis Saloon 2.2 D-CAT	2AD-FHV Euro 4	Diesel	2231	4	22
09/97→10/00	Avensis Station Wagon 1.6	4A-FE	Petrol	1587	4	17
10/00→02/03	Avensis Station Wagon 1.6 VVT-i	3ZZ-FE	Petrol	1598	4	14

MODEL INDEX

Modelverzeichnis • Index de modele • Índice de Modelo
Indeks modelu • Модель автомобиля • دليل الموديل



CCM

x



9

10/00→02/03	Avensis Station Wagon 1.8 VVT-i	1ZZ-FE	Petrol	1794	4	14
09/02→02/03	Avensis Station Wagon 1.9 D	1CD-FTV	Diesel	1995	4	19
09/97→10/00	Avensis Station Wagon 2.0	3S-FE	Petrol	1998	4	23
10/99→02/03	Avensis Station Wagon 2.0 D-4D	1CD-FTV	Diesel	1995	4	19
08/01→08/05	Avensis Verso 2.0 D-4D	1CD-FTV	Diesel	1995	4	19
08/01→11/09	Avensis Verso 2.0 VVT-i	1AZ FE	Petrol	1998	4	21
07/05→	Aygo 1.0	1KR-FE Euro 4	Petrol	998	3	3
07/05→	Aygo 1.0 GPL	1KR-FE Euro 4	Petrol	998	3	3
07/05→08/10	Aygo 1.4 HDi	2WZ-TV	Diesel	1398	4	8
03/00→12/05	BB I 1.5	1NZ-FE	Petrol	1497	4	10
03/82→12/83	Blizzard 2.2	L	Diesel	2188	4	26
02/92→09/97	Caldina 1.6	4A-FE	Petrol	1587	4	17
02/92→10/97	Caldina 2.0	3S-FE	Petrol	1998	4	23
11/86→05/91	Camry 2.0	3S-FE	Petrol	1998	4	23
08/88→05/91	Camry 2.0 4WD	3S-FE	Petrol	1998	4	23
11/86→05/91	Camry 2.0 GLi 16V	3S-FE	Petrol	1998	4	23
10/87→07/88	Camry 2.0 GLi 4WD	3S-FE	Petrol	1998	4	23
08/01→11/06	Camry 2.0 VVTi	1AZ FE	Petrol	1998	4	21
01/06→11/06	Camry 2.4 VVTi Hybrid	2AZ-FXE	Petrol	2362	4	25
06/91→09/97	Camry 2000ZX 4WD	3S-FE	Petrol	1998	4	23
10/84→01/88	Camry Liftback 1.8 Turbo-D	1C-TL	Diesel	1839	4	20
11/83→01/88	Camry Saloon 1.8 Turbo-D	1C-TL	Diesel	1839	4	20
09/11→	Camry Saloon 2.0	1AZ FE	Petrol	1998	4	21
03/83→07/88	Camry Saloon 2.0	3S-FE	Petrol	1998	4	23
03/83→07/86	Camry Saloon 2.0 GLi 4WD	3S-FE	Petrol	1998	4	23
01/06→09/11	Camry Saloon 2.0 VVT-i	1AZ FE	Petrol	1998	4	21
01/06→09/11	Camry Saloon 2.4 VVTi Hybrid	2AZ-FXE	Petrol	2362	4	25
01/06→09/11	Camry Saloon 2.4 VVT-i Hybrid	2AZ-FXE	Petrol	2362	4	25
11/86→06/91	Camry Station Wagon 2.0	3S-FE	Petrol	1998	4	23
11/86→05/91	Camry Station Wagon 2.0 GLi 16V	3S-FE	Petrol	1998	4	23
08/88→05/91	Camry Station Wagon 2.0 GLi 4WD	3S-FE	Petrol	1998	4	23
09/94→08/96	Caribe Estate 1.3	4E-FE	Petrol	1331	4	9
09/94→08/03	Caribe Estate 1.6	4A-FE	Petrol	1587	4	17
10/86→08/94	Caribe Saloon 1.3	2A	Petrol	1295	4	13
04/82→09/83	Carina 1.8 D	1C	Diesel	1839	4	20
12/93→09/97	Carina E 1.6	4A-FE	Petrol	1587	4	17
10/95→09/97	Carina E 1.6 16V	4A-FE	Petrol	1587	4	17
04/92→09/97	Carina E 1.6 GLI	4A-FE	Petrol	1587	4	17
04/92→09/97	Carina E 2.0 GLI	3S-FE	Petrol	1998	4	23
12/93→09/97	Carina E 2.0 i	3S-FE	Petrol	1998	4	23
01/93→09/97	Carina E Saloon 1.6	4A-FE	Petrol	1587	4	17
12/94→09/97	Carina E Saloon 1.6 16V	4A-FE	Petrol	1587	4	17
01/93→09/97	Carina E Saloon 2.0	3S-FE	Petrol	1998	4	23
12/92→09/97	Carina E Saloon 2.0 i	3S-FE	Petrol	1998	4	23
04/92→09/97	Carina E Sportswagon 1.6	4A-FE	Petrol	1587	4	17
01/93→09/97	Carina E Sportswagon 1.6 GLI	4A-FE	Petrol	1587	4	17
02/95→09/97	Carina E Sportswagon 1.6 i	4A-FE	Petrol	1587	4	17
01/93→09/97	Carina E Sportswagon 2.0 GLI	3S-FE	Petrol	1998	4	23
05/95→09/97	Carina E Sportswagon 2.0 i	3S-FE	Petrol	1998	4	23
12/87→03/92	Carina II 1.6	4A-FE	Petrol	1587	4	17
10/83→11/87	Carina II 1.6	4A-LC	Petrol	1587	4	16
06/88→03/92	Carina II 1.6 4WD	4A-FE	Petrol	1587	4	17
12/87→03/92	Carina II 2.0 GLI	3S-FE	Petrol	1998	4	23
12/87→03/92	Carina II Saloon 1.6	4A-FE	Petrol	1587	4	17
10/83→11/87	Carina II Saloon 1.6	4A-LC	Petrol	1587	4	16
12/87→03/92	Carina II Saloon 1.6 4WD	4A-FE	Petrol	1587	4	17
12/87→03/92	Carina II Saloon 2.0	3S-FE	Petrol	1998	4	23
12/87→03/92	Carina II Saloon 2.0 4WD	3S-FE	Petrol	1998	4	23
12/87→03/92	Carina II Saloon 2.0 GLI	3S-FE	Petrol	1998	4	23
12/87→03/92	Carina II Station Wagon 1.6	4A-FE	Petrol	1587	4	17



CCM

x



9

12/87→03/92	Carina II Station Wagon 1.6 GX 4WD	4A-FE	Petrol	1587	4	17
12/87→04/92	Carina II Station Wagon 2.0	3S-FE	Petrol	1998	4	23
12/87→03/92	Carina II Station Wagon 2.0 4WD	3S-FE	Petrol	1998	4	23
12/87→03/92	Carina II Station Wagon 2.0 GLi	3S-FE	Petrol	1998	4	23
04/82→09/83	Carina Station Wagon 1.8 D	1C	Diesel	1839	4	20
08/99→09/05	Celica 1.8 16V TS	2ZZ-GE	Petrol	1796	4	18
08/99→07/05	Celica 1.8 16V VT-i	1ZZ-FE	Petrol	1794	4	14
10/89→11/93	Celica Coupe 1.6 STI	4A-FE	Petrol	1587	4	17
10/92→08/96	Chaser 2.4 D	2L	Diesel	2446	4	28
08/77→04/82	Coaster Bus 2.0	5R	Petrol	1997	4	24
09/85→05/89	Corolla 1.3	2A	Petrol	1295	4	13
08/83→10/01	Corolla 1.3	2E	Petrol	1296	4	7
10/84→08/87	Corolla 1.3	2E-L	Petrol	1296	4	7
10/84→08/87	Corolla 1.3	2E-LC	Petrol	1295	4	7
09/79→06/83	Corolla 1.3	4K	Petrol	1290	4	11
07/92→04/97	Corolla 1.3 12V	2E	Petrol	1296	4	7
08/87→12/92	Corolla 1.3 i	2E	Petrol	1296	4	7
08/87→12/92	Corolla 1.3 i	2E-E	Petrol	1296	4	7
09/95→04/97	Corolla 1.3 XLI	4E-FE	Petrol	1331	4	9
07/92→09/95	Corolla 1.3 XLI 16V	4E-FE	Petrol	1331	4	9
04/97→02/00	Corolla 1.4	4E-FE	Petrol	1331	4	9
07/04→02/07	Corolla 1.4 D	1ND-TV	Diesel	1364	4	6
06/04→12/01	Corolla 1.4 D-4D	1ND-TV	Diesel	1364	4	6
09/99→10/01	Corolla 1.5	1NZ-FE	Petrol	1497	4	10
05/92→02/00	Corolla 1.6	4A-FE	Petrol	1587	4	17
08/85→05/88	Corolla 1.6	4A-LC	Petrol	1587	4	16
02/00→11/01	Corolla 1.6 16V	3ZZ-FE	Petrol	1598	4	14
04/97→02/00	Corolla 1.6 Aut.	4A-FE	Petrol	1587	4	17
11/89→06/93	Corolla 1.6 i	4A-FE	Petrol	1587	4	17
10/87→08/90	Corolla 1.6 i 4WD	4A-FE	Petrol	1587	4	17
09/95→04/97	Corolla 1.6 Si	4A-FE	Petrol	1587	4	17
01/02→12/06	Corolla 1.6 VVT-i	3ZZ-FE	Petrol	1598	4	14
12/01→02/07	Corolla 1.8 4WD	1ZZ-FE	Petrol	1794	4	14
01/83→06/93	Corolla 1.8 D	1C	Diesel	1839	4	20
07/85→05/88	Corolla 1.8 D	1C-L	Diesel	1839	4	20
06/04→02/07	Corolla 1.8 VVTi	1ZZ-FE	Petrol	1794	4	14
01/02→02/07	Corolla 1.8 VVTL-i TS	2ZZ-GE	Petrol	1796	4	18
08/00→02/07	Corolla 2.0 D-4D	1CD-FTV	Diesel	1995	4	19
07/75→01/80	Corolla Combi 1.2	3K	Petrol	1166	4	11
05/87→04/92	Corolla Compact 1.3	2E	Petrol	1296	4	7
07/92→05/95	Corolla Compact 1.3 12V	2E	Petrol	1296	4	7
09/95→04/97	Corolla Compact 1.3 XLI	4E-FE	Petrol	1331	4	9
07/92→09/95	Corolla Compact 1.3 XLI 16V	4E-FE	Petrol	1331	4	9
04/97→02/00	Corolla Compact 1.4	4E-FE	Petrol	1331	4	9
09/99→10/01	Corolla Compact 1.5	1NZ-FE	Petrol	1497	4	10
02/00→01/02	Corolla Compact 1.6	3ZZ-FE	Petrol	1598	4	14
04/97→02/00	Corolla Compact 1.6	4A-FE	Petrol	1587	4	17
04/97→02/00	Corolla Compact 1.6 Aut.	4A-FE	Petrol	1587	4	17
08/89→04/92	Corolla Compact 1.6 i	4A-FE	Petrol	1587	4	17
07/92→04/97	Corolla Compact 1.6 Si	4A-FE	Petrol	1587	4	17
08/87→04/92	Corolla Compact 1.8 D	1C	Diesel	1839	4	20
08/00→01/02	Corolla Compact 2.0 D-4D	1CD-FTV	Diesel	1995	4	19
08/83→04/85	Corolla Coupe 1.6 SR	4A-C	Petrol	1587	4	16
05/83→04/87	Corolla Coupe 1.6 SR 16V	4A-C	Petrol	1587	4	16
07/04→02/07	Corolla Estate 1.4 D4-D	1ND-TV	Diesel	1364	4	6
09/06→	Corolla Estate 1.5	1NZ-FE	Petrol	1497	4	10
09/06→	Corolla Estate 1.5 4WD	1NZ-FE	Petrol	1497	4	10
01/02→02/07	Corolla Estate 1.6 VVT-i	3ZZ-FE	Petrol	1598	4	14
06/04→02/07	Corolla Estate 1.8	1ZZ-FE	Petrol	1794	4	14
09/06→	Corolla Estate 1.8	2ZR-FAE	Petrol	1798	4	15

MODEL INDEX

Modelverzeichnis • Index de modele • Índice de Modelo
 Indeks modelu • Модель автомобиля • دليل الموديل

CCM
x

9

12/01→02/07	Corolla Estate 1.8 4WD	1ZZ-FE	Petrol	1794	4	14
09/06→	Corolla Estate 1.8 4WD	2ZR-FAE	Petrol	1798	4	15
01/02→02/07	Corolla Estate 2.0 D-4D	1CD-FTV	Diesel	1995	4	19
10/84→04/87	Corolla FX Compact 1.3	2E	Petrol	1296	4	7
08/85→08/87	Corolla FX Compact 1.3	2E-L	Petrol	1296	4	7
08/84→08/87	Corolla FX Compact 1.6	4A-C	Petrol	1587	4	16
01/87→09/87	Corolla FX Compact 1.6	4A-LC	Petrol	1587	4	16
01/85→05/88	Corolla FX Compact 1.8 D	1C	Diesel	1839	4	20
08/85→08/87	Corolla FX Compact 1.8 D	1C-L	Diesel	1839	4	20
09/79→05/83	Corolla Hatchback 1.3	4K	Petrol	1290	4	11
01/83→09/83	Corolla Hatchback 1.8 D	1C	Diesel	1839	4	20
09/85→05/89	Corolla Liftback 1.3	2A	Petrol	1295	4	13
08/83→04/92	Corolla Liftback 1.3	2E	Petrol	1296	4	7
01/85→08/87	Corolla Liftback 1.3	2E-L	Petrol	1296	4	7
01/85→08/87	Corolla Liftback 1.3	2E-LC	Petrol	1295	4	7
07/92→05/95	Corolla Liftback 1.3 12V	2E	Petrol	1296	4	7
08/87→04/92	Corolla Liftback 1.3 i	2E	Petrol	1296	4	7
08/87→04/92	Corolla Liftback 1.3 i	2E-E	Petrol	1296	4	7
07/92→04/97	Corolla Liftback 1.3 XLI	4E-FE	Petrol	1331	4	9
04/97→02/00	Corolla Liftback 1.4	4E-FE	Petrol	1331	4	9
02/00→01/02	Corolla Liftback 1.6	3ZZ-FE	Petrol	1598	4	14
08/89→02/00	Corolla Liftback 1.6	4A-FE	Petrol	1587	4	17
04/85→06/89	Corolla Liftback 1.6	4A-LC	Petrol	1587	4	16
04/97→02/00	Corolla Liftback 1.6 Aut.	4A-FE	Petrol	1587	4	17
07/92→04/97	Corolla Liftback 1.6 GLI	4A-FE	Petrol	1587	4	17
06/83→04/92	Corolla Liftback 1.8 D	1C	Diesel	1839	4	20
06/83→08/87	Corolla Liftback 1.8 D	1C-L	Diesel	1839	4	20
09/00→01/02	Corolla Liftback 2.0 D-4D	1CD-FTV	Diesel	1995	4	19
09/07→	Corolla Rumion 1.5	1NZ-FE	Petrol	1497	4	10
09/07→	Corolla Rumion 1.8	2ZR-FAE	Petrol	1798	4	15
09/07→	Corolla Rumion 1.8 4WD	2ZR-FAE	Petrol	1798	4	15
11/01→05/04	Corolla Saloon 1.3	2NZ-FE	Petrol	1299	4	10
03/08→	Corolla Saloon 1.3 VVT-i	2NZ-FE	Petrol	1299	4	10
07/04→	Corolla Saloon 1.4 D-4D	1ND-TV	Diesel	1364	4	6
11/01→	Corolla Saloon 1.5	1NZ-FE	Petrol	1497	4	10
08/07→	Corolla Saloon 1.5 4WD	1NZ-FE	Petrol	1497	4	10
11/01→05/04	Corolla Saloon 1.5 G 4WD	1NZ-FE	Petrol	1497	4	10
01/09→	Corolla Saloon 1.6	1ZR-FAE	Petrol	1598	4	15
11/06→	Corolla Saloon 1.6	1ZR-FE	Petrol	1598	4	15
08/07→	Corolla Saloon 1.6 CNG	3ZZ-FE	Petrol	1598	4	14
01/07→	Corolla Saloon 1.6 Dual VVTi	1ZR-FE	Petrol	1598	4	15
08/02→	Corolla Saloon 1.6 VVT-i	3ZZ-FE	Petrol	1598	4	14
03/01→07/07	Corolla Saloon 1.8	1ZZ-FE	Petrol	1794	4	14
01/09→	Corolla Saloon 1.8	2ZR-FAE	Petrol	1798	4	15
08/07→	Corolla Saloon 1.8 4WD	2ZR-FAE	Petrol	1798	4	15
08/10→	Corolla Saloon 1.8 VVTi	2ZR-FE	Petrol	1798	4	15
05/07→	Corolla Saloon 1.8 VVTL-i	2ZR-FE	Petrol	1798	4	15
08/02→07/07	Corolla Saloon 2.0 D-4D	1CD-FTV	Diesel	1995	4	19
11/06→	Corolla Saloon 2.2 D-4D	2AD-FHV Euro 4	Diesel	2231	4	22
05/87→04/92	Corolla Station Wagon 1.3	2E	Petrol	1296	4	7
02/82→08/87	Corolla Station Wagon 1.3	4K	Petrol	1290	4	11
06/89→06/92	Corolla Station Wagon 1.3 i	2E-E	Petrol	1296	4	7
11/89→06/92	Corolla Station Wagon 1.6 XLI	4A-FE	Petrol	1587	4	17
08/88→06/92	Corolla Station Wagon 1.6 XLI 4WD	4A-FE	Petrol	1587	4	17
05/83→06/92	Corolla Station Wagon 1.8 D	1C	Diesel	1839	4	20
09/01→03/09	Corolla Verso 1.4 D-4D	1ND-TV	Diesel	1364	4	6
03/04→03/09	Corolla Verso 1.5	1NZ-FE	Petrol	1497	4	10
04/04→03/09	Corolla Verso 1.6	3ZZ-FE	Petrol	1598	4	14
01/02→05/04	Corolla Verso 1.6 VVT-i	3ZZ-FE	Petrol	1598	4	14
04/04→03/09	Corolla Verso 1.8	1ZZ-FE	Petrol	1794	4	14

CCM

x



9

01/02→05/04	Corolla Verso 1.8 VVT-i	1ZZ-FE	Petrol	1794	4	14
10/01→02/04	Corolla Verso 1.8 VVTi 4WD	1ZZ-FE	Petrol	1794	4	14
09/01→03/09	Corolla Verso 2.0 D-4D	1CD-FTV	Diesel	1995	4	19
10/05→03/09	Corolla Verso 2.2 D-4D	2AD-FHV Euro 4	Diesel	2231	4	22
07/92→05/95	Corolla Wagon 1.3 12V	2E	Petrol	1296	4	7
09/95→04/97	Corolla Wagon 1.3 XLI	4E-FE	Petrol	1331	4	9
07/92→09/95	Corolla Wagon 1.3 XLI 16V	4E-FE	Petrol	1331	4	9
04/97→02/00	Corolla Wagon 1.4	4E-FE	Petrol	1331	4	9
06/04→10/01	Corolla Wagon 1.4 D4d	1ND-TV	Diesel	1364	4	6
07/92→02/00	Corolla Wagon 1.6	4A-FE	Petrol	1587	4	17
02/00→10/01	Corolla Wagon 1.6 16V	3ZZ-FE	Petrol	1598	4	14
04/97→02/00	Corolla Wagon 1.6 Aut.	4A-FE	Petrol	1587	4	17
07/92→04/97	Corolla Wagon 1.6 Si	4A-FE	Petrol	1587	4	17
04/97→10/01	Corolla Wagon 2.0 D-4D	1CD-FTV	Diesel	1995	4	19
02/92→09/97	Corona Estate 1.6	4A-FE	Petrol	1587	4	17
02/92→09/97	Corona Estate 2.0	3S-FE	Petrol	1998	4	23
06/89→09/97	Corona Hatchback 1.6	4A-FE	Petrol	1587	4	17
02/92→09/97	Corona Hatchback 2.0	3S-FE	Petrol	1998	4	23
12/87→01/92	Corona Hatchback 2.0 EZ	3S-FE	Petrol	1998	4	23
06/89→09/97	Corona Saloon 1.6	4A-FE	Petrol	1587	4	17
02/92→09/97	Corona Saloon 2.0	3S-FE	Petrol	1998	4	23
12/87→01/92	Corona Saloon 2.0 EZ	3S-FE	Petrol	1998	4	23
11/94→09/99	Corsa Hatchback 1.3	4E-FE	Petrol	1331	4	9
10/90→09/99	Corsa Saloon 1.3	4E-FE	Petrol	1331	4	9
09/80→07/84	Cressida Saloon 2.2 D	L	Diesel	2188	4	26
01/85→10/88	Cressida Saloon 2.4 TD	2L-T	Diesel	2446	4	28
06/81→03/85	Cressida Station Wagon 2.2 D	L	Diesel	2188	4	26
09/88→10/96	Cresta Saloon 2.4 D	2L	Diesel	2446	4	28
04/80→07/83	Crown Saloon 2.2 D	L	Diesel	2188	4	26
08/94→07/02	Crown Saloon 2.4 D	2L-TE	Diesel	2446	4	28
09/89→10/93	Curren Coupe 1.6	4A-FE	Petrol	1587	4	17
08/85→07/01	Dyna 150 Platform/Chassis 2.4 D	2L	Diesel	2446	4	28
09/88→08/98	Dyna 150 Platform/Chassis 2.8 D	3L	Diesel	2779	4	31
09/88→06/95	Dyna 150 Platform/Chassis 3.4 D	3B	Diesel	3432	4	32
10/92→05/99	Dyna 200 Platform/Chassis 3.4 D	3B	Diesel	3432	4	32
06/95→05/99	Dyna 300 Platform/Chassis 3.4 D	3B	Diesel	3432	4	32
08/87→07/01	Dyna Bus 2.4 D	2L	Diesel	2446	4	28
08/01→	Dyna Bus 3.0 D4d	1KD-FTV	Diesel	2982	4	30
08/77→04/79	Dyna Pickup 2.4 D	2L	Diesel	2446	4	28
08/77→08/84	Dyna Platform/Chassis 2.0	5R	Petrol	1997	4	24
08/77→04/95	Dyna Platform/Chassis 2.4 D	2L	Diesel	2446	4	28
09/06→	Dyna Platform/Chassis 3.0 D4d	1KD-FTV	Diesel	2982	4	30
09/06→	Dyna Platform/Chassis 3.0 D4d 4WD	1KD-FTV	Diesel	2982	4	30
04/03→08/05	Echo Hatchback 1.0 VVTi	1SZ-FE	Petrol	998	4	1
08/99→03/03	Echo Hatchback 1.3 VVTi	2NZ-FE	Petrol	1299	4	10
04/03→08/05	Echo Hatchback 1.3 VVTi	2SZ-FE	Petrol	1298	4	5
01/00→03/03	Echo Hatchback 1.4 D4d	1ND-TV	Diesel	1364	4	6
04/03→08/05	Echo Hatchback 1.5 VVTi	1NZ-FE	Petrol	1497	4	10
04/99→08/05	Echo Saloon 1.5 VVTi	1NZ-FE	Petrol	1497	4	10
08/09→	Fortuner Closed Off-Road Vehicle 3.0 D	1KD-FTV	Diesel	2982	4	30
01/79→03/83	Hiace I Box 2.2 D	L	Diesel	2188	4	26
01/80→12/80	Hiace I Wagon 2.2 D	L	Diesel	2188	4	26
03/83→11/89	Hiace II Box 2.2 D	L	Diesel	2188	4	26
05/84→11/89	Hiace II Box 2.4 D	2L	Diesel	2446	4	28
04/84→07/87	Hiace II Box 2.4 D 4WD	2L	Diesel	2446	4	28
03/83→11/89	Hiace II Wagon 2.2 D	L	Diesel	2188	4	26
08/84→08/89	Hiace II Wagon 2.4 D	2L	Diesel	2446	4	28
01/87→01/88	Hiace II Wagon 2.4 D 4WD	2L	Diesel	2446	4	28
09/89→08/95	Hiace III Box 2.4 D	2L	Diesel	2446	4	28
08/89→08/95	Hiace III Box 2.4 D 4WD	2L	Diesel	2446	4	28

MODEL INDEX

 Modelverzeichnis • Index de modele • Índice de Modelo
 Indeks modelu • Модель автомобиля • دليل الموديل

CCM
x

9

08/89→08/00	Hiace III Box 2.8 D	3L	Diesel	2779	4	31
08/89→08/95	Hiace III Wagon 2.4 D	2L	Diesel	2446	4	28
08/89→08/95	Hiace III Wagon 2.4 D 4WD	2L	Diesel	2446	4	28
08/89→08/00	Hiace III Wagon 2.8 D	3L	Diesel	2779	4	31
08/95→08/06	Hiace IV Box 2.4 D	2L	Diesel	2446	4	28
08/95→08/06	Hiace IV Box 2.4 TD	2L-T	Diesel	2446	4	28
08/95→08/06	Hiace IV Box 2.4 TD 4WD	2L-T	Diesel	2446	4	28
08/95→08/00	Hiace IV Box 2.8 D	3L	Diesel	2779	4	31
01/05→	Hiace IV Box 3.0 D	1KD-FTV	Diesel	2982	4	30
08/95→08/06	Hiace IV Bus 2.4 D	2L	Diesel	2446	4	28
08/95→08/06	Hiace IV Bus 2.4 TD	2L-T	Diesel	2446	4	28
08/95→08/06	Hiace IV Bus 2.4 TD 4WD	2L-T	Diesel	2446	4	28
08/95→08/06	Hiace IV Platform/Chassis 2.4 D	2L	Diesel	2446	4	28
08/95→08/00	Hiace IV Wagon 2.8 D	3L	Diesel	2779	4	31
01/05→	Hiace IV Wagon 3.0 D	1KD-FTV	Diesel	2982	4	30
01/79→07/85	Hiace Pickup 2.2 D	L	Diesel	2188	4	26
08/89→07/01	Hilux Closed Off-Road Vehicle 2.4 TD 4WD	2L-T	Diesel	2446	4	28
01/95→08/98	Hilux Closed Off-Road Vehicle 2.8 D	3L	Diesel	2779	4	31
05/79→03/83	Hilux I Pickup 2.2 D	L	Diesel	2188	4	26
08/83→08/84	Hilux II Pickup 2.2 D	L	Diesel	2188	4	26
08/83→08/84	Hilux II Pickup 2.2 D 4WD	L	Diesel	2188	4	26
08/88→07/05	Hilux II Pickup 2.4 D	2L	Diesel	2446	4	28
01/84→07/05	Hilux II Pickup 2.4 D 4WD	2L	Diesel	2446	4	28
08/98→01/02	Hilux II Pickup 2.4 TD 4WD	2L-T	Diesel	2446	4	28
09/91→11/97	Hilux II Pickup 2.8 D	3L	Diesel	2779	4	31
10/88→07/01	Hilux II Pickup 2.8 D 4WD	3L	Diesel	2779	4	31
01/84→08/88	Hilux II Platform/Chassis 2.4 D 4WD	2L	Diesel	2446	4	28
08/88→08/97	Hilux II Platform/Chassis 2.8 D 4WD	3L	Diesel	2779	4	31
08/05→09/06	Hilux III Pickup 3.0	1KD-FTV	Diesel	2982	4	30
10/06→	Hilux III Pickup 3.0 D	1KD-FTV	Diesel	2982	4	30
12/07→	Hilux III Pickup 3.0 D-4D 4WD	1KD-FTV	Diesel	2982	4	30
02/05→	Hilux III Platform/Chassis 3.0 D	1KD-FTV	Diesel	2982	4	30
02/05→	Hilux III Platform/Chassis 3.0 D 4WD	1KD-FTV	Diesel	2982	4	30
01/09→	IQ 1.0	1KR-FE Euro 4	Petrol	998	3	3
01/09→	IQ 1.4 D-4D	1ND-TV	Diesel	1364	4	6
07/04→	Isis 1.8 VVTi	1ZZ-FE	Petrol	1794	4	14
04/07→	Isis 1.8 VVTi	2ZR-FAE	Petrol	1798	4	15
04/07→	Isis 1.8 VVTi 4WD	2ZR-FAE	Petrol	1798	4	15
05/04→07/07	IST 1.3 VVTi	2NZ-FE	Petrol	1299	4	10
05/04→07/07	IST 1.5 VVTi	1NZ-FE	Petrol	1497	4	10
08/89→08/95	Kijang Bus 2.4 D	2L	Diesel	2446	4	28
09/93→08/00	Kijang Bus 2.7 D	3L	Diesel	2779	4	31
11/84→10/85	Land Cruiser 2.4 D	2L	Diesel	2446	4	28
10/85→05/93	Land Cruiser 2.4 TD	2L-T	Diesel	2446	4	28
01/90→08/01	Land Cruiser 2.7 TD 4x4	3L	Diesel	2779	4	31
02/74→10/84	Land Cruiser 3.0 D	B	Diesel	2977	4	29
09/02→	Land Cruiser 3.0 D-4D	1KD-FTV	Diesel	2982	4	30
08/80→12/96	Land Cruiser 3.4 D	3B	Diesel	3432	4	32
10/81→08/87	Land Cruiser 3.4 Diesel	3B	Diesel	3432	4	32
08/80→10/84	Land Cruiser 4.0 D	2H	Diesel	3980	6	27
08/87→12/89	Land Cruiser 4.0 D 4x4	2H	Diesel	3980	6	27
10/81→01/88	Land Cruiser 4.0 Diesel	2H	Diesel	3980	6	27
10/00→	Land Cruiser 90 3.0 D-4D	1KD-FTV	Diesel	2982	4	30
01/10→	Land Cruiser 150 3.0 D-4D	1KD-FTV	Diesel	2982	4	30
07/90→05/96	Land Cruiser Hardtop 2.4 TD	2L-T	Diesel	2446	4	28
08/80→10/84	Land Cruiser Pickup 3.4 D	3B	Diesel	3432	4	32
08/80→10/84	Land Cruiser Pickup 4.0 D	2H	Diesel	3980	6	27
10/79→10/86	Liteace Box 1.3	4K	Petrol	1290	4	11
10/82→08/88	Liteace Box 1.8 D	1C	Diesel	1839	4	20
10/97→08/01	Liteace Bus 1.8	1ZZ-FE	Petrol	1794	4	14

CCM

x



9

10/85→07/88	Liteace Bus 1.8 D	1C	Diesel	1839	4	20
10/79→09/85	Liteace Wagon 1.3	4K	Petrol	1290	4	11
10/82→09/85	Liteace Wagon 1.8 D	1C	Diesel	1839	4	20
04/88→09/96	Mark II Estate 2.4 D	2L	Diesel	2446	4	28
08/80→10/83	Mark II Saloon 2.2 DX	L	Diesel	2188	4	26
11/84→09/96	Mark II Saloon 2.4 TD	2L-TE	Diesel	2446	4	28
09/01→02/04	Matrix 1.8 VVTi	1ZZ-FE	Petrol	1794	4	14
09/01→02/04	Matrix 1.8 VVTi 4WD	1ZZ-FE	Petrol	1794	4	14
12/89→08/92	MR 2 II 2.0	3S-FE	Petrol	1998	4	23
10/99→06/07	MR 2 III 1.8 16V VT-i	1ZZ-FE	Petrol	1794	4	14
04/98→08/03	Nadia 2.0	3S-FE	Petrol	1998	4	23
04/00→08/03	OPA 1.8	1ZZ-FE	Petrol	1794	4	14
04/00→08/03	OPA 1.8 4WD	1ZZ-FE	Petrol	1794	4	14
08/95→04/00	Paseo Coupe 1.3	4E-FE	Petrol	1331	4	9
06/05→	Passo 1.0	1KR-FE Euro 4	Petrol	998	3	3
06/05→	Passo 1.0 4WD	1KR-FE Euro 4	Petrol	998	3	3
06/00→01/03	Picnic 2.0	3S-FE	Petrol	1998	4	23
05/96→12/01	Picnic 2.0 16V	3S-FE	Petrol	1998	4	23
04/99→08/05	Platz 1.0 VVTi	1SZ-FE	Petrol	998	4	1
09/02→08/05	Platz 1.3 VVTi	2NZ-FE	Petrol	1299	4	10
09/02→08/05	Platz 1.3 VVTi 4WD	2NZ-FE	Petrol	1299	4	10
04/99→08/05	Platz 1.5 VVTi	1NZ-FE	Petrol	1497	4	10
09/02→08/05	Platz 1.5 VVTi 4WD	1NZ-FE	Petrol	1497	4	10
07/04→07/12	Porte 1.3 VVTi	2NZ-FE	Petrol	1299	4	10
07/04→07/12	Porte 1.5 4WD	1NZ-FE	Petrol	1497	4	10
07/04→07/12	Porte 1.5 VVTi	1NZ-FE	Petrol	1497	4	10
08/12→	Porte II 1.5	1NZ-FE	Petrol	1497	4	10
08/12→	Porte II 1.5 4WD	1NZ-FE	Petrol	1497	4	10
07/07→	Premio 1.5	1NZ-FE	Petrol	1497	4	10
07/07→	Premio 1.8	2ZR-FAE	Petrol	1798	4	15
07/07→	Premio 1.8 4WD	2ZR-FAE	Petrol	1798	4	15
10/00→08/03	Previa 2.0	3S-FE	Petrol	1998	4	23
03/01→01/06	Previa 2.0 D-4D	1CD-FTV	Diesel	1995	4	19
07/02→12/05	Previa 2.4 4WD	2AZ-FXE	Petrol	2362	4	25
10/05→01/06	Previa 2.4 Hybrid	2AZ-FXE	Petrol	2362	4	25
10/05→01/06	Previa 2.4 Hybrid 4WD	2AZ-FXE	Petrol	2362	4	25
05/12→	Previa III 2.4 Hybrid	2AZ-FXE	Petrol	2362	4	25
10/06→	Previa III 2.4 Hybrid 4WD	2AZ-FXE	Petrol	2362	4	25
06/13→	Proace Box 1.6 D-4D	3WZ-TV	Diesel	1560	4	12
07/02→	Probox/Succeed 1.3 VVTi	2NZ-FE	Petrol	1299	4	10
07/02→	Probox/Succeed 1.4 D-4D	1ND-TV	Diesel	1364	4	6
07/02→	Probox/Succeed 1.5 VVTi	1NZ-FE	Petrol	1497	4	10
07/02→	Probox/Succeed 1.5 VVTi 4WD	1NZ-FE	Petrol	1497	4	10
09/05→08/10	Ractis 1.3	2SZ-FE	Petrol	1298	4	5
09/05→08/10	Ractis 1.5 VVTi	1NZ-FE	Petrol	1497	4	10
09/05→08/10	Ractis 1.5 VVTi 4WD	1NZ-FE	Petrol	1497	4	10
05/03→	Raum MPV 1.5	1NZ-FE	Petrol	1497	4	10
05/03→	Raum MPV 1.5 4WD	1NZ-FE	Petrol	1497	4	10
06/97→09/99	RAV 4 I 2.0	3S-FE	Petrol	1998	4	23
01/94→06/00	RAV 4 I 2.0 4WD	3S-FE	Petrol	1998	4	23
12/97→06/00	RAV 4 I Cabrio 2.0 16V 4WD	3S-FE	Petrol	1998	4	23
02/01→11/05	RAV 4 II 1.8 VVTi	1ZZ-FE	Petrol	1794	4	14
09/01→11/05	RAV 4 II 2.0 D-4D 4WD	1CD-FTV	Diesel	1995	4	19
06/00→11/05	RAV 4 II 2.0 VVTi 4WD	1AZ FE	Petrol	1998	4	21
03/06→	RAV 4 III 2.0 VVT-i 4WD	1AZ FE	Petrol	1998	4	21
12/08→	RAV 4 III 2.2 D-4D	2AD-FHV Euro 4	Diesel	2231	4	22
12/08→	RAV 4 III 2.2 D-4D 4WD	2AD-FHV Euro 4	Diesel	2231	4	22
03/06→	RAV 4 III 2.2 D-CAT 4WD	2AD-FHV Euro 4	Diesel	2231	4	22
12/12→	RAV 4 IV 2.2 D4-D 4WD	2AD-FHV Euro 4	Diesel	2231	4	22
08/04→	Regiusace Box 3.0 D-4D	1KD-FTV	Diesel	2982	4	30

MODEL INDEX

Modelverzeichnis • Index de modele • Índice de Modelo
Indeks modelu • Модель автомобиля • دليل الموديل



CCM

x



9

08/04→	Regiusace Box 3.0 D-4D 4WD	1KD-FTV	Diesel	2982	4	30
08/04→	Regiusace Bus 3.0 D-4D	1KD-FTV	Diesel	2982	4	30
08/04→	Regiusace Bus 3.0 D-4D 4WD	1KD-FTV	Diesel	2982	4	30
11/09→	SAI 2.4 Hybrid	2AZ-FXE	Petrol	2362	4	25
10/86→09/96	Scepter Estate 2.0	3S-FE	Petrol	1998	4	23
10/86→09/96	Scepter Saloon 2.0	3S-FE	Petrol	1998	4	23
05/03→	Sienta 1.5	1NZ-FE	Petrol	1497	4	10
05/03→	Sienta 1.5 4WD	1NZ-FE	Petrol	1497	4	10
08/12→	Spade 1.5	1NZ-FE	Petrol	1497	4	10
08/12→	Spade 1.5 4WD	1NZ-FE	Petrol	1497	4	10
06/92→04/97	Sprinter Carib 1.3	4E-FE	Petrol	1331	4	9
08/95→10/01	Sprinter Carib 1.6	4A-FE	Petrol	1587	4	17
11/87→07/95	Sprinter Carib 1.6 4WD	4A-FE	Petrol	1587	4	17
06/83→07/87	Sprinter Coupe 1.3	2E-L	Petrol	1296	4	7
10/84→07/87	Sprinter Coupe 1.6	4A-LC	Petrol	1587	4	16
08/87→04/92	Sprinter Hatchback 1.3	2E	Petrol	1296	4	7
08/87→04/92	Sprinter Hatchback 1.3	2E-E	Petrol	1296	4	7
06/83→07/87	Sprinter Hatchback 1.3	2E-L	Petrol	1296	4	7
06/92→11/00	Sprinter Hatchback 1.3	4E-FE	Petrol	1331	4	9
08/87→04/97	Sprinter Hatchback 1.6	4A-FE	Petrol	1587	4	17
10/84→07/87	Sprinter Hatchback 1.6	4A-LC	Petrol	1587	4	16
10/88→04/92	Sprinter Hatchback 1.6 4WD	4A-FE	Petrol	1587	4	17
06/92→11/00	Sprinter Saloon 1.3	4E-FE	Petrol	1331	4	9
06/92→04/97	Sprinter Saloon 1.6	4A-FE	Petrol	1587	4	17
12/89→12/92	Starlet 1.0	1E	Petrol	999	4	2
10/84→12/89	Starlet 1.0	1E-L	Petrol	999	4	2
02/78→09/84	Starlet 1.0	2K	Petrol	993	4	4
10/84→12/89	Starlet 1.3	2E-LC	Petrol	1295	4	7
04/96→03/99	Starlet 1.3	4E-FE	Petrol	1331	4	9
02/78→09/84	Starlet 1.3	4K	Petrol	1290	4	11
12/89→12/92	Starlet 1.3 12V	2E	Petrol	1296	4	7
12/89→03/96	Starlet 1.3 12V	2E-E	Petrol	1296	4	7
08/82→09/84	Starlet 1.3 S	4K	Petrol	1290	4	11
12/89→12/91	Starlet 1.3 XL	2E	Petrol	1296	4	7
11/74→08/78	Starlet 1000 1.0	2K	Petrol	993	4	4
05/76→08/78	Starlet 1000 Kombi 1.0	2K	Petrol	993	4	4
02/78→09/84	Starlet Estate 1.0	2K	Petrol	993	4	4
02/78→09/84	Starlet Estate 1.3	4K	Petrol	1290	4	11
		1NZ-FE	Petrol	1497	4	10
01/99→10/04	Tamaraw FX 2.4 D	2L	Diesel	2446	4	28
03/79→01/88	Tercel 1.3	2A	Petrol	1295	4	13
05/92→09/99	Tercel Hatchback 1.3	4E-FE	Petrol	1331	4	9
05/92→09/99	Tercel Saloon 1.3	4E-FE	Petrol	1331	4	9
04/85→09/90	Town Ace Box 2.2 D	L	Diesel	2188	4	26
04/85→12/91	Town Ace Box 2.4 D	2L	Diesel	2446	4	28
05/95→09/01	Town Ace Box 2.8 D	3L	Diesel	2779	4	31
04/85→12/91	Town Ace Bus 2.2 D	L	Diesel	2188	4	26
04/85→12/91	Town Ace Bus 2.4 D	2L	Diesel	2446	4	28
05/95→09/01	Town Ace Bus 2.8 D	3L	Diesel	2779	4	31
04/09→	Urban Cruiser 1.4 D-4D	1ND-TV	Diesel	1364	4	6
04/09→	Urban Cruiser 1.4 D-4D 4WD	1ND-TV	Diesel	1364	4	6
07/07→	Urban Cruiser 1.5 VVTi	1NZ-FE	Petrol	1497	4	10
04/09→	Urban Cruiser 1.5 VVTi 4WD	1NZ-FE	Petrol	1497	4	10
04/09→	Verso 1.6	1ZR-FAE	Petrol	1598	4	15
04/09→	Verso 1.8	2ZR-FAE	Petrol	1798	4	15
04/09→	Verso 2.2 D-4D	2AD-FHV Euro 4	Diesel	2231	4	22
04/09→	Verso 2.2 D-CAT	2AD-FHV Euro 4	Diesel	2231	4	22
11/10→	Verso S 1.4 D4-D	1ND-TV	Diesel	1364	4	6
11/10→	Verso S 1.5	1NZ-FE	Petrol	1497	4	10
11/10→	Verso S 1.5 4WD	1NZ-FE	Petrol	1497	4	10

CCM
x

9

07/02→01/08	Vios 1.5 VVTi	1NZ-FE	Petrol	1497	4	10
08/07→	Vios/Yaris Saloon 1.0	1KR-FE Euro 4	Petrol	998	3	3
08/07→	Vios/Yaris Saloon 1.3	2NZ-FE	Petrol	1299	4	10
08/07→	Vios/Yaris Saloon 1.3	2SZ-FE	Petrol	1298	4	5
08/07→	Vios/Yaris Saloon 1.3 4WD	2NZ-FE	Petrol	1299	4	10
08/07→	Vios/Yaris Saloon 1.5	1NZ-FE	Petrol	1497	4	10
11/88→06/91	Vista Estate 2.0	3S-FE	Petrol	1998	4	23
06/98→08/03	Vista Saloon 1.8 N180	1ZZ-FE	Petrol	1794	4	14
10/86→06/90	Vista Saloon 2.0	3S-FE	Petrol	1998	4	23
06/98→08/03	Vista Saloon 2.0 D4 N200	1AZ FE	Petrol	1998	4	21
06/98→08/03	Vista Saloon 2.0 D4 N200 4WD	1AZ FE	Petrol	1998	4	21
05/01→07/05	Will Cypha 1.3 VVTi	2NZ-FE	Petrol	1299	4	10
05/01→07/05	Will Cypha 1.5 VVTi 4WD	1NZ-FE	Petrol	1497	4	10
01/00→12/01	Will Vi 1.3	2NZ-FE	Petrol	1299	4	10
03/01→04/04	Will VS 1.5 VVTi 4WD	1NZ-FE	Petrol	1497	4	10
03/01→04/04	Will VS 1.8 VVTi	1ZZ-FE	Petrol	1794	4	14
03/01→04/04	Will VS 1.8 VVTi 4WD	1ZZ-FE	Petrol	1794	4	14
03/01→04/04	Will VS 1.8 VVTi 4WD	1ZZ-FE	Petrol	1794	4	14
04/09→	Wish MPV 1.8	2ZR-FAE	Petrol	1798	4	15
04/09→	Wish MPV 1.8 4WD	2ZR-FAE	Petrol	1798	4	15
04/03→03/09	Wish MPV 1.8 Hi	1ZZ-FE	Petrol	1794	4	14
04/03→03/09	Wish MPV 1.8 Hi 4WD	1ZZ-FE	Petrol	1794	4	14
09/11→	Yaris 1.0	1KR-FE Euro 4	Petrol	998	3	3
04/99→09/05	Yaris 1.0 16V	1SZ-FE	Petrol	998	4	1
01/06→	Yaris 1.0 GPL	1KR-FE Euro 4	Petrol	998	3	3
01/06→	Yaris 1.0 VVT-i	1KR-FE Euro 4	Petrol	998	3	3
04/02→09/05	Yaris 1.3	2SZ-FE	Petrol	1298	4	5
11/99→09/05	Yaris 1.3 16V	2NZ-FE	Petrol	1299	4	10
08/07→	Yaris 1.3 4WD	2NZ-FE	Petrol	1299	4	10
11/05→	Yaris 1.3 VVT-i	2NZ-FE	Petrol	1299	4	10
01/06→	Yaris 1.3 VVT-i	2SZ-FE	Petrol	1298	4	5
12/01→	Yaris 1.4 D-4D	1ND-TV	Diesel	1364	4	6
11/05→	Yaris 1.5	1NZ-FE	Petrol	1497	4	10
01/03→09/05	Yaris 1.5 TS	1NZ-FE	Petrol	1497	4	10
04/01→09/05	Yaris 1.5 VVT-i TS	1NZ-FE	Petrol	1497	4	10
11/05→	Yaris 1.8 VVTi	1ZZ-FE	Petrol	1794	4	14
01/07→	Yaris 1.8 VVTi	2ZR-FE	Petrol	1798	4	15
11/99→09/05	Yaris Verso 1.3	2NZ-FE	Petrol	1299	4	10
12/01→09/05	Yaris Verso 1.4 D-4D	1ND-TV	Diesel	1364	4	6
03/00→09/05	Yaris Verso 1.5	1NZ-FE	Petrol	1497	4	10

ENGINE INDEX

Motorverzeichnis • Index de moteur • Índice de Motor
Indeks silnika • Модель двигателя • دليل المحرك



CCM

x



9

1AZ-FE	Petrol	1998	4	86.00	21
1C	Diesel	1839	4	83.00	20
1CD-FTV	Diesel	1995	4	82.20	19
1C-L	Diesel	1839	4	83.00	20
1C-TL	Diesel	1839	4	83.00	20
1E	Petrol	999	4	70.50	2
1E-L	Petrol	999	4	70.50	2
1KD-FTV	Diesel	2982	4	96.00	30
1KR-FE Euro 4	Petrol	998	3	71.00	3
1ND-TV	Diesel	1364	4	73.00	6
1NZ-FE	Petrol	1497	4	75.00	10
1SZ-FE	Petrol	998	4	69.00	1
1ZR-FAE	Petrol	1598	4	80.50	15
1ZR-FE	Petrol	1598	4	80.50	15
1ZZ-FE	Petrol	1794	4	79.00	14
2A	Petrol	1295	4	76.00	13
2AD-FHV Euro 4	Diesel	2231	4	86.00	22
2AZ-FXE	Petrol	2362	4	88.50	25
2E	Petrol	1296	4	73.00	7
2E-E	Petrol	1296	4	73.00	7
2E-L	Petrol	1296	4	73.00	7
2E-LC	Petrol	1295	4	73.00	7
2H	Diesel	3980	6	91.00	27
2K	Petrol	993	4	72.00	4
2L	Diesel	2446	4	92.00	28
2L-T	Diesel	2446	4	92.00	28
2L-TE	Diesel	2446	4	92.00	28
2NZ-FE	Petrol	1299	4	75.00	10
2SZ-FE	Petrol	1298	4	72.00	5
2WZ-TV	Diesel	1398	4	73.70	8
2ZR-FAE	Petrol	1798	4	80.50	15
2ZR-FE	Petrol	1798	4	80.50	15
2ZZ-GE	Petrol	1796	4	82.00	18
3B	Diesel	3432	4	102.00	32
3K	Petrol	1166	4	75.00	11
3L	Diesel	2779	4	96.00	31
3S-FE	Petrol	1998	4	86.00	23
3WZ-TV	Diesel	1560	4	75.00	12
3ZZ-FE	Petrol	1598	4	79.00	14
4A-C	Petrol	1587	4	81.00	16
4A-FE	Petrol	1587	4	81.00	17
4A-LC	Petrol	1587	4	81.00	16
4E-FE	Petrol	1331	4	74.00	9
4K	Petrol	1290	4	75.00	11
5R	Petrol	1997	4	88.00	24
B	Diesel	2977	4	95.00	29
L	Diesel	2188	4	90.00	26



Echo Hatchback 1.0 VVTi	04/03→08/05	1SZ-FE						1
Platz 1.0 VVTi	04/99→08/05		4cyl.					
Yaris 1.0 16V	04/99→09/05		998cc	50kW (68PS)				
TD11808								

08-426500-00	STD	69.00	1.200		001 NT		ST
08-426507-00	0.50mm		1.200		005 P		STD
			2.000		712 NT		ST

Starlet 1.0	12/89→12/92	1E						2
			4cyl.					
			999cc	40kW (54PS)				
TD3718								

Starlet 1.0	10/84→12/89	1E-L						
			4cyl.					
			999cc	40kW (54PS)				
TD3719								

08-373000-00	STD	70.50	1.500		001 CR P		IKA
			1.500		005 P		STD
			3.000		236 P		STD

Aygo 1.0, Aygo 1.0 GPL	07/05→	1KR-FE Euro 4						3
IQ 1.0	01/09→		3cyl.					
Passo 1.0, Passo 1.0 4WD	06/05→		998cc	50kW (68PS)				
Vios/Yaris Saloon 1.0	08/07→							
Yaris 1.0	09/11→							
Yaris 1.0 GPL, Yaris 1.0 VVT-i	01/06→							TD18481

08-439600-00	STD	71.00	1.000		001 IF CR		ST
			1.000		026		ST
			1.500		231 PVD		ST

1000 1.0, 1000 Box 1.0	04/69→08/88	2K						4
Starlet 1.0	02/78→09/84		4cyl.					
Starlet 1000 1.0	11/74→08/78		993cc	33kW (45PS)				
Starlet 1000 Kombi 1.0	05/76→08/78							
Starlet Estate 1.0	02/78→09/84							TD3763

08-371600-10	STD	72.00	2.000		001 IF CR P		STD
			2.000		026 P		STD
			4.000		712 CR		ST

Echo Hatchback 1.3 VVTi	04/03→08/05	2SZ-FE						5
Ractis 1.3	09/05→08/10		4cyl.					
Vios/Yaris Saloon 1.3	08/07→		1298cc	64kW (87PS)				
Yaris 1.3	04/02→09/05							
Yaris 1.3 VVT-i	01/06→							TD17287

08-439800-00	STD	72.00	1.200		001 NT		ST
			1.200		026 P		STD
			2.000		712 NT		ST



Auris 1.4 D-4D	03/07→	1ND-TV				6
Auris Touring Sports 1.4 D-4D	07/13→		4cyl.			
Auris Van Box 1.4 D-4D	03/07→		1364cc	55-66kW (75-90PS)		
Corolla 1.4 D	07/04→02/07	Diesel		Turbo Intercooled		
Corolla 1.4 D-4D	06/04→12/01					
Corolla Estate 1.4 D4-D	07/04→02/07					
Corolla Saloon 1.4 D-4D	07/04→					
Corolla Verso 1.4 D-4D	09/01→03/09					
Corolla Wagon 1.4 D4d	06/04→10/01					
Echo Hatchback 1.4 D4d	01/00→03/03					
IQ 1.4 D-4D	01/09→					
Probox/Succeed 1.4 D-4D	07/02→					
Urban Cruiser 1.4 D-4D, Urban Cruiser 1.4 D-4D 4WD	04/09→					
Verso S 1.4 D4-D	11/10→					
Yaris 1.4 D-4D	12/01→					
Yaris Verso 1.4 D-4D	12/01→09/05				TD16378	

08-898400-00	STD	73.00	1.500		001 NT	ST
08-898407-00	0.50mm		1.500		005 CR	STD
			3.000		231 NT	ST

Corolla 1.3	08/83→10/01	2E				7
Corolla 1.3 12V	07/92→04/97		4cyl.			
Corolla 1.3 i	08/87→12/92		1296cc	53-55kW (72-75PS)		
Corolla Compact 1.3	05/87→04/92					
Corolla Compact 1.3 12V	07/92→05/95					
Corolla FX Compact 1.3	10/84→04/87					
Corolla Liftback 1.3	08/83→04/92					
Corolla Liftback 1.3 12V	07/92→05/95					
Corolla Liftback 1.3 i	08/87→04/92					
Corolla Station Wagon 1.3	05/87→04/92					
Corolla Wagon 1.3 12V	07/92→05/95					
Sprinter Hatchback 1.3	08/87→04/92					
Starlet 1.3 12V	12/89→12/92					
Starlet 1.3 XL	12/89→12/91				TD4935	



Corolla 1.3 i	08/87→12/92	2E-E				TD4936
Corolla Liftback 1.3 i	08/87→04/92		4cyl.			
Corolla Station Wagon 1.3 i	06/89→06/92		1296cc	74kW (100PS)		
Sprinter Hatchback 1.3	08/87→04/92					
Starlet 1.3 12V	12/89→03/96					



Corolla 1.3	10/84→08/87	2E-L				TD4937
Corolla FX Compact 1.3	08/85→08/87		4cyl.			
Corolla Liftback 1.3	01/85→08/87		1296cc	55kW (75PS)		
Sprinter Coupe 1.3, Sprinter Hatchback 1.3	06/83→07/87					

Corolla 1.3	10/84→08/87	2E-LC				TD3756
Corolla Liftback 1.3	01/85→08/87		4cyl.			
Starlet 1.3	10/84→12/89		1295cc	55kW (75PS)		

08-374400-00	STD	73.00	1.500		001 CR P	IKA
08-374407-00	0.50mm		1.500		005 P	STD
[R45530]			3.000		712 CR	ST



Aygo 1.4 HDi			07/05→08/10	2WZ-TV				8
					4cyl.			
					1398cc	40kW (54PS)		
				Diesel				TD24605
08-135300-00	STD	73.70	2.500		008 CK P			KV1
08-135305-00	0.25mm				005 IFU P			GOE12
08-135307-00	0.50mm		1.950		231 CR P			GOE12
[R66770]			2.500					

Caribe Estate 1.3			09/94→08/96	4E-FE				9
Corolla 1.3 XLI			09/95→04/97		4cyl.			
Corolla 1.3 XLI 16V			07/92→09/95		1331cc	55-65kW (75-88PS)		
Corolla 1.4			04/97→02/00					
Corolla Compact 1.3 XLI			09/95→04/97					
Corolla Compact 1.3 XLI 16V			07/92→09/95					
Corolla Compact 1.4			04/97→02/00					
Corolla Liftback 1.3 XLI			07/92→04/97					
Corolla Liftback 1.4			04/97→02/00					
Corolla Wagon 1.3 XLI			09/95→04/97					
Corolla Wagon 1.3 XLI 16V			07/92→09/95					
Corolla Wagon 1.4			04/97→02/00					
Corsa Hatchback 1.3			11/94→09/99					
Corsa Saloon 1.3			10/90→09/99					
Paseo Coupe 1.3			08/95→04/00					
Sprinter Carib 1.3			06/92→04/97					
Sprinter Hatchback 1.3,			06/92→11/00					
Sprinter Saloon 1.3								
Starlet 1.3			04/96→03/99					
Tercel Hatchback 1.3, Tercel Saloon 1.3			05/92→09/99					TD3833
08-428400-00	STD	74.00	1.200		001 CR			ST
08-428407-00	0.50mm			1.200		005 P		STD
				3.000		712 CR P		ST



Allion I 1.5	06/01→04/05	1NZ-FE			10
Allion II 1.5	07/07→		4cyl.		
Auris 1.5, Auris 1.5 4WD	09/09→		1497cc	78kW (106PS)	
BB I 1.5	03/00→12/05				
Corolla 1.5, Corolla Compact 1.5	09/99→10/01				
Corolla Estate 1.5,	09/06→				
Corolla Estate 1.5 4WD					
Corolla Rumion 1.5	09/07→				
Corolla Saloon 1.5	11/01→				
Corolla Saloon 1.5 4WD	08/07→				
Corolla Saloon 1.5 G 4WD	11/01→05/04				
Corolla Verso 1.5	03/04→03/09				
Echo Hatchback 1.5 VVTi	04/03→08/05				
Echo Saloon 1.5 VVTi	04/99→08/05				
IST 1.5 VVTi	05/04→07/07				
Platz 1.5 VVTi	04/99→08/05				
Platz 1.5 VVTi 4WD	09/02→08/05				
Porte 1.5 4WD, Porte 1.5 VVTi	07/04→07/12				
Porte II 1.5, Porte II 1.5 4WD	08/12→				
Premio 1.5	07/07→				
Probox/Succeed 1.5 VVTi, Probox/ Succeed 1.5 VVTi 4WD	07/02→				
Ractis 1.5 VVTi, Ractis 1.5 VVTi 4WD	09/05→08/10				
Raum MPV 1.5, Raum MPV 1.5 4WD,	05/03→				
Sienta 1.5, Sienta 1.5 4WD					
Spade 1.5, Spade 1.5 4WD	08/12→				
Urban Cruiser 1.5 VVTi	07/07→				
Urban Cruiser 1.5 VVTi 4WD	04/09→				
Verso S 1.5, Verso S 1.5 4WD	11/10→				
Vios 1.5 VVTi	07/02→01/08				
Vios/Yaris Saloon 1.5	08/07→				
Will Cypha 1.5 VVTi 4WD	05/01→07/05				
Will VS 1.5 VVTi 4WD	03/01→04/04				
Yaris 1.5	11/05→				
Yaris 1.5 TS	01/03→09/05				
Yaris 1.5 VVT-i TS	04/01→09/05				
Yaris Verso 1.5	03/00→09/05				TD15499

Corolla Saloon 1.3	11/01→05/04	2NZ-FE			
Corolla Saloon 1.3 VVT-i	03/08→		4cyl.		
Echo Hatchback 1.3 VVTi	08/99→03/03		1299cc	66kW (89PS)	
IST 1.3 VVTi	05/04→07/07				
Platz 1.3 VVTi, Platz 1.3 VVTi 4WD	09/02→08/05				
Porte 1.3 VVTi	07/04→07/12				
Probox/Succeed 1.3 VVTi	07/02→				
Vios/Yaris Saloon 1.3, Vios/ Yaris Saloon 1.3 4WD	08/07→				
Will Cypha 1.3 VVTi	05/01→07/05				
Will Vi 1.3	01/00→12/01				
Yaris 1.3 16V	11/99→09/05				
Yaris 1.3 4WD	08/07→				
Yaris 1.3 VVT-i	11/05→				
Yaris Verso 1.3	11/99→09/05				TD13088

08-440000-00	STD	75.00	1.200		001 NT	ST
			1.200		026 P	STD
			2.000		712 NT	ST



Corolla Combi 1.2	07/75→01/80	3K	4cyl. 1166cc	40kW (54PS)	11
					TD4943

Corolla 1.3	09/79→06/83	4K	4cyl. 1290cc	42-48kW (57-65PS)	
Corolla Hatchback 1.3	09/79→05/83				
Corolla Station Wagon 1.3	02/82→08/87				
Liteace Box 1.3	10/79→10/86				
Liteace Wagon 1.3	10/79→09/85				
Starlet 1.3	02/78→09/84				
Starlet 1.3 S	08/82→09/84				
Starlet Estate 1.3	02/78→09/84				TD4950

08-371700-00	STD	75.00	2.000		001 CR P	STD
[R43280]			2.000		026 P	STD
			4.000		231 CR P	STD

Proace Box 1.6 D-4D	06/13→	3WZ-TV	4cyl. 1560cc	66kW (89PS)	12
					TD28203
			Diesel	Turbo Direct Injection	

08-433600-00	STD	75.00	2.500		008 CK P	KV1
08-433607-00	0.50mm		1.950		026 P	F12/F14
			2.000		231 LKZ CR P	KV1

Caribe Saloon 1.3	10/86→08/94	2A	4cyl. 1295cc	48kW (65PS)	13
Corolla 1.3, Corolla Liftback 1.3	09/85→05/89				
Tercel 1.3	03/79→01/88				
					TD3745

08-373100-00	STD	76.00	2.000		001 CR P	IKA
[R38720]			2.000		026 P	STD
			4.000		236 P	STD









Allion I 1.8	06/01→04/05	1ZZ-FE			14
Allion I 1.8 4WD	06/01→06/07		4cyl.		
Avensis 1.8	04/03→11/08		1794cc	92-107kW (125-146PS)	
Avensis 1.8 VVT-i	10/00→02/03				
Avensis Estate 1.8	04/03→11/08				
Avensis Liftback 1.8 VVT-i	10/00→02/03				
Avensis Saloon 1.8	04/03→11/08				
Avensis Station Wagon 1.8 VVT-i	10/00→02/03				
Celica 1.8 16V VT-i	08/99→07/05				
Corolla 1.8 4WD	12/01→02/07				
Corolla 1.8 VVTi, Corolla Estate 1.8	06/04→02/07				
Corolla Estate 1.8 4WD	12/01→02/07				
Corolla Saloon 1.8	03/01→07/07				
Corolla Verso 1.8	04/04→03/09				
Corolla Verso 1.8 VVT-i	01/02→05/04				
Corolla Verso 1.8 VVTi 4WD	10/01→02/04				
Isis 1.8 VVTi	07/04→				
Liteace Bus 1.8	10/97→08/01				
Matrix 1.8 VVTi, Matrix 1.8 VVTi 4WD	09/01→02/04				
MR 2 III 1.8 16V VT-i	10/99→06/07				
OPA 1.8, OPA 1.8 4WD	04/00→08/03				
RAV 4 II 1.8 VVTi	02/01→11/05				
Vista Saloon 1.8 N180	06/98→08/03				
Will VS 1.8 VVTi, Will VS 1.8 VVTi 4WD,	03/01→04/04				
Will VS 1.8 VVTi 4WD					
Wish MPV 1.8 Hi, Wish MPV 1.8 Hi 4WD	04/03→03/09				
Yaris 1.8 VVTi	11/05→				TD13368

Avensis 1.6 VVT-i	10/00→11/08	3ZZ-FE			
Avensis Estate 1.6 VVT-i	04/03→11/08		4cyl.		
Avensis Liftback 1.6 VVT-i	10/00→02/03		1598cc	81kW (110PS)	
Avensis Saloon 1.6 VVT-i	04/03→11/08				
Avensis Station Wagon 1.6 VVT-i	10/00→02/03				
Corolla 1.6 16V	02/00→11/01				
Corolla 1.6 VVT-i	01/02→12/06				
Corolla Compact 1.6	02/00→01/02				
Corolla Estate 1.6 VVT-i	01/02→02/07				
Corolla Liftback 1.6	02/00→01/02				
Corolla Saloon 1.6 CNG	08/07→				
Corolla Saloon 1.6 VVT-i	08/02→				
Corolla Verso 1.6	04/04→03/09				
Corolla Verso 1.6 VVT-i	01/02→05/04				
Corolla Wagon 1.6 16V	02/00→10/01				TD14229

08-426700-00	STD	79.00	1.200		001 NT	ST
08-426707-00	0.50mm		1.200		005 P	STD
			3.000		712 NT	ST



Auris 1.6		05/09→	1ZR-FAE			15
Auris Touring Sports 1.6		07/13→		4cyl.		
Avensis Estate 1.6, Avensis Saloon 1.6		02/09→		1598cc	97kW (132PS)	
Corolla Saloon 1.6		01/09→				
Verso 1.6		04/09→			TD21730	
Auris 1.6 VVTi		03/07→	1ZR-FE			TD20925
Corolla Saloon 1.6		11/06→		4cyl.		
Corolla Saloon 1.6 Dual VVTi		01/07→		1598cc	91kW (124PS)	
Allion II 1.8, Allion II 1.8 4WD		07/07→	2ZR-FAE			TD21731
Auris 1.8, Auris 1.8 4WD,		02/09→		4cyl.		
Avensis Estate 1.8, Avensis Saloon 1.8				1798cc	108kW (147PS)	
Corolla Estate 1.8,		09/06→				
Corolla Estate 1.8 4WD						
Corolla Rumion 1.8,		09/07→				
Corolla Rumion 1.8 4WD						
Corolla Saloon 1.8		01/09→				
Corolla Saloon 1.8 4WD		08/07→				
Isis 1.8 VVTi, Isis 1.8 VVTi 4WD		04/07→				
Premio 1.8, Premio 1.8 4WD		07/07→				
Verso 1.8, Wish MPV 1.8, Wish MPV 1.8 4WD		04/09→				
Allion I 1.8, Allion I 1.8 4WD		06/01→06/07	2ZR-FE			
Auris 1.8 VVTi		10/06→		4cyl.		
Corolla Saloon 1.8 VVTi		08/10→		1798cc	98kW (133PS)	
Corolla Saloon 1.8 VVTL-i		05/07→				
Yaris 1.8 VVTi		01/07→				
08-439300-00	STD	80.50	1.000		001 CR P	ST
			1.000		026	ST
			1.500		231 PVD	ST
Corolla Coupe 1.6 SR		08/83→04/85	4A-C			16
Corolla Coupe 1.6 SR 16V		05/83→04/87		4cyl.		
Corolla FX Compact 1.6		08/84→08/87		1587cc	57kW (77PS)	
Carina II 1.6, Carina II Saloon 1.6		10/83→11/87	4A-LC			TD3814
Corolla 1.6		08/85→05/88		4cyl.		
Corolla FX Compact 1.6		01/87→09/87		1587cc	53-55kW (72-75PS)	
Corolla Liftback 1.6		04/85→06/89				
Sprinter Coupe 1.6, Sprinter Hatchback 1.6		10/84→07/87				
08-373200-00	STD	81.00	1.500		001 CR P	KV1
08-373207-00	0.50mm		1.500		026 P	STD
[R42110]			2.800		236 P	STD



Avensis 1.6, Avensis Liftback 1.6, Avensis Station Wagon 1.6	09/97→10/00	4A-FE	4cyl.	1587cc	84kW (114PS)	17
Caldina 1.6	02/92→09/97					
Caribe Estate 1.6	09/94→08/03					
Carina E 1.6	12/93→09/97					
Carina E 1.6 16V	10/95→09/97					
Carina E 1.6 GLI	04/92→09/97					
Carina E Saloon 1.6	01/93→09/97					
Carina E Saloon 1.6 16V	12/94→09/97					
Carina E Sportswagon 1.6	04/92→09/97					
Carina E Sportswagon 1.6 GLI	01/93→09/97					
Carina E Sportswagon 1.6 i	02/95→09/97					
Carina II 1.6	12/87→03/92					
Carina II 1.6 4WD	06/88→03/92					
Carina II Saloon 1.6, Carina II Saloon 1.6 4WD, Carina II Station Wagon 1.6, Carina II Station Wagon 1.6 GX 4WD	12/87→03/92					
Celica Coupe 1.6 STI	10/89→11/93					
Corolla 1.6	05/92→02/00					
Corolla 1.6 Aut.	04/97→02/00					
Corolla 1.6 i	11/89→06/93					
Corolla 1.6 i 4WD	10/87→08/90					
Corolla 1.6 Si	09/95→04/97					
Corolla Compact 1.6, Corolla Compact 1.6 Aut.	04/97→02/00					
Corolla Compact 1.6 i	08/89→04/92					
Corolla Compact 1.6 Si	07/92→04/97					
Corolla Liftback 1.6	08/89→02/00					
Corolla Liftback 1.6 Aut.	04/97→02/00					
Corolla Liftback 1.6 GLI	07/92→04/97					
Corolla Station Wagon 1.6 XLI	11/89→06/92					
Corolla Station Wagon 1.6 XLI 4WD	08/88→06/92					
Corolla Wagon 1.6	07/92→02/00					
Corolla Wagon 1.6 Aut.	04/97→02/00					
Corolla Wagon 1.6 Si	07/92→04/97					
Corona Estate 1.6	02/92→09/97					
Corona Hatchback 1.6, Corona Saloon 1.6	06/89→09/97					
Curren Coupe 1.6	09/89→10/93					
Sprinter Carib 1.6	08/95→10/01					
Sprinter Carib 1.6 4WD	11/87→07/95					
Sprinter Hatchback 1.6	08/87→04/97					
Sprinter Hatchback 1.6 4WD	10/88→04/92					
Sprinter Saloon 1.6	06/92→04/97					TD3820

08-428300-00	STD	81.00	1.200		001 CR P	ST
08-428307-00	0.50mm		1.500		005 P	STD
			3.000		712 NT	ST

Celica 1.8 16V TS	08/99→09/05	2ZZ-GE	4cyl.	1796cc	141kW (192PS)	18
Corolla 1.8 VVTL-i TS	01/02→02/07					TD13369

08-439500-00	STD	82.00	1.200		001 NT	ST
			1.200		026	ST
			3.000		712 CR	ST



Avensis 1.9 D	09/02→02/03	1CD-FTV				
Avensis 2.0 D-4D	10/99→11/08		4cyl.			19
Avensis Estate 2.0 D-4D	04/03→11/08		1995cc	66-85kW (90-116PS)		
Avensis Liftback 2.0 D	09/02→02/03	Diesel		Turbo Intercooled		
Avensis Liftback 2.0 D-4D	10/99→02/03					
Avensis Saloon 2.0 D-4D	04/03→11/08					
Avensis Station Wagon 1.9 D	09/02→02/03					
Avensis Station Wagon 2.0 D-4D	10/99→02/03					
Avensis Verso 2.0 D-4D	08/01→08/05					
Corolla 2.0 D-4D	08/00→02/07					
Corolla Compact 2.0 D-4D	08/00→01/02					
Corolla Estate 2.0 D-4D	01/02→02/07					
Corolla Liftback 2.0 D-4D	09/00→01/02					
Corolla Saloon 2.0 D-4D	08/02→07/07					
Corolla Verso 2.0 D-4D	09/01→03/09					
Corolla Wagon 2.0 D-4D	04/97→10/01					
Previa 2.0 D-4D	03/01→01/06					
RAV 4 II 2.0 D-4D 4WD	09/01→11/05					TD15191

08-426600-00	STD	82.20	2.000		001 CR	ST
08-426607-00	0.50mm		1.500		005 NT	ST
			3.000		231 NT	ST

Carina 1.8 D, Carina Station Wagon 1.8 D	04/82→09/83	1C				20
Corolla 1.8 D	01/83→06/93		4cyl.			
Corolla Compact 1.8 D	08/87→04/92		1839cc	54kW (73PS)		
Corolla FX Compact 1.8 D	01/85→05/88	Diesel				
Corolla Hatchback 1.8 D	01/83→09/83					
Corolla Liftback 1.8 D	06/83→04/92					
Corolla Station Wagon 1.8 D	05/83→06/92					
Liteace Box 1.8 D	10/82→08/88					
Liteace Bus 1.8 D	10/85→07/88					
Liteace Wagon 1.8 D	10/82→09/85					TD3715

Corolla 1.8 D	07/85→05/88	1C-L				
Corolla FX Compact 1.8 D	08/85→08/87		4cyl.			
Corolla Liftback 1.8 D	06/83→08/87		1839cc	47kW (64PS)		
		Diesel				TD3716

Camry Liftback 1.8 Turbo-D	10/84→01/88	1C-TL				
Camry Saloon 1.8 Turbo-D	11/83→01/88		4cyl.			
			1839cc	54kW (73PS)		
		Diesel	Turbo			TD3717

08-374300-00	STD	83.00	2.000		007 IFU CK P	KV1
[R44140]			2.000		005 P	STD
			4.000		231 CR P	STD



Avensis Estate 2.0 VVTi, Avensis Saloon 2.0 VVTi	04/03→11/08	1AZ FE							21
Avensis Verso 2.0 VVT-i	08/01→11/09		4cyl.	1998cc	110kW (150PS)				
Camry 2.0 VVTi	08/01→11/06								
Camry Saloon 2.0	09/11→								
Camry Saloon 2.0 VVT-i	01/06→09/11								
RAV 4 II 2.0 VVTi 4WD	06/00→11/05								
RAV 4 III 2.0 VVT-i 4WD	03/06→								
Vista Saloon 2.0 D4 N200, Vista Saloon 2.0 D4 N200 4WD	06/98→08/03								TD14870

08-439900-00	STD	86.00	1.200		001 NT		ST
			1.200		026 P		STD
			2.000		712 NT		ST

Auris 2.2 D	03/07→	2AD-FHV Euro 4							22
Avensis 2.2 D-CAT	07/05→11/08		4cyl.	2231cc	130kW (177PS)				
Avensis Estate 2.2 D-4D	02/09→								
Avensis Estate 2.2 D-CAT	07/05→11/08	Diesel		Turbo Intercooled					
Avensis Saloon 2.2 D-4D	02/09→								
Avensis Saloon 2.2 D-CAT	07/05→11/08								
Corolla Saloon 2.2 D-4D	11/06→								
Corolla Verso 2.2 D-4D	10/05→03/09								
RAV 4 III 2.2 D-4D, RAV 4 III 2.2 D-4D 4WD	12/08→								
RAV 4 III 2.2 D-CAT 4WD	03/06→								
RAV 4 IV 2.2 D4-D 4WD	12/12→								
Verso 2.2 D-4D, Verso 2.2 D-CAT	04/09→								TD18483

08-436300-00	STD	86.00	2.000		001 NT		ST
			1.500		026 P		ST
			2.000		231 NT		ST



Avensis 2.0, Avensis Liftback 2.0, Avensis Station Wagon 2.0	09/97→10/00	3S-FE	4cyl.	1998cc	88-98kW (120-133PS)	23
Caldina 2.0	02/92→10/97					
Camry 2.0	11/86→05/91					
Camry 2.0 4WD	08/88→05/91					
Camry 2.0 Gli 16V	11/86→05/91					
Camry 2.0 GLi 4WD	10/87→07/88					
Camry 2000ZX 4WD	06/91→09/97					
Camry Saloon 2.0	03/83→07/88					
Camry Saloon 2.0 GLi 4WD	03/83→07/86					
Camry Station Wagon 2.0	11/86→06/91					
Camry Station Wagon 2.0 GLi 16V	11/86→05/91					
Camry Station Wagon 2.0 GLi 4WD	08/88→05/91					
Carina E 2.0 GLI	04/92→09/97					
Carina E 2.0 i	12/93→09/97					
Carina E Saloon 2.0	01/93→09/97					
Carina E Saloon 2.0 i	12/92→09/97					
Carina E Sportswagon 2.0 GLI	01/93→09/97					
Carina E Sportswagon 2.0 i	05/95→09/97					
Carina II 2.0 GLI, Carina II Saloon 2.0,	12/87→03/92					
Carina II Saloon 2.0 4WD,						
Carina II Saloon 2.0 GLI						
Carina II Station Wagon 2.0	12/87→04/92					
Carina II Station Wagon 2.0 4WD,	12/87→03/92					
Carina II Station Wagon 2.0 GLi						
Corona Estate 2.0, Corona Hatchback 2.0	02/92→09/97					
Corona Hatchback 2.0 EZ	12/87→01/92					
Corona Saloon 2.0	02/92→09/97					
Corona Saloon 2.0 EZ	12/87→01/92					
MR 2 II 2.0	12/89→08/92					
Nadia 2.0	04/98→08/03					
Picnic 2.0	06/00→01/03					
Picnic 2.0 16V	05/96→12/01					
Previa 2.0	10/00→08/03					
RAV 4 I 2.0	06/97→09/99					
RAV 4 I 2.0 4WD	01/94→06/00					
RAV 4 I Cabrio 2.0 16V 4WD	12/97→06/00					
Scepter Estate 2.0, Scepter Saloon 2.0	10/86→09/96					
Vista Estate 2.0	11/88→06/91					
Vista Saloon 2.0	10/86→06/90					TD3798

08-439700-00	STD	86.00	1.200		001 NT	ST
			1.200		026 P	STD
			3.000		712 CR	ST

Coaster Bus 2.0	08/77→04/82	5R	4cyl.	1997cc	46-72kW (63-98PS)	24
Dyna Platform/Chassis 2.0	08/77→08/84					TD3849

08-372100-10	STD	88.00	2.000		001 IF CR P	IKA
			2.500		026 P	STD
			4.000		712 CR	ST



Alphard I 2.4, Alphard I 2.4 Hybrid, Alphard I 2.4 Hybrid 4WD	09/03→04/08	2AZ-FXE	4cyl.			25
Alphard II 2.4 Hybrid	12/11→		2362cc	110kW (150PS)		
Aurion 2.4 Hybrid	11/00→09/11					
Camry 2.4 VVTi Hybrid	01/06→11/06					
Camry Saloon 2.4 VVTi Hybrid, Camry Saloon 2.4 VVT-i Hybrid	01/06→09/11					
Previa 2.4 4WD	07/02→12/05					
Previa 2.4 Hybrid, Previa 2.4 Hybrid 4WD	10/05→01/06					
Previa III 2.4 Hybrid	05/12→					
Previa III 2.4 Hybrid 4WD	10/06→					
SAI 2.4 Hybrid	11/09→					TD19295

08-436400-00 STD	88.50	1.200		001 NT	ST
		1.200		026	ST
		2.000		712 NT	ST

Blizzard 2.2	03/82→12/83	L				26
Cressida Saloon 2.2 D	09/80→07/84		4cyl.			
Cressida Station Wagon 2.2 D	06/81→03/85		2188cc	46-49kW (63-67PS)		
Crown Saloon 2.2 D	04/80→07/83	Diesel				
Hiace I Box 2.2 D	01/79→03/83					
Hiace I Wagon 2.2 D	01/80→12/80					
Hiace II Box 2.2 D, Hiace II Wagon 2.2 D	03/83→11/89					
Hiace Pickup 2.2 D	01/79→07/85					
Hilux I Pickup 2.2 D	05/79→03/83					
Hilux II Pickup 2.2 D, Hilux II Pickup 2.2 D 4WD	08/83→08/84					
Mark II Saloon 2.2 DX	08/80→10/83					
Town Ace Box 2.2 D	04/85→09/90					
Town Ace Bus 2.2 D	04/85→12/91					TD4955

08-373600-00 STD	90.00	2.500		001 MO P	KV1	
		[R67080]	2.000		005 CR P	STD
			4.000		231 CR P	STD
08-373700-00 STD	90.00	2.000		007 CR P	KV1	
		[R41540]	2.000		005 CR P	STD
			4.000		231 CR P	STD

Land Cruiser 4.0 D	08/80→10/84	2H				27
Land Cruiser 4.0 D 4x4	08/87→12/89		6cyl.			
Land Cruiser 4.0 Diesel	10/81→01/88		3980cc	74-77kW (101-105PS)		
Land Cruiser Pickup 4.0 D	08/80→10/84	Diesel				TD3758

08-526800-00 STD	91.00	2.500		007 CR	GOE13	
		[R42770]	2.500		005 CR	GOE13
			4.000		231 CR	GOE13



Chaser 2.4 D		10/92→08/96	2L				28
Cresta Saloon 2.4 D		09/88→10/96		4cyl.			
Dyna 150 Platform/Chassis 2.4 D		08/85→07/01		2446cc	53-61kW (72-83PS)		
Dyna Bus 2.4 D		08/87→07/01	Diesel				
Dyna Pickup 2.4 D		08/77→04/79					
Dyna Platform/Chassis 2.4 D		08/77→04/95					
Hiace II Box 2.4 D		05/84→11/89					
Hiace II Box 2.4 D 4WD		04/84→07/87					
Hiace II Wagon 2.4 D		08/84→08/89					
Hiace II Wagon 2.4 D 4WD		01/87→01/88					
Hiace III Box 2.4 D		09/89→08/95					
Hiace III Box 2.4 D 4WD,		08/89→08/95					
Hiace III Wagon 2.4 D,							
Hiace III Wagon 2.4 D 4WD							
Hiace IV Box 2.4 D, Hiace IV Bus 2.4 D,		08/95→08/06					
Hiace IV Platform/Chassis 2.4 D							
Hilux II Pickup 2.4 D		08/88→07/05					
Hilux II Pickup 2.4 D 4WD		01/84→07/05					
Hilux II Platform/Chassis 2.4 D 4WD		01/84→08/88					
Kijang Bus 2.4 D		08/89→08/95					
Land Cruiser 2.4 D		11/84→10/85					
Mark II Estate 2.4 D		04/88→09/96					
Tamaraw FX 2.4 D		01/99→10/04					
Town Ace Box 2.4 D, Town Ace Bus 2.4 D		04/85→12/91				TD4938	
4 Runner 2.4 TD		08/89→11/95	2L-T				
Cressida Saloon 2.4 TD		01/85→10/88		4cyl.			
Hiace IV Box 2.4 TD,		08/95→08/06		2446cc	63-66kW (85-90PS)		
Hiace IV Box 2.4 TD 4WD,			Diesel	Turbo			
Hiace IV Bus 2.4 TD,							
Hiace IV Bus 2.4 TD 4WD							
Hilux Closed Off-Road Vehicle 2.4 TD 4WD		08/89→07/01					
Hilux II Pickup 2.4 TD 4WD		08/98→01/02					
Land Cruiser 2.4 TD		10/85→05/93					
Land Cruiser Hardtop 2.4 TD		07/90→05/96				TD3767	
Crown Saloon 2.4 D		08/94→07/02	2L-TE				
Mark II Saloon 2.4 TD		11/84→09/96		4cyl.			
				2446cc	66-71kW (90-97PS)		
			Diesel	Turbo Intercooled		TD24627	
08-373800-00	STD	92.00	2.000		007 CR P	KV1	
08-373807-00	0.50mm		2.000		005 P	STD	
[R42780]			4.000		231 CR P	STD	
Land Cruiser 3.0 D		02/74→10/84	B				
				4cyl.		29	
				2977cc	59-63kW (80-86PS)		
			Diesel			TD9039	
08-526300-00	STD	95.00	2.500		007 CR	KV1	
[R34990]			2.500		005 CR	STD	
			4.500		231 CR	STD	



Dyna Bus 3.0 D4d	08/01→	1KD-FTV				30
Dyna Platform/Chassis 3.0 D4d,	09/06→		4cyl.			
Dyna Platform/Chassis 3.0 D4d 4WD			2982cc	120-122kW (163-166PS)		
Fortuner Closed Off-Road Vehicle 3.0 D	08/09→	Diesel	Turbo Intercooled			
Hiace IV Box 3.0 D, Hiace IV Wagon 3.0 D	01/05→					
Hilux III Pickup 3.0	08/05→09/06					
Hilux III Pickup 3.0 D	10/06→					
Hilux III Pickup 3.0 D-4D 4WD	12/07→					
Hilux III Platform/Chassis 3.0 D,	02/05→					
Hilux III Platform/Chassis 3.0 D 4WD						
Land Cruiser 3.0 D-4D	09/02→					
Land Cruiser 90 3.0 D-4D	10/00→					
Land Cruiser 150 3.0 D-4D	01/10→					
Regiusace Box 3.0 D-4D,	08/04→					
Regiusace Box 3.0 D-4D 4WD,						
Regiusace Bus 3.0 D-4D,						
Regiusace Bus 3.0 D-4D 4WD					TD15208	

08-422400-00	STD	96.00	2.000		007 NT	
08-422407-00	0.50mm		1.500		005 NT	
			3.000		231 NT	

Dyna 150 Platform/Chassis 2.8 D	09/88→08/98	3L				31
Hiace III Box 2.8 D,	08/89→08/00		4cyl.			
Hiace III Wagon 2.8 D			2779cc	58-61kW (79-83PS)		
Hiace IV Box 2.8 D, Hiace IV Wagon 2.8 D	08/95→08/00	Diesel				
Hilux Closed Off-Road Vehicle 2.8 D	01/95→08/98					
Hilux II Pickup 2.8 D	09/91→11/97					
Hilux II Pickup 2.8 D 4WD	10/88→07/01					
Hilux II Platform/Chassis 2.8 D 4WD	08/88→08/97					
Kijang Bus 2.7 D	09/93→08/00					
Land Cruiser 2.7 TD 4x4	01/90→08/01					
Town Ace Box 2.8 D, Town Ace Bus 2.8 D	05/95→09/01				TD3796	

08-528800-00	STD	96.00	2.000		007 CR	GOE13
08-528807-00	0.50mm		2.000		005 CR	GOE13
[R48660]			4.000		231 CR	GOE13

Dyna 150 Platform/Chassis 3.4 D	09/88→06/95	3B				32
Dyna 200 Platform/Chassis 3.4 D	10/92→05/99		4cyl.			
Dyna 300 Platform/Chassis 3.4 D	06/95→05/99		3432cc	66-72kW (90-98PS)		
Land Cruiser 3.4 D	08/80→12/96	Diesel				
Land Cruiser 3.4 Diesel	10/81→08/87					
Land Cruiser Pickup 3.4 D	08/80→10/84				TD3789	

08-374000-00	STD	102.00	2.500		007 CR P	KV1
[R41840]			2.500		005 P	STD
			4.500		231 CR P	STD



Acclaim 1.3		01/82→12/85	EJ	4cyl. 1335cc 51kW (69PS)		1
TD5249						

08-228300-00	STD	72.00	1.500		001 IF CR P	IKA
			1.500		005 P	STD
			4.000		236 P	STD

TR 6 2.5		01/72→12/76	CF1	6cyl. 2498cc 83-90kW (113-122PS)		2
TD18385						

08-525700-00	STD	74.70	1.588		001	GOE12
08-525707-00	.020		1.588		023	GOE12
08-525709-00	.030		1.588		231 CR	GOE12
08-525711-00	.040		1.588			
[R22626]						



Rocket 3			01/68→12/72	A75R			
T150			01/68→12/76		3cyl.		1
T160V			01/76→12/77		740cc		
Trident			01/68→12/77				FM21720

08-525800-00	STD	66.96	1.590		005 P		IKA
08-525807-00	.020		3.170		232 P		GOE12
<i>[R23020]</i>			3.170		232 P		GOE12

Bonneville			01/59→12/75	TR6			
T110			01/54→12/62		2cyl.		2
T120			01/59→12/75		649cc		
Tiger 110			01/54→12/62				
Trophy			01/56→12/71				FM11720

08-525400-00	STD	70.99	1.590		005 P		IKA
08-525407-00	.020		1.590		005 P		IKA
08-525411-00	.040		3.175		030 P		IKA
08-525414-00	.060						
<i>[R11050]</i>							

Bonneville T140			01/70→	T140			
					2cyl.		3
					747cc		
							FM31720

08-523700-00	STD	75.97	1.600		005 P		GOE12
08-523707-00	.020		1.600		005 P		GOE12
<i>[R26490]</i>			3.170		232 P		GOE12



2.0l						4cyl.		2000cc		1	
										FM6198	
08-215300-10	STD	84.00	1.500		001 IF CR P					KV1	
08-215306-10	0.40mm				026 P					STD	
08-215308-10	0.60mm					232 P					STD
[R46970]			3.947								

2.4TD						4cyl.		2400cc		Diesel		2		
												FM6199		
08-110100-00	STD	92.00	2.500		008 CR P							KV1		
[R47730]				2.000		026 P							STD	
				4.000		231 CR P							STD	

2.3l D						4cyl.				Diesel		3		
												FM8952		
2.5l D						4cyl.				Diesel		FM8953		
08-318700-10	STD	94.00	2.000		001 CR P							KV1		
08-318704-10	0.20mm					005 IF P							STD	
08-318706-10	0.40mm			2.000										
08-318707-10	0.50mm					231 CR P							STD	
08-318708-10	0.60mm			4.000										
08-318710-10	0.80mm													
[R66140]														



1

3.152		3cyl.	2500cc	22-33kW (30-45PS)	Diesel	Indirect Injection	FM1351
08-314600-00 ¹ STD [R34560K]		91.49	2.385		001 IW CR P		STD
			2.385		005 IF P		STD
			3.160		026 P		STD
			6.335		231 P		STD
			6.335		031 P		STD
08-525100-00 STD [R34550]		91.49	2.385		001 P		GOE12
			2.385		005 P		GOE12
			3.160		026 P		GOE12
			6.350		030		GOE12
			6.350		030		GOE12

¹ Not for chromed cylinders

¹ Nicht für verchromte Zylinder

¹ Non appropriés pour cylindres chromés

¹ No se usan para cilindros cromados

2

4.236		4cyl.	3900cc		Diesel		FM8954
08-318900-10 STD 08-318905-10 0.25mm [R34740/2K]		98.48	2.385		001 IF CR P		KV1
			2.385		005 IW P		STD
			4.747		231 CR P		STD



1						
D121		4cyl.	Diesel			FM8979
08-207200-00	STD	95.00	2.500		001 IW CR P	KV1
08-207208-00	0.60mm		2.500		023 P	IKA
[R46770]			5.500		231 CR P	STD

2						
D115		3cyl.	Diesel			FM8978
08-134000-00	STD	102.00	2.500		001 CR P	IKA
			2.500		001 P	STD
			5.000		231 P	STD

3						
D113		4cyl.	Diesel			FM5581
08-381100-00	STD	108.00	3.000		001 IF CR P	STD
08-381111-00	1.00mm		3.000		005 P	STD
			3.000		023 P	STD
			6.000		231 P	STD
			6.000		031 P	STD

MODEL INDEX

Modelverzeichnis • Index de modele • Índice de Modelo
Indeks modelu • Модель автомобиля • دليل الموديل



CCM

x



9

09/00→08/05	Agila Mk I 1.0 12V	Z 10 XE	Petrol	973	3	10
02/00→11/06	Agila Mk I 1.0 12V	Z 10 XEP	Petrol	998	3	11
09/00→03/08	Agila Mk I 1.2 16V	Z 12 XE	Petrol	1199	4	10
07/04→11/06	Agila Mk I 1.2 16V Twinport	Z 12 XEP	Petrol	1229	4	11
08/03→03/08	Agila Mk I 1.3 CDTI	Z 13 DT Euro 4	Diesel	1248	4	3
01/08→	Agila Mk II 1.3 CDTI	Z 13 DTJ	Diesel	1248	4	4
03/98→08/01	Arena Combi 1.9 D	F8Q 600	Diesel	1870	4	28
03/98→08/01	Arena Combi 1.9 D	F8Q 606	Diesel	1870	4	28
03/98→08/01	Arena Combi 2.5 D	S8U 758	Diesel	2499	4	56
03/98→08/01	Arena Combi 2.5 D	S8U 780	Diesel	2499	4	56
03/98→08/01	Arena Combi 2.5 D	S8U 782	Diesel	2499	4	56
03/98→08/01	Arena Van 1.9 D	F8Q 600	Diesel	1870	4	28
03/98→08/01	Arena Van 1.9 D	F8Q 606	Diesel	1870	4	28
03/98→08/01	Arena Van 2.5 D	S8U 758	Diesel	2499	4	56
03/98→08/01	Arena Van 2.5 D	S8U 780	Diesel	2499	4	56
03/98→08/01	Arena Van 2.5 D	S8U 782	Diesel	2499	4	56
10/79→08/82	Astra 1.2	12 S	Petrol	1196	4	18
08/82→08/84	Astra Estate 1.3	13 S	Petrol	1297	4	12
09/79→08/84	Astra Estate 1.3 S	13 S	Petrol	1297	4	12
02/82→08/86	Astra Estate 1.6 D	16 D	Diesel	1598	4	26
09/81→08/86	Astra Estate 1.6 S	16 SH	Petrol	1598	4	27
10/11→	Astra GTC Mk VI 1.4	A 14 NET Euro 5	Petrol	1364	4	9
10/11→	Astra GTC Mk VI 1.6	A 16 LET Euro 5	Petrol	1598	4	21
12/12→	Astra GTC Mk VI 2.0 BiTurbo CDTI	A 20 DTR Euro 5	Diesel	1956	4	36
10/11→	Astra GTC Mk VI 2.0 CDTi	A 20 DTH Euro 5	Diesel	1956	4	36
10/79→08/84	Astra Hatchback 1.2	12 S	Petrol	1196	4	18
02/82→08/84	Astra Hatchback 1.2 S	12 S	Petrol	1196	4	18
09/80→08/84	Astra Hatchback 1.3	13 S	Petrol	1297	4	12
09/79→08/84	Astra Hatchback 1.3 S	13 S	Petrol	1297	4	12
03/82→08/86	Astra Hatchback 1.6 D	16 D	Diesel	1598	4	26
09/81→08/86	Astra Hatchback 1.6 S	16 S	Petrol	1598	4	44
03/83→08/86	Astra Hatchback 1.8 GTE	18 E	Petrol	1796	4	42
09/84→07/86	Astra Mk II 1.2	12 SC	Petrol	1196	4	18
09/85→08/91	Astra Mk II Belmont 1.3	13 S	Petrol	1297	4	12
09/85→08/91	Astra Mk II Belmont 1.3 i CAT	C 13 N	Petrol	1297	4	12
01/90→12/91	Astra Mk II Belmont 1.4 i	C 14 NZ	Petrol	1389	4	14
01/88→08/90	Astra Mk II Belmont 1.5 DT	15 DT (T4EC1)	Diesel	1488	4	13
09/85→08/91	Astra Mk II Belmont 1.6	16 SH	Petrol	1598	4	27
09/85→08/91	Astra Mk II Belmont 1.6 D	16 DA	Diesel	1598	4	26
01/89→12/91	Astra Mk II Belmont 1.6 S	16 SV	Petrol	1598	4	19
01/89→12/91	Astra Mk II Belmont 1.7 D	17 D	Diesel	1699	4	35
01/86→12/90	Astra Mk II Belmont 1.8	18 SE	Petrol	1796	4	42
09/85→08/91	Astra Mk II Belmont 1.8 i	18 E	Petrol	1796	4	42
09/85→08/91	Astra Mk II Belmont 1.8 i	18 SE	Petrol	1796	4	42
10/85→08/86	Astra Mk II Belmont 1.8 i	C 18 NE	Petrol	1796	4	42
01/87→12/91	Astra Mk II Convertible 1.6 i	16 SV	Petrol	1598	4	19
01/91→08/93	Astra Mk II Convertible 1.6 i	E 16 NZ	Petrol	1598	4	19
10/87→02/93	Astra Mk II Convertible 1.6 i CAT	C 16 LZ	Petrol	1598	4	19
10/87→02/93	Astra Mk II Convertible 1.6 i CAT	C 16 NZ	Petrol	1598	4	19
01/87→12/91	Astra Mk II Convertible 2.0 i	20 NE	Petrol	1998	4	46
01/91→08/93	Astra Mk II Convertible 2.0 i CAT	C 20 NE	Petrol	1998	4	46
09/84→12/88	Astra Mk II Estate 1.2	12 S	Petrol	1196	4	18
09/84→08/91	Astra Mk II Estate 1.3	13 S	Petrol	1297	4	12
01/89→08/91	Astra Mk II Estate 1.4 S	14 NV	Petrol	1389	4	14
01/88→08/91	Astra Mk II Estate 1.5 DT	15 DT (T4EC1)	Diesel	1488	4	13
09/84→08/91	Astra Mk II Estate 1.6	16 SV	Petrol	1598	4	19
09/84→12/89	Astra Mk II Estate 1.6 D	16 DA	Diesel	1598	4	26
09/84→08/86	Astra Mk II Estate 1.6 S	16 S	Petrol	1598	4	44
09/84→08/86	Astra Mk II Estate 1.6 S	16 SH	Petrol	1598	4	27
02/89→08/91	Astra Mk II Estate 1.7 D	17 D	Diesel	1699	4	35



CCM

x



9

01/90→08/91	Astra Mk II Estate 1.8 i	18 E	Petrol	1796	4	42
09/84→08/91	Astra Mk II Hatchback 1.2	12 S	Petrol	1196	4	18
09/84→08/91	Astra Mk II Hatchback 1.3	13 S	Petrol	1297	4	12
01/90→08/91	Astra Mk II Hatchback 1.4 i	C 14 NZ	Petrol	1389	4	14
01/90→08/91	Astra Mk II Hatchback 1.4 S	14 NV	Petrol	1389	4	14
09/84→08/91	Astra Mk II Hatchback 1.6	16 SV	Petrol	1598	4	19
09/84→12/89	Astra Mk II Hatchback 1.6 D	16 DA	Diesel	1598	4	26
09/84→08/86	Astra Mk II Hatchback 1.6 S	16 SH	Petrol	1598	4	27
01/89→08/91	Astra Mk II Hatchback 1.7 D	17 DR	Diesel	1699	4	35
09/84→08/91	Astra Mk II Hatchback 1.8 GTE	18 E	Petrol	1796	4	42
09/84→08/91	Astra Mk II Hatchback 1.8 GTE	18 SE	Petrol	1796	4	42
03/88→08/91	Astra Mk II Hatchback 1.9	C 20 XE	Petrol	1998	4	46
09/86→08/91	Astra Mk II Hatchback 2.0	20 NE	Petrol	1998	4	46
09/86→08/91	Astra Mk II Hatchback 2.0 GTE	20 SEH	Petrol	1998	4	46
05/88→08/91	Astra Mk II Hatchback 2.0 GTE 16V	20 XE	Petrol	1998	4	46
09/91→09/93	Astra Mk III 1.4	14 NV	Petrol	1389	4	14
09/91→09/98	Astra Mk III 1.4 i	C 14 NZ	Petrol	1389	4	14
03/91→03/01	Astra Mk III 1.4 i	C 14 SE	Petrol	1389	4	14
01/96→03/01	Astra Mk III 1.4 i 16V	X 14 XE	Petrol	1389	4	14
09/91→02/98	Astra Mk III 1.4 S	14 NV	Petrol	1389	4	14
03/94→08/95	Astra Mk III 1.6	C 16 SE	Petrol	1598	4	19
09/91→09/98	Astra Mk III 1.6 i	C 16 NZ	Petrol	1598	4	19
03/92→02/98	Astra Mk III 1.6 i	C 16 SE	Petrol	1598	4	19
09/91→02/98	Astra Mk III 1.6 i	E 16 NZ	Petrol	1598	4	19
03/93→02/98	Astra Mk III 1.6 i	X 16 SZ	Petrol	1598	4	19
03/92→03/01	Astra Mk III 1.6 i	X 16 SZR	Petrol	1598	4	19
01/94→09/98	Astra Mk III 1.6 i 16V	X 16 XEL	Petrol	1598	4	22
03/91→12/94	Astra Mk III 1.6 Si	C 16 SE	Petrol	1598	4	19
12/91→02/98	Astra Mk III 1.7 D	17 D	Diesel	1699	4	35
03/91→09/98	Astra Mk III 1.7 D	17 DR	Diesel	1699	4	35
12/91→09/98	Astra Mk III 1.7 TD	17 DT (TC4EE1)	Diesel	1686	4	20
01/94→09/98	Astra Mk III 1.7 TD	X 17 DTL	Diesel	1699	4	35
09/94→08/96	Astra Mk III 1.8	C 18 XE	Petrol	1796	4	32
11/94→03/01	Astra Mk III 1.8 16V	C 18 XEL	Petrol	1796	4	32
11/94→03/01	Astra Mk III 1.8 16V	X 18 XE	Petrol	1796	4	32
09/91→09/98	Astra Mk III 1.8 i	C 18 NZ	Petrol	1796	4	42
09/95→02/98	Astra Mk III 1.8 i 16V	18 SE	Petrol	1796	4	42
06/93→02/98	Astra Mk III 1.8 i 16V	C 18 XE	Petrol	1796	4	32
01/94→02/98	Astra Mk III 1.8 i 16V	C 18 XEL	Petrol	1796	4	32
09/94→02/98	Astra Mk III 1.8 i 16V	X 18 XE	Petrol	1796	4	32
09/91→09/98	Astra Mk III 2.0 i	C 20 NE	Petrol	1998	4	46
09/91→02/98	Astra Mk III 2.0 i 16V	C 20 XE	Petrol	1998	4	46
01/94→09/98	Astra Mk III 2.0 i 16V	X 20 XEV	Petrol	1998	4	46
02/98→09/00	Astra Mk IV 1.2 16V	X 12 XE	Petrol	1199	4	10
09/00→05/05	Astra Mk IV 1.2 16V	Z 12 XE	Petrol	1199	4	10
05/98→05/05	Astra Mk IV 1.4	C 14 NZ	Petrol	1389	4	14
05/98→05/05	Astra Mk IV 1.4	X 14 SZ	Petrol	1389	4	14
02/98→05/05	Astra Mk IV 1.4 16V	X 14 XE	Petrol	1389	4	14
02/98→05/05	Astra Mk IV 1.4 16V	Z 14 XE	Petrol	1389	4	15
02/98→04/04	Astra Mk IV 1.6	X 16 SZR	Petrol	1598	4	19
03/98→05/05	Astra Mk IV 1.6	Z 16 SE	Petrol	1598	4	23
12/02→05/05	Astra Mk IV 1.6	Z 16 XEP	Petrol	1598	4	24
02/98→05/05	Astra Mk IV 1.6 16V	X 16 XEL	Petrol	1598	4	22
02/98→10/05	Astra Mk IV 1.6 16V	Z 16 XE	Petrol	1598	4	23
09/98→10/05	Astra Mk IV 1.6 16V	Z 16 XEP	Petrol	1598	4	24
07/00→05/05	Astra Mk IV 1.6 Dualfuel	Z 16 SE	Petrol	1598	4	23
03/98→05/05	Astra Mk IV 1.6 Dualfuel	Z 16 XE	Petrol	1598	4	23
04/03→05/05	Astra Mk IV 1.7 CDTI 16V	Z 17 DTL	Diesel	1686	4	20
02/00→05/05	Astra Mk IV 1.7 DTI 16V	Y 17 DT	Diesel	1686	4	20
02/98→08/00	Astra Mk IV 1.7 TD	X 17 DTL	Diesel	1699	4	35

MODEL INDEX

 Modelverzeichnis • Index de modele • Índice de Modelo
 Indeks modelu • Модель автомобиля • دليل الموديل

CCM

x



9

02/98→08/05	Astra Mk IV 1.8 16V	X 18 XE1	Petrol	1796	4	31
02/98→10/05	Astra Mk IV 1.8 16V	Z 18 XE	Petrol	1799	4	31
03/00→08/05	Astra Mk IV 1.8 16V	Z 18 XEL	Petrol	1796	4	31
02/98→08/05	Astra Mk IV 1.8 16V Dualfuel	Z 18 XE	Petrol	1799	4	31
02/98→05/05	Astra Mk IV 2.0 16V	X 20 XEV	Petrol	1998	4	46
02/98→05/05	Astra Mk IV 2.0 DI	X 20 DTL	Diesel	1995	4	40
02/98→05/05	Astra Mk IV 2.0 DI	Y 20 DTL	Diesel	1995	4	40
02/98→05/05	Astra Mk IV 2.0 DTI 16V	X 20 DTH	Diesel	1995	4	39
02/98→05/05	Astra Mk IV 2.0 DTI 16V	Y 20 DTH	Diesel	1995	4	41
09/02→05/05	Astra Mk IV 2.2 DTI	Y 22 DTR	Diesel	2172	4	41
08/05→10/10	Astra Mk V 1.2	Z 12 XEP	Petrol	1229	4	11
01/04→11/10	Astra Mk V 1.3 CDTi	Z 13 DTH	Diesel	1248	4	4
01/04→05/09	Astra Mk V 1.4	Z 14 XEP	Petrol	1364	4	11
03/05→11/10	Astra Mk V 1.4 i 16V	Z 14 XEP	Petrol	1364	4	11
01/04→11/10	Astra Mk V 1.6	Z 16 XEP	Petrol	1598	4	24
01/04→05/09	Astra Mk V 1.6	Z 16 XER	Petrol	1598	4	25
12/06→11/10	Astra Mk V 1.6 i 16V	Z 16 XER	Petrol	1598	4	25
01/04→11/10	Astra Mk V 1.7 CDTi	Z 17 DTH	Diesel	1686	4	20
01/04→05/09	Astra Mk V 1.7 CDTi	Z 17 DTL	Diesel	1686	4	20
01/04→11/10	Astra Mk V 1.8	Z 18 XE	Petrol	1799	4	31
01/04→05/09	Astra Mk V 1.8	Z 18 XER	Petrol	1796	4	31
03/07→11/10	Astra Mk V 1.8 i 16V	Z 18 XER	Petrol	1796	4	31
01/04→11/10	Astra Mk V 1.9 CDTi	Z 19 DT	Diesel	1910	4	33
01/04→11/10	Astra Mk V 1.9 CDTi	Z 19 DTH	Diesel	1910	4	34
08/04→11/10	Astra Mk V 1.9 CDTi	Z 19 DTL Euro 4	Diesel	1910	4	33
01/04→05/09	Astra Mk V 1.9 CDTi 16V	Z 19 DTJ	Diesel	1910	4	34
12/09→	Astra Mk VI 1.4 Turbo	A 14 NET Euro 5	Petrol	1364	4	9
12/09→	Astra Mk VI 1.6 Turbo	A 16 LET Euro 5	Petrol	1598	4	21
12/09→	Astra Mk VI 1.7 CDTi	Z 17 DTH	Diesel	1686	4	20
12/12→	Astra Mk VI 2.0 BiTurbo CDTi	A 20 DTR Euro 5	Diesel	1956	4	36
12/09→	Astra Mk VI 2.0 CDTi	A 20 DTH Euro 5	Diesel	1956	4	36
09/05→11/10	Astra TwinTop Mk V 1.6	Z 16 XEP	Petrol	1598	4	24
10/06→11/10	Astra TwinTop Mk V 1.6 i 16V	Z 16 XER	Petrol	1598	4	25
09/05→11/10	Astra TwinTop Mk V 1.8	Z 18 XE	Petrol	1799	4	31
05/08→11/10	Astra TwinTop Mk V 1.8	Z 18 XER	Petrol	1796	4	31
01/06→11/10	Astra TwinTop Mk V 1.9 CDTi	Z 19 DTH	Diesel	1910	4	34
01/91→10/94	Astra Van Mk III 1.4 i	C 14 NZ	Petrol	1389	4	14
01/91→08/98	Astra Van Mk III 1.6 i	C 16 NZ	Petrol	1598	4	19
02/94→10/96	Astra Van Mk III 1.6 i	X 16 SZ	Petrol	1598	4	19
01/91→08/94	Astra Van Mk III 1.7 D	17 DR	Diesel	1699	4	35
01/94→08/98	Astra Van Mk III 1.7 TD	X 17 DTL	Diesel	1699	4	35
08/98→09/00	Astra Van Mk IV 1.6 i	X 16 SZR	Petrol	1598	4	19
09/00→08/06	Astra Van Mk IV 1.6 i	Z 16 SE	Petrol	1598	4	23
04/04→08/06	Astra Van Mk IV 1.7 CDTi	Z 17 DTL	Diesel	1686	4	20
04/01→08/06	Astra Van Mk IV 1.7 DTI 16V	Y 17 DT	Diesel	1686	4	20
08/98→08/06	Astra Van Mk IV 1.7 TD	X 17 DTL	Diesel	1699	4	35
08/98→08/06	Astra Van Mk IV 2.0 DI	X 20 DTL	Diesel	1995	4	40
04/04→08/06	Astra Van Mk IV 2.0 DTI	Y 20 DTH	Diesel	1995	4	41
08/85→12/89	Astramax 1.3 N	13 N	Petrol	1297	4	12
08/85→12/89	Astramax 1.3 N	13 NB	Petrol	1297	4	12
08/85→12/89	Astramax 1.3 S	13 S	Petrol	1297	4	12
08/91→07/94	Astramax 1.4 i	C 14 NZ	Petrol	1389	4	14
07/89→08/91	Astramax 1.4 S	14 NV	Petrol	1389	4	14
09/85→12/91	Astramax 1.6	16 SV	Petrol	1598	4	19
05/86→06/90	Astramax 1.6 D	16 DA	Diesel	1598	4	26
08/91→10/94	Astramax 1.6 i	C 16 NZ	Petrol	1598	4	19
01/89→07/94	Astramax 1.7 D	17 D	Diesel	1699	4	35
08/05→	Astravan Mk V 1.3 CDTi	Z 13 DTH	Diesel	1248	4	4
03/05→	Astravan Mk V 1.4 i	Z 14 XEP	Petrol	1364	4	11
03/05→	Astravan Mk V 1.6	Z 16 XEP	Petrol	1598	4	24

CCM

x



03/05→11/11	Astravan Mk V 1.7 CDTi	Z 17 DTH	Diesel	1686	4	20
03/05→07/06	Astravan Mk V 1.7 CDTi	Z 17 DTL	Diesel	1686	4	20
03/05→11/11	Astravan Mk V 1.9 CDTi	Z 19 DT	Diesel	1910	4	33
03/05→11/11	Astravan Mk V 1.9 CDTi	Z 19 DTH	Diesel	1910	4	34
08/91→09/96	Brava Pickup 2.2 D	C 223	Diesel	2238	4	49
08/91→09/96	Brava Pickup 2.2 D 4x4	C 223	Diesel	2238	4	49
06/90→07/97	Calibra 2.0 i	C 20 NE	Petrol	1998	4	46
06/90→02/94	Calibra 2.0 i 16V	C 20 XE	Petrol	1998	4	46
06/90→07/97	Calibra 2.0 i 16V	X 20 XEV	Petrol	1998	4	46
06/90→02/94	Calibra 2.0 i 16V 4x4	C 20 XE	Petrol	1998	4	46
02/94→07/97	Calibra 2.0 i 16V 4x4	X 20 XEV	Petrol	1998	4	46
06/90→07/97	Calibra 2.0 i 4x4	C 20 NE	Petrol	1998	4	46
03/92→07/97	Calibra 2.0 i Turbo 4x4	C 20 LET	Petrol	1998	4	46
04/93→07/97	Calibra 2.5 i V6	C 25 XE	Petrol	2498	V6	32
04/93→07/97	Calibra 2.5 i V6	X 25 XE	Petrol	2498	V6	32
12/82→08/86	Carlton Mk II 1.8 S	18 S	Petrol	1796	4	42
01/83→12/84	Carlton Mk II 2.0 i	20 E	Petrol	1979	4	58
05/83→08/86	Carlton Mk II 2.3 D	23 D	Diesel	2260	4	53
11/82→08/86	Carlton Mk II Estate 1.8 S	18 S	Petrol	1796	4	42
09/77→08/86	Carlton Mk II Estate 1.9	20 E	Petrol	1979	4	58
05/83→08/86	Carlton Mk II Estate 2.3 D	23 D	Diesel	2260	4	53
09/87→03/94	Carlton Mk III 1.8	E 18 NVR	Petrol	1796	4	43
09/86→03/94	Carlton Mk III 1.8 i	18 SEH	Petrol	1796	4	42
09/86→08/87	Carlton Mk III 1.8 N	18 NV	Petrol	1796	4	43
09/86→03/94	Carlton Mk III 1.8 S	18 SV	Petrol	1796	4	42
09/86→03/94	Carlton Mk III 2.0	C 20 NE	Petrol	1998	4	46
09/86→03/94	Carlton Mk III 2.0 i	20 SE	Petrol	1998	4	46
10/86→08/88	Carlton Mk III 2.2 TD	23 YDT	Diesel	2260	4	54
08/88→03/94	Carlton Mk III 2.3 TD Interc.	23 DTR	Diesel	2260	4	54
09/88→03/94	Carlton Mk III 2.4 i	C 24 NE	Petrol	2410	4	59
09/90→03/94	Carlton Mk III 2.6 i	C 26 NE	Petrol	2594	6	50
03/87→09/90	Carlton Mk III 3.0 3000	30 NE	Petrol	2969	6	58
09/89→03/94	Carlton Mk III 3.0 3000 24V	C 30 SE	Petrol	2969	6	59
03/87→12/87	Carlton Mk III 3000	C 30 LE	Petrol	2969	6	58
09/89→03/94	Carlton Mk III 3000 24V	C 30 SEJ	Petrol	2969	6	59
03/88→03/94	Carlton Mk III 3000 CAT	C 30 NE	Petrol	2969	6	58
09/87→03/94	Carlton Mk III Estate 1.8	E 18 NVR	Petrol	1796	4	43
09/86→08/88	Carlton Mk III Estate 1.8	S 18 NV	Petrol	1796	4	43
09/86→03/94	Carlton Mk III Estate 1.8 i	18 SEH	Petrol	1796	4	42
09/86→08/87	Carlton Mk III Estate 1.8 N	18 NV	Petrol	1796	4	43
09/86→03/94	Carlton Mk III Estate 1.8 S	18 SV	Petrol	1796	4	42
09/86→03/94	Carlton Mk III Estate 2.0	C 20 NE	Petrol	1998	4	46
09/86→03/94	Carlton Mk III Estate 2.0 i	20 SE	Petrol	1998	4	46
09/86→08/88	Carlton Mk III Estate 2.2 TD	23 YDT	Diesel	2260	4	54
09/88→03/94	Carlton Mk III Estate 2.3 TD Interc.	23 DTR	Diesel	2260	4	54
09/88→03/94	Carlton Mk III Estate 2.4 i	C 24 NE	Petrol	2410	4	59
09/90→03/94	Carlton Mk III Estate 2.6 i	C 26 NE	Petrol	2594	6	50
03/87→03/94	Carlton Mk III Estate 3.0	C 30 NE	Petrol	2969	6	58
09/89→03/94	Carlton Mk III Estate 3.0 24V	C 30 SEJ	Petrol	2969	6	59
02/13→	Cascada Convertible 1.4	A 14 NET Euro 5	Petrol	1364	4	9
02/13→	Cascada Convertible 2.0 CDTi	A 20 DTH Euro 5	Diesel	1956	4	36
02/13→	Cascada Convertible 2.0 CDTi	A 20 DTR Euro 5	Diesel	1956	4	36
03/75→08/81	Cavalier 1.6 N	16 N	Petrol	1584	4	44
01/78→08/81	Cavalier 2.0 S	20 S	Petrol	1979	4	58
08/77→08/81	Cavalier 1300	13 N	Petrol	1297	4	12
08/77→08/81	Cavalier CC 2000	20 S	Petrol	1979	4	58
03/78→08/81	Cavalier Coupe 2.0 S	20 S	Petrol	1979	4	58
09/81→08/88	Cavalier Mk II 1.3 N	13 N	Petrol	1297	4	12
09/81→08/88	Cavalier Mk II 1.3 S	13 S	Petrol	1297	4	12
08/81→07/86	Cavalier Mk II 1.6	16 N	Petrol	1598	4	27

MODEL INDEX

Modelverzeichnis • Index de modele • Índice de Modelo
Indeks modelu • Модель автомобиля • دليل الموديل



CCM

x



9

03/82→08/88	Cavalier Mk II 1.6 D	16 D	Diesel	1598	4	26
08/86→08/88	Cavalier Mk II 1.6 i	E 16 NZ	Petrol	1598	4	19
08/86→08/88	Cavalier Mk II 1.6 i CAT	C 16 LZ	Petrol	1598	4	19
08/86→08/88	Cavalier Mk II 1.6 i CAT	C 16 NZ	Petrol	1598	4	19
09/81→08/88	Cavalier Mk II 1.6 N	16 N	Petrol	1598	4	27
09/81→08/88	Cavalier Mk II 1.6 S	16 SH	Petrol	1598	4	27
08/86→08/88	Cavalier Mk II 1.8	E 18 NV	Petrol	1796	4	43
09/81→08/88	Cavalier Mk II 1.8 i	18 E	Petrol	1796	4	42
09/81→08/88	Cavalier Mk II 1.8 i	18 SE	Petrol	1796	4	42
01/85→08/86	Cavalier Mk II 1.8 i CAT	C 18 NE	Petrol	1796	4	42
08/86→08/87	Cavalier Mk II 2.0	20 E	Petrol	1979	4	58
09/86→08/87	Cavalier Mk II 2.0	20 S	Petrol	1979	4	58
09/87→08/88	Cavalier Mk II 2.0 4x4	20 SEH	Petrol	1998	4	46
09/86→08/88	Cavalier Mk II 2.0 i	20 NE	Petrol	1998	4	46
09/86→08/88	Cavalier Mk II 2.0 i CAT	C 20 NE	Petrol	1998	4	46
03/87→08/88	Cavalier Mk II 2.0 SRi 130	20 SEH	Petrol	1998	4	46
09/86→08/88	Cavalier Mk II 2000i	20 SE	Petrol	1998	4	46
03/85→10/88	Cavalier Mk II Convertible 1800i	18 SE	Petrol	1796	4	42
09/81→08/88	Cavalier Mk II Estate 1.3 S	13 S	Petrol	1297	4	12
10/83→08/88	Cavalier Mk II Estate 1.6	16 SH	Petrol	1598	4	27
03/82→08/88	Cavalier Mk II Estate 1.6 D	16 DA	Diesel	1598	4	26
09/81→08/86	Cavalier Mk II Estate 1.8 i	18 E	Petrol	1796	4	42
09/81→08/86	Cavalier Mk II Estate 1.8 i	18 SE	Petrol	1796	4	42
09/81→08/88	Cavalier Mk II Hatchback 1.3	13 NB	Petrol	1297	4	12
09/81→08/88	Cavalier Mk II Hatchback 1.3 S	13 S	Petrol	1297	4	12
09/81→08/88	Cavalier Mk II Hatchback 1.6 S	16 SH	Petrol	1598	4	27
09/81→08/88	Cavalier Mk II Hatchback 1.8 i	18 E	Petrol	1796	4	42
09/81→08/88	Cavalier Mk II Hatchback 1.8 i	18 SE	Petrol	1796	4	42
07/82→08/88	Cavalier Mk II Hatchback 1.8 S	18 S	Petrol	1796	4	42
09/86→08/87	Cavalier Mk II Hatchback 2.0	20 E	Petrol	1979	4	58
09/86→08/87	Cavalier Mk II Hatchback 2.0	20 S	Petrol	1979	4	58
09/87→08/88	Cavalier Mk II Hatchback 2.0 4x4	20 SEH	Petrol	1998	4	46
09/86→08/88	Cavalier Mk II Hatchback 2.0 i CAT	C 20 NE	Petrol	1998	4	46
03/87→08/88	Cavalier Mk II Hatchback 2.0 SRi 130	20 SEH	Petrol	1998	4	46
03/82→08/88	Cavalier Mk II Hatchback 1600D	16 D	Diesel	1598	4	26
03/82→08/88	Cavalier Mk II Hatchback 1600D	16 DA	Diesel	1598	4	26
09/86→08/88	Cavalier Mk II Hatchback 2000i	20 SE	Petrol	1998	4	46
09/88→11/95	Cavalier Mk III 1.4 S	14 NV	Petrol	1389	4	14
09/88→05/93	Cavalier Mk III 1.6	16 SV	Petrol	1598	4	19
09/88→11/95	Cavalier Mk III 1.6 i	E 16 NZ	Petrol	1598	4	19
09/93→11/95	Cavalier Mk III 1.6 i	X 16 SZ	Petrol	1598	4	19
09/88→09/92	Cavalier Mk III 1.7 D	17 D	Diesel	1699	4	35
07/92→11/95	Cavalier Mk III 1.7 D	17 DR	Diesel	1699	4	35
09/88→11/95	Cavalier Mk III 1.7 TD	17 DT (TC4EE1)	Diesel	1686	4	20
09/88→08/95	Cavalier Mk III 1.8	18 SV	Petrol	1796	4	42
09/88→08/95	Cavalier Mk III 1.8	C 18 NZ	Petrol	1796	4	42
09/89→08/92	Cavalier Mk III 1.8	E 18 NVR	Petrol	1796	4	43
03/90→11/95	Cavalier Mk III 1.8 i CAT	C 18 NZ	Petrol	1796	4	42
09/89→08/92	Cavalier Mk III 2.0 GSi	20 XE	Petrol	1998	4	46
09/89→08/92	Cavalier Mk III 2.0 GSi 4x4	20 XE	Petrol	1998	4	46
09/88→10/90	Cavalier Mk III 2.0 i	20 NE	Petrol	1998	4	46
09/88→11/95	Cavalier Mk III 2.0 i 16V	C 20 XE	Petrol	1998	4	46
09/88→11/95	Cavalier Mk III 2.0 i 16V 4x4	C 20 XE	Petrol	1998	4	46
01/91→10/92	Cavalier Mk III 2.0 i 4x4	20 NE	Petrol	1998	4	46
09/88→09/92	Cavalier Mk III 2.0 i 4x4	20 SEH	Petrol	1998	4	46
09/90→11/95	Cavalier Mk III 2.0 i CAT	C 20 NE	Petrol	1998	4	46
06/92→11/94	Cavalier Mk III 2.0 i Turbo 4x4	C 20 LET	Petrol	1998	4	46
09/88→09/92	Cavalier Mk III 2.0 SRi	20 SEH	Petrol	1998	4	46
09/93→11/95	Cavalier Mk III 2.0 SRi 16V	X 20 XEV	Petrol	1998	4	46
08/88→06/94	Cavalier Mk III 2.5 V6	C 25 XE	Petrol	2498	V6	32



CCM

x



9

09/88→11/95	Cavalier Mk III Hatchback 1.4 S	14 NV	Petrol	1389	4	14
09/88→05/93	Cavalier Mk III Hatchback 1.6	16 SV	Petrol	1598	4	19
09/88→11/95	Cavalier Mk III Hatchback 1.6 i	E 16 NZ	Petrol	1598	4	19
09/93→11/95	Cavalier Mk III Hatchback 1.6 i	X 16 SZ	Petrol	1598	4	19
09/88→09/92	Cavalier Mk III Hatchback 1.7 D	17 D	Diesel	1699	4	35
07/92→11/95	Cavalier Mk III Hatchback 1.7 D	17 DR	Diesel	1699	4	35
09/88→11/95	Cavalier Mk III Hatchback 1.7 TD	17 DT (TC4EE1)	Diesel	1686	4	20
09/88→10/90	Cavalier Mk III Hatchback 1.8	18 SV	Petrol	1796	4	42
09/88→10/90	Cavalier Mk III Hatchback 1.8	C 18 NZ	Petrol	1796	4	42
03/90→11/95	Cavalier Mk III Hatchback 1.8 i CAT	C 18 NZ	Petrol	1796	4	42
09/88→10/92	Cavalier Mk III Hatchback 2.0 i	20 NE	Petrol	1998	4	46
09/88→11/95	Cavalier Mk III Hatchback 2.0 i 16V	C 20 XE	Petrol	1998	4	46
09/93→11/95	Cavalier Mk III Hatchback 2.0 i 16V	X 20 XEV	Petrol	1998	4	46
01/92→11/93	Cavalier Mk III Hatchback 2.0 i 16V 4x4	C 20 XE	Petrol	1998	4	46
01/91→10/92	Cavalier Mk III Hatchback 2.0 i 4x4	20 NE	Petrol	1998	4	46
09/88→09/92	Cavalier Mk III Hatchback 2.0 i 4x4	20 SEH	Petrol	1998	4	46
09/90→11/95	Cavalier Mk III Hatchback 2.0 i CAT	C 20 NE	Petrol	1998	4	46
09/88→09/92	Cavalier Mk III Hatchback 2.0 SRi	20 SEH	Petrol	1998	4	46
09/88→06/94	Cavalier Mk III Hatchback 2.5 V6	C 25 XE	Petrol	2498	V6	32
03/75→12/85	Chevette 1300	13 N	Petrol	1297	4	12
03/75→12/85	Chevette 1300	13 S	Petrol	1297	4	12
09/76→12/85	Chevette Estate 1.2	13 N	Petrol	1297	4	12
09/76→12/85	Chevette Estate 1300	13 S	Petrol	1297	4	12
03/75→12/85	Chevette Hatchback 1300	13 N	Petrol	1297	4	12
03/75→12/85	Chevette Hatchback 1300	13 S	Petrol	1297	4	12
01/12→	Combo D 1.4 CNG Turbo EcoFlex	A 14 FC Euro 5	Bi-fuel (Petrol/ Gas)	1364	4	6
07/94→10/01	Combo Mk I 1.2	C 12 NZ	Petrol	1187	4	8
07/94→10/01	Combo Mk I 1.2	X 12 SZ	Petrol	1195	4	8
07/94→10/01	Combo Mk I 1.4	C 14 NZ	Petrol	1389	4	14
07/94→10/01	Combo Mk I 1.4	C 14 SE	Petrol	1389	4	14
08/99→10/01	Combo Mk I 1.4 16V	X 14 XE	Petrol	1389	4	14
07/94→10/01	Combo Mk I 1.7 D	17 D (4EE1)	Diesel	1686	4	20
07/94→10/01	Combo Mk I 1.7 D	X 17 D (4EE1)	Diesel	1686	4	20
09/04→02/12	Combo Mk II 1.3 CDTI 16V	Z 13 DT Euro 4	Diesel	1248	4	3
10/05→11/11	Combo Mk II 1.3 CDTI 16V	Z 13 DTJ	Diesel	1248	4	4
10/01→05/07	Combo Mk II 1.4 16V	Z 14 XE	Petrol	1389	4	15
01/04→11/11	Combo Mk II 1.4 i 16V	Z 14 XEP	Petrol	1364	4	11
08/01→11/11	Combo Mk II 1.6	Z 16 SE	Petrol	1598	4	23
12/04→11/11	Combo Mk II 1.7 CDTI 16V	Z 17 DTH	Diesel	1686	4	20
09/01→11/11	Combo Mk II 1.7 DI 16V	Y 17 DTL	Diesel	1686	4	20
10/01→11/11	Combo Mk II 1.7 DTI 16V	Y 17 DT	Diesel	1686	4	20
11/11→	Combo Mk III 1.3 CDTi	A 13 FD Euro 5 (CDTi)	Diesel	1248	4	2
11/11→	Combo Mk III 1.4	843 A1.000	Petrol	1368	4	7
11/11→	Combo Mk III 1.4 CNG	198 A4.000 (Turbo CNG)	Bi-fuel (Petrol/ Gas)	1368	4	6
11/11→	Combo Mk III 2.0 CDTi	A 20 FD Euro 5	Diesel	1956	4	36
09/04→09/06	Combo TOUR Mk II 1.3 CDTI 16V	Y 13 DT	Diesel	1248	4	3
09/04→09/06	Combo TOUR Mk II 1.3 CDTI 16V	Z 13 DT Euro 4	Diesel	1248	4	3
10/05→09/10	Combo TOUR Mk II 1.3 CDTI 16V	Z 13 DTJ	Diesel	1248	4	4
10/04→09/10	Combo TOUR Mk II 1.4	Z 14 XEP	Petrol	1364	4	11
10/01→06/04	Combo TOUR Mk II 1.6	Z 16 SE	Petrol	1598	4	23
12/04→09/10	Combo TOUR Mk II 1.7 CDTI 16V	Z 17 DTH	Diesel	1686	4	20
09/01→06/04	Combo TOUR Mk II 1.7 DI 16V	Y 17 DTL	Diesel	1686	4	20
10/01→02/12	Combo TOUR Mk II 1.7 DTI 16V	Y 17 DT	Diesel	1686	4	20
11/96→09/00	Corsa Mk I 1.0 i 12V	X 10 XE	Petrol	973	3	10
03/93→09/00	Corsa Mk I 1.2 i	C 12 NZ	Petrol	1187	4	8
03/93→09/00	Corsa Mk I 1.2 i	X 12 SZ	Petrol	1195	4	8

MODEL INDEX

Modelverzeichnis • Index de modele • Índice de Modelo
Indeks modelu • Модель автомобиля • دليل الموديل



CCM

x



9

03/98→09/00	Corsa Mk I 1.2 i 16V	X 12 XE	Petrol	1199	4	10
03/93→09/00	Corsa Mk I 1.4 i	C 14 NZ	Petrol	1389	4	14
03/93→09/00	Corsa Mk I 1.4 i	X 14 SZ	Petrol	1389	4	14
08/97→09/00	Corsa Mk I 1.4 i 16V	C 14 SEL	Petrol	1389	4	14
09/94→09/00	Corsa Mk I 1.4 i 16V	X 14 XE	Petrol	1389	4	14
03/93→09/00	Corsa Mk I 1.4 i S	C 14 SE	Petrol	1389	4	14
03/93→09/00	Corsa Mk I 1.5 D	15 D	Diesel	1488	4	13
03/93→10/96	Corsa Mk I 1.5 TD	15 DT (T4EC1)	Diesel	1488	4	13
03/93→10/96	Corsa Mk I 1.5 TD	X 15 DT (T4EC1)	Diesel	1488	4	13
03/93→09/00	Corsa Mk I 1.6 GSI 16V	C 16 XE	Petrol	1598	4	22
09/94→09/00	Corsa Mk I 1.6 i 16V	X 16 XE	Petrol	1598	4	22
02/96→09/00	Corsa Mk I 1.7 D	17 D (4EE1)	Diesel	1686	4	20
02/96→09/00	Corsa Mk I 1.7 D	X 17 D (4EE1)	Diesel	1686	4	20
09/00→10/03	Corsa Mk II 1.0 12V	Z 10 XE	Petrol	973	3	10
11/03→10/06	Corsa Mk II 1.0 12V	Z 10 XEP	Petrol	998	3	11
09/00→10/06	Corsa Mk II 1.2 16V	Z 12 XE	Petrol	1199	4	10
08/01→10/06	Corsa Mk II 1.2 16V Dualfuel	Z 12 XE	Petrol	1199	4	10
07/04→10/06	Corsa Mk II 1.2 Twinport	Z 12 XEP	Petrol	1229	4	11
08/00→09/06	Corsa Mk II 1.3 CDTI 16V	Z 13 DT Euro 4	Diesel	1248	4	3
09/05→09/06	Corsa Mk II 1.3 CDTI 16V	Z 13 DTJ	Diesel	1248	4	4
09/00→10/06	Corsa Mk II 1.4 16V	Z 14 XE	Petrol	1389	4	15
06/03→10/06	Corsa Mk II 1.4 Twinport	Z 14 XEP	Petrol	1364	4	11
08/01→10/04	Corsa Mk II 1.6	Z 16 SE	Petrol	1598	4	23
08/00→09/06	Corsa Mk II 1.7 CDTI 16V	Z 17 DTH	Diesel	1686	4	20
08/00→09/06	Corsa Mk II 1.7 DI 16V	Y 17 DTL	Diesel	1686	4	20
08/00→09/06	Corsa Mk II 1.7 DTI 16V	Y 17 DT	Diesel	1686	4	20
08/00→09/06	Corsa Mk II 1.8 16V	Z 18 XE	Petrol	1799	4	31
11/06→	Corsa Mk III 1.0	Z 10 XEP	Petrol	998	3	11
11/06→	Corsa Mk III 1.2	Z 12 XEP	Petrol	1229	4	11
09/09→	Corsa Mk III 1.2 LPG	Z 12 XEP	Petrol	1229	4	11
11/06→	Corsa Mk III 1.3 CDTI	A 13 DTC Euro 5 (CDTI)	Diesel	1248	4	2
11/06→	Corsa Mk III 1.3 CDTI	A 13 DTR Euro 5	Diesel	1248	4	2
11/06→	Corsa Mk III 1.3 CDTI	Z 13 DTH	Diesel	1248	4	4
11/06→	Corsa Mk III 1.3 CDTI	Z 13 DTJ	Diesel	1248	4	4
07/06→	Corsa Mk III 1.4	Z 14 XEP	Petrol	1364	4	11
07/06→	Corsa Mk III 1.4 LPG	Z 14 XEP	Petrol	1364	4	11
01/94→09/00	Corsavan Mk I 1.4 i	C 14 NZ	Petrol	1389	4	14
08/94→12/95	Corsavan Mk I 1.5 D	15 D	Diesel	1488	4	13
01/94→09/00	Corsavan Mk I 1.7 D	17 D (4EE1)	Diesel	1686	4	20
01/94→09/00	Corsavan Mk I 1.7 D	X 17 D (4EE1)	Diesel	1686	4	20
09/00→06/06	Corsavan Mk II 1.2 16V	Z 12 XE	Petrol	1199	4	10
08/01→06/06	Corsavan Mk II 1.2 16V Dualfuel	Z 12 XE	Petrol	1199	4	10
04/04→06/06	Corsavan Mk II 1.3 CDTI 16V	Z 13 DT Euro 4	Diesel	1248	4	3
11/03→06/06	Corsavan Mk II 1.4	Z 14 XEP	Petrol	1364	4	11
09/00→06/06	Corsavan Mk II 1.7 DI 16V	Y 17 DTL	Diesel	1686	4	20
09/00→06/06	Corsavan Mk II 1.7 DTI 16V	Y 17 DT	Diesel	1686	4	20
07/09→	Corsavan Mk III 1.2	Z 12 XEP	Petrol	1229	4	11
07/06→	Corsavan Mk III 1.3 CDTI	Z 13 DTH	Diesel	1248	4	4
07/06→	Corsavan Mk III 1.3 CDTI	Z 13 DTJ	Diesel	1248	4	4
04/95→08/98	Frontera Mk I 2.0	C 20 NE	Petrol	1998	4	46
04/95→08/98	Frontera Mk I 2.0	X 20 SE	Petrol	1998	4	46
03/92→10/98	Frontera Mk I 2.0 i	C 20 NE	Petrol	1998	4	46
03/92→10/98	Frontera Mk I 2.0 i	X 20 SE	Petrol	1998	4	46
03/95→10/98	Frontera Mk I 2.2 i	X 22 XE	Petrol	2198	4	46
03/92→10/98	Frontera Mk I 2.3 TD	23 DTR	Diesel	2260	4	54
03/92→10/98	Frontera Mk I 2.4 i	C 24 NE	Petrol	2410	4	59
09/96→10/98	Frontera Mk I 2.5 TDS	25TDS (VM41B)	Diesel	2499	4	55
10/98→09/04	Frontera Mk II 2.2 DTI	X 22 DTH	Diesel	2172	4	41
10/98→09/04	Frontera Mk II 2.2 DTI	Y 22 DTH	Diesel	2172	4	41
10/98→10/04	Frontera Mk II 2.2 i	X 22 SE	Petrol	2198	4	46



CCM

x



9

04/11→	Insignia 1.4	A 14 NET Euro 5	Petrol	1364	4	9
07/12→	Insignia 1.4 LPG	A 14 NET Euro 5	Petrol	1364	4	9
01/09→	Insignia 1.6 Turbo	A 16 LET Euro 5	Petrol	1598	4	21
03/12→	Insignia 2.0 Biturbo CDTI	A 20 DTR Euro 5	Diesel	1956	4	36
03/12→	Insignia 2.0 Biturbo CDTI 4x4	A 20 DTR Euro 5	Diesel	1956	4	36
07/08→	Insignia 2.0 CDTI	A 20 DTC Euro 5	Diesel	1956	4	36
07/08→	Insignia 2.0 CDTI	A 20 DTH Euro 5	Diesel	1956	4	36
07/08→	Insignia 2.0 CDTI	A 20 DTJ Euro 5	Diesel	1956	4	36
10/08→	Insignia 2.0 CDTI	A 20 DTR Euro 5	Diesel	1956	4	36
07/08→	Insignia 2.0 CDTI 4x4	A 20 DTH Euro 5	Diesel	1956	4	36
05/09→	Insignia 2.0 CDTI 4x4	A 20 DTR Euro 5	Diesel	1956	4	36
04/11→	Insignia Saloon 1.4	A 14 NET Euro 5	Petrol	1364	4	9
07/12→	Insignia Saloon 1.4 LPG	A 14 NET Euro 5	Petrol	1364	4	9
01/09→	Insignia Saloon 1.6 Turbo	A 16 LET Euro 5	Petrol	1598	4	21
03/12→	Insignia Saloon 2.0 Biturbo CDTI	A 20 DTR Euro 5	Diesel	1956	4	36
03/12→	Insignia Saloon 2.0 Biturbo CDTI 4x4	A 20 DTR Euro 5	Diesel	1956	4	36
07/08→	Insignia Saloon 2.0 CDTI	A 20 DTC Euro 5	Diesel	1956	4	36
07/08→	Insignia Saloon 2.0 CDTI	A 20 DTH Euro 5	Diesel	1956	4	36
07/08→	Insignia Saloon 2.0 CDTI	A 20 DTJ Euro 5	Diesel	1956	4	36
11/08→	Insignia Saloon 2.0 CDTI	A 20 DTR Euro 5	Diesel	1956	4	36
07/08→	Insignia Saloon 2.0 CDTI 4x4	A 20 DTH Euro 5	Diesel	1956	4	36
05/09→	Insignia Saloon 2.0 CDTI 4x4	A 20 DTR Euro 5	Diesel	1956	4	36
04/11→	Insignia Sports Tourer 1.4	A 14 NET Euro 5	Petrol	1364	4	9
07/12→	Insignia Sports Tourer 1.4 LPG	A 14 NET Euro 5	Petrol	1364	4	9
01/09→	Insignia Sports Tourer 1.6 Turbo	A 16 LET Euro 5	Petrol	1598	4	21
03/12→	Insignia Sports Tourer 2.0 Biturbo CDTI	A 20 DTR Euro 5	Diesel	1956	4	36
03/12→	Insignia Sports Tourer 2.0 Biturbo CDTI 4x4	A 20 DTR Euro 5	Diesel	1956	4	36
07/08→	Insignia Sports Tourer 2.0 CDTI	A 20 DTC Euro 5	Diesel	1956	4	36
07/08→	Insignia Sports Tourer 2.0 CDTI	A 20 DTH Euro 5	Diesel	1956	4	36
07/08→	Insignia Sports Tourer 2.0 CDTI	A 20 DTJ Euro 5	Diesel	1956	4	36
11/08→	Insignia Sports Tourer 2.0 CDTI	A 20 DTR Euro 5	Diesel	1956	4	36
07/08→	Insignia Sports Tourer 2.0 CDTI 4x4	A 20 DTH Euro 5	Diesel	1956	4	36
05/09→	Insignia Sports Tourer 2.0 CDTI 4x4	A 20 DTR Euro 5	Diesel	1956	4	36
04/05→06/10	Meriva Mk I 1.3 CDTI	Y 13 DT	Diesel	1248	4	3
04/05→06/10	Meriva Mk I 1.3 CDTI	Z 13 DT Euro 4	Diesel	1248	4	3
01/03→10/09	Meriva Mk I 1.3 CDTI	Z 13 DTJ	Diesel	1248	4	4
01/03→10/09	Meriva Mk I 1.4 16V Twinport	Z 14 XEP	Petrol	1364	4	11
01/03→10/09	Meriva Mk I 1.6 i	Z 16 SE	Petrol	1598	4	23
01/03→10/09	Meriva Mk I 1.6 i 16V	Z 16 XE	Petrol	1598	4	23
01/03→10/09	Meriva Mk I 1.6 i 16V Twinport	Z 16 XEP	Petrol	1598	4	24
09/03→08/05	Meriva Mk I 1.7 CDTI 16V	Z 17 DTH	Diesel	1686	4	20
06/03→06/10	Meriva Mk I 1.7 DTI 16V	Y 17 DT	Diesel	1686	4	20
05/03→08/05	Meriva Mk I 1.8 i 16V	Z 18 XE	Petrol	1799	4	31
06/10→	Meriva Mk II 1.3 CDTI	A 13 DTC Euro 5 (CDTI)	Diesel	1248	4	2
06/10→	Meriva Mk II 1.4	A 14 NET Euro 5	Petrol	1364	4	9
06/12→	Mokka 1.4 4x4	A 14 NET Euro 5	Petrol	1364	4	9
09/00→05/10	Movano Mk I 2.2 DTI	G9T 720	Diesel	2188	4	47
09/00→05/10	Movano Mk I 2.2 DTI	G9T 722	Diesel	2188	4	47
09/00→05/10	Movano Mk I 2.2 DTI	G9T 750	Diesel	2188	4	47
10/01→05/10	Movano Mk I 2.5 CDTI	G9U 754 Euro 3	Diesel	2463	4	52
10/01→05/10	Movano Mk I 2.5 DTI	G9U 720 Euro 3	Diesel	2463	4	52
10/01→05/10	Movano Mk I 2.5 DTI	G9U 724 Euro 3	Diesel	2463	4	52
10/01→05/10	Movano Mk I 2.5 DTI	G9U 750 Euro 3	Diesel	2463	4	52
10/01→05/10	Movano Mk I 2.5 DTI	G9U 754 Euro 3	Diesel	2463	4	52
	Movano Mk I 2.8 DTI	S9W 700	Diesel	2799	4	57
10/98→10/01	Movano Mk I 2.8 DTI	S9W 702	Diesel	2799	4	57
	Movano Mk I 2.8 TDI	S9W 700	Diesel	2799	4	57
10/98→10/01	Movano Mk I 2.8 TDI	S9W 702	Diesel	2799	4	57
05/10→	Movano Mk II 2.3 CDTI	M9T 670 Euro 5	Diesel	2298	4	45
05/10→	Movano Mk II 2.3 CDTI	M9T 672 Euro 5	Diesel	2298	4	45

MODEL INDEX

Modelverzeichnis • Index de modele • Índice de Modelo
 Indeks modelu • Модель автомобиля • دليل الموديل

CCM
x

9

05/10→	Movano Mk II 2.3 CDTI	M9T 676 Euro 4	Diesel	2298	4	45
05/10→	Movano Mk II 2.3 CDTI	M9T 678	Diesel	2298	4	45
05/10→	Movano Mk II 2.3 CDTI	M9T 680	Diesel	2298	4	45
05/10→	Movano Mk II 2.3 CDTI [RWD]	M9T 686 Euro 5	Diesel	2298	4	45
05/10→	Movano Mk II 2.3 CDTI [RWD]	M9T 690 Euro 5	Diesel	2298	4	45
05/10→	Movano Mk II 2.3 CDTI [RWD]	M9T 692 Euro 4	Diesel	2298	4	45
05/10→	Movano Mk II 2.3 CDTI [RWD]	M9T 694 Euro 4	Diesel	2298	4	45
05/10→	Movano Mk II 2.3 CDTI [RWD]	M9T 696 Euro 4	Diesel	2298	4	45
05/10→	Movano Mk II 2.3 CDTI [RWD]	M9T 698 Euro 5	Diesel	2298	4	45
05/10→	Movano Mk II 2.3 CDTI FWD	M9T 670 Euro 5	Diesel	2298	4	45
05/10→	Movano Mk II 2.3 CDTI FWD	M9T 672 Euro 5	Diesel	2298	4	45
05/10→	Movano Mk II 2.3 CDTI FWD	M9T 676 Euro 4	Diesel	2298	4	45
05/10→	Movano Mk II 2.3 CDTI FWD	M9T 678	Diesel	2298	4	45
05/10→	Movano Mk II 2.3 CDTI FWD	M9T 680	Diesel	2298	4	45
05/10→	Movano Mk II 2.3 CDTI FWD	M9T 694 Euro 4	Diesel	2298	4	45
09/82→10/87	Nova 1.0	10 S/N	Petrol	993	4	5
01/85→12/86	Nova 1.2	12 N	Petrol	1196	4	18
01/85→10/87	Nova 1.2 N	12 NC	Petrol	1196	4	18
01/85→10/87	Nova 1.2 N	E 12 GV	Petrol	1196	4	18
09/82→10/87	Nova 1.2 S	12 ST	Petrol	1196	4	17
09/85→10/87	Nova 1.3 i	13 NB	Petrol	1297	4	12
09/82→10/87	Nova 1.3 S	13 SB	Petrol	1297	4	12
10/90→08/92	Nova 1.4	C 14 NZ	Petrol	1389	4	14
09/90→08/92	Nova 1.4	C 14 SE	Petrol	1389	4	14
01/90→02/93	Nova 1.4 S	14 NV	Petrol	1389	4	14
09/87→02/93	Nova 1.5 D	15 D	Diesel	1488	4	13
01/90→02/93	Nova 1.5 TD	15 DT (T4EC1)	Diesel	1488	4	13
05/83→03/93	Nova Hatchback 1.0	10 S/N	Petrol	993	4	5
01/85→10/89	Nova Hatchback 1.2 i	12 NC	Petrol	1196	4	18
01/85→10/89	Nova Hatchback 1.2 i	E 12 GV	Petrol	1196	4	18
09/89→03/93	Nova Hatchback 1.2 i CAT	C 12 NZ	Petrol	1187	4	8
01/90→03/93	Nova Hatchback 1.2 N	12 NV	Petrol	1196	4	16
01/88→02/90	Nova Hatchback 1.2 S	12 S	Petrol	1196	4	18
05/83→02/90	Nova Hatchback 1.2 S	12 ST	Petrol	1196	4	17
09/85→10/89	Nova Hatchback 1.3 i	13 NB	Petrol	1297	4	12
09/89→03/93	Nova Hatchback 1.3 i CAT	C 13 N	Petrol	1297	4	12
05/83→10/89	Nova Hatchback 1.3 S	13 SB	Petrol	1297	4	12
01/90→03/93	Nova Hatchback 1.4 i	C 14 NZ	Petrol	1389	4	14
09/91→03/93	Nova Hatchback 1.4 i S	C 14 SE	Petrol	1389	4	14
01/90→03/93	Nova Hatchback 1.4 S	14 NV	Petrol	1389	4	14
09/87→03/93	Nova Hatchback 1.5 D	15 D	Diesel	1488	4	13
01/90→03/93	Nova Hatchback 1.5 TD	15 DT (T4EC1)	Diesel	1488	4	13
09/88→08/90	Nova Hatchback 1.6	E 16 SE	Petrol	1598	4	19
05/88→03/92	Nova Hatchback 1.6 GSI	E 16 SE	Petrol	1598	4	19
02/92→03/93	Nova Hatchback 1.6 GSI CAT	C 16 SE	Petrol	1598	4	19
01/90→10/94	Novavan 1.2	12 NV	Petrol	1196	4	16
11/90→03/93	Novavan 1.4	14 NV	Petrol	1389	4	14
01/91→10/94	Novavan 1.5 D	15 D	Diesel	1488	4	13
09/95→09/96	Omega 2.0	20 SE	Petrol	1998	4	46
03/94→09/99	Omega 2.0	X 20 SE	Petrol	1998	4	46
03/94→02/01	Omega 2.0 16V	X 20 XEV	Petrol	1998	4	46
01/98→09/00	Omega 2.0 DTI 16V	X 20 DTH	Diesel	1995	4	39
08/00→07/03	Omega 2.2 DTI 16V	Y 22 DTH	Diesel	2172	4	41
01/94→	Omega 2.5 TD	U 25TD	Diesel	2498	6	30
04/94→07/01	Omega 2.5 TD	X 25 DT	Diesel	2497	6	30
05/94→	Omega 2.5 TD	X 25 TD	Diesel	2498	6	30
03/94→09/00	Omega 2.5 V6	X 25 XE	Petrol	2498	V6	32
08/00→07/03	Omega 2.6 V6	Y 26 SE	Petrol	2597	V6	37
04/94→07/00	Omega 3.0 V6	X 30 XE	Petrol	2962	V6	46
02/01→07/03	Omega 3.2 V6	Y 32 SE	Petrol	3175	V6	48



CCM

x



01/90→	Rascal	F 10 A	Petrol	970	4	1
04/78→07/82	Royale 2.9	30 H	Petrol	2969	6	58
09/85→08/87	Royale 2.9	C 30 LE	Petrol	2969	6	58
02/78→12/86	Royale 2.9 E	30 E	Petrol	2969	6	58
10/79→10/82	Royale 3.0	30 E	Petrol	2969	6	58
01/80→12/83	Royale 3.0 Coupe	30 S	Petrol	2969	6	58
02/78→08/86	Royale Coupe 2.9	30 E	Petrol	2969	6	58
10/79→10/82	Royale Coupe 3.0	30 E	Petrol	2969	6	58
04/78→07/82	Senator 3.0	30 H	Petrol	2969	6	58
09/85→08/87	Senator 3.0	C 30 LE	Petrol	2969	6	58
09/84→12/86	Senator 3.0 i	30 E	Petrol	2969	6	58
09/90→09/93	Senator Mk II 2.6 i	C 26 NE	Petrol	2594	6	50
09/87→09/90	Senator Mk II 3.0	30 NE	Petrol	2969	6	58
09/87→09/93	Senator Mk II 3.0	C 30 LE	Petrol	2969	6	58
09/89→09/93	Senator Mk II 3.0 24V	C 30 SE	Petrol	2969	6	59
01/88→09/93	Senator Mk II 3.0 i CAT	C 30 NE	Petrol	2969	6	58
06/03→07/05	Signum 1.8	Z 18 XE	Petrol	1799	4	31
08/05→05/08	Signum 1.8	Z 18 XER	Petrol	1796	4	31
04/04→03/08	Signum 1.9 CDTI	Z 19 DT	Diesel	1910	4	33
04/04→03/08	Signum 1.9 CDTI 16V	Z 19 DTH	Diesel	1910	4	34
01/05→05/08	Signum 1.9 Turbo	Z 19 DTL Euro 4	Diesel	1910	4	33
05/03→05/08	Signum 2.0 DTI	Y 20 DTH	Diesel	1995	4	41
05/03→05/08	Signum 2.2 DTI	Y 22 DTR	Diesel	2172	4	41
07/97→04/99	Sintra 2.2 DTI	X 22 DTH	Diesel	2172	4	41
11/96→04/99	Sintra 2.2 i 16 V	X 22 XE	Petrol	2198	4	46
11/96→04/99	Sintra 3.0 i 24V	X 30 XE	Petrol	2962	V6	46
07/94→12/00	Tigra Mk I 1.4 16V	X 14 XE	Petrol	1389	4	14
07/94→12/00	Tigra Mk I 1.6 16V	X 16 XE	Petrol	1598	4	22
06/04→08/09	Tigra TwinTop 1.3 CDTI	Z 13 DT Euro 4	Diesel	1248	4	3
06/04→08/09	Tigra TwinTop 1.4	Z 14 XEP	Petrol	1364	4	11
06/04→08/09	Tigra TwinTop 1.8	Z 18 XE	Petrol	1799	4	31
08/95→03/02	Vectra 1.6 i	X 16 SZR	Petrol	1598	4	19
08/95→03/02	Vectra 1.6 i 16V	X 16 XEL	Petrol	1598	4	22
08/95→03/02	Vectra 1.6 i 16V	Y 16 XE	Petrol	1598	4	23
08/95→03/02	Vectra 1.6 i 16V	Z 16 XE	Petrol	1598	4	23
10/95→12/97	Vectra 1.7 TD	X 17 DT (TC4EE1)	Diesel	1686	4	20
10/95→09/00	Vectra 1.8 i 16V	X 18 XE	Petrol	1796	4	32
10/95→09/00	Vectra 1.8 i 16V	X 18 XE1	Petrol	1796	4	31
09/00→07/03	Vectra 1.8 i 16V	Z 18 XE	Petrol	1799	4	31
08/95→10/01	Vectra 2.0 DI 16V	X 20 DTL	Diesel	1995	4	40
08/95→10/01	Vectra 2.0 DTI 16V	X 20 DTH	Diesel	1995	4	39
08/95→10/01	Vectra 2.0 DTI 16V	Y 20 DTH	Diesel	1995	4	41
10/95→01/01	Vectra 2.0 i 16V	X 20 XEV	Petrol	1998	4	46
08/95→10/01	Vectra 2.2 DTI 16V	Y 22 DTR	Diesel	2172	4	41
10/99→09/02	Vectra 2.2i 16V	C 22 SEL	Petrol	2198	4	46
03/98→07/00	Vectra 2.5 i GS i	X 25 XE	Petrol	2498	V6	32
09/95→08/00	Vectra 2.5 i V6	X 25 XE	Petrol	2498	V6	32
09/00→07/03	Vectra 2.6 i V6	Y 26 SE	Petrol	2597	V6	37
01/06→07/08	Vectra Mk II 1.6	Z 16 XEP	Petrol	1598	4	24
06/04→07/08	Vectra Mk II 1.6 16V	Z 16 XE	Petrol	1598	4	23
04/02→07/08	Vectra Mk II 1.8	Z 18 XEL	Petrol	1796	4	31
01/06→07/08	Vectra Mk II 1.8	Z 18 XER	Petrol	1796	4	31
04/02→07/08	Vectra Mk II 1.8 16V	Z 18 XE	Petrol	1799	4	31
04/02→07/08	Vectra Mk II 1.8 16V Dualfuel	Z 18 XE	Petrol	1799	4	31
04/02→09/08	Vectra Mk II 1.9 CDTI	Z 19 DT	Diesel	1910	4	33
10/05→07/08	Vectra Mk II 1.9 CDTI	Z 19 DTL Euro 4	Diesel	1910	4	33
04/04→08/08	Vectra Mk II 1.9 CDTI 16V	Z 19 DTH	Diesel	1910	4	34
04/02→10/08	Vectra Mk II 2.0 DTI 16V	Y 20 DTH	Diesel	1995	4	41
04/02→10/08	Vectra Mk II 2.2 DTI 16V	Y 22 DTR	Diesel	2172	4	41
08/01→12/06	Vivaro Box 1.9 DTI	F9Q 760	Diesel	1870	4	29

MODEL INDEX

Modelverzeichnis • Index de modele • Índice de Modelo
Indeks modelu • Модель автомобиля • دليل الموديل



CCM

x



9

01/06→	Vivaro Box 2.0 CDTI	M9R 630	Diesel	1995	4	38
01/06→	Vivaro Box 2.0 CDTI	M9R 780 Euro 4	Diesel	1995	4	38
01/06→	Vivaro Box 2.0 CDTI	M9R 782	Diesel	1995	4	38
01/06→	Vivaro Box 2.0 CDTI	M9R 786 Euro 4	Diesel	1995	4	38
08/06→	Vivaro Box 2.0 CDTI	M9R 788	Diesel	1995	4	38
08/06→	Vivaro Box 2.5 CDTI	G9U 630 Euro 4	Diesel	2464	4	51
04/04→	Vivaro Box 2.5 DTI	G9U 630 Euro 4	Diesel	2464	4	51
04/04→	Vivaro Box 2.5 DTI	G9U 730 Euro 3	Diesel	2463	4	52
08/01→12/06	Vivaro Combi 1.9 DTI	F9Q 760	Diesel	1870	4	29
01/06→	Vivaro Combi 2.0 CDTI	M9R 630	Diesel	1995	4	38
01/06→	Vivaro Combi 2.0 CDTI	M9R 780 Euro 4	Diesel	1995	4	38
01/06→	Vivaro Combi 2.0 CDTI	M9R 782	Diesel	1995	4	38
08/06→	Vivaro Combi 2.0 CDTI	M9R 784	Diesel	1995	4	38
01/06→	Vivaro Combi 2.0 CDTI	M9R 786 Euro 4	Diesel	1995	4	38
08/06→	Vivaro Combi 2.0 CDTI	M9R 788	Diesel	1995	4	38
01/06→	Vivaro Combi 2.5 CDTI	G9U 630 Euro 4	Diesel	2464	4	51
04/04→	Vivaro Combi 2.5 DTI	G9U 630 Euro 4	Diesel	2464	4	51
04/04→	Vivaro Combi 2.5 DTI	G9U 730 Euro 3	Diesel	2463	4	52
01/06→	Vivaro Platform/Chassis 2.0 CDTI	M9R 630	Diesel	1995	4	38
01/06→	Vivaro Platform/Chassis 2.0 CDTI	M9R 782	Diesel	1995	4	38
08/06→	Vivaro Platform/Chassis 2.0 CDTI	M9R 788	Diesel	1995	4	38
08/06→	Vivaro Platform/Chassis 2.0 CDTI	M9R 780 Euro 4	Diesel	1995	4	38
04/03→	Vivaro Platform/Chassis 2.5 CDTI	G9U 630 Euro 4	Diesel	2464	4	51
04/03→	Vivaro Platform/Chassis 2.5 CDTI	G9U 730 Euro 3	Diesel	2463	4	52
04/99→08/05	Zafira Mk I 1.6 16V	X 16 XEL	Petrol	1598	4	22
04/99→08/05	Zafira Mk I 1.6 16V	Z 16 XE	Petrol	1598	4	23
11/98→08/05	Zafira Mk I 1.6 Dualfuel	X 16 XEL	Petrol	1598	4	22
11/98→08/05	Zafira Mk I 1.6 Dualfuel	Z 16 XE	Petrol	1598	4	23
05/99→08/00	Zafira Mk I 1.8 16V	X 18 XE1	Petrol	1796	4	31
09/00→08/05	Zafira Mk I 1.8 16V	Z 18 XE	Petrol	1799	4	31
09/00→08/05	Zafira Mk I 1.8 Dualfuel	Z 18 XE	Petrol	1799	4	31
10/99→08/05	Zafira Mk I 2.0 DI 16V	X 20 DTL	Diesel	1995	4	40
04/99→08/05	Zafira Mk I 2.0 DTI 16V	Y 20 DTH	Diesel	1995	4	41
06/01→06/05	Zafira Mk I 2.2 D	Y 22 DTR	Diesel	2172	4	41
07/05→	Zafira Mk II 1.6	Z 16 XEP	Petrol	1598	4	24
12/07→	Zafira Mk II 1.6	Z 16 XER	Petrol	1598	4	25
04/05→	Zafira Mk II 1.8	Z 18 XER	Petrol	1796	4	31
07/05→	Zafira Mk II 1.9 CDTI	Z 19 DT	Diesel	1910	4	33
07/05→	Zafira Mk II 1.9 CDTI	Z 19 DTH	Diesel	1910	4	34
07/05→	Zafira Mk II 1.9 CDTI	Z 19 DTL Euro 4	Diesel	1910	4	33
10/11→	Zafira Mk III 1.4	A 14 NET Euro 5	Petrol	1364	4	9
10/11→	Zafira Mk III 1.4 LPG	A 14 NET Euro 5	Petrol	1364	4	9
01/13→	Zafira Mk III 2.0 BiTurbo CDTI	A 20 DTR Euro 5	Diesel	1956	4	36
10/11→	Zafira Mk III 2.0 CDTi	A 20 DT Euro 5	Diesel	1956	4	36
10/11→	Zafira Mk III 2.0 CDTI	A 20 DTE Euro 5	Diesel	1956	4	36
10/11→	Zafira Mk III 2.0 CDTi	A 20 DTH Euro 5	Diesel	1956	4	36
10/11→	Zafira Mk III 2.0 CDTi	A 20 DTL Euro 5	Diesel	1956	4	36
10/11→	Zafira Mk III 2.0 CDTi	Y 20 DTJ	Diesel	1956	4	36
10/11→	Zafira Mk III 2.0 CDTi	Z 20 DTJ	Diesel	1956	4	36

Motorverzeichnis • Index de moteur • Índice de Motor
Indeks silnika • Модель двигателя • دليل المحرك

ENGINE INDEX



CCM

x



9

10 S/N	Petrol	993	4	72.00	5
12 N	Petrol	1196	4	79.00	18
12 NC	Petrol	1196	4	79.00	18
12 NV	Petrol	1196	4	77.80	16
12 S	Petrol	1196	4	79.00	18
12 SC	Petrol	1196	4	79.00	18
12 ST	Petrol	1196	4	77.80	17
13 N	Petrol	1297	4	75.00	12
13 NB	Petrol	1297	4	75.00	12
13 S	Petrol	1297	4	75.00	12
13 SB	Petrol	1297	4	75.00	12
14 NV	Petrol	1389	4	77.60	14
15 D	Diesel	1488	4	76.00	13
15 DT (T4EC1)	Diesel	1488	4	76.00	13
16 D	Diesel	1598	4	80.00	26
16 DA	Diesel	1598	4	80.00	26
16 N	Petrol	1584	4	85.00	44
16 N	Petrol	1598	4	80.00	27
16 S	Petrol	1598	4	85.00	44
16 SH	Petrol	1598	4	80.00	27
16 SV	Petrol	1598	4	79.00	19
17 D	Diesel	1699	4	82.50	35
17 D (4EE1)	Diesel	1686	4	79.00	20
17 DR	Diesel	1699	4	82.50	35
17 DT (TC4EE1)	Diesel	1686	4	79.00	20
18 E	Petrol	1796	4	84.80	42
18 NV	Petrol	1796	4	84.80	43
18 S	Petrol	1796	4	84.80	42
18 SE	Petrol	1796	4	84.80	42
18 SEH	Petrol	1796	4	84.80	42
18 SV	Petrol	1796	4	84.80	42
20 E	Petrol	1979	4	95.00	58
20 NE	Petrol	1998	4	86.00	46
20 S	Petrol	1979	4	95.00	58
20 SE	Petrol	1998	4	86.00	46
20 SEH	Petrol	1998	4	86.00	46
20 XE	Petrol	1998	4	86.00	46
23 D	Diesel	2260	4	92.00	53
23 DTR	Diesel	2260	4	92.00	54
23 YDT	Diesel	2260	4	92.00	54
25TDS (VM41B)	Diesel	2499	4	92.00	55
30 E	Petrol	2969	6	95.00	58
30 H	Petrol	2969	6	95.00	58
30 NE	Petrol	2969	6	95.00	58
30 S	Petrol	2969	6	95.00	58
198 A4.000 (Turbo CNG)	Bi-fuel (Petrol/ Gas)	1368	4	72.00	6
843 A1.000	Petrol	1368	4	72.00	7
A 13 DTC Euro 5 (CDTI)	Diesel	1248	4	69.60	2
A 13 DTR Euro 5	Diesel	1248	4	69.60	2
A 13 FD Euro 5 (CDTI)	Diesel	1248	4	69.60	2
A 14 FC Euro 5	Bi-fuel (Petrol/ Gas)	1364	4	72.00	6
A 14 NET Euro 5	Petrol	1364	4	72.50	9
A 16 LET Euro 5	Petrol	1598	4	79.00	21
A 20 DT Euro 5	Diesel	1956	4	83.00	36
A 20 DTC Euro 5	Diesel	1956	4	83.00	36
A 20 DTE Euro 5	Diesel	1956	4	83.00	36

ENGINE INDEX

Motorverzeichnis • Index de moteur • Índice de Motor
 Indeks silnika • Модель двигателя • دليل المحرك

CCM

9

A 20 DTH Euro 5	Diesel	1956	4	83.00	36
A 20 DTJ Euro 5	Diesel	1956	4	83.00	36
A 20 DTL Euro 5	Diesel	1956	4	83.00	36
A 20 DTR Euro 5	Diesel	1956	4	83.00	36
A 20 FD Euro 5	Diesel	1956	4	83.00	36
C 12 NZ	Petrol	1187	4	72.00	8
C 13 N	Petrol	1297	4	75.00	12
C 14 NZ	Petrol	1389	4	77.60	14
C 14 SE	Petrol	1389	4	77.60	14
C 14 SEL	Petrol	1389	4	77.60	14
C 16 LZ	Petrol	1598	4	79.00	19
C 16 NZ	Petrol	1598	4	79.00	19
C 16 SE	Petrol	1598	4	79.00	19
C 16 XE	Petrol	1598	4	79.00	22
C 18 NE	Petrol	1796	4	84.80	42
C 18 NZ	Petrol	1796	4	84.80	42
C 18 XE	Petrol	1796	4	81.60	32
C 18 XEL	Petrol	1796	4	81.60	32
C 20 LET	Petrol	1998	4	86.00	46
C 20 NE	Petrol	1998	4	86.00	46
C 20 XE	Petrol	1998	4	86.00	46
C 22 SEL	Petrol	2198	4	86.00	46
C 24 NE	Petrol	2410	4	95.00	59
C 25 XE	Petrol	2498	V6	81.60	32
C 26 NE	Petrol	2594	6	88.80	50
C 30 LE	Petrol	2969	6	95.00	58
C 30 NE	Petrol	2969	6	95.00	58
C 30 SE	Petrol	2969	6	95.00	59
C 30 SEJ	Petrol	2969	6	95.00	59
C 223	Diesel	2238	4	88.00	49
E 12 GV	Petrol	1196	4	79.00	18
E 16 NZ	Petrol	1598	4	79.00	19
E 16 SE	Petrol	1598	4	79.00	19
E 18 NV	Petrol	1796	4	84.80	43
E 18 NVR	Petrol	1796	4	84.80	43
F 10 A	Petrol	970	4	65.50	1
F8Q 600	Diesel	1870	4	80.00	28
F8Q 606	Diesel	1870	4	80.00	28
F9Q 760	Diesel	1870	4	80.00	29
G9T 720	Diesel	2188	4	87.00	47
G9T 722	Diesel	2188	4	87.00	47
G9T 750	Diesel	2188	4	87.00	47
G9U 630 Euro 4	Diesel	2464	4	89.00	51
G9U 720 Euro 3	Diesel	2463	4	89.00	52
G9U 724 Euro 3	Diesel	2463	4	89.00	52
G9U 730 Euro 3	Diesel	2463	4	89.00	52
G9U 750 Euro 3	Diesel	2463	4	89.00	52
G9U 754 Euro 3	Diesel	2463	4	89.00	52
M9R 630	Diesel	1995	4	84.00	38
M9R 780 Euro 4	Diesel	1995	4	84.00	38
M9R 782	Diesel	1995	4	84.00	38
M9R 784	Diesel	1995	4	84.00	38
M9R 786 Euro 4	Diesel	1995	4	84.00	38
M9R 788	Diesel	1995	4	84.00	38
M9T 670 Euro 5	Diesel	2298	4	85.00	45
M9T 672 Euro 5	Diesel	2298	4	85.00	45
M9T 676 Euro 4	Diesel	2298	4	85.00	45
M9T 678	Diesel	2298	4	85.00	45
M9T 680	Diesel	2298	4	85.00	45
M9T 686 Euro 5	Diesel	2298	4	85.00	45

Motorverzeichnis • Index de moteur • Índice de Motor
Indeks silnika • Модель двигателя • دليل المحرك

ENGINE INDEX



CCM

x



9

M9T 690 Euro 5	Diesel	2298	4	85.00	45
M9T 692 Euro 4	Diesel	2298	4	85.00	45
M9T 694 Euro 4	Diesel	2298	4	85.00	45
M9T 696 Euro 4	Diesel	2298	4	85.00	45
M9T 698 Euro 5	Diesel	2298	4	85.00	45
S 18 NV	Petrol	1796	4	84.80	43
S8U 758	Diesel	2499	4	93.00	56
S8U 780	Diesel	2499	4	93.00	56
S8U 782	Diesel	2499	4	93.00	56
S9W 700	Diesel	2799	4	94.40	57
S9W 702	Diesel	2799	4	94.40	57
U 25TD	Diesel	2498	6	80.00	30
X 10 XE	Petrol	973	3	72.50	10
X 12 SZ	Petrol	1195	4	72.00	8
X 12 XE	Petrol	1199	4	72.50	10
X 14 SZ	Petrol	1389	4	77.60	14
X 14 XE	Petrol	1389	4	77.60	14
X 15 DT (T4EC1)	Diesel	1488	4	76.00	13
X 16 SZ	Petrol	1598	4	79.00	19
X 16 SZR	Petrol	1598	4	79.00	19
X 16 XE	Petrol	1598	4	79.00	22
X 16 XEL	Petrol	1598	4	79.00	22
X 17 D (4EE1)	Diesel	1686	4	79.00	20
X 17 DT (TC4EE1)	Diesel	1686	4	79.00	20
X 17 DTL	Diesel	1699	4	82.50	35
X 18 XE	Petrol	1796	4	81.60	32
X 18 XE1	Petrol	1796	4	80.50	31
X 20 DTH	Diesel	1995	4	84.00	39
X 20 DTL	Diesel	1995	4	84.00	40
X 20 SE	Petrol	1998	4	86.00	46
X 20 XEV	Petrol	1998	4	86.00	46
X 22 DTH	Diesel	2172	4	84.00	41
X 22 SE	Petrol	2198	4	86.00	46
X 22 XE	Petrol	2198	4	86.00	46
X 25 DT	Diesel	2497	6	80.00	30
X 25 TD	Diesel	2498	6	80.00	30
X 25 XE	Petrol	2498	V6	81.60	32
X 30 XE	Petrol	2962	V6	86.00	46
Y 13 DT	Diesel	1248	4	69.60	3
Y 16 XE	Petrol	1598	4	79.00	23
Y 17 DT	Diesel	1686	4	79.00	20
Y 17 DTL	Diesel	1686	4	79.00	20
Y 20 DTH	Diesel	1995	4	84.00	41
Y 20 DTJ	Diesel	1956	4	83.00	36
Y 20 DTL	Diesel	1995	4	84.00	40
Y 22 DTH	Diesel	2172	4	84.00	41
Y 22 DTR	Diesel	2172	4	84.00	41
Y 26 SE	Petrol	2597	V6	83.20	37
Y 32 SE	Petrol	3175	V6	87.50	48
Z 10 XE	Petrol	973	3	72.50	10
Z 10 XEP	Petrol	998	3	73.40	11
Z 12 XE	Petrol	1199	4	72.50	10
Z 12 XEP	Petrol	1229	4	73.40	11
Z 13 DT Euro 4	Diesel	1248	4	69.60	3
Z 13 DTH	Diesel	1248	4	69.60	4
Z 13 DTJ	Diesel	1248	4	69.60	4
Z 14 XE	Petrol	1389	4	77.60	15
Z 14 XEP	Petrol	1364	4	73.40	11
Z 16 SE	Petrol	1598	4	79.00	23
Z 16 XE	Petrol	1598	4	79.00	23

ENGINE INDEX

Motorverzeichnis • Index de moteur • Índice de Motor
Indeks silnika • Модель двигателя • دليل المحرك



CCM

x



9

Z 16 XEP	Petrol	1598	4	79.00	24
Z 16 XER	Petrol	1598	4	79.00	25
Z 17 DTH	Diesel	1686	4	79.00	20
Z 17 DTL	Diesel	1686	4	79.00	20
Z 18 XE	Petrol	1799	4	80.50	31
Z 18 XEL	Petrol	1796	4	80.50	31
Z 18 XER	Petrol	1796	4	80.50	31
Z 19 DT	Diesel	1910	4	82.00	33
Z 19 DTH	Diesel	1910	4	82.00	34
Z 19 DTJ	Diesel	1910	4	82.00	34
Z 19 DTL Euro 4	Diesel	1910	4	82.00	33
Z 20 DTJ	Diesel	1956	4	83.00	36



Rascal		01/90→	F 10 A		4cyl. 970cc	1
						FM3641
08-960200-00	STD	65.50	1.500		001 CR P	IKA
08-960207-00	0.50mm		1.500		026 P	STD
[R41260]			2.800		236 P	STD
Corsa Mk III 1.3 CDTI		11/06→	A 13 DTC Euro 5 (CDTI)		4cyl. 1248cc 55kW (75PS)	2
Meriva Mk II 1.3 CDTI		06/10→			Diesel Turbo Intercooled	TD24745
Corsa Mk III 1.3 CDTI		11/06→	A 13 DTR Euro 5		4cyl. 1248cc 70kW (95PS)	
					Diesel Turbo Direct Injection	TD28000
Combo Mk III 1.3 CDTi		11/11→	A 13 FD Euro 5 (CDTI)		4cyl. 1248cc 66kW (89PS)	
					Diesel Turbo Intercooled	TD26203
08-435700-00	STD	69.60	1.500		001 GDC P	KV4
08-435706-00	0.40mm		1.500		005 P	F12/F14
			2.000		231 LKZ CR P	GOE13
Combo TOUR Mk II 1.3 CDTI 16V		09/04→09/06	Y 13 DT		4cyl. 1248cc 51kW (69PS)	3
Meriva Mk I 1.3 CDTI		04/05→06/10			Diesel Turbo Intercooled	TD23798
Agila Mk I 1.3 CDTI		08/03→03/08	Z 13 DT Euro 4		4cyl. 1248cc 51kW (69PS)	
Combo Mk II 1.3 CDTI 16V		09/04→02/12			Diesel Turbo Intercooled	
Combo TOUR Mk II 1.3 CDTI 16V		09/04→09/06				
Corsa Mk II 1.3 CDTI 16V		08/00→09/06				
Corsavan Mk II 1.3 CDTI 16V		04/04→06/06				
Meriva Mk I 1.3 CDTI		04/05→06/10				
Tigra TwinTop 1.3 CDTI		06/04→08/09				TD18361
08-137600-00	STD	69.60	2.000		001 CK P	KV1
08-137606-00	0.40mm		1.500		023 P	F12/F14
[R66830]			2.000		231 P	F12/F14



Astra Mk V 1.3 CDTi	01/04→11/10	Z 13 DTH						4
Astravan Mk V 1.3 CDTi	08/05→		4cyl.					
Corsa Mk III 1.3 CDTi	11/06→		1248cc	66-74kW (90-101PS)				
Corsavan Mk III 1.3 CDTi	07/06→	Diesel	Turbo Intercooled					TD18654

Agila Mk II 1.3 CDTi	01/08→	Z 13 DTJ						
Combo Mk II 1.3 CDTi 16V	10/05→11/11		4cyl.					
Combo TOUR Mk II 1.3 CDTi 16V	10/05→09/10		1248cc	55kW (75PS)				
Corsa Mk II 1.3 CDTi 16V	09/05→09/06	Diesel	Turbo Intercooled					
Corsa Mk III 1.3 CDTi	11/06→							
Corsavan Mk III 1.3 CDTi	07/06→							
Meriva Mk I 1.3 CDTi	01/03→10/09							TD19348

08-425600-00	STD	69.60	2.000		001 CK P		KV4
08-425606-00	0.40mm				005 NT		F12/F14
08-425608-00	0.60mm		1.500		231 CR P		GOE13
			2.000				

Nova 1.0	09/82→10/87	10 S/N						5
Nova Hatchback 1.0	05/83→03/93		4cyl.					
			993cc	29-37kW (39-50PS)				TD17551

08-302200-00	STD	72.00	2.000		001 IF CR P		STD
08-302207-00	0.50mm				026 P		STD
[R40240]			2.000		236 P		STD
			5.000				

Combo Mk III 1.4 CNG	11/11→	198 A4.000 (Turbo CNG)						6
			4cyl.					
			1368cc	88kW (120PS)				TD26414
			Turbo Intercooled					

Combo D 1.4 CNG Turbo EcoFlex	01/12→	A 14 FC Euro 5						
			4cyl.					
			1364cc	88kW (120PS)				TD26199
			Turbo Intercooled					

08-438300-00	STD	72.00	1.200		021 GDC P		KV1
08-438306-00	0.40mm				026 P		GOE13
			1.200		231 LKZ CR P		GOE13
			2.000				

Combo Mk III 1.4	11/11→	843 A1.000						7
			4cyl.					
			1368cc	70kW (95PS)				TD26415

08-433200-00	STD	72.00	1.000		001 IF NT		ST
08-433206-00	0.40mm				005 IF P		GOE13
			1.200		231 P		GOE13
			2.000				



Combo Mk I 1.2	07/94→10/01	C 12 NZ								8
Corsa Mk I 1.2 i	03/93→09/00		4cyl.							
Nova Hatchback 1.2 i CAT	09/89→03/93		1187cc	33kW (45PS)						
TD17553										

Combo Mk I 1.2	07/94→10/01	X 12 SZ								
Corsa Mk I 1.2 i	03/93→09/00		4cyl.							
			1195cc	33kW (45PS)						
TD17552										

08-307500-00	STD	72.00	1.500		001 CR P			IKA
08-307507-00	0.50mm		1.500		026 P			STD
[R49590]			3.000		712 CR			ST

Astra GTC Mk VI 1.4	10/11→	A 14 NET Euro 5								9
Astra Mk VI 1.4 Turbo	12/09→		4cyl.							
Cascade Convertible 1.4	02/13→		1364cc	103kW (140PS)						
Insignia 1.4	04/11→		Turbo Intercooled							
Insignia 1.4 LPG	07/12→									
Insignia Saloon 1.4	04/11→									
Insignia Saloon 1.4 LPG	07/12→									
Insignia Sports Tourer 1.4	04/11→									
Insignia Sports Tourer 1.4 LPG	07/12→									
Meriva Mk II 1.4	06/10→									
Mokka 1.4 4x4	06/12→									
Zafira Mk III 1.4, Zafira Mk III 1.4 LPG	10/11→									TD24731

08-437400-00	STD	72.50	1.200		001 NT DLC			ST		
			1.200		026 P			GOE13		
			2.000		712 NT			ST		
CARBOGLIDE®										

Corsa Mk I 1.0 i 12V	11/96→09/00	X 10 XE								10
			3cyl.							
			973cc	40kW (54PS)						TD17619

Astra Mk IV 1.2 16V	02/98→09/00	X 12 XE								
Corsa Mk I 1.2 i 16V	03/98→09/00		4cyl.							
			1199cc	48kW (65PS)						TD17620

Agila Mk I 1.0 12V	09/00→08/05	Z 10 XE								
Corsa Mk II 1.0 12V	09/00→10/03		3cyl.							
			973cc	43kW (58PS)						TD17630

Agila Mk I 1.2 16V	09/00→03/08	Z 12 XE								
Astra Mk IV 1.2 16V	09/00→05/05		4cyl.							
Corsa Mk II 1.2 16V	09/00→10/06		1199cc	55kW (75PS)						
Corsa Mk II 1.2 16V Dualfuel	08/01→10/06									
Corsavan Mk II 1.2 16V	09/00→06/06									
Corsavan Mk II 1.2 16V Dualfuel	08/01→06/06									TD17935

08-102700-00	STD	72.50	1.200		001 NT			ST
08-102707-00	0.50mm		1.500		005 P			STD
[R49990]			2.000		712 CR			ST



Agila Mk I 1.0 12V	02/00→11/06	Z 10 XEP				11
Corsa Mk II 1.0 12V	11/03→10/06		3cyl.			
Corsa Mk III 1.0	11/06→		998cc	44kW (60PS)		
TD19349						

Agila Mk I 1.2 16V Twinport	07/04→11/06	Z 12 XEP				
Astra Mk V 1.2	08/05→10/10		4cyl.			
Corsa Mk II 1.2 Twinport	07/04→10/06		1229cc	59kW (80PS)		
Corsa Mk III 1.2	11/06→					
Corsa Mk III 1.2 LPG	09/09→					
Corsavan Mk III 1.2	07/09→					
TD19350						

Astra Mk V 1.4	01/04→05/09	Z 14 XEP				
Astra Mk V 1.4 i 16V	03/05→11/10		4cyl.			
Astravan Mk V 1.4 i	03/05→		1364cc	66kW (89PS)		
Combo Mk II 1.4 i 16V	01/04→11/11					
Combo TOUR Mk II 1.4	10/04→09/10					
Corsa Mk II 1.4 Twinport	06/03→10/06					
Corsa Mk III 1.4, Corsa Mk III 1.4 LPG	07/06→					
Corsavan Mk II 1.4	11/03→06/06					
Meriva Mk I 1.4 16V Twinport	01/03→10/09					
Tigra TwinTop 1.4	06/04→08/09					
TD18228						

08-429500-00	STD	73.40	1.200		001 NT	ST
08-429507-00	0.50mm		1.200		026 P	F12/F14
			2.000		712 CR	ST

Astramax 1.3 N	08/85→12/89	13 N				12
Cavalier 1300	08/77→08/81		4cyl.			
Cavalier Mk II 1.3 N	09/81→08/88		1297cc	39-44kW (53-60PS)		
Chevette 1300	03/75→12/85					
Chevette Estate 1.2	09/76→12/85					
Chevette Hatchback 1300	03/75→12/85					
TD17558						

Astramax 1.3 N	08/85→12/89	13 NB				
Cavalier Mk II Hatchback 1.3	09/81→08/88		4cyl.			
Nova 1.3 i	09/85→10/87		1297cc	44kW (60PS)		
Nova Hatchback 1.3 i	09/85→10/89					
TD17560						

Astra Estate 1.3	08/82→08/84	13 S				
Astra Estate 1.3 S	09/79→08/84		4cyl.			
Astra Hatchback 1.3	09/80→08/84		1297cc	42-55kW (57-75PS)		
Astra Hatchback 1.3 S	09/79→08/84					
Astra Mk II Belmont 1.3	09/85→08/91					
Astra Mk II Estate 1.3,	09/84→08/91					
Astra Mk II Hatchback 1.3						
Astramax 1.3 S	08/85→12/89					
Cavalier Mk II 1.3 S,	09/81→08/88					
Cavalier Mk II Estate 1.3 S,						
Cavalier Mk II Hatchback 1.3 S						
Chevette 1300	03/75→12/85					
Chevette Estate 1300	09/76→12/85					
Chevette Hatchback 1300	03/75→12/85					
TD17561						

Nova 1.3 S	09/82→10/87	13 SB				
Nova Hatchback 1.3 S	05/83→10/89		4cyl.			
			1297cc	51kW (69PS)		
TD17600						





Astra Mk II Belmont 1.3 i CAT		09/85→08/91	C 13 N				
Nova Hatchback 1.3 i CAT		09/89→03/93		4cyl.			
				1297cc	44kW (60PS)		
TD18673							
08-305500-00	STD	75.00	1.750		001 IF CR P		IKA
08-305507-00	0.50mm		2.000		026 P		STD
→eng.M.13N1225588			4.000		712 CR		ST
[R33516]							
08-306300-00	STD	75.00	1.500		001 IF CR P		IKA
08-306307-00	0.50mm		1.500		005 IF P		STD
08-306311-00	1.00mm		4.000		231 CR P		STD
eng.M.13N1225589→							
[R41270]							
Corsa Mk I 1.5 D		03/93→09/00	15 D				
Corsavan Mk I 1.5 D		08/94→12/95		4cyl.			
Nova 1.5 D		09/87→02/93		1488cc	37kW (50PS)		
Nova Hatchback 1.5 D		09/87→03/93	Diesel				
Novavan 1.5 D		01/91→10/94					TD21906
13							
Astra Mk II Belmont 1.5 DT		01/88→08/90	15 DT (T4EC1)				
Astra Mk II Estate 1.5 DT		01/88→08/91		4cyl.			
Corsa Mk I 1.5 TD		03/93→10/96		1488cc	49-53kW (67-72PS)		
Nova 1.5 TD		01/90→02/93	Diesel	Turbo			
Nova Hatchback 1.5 TD		01/90→03/93					TD18227
Corsa Mk I 1.5 TD		03/93→10/96	X 15 DT (T4EC1)				
				4cyl.			
				1488cc	49kW (67PS)		
			Diesel	Turbo			
TD22871							
08-307000-00	STD	76.00	2.000		001 CR P		KV1
08-307007-00	0.50mm		1.500		005 P		STD
08-307011-00	1.00mm		3.000		231 CR P		STD
[R43910]							
Astra Mk II Estate 1.4 S		01/89→08/91	14 NV				
Astra Mk II Hatchback 1.4 S		01/90→08/91		4cyl.			
Astra Mk III 1.4		09/91→09/93		1389cc	53-55kW (72-75PS)		
Astra Mk III 1.4 S		09/91→02/98					
Astramax 1.4 S		07/89→08/91					
Cavalier Mk III 1.4 S,		09/88→11/95					
Cavalier Mk III Hatchback 1.4 S							
Nova 1.4 S		01/90→02/93					
Nova Hatchback 1.4 S		01/90→03/93					
Novavan 1.4		11/90→03/93					TD17562
Astra Mk II Belmont 1.4 i		01/90→12/91	C 14 NZ				
Astra Mk II Hatchback 1.4 i		01/90→08/91		4cyl.			
Astra Mk III 1.4 i		09/91→09/98		1389cc	44kW (60PS)		
Astra Mk IV 1.4		05/98→05/05					
Astra Van Mk III 1.4 i		01/91→10/94					
Astramax 1.4 i		08/91→07/94					
Combo Mk I 1.4		07/94→10/01					
Corsa Mk I 1.4 i		03/93→09/00					
Corsavan Mk I 1.4 i		01/94→09/00					
Nova 1.4		10/90→08/92					
Nova Hatchback 1.4 i		01/90→03/93					TD17581





Astra Mk III 1.4 i	03/91→03/01	C 14 SE			
Combo Mk I 1.4	07/94→10/01		4cyl.		
Corsa Mk I 1.4 i S	03/93→09/00		1389cc	60kW (81PS)	
Nova 1.4	09/90→08/92				
Nova Hatchback 1.4 i S	09/91→03/93				TD17582

Corsa Mk I 1.4 i 16V	08/97→09/00	C 14 SEL			
			4cyl.		
			1389cc	63kW (86PS)	
					TD21363

Astra Mk IV 1.4	05/98→05/05	X 14 SZ			
Corsa Mk I 1.4 i	03/93→09/00		4cyl.		
			1389cc	44kW (60PS)	
					TD17621

Astra Mk III 1.4 i 16V	01/96→03/01	X 14 XE			
Astra Mk IV 1.4 16V	02/98→05/05		4cyl.		
Combo Mk I 1.4 16V	08/99→10/01		1389cc	66kW (89PS)	
Corsa Mk I 1.4 i 16V	09/94→09/00				
Tigra Mk I 1.4 16V	07/94→12/00				TD17589

08-307100-00	STD	77.60	1.500		001 IF CR P	KV1
08-307107-00	0.50mm		1.500		026 P	STD
[R43740]			3.000		712 CR	ST

Astra Mk IV 1.4 16V	02/98→05/05	Z 14 XE				15
Combo Mk II 1.4 16V	10/01→05/07		4cyl.			
Corsa Mk II 1.4 16V	09/00→10/06		1389cc	66kW (89PS)		
						TD17631

08-144200-00	STD	77.60	1.200		001 NT	ST
08-144207-00	0.50mm		1.500		005 P	GOE12
			2.000		712 CR	ST

Nova Hatchback 1.2 N	01/90→03/93	12 NV				16
Novavan 1.2	01/90→10/94		4cyl.			
			1196cc	38kW (52PS)		
						TD22840

08-306400-00	STD	77.80	1.500		001 IF CR P	IKA
[R40250]			1.500		005 IF P	STD
			4.000		712 CR	ST



Nova 1.2 S Nova Hatchback 1.2 S	09/82→10/87 05/83→02/90	12 ST	4cyl. 1196cc	40-43kW (54-58PS)	17
					TD17599

08-306200-00 STD →eng.12ST19136602 [R40260]	77.80	1.750		001 IF CR P	IKA
		2.000		026 P	STD
		4.000		712 CR	ST
08-306400-00 STD eng.12ST19136603→ [R40250]	77.80	1.500		001 IF CR P	IKA
		1.500		005 IF P	STD
		4.000		712 CR	ST

Nova 1.2	01/85→12/86	12 N	4cyl. 1196cc	38-40kW (52-55PS)	18
					TD17554

Nova 1.2 N Nova Hatchback 1.2 i	01/85→10/87 01/85→10/89	12 NC	4cyl. 1196cc	33kW (45PS)	TD17555
--	----------------------------	--------------	------------------------	--------------------	----------------

Astra 1.2 Astra Hatchback 1.2 Astra Hatchback 1.2 S Astra Mk II Estate 1.2 Astra Mk II Hatchback 1.2 Nova Hatchback 1.2 S	10/79→08/82 10/79→08/84 02/82→08/84 09/84→12/88 09/84→08/91 01/88→02/90	12 S	4cyl. 1196cc	44kW (60PS)	TD17556
--	--	-------------	------------------------	--------------------	----------------

Astra Mk II 1.2	09/84→07/86	12 SC	4cyl. 1196cc	40kW (54PS)	TD17598
------------------------	-------------	--------------	------------------------	--------------------	----------------

Nova 1.2 N Nova Hatchback 1.2 i	01/85→10/87 01/85→10/89	E 12 GV	4cyl. 1196cc	33kW (45PS)	TD22847
--	----------------------------	----------------	------------------------	--------------------	----------------

08-304200-00 STD 08-304207-00 0.50mm 08-304211-00 1.00mm [R33294K]	79.00	2.000		001 CR P	STD
		2.000		026 P	GOE12
		5.000		236 P	STD

Astra Mk II Belmont 1.6 S Astra Mk II Convertible 1.6 i Astra Mk II Estate 1.6, Astra Mk II Hatchback 1.6 Astramax 1.6 Cavalier Mk III 1.6, Cavalier Mk III Hatchback 1.6	01/89→12/91 01/87→12/91 09/84→08/91 09/85→12/91 09/88→05/93	16 SV	4cyl. 1598cc	60kW (81PS)	19
					TD17565

Astra Mk II Convertible 1.6 i CAT Cavalier Mk II 1.6 i CAT	10/87→02/93 08/86→08/88	C 16 LZ	4cyl. 1598cc	55kW (75PS)	TD21362
---	----------------------------	----------------	------------------------	--------------------	----------------





Astra Mk II Convertible 1.6 i CAT	10/87→02/93	C 16 NZ				
Astra Mk III 1.6 i	09/91→09/98		4cyl.			
Astra Van Mk III 1.6 i	01/91→08/98		1598cc	55kW (75PS)		
Astramax 1.6 i	08/91→10/94					
Cavalier Mk II 1.6 i CAT	08/86→08/88					TD17583
Astra Mk III 1.6	03/94→08/95	C 16 SE				
Astra Mk III 1.6 i	03/92→02/98		4cyl.			
Astra Mk III 1.6 Si	03/91→12/94		1598cc	74kW (100PS)		
Nova Hatchback 1.6 GSI CAT	02/92→03/93					TD17608
Astra Mk II Convertible 1.6 i	01/91→08/93	E 16 NZ				
Astra Mk III 1.6 i	09/91→02/98		4cyl.			
Cavalier Mk II 1.6 i	08/86→08/88		1598cc	55kW (75PS)		
Cavalier Mk III 1.6 i,	09/88→11/95					
Cavalier Mk III Hatchback 1.6 i						TD17618
Nova Hatchback 1.6	09/88→08/90	E 16 SE				
Nova Hatchback 1.6 GSI	05/88→03/92		4cyl.			
			1598cc	74kW (100PS)		TD17586
Astra Mk III 1.6 i	03/93→02/98	X 16 SZ				
Astra Van Mk III 1.6 i	02/94→10/96		4cyl.			
Cavalier Mk III 1.6 i,	09/93→11/95		1598cc	52kW (71PS)		
Cavalier Mk III Hatchback 1.6 i						TD17622
Astra Mk III 1.6 i	03/92→03/01	X 16 SZR				
Astra Mk IV 1.6	02/98→04/04		4cyl.			
Astra Van Mk IV 1.6 i	08/98→09/00		1598cc	55kW (75PS)		
Vectra 1.6 i	08/95→03/02					TD17623
08-306900-00	STD	79.00	1.200		001 CR	ST
08-306907-00	0.50mm		1.500		026 P	STD
[R43150]			3.000		712 CR	ST
Combo Mk I 1.7 D	07/94→10/01	17 D (4EE1)				20
Corsa Mk I 1.7 D	02/96→09/00		4cyl.			
Corsavan Mk I 1.7 D	01/94→09/00		1686cc	44kW (60PS)		
		Diesel				TD22845
Astra Mk III 1.7 TD	12/91→09/98	17 DT (TC4EE1)				
Cavalier Mk III 1.7 TD,	09/88→11/95		4cyl.			
Cavalier Mk III Hatchback 1.7 TD			1686cc	60kW (81PS)		
		Diesel	Turbo			TD22846
Combo Mk I 1.7 D	07/94→10/01	X 17 D (4EE1)				
Corsa Mk I 1.7 D	02/96→09/00		4cyl.			
Corsavan Mk I 1.7 D	01/94→09/00		1686cc	44kW (60PS)		
		Diesel				TD22872
Vectra 1.7 TD	10/95→12/97	X 17 DT (TC4EE1)				
			4cyl.			
			1686cc	60kW (81PS)		
		Diesel	Turbo Intercooled			TD22873
Astra Mk IV 1.7 DTI 16V	02/00→05/05	Y 17 DT				
Astra Van Mk IV 1.7 DTI 16V	04/01→08/06		4cyl.			
Combo Mk II 1.7 DTI 16V	10/01→11/11		1686cc	55kW (75PS)		
Combo TOUR Mk II 1.7 DTI 16V	10/01→02/12	Diesel	Turbo Intercooled			
Corsa Mk II 1.7 DTI 16V	08/00→09/06					
Corsavan Mk II 1.7 DTI 16V	09/00→06/06					
Meriva Mk I 1.7 DTI 16V	06/03→06/10					TD18380





Combo Mk II 1.7 DI 16V		09/01→11/11	Y 17 DTL			
Combo TOUR Mk II 1.7 DI 16V		09/01→06/04			4cyl.	
Corsa Mk II 1.7 DI 16V		08/00→09/06			1686cc	48kW (65PS)
Corsavan Mk II 1.7 DI 16V		09/00→06/06	Diesel	Turbo Intercooled		TD18381
Astra Mk V 1.7 CDTi		01/04→11/10	Z 17 DTH			
Astra Mk VI 1.7 CDTi		12/09→			4cyl.	
Astravan Mk V 1.7 CDTi		03/05→11/11			1686cc	74kW (100PS)
Combo Mk II 1.7 CDTi 16V		12/04→11/11	Diesel	Turbo Intercooled		
Combo TOUR Mk II 1.7 CDTi 16V		12/04→09/10				
Corsa Mk II 1.7 CDTi 16V		08/00→09/06				
Meriva Mk I 1.7 CDTi 16V		09/03→08/05				TD17941
Astra Mk IV 1.7 CDTi 16V		04/03→05/05	Z 17 DTL			
Astra Mk V 1.7 CDTi		01/04→05/09			4cyl.	
Astra Van Mk IV 1.7 CDTi		04/04→08/06			1686cc	59kW (80PS)
Astravan Mk V 1.7 CDTi		03/05→07/06	Diesel	Turbo Intercooled		TD17945
08-307600-00	STD	79.00	2.000		001 CR P	KV1
08-307607-00	0.50mm				005 CR P	STD
[R48400]			3.000		231 CR P	STD
Astra GTC Mk VI 1.6		10/11→	A 16 LET Euro 5			21
Astra Mk VI 1.6 Turbo		12/09→			4cyl.	
Insignia 1.6 Turbo,		01/09→			1598cc	132kW (180PS)
Insignia Saloon 1.6 Turbo,					Turbo Intercooled	
Insignia Sports Tourer 1.6 Turbo						TD22590
08-435500-00	STD	79.00	1.200		001 NT	ST
08-435507-00	0.50mm				026 P	GOE13
			2.000		712 NT	ST
Corsa Mk I 1.6 GSI 16V		03/93→09/00	C 16 XE			22
					4cyl.	
					1598cc	78-80kW (106-109PS)
						TD17609
Corsa Mk I 1.6 i 16V		09/94→09/00	X 16 XE			
Tigra Mk I 1.6 16V		07/94→12/00			4cyl.	
					1598cc	78kW (106PS)
						TD17624
Astra Mk III 1.6 i 16V		01/94→09/98	X 16 XEL			
Astra Mk IV 1.6 16V		02/98→05/05			4cyl.	
Vectra 1.6 i 16V		08/95→03/02			1598cc	74kW (100PS)
Zafira Mk I 1.6 16V		04/99→08/05				
Zafira Mk I 1.6 Dualfuel		11/98→08/05				TD17590
08-307800-00	STD	79.00	1.200		001 CR	ST
08-307807-00	0.50mm				026 P	STD
08-307811-00	1.00mm		1.500		712 CR	ST
[R48380]			2.500			



Vectra 1.6 i 16V	08/95→03/02	Y 16 XE	4cyl. 1598cc	74kW (100PS)	23
					TD22874

Astra Mk IV 1.6	03/98→05/05	Z 16 SE	4cyl. 1598cc	62-64kW (84-87PS)	
Astra Mk IV 1.6 Dualfuel	07/00→05/05				
Astra Van Mk IV 1.6 i	09/00→08/06				
Combo Mk II 1.6	08/01→11/11				
Combo TOUR Mk II 1.6	10/01→06/04				
Corsa Mk II 1.6	08/01→10/04				
Meriva Mk I 1.6 i	01/03→10/09				TD17632

Astra Mk IV 1.6 16V	02/98→10/05	Z 16 XE	4cyl. 1598cc	63-74kW (85-101PS)	
Astra Mk IV 1.6 Dualfuel	03/98→05/05				
Meriva Mk I 1.6 i 16V	01/03→10/09				
Vectra 1.6 i 16V	08/95→03/02				
Vectra Mk II 1.6 16V	06/04→07/08				
Zafira Mk I 1.6 16V	04/99→08/05				
Zafira Mk I 1.6 Dualfuel	11/98→08/05				TD17937

08-125600-00	STD	79.00	1.200		001 NT	ST
08-125607-00	0.50mm		1.500		026 P	STD
			2.500		712 CR	ST
<i>[R60570]</i>						

Astra Mk IV 1.6	12/02→05/05	Z 16 XEP	4cyl. 1598cc	74-77kW (101-105PS)	24
Astra Mk IV 1.6 16V	09/98→10/05				
Astra Mk V 1.6	01/04→11/10				
Astra TwinTop Mk V 1.6	09/05→11/10				
Astravan Mk V 1.6	03/05→				
Meriva Mk I 1.6 i 16V Twinport	01/03→10/09				
Vectra Mk II 1.6	01/06→07/08				
Zafira Mk II 1.6	07/05→				TD17939

08-427800-00	STD	79.00	1.200		001 NT	ST
08-427807-00	0.50mm		1.200		026 P	GOE13
			2.000		712 CR	ST

Astra Mk V 1.6	01/04→05/09	Z 16 XER	4cyl. 1598cc	85kW (116PS)	25
Astra Mk V 1.6 i 16V	12/06→11/10				
Astra TwinTop Mk V 1.6 i 16V	10/06→11/10				
Zafira Mk II 1.6	12/07→				TD21873

08-435300-00	STD	79.00	1.200		001 NT	ST
08-435307-00	0.50mm		1.200		026 P	F12/F14
			2.000		712 NT	ST



Astra Estate 1.6 D	02/82→08/86	16 D							
Astra Hatchback 1.6 D	03/82→08/86		4cyl.						26
Cavalier Mk II 1.6 D, Cavalier Mk II Hatchback 1600D	03/82→08/88		1598cc	40kW (54PS)					
		Diesel							TD17563

Astra Mk II Belmont 1.6 D	09/85→08/91	16 DA							
Astra Mk II Estate 1.6 D, Astra Mk II Hatchback 1.6 D	09/84→12/89		4cyl.						
Astramax 1.6 D	05/86→06/90		1598cc	40kW (54PS)					
Cavalier Mk II Estate 1.6 D, Cavalier Mk II Hatchback 1600D	03/82→08/88	Diesel							TD17601

08-305900-10	STD	80.00	2.000		001 CR P		KV1
08-305907-10	0.50mm				005 IF P		STD
08-305911-10	1.00mm		2.000		231 CR P		STD
[R35900]			3.000				

Cavalier Mk II 1.6	08/81→07/86	16 N							
Cavalier Mk II 1.6 N	09/81→08/88		4cyl.						27
			1598cc	51kW (69PS)					
									TD17602

Astra Estate 1.6 S	09/81→08/86	16 SH							
Astra Mk II Belmont 1.6	09/85→08/91		4cyl.						
Astra Mk II Estate 1.6 S, Astra Mk II Hatchback 1.6 S	09/84→08/86		1598cc	66kW (89PS)					
Cavalier Mk II 1.6 S	09/81→08/88								
Cavalier Mk II Estate 1.6	10/83→08/88								
Cavalier Mk II Hatchback 1.6 S	09/81→08/88								TD17564

08-305600-00	STD	80.00	1.500		001 IF CR P		IKA
08-305607-00	0.50mm				026 P		STD
08-305611-00	1.00mm		1.750		712 CR		ST
[R35930]			4.000				

Arena Combi 1.9 D, Arena Van 1.9 D	03/98→08/01	F8Q 600							
			4cyl.						28
			1870cc	44kW (60PS)					
		Diesel							TD21360

Arena Combi 1.9 D, Arena Van 1.9 D	03/98→08/01	F8Q 606							
			4cyl.						
			1870cc	44kW (60PS)					
		Diesel							TD21358

08-336500-00	STD	80.00	2.000		001 MO P		KV1
08-336505-00	0.25mm				005 IFU P		IKA
08-336507-00	0.50mm		2.000		231 CR P		STD
08-336510-00	0.80mm		3.000				
[R66330]							

Vivaro Box 1.9 DTI, Vivaro Combi 1.9 DTI	08/01→12/06	F9Q 760							
			4cyl.						29
			1870cc	74kW (100PS)					
		Diesel							TD19375

08-113700-00	STD	80.00	2.500		001 IF CK P		KV1	
				2.000		005 IFU P		IKA
				3.000		231 CR P		STD



Omega 2.5 TD	01/94→	U 25TD	6cyl. 2498cc 96kW (131PS)	30
		Diesel	Turbo Intercooled	TD18956
Omega 2.5 TD	04/94→07/01	X 25 DT	6cyl. 2497cc 96kW (131PS)	
		Diesel	Turbo Intercooled	TD17595
Omega 2.5 TD	05/94→	X 25 TD	6cyl. 2498cc 96kW (131PS)	
		Diesel	Turbo Intercooled	TD17920

08-704500-00	STD	80.00	3.000		008 CR P	KV1
08-704507-00	0.50mm		1.750		005 IFU P	IKA
[R49900]			3.000		231 CR P	STD

Astra Mk IV 1.8 16V	02/98→08/05	X 18 XE1	4cyl. 1796cc 85kW (116PS)	31
Vectra 1.8 i 16V	10/95→09/00			
Zafira Mk I 1.8 16V	05/99→08/00			TD17626

Astra Mk IV 1.8 16V	02/98→10/05	Z 18 XE	4cyl. 1799cc 87-92kW (118-125PS)	
Astra Mk IV 1.8 16V Dualfuel	02/98→08/05			
Astra Mk V 1.8	01/04→11/10			
Astra TwinTop Mk V 1.8	09/05→11/10			
Corsa Mk II 1.8 16V	08/00→09/06			
Meriva Mk I 1.8 i 16V	05/03→08/05			
Signum 1.8	06/03→07/05			
Tigra TwinTop 1.8	06/04→08/09			
Vectra 1.8 i 16V	09/00→07/03			
Vectra Mk II 1.8 16V,	04/02→07/08			
Vectra Mk II 1.8 16V Dualfuel				
Zafira Mk I 1.8 16V,	09/00→08/05			
Zafira Mk I 1.8 Dualfuel				TD17633

Astra Mk IV 1.8 16V	03/00→08/05	Z 18 XEL	4cyl. 1796cc 85kW (116PS)	
Vectra Mk II 1.8	04/02→07/08			TD17987

Astra Mk V 1.8	01/04→05/09	Z 18 XER	4cyl. 1796cc 103kW (140PS)	
Astra Mk V 1.8 i 16V	03/07→11/10			
Astra TwinTop Mk V 1.8	05/08→11/10			
Signum 1.8	08/05→05/08			
Vectra Mk II 1.8	01/06→07/08			
Zafira Mk II 1.8	04/05→			TD18838

08-141200-00	STD	80.50	1.200		001 NT	ST
08-141207-00	0.50mm		1.200		005 P	GOE12
			2.000		712 CR	ST



Astra Mk III 1.8 Astra Mk III 1.8 i 16V	09/94→08/96 06/93→02/98	C 18 XE	4cyl. 1796cc	92kW (125PS)	32	TD17611
Astra Mk III 1.8 16V Astra Mk III 1.8 i 16V	11/94→03/01 01/94→02/98	C 18 XEL	4cyl. 1796cc	85kW (116PS)		
Calibra 2.5 i V6 Cavalier Mk III 2.5 V6 Cavalier Mk III Hatchback 2.5 V6	04/93→07/97 08/88→06/94 09/88→06/94	C 25 XE	V6cyl. 2498cc	125kW (170PS)	33	TD17635
Astra Mk III 1.8 16V Astra Mk III 1.8 i 16V Vectra 1.8 i 16V	11/94→03/01 09/94→02/98 10/95→09/00	X 18 XE	4cyl. 1796cc	85kW (116PS)		
Calibra 2.5 i V6 Omega 2.5 V6 Vectra 2.5 i GSi Vectra 2.5 i V6	04/93→07/97 03/94→09/00 03/98→07/00 09/95→08/00	X 25 XE	V6cyl. 2498cc	125-143kW (170-194PS)	34	TD17634
Astra Mk V 1.9 CDTi Astravan Mk V 1.9 CDTi Signum 1.9 CDTi Vectra Mk II 1.9 CDTi Zafira Mk II 1.9 CDTi	01/04→11/10 03/05→11/11 04/04→03/08 04/02→09/08 07/05→	Z 19 DT	4cyl. 1910cc	74-88kW (100-120PS)		
Astra Mk V 1.9 CDTi Signum 1.9 Turbo Vectra Mk II 1.9 CDTi Zafira Mk II 1.9 CDTi	08/04→11/10 01/05→05/08 10/05→07/08 07/05→	Z 19 DTL Euro 4	4cyl. 1910cc	74kW (100PS)	35	TD20149
Astra Mk V 1.9 CDTi Astra TwinTop Mk V 1.9 CDTi Astravan Mk V 1.9 CDTi Signum 1.9 CDTi 16V Vectra Mk II 1.9 CDTi 16V Zafira Mk II 1.9 CDTi	01/04→11/10 01/06→11/10 03/05→11/11 04/04→03/08 04/04→08/08 07/05→	Z 19 DTH	4cyl. 1910cc	110kW (150PS)		
Astra Mk V 1.9 CDTi 16V	01/04→05/09	Z 19 DTJ	4cyl. 1910cc	88kW (120PS)	36	TD18017

08-307700-00	STD	81.60	1.500		001 MO P	IKA
08-307707-00	0.50mm		1.500		026 P	STD
08-307711-00	1.00mm		3.000		712 CR	ST
[R49600]						

08-124000-00	STD	82.00	2.000		001 CK P	KV1
08-124006-00	0.40mm		2.000		026 P	F12/F14
08-124008-00	0.60mm		2.000		231 CR P	GOE12
[R60580]						

08-146100-00	STD	82.00	2.000		001 CK P	KV1
08-146106-00	0.40mm		2.000		023 IWU P	F12/F14
08-146108-00	0.60mm		2.000		231 CK P	GOE12
[R67925]						



Astra Mk II Belmont 1.7 D	01/89→12/91	17 D				35
Astra Mk II Estate 1.7 D	02/89→08/91		4cyl.			
Astra Mk III 1.7 D	12/91→02/98		1699cc	42kW (57PS)		
Astramax 1.7 D	01/89→07/94	Diesel				
Cavalier Mk III 1.7 D, Cavalier Mk III Hatchback 1.7 D	09/88→09/92					
TD17566						

Astra Mk II Hatchback 1.7 D	01/89→08/91	17 DR				35
Astra Mk III 1.7 D	03/91→09/98		4cyl.			
Astra Van Mk III 1.7 D	01/91→08/94		1699cc	42-44kW (57-60PS)		
Cavalier Mk III 1.7 D, Cavalier Mk III Hatchback 1.7 D	07/92→11/95	Diesel				
TD17567						

Astra Mk III 1.7 TD	01/94→09/98	X 17 DTL				35
Astra Mk IV 1.7 TD	02/98→08/00		4cyl.			
Astra Van Mk III 1.7 TD	01/94→08/98		1699cc	50kW (68PS)		
Astra Van Mk IV 1.7 TD	08/98→08/06	Diesel	Turbo Intercooled			
TD17591						

08-306700-00	STD	82.50	2.000		001 CR P	KV1
08-306707-00	0.50mm				005 P	STD
08-306711-00	1.00mm				231 CR P	STD
[R48750]						

Zafira Mk III 2.0 CDTi	10/11→	A 20 DT Euro 5				36
			4cyl.			
			1956cc	96kW (131PS)		
		Diesel	Turbo Intercooled			TD25781

Insignia 2.0 CDTI, Insignia Saloon 2.0 CDTI, Insignia Sports Tourer 2.0 CDTI	07/08→	A 20 DTC Euro 5				36
			4cyl.			
			1956cc	81kW (110PS)		
		Diesel	Turbo Intercooled			TD22598

Zafira Mk III 2.0 CDTI	10/11→	A 20 DTE Euro 5				36
			4cyl.			
			1956cc	88-103kW (120-140PS)		
		Diesel	Turbo Intercooled			TD28276

Astra GTC Mk VI 2.0 CDTi	10/11→	A 20 DTH Euro 5				36	
Astra Mk VI 2.0 CDTi	12/09→		4cyl.				
Cascadia Convertible 2.0 CDTI	02/13→		1956cc	118kW (160PS)			
Insignia 2.0 CDTI, Insignia 2.0 CDTI 4x4, Insignia Saloon 2.0 CDTI, Insignia Saloon 2.0 CDTI 4x4, Insignia Sports Tourer 2.0 CDTI, Insignia Sports Tourer 2.0 CDTI 4x4	07/08→	Diesel	Turbo Intercooled				
Zafira Mk III 2.0 CDTi	10/11→						
TD22603							

Insignia 2.0 CDTI, Insignia Saloon 2.0 CDTI, Insignia Sports Tourer 2.0 CDTI	07/08→	A 20 DTJ Euro 5				36
			4cyl.			
			1956cc	96kW (131PS)		
		Diesel	Turbo Intercooled			TD22600

Zafira Mk III 2.0 CDTi	10/11→	A 20 DTL Euro 5				36
			4cyl.			
			1956cc	81kW (110PS)		
		Diesel	Turbo			TD25780





Astra GTC Mk VI 2.0 BiTurbo CDTI,		12/12→	A 20 DTR Euro 5			
Astra Mk VI 2.0 BiTurbo CDTI			4cyl.			
Cascada Convertible 2.0 CDTI		02/13→	1956cc 140kW (190PS)			
Insignia 2.0 Biturbo CDTI,		03/12→	Diesel Bi-Turbo Intercooled			
Insignia 2.0 Biturbo CDTI 4x4						
Insignia 2.0 CDTI		10/08→				
Insignia 2.0 CDTI 4x4		05/09→				
Insignia Saloon 2.0 Biturbo CDTI,		03/12→				
Insignia Saloon 2.0 Biturbo CDTI 4x4						
Insignia Saloon 2.0 CDTI		11/08→				
Insignia Saloon 2.0 CDTI 4x4		05/09→				
Insignia Sports Tourer 2.0 Biturbo CDTI,		03/12→				
Insignia Sports Tourer 2.0 Biturbo CDTI 4x4						
Insignia Sports Tourer 2.0 CDTI		11/08→				
Insignia Sports Tourer 2.0 CDTI 4x4		05/09→				
Zafira Mk III 2.0 BiTurbo CDTI		01/13→				TD25210
Combo Mk III 2.0 CDTI		11/11→	A 20 FD Euro 5			
			4cyl.			
			1956cc 99kW (135PS)			
			Diesel Turbo Intercooled			TD26202
Zafira Mk III 2.0 CDTI		10/11→	Y 20 DTJ			
			4cyl.			
			1956cc 96kW (131PS)			
			Diesel Turbo Intercooled			TD27238
Zafira Mk III 2.0 CDTI		10/11→	Z 20 DTJ			
			4cyl.			
			1956cc 96kW (131PS)			
			Diesel Turbo Intercooled			TD25783
08-436500-00	STD	83.00	1.500		001 GDC P	KV4
08-436506-00	0.40mm		1.500		050 P	F12/F14
			2.000		231 LKZ CK P	GOE13
Omega 2.6 V6		08/00→07/03	Y 26 SE			37
Vectra 2.6 i V6		09/00→07/03	V6cyl.			
			2597cc 125-132kW (170-180PS)			
						TD18888
08-126100-00	STD	83.20	1.200		001 CK	ST
08-126107-00	0.50mm		1.500		026 P	GOE12
			3.000		712 CR	ST
	[R66640]					
Vivaro Box 2.0 CDTI,		01/06→	M9R 630			38
Vivaro Combi 2.0 CDTI, Vivaro Platform/			4cyl.			
Chassis 2.0 CDTI			1995cc 66-84kW (90-114PS)			
			Diesel Turbo Intercooled			TD25645
Vivaro Box 2.0 CDTI,		01/06→	M9R 780 Euro 4			
Vivaro Combi 2.0 CDTI			4cyl.			
Vivaro Platform/Chassis 2.0 CDTI		08/06→	1995cc 66-84kW (90-114PS)			
			Diesel Turbo Intercooled			TD20889
Vivaro Box 2.0 CDTI,		01/06→	M9R 782			
Vivaro Combi 2.0 CDTI, Vivaro Platform/			4cyl.			
Chassis 2.0 CDTI			1995cc 66-84kW (90-114PS)			
			Diesel Turbo Intercooled			TD21889





Vivaro Combi 2.0 CDTI		08/06→	M9R 784		4cyl. 1995cc 84kW (114PS)		
			Diesel Turbo Intercooled				TD21904
Vivaro Box 2.0 CDTI, Vivaro Combi 2.0 CDTI		01/06→	M9R 786 Euro 4		4cyl. 1995cc 66-84kW (90-114PS)		
			Diesel Turbo Intercooled				TD25647
Vivaro Box 2.0 CDTI, Vivaro Combi 2.0 CDTI, Vivaro Platform/ Chassis 2.0 CDTI		08/06→	M9R 788		4cyl. 1995cc 84kW (114PS)		
			Diesel Turbo Intercooled				TD25644
08-422000-00	STD	84.00	2.500		007 MOL P		KV1
08-422007-00	0.50mm		2.000		005 IFU MOL P		GOE12
			2.000		231 CR P		GOE12
Astra Mk IV 2.0 DTI 16V		02/98→05/05	X 20 DTH		4cyl. 1995cc 74kW (100PS)		39
Omega 2.0 DTI 16V		01/98→09/00					
Vectra 2.0 DTI 16V		08/95→10/01					
			Diesel Turbo Intercooled				TD17592
08-102900-00	STD	84.00	2.500		008 CK P		KV1
08-102907-00	0.50mm		1.750		005 P		IKA
[R49840]			3.000		231 CR P		STD
Astra Mk IV 2.0 DI		02/98→05/05	X 20 DTL		4cyl. 1995cc 60kW (81PS)		40
Astra Van Mk IV 2.0 DI		08/98→08/06					
Vectra 2.0 DI 16V		08/95→10/01					
Zafira Mk I 2.0 DI 16V		10/99→08/05					TD17627
Astra Mk IV 2.0 DI		02/98→05/05	Y 20 DTL		4cyl. 1995cc 60kW (81PS)		
			Diesel Turbo				TD17926
08-102800-00	STD	84.00	2.000		001 CK P		KV1
08-102807-00	0.50mm		1.750		005 P		IKA
[R49830]			3.000		231 CR P		STD
Frontera Mk II 2.2 DTI		10/98→09/04	X 22 DTH		4cyl. 2172cc 85kW (116PS)		41
Sintra 2.2 DTI		07/97→04/99					
			Diesel Turbo Intercooled				TD17916
Astra Mk IV 2.0 DTI 16V		02/98→05/05	Y 20 DTH		4cyl. 1995cc 74kW (100PS)		
Astra Van Mk IV 2.0 DTI		04/04→08/06					
Signum 2.0 DTI		05/03→05/08					
Vectra 2.0 DTI 16V		08/95→10/01					
Vectra Mk II 2.0 DTI 16V		04/02→10/08					
Zafira Mk I 2.0 DTI 16V		04/99→08/05					TD17924
Frontera Mk II 2.2 DTI		10/98→09/04	Y 22 DTH		4cyl. 2172cc 85-88kW (116-120PS)		
Omega 2.2 DTI 16V		08/00→07/03					
			Diesel Turbo Intercooled				TD17928





Astra Mk IV 2.2 DTI	09/02→05/05			Y 22 DTR			
Signum 2.2 DTI	05/03→05/08				4cyl.		
Vectra 2.2 DTI 16V	08/95→10/01				2172cc	92kW (125PS)	
Vectra Mk II 2.2 DTI 16V	04/02→10/08			Diesel	Turbo Intercooled		
Zafira Mk I 2.2 D	06/01→06/05						TD17629
08-126000-00	STD	84.00	1.750		001 CK P		KV1
08-126007-00	0.50mm				005 P		IKA
[R60610]			3.000		231 CR P		GOE12
Astra Hatchback 1.8 GTE	03/83→08/86			18 E			42
Astra Mk II Belmont 1.8 i	09/85→08/91				4cyl.		
Astra Mk II Estate 1.8 i	01/90→08/91				1796cc	85kW (116PS)	
Astra Mk II Hatchback 1.8 GTE	09/84→08/91						
Cavalier Mk II 1.8 i	09/81→08/88						
Cavalier Mk II Estate 1.8 i	09/81→08/86						
Cavalier Mk II Hatchback 1.8 i	09/81→08/88						TD17568
Carlton Mk II 1.8 S	12/82→08/86			18 S			
Carlton Mk II Estate 1.8 S	11/82→08/86				4cyl.		
Cavalier Mk II Hatchback 1.8 S	07/82→08/88				1796cc	66kW (89PS)	
							TD17603
Astra Mk II Belmont 1.8	01/86→12/90			18 SE			
Astra Mk II Belmont 1.8 i	09/85→08/91				4cyl.		
Astra Mk II Hatchback 1.8 GTE	09/84→08/91				1796cc	82kW (111PS)	
Astra Mk III 1.8 i 16V	09/95→02/98						
Cavalier Mk II 1.8 i	09/81→08/88						
Cavalier Mk II Convertible 1800i	03/85→10/88						
Cavalier Mk II Estate 1.8 i	09/81→08/86						
Cavalier Mk II Hatchback 1.8 i	09/81→08/88						TD17604
Carlton Mk III 1.8 i, Carlton Mk III Estate 1.8 i	09/86→03/94			18 SEH			
					4cyl.		
					1796cc	85kW (116PS)	
							TD17570
Carlton Mk III 1.8 S, Carlton Mk III Estate 1.8 S	09/86→03/94			18 SV			
					4cyl.		
Cavalier Mk III 1.8	09/88→08/95				1796cc	66kW (89PS)	
Cavalier Mk III Hatchback 1.8	09/88→10/90						TD17571
Astra Mk II Belmont 1.8 i	10/85→08/86			C 18 NE			
Cavalier Mk II 1.8 i CAT	01/85→08/86				4cyl.		
					1796cc	74kW (100PS)	
							TD22865





Astra Mk III 1.8 i	09/91→09/98	C 18 NZ		
Cavalier Mk III 1.8	09/88→08/95		4cyl.	
Cavalier Mk III 1.8 i CAT	03/90→11/95		1796cc	66kW (89PS)
Cavalier Mk III Hatchback 1.8	09/88→10/90			
Cavalier Mk III Hatchback 1.8 i CAT	03/90→11/95			TD17610

08-306000-00	STD	84.80	1.500		001 IF CR P	IKA
08-306007-00	0.50mm		1.750		026 P	STD
[R39880]			4.000		712 CR	ST
08-306100-00	STD	84.80	1.500		001 IF MO P	IKA
			1.750		026 P	STD
			4.000		712 CR	ST
08-307200-00	STD	84.80	1.500		001 CR P	KV1
08-307207-00	0.50mm		1.500		026 P	STD
09/1986→			3.000		712 CR	ST
[R43260]						

Carlton Mk III 1.8 N, Carlton Mk III Estate 1.8 N	09/86→08/87	18 NV			43
			4cyl.		
			1796cc	60kW (81PS)	
					TD17569

Cavalier Mk II 1.8	08/86→08/88	E 18 NV			
			4cyl.		
			1796cc	62kW (84PS)	
					TD17587

Carlton Mk III 1.8, Carlton Mk III Estate 1.8	09/87→03/94	E 18 NVR			
Cavalier Mk III 1.8	09/89→08/92		4cyl.		
			1796cc	65kW (88PS)	
					TD17588



Carlton Mk III Estate 1.8	09/86→08/88	S 18 NV			
			4cyl.		
			1796cc	62-74kW (84-101PS)	
					TD21884

08-307200-00	STD	84.80	1.500		001 CR P	KV1
08-307207-00	0.50mm		1.500		026 P	STD
09/1986→			3.000		712 CR	ST
[R43260]						



Cavalier 1.6 N	03/75→08/81	16 N	4cyl. 1584cc	44kW (60PS)	44	TD22841
----------------	-------------	------	-----------------	-------------	----	---------

Astra Hatchback 1.6 S	09/81→08/86	16 S	4cyl. 1598cc	55-66kW (75-90PS)		TD22382
Astra Mk II Estate 1.6 S	09/84→08/86					

08-304000-00	STD	85.00	2.000		001 IF CR P	STD
			2.000		026 P	STD
			5.000		236 P	STD

Movano Mk II 2.3 CDTI, Movano Mk II 2.3 CDTI FWD	05/10→	M9T 670 Euro 5	4cyl. 2298cc	74-92kW (101-125PS)	45	TD24749
		Diesel	Turbo Intercooled			

Movano Mk II 2.3 CDTI, Movano Mk II 2.3 CDTI FWD	05/10→	M9T 672 Euro 5	4cyl. 2298cc	74-92kW (101-125PS)		TD25155
		Diesel	Turbo Intercooled			

Movano Mk II 2.3 CDTI, Movano Mk II 2.3 CDTI FWD	05/10→	M9T 676 Euro 4	4cyl. 2298cc	74-92kW (101-125PS)		TD24748
		Diesel	Turbo Intercooled			

Movano Mk II 2.3 CDTI, Movano Mk II 2.3 CDTI FWD	05/10→	M9T 678	4cyl. 2298cc	107kW (146PS)		TD25156
		Diesel	Turbo Intercooled			

Movano Mk II 2.3 CDTI, Movano Mk II 2.3 CDTI FWD	05/10→	M9T 680	4cyl. 2298cc	92-107kW (125-146PS)		TD25138
		Diesel	Turbo Intercooled			

Movano Mk II 2.3 CDTI [RWD]	05/10→	M9T 686 Euro 5	4cyl. 2298cc	92kW (125PS)		TD25152
		Diesel	Turbo Intercooled			

Movano Mk II 2.3 CDTI [RWD]	05/10→	M9T 690 Euro 5	4cyl. 2298cc	74-92kW (101-125PS)		TD25105
		Diesel	Turbo Intercooled			

Movano Mk II 2.3 CDTI [RWD]	05/10→	M9T 692 Euro 4	4cyl. 2298cc	74-92kW (101-125PS)		TD25106
		Diesel	Turbo Intercooled			

Movano Mk II 2.3 CDTI [RWD], Movano Mk II 2.3 CDTI FWD	05/10→	M9T 694 Euro 4	4cyl. 2298cc	107kW (146PS)		TD24750
		Diesel	Turbo Intercooled			

Movano Mk II 2.3 CDTI [RWD]	05/10→	M9T 696 Euro 4	4cyl. 2298cc	92-107kW (125-146PS)		TD25149
		Diesel	Turbo Intercooled			





Movano Mk II 2.3 CDTI [RWD]		05/10→	M9T 698 Euro 5				
			4cyl.				
			2298cc		107kW (146PS)		
			Diesel	Turbo Intercooled			TD24751
08-435200-00	STD	85.00	2.500		007 GDC P		KV1
08-435207-00	0.50mm		2.000		005 IF MO P		GOE13
			2.000		231 CR P		GOE13
Astra Mk II Convertible 2.0 i		01/87→12/91	20 NE				46
Astra Mk II Hatchback 2.0		09/86→08/91	4cyl.				
Cavalier Mk II 2.0 i		09/86→08/88	1998cc		85kW (116PS)		
Cavalier Mk III 2.0 i		09/88→10/90					
Cavalier Mk III 2.0 i 4x4		01/91→10/92					
Cavalier Mk III Hatchback 2.0 i		09/88→10/92					
Cavalier Mk III Hatchback 2.0 i 4x4		01/91→10/92					TD17637
Carlton Mk III 2.0 i,		09/86→03/94	20 SE				
Carlton Mk III Estate 2.0 i			4cyl.				
Cavalier Mk II 2000i,		09/86→08/88	1998cc		90kW (122PS)		
Cavalier Mk II Hatchback 2000i							
Omega 2.0		09/95→09/96					TD17573
Astra Mk II Hatchback 2.0 GTE		09/86→08/91	20 SEH				
Cavalier Mk II 2.0 4x4		09/87→08/88	4cyl.				
Cavalier Mk II 2.0 SRi 130		03/87→08/88	1998cc		95kW (129PS)		
Cavalier Mk II Hatchback 2.0 4x4		09/87→08/88					
Cavalier Mk II Hatchback 2.0 SRi 130		03/87→08/88					
Cavalier Mk III 2.0 i 4x4,		09/88→09/92					
Cavalier Mk III 2.0 SRi,							
Cavalier Mk III Hatchback 2.0 i 4x4,							
Cavalier Mk III Hatchback 2.0 SRi							TD17574
Astra Mk II Hatchback 2.0 GTE 16V		05/88→08/91	20 XE				
Cavalier Mk III 2.0 GSi,		09/89→08/92	4cyl.				
Cavalier Mk III 2.0 GSi 4x4			1998cc		115kW (156PS)		
							TD17605
Calibra 2.0 i Turbo 4x4		03/92→07/97	C 20 LET				
Cavalier Mk III 2.0 i Turbo 4x4		06/92→11/94	4cyl.				
			1998cc		150kW (204PS)		
			Turbo Intercooled				TD17612
Astra Mk II Convertible 2.0 i CAT		01/91→08/93	C 20 NE				
Astra Mk III 2.0 i		09/91→09/98	4cyl.				
Calibra 2.0 i, Calibra 2.0 i 4x4		06/90→07/97	1998cc		85kW (116PS)		
Carlton Mk III 2.0,		09/86→03/94					
Carlton Mk III Estate 2.0							
Cavalier Mk II 2.0 i CAT,		09/86→08/88					
Cavalier Mk II Hatchback 2.0 i CAT							
Cavalier Mk III 2.0 i CAT,		09/90→11/95					
Cavalier Mk III Hatchback 2.0 i CAT							
Frontera Mk I 2.0		04/95→08/98					
Frontera Mk I 2.0 i		03/92→10/98					TD17584
Astra Mk II Hatchback 1.9		03/88→08/91	C 20 XE				
Astra Mk III 2.0 i 16V		09/91→02/98	4cyl.				
Calibra 2.0 i 16V, Calibra 2.0 i 16V 4x4		06/90→02/94	1998cc		110kW (150PS)		
Cavalier Mk III 2.0 i 16V,		09/88→11/95					
Cavalier Mk III 2.0 i 16V 4x4,							
Cavalier Mk III Hatchback 2.0 i 16V							
Cavalier Mk III Hatchback 2.0 i 16V 4x4		01/92→11/93					TD17585





Vectra 2.2i 16V	10/99→09/02	C 22 SEL	4cyl. 2198cc	102-106kW (139-144PS)	TD22204
Frontera Mk I 2.0	04/95→08/98	X 20 SE	4cyl. 1998cc	85kW (116PS)	TD17593
Frontera Mk I 2.0 i	03/92→10/98				
Omega 2.0	03/94→09/99				
Astra Mk III 2.0 i 16V	01/94→09/98	X 20 XEV	4cyl. 1998cc	100kW (136PS)	TD17594
Astra Mk IV 2.0 16V	02/98→05/05				
Calibra 2.0 i 16V	06/90→07/97				
Calibra 2.0 i 16V 4x4	02/94→07/97				
Cavalier Mk III 2.0 SRi 16V,	09/93→11/95				
Cavalier Mk III Hatchback 2.0 i 16V					
Omega 2.0 16V	03/94→02/01				
Vectra 2.0 i 16V	10/95→01/01				
Frontera Mk II 2.2 i	10/98→10/04	X 22 SE	4cyl. 2198cc	100-104kW (136-141PS)	TD17918
Frontera Mk I 2.2 i	03/95→10/98	X 22 XE	4cyl. 2198cc	100kW (136PS)	TD17628
Sintra 2.2 i 16 V	11/96→04/99				
Omega 3.0 V6	04/94→07/00	X 30 XE	V6cyl. 2962cc	148-155kW (201-211PS)	TD17922
Sintra 3.0 i 24V	11/96→04/99				

08-306800-00	STD	86.00	1.500		001 IF CR P	IKA
08-306807-00	0.50mm				005 IF P	STD
08-306811-00	1.00mm		1.500		712 CR	ST
<i>[R43290]</i>			3.000			

Movano Mk I 2.2 DTI	09/00→05/10	G9T 720	4cyl. 2188cc	66kW (89PS)	47
		Diesel	Turbo Intercooled		TD19353
Movano Mk I 2.2 DTI	09/00→05/10	G9T 722	4cyl. 2188cc	66kW (89PS)	TD19356
		Diesel	Turbo Intercooled		
Movano Mk I 2.2 DTI	09/00→05/10	G9T 750	4cyl. 2188cc	66kW (89PS)	TD19355
		Diesel	Turbo Intercooled		

08-127400-00	STD	87.00	3.000		007 P PS	KV1
08-127407-00	0.50mm		1.750		005 IFU P	IKA
<i>[R66780]</i>			2.500		236 P	IKA



Omega 3.2 V6	02/01→07/03	Y 32 SE	V6cyl. 3175cc	160kW (218PS)	48
					TD18887

08-126200-00	STD	87.50	1.200		001 CK	ST
08-126207-00	0.50mm		1.500		026 P	GOE13
[R66630]			2.500		712 CR	ST

Brava Pickup 2.2 D, Brava Pickup 2.2 D 4x4	08/91→09/96	C 223	4cyl. 2238cc	39-54kW (53-73PS)	49
					TD22879

08-247600-00	STD	88.00	2.000		001 P	IKA
12/1983→			2.000		005 P	STD
[R42520]			4.000		236 P	STD

Carlton Mk III 2.6 i, Carlton Mk III Estate 2.6 i Senator Mk II 2.6 i	09/90→03/94	C 26 NE	6cyl. 2594cc	110kW (150PS)	50
					TD17614

08-307400-00	STD	88.80	1.500		001 IF MO P	IKA
			1.500		026 P	STD
			3.000		236 P	STD

Vivaro Box 2.5 CDTI Vivaro Box 2.5 DTI Vivaro Combi 2.5 CDTI Vivaro Combi 2.5 DTI Vivaro Platform/Chassis 2.5 CDTI	08/06→ 04/04→ 01/06→ 04/04→ 04/03→	G9U 630 Euro 4	4cyl. 2464cc	84-107kW (114-146PS)	51
					TD21903

08-137500-00	STD	89.00	3.000		007 MO P	KV1
08-137507-00	0.50mm		1.750		005 IFU P	STD
[R66720]			2.500		236 P	GOE12

Movano Mk I 2.5 DTI	10/01→05/10	G9U 720 Euro 3	4cyl. 2463cc	84kW (114PS)	52
					TD19358

Movano Mk I 2.5 DTI	10/01→05/10	G9U 724 Euro 3	4cyl. 2463cc	84kW (114PS)	52
					TD19368

Vivaro Box 2.5 DTI, Vivaro Combi 2.5 DTI Vivaro Platform/Chassis 2.5 CDTI	04/04→ 04/03→	G9U 730 Euro 3	4cyl. 2463cc	99kW (135PS)	52
					TD18701

Movano Mk I 2.5 DTI	10/01→05/10	G9U 750 Euro 3	4cyl. 2463cc	84kW (114PS)	52
					TD19365





Movano Mk I 2.5 CDTI, Movano Mk I 2.5 DTI		10/01→05/10	G9U 754 Euro 3		4cyl. 2463cc 73kW (99PS)	
			Diesel	Turbo Intercooled		TD19369

08-137500-10	STD	89.00	2.500		001 IF MO P	KV1
08-137507-10	0.50mm		1.750		005 IFU P	F12/F14
			2.500		231 CR P	GOE12

Carlton Mk II 2.3 D, Carlton Mk II Estate 2.3 D		05/83→08/86	23 D		4cyl. 2260cc 48-52kW (65-71PS)	53
			Diesel			TD17575

08-305400-10	STD	92.00	2.000		001 CR P	KV1
08-305407-10	0.50mm		2.000		005 IF P	STD
08-305411-10	1.00mm		4.000		231 CR P	STD

Carlton Mk III 2.3 TD Interc. Carlton Mk III Estate 2.3 TD Interc. Frontera Mk I 2.3 TD		08/88→03/94 09/88→03/94 03/92→10/98	23 DTR		4cyl. 2260cc 74kW (100PS)	54
			Diesel	Turbo Intercooled		TD17576

Carlton Mk III 2.2 TD Carlton Mk III Estate 2.2 TD		10/86→08/88 09/86→08/88	23 YDT		4cyl. 2260cc 66kW (89PS)	
			Diesel	Turbo		TD17579

08-306600-00	STD	92.00	2.500		008 MOL P	KV1
08-306607-00	0.50mm		2.000		005 P	F12/F14
			4.000		231 CR P	STD

Frontera Mk I 2.5 TDS		09/96→10/98	25TDS (VM41B)		4cyl. 2499cc 85kW (116PS)	55
			Diesel	Turbo Intercooled		TD22850

08-110100-00	STD	92.00	2.500		008 CR P	KV1
[R47730]			2.000		026 P	STD
			4.000		231 CR P	STD



Arena Combi 2.5 D, Arena Van 2.5 D		03/98→08/01	S8U 758		4cyl. 2499cc	55-58kW (75-79PS)	56
			Diesel				TD22883
Arena Combi 2.5 D, Arena Van 2.5 D		03/98→08/01	S8U 780		4cyl. 2499cc	55kW (75PS)	TD22884
			Diesel				
Arena Combi 2.5 D, Arena Van 2.5 D		03/98→08/01	S8U 782		4cyl. 2499cc	55kW (75PS)	TD22885
			Diesel				
08-783300-00	STD	93.00	3.000		001 CR P		KV1
08-783308-00	0.60mm		2.000		026 P		STD
[R47100]			3.000		231 CR P		STD
Movano Mk I 2.8 DTI, Movano Mk I 2.8 TDI			S9W 700		4cyl. 2799cc	84kW (114PS)	57
			Diesel		Turbo		TD21150
Movano Mk I 2.8 DTI, Movano Mk I 2.8 TDI		10/98→10/01	S9W 702		4cyl. 2799cc	84kW (114PS)	TD19361
			Diesel		Turbo		
08-122200-00	STD	94.40	2.500		008 CK P		KV1
08-122208-00	0.60mm		2.000		005 P		IKA
eng.2572280→			2.500		231 CR P		GOE12
[R60070]							
08-854700-00	STD	94.40	3.000		008 CR		GOE12
08-854708-00	0.60mm		2.000		005 IWU P		GOE12
→eng.2572279			3.000		231 CR		GOE12
[R49690]							
Carlton Mk II 2.0 i		01/83→12/84	20 E		4cyl.		58
Carlton Mk II Estate 1.9		09/77→08/86			1979cc	81kW (110PS)	TD18375
Cavalier Mk II 2.0		08/86→08/87					
Cavalier Mk II Hatchback 2.0		09/86→08/87					
Cavalier 2.0 S		01/78→08/81	20 S		4cyl.		TD17572
Cavalier CC 2000		08/77→08/81			1979cc	74kW (100PS)	
Cavalier Coupe 2.0 S		03/78→08/81					
Cavalier Mk II 2.0,		09/86→08/87					
Cavalier Mk II Hatchback 2.0							
Royale 2.9 E		02/78→12/86	30 E		6cyl.		TD17580
Royale 3.0		10/79→10/82			2969cc	132kW (180PS)	
Royale Coupe 2.9		02/78→08/86					
Royale Coupe 3.0		10/79→10/82					
Senator 3.0 i		09/84→12/86					
Royale 2.9, Senator 3.0		04/78→07/82	30 H		6cyl.		TD22852
					2969cc	110kW (150PS)	





Carlton Mk III 3.0 3000 Senator Mk II 3.0	03/87→09/90 09/87→09/90	30 NE	6cyl. 2969cc	130-135kW (177-184PS)	TD18376
Royale 3.0 Coupe	01/80→12/83	30 S	6cyl. 2969cc	110kW (150PS)	FM2688
Carlton Mk III 3000 Royale 2.9, Senator 3.0 Senator Mk II 3.0	03/87→12/87 09/85→08/87 09/87→09/93	C 30 LE	6cyl. 2969cc	115kW (156PS)	TD17615
Carlton Mk III 3000 CAT Carlton Mk III Estate 3.0 Senator Mk II 3.0 i CAT	03/88→03/94 03/87→03/94 01/88→09/93	C 30 NE	6cyl. 2969cc	130kW (177PS)	TD17616

08-305000-00	STD	95.00	2.000		001 IF MO P	IKA
08-305007-00	0.50mm		2.000		026 P	STD
[R41350V1]			4.000		712 CR	ST

Carlton Mk III 2.4 i, Carlton Mk III Estate 2.4 i Frontera Mk I 2.4 i	09/88→03/94 03/92→10/98	C 24 NE	4cyl. 2410cc	92kW (125PS)	59 TD17613
Carlton Mk III 3.0 3000 24V Senator Mk II 3.0 24V	09/89→03/94 09/89→09/93	C 30 SE	6cyl. 2969cc	150kW (204PS)	TD17617
Carlton Mk III 3000 24V, Carlton Mk III Estate 3.0 24V	09/89→03/94	C 30 SEJ	6cyl. 2969cc	147kW (200PS)	TD18889

08-307300-00	STD	95.00	1.500		001 MOL P	KV1
08-307307-00	0.50mm		1.500		026 P	STD
[R49610]			3.000		712 CR	ST

ENGINE INDEX

Motorverzeichnis • Index de moteur • Índice de Motor
Indeks silnika • Модель двигателя • دليل المحرك



CCM

x



9

HR88-1	Diesel	499	1	88.00	1
HR88-2	Diesel	998	2	88.00	1
HR88-3	Diesel	1497	3	88.00	1
HR88-4	Diesel	1994	4	88.00	1
HR88-5	Diesel	2492	5	88.00	1
HR88-6	Diesel	2988	6	88.00	1
HR92-1	Diesel	598	1	92.00	2
HR92-2	Diesel	1196	2	92.00	2
HR92-3	Diesel	1794	3	92.00	2
HR92-4	Diesel	2392	4	92.00	2
HR92-5	Diesel	2990	5	92.00	2
HR92-6	Diesel	3588	6	92.00	2
HR492HTI	Diesel	2500	4	92.00	2
R 425 DOHC	Diesel	2499	4	92.00	3
R 425 OHV	Diesel	2499	4	92.00	4
VM 80 A	Diesel	1995	4	88.00	1
VM 81 A	Diesel	2393	4	92.00	2
VM 392 HT	Diesel	1779	3	92.00	2
VM 492 HT	Diesel	2393	4	92.00	2



1

HR88-1		1cyl.	499cc		Diesel		FM6204
HR88-2		2cyl.	998cc		Diesel		FM6205
HR88-3		3cyl.	1497cc		Diesel		FM6206
HR88-4		4cyl.	1994cc	52kW (71PS)	Diesel		FM6207
HR88-5		5cyl.	2492cc	75kW (102PS)	Diesel		FM6208
HR88-6		6cyl.	2988cc		Diesel		FM6209
VM 80 A		4cyl.	1995cc	70-78kW (95-106PS)	Diesel	Turbo	TD21355
08-110000-00	STD	88.00	2.500		008 CR P		KV1
[R47710]			2.000		023 P		STD
			4.000		231 CR P		STD

2

HR492HTI		4cyl.	2500cc	85kW (116PS)	Diesel	Turbo	FM4053
HR92-1		1cyl.	598cc		Diesel		FM6210
HR92-2		2cyl.	1196cc		Diesel		FM6211
HR92-3		3cyl.	1794cc		Diesel		FM6212
HR92-4		4cyl.	2392cc		Diesel		FM6213
HR92-5		5cyl.	2990cc		Diesel		FM6214
HR92-6		6cyl.	3588cc		Diesel		FM6215
VM 392 HT		3cyl.	1779cc		Diesel	Turbo	FM4049
VM 492 HT		4cyl.	2393cc		Diesel	Turbo	FM4047
VM 81 A		4cyl.	2393cc	81kW (110PS)	Diesel	Turbo	TD21356
08-110100-00	STD	92.00	2.500		008 CR P		KV1
[R47730]			2.000		026 P		STD
			4.000		231 CR P		STD

3

R 425 DOHC		4cyl.	2499cc	70-104kW (94-140PS)	Diesel	Turbo Intercooled	TD18633
08-423100-00	STD	92.00	2.500		008 CK P		KV1
→01/2005			1.500		026 P		IKA
			2.000		231 NT		GOE12
08-429200-00	STD	92.00	2.500		008 IF GDC P		KV1
02/2005→			1.500		050 P		KV1
			2.000		231 NT		GOE13



4

R 425 OHV		4cyl.	2499cc	87kW (118PS)	Diesel	Turbo Intercooled	TD18627
08-134100-00 →12/2004 [R67370]	STD	92.00	2.500		008 CK P		KV1
			1.500		026 P		IKA
			2.000		231		GOE13
08-423200-00 01/2004→	STD	92.00	2.500		008 CK P		KV1
			1.500		023 P		IKA
			2.000		231 NT		GOE13



3102, GAZ 20-10

XDP88

4cyl.
2000cc

1

Diesel

FM6216

08-313800-10	STD	98.00	2.000		001 IW CR P	KV1
[R66050]			2.000		005 P	STD
			2.000		026 P	STD
			4.500		231 CR P	STD

3102,31029, GAZ 24-10,GAZ 53

ZMZ4062.10

4cyl.
2400cc

2

FM6217

08-398300-00	STD	92.00	2.000		001 IF CR P	IKA
08-398307-00	0.50mm		2.000		005 P	GOE13
			5.000		236 P	GOE13

3102, GAZ 23-10

XD2, XD2P, XD94

4cyl.
2304cc

3

M24 2.3 D

01/71→12/80

M24 Break 2.3 D

01/71→12/87

Diesel

FM1428

08-318700-10	STD	94.00	2.000		001 CR P	KV1
08-318704-10	0.20mm		2.000		005 IF P	STD
08-318706-10	0.40mm		4.000		231 CR P	STD
08-318707-10	0.50mm					
08-318708-10	0.60mm					
08-318710-10	0.80mm					
[R66140]						

MODEL INDEX

Modelverzeichnis • Index de modele • Índice de Modelo
Indeks modelu • Модель автомобиля • دليل الموديل



CCM

x



9

09/69→07/70	181 1.5	H	Diesel	1493	B4	48
03/73→02/79	181 1.6	AL	Petrol	1584	B4	51
03/73→02/79	181 1.6	AM	Petrol	1584	B4	51
07/73→03/75	411	AN	Petrol	1795	4	57
07/73→03/75	411	AT	Petrol	1795	4	57
07/68→08/73	411	V	Petrol	1679	4	54
09/69→08/73	411	W	Petrol	1679	4	54
07/68→08/73	411	Z	Petrol	1679	4	54
07/68→08/73	412 1.7	V	Petrol	1679	4	54
09/69→08/73	412 1.7	W	Petrol	1679	4	54
07/68→08/73	412 1.7	Z	Petrol	1679	4	54
07/73→03/75	412 1.8	AN	Petrol	1795	4	57
07/73→03/75	412 1.8	AT	Petrol	1795	4	57
01/72→12/73	412 Variant 1.7	W	Petrol	1679	4	54
07/73→03/75	412 Variant 1.8 E, LE	AN	Petrol	1795	4	57
07/73→03/75	412 Variant 1.8 E, LE	AT	Petrol	1795	4	57
01/65→12/77	1200	113	Petrol	1285	4	19
01/65→12/79	1200	211, 311	Petrol	1584	B4	51
01/65→12/77	1200A	113	Petrol	1285	4	19
01/65→12/77	1300	113	Petrol	1285	4	19
01/65→12/77	1300A Ghia	113	Petrol	1285	4	19
01/67→12/75	1302S	211, 311	Petrol	1584	B4	51
01/72→12/79	1303S	211, 311	Petrol	1584	B4	51
04/61→07/73	1500	K	Petrol	1493	B4	48
07/68→07/73	1500	K	Petrol	1493	B4	48
07/64→07/73	1500	P	Petrol	1584	B4	51
08/65→07/73	1500	T	Petrol	1584	B4	51
08/65→07/73	1500	U	Petrol	1584	B4	51
04/61→07/73	1600 1.5	K	Petrol	1493	B4	48
08/65→07/73	1600 1.6	T	Petrol	1584	B4	51
08/65→07/73	1600 1.6	U	Petrol	1584	B4	51
07/64→07/73	1600 1.6 L	P	Petrol	1584	B4	51
08/65→07/73	1600 1.6 TL	T	Petrol	1584	B4	51
08/65→07/73	1600 1.6 TL	U	Petrol	1584	B4	51
07/68→07/73	1600 Hatchback 1.5 L	K	Petrol	1493	B4	48
08/65→07/73	1600 Hatchback 1.6 TL	T	Petrol	1584	B4	51
08/65→07/73	1600 Hatchback 1.6 TL	U	Petrol	1584	B4	51
01/67→12/75	1600 Karmann Ghia	211, 311	Petrol	1584	B4	51
01/68→12/79	1600 Transporter	211, 311	Petrol	1584	B4	51
04/61→07/73	1600 Variant 1.5	K	Petrol	1493	B4	48
08/65→07/73	1600 Variant 1.6 L	T	Petrol	1584	B4	51
08/65→07/73	1600 Variant 1.6 L	U	Petrol	1584	B4	51
01/66→12/75	1600TL	211, 311	Petrol	1584	B4	51
09/10→	Amarok 2.0 BiTDI	CDCA	Diesel	1968	4	40
11/11→	Amarok 2.0 BiTDI	CNEA	Diesel	1968	4	40
11/11→	Amarok 2.0 BiTDI	CSHA	Diesel	1968	4	40
09/10→	Amarok 2.0 BiTDI 4motion	CDCA	Diesel	1968	4	40
11/11→	Amarok 2.0 BiTDI 4motion	CNEA	Diesel	1968	4	40
11/11→	Amarok 2.0 BiTDI 4motion	CSHA	Diesel	1968	4	40
09/10→	Amarok 2.0 TDI	CDBA	Diesel	1968	4	40
09/10→	Amarok 2.0 TDI	CNFA	Diesel	1968	4	40
09/10→	Amarok 2.0 TDI 4motion	CDBA	Diesel	1968	4	40
09/10→	Amarok 2.0 TDI 4motion	CNFA	Diesel	1968	4	40
01/65→12/77	Beetle	113	Petrol	1285	4	19
04/11→	Beetle 1.4 TSI	CAVD	Petrol	1390	4	18
04/11→	Beetle 1.4 TSI	CNWA	Petrol	1390	4	18
10/11→	Beetle 1.6 TDI	CAYC	Diesel	1598	4	25
04/11→	Beetle 2.0 TDI	CFFB	Diesel	1968	4	41
04/11→	Beetle 2.0 TDI	CJAA	Diesel	1968	4	40



CCM



12/12→	Beetle Convertible 1.4 TSI	CAVD	Petrol	1390	4	18
12/12→	Beetle Convertible 1.4 TSI	CNWA	Petrol	1390	4	18
12/12→	Beetle Convertible 1.6 TDI	CAYC	Diesel	1598	4	25
12/12→	Beetle Convertible 2.0 TDI	CFFB	Diesel	1968	4	41
12/12→	Beetle Convertible 2.0 TDI	CJAA	Diesel	1968	4	40
03/00→05/05	Bora 1.4 16V	AHW	Petrol	1390	4	13
03/00→05/05	Bora 1.4 16V	AKQ	Petrol	1390	4	13
03/00→05/05	Bora 1.4 16V	APE	Petrol	1390	4	13
03/00→05/05	Bora 1.4 16V	AXP	Petrol	1390	4	13
03/00→05/05	Bora 1.4 16V	BCA	Petrol	1390	4	15
10/98→05/05	Bora 1.6	AEH	Petrol	1595	4	35
10/98→05/05	Bora 1.6	AKL	Petrol	1595	4	35
10/98→05/05	Bora 1.6	APF	Petrol	1595	4	35
08/00→05/05	Bora 1.6	AVU	Petrol	1595	4	38
08/00→05/05	Bora 1.6	BFQ	Petrol	1595	4	38
05/00→05/05	Bora 1.6 16V	ATN	Petrol	1595	4	13
05/00→05/05	Bora 1.6 16V	AUS	Petrol	1597	4	13
05/00→05/05	Bora 1.6 16V	AZD	Petrol	1597	4	13
05/00→05/05	Bora 1.6 16V	BCB	Petrol	1598	4	13
10/98→05/05	Bora 1.8	AGN	Petrol	1781	4	36
02/99→05/05	Bora 1.8 4motion	AGN	Petrol	1781	4	36
05/00→05/05	Bora 1.8 T	AGU	Petrol	1781	4	36
05/00→05/05	Bora 1.8 T	ARX	Petrol	1781	4	36
05/00→05/05	Bora 1.8 T	AUM	Petrol	1781	4	36
03/02→05/05	Bora 1.8 T	AUQ	Petrol	1781	4	36
10/98→05/05	Bora 1.9 SDI	AGP	Diesel	1896	4	22
10/98→05/05	Bora 1.9 SDI	AQM	Diesel	1896	4	22
10/98→06/01	Bora 1.9 TDI	AGR	Diesel	1896	4	22
10/98→06/01	Bora 1.9 TDI	AHF	Diesel	1896	4	22
12/98→01/02	Bora 1.9 TDI	AJM	Diesel	1896	4	22
10/98→06/01	Bora 1.9 TDI	ALH	Diesel	1896	4	22
05/00→05/05	Bora 1.9 TDI	ARL	Diesel	1896	4	22
10/98→06/01	Bora 1.9 TDI	ASV	Diesel	1896	4	22
11/00→05/05	Bora 1.9 TDI	ASZ	Diesel	1896	4	22
09/00→05/05	Bora 1.9 TDI	ATD	Diesel	1896	4	22
12/98→01/02	Bora 1.9 TDI	AUY	Diesel	1896	4	22
09/00→05/05	Bora 1.9 TDI	AXR	Diesel	1896	4	22
02/99→06/01	Bora 1.9 TDI 4motion	AGR	Diesel	1896	4	22
02/99→06/01	Bora 1.9 TDI 4motion	AJM	Diesel	1896	4	22
05/00→05/05	Bora 1.9 TDI 4motion	ARL	Diesel	1896	4	22
11/00→05/05	Bora 1.9 TDI 4motion	ASZ	Diesel	1896	4	22
09/00→05/05	Bora 1.9 TDI 4motion	ATD	Diesel	1896	4	22
02/99→06/01	Bora 1.9 TDI 4motion	AUY	Diesel	1896	4	22
10/98→05/05	Bora 2.0	APK	Petrol	1984	4	43
10/98→05/05	Bora 2.0	AQY	Petrol	1984	4	43
10/98→05/05	Bora 2.0	AZH	Petrol	1984	4	43
10/98→05/05	Bora 2.0	AZJ	Petrol	1984	4	43
04/00→05/05	Bora 2.0 4motion	AZH	Petrol	1984	4	43
04/00→05/05	Bora 2.0 4motion	AZJ	Petrol	1984	4	43
10/98→10/00	Bora 2.3 V5	AGZ	Petrol	2324	V5	32
10/00→05/05	Bora 2.3 V5	AQN	Petrol	2324	V5	32
12/98→10/00	Bora 2.3 V5 4motion	AGZ	Petrol	2324	V5	32
10/00→05/05	Bora 2.3 V5 4motion	AQN	Petrol	2324	V5	32
03/99→05/05	Bora 2.8 V6 4motion	AQP	Petrol	2792	V6	32
03/99→05/05	Bora 2.8 V6 4motion	AUE	Petrol	2792	V6	32
03/99→05/05	Bora 2.8 V6 4motion	BDE	Petrol	2792	V6	32
09/01→05/05	Bora Estate 1.4 16V	AHW	Petrol	1390	4	13
09/01→05/05	Bora Estate 1.4 16V	AXP	Petrol	1390	4	13
09/01→05/05	Bora Estate 1.4 16V	BCA	Petrol	1390	4	15

MODEL INDEX

Modelverzeichnis • Index de modele • Índice de Modelo
Indeks modelu • Модель автомобиля • دليل الموديل



CCM



9

05/99→05/05	Bora Estate 1.6	AEH	Petrol	1595	4	35
05/99→05/05	Bora Estate 1.6	AKL	Petrol	1595	4	35
05/99→05/05	Bora Estate 1.6	APF	Petrol	1595	4	35
08/00→05/05	Bora Estate 1.6	AVU	Petrol	1595	4	38
08/00→05/05	Bora Estate 1.6	BFQ	Petrol	1595	4	38
02/00→05/05	Bora Estate 1.6 16V	ATN	Petrol	1595	4	13
02/00→05/05	Bora Estate 1.6 16V	AUS	Petrol	1597	4	13
02/00→05/05	Bora Estate 1.6 16V	AZD	Petrol	1597	4	13
02/00→05/05	Bora Estate 1.6 16V	BCB	Petrol	1598	4	13
05/99→05/05	Bora Estate 1.8 4motion	AGN	Petrol	1781	4	36
05/00→05/05	Bora Estate 1.8 T	AGU	Petrol	1781	4	36
05/00→05/05	Bora Estate 1.8 T	ARX	Petrol	1781	4	36
05/00→05/05	Bora Estate 1.8 T	AUM	Petrol	1781	4	36
05/02→05/05	Bora Estate 1.8 T	AUQ	Petrol	1781	4	36
07/04→05/05	Bora Estate 1.9 TDI	AGR	Diesel	1896	4	22
05/99→06/01	Bora Estate 1.9 TDI	AHF	Diesel	1896	4	22
05/99→06/01	Bora Estate 1.9 TDI	AJM	Diesel	1896	4	22
05/01→05/05	Bora Estate 1.9 TDI	ARL	Diesel	1896	4	22
05/99→06/01	Bora Estate 1.9 TDI	ASV	Diesel	1896	4	22
11/00→05/05	Bora Estate 1.9 TDI	ASZ	Diesel	1896	4	22
09/00→05/05	Bora Estate 1.9 TDI	ATD	Diesel	1896	4	22
05/99→06/01	Bora Estate 1.9 TDI	AUY	Diesel	1896	4	22
09/00→05/05	Bora Estate 1.9 TDI	AXR	Diesel	1896	4	22
05/99→06/01	Bora Estate 1.9 TDI 4motion	AJM	Diesel	1896	4	22
05/01→05/05	Bora Estate 1.9 TDI 4motion	ARL	Diesel	1896	4	22
11/00→05/05	Bora Estate 1.9 TDI 4motion	ASZ	Diesel	1896	4	22
09/00→05/05	Bora Estate 1.9 TDI 4motion	ATD	Diesel	1896	4	22
05/99→06/01	Bora Estate 1.9 TDI 4motion	AUY	Diesel	1896	4	22
05/99→05/05	Bora Estate 2.0	APK	Petrol	1984	4	43
05/99→05/05	Bora Estate 2.0	AQY	Petrol	1984	4	43
05/99→05/05	Bora Estate 2.0	AZH	Petrol	1984	4	43
05/99→05/05	Bora Estate 2.0	AZJ	Petrol	1984	4	43
04/00→05/05	Bora Estate 2.0 4motion	AZH	Petrol	1984	4	43
04/00→05/05	Bora Estate 2.0 4motion	AZJ	Petrol	1984	4	43
05/99→10/00	Bora Estate 2.3 V5	AGZ	Petrol	2324	V5	32
10/00→05/05	Bora Estate 2.3 V5	AQN	Petrol	2324	V5	32
05/99→10/00	Bora Estate 2.3 V5 4motion	AGZ	Petrol	2324	V5	32
10/00→05/05	Bora Estate 2.3 V5 4motion	AQN	Petrol	2324	V5	32
05/99→05/05	Bora Estate 2.8 V6 4motion	AQP	Petrol	2792	V6	32
05/99→05/05	Bora Estate 2.8 V6 4motion	AUE	Petrol	2792	V6	32
05/99→05/05	Bora Estate 2.8 V6 4motion	BDE	Petrol	2792	V6	32
03/00→05/00	Bora Estate 2.8 VR6	AUE	Petrol	2792	V6	32
08/82→07/83	Caddy I 1.5	JB	Petrol	1457	4	27
01/83→07/92	Caddy I 1.6	EW	Petrol	1595	4	30
08/82→07/92	Caddy I 1.6 D	JK	Diesel	1588	4	10
08/82→07/92	Caddy I 1.6 D	ME	Diesel	1588	4	10
08/85→07/92	Caddy I 1.8	JH	Petrol	1781	4	31
08/00→01/04	Caddy II Box 1.4	AUA	Petrol	1390	4	13
07/96→09/00	Caddy II Box 1.7 SDI	AHB	Diesel	1716	4	22
11/95→01/04	Caddy II Box 1.9 D	1Y	Diesel	1896	4	21
11/95→01/04	Caddy II Box 1.9 SDI	AEY	Diesel	1896	4	22
11/95→01/04	Caddy II Box 1.9 SDI	AYQ	Diesel	1896	4	22
09/96→01/04	Caddy II Box 1.9 TDI	1Z	Diesel	1896	4	22
09/96→01/04	Caddy II Box 1.9 TDI	AHU	Diesel	1896	4	22
09/96→01/04	Caddy II Box 1.9 TDI	ALH	Diesel	1896	4	22
11/95→01/04	Caddy II Box 60 1.4	AEX	Petrol	1390	4	12
11/95→01/04	Caddy II Box 60 1.4	APQ	Petrol	1390	4	12
11/95→01/04	Caddy II Box 60 1.4	AUD	Petrol	1390	4	13
11/95→05/97	Caddy II Box 75 1.6	1F	Petrol	1595	4	30



CCM

x



11/95→09/00	Caddy II Box 75 1.6	AEE	Petrol	1598	4	12
11/95→01/04	Caddy II Estate 1.4	AEX	Petrol	1390	4	12
11/95→01/04	Caddy II Estate 1.4	AKV	Petrol	1390	4	12
11/95→01/04	Caddy II Estate 1.4	APQ	Petrol	1390	4	12
11/95→01/04	Caddy II Estate 1.4	AUD	Petrol	1390	4	13
08/00→01/04	Caddy II Estate 1.4 16V	AUA	Petrol	1390	4	13
11/95→05/97	Caddy II Estate 1.6	1F	Petrol	1595	4	30
06/97→09/00	Caddy II Estate 1.6	AEE	Petrol	1598	4	12
07/96→09/00	Caddy II Estate 1.7 SDI	AHB	Diesel	1716	4	22
11/95→01/04	Caddy II Estate 1.9 D	1Y	Diesel	1896	4	21
11/95→01/04	Caddy II Estate 1.9 SDI	AEY	Diesel	1896	4	22
11/95→01/04	Caddy II Estate 1.9 SDI	AYQ	Diesel	1896	4	22
10/96→01/04	Caddy II Estate 1.9 TDI	AHU	Diesel	1896	4	22
10/96→01/04	Caddy II Estate 1.9 TDI	ALE	Diesel	1896	4	22
10/96→01/04	Caddy II Estate 1.9 TDI	ALH	Diesel	1896	4	22
06/96→12/00	Caddy II Pickup 1.6	AEE	Petrol	1598	4	12
06/96→12/00	Caddy II Pickup 1.9 D	AEF	Diesel	1896	4	21
03/04→05/06	Caddy III Box 1.4	BCA	Petrol	1390	4	15
05/06→08/10	Caddy III Box 1.4 16V	BUD	Petrol	1390	4	16
04/04→	Caddy III Box 1.6	BGU	Petrol	1595	4	38
04/04→	Caddy III Box 1.6	BSE	Petrol	1595	4	38
04/04→	Caddy III Box 1.6	BSF	Petrol	1595	4	38
08/10→	Caddy III Box 1.6 TDI	CAYD	Diesel	1598	4	25
08/10→	Caddy III Box 1.6 TDI	CAYE	Diesel	1598	4	25
04/04→08/10	Caddy III Box 1.9 TDI	BJB	Diesel	1896	4	24
04/04→08/10	Caddy III Box 1.9 TDI	BLS	Diesel	1896	4	24
09/05→08/10	Caddy III Box 1.9 TDI	BSU	Diesel	1896	4	24
11/08→08/10	Caddy III Box 1.9 TDI 4motion	BLS	Diesel	1896	4	24
03/04→08/10	Caddy III Box 2.0 SDI	BDJ	Diesel	1968	4	39
03/04→08/10	Caddy III Box 2.0 SDI	BST	Diesel	1968	4	39
09/07→08/10	Caddy III Box 2.0 TDI	BMM	Diesel	1968	4	39
11/10→	Caddy III Box 2.0 TDI	CFHE	Diesel	1968	4	41
05/12→	Caddy III Box 2.0 TDI	CFJA	Diesel	1968	4	41
08/10→	Caddy III Box 2.0 TDI	CLCA	Diesel	1968	4	41
11/10→	Caddy III Box 2.0 TDI 16V	CFHC	Diesel	1968	4	41
11/10→	Caddy III Box 2.0 TDI 16V	CLCB	Diesel	1968	4	41
11/10→	Caddy III Box 2.0 TDI 16V 4motion	CFHC	Diesel	1968	4	41
12/10→	Caddy III Box 2.0 TDI 4motion	CFHE	Diesel	1968	4	41
08/10→	Caddy III Box 2.0 TDI 4motion	CFHF	Diesel	1968	4	41
03/04→05/06	Caddy III Estate 1.4	BCA	Petrol	1390	4	15
05/06→08/10	Caddy III Estate 1.4 16V	BUD	Petrol	1390	4	16
04/04→	Caddy III Estate 1.6	BGU	Petrol	1595	4	38
04/04→	Caddy III Estate 1.6	BSE	Petrol	1595	4	38
04/04→	Caddy III Estate 1.6	BSF	Petrol	1595	4	38
08/10→	Caddy III Estate 1.6 TDI	CAYD	Diesel	1598	4	25
08/10→	Caddy III Estate 1.6 TDI	CAYE	Diesel	1598	4	25
04/04→08/10	Caddy III Estate 1.9 TDI	BJB	Diesel	1896	4	24
04/04→08/10	Caddy III Estate 1.9 TDI	BLS	Diesel	1896	4	24
09/05→08/10	Caddy III Estate 1.9 TDI	BSU	Diesel	1896	4	24
05/08→08/10	Caddy III Estate 1.9 TDI 4motion	BLS	Diesel	1896	4	24
03/04→08/10	Caddy III Estate 2.0 SDI	BDJ	Diesel	1968	4	39
03/04→08/10	Caddy III Estate 2.0 SDI	BST	Diesel	1968	4	39
09/07→08/10	Caddy III Estate 2.0 TDI	BMM	Diesel	1968	4	39
05/12→	Caddy III Estate 2.0 TDI	CFJA	Diesel	1968	4	41
08/10→	Caddy III Estate 2.0 TDI	CLCA	Diesel	1968	4	41
11/10→	Caddy III Estate 2.0 TDI 16V	CFHC	Diesel	1968	4	41
11/10→	Caddy III Estate 2.0 TDI 16V	CLCB	Diesel	1968	4	41
11/10→	Caddy III Estate 2.0 TDI 16V 4motion	CFHC	Diesel	1968	4	41
08/10→	Caddy III Estate 2.0 TDI 4motion	CFHF	Diesel	1968	4	41

MODEL INDEX

Modelverzeichnis • Index de modele • Índice de Modelo
Indeks modelu • Модель автомобиля • دليل الموديل



CCM

x



9

11/11→	CC 2.0 TDI	CFFA	Diesel	1968	4	41
11/11→	CC 2.0 TDI	CFFB	Diesel	1968	4	41
11/11→	CC 2.0 TDI	CFGB	Diesel	1968	4	41
12/12→	CC 2.0 TDI	CFGC	Diesel	1968	4	41
11/11→	CC 2.0 TDI	CLLA	Diesel	1968	4	41
11/11→	CC 2.0 TDI 4motion	CFFB	Diesel	1968	4	41
11/11→	CC 2.0 TDI 4motion	CFGB	Diesel	1968	4	41
12/12→	CC 2.0 TDI 4motion	CFGC	Diesel	1968	4	41
04/89→07/92	Corrado 1.8 16V	KR	Petrol	1781	4	31
09/88→09/93	Corrado 1.8 G60	PG	Petrol	1781	4	31
04/93→12/95	Corrado 2.0 i	2E	Petrol	1984	4	43
04/93→12/95	Corrado 2.0 i	ADY	Petrol	1984	4	43
08/91→12/95	Corrado 2.0 i 16V	9A	Petrol	1984	4	43
08/91→12/95	Corrado 2.9 VR6	ABV	Petrol	2861	V6	42
05/11→	Crafter 30-35 Bus 2.0 TDI	CKTB	Diesel	1968	4	40
05/11→	Crafter 30-35 Bus 2.0 TDI	CKTC	Diesel	1968	4	40
07/11→	Crafter 30-35 Bus 2.0 TDI	CKUB	Diesel	1968	4	40
10/11→	Crafter 30-35 Bus 2.0 TDI	CKUC	Diesel	1968	4	40
11/11→	Crafter 30-35 Bus 2.0 TDI 4motion	CKUB	Diesel	1968	4	40
04/06→	Crafter 30-35 Bus 2.5 TDI	BJL	Diesel	2461	5	37
04/06→07/11	Crafter 30-35 Bus 2.5 TDI	BJM	Diesel	2461	5	37
04/06→	Crafter 30-35 Bus 2.5 TDI	CECA	Diesel	2461	5	37
04/06→07/11	Crafter 30-35 Bus 2.5 TDI	CECB	Diesel	2461	5	37
05/11→	Crafter 30-50 Box 2.0 TDI	CKTB	Diesel	1968	4	40
05/11→	Crafter 30-50 Box 2.0 TDI	CKTC	Diesel	1968	4	40
07/11→	Crafter 30-50 Box 2.0 TDI	CKUB	Diesel	1968	4	40
10/11→	Crafter 30-50 Box 2.0 TDI	CKUC	Diesel	1968	4	40
11/11→	Crafter 30-50 Box 2.0 TDI 4motion	CKUB	Diesel	1968	4	40
04/06→	Crafter 30-50 Box 2.5 TDI	BJL	Diesel	2461	5	37
04/06→07/11	Crafter 30-50 Box 2.5 TDI	BJM	Diesel	2461	5	37
04/06→	Crafter 30-50 Box 2.5 TDI	CECA	Diesel	2461	5	37
04/06→07/11	Crafter 30-50 Box 2.5 TDI	CECB	Diesel	2461	5	37
11/11→	Crafter 30-50 Platform/Chassis 2.0 TDI 4motion	CKUB	Diesel	1968	4	40
05/11→	Crafter 30-50 Platform/Chassis 2.0 TDI	CKTB	Diesel	1968	4	40
05/11→	Crafter 30-50 Platform/Chassis 2.0 TDI	CKTC	Diesel	1968	4	40
07/11→	Crafter 30-50 Platform/Chassis 2.0 TDI	CKUB	Diesel	1968	4	40
10/11→	Crafter 30-50 Platform/Chassis 2.0 TDI	CKUC	Diesel	1968	4	40
04/06→	Crafter 30-50 Platform/Chassis 2.5 TDI	BJL	Diesel	2461	5	37
04/06→07/11	Crafter 30-50 Platform/Chassis 2.5 TDI	BJM	Diesel	2461	5	37
04/06→	Crafter 30-50 Platform/Chassis 2.5 TDI	CECA	Diesel	2461	5	37
04/06→07/11	Crafter 30-50 Platform/Chassis 2.5 TDI	CECB	Diesel	2461	5	37
01/75→12/78	Derby	HD	Petrol	1093	4	2
02/77→09/81	Derby 0.9	HA	Petrol	895	4	2
10/81→12/84	Derby 1.0	GL	Petrol	1043	4	4
08/81→12/84	Derby 1.0	HZ	Petrol	1043	4	4
02/77→07/83	Derby 1.1	HB	Petrol	1093	4	2
09/82→12/84	Derby 1.3	GK	Petrol	1272	4	4
02/77→07/83	Derby 1.3	HH	Petrol	1272	4	7
02/77→09/81	Derby 1.3	HJ	Petrol	1272	4	7
08/83→12/84	Derby 1.3	HK	Petrol	1272	4	4
08/83→12/84	Derby 1.3	HW	Petrol	1272	4	4
05/08→	Eos 1.4 TSI	CAVD	Petrol	1390	4	18
11/07→	Eos 1.4 TSI	CAXA	Petrol	1390	4	17
06/06→05/08	Eos 1.6 FSI	BLF	Petrol	1598	4	17
03/06→05/08	Eos 2.0 FSI	BVY	Petrol	1984	4	44
03/06→05/08	Eos 2.0 FSI	BVZ	Petrol	1984	4	44
06/06→05/08	Eos 2.0 TDI	BMM	Diesel	1968	4	39
11/10→	Eos 2.0 TDI	CFFA	Diesel	1968	4	41
05/08→	Eos 2.0 TDI 16V	CBAB	Diesel	1968	4	41



CCM

x



9

05/08→	Eos 2.0 TDI 16V	CFFB	Diesel	1968	4	41
03/06→	Eos 2.0 TFSI	BPY	Petrol	1984	4	44
03/06→	Eos 2.0 TFSI	BWA	Petrol	1984	4	44
06/06→05/09	Eos 3.2 V6	BUB	Petrol	3189	V6	49
06/06→05/09	Eos 3.2 V6	CBR	Petrol	3189	V6	49
06/06→05/09	Eos 3.2 V6	CBRA	Petrol	3189	V6	49
04/05→	Fox 1.4	BKR	Petrol	1390	4	16
04/05→	Fox 1.4 TDI	BNM	Diesel	1422	3	22
05/84→09/94	Gol 1.8	RM	Petrol	1781	4	30
02/76→07/77	Golf	EE	Petrol	1588	4	26
01/87→12/87	Golf	2C	Diesel	1272	4	4
08/77→07/79	Golf 1.5	EH	Petrol	1457	4	27
08/79→07/80	Golf 1.5	GH	Petrol	1457	4	27
08/79→07/80	Golf 1.6	EJ	Petrol	1588	4	27
08/85→07/87	Golf 1.6i	EZA	Petrol	1595	4	30
01/76→07/79	Golf 1.6i	FV	Petrol	1588	4	27
08/80→12/83	Golf 1.7i	EN	Petrol	1716	4	27
04/74→07/83	Golf I 1.1	FA	Petrol	1093	4	2
01/81→07/83	Golf I 1.1	FJ	Petrol	1093	4	2
04/74→07/83	Golf I 1.1	GG	Petrol	1093	4	2
01/81→07/83	Golf I 1.1	HC	Petrol	1093	4	2
08/79→07/83	Golf I 1.3	GF	Petrol	1272	4	7
08/82→12/83	Golf I 1.3	GS	Petrol	1272	4	7
08/77→07/83	Golf I 1.5	JB	Petrol	1457	4	27
08/76→07/80	Golf I 1.5 D	CK	Diesel	1471	4	10
01/83→02/84	Golf I 1.6	EW	Petrol	1595	4	30
08/75→02/84	Golf I 1.6	FN	Petrol	1588	4	29
08/75→02/84	Golf I 1.6	FP	Petrol	1588	4	27
08/75→07/77	Golf I 1.6	FT	Petrol	1588	4	26
01/83→02/84	Golf I 1.6	HN	Petrol	1595	4	30
08/80→07/83	Golf I 1.6 D	CR	Diesel	1588	4	10
08/80→07/83	Golf I 1.6 D	JK	Diesel	1588	4	10
08/76→07/82	Golf I 1.6 GTI	EG	Petrol	1588	4	28
03/82→07/83	Golf I 1.6 TD	CY	Diesel	1588	4	9
08/82→12/83	Golf I 1.8 GTI	DX	Petrol	1781	4	31
08/82→12/83	Golf I 1.8 GTI	JJ	Petrol	1781	4	31
08/83→07/86	Golf I Cabriolet 1.3	HK	Petrol	1272	4	4
01/79→11/83	Golf I Cabriolet 1.5	JB	Petrol	1457	4	27
08/79→07/82	Golf I Cabriolet 1.6	EG	Petrol	1588	4	28
08/83→04/92	Golf I Cabriolet 1.6	EW	Petrol	1595	4	30
08/83→04/92	Golf I Cabriolet 1.6	HN	Petrol	1595	4	30
04/86→02/90	Golf I Cabriolet 1.6	RE	Petrol	1595	4	30
08/82→12/92	Golf I Cabriolet 1.8	DX	Petrol	1781	4	31
08/82→12/89	Golf I Cabriolet 1.8	EV	Petrol	1781	4	31
08/83→09/92	Golf I Cabriolet 1.8	EX	Petrol	1781	4	31
08/83→04/93	Golf I Cabriolet 1.8	JH	Petrol	1781	4	31
08/82→12/89	Golf I Cabriolet 1.8	PB	Petrol	1781	4	31
08/89→03/93	Golf I Cabriolet 1.8	2H	Diesel	1781	4	31
11/83→08/85	Golf II 1.0	GN	Petrol	1043	4	4
08/85→10/91	Golf II 1.0	HZ	Petrol	1043	4	4
08/83→10/86	Golf II 1.3	GT	Petrol	1272	4	7
08/83→06/87	Golf II 1.3	HK	Petrol	1272	4	4
08/83→06/87	Golf II 1.3	MH	Petrol	1272	4	4
08/85→12/87	Golf II 1.3	NU	Petrol	1272	4	4
06/86→12/92	Golf II 1.3 CAT	2G	Petrol	1272	4	4
06/86→12/92	Golf II 1.3 CAT	MH	Petrol	1272	4	4
06/86→12/92	Golf II 1.3 CAT	NZ	Petrol	1272	4	4
08/83→07/92	Golf II 1.6	ABN	Petrol	1595	4	30
08/83→07/92	Golf II 1.6	EZ	Petrol	1595	4	30

MODEL INDEX

Modelverzeichnis • Index de modele • Índice de Modelo
Indeks modelu • Модель автомобиля • دليل الموديل



CCM

x



9

08/83→07/92	Golf II 1.6	HM	Petrol	1595	4	30
10/86→12/92	Golf II 1.6	PN	Diesel	1595	4	30
02/86→10/91	Golf II 1.6	RF	Diesel	1595	4	30
08/83→10/91	Golf II 1.6 D	JP	Diesel	1588	4	10
08/83→10/91	Golf II 1.6 D	ME	Diesel	1588	4	10
08/89→10/91	Golf II 1.6 TD	1V	Diesel	1588	4	9
08/83→10/91	Golf II 1.6 TD	JR	Diesel	1588	4	9
08/83→10/91	Golf II 1.6 TD	MF	Diesel	1588	4	9
04/89→10/91	Golf II 1.6 TD	RA	Diesel	1588	4	9
04/89→10/91	Golf II 1.6 TD	SB	Diesel	1588	4	9
08/84→10/91	Golf II 1.8	GU	Petrol	1781	4	31
08/84→10/91	Golf II 1.8	GX	Petrol	1781	4	31
08/84→10/91	Golf II 1.8	HV	Petrol	1781	4	31
08/86→01/90	Golf II 1.8	RH	Petrol	1781	4	31
08/83→10/91	Golf II 1.8 GTI	DX	Petrol	1781	4	31
08/83→10/91	Golf II 1.8 GTI	EV	Petrol	1781	4	31
08/83→10/91	Golf II 1.8 GTI	GZ	Petrol	1781	4	31
01/85→07/85	Golf II 1.8 GTI	HT	Petrol	1781	4	31
	Golf II 1.8 GTI	KT	Petrol	1781	4	31
08/83→10/91	Golf II 1.8 GTI	PB	Petrol	1781	4	31
08/85→10/87	Golf II 1.8 GTI	RD	Petrol	1781	4	30
01/85→07/85	Golf II 1.8 GTI	RV	Petrol	1781	4	31
	Golf II 1.8 GTI	RG	Diesel	1781	4	31
02/86→06/90	Golf II 1.8 GTI 16V	KR	Petrol	1781	4	31
02/86→10/91	Golf II 1.8 GTI 16V	PL	Petrol	1781	4	31
01/87→10/91	Golf II 1.8 GTI CAT	PF	Petrol	1781	4	31
04/90→07/91	Golf II 1.8 GTI G60	PG	Petrol	1781	4	31
08/88→07/91	Golf II 1.8 GTI G60 Syncro	PG	Petrol	1781	4	31
08/87→10/91	Golf II 1.8 i CAT	GX	Petrol	1781	4	31
08/87→10/91	Golf II 1.8 i CAT	RP	Petrol	1781	4	30
08/87→10/91	Golf II 1.8 i Syncro CAT	RP	Petrol	1781	4	30
08/88→07/91	Golf II 1.8 Syncro	1P	Petrol	1781	4	31
02/86→07/91	Golf II 1.8 Syncro	GU	Petrol	1781	4	31
02/86→07/91	Golf II 1.8 Syncro	GX	Petrol	1781	4	31
08/87→07/88	Golf II 1.8 Syncro	RH	Petrol	1781	4	31
08/91→07/92	Golf III 1.3	2G	Petrol	1272	4	4
10/91→08/97	Golf III 1.4	ABD	Petrol	1391	4	5
10/91→08/97	Golf III 1.4	AEX	Petrol	1390	4	12
09/92→08/97	Golf III 1.6	ABU	Petrol	1598	4	11
09/92→08/97	Golf III 1.6	AEA	Petrol	1598	4	12
09/92→08/97	Golf III 1.6	AEE	Petrol	1598	4	12
07/95→08/97	Golf III 1.6	AEK	Petrol	1595	4	35
07/95→08/97	Golf III 1.6	AFT	Petrol	1595	4	35
07/95→08/97	Golf III 1.6	AKS	Petrol	1588	4	35
11/91→08/97	Golf III 1.8	AAM	Petrol	1781	4	30
11/91→08/97	Golf III 1.8	ABS	Petrol	1781	4	31
11/91→08/97	Golf III 1.8	ACC	Petrol	1781	4	30
11/91→08/97	Golf III 1.8	ADZ	Petrol	1781	4	31
01/93→08/97	Golf III 1.8 Syncro	ABS	Petrol	1781	4	31
01/93→08/97	Golf III 1.8 Syncro	ADZ	Petrol	1781	4	31
11/91→08/97	Golf III 1.9 D	1Y	Diesel	1896	4	21
07/95→08/97	Golf III 1.9 SDI	AEY	Diesel	1896	4	22
11/91→08/97	Golf III 1.9 TD GTD	AAZ	Diesel	1896	4	21
09/93→08/97	Golf III 1.9 TDI	1Z	Diesel	1896	4	22
04/96→08/97	Golf III 1.9 TDI	AFN	Diesel	1896	4	22
09/93→08/97	Golf III 1.9 TDI	AHU	Diesel	1896	4	22
09/93→08/97	Golf III 1.9 TDI	ALE	Diesel	1896	4	22
08/95→08/97	Golf III 1.9 TDI Syncro	1Z	Diesel	1896	4	22
08/95→08/97	Golf III 1.9 TDI Syncro	AHU	Diesel	1896	4	22



CCM

x



08/95→08/97	Golf III 1.9 TDI Syncro	ALE	Diesel	1896	4	22
11/91→08/97	Golf III 2.0	2E	Petrol	1984	4	43
11/91→08/97	Golf III 2.0	ADY	Petrol	1984	4	43
11/91→08/97	Golf III 2.0	AGG	Petrol	1984	4	43
11/91→08/97	Golf III 2.0	AKR	Petrol	1984	4	43
08/95→09/97	Golf III 2.0 GL	AEP	Petrol	1984	4	43
08/92→08/97	Golf III 2.0 GTI 16V	ABF	Petrol	1984	4	43
08/95→08/97	Golf III 2.0 Syncro	AGG	Petrol	1984	4	43
01/92→09/97	Golf III 2.8 VR6	AAA	Petrol	2792	V6	32
10/94→08/97	Golf III 2.9 VR6 Syncro	ABV	Petrol	2861	V6	42
10/94→05/98	Golf III Cabriolet 1.6	AEK	Petrol	1595	4	35
10/94→05/98	Golf III Cabriolet 1.6	AFT	Petrol	1595	4	35
10/94→05/98	Golf III Cabriolet 1.6	AKS	Petrol	1588	4	35
07/93→05/98	Golf III Cabriolet 1.8	AAM	Petrol	1781	4	30
07/93→05/98	Golf III Cabriolet 1.8	ABS	Petrol	1781	4	31
07/93→05/98	Golf III Cabriolet 1.8	ADZ	Petrol	1781	4	31
08/95→05/98	Golf III Cabriolet 1.9 TDI	1Z	Diesel	1896	4	22
07/96→05/98	Golf III Cabriolet 1.9 TDI	AFN	Diesel	1896	4	22
08/95→05/98	Golf III Cabriolet 1.9 TDI	AHU	Diesel	1896	4	22
08/95→05/98	Golf III Cabriolet 1.9 TDI	ALE	Diesel	1896	4	22
07/93→05/98	Golf III Cabriolet 2.0	2E	Petrol	1984	4	43
07/93→05/98	Golf III Cabriolet 2.0	ADY	Petrol	1984	4	43
07/93→05/98	Golf III Cabriolet 2.0	AGG	Petrol	1984	4	43
07/93→05/98	Golf III Cabriolet 2.0	AKR	Petrol	1984	4	43
07/93→04/99	Golf III Variant 1.4	ABD	Petrol	1391	4	5
07/93→04/99	Golf III Variant 1.4	AEX	Petrol	1390	4	12
07/93→04/99	Golf III Variant 1.4	APQ	Petrol	1390	4	12
07/94→04/99	Golf III Variant 1.6	AEK	Petrol	1595	4	35
07/94→04/99	Golf III Variant 1.6	AFT	Petrol	1595	4	35
07/94→04/99	Golf III Variant 1.6	AKS	Petrol	1588	4	35
07/93→04/99	Golf III Variant 1.8	AAM	Petrol	1781	4	30
07/93→04/99	Golf III Variant 1.8	ABS	Petrol	1781	4	31
07/93→04/99	Golf III Variant 1.8	ADZ	Petrol	1781	4	31
07/93→04/99	Golf III Variant 1.8	ANN	Petrol	1781	4	31
07/93→04/99	Golf III Variant 1.8	ANP	Petrol	1781	4	31
10/94→04/99	Golf III Variant 1.8 Syncro	ADZ	Petrol	1781	4	31
07/93→04/99	Golf III Variant 1.9 D	1Y	Diesel	1896	4	21
07/95→04/99	Golf III Variant 1.9 SDI	AEY	Diesel	1896	4	22
07/93→04/99	Golf III Variant 1.9 TD	AAZ	Diesel	1896	4	21
03/94→04/99	Golf III Variant 1.9 TDI	1Z	Diesel	1896	4	22
04/96→04/99	Golf III Variant 1.9 TDI	AFN	Diesel	1896	4	22
03/94→04/99	Golf III Variant 1.9 TDI	AHU	Diesel	1896	4	22
03/94→04/99	Golf III Variant 1.9 TDI	ALE	Diesel	1896	4	22
07/95→04/99	Golf III Variant 1.9 TDI Syncro	1Z	Diesel	1896	4	22
07/95→04/99	Golf III Variant 1.9 TDI Syncro	AHU	Diesel	1896	4	22
07/95→04/99	Golf III Variant 1.9 TDI Syncro	ALE	Diesel	1896	4	22
07/93→04/99	Golf III Variant 2.0	2E	Petrol	1984	4	43
07/93→04/99	Golf III Variant 2.0	ADY	Petrol	1984	4	43
08/95→04/96	Golf III Variant 2.0	AEP	Petrol	1984	4	43
07/93→04/99	Golf III Variant 2.0	AGG	Petrol	1984	4	43
07/93→04/99	Golf III Variant 2.0	AKR	Petrol	1984	4	43
08/95→04/99	Golf III Variant 2.0 Syncro	AGG	Petrol	1984	4	43
10/94→04/99	Golf III Variant 2.9 VR6	ABV	Petrol	2861	V6	42
10/94→04/99	Golf III Variant 2.9 VR6 Syncro	ABV	Petrol	2861	V6	42
08/97→06/05	Golf IV 1.4 16V	AHW	Petrol	1390	4	13
08/97→06/05	Golf IV 1.4 16V	AKQ	Petrol	1390	4	13
08/97→06/05	Golf IV 1.4 16V	APE	Petrol	1390	4	13
08/97→06/05	Golf IV 1.4 16V	AXP	Petrol	1390	4	13
08/97→06/05	Golf IV 1.4 16V	BCA	Petrol	1390	4	15

MODEL INDEX

Modelverzeichnis • Index de modele • Índice de Modelo
Indeks modelu • Модель автомобиля • دليل الموديل



CCM



9

Year Range	Model Name	Code	Fuel Type	CCM	Filter	9
08/97→05/04	Golf IV 1.6	AEH	Petrol	1595	4	35
08/97→05/04	Golf IV 1.6	AKL	Petrol	1595	4	35
08/97→05/04	Golf IV 1.6	APF	Petrol	1595	4	35
08/00→06/05	Golf IV 1.6	AVU	Petrol	1595	4	38
08/00→06/05	Golf IV 1.6	BFQ	Petrol	1595	4	38
02/00→06/05	Golf IV 1.6 16V	ATN	Petrol	1595	4	13
02/00→06/05	Golf IV 1.6 16V	AUS	Petrol	1597	4	13
02/00→06/05	Golf IV 1.6 16V	AZD	Petrol	1597	4	13
02/00→06/05	Golf IV 1.6 16V	BCB	Petrol	1598	4	13
10/97→09/99	Golf IV 1.8	ACC	Petrol	1781	4	30
08/97→06/05	Golf IV 1.8	AGN	Petrol	1781	4	36
05/98→06/05	Golf IV 1.8 4motion	AGN	Petrol	1781	4	36
08/97→06/05	Golf IV 1.8 T	AGU	Petrol	1781	4	36
08/97→06/05	Golf IV 1.8 T	AQA	Petrol	1781	4	36
08/97→06/05	Golf IV 1.8 T	ARZ	Petrol	1781	4	36
08/97→06/05	Golf IV 1.8 T	AUM	Petrol	1781	4	36
08/97→06/05	Golf IV 1.8 T	AWD	Petrol	1781	4	36
08/01→06/05	Golf IV 1.8 T GTI	AUQ	Petrol	1781	4	36
08/97→06/05	Golf IV 1.9 SDI	AGP	Diesel	1896	4	22
08/97→06/05	Golf IV 1.9 SDI	AQM	Diesel	1896	4	22
10/97→09/99	Golf IV 1.9 TD	AAZ	Diesel	1896	4	21
10/97→05/04	Golf IV 1.9 TDI	AGR	Diesel	1896	4	22
08/97→05/04	Golf IV 1.9 TDI	AHF	Diesel	1896	4	22
12/98→06/01	Golf IV 1.9 TDI	AJM	Diesel	1896	4	22
10/97→05/04	Golf IV 1.9 TDI	ALH	Diesel	1896	4	22
05/00→06/05	Golf IV 1.9 TDI	ARL	Diesel	1896	4	22
08/97→05/04	Golf IV 1.9 TDI	ASV	Diesel	1896	4	22
11/00→06/05	Golf IV 1.9 TDI	ASZ	Diesel	1896	4	22
09/00→06/05	Golf IV 1.9 TDI	ATD	Diesel	1896	4	22
12/98→06/01	Golf IV 1.9 TDI	AUY	Diesel	1896	4	22
09/00→06/05	Golf IV 1.9 TDI	AXR	Diesel	1896	4	22
07/98→04/02	Golf IV 1.9 TDI 4motion	AGR	Diesel	1896	4	22
09/99→06/01	Golf IV 1.9 TDI 4motion	AJM	Diesel	1896	4	22
07/98→04/02	Golf IV 1.9 TDI 4motion	ALH	Diesel	1896	4	22
02/00→06/05	Golf IV 1.9 TDI 4motion	ARL	Diesel	1896	4	22
11/00→06/05	Golf IV 1.9 TDI 4motion	ASZ	Diesel	1896	4	22
09/00→06/05	Golf IV 1.9 TDI 4motion	ATD	Diesel	1896	4	22
09/99→06/01	Golf IV 1.9 TDI 4motion	AUY	Diesel	1896	4	22
07/98→05/04	Golf IV 2.0	APK	Petrol	1984	4	43
07/98→05/04	Golf IV 2.0	AQY	Petrol	1984	4	43
07/98→05/04	Golf IV 2.0	AZJ	Petrol	1984	4	43
10/00→06/05	Golf IV 2.0 4motion	AZH	Petrol	1984	4	43
10/00→06/05	Golf IV 2.0 4motion	AZJ	Petrol	1984	4	43
08/97→10/00	Golf IV 2.3 V5	AGZ	Petrol	2324	V5	32
10/00→06/05	Golf IV 2.3 V5	AQN	Petrol	2324	V5	32
12/98→10/00	Golf IV 2.3 V5 4motion	AGZ	Petrol	2324	V5	32
10/00→06/05	Golf IV 2.3 V5 4motion	AQN	Petrol	2324	V5	32
03/99→06/05	Golf IV 2.8 V6 4motion	AQP	Petrol	2792	V6	32
03/99→06/05	Golf IV 2.8 V6 4motion	AUE	Petrol	2792	V6	32
03/99→06/05	Golf IV 2.8 V6 4motion	BDE	Petrol	2792	V6	32
09/02→06/05	Golf IV 3.2 R32 4motion	BFH	Petrol	3189	V6	49
09/02→06/05	Golf IV 3.2 R32 4motion	BML	Petrol	3189	V6	49
	Golf IV 3.2 R32 4motion	BPF	Petrol	3189	V6	49
06/98→06/02	Golf IV Cabriolet 1.6	AFT	Petrol	1595	4	35
06/98→06/02	Golf IV Cabriolet 1.6	AKS	Petrol	1588	4	35
06/98→06/02	Golf IV Cabriolet 1.8	AAM	Petrol	1781	4	30
06/98→06/02	Golf IV Cabriolet 1.8	ADZ	Petrol	1781	4	31
06/98→06/02	Golf IV Cabriolet 1.8	ANN	Petrol	1781	4	31
06/98→06/02	Golf IV Cabriolet 1.8	ANP	Petrol	1781	4	31

Modelverzeichnis • Index de modele • Índice de Modelo
 Indeks modelu • Модель автомобиля • دليل الموديل

MODEL INDEX

CCM

x



06/98→06/02	Golf IV Cabriolet 1.9 TDI	AFN	Diesel	1896	4	22
06/98→06/02	Golf IV Cabriolet 1.9 TDI	AHU	Diesel	1896	4	22
06/98→06/02	Golf IV Cabriolet 1.9 TDI	ALE	Diesel	1896	4	22
06/98→06/02	Golf IV Cabriolet 1.9 TDI	AVG	Diesel	1896	4	22
06/98→06/02	Golf IV Cabriolet 2.0	AGG	Petrol	1984	4	43
06/98→06/02	Golf IV Cabriolet 2.0	AKR	Petrol	1984	4	43
05/99→06/06	Golf IV Variant 1.4 16V	AHW	Petrol	1390	4	13
05/99→06/06	Golf IV Variant 1.4 16V	AKQ	Petrol	1390	4	13
05/99→06/06	Golf IV Variant 1.4 16V	APE	Petrol	1390	4	13
05/99→06/06	Golf IV Variant 1.4 16V	AXP	Petrol	1390	4	13
05/99→06/06	Golf IV Variant 1.4 16V	BCA	Petrol	1390	4	15
05/99→04/02	Golf IV Variant 1.6	AEH	Petrol	1595	4	35
05/99→04/02	Golf IV Variant 1.6	AKL	Petrol	1595	4	35
05/99→04/02	Golf IV Variant 1.6	APF	Petrol	1595	4	35
08/00→06/06	Golf IV Variant 1.6	AVU	Petrol	1595	4	38
08/00→06/06	Golf IV Variant 1.6	BFQ	Petrol	1595	4	38
02/00→06/06	Golf IV Variant 1.6 16V	ATN	Petrol	1595	4	13
02/00→06/06	Golf IV Variant 1.6 16V	AUS	Petrol	1597	4	13
02/00→06/06	Golf IV Variant 1.6 16V	AZD	Petrol	1597	4	13
02/00→06/06	Golf IV Variant 1.6 16V	BCB	Petrol	1598	4	13
05/99→06/06	Golf IV Variant 1.8 4motion	AGN	Petrol	1781	4	36
05/00→06/06	Golf IV Variant 1.8 T	AGU	Petrol	1781	4	36
05/00→06/06	Golf IV Variant 1.8 T	AQA	Petrol	1781	4	36
05/00→06/06	Golf IV Variant 1.8 T	ARZ	Petrol	1781	4	36
05/00→06/06	Golf IV Variant 1.8 T	AUM	Petrol	1781	4	36
05/00→06/06	Golf IV Variant 1.8 T	AWD	Petrol	1781	4	36
05/99→06/06	Golf IV Variant 1.9 SDI	AGP	Diesel	1896	4	22
05/99→06/06	Golf IV Variant 1.9 SDI	AQM	Diesel	1896	4	22
05/99→05/06	Golf IV Variant 1.9 TDI	AGR	Diesel	1896	4	22
05/99→06/01	Golf IV Variant 1.9 TDI	AHF	Diesel	1896	4	22
08/99→06/01	Golf IV Variant 1.9 TDI	AJM	Diesel	1896	4	22
05/99→05/06	Golf IV Variant 1.9 TDI	ALH	Diesel	1896	4	22
05/99→06/01	Golf IV Variant 1.9 TDI	ASV	Diesel	1896	4	22
11/00→06/06	Golf IV Variant 1.9 TDI	ASZ	Diesel	1896	4	22
09/00→06/06	Golf IV Variant 1.9 TDI	ATD	Diesel	1896	4	22
08/99→06/01	Golf IV Variant 1.9 TDI	AUY	Diesel	1896	4	22
09/00→06/06	Golf IV Variant 1.9 TDI	AXR	Diesel	1896	4	22
05/99→04/02	Golf IV Variant 1.9 TDI 4motion	AGR	Diesel	1896	4	22
05/99→06/01	Golf IV Variant 1.9 TDI 4motion	AJM	Diesel	1896	4	22
05/99→04/02	Golf IV Variant 1.9 TDI 4motion	ALH	Diesel	1896	4	22
05/02→06/05	Golf IV Variant 1.9 TDI 4motion	ARL	Diesel	1896	4	22
11/00→06/06	Golf IV Variant 1.9 TDI 4motion	ASZ	Diesel	1896	4	22
09/00→06/06	Golf IV Variant 1.9 TDI 4motion	ATD	Diesel	1896	4	22
05/99→06/06	Golf IV Variant 2.0	APK	Petrol	1984	4	43
05/99→06/06	Golf IV Variant 2.0	AQY	Petrol	1984	4	43
05/99→06/06	Golf IV Variant 2.0	AZJ	Petrol	1984	4	43
10/00→06/06	Golf IV Variant 2.0 4motion	AZH	Petrol	1984	4	43
10/00→06/06	Golf IV Variant 2.0 4motion	AZJ	Petrol	1984	4	43
02/02→06/06	Golf IV Variant 2.0 Bi-Fuel	BEH	Petrol	1984	4	43
05/99→06/06	Golf IV Variant 2.3 V5	AGZ	Petrol	2324	V5	32
10/00→06/06	Golf IV Variant 2.3 V5	AQN	Petrol	2324	V5	32
05/99→06/06	Golf IV Variant 2.3 V5 4motion	AGZ	Petrol	2324	V5	32
10/00→06/06	Golf IV Variant 2.3 V5 4motion	AQN	Petrol	2324	V5	32
05/99→06/06	Golf IV Variant 2.8 V6 4motion	AQP	Petrol	2792	V6	32
05/99→06/06	Golf IV Variant 2.8 V6 4motion	AUE	Petrol	2792	V6	32
05/99→06/06	Golf IV Variant 2.8 V6 4motion	BDE	Petrol	2792	V6	32
01/05→	Golf Plus 1.4 16V	BCA	Petrol	1390	4	15
05/06→	Golf Plus 1.4 16V	BUD	Petrol	1390	4	16
05/06→	Golf Plus 1.4 16V	CGGA	Petrol	1390	4	16

MODEL INDEX

Modelverzeichnis • Index de modele • Índice de Modelo
 Indeks modelu • Модель автомобиля • دليل الموديل

CCM
x

9

05/06→06/08	Golf Plus 1.4 TSI	BLG	Petrol	1390	4	18
05/06→06/08	Golf Plus 1.4 TSI	BMV	Petrol	1390	4	18
06/08→	Golf Plus 1.4 TSI	CAVD	Petrol	1390	4	18
06/07→	Golf Plus 1.4 TSI	CAXA	Petrol	1390	4	17
06/08→	Golf Plus 1.4 TSI	CNWA	Petrol	1390	4	18
05/05→	Golf Plus 1.6	BSE	Petrol	1595	4	38
05/05→	Golf Plus 1.6	BSF	Petrol	1595	4	38
05/05→	Golf Plus 1.6	CCSA	Petrol	1595	4	38
01/05→05/08	Golf Plus 1.6 FSI	BLF	Petrol	1598	4	17
11/07→	Golf Plus 1.6 MultiFuel	CCSA	Petrol	1595	4	38
02/09→	Golf Plus 1.6 TDI	CAYB	Diesel	1598	4	25
03/09→	Golf Plus 1.6 TDI	CAYC	Diesel	1598	4	25
01/05→01/09	Golf Plus 1.9 TDI	BKC	Diesel	1896	4	24
01/05→01/09	Golf Plus 1.9 TDI	BLS	Diesel	1896	4	24
05/05→12/08	Golf Plus 1.9 TDI	BRU	Diesel	1896	4	24
01/05→01/09	Golf Plus 1.9 TDI	BXE	Diesel	1896	4	24
05/05→12/08	Golf Plus 1.9 TDI	BXF	Diesel	1896	4	24
05/05→12/08	Golf Plus 1.9 TDI	BXJ	Diesel	1896	4	24
05/05→06/08	Golf Plus 2.0 FSI	BLR	Petrol	1984	4	44
05/05→06/08	Golf Plus 2.0 FSI	BLY	Petrol	1984	4	44
05/05→06/08	Golf Plus 2.0 FSI	BVY	Petrol	1984	4	44
05/05→06/08	Golf Plus 2.0 FSI	BVZ	Petrol	1984	4	44
05/05→	Golf Plus 2.0 TDI	AZV	Diesel	1968	4	39
05/05→05/07	Golf Plus 2.0 TDI	BEE	Diesel	1968	4	39
12/05→05/09	Golf Plus 2.0 TDI	BMM	Diesel	1968	4	39
05/05→	Golf Plus 2.0 TDI	CBDA	Diesel	1968	4	41
01/09→	Golf Plus 2.0 TDI	CBDC	Diesel	1968	4	41
05/05→	Golf Plus 2.0 TDI	CFHB	Diesel	1968	4	41
01/09→	Golf Plus 2.0 TDI	CLCA	Diesel	1968	4	41
01/05→	Golf Plus 2.0 TDI 16V	BKD	Diesel	1968	4	39
01/05→	Golf Plus 2.0 TDI 16V	CBDB	Diesel	1968	4	41
01/05→	Golf Plus 2.0 TDI 16V	CFHC	Diesel	1968	4	41
10/03→05/06	Golf V 1.4 16V	BCA	Petrol	1390	4	15
05/06→11/08	Golf V 1.4 16V	BUD	Petrol	1390	4	16
11/05→11/08	Golf V 1.4 TSI	BLG	Petrol	1390	4	18
05/06→11/08	Golf V 1.4 TSI	BMV	Petrol	1390	4	18
05/07→11/08	Golf V 1.4 TSI	CAXA	Petrol	1390	4	17
01/04→11/08	Golf V 1.6	BGU	Petrol	1595	4	38
01/04→11/08	Golf V 1.6	BSE	Petrol	1595	4	38
01/04→11/08	Golf V 1.6	BSF	Petrol	1595	4	38
10/03→07/08	Golf V 1.6 FSI	BLF	Petrol	1598	4	17
10/03→07/08	Golf V 1.6 FSI	BLP	Petrol	1598	4	17
10/07→11/08	Golf V 1.6 MultiFuel	CCSA	Petrol	1595	4	38
10/03→11/08	Golf V 1.9 TDI	BKC	Diesel	1896	4	24
10/03→11/08	Golf V 1.9 TDI	BLS	Diesel	1896	4	24
05/04→11/08	Golf V 1.9 TDI	BRU	Diesel	1896	4	24
10/03→11/08	Golf V 1.9 TDI	BXE	Diesel	1896	4	24
05/04→11/08	Golf V 1.9 TDI	BXF	Diesel	1896	4	24
05/04→11/08	Golf V 1.9 TDI	BXJ	Diesel	1896	4	24
08/04→11/08	Golf V 1.9 TDI 4motion	BKC	Diesel	1896	4	24
08/04→11/08	Golf V 1.9 TDI 4motion	BLS	Diesel	1896	4	24
08/04→11/08	Golf V 1.9 TDI 4motion	BXE	Diesel	1896	4	24
01/04→11/08	Golf V 2.0 FSI	AXW	Petrol	1984	4	44
01/04→11/08	Golf V 2.0 FSI	BLR	Petrol	1984	4	44
01/04→11/08	Golf V 2.0 FSI	BLX	Petrol	1984	4	44
01/04→11/08	Golf V 2.0 FSI	BLY	Petrol	1984	4	44
01/04→11/08	Golf V 2.0 FSI	BVX	Petrol	1984	4	44
01/04→11/08	Golf V 2.0 FSI	BVY	Petrol	1984	4	44
01/04→11/08	Golf V 2.0 FSI	BVZ	Petrol	1984	4	44



CCM

x



08/04→11/08	Golf V 2.0 FSI 4motion	BLX	Petrol	1984	4	44
08/04→11/08	Golf V 2.0 FSI 4motion	BVX	Petrol	1984	4	44
10/04→02/09	Golf V 2.0 GTI	AXX	Petrol	1984	4	44
10/04→02/09	Golf V 2.0 GTI	BPY	Petrol	1984	4	44
10/04→02/09	Golf V 2.0 GTI	BWA	Petrol	1984	4	44
01/04→11/08	Golf V 2.0 SDI	BDK	Diesel	1968	4	39
10/03→11/08	Golf V 2.0 TDI	AZV	Diesel	1968	4	39
12/04→11/08	Golf V 2.0 TDI	BMM	Diesel	1968	4	39
11/05→11/08	Golf V 2.0 TDI	BMN	Diesel	1968	4	39
10/03→11/08	Golf V 2.0 TDI	CBDA	Diesel	1968	4	41
10/03→11/08	Golf V 2.0 TDI 16V	BKD	Diesel	1968	4	39
08/04→11/08	Golf V 2.0 TDI 16V 4motion	BKD	Diesel	1968	4	39
08/04→11/08	Golf V 2.0 TDI 4motion	BMM	Diesel	1968	4	39
09/05→11/08	Golf V 3.2	BUB	Petrol	3189	V6	49
11/05→11/08	Golf V 3.2 R32 4motion	BUB	Petrol	3189	V6	49
11/05→11/08	Golf V 3.2 R32 4motion	CBR	Petrol	3189	V6	49
11/05→11/08	Golf V 3.2 R32 4motion	CBRA	Petrol	3189	V6	49
06/07→	Golf V Variant 1.4	BUD	Petrol	1390	4	16
06/07→	Golf V Variant 1.4 TSI	BLG	Petrol	1390	4	18
06/07→	Golf V Variant 1.4 TSI	BMY	Petrol	1390	4	18
07/08→	Golf V Variant 1.4 TSI	CAVD	Petrol	1390	4	18
06/07→	Golf V Variant 1.4 TSI	CAXA	Petrol	1390	4	17
06/07→	Golf V Variant 1.6	BSE	Petrol	1595	4	38
06/07→	Golf V Variant 1.6	BSF	Petrol	1595	4	38
06/07→	Golf V Variant 1.6	CCSA	Petrol	1595	4	38
11/07→	Golf V Variant 1.6 MultiFuel	CCSA	Petrol	1595	4	38
06/07→	Golf V Variant 1.9 TDI	BLS	Diesel	1896	4	24
06/07→	Golf V Variant 1.9 TDI	BXE	Diesel	1896	4	24
01/08→	Golf V Variant 1.9 TDI 4motion	BLS	Diesel	1896	4	24
06/07→	Golf V Variant 2.0	BWA	Petrol	1984	4	44
06/07→	Golf V Variant 2.0 TDI	AZV	Diesel	1968	4	39
06/07→	Golf V Variant 2.0 TDI	BMM	Diesel	1968	4	39
06/07→	Golf V Variant 2.0 TDI 16V	BKD	Diesel	1968	4	39
06/07→	Golf V Variant 2.0 TDI 16V	CBDB	Diesel	1968	4	41
06/07→	Golf V Variant 2.0 TDI 4motion	AZV	Diesel	1968	4	39
10/08→11/12	Golf VI 1.4	CGGA	Petrol	1390	4	16
10/08→11/12	Golf VI 1.4 TSI	CAVD	Petrol	1390	4	18
10/08→11/12	Golf VI 1.4 TSI	CAXA	Petrol	1390	4	17
10/08→11/12	Golf VI 1.4 TSI	CNWA	Petrol	1390	4	18
10/08→11/12	Golf VI 1.6	BSE	Petrol	1595	4	38
10/08→11/12	Golf VI 1.6	BSF	Petrol	1595	4	38
10/08→11/12	Golf VI 1.6	CCSA	Petrol	1595	4	38
10/08→11/12	Golf VI 1.6 MultiFuel	CCSA	Petrol	1595	4	38
02/09→11/12	Golf VI 1.6 TDI	CAYB	Diesel	1598	4	25
02/09→11/12	Golf VI 1.6 TDI	CAYC	Diesel	1598	4	25
10/08→11/12	Golf VI 2.0 TDI	CBAA	Diesel	1968	4	41
10/08→05/13	Golf VI 2.0 TDI	CBAB	Diesel	1968	4	41
04/09→11/12	Golf VI 2.0 TDI	CBBB	Diesel	1968	4	41
10/08→11/12	Golf VI 2.0 TDI	CBDC	Diesel	1968	4	41
10/08→11/12	Golf VI 2.0 TDI	CFFA	Diesel	1968	4	41
10/08→05/13	Golf VI 2.0 TDI	CFFB	Diesel	1968	4	41
04/09→11/12	Golf VI 2.0 TDI	CFGB	Diesel	1968	4	41
10/08→05/13	Golf VI 2.0 TDI	CJAA	Diesel	1968	4	40
10/08→11/12	Golf VI 2.0 TDI	CLCA	Diesel	1968	4	41
05/09→11/12	Golf VI 2.0 TDI 4motion	CBAB	Diesel	1968	4	41
05/09→11/12	Golf VI 2.0 TDI 4motion	CFFB	Diesel	1968	4	41
03/11→	Golf VI Convertible 1.4 TSI	CAVD	Petrol	1390	4	18
11/11→	Golf VI Convertible 1.4 TSI	CAXA	Petrol	1390	4	17
03/11→	Golf VI Convertible 1.4 TSI	CNWA	Petrol	1390	4	18

MODEL INDEX

Modelverzeichnis • Index de modele • Índice de Modelo
Indeks modelu • Модель автомобиля • دليل الموديل



CCM

x



9

03/11→	Golf VI Convertible 1.6 TDI	CAYC	Diesel	1598	4	25
11/11→	Golf VI Convertible 2.0 TDI	CFHC	Diesel	1968	4	41
07/09→	Golf VI Variant 1.4	BUD	Petrol	1390	4	16
07/09→	Golf VI Variant 1.4	CGGA	Petrol	1390	4	16
07/09→	Golf VI Variant 1.4 TSI	CAVD	Petrol	1390	4	18
07/09→	Golf VI Variant 1.4 TSI	CAXA	Petrol	1390	4	17
07/09→	Golf VI Variant 1.4 TSI	CNWA	Petrol	1390	4	18
07/09→	Golf VI Variant 1.6	BSE	Petrol	1595	4	38
07/09→	Golf VI Variant 1.6	BSF	Petrol	1595	4	38
07/09→	Golf VI Variant 1.6	CCSA	Petrol	1595	4	38
12/09→	Golf VI Variant 1.6 TDI	CAYB	Diesel	1598	4	25
07/09→	Golf VI Variant 1.6 TDI	CAYC	Diesel	1598	4	25
07/09→	Golf VI Variant 1.6 TDI 4motion	CAYC	Diesel	1598	4	25
07/09→	Golf VI Variant 2.0 TDI	BMM	Diesel	1968	4	39
07/09→	Golf VI Variant 2.0 TDI	CBDA	Diesel	1968	4	41
07/09→	Golf VI Variant 2.0 TDI	CFHB	Diesel	1968	4	41
01/10→	Golf VI Variant 2.0 TDI	CLCA	Diesel	1968	4	41
07/09→	Golf VI Variant 2.0 TDI 16V	CBDB	Diesel	1968	4	41
07/09→	Golf VI Variant 2.0 TDI 16V	CFHC	Diesel	1968	4	41
07/09→	Golf VI Variant 2.0 TDI 16V	CJAA	Diesel	1968	4	40
07/09→	Golf VI Variant 2.0 TDI 16V	CLCB	Diesel	1968	4	41
01/65→12/79	Industrial Eng. 126	211, 311	Petrol	1584	B4	51
08/79→07/80	Jetta 1.5	GH	Petrol	1457	4	27
08/79→07/80	Jetta 1.6	EJ	Petrol	1588	4	27
08/85→07/87	Jetta 1.6i	EZA	Petrol	1595	4	30
08/80→02/84	Jetta 1.7	EN	Petrol	1716	4	27
08/78→02/84	Jetta I 1.1	FA	Petrol	1093	4	2
08/78→02/84	Jetta I 1.1	GG	Petrol	1093	4	2
08/79→02/84	Jetta I 1.3	GF	Petrol	1272	4	7
08/82→02/84	Jetta I 1.3	GS	Petrol	1272	4	7
08/78→02/84	Jetta I 1.5	JB	Petrol	1457	4	27
08/78→07/80	Jetta I 1.5 D	CK	Diesel	1471	4	10
08/82→07/83	Jetta I 1.6	EW	Petrol	1595	4	30
08/78→02/84	Jetta I 1.6	FR	Diesel	1588	4	27
08/80→02/84	Jetta I 1.6 D	CR	Diesel	1588	4	10
08/80→02/84	Jetta I 1.6 D	JK	Diesel	1588	4	10
08/78→07/82	Jetta I 1.6 GLI	EG	Petrol	1588	4	28
03/82→02/84	Jetta I 1.6 TD	CY	Diesel	1588	4	9
08/82→02/84	Jetta I 1.8	DX	Petrol	1781	4	31
08/82→02/84	Jetta I 1.8	JJ	Petrol	1781	4	31
01/84→10/86	Jetta II 1.3	GT	Petrol	1272	4	7
01/84→06/87	Jetta II 1.3	HK	Petrol	1272	4	4
01/84→06/87	Jetta II 1.3	MH	Petrol	1272	4	4
06/87→12/91	Jetta II 1.3 CAT	2G	Petrol	1272	4	4
06/87→12/91	Jetta II 1.3 CAT	MH	Petrol	1272	4	4
06/87→12/91	Jetta II 1.3 CAT	NZ	Petrol	1272	4	4
01/84→07/92	Jetta II 1.6	ABN	Petrol	1595	4	30
01/84→07/92	Jetta II 1.6	EZ	Petrol	1595	4	30
01/84→07/92	Jetta II 1.6	HM	Petrol	1595	4	30
10/86→10/91	Jetta II 1.6	PN	Diesel	1595	4	30
03/86→10/91	Jetta II 1.6	RF	Diesel	1595	4	30
01/84→10/91	Jetta II 1.6 D	JP	Diesel	1588	4	10
01/84→10/91	Jetta II 1.6 D	ME	Diesel	1588	4	10
01/90→10/91	Jetta II 1.6 TD	1V	Diesel	1588	4	9
01/84→10/91	Jetta II 1.6 TD	JR	Diesel	1588	4	9
01/84→10/91	Jetta II 1.6 TD	MF	Diesel	1588	4	9
04/89→10/91	Jetta II 1.6 TD	RA	Diesel	1588	4	9
04/89→10/91	Jetta II 1.6 TD	SB	Diesel	1588	4	9
01/84→10/91	Jetta II 1.8	EV	Petrol	1781	4	31

Modelverzeichnis • Index de modele • Índice de Modelo
 Indeks modelu • Модель автомобиля • دليل الموديل

MODEL INDEX

CCM
x

9

08/84→10/91	Jetta II 1.8	GU	Petrol	1781	4	31
08/84→10/91	Jetta II 1.8	GX	Petrol	1781	4	31
01/84→10/91	Jetta II 1.8	GZ	Petrol	1781	4	31
08/84→10/91	Jetta II 1.8	HV	Petrol	1781	4	31
01/84→10/91	Jetta II 1.8	PB	Petrol	1781	4	31
08/85→10/87	Jetta II 1.8	RD	Petrol	1781	4	30
08/86→01/90	Jetta II 1.8	RH	Petrol	1781	4	31
06/87→12/89	Jetta II 1.8 16V	KR	Petrol	1781	4	31
08/86→10/91	Jetta II 1.8 16V	PL	Petrol	1781	4	31
08/87→10/91	Jetta II 1.8 CAT	GX	Petrol	1781	4	31
01/87→10/91	Jetta II 1.8 CAT	PF	Petrol	1781	4	31
08/87→10/91	Jetta II 1.8 CAT	RP	Petrol	1781	4	30
08/88→07/91	Jetta II 1.8 Syncro	1P	Petrol	1781	4	31
08/87→12/88	Jetta II 1.8 Syncro	GU	Petrol	1781	4	31
08/87→07/88	Jetta II 1.8 Syncro	RH	Petrol	1781	4	31
08/87→12/88	Jetta II 1.8 Syncro	RP	Petrol	1781	4	30
07/06→10/10	Jetta III 1.4 TSI	BLG	Petrol	1390	4	18
07/06→10/10	Jetta III 1.4 TSI	BMV	Petrol	1390	4	18
07/08→10/10	Jetta III 1.4 TSI	CAVD	Petrol	1390	4	18
05/07→10/10	Jetta III 1.4 TSI	CAXA	Petrol	1390	4	17
10/05→10/10	Jetta III 1.6	BGU	Petrol	1595	4	38
10/05→10/10	Jetta III 1.6	BSE	Petrol	1595	4	38
10/05→10/10	Jetta III 1.6	BSF	Petrol	1595	4	38
10/05→10/10	Jetta III 1.6	CCSA	Petrol	1595	4	38
09/05→10/10	Jetta III 1.6 FSI	BLF	Petrol	1598	4	17
01/08→10/10	Jetta III 1.6 MultiFuel	CCSA	Petrol	1595	4	38
12/09→10/10	Jetta III 1.6 TDI	CAYB	Diesel	1598	4	25
06/09→10/10	Jetta III 1.6 TDI	CAYC	Diesel	1598	4	25
08/05→10/10	Jetta III 1.9 TDI	BKC	Diesel	1896	4	24
08/05→10/10	Jetta III 1.9 TDI	BLS	Diesel	1896	4	24
08/05→10/10	Jetta III 1.9 TDI	BXE	Diesel	1896	4	24
08/05→10/10	Jetta III 2.0 FSI	BLR	Petrol	1984	4	44
08/05→10/10	Jetta III 2.0 FSI	BLX	Petrol	1984	4	44
08/05→10/10	Jetta III 2.0 FSI	BLY	Petrol	1984	4	44
08/05→10/10	Jetta III 2.0 FSI	BVY	Petrol	1984	4	44
08/05→10/10	Jetta III 2.0 FSI	BVZ	Petrol	1984	4	44
09/05→10/10	Jetta III 2.0 TDI	AZV	Diesel	1968	4	39
10/05→10/10	Jetta III 2.0 TDI	BMM	Diesel	1968	4	39
10/06→10/10	Jetta III 2.0 TDI	BMN	Diesel	1968	4	39
09/05→10/10	Jetta III 2.0 TDI	CBDA	Diesel	1968	4	41
10/06→10/10	Jetta III 2.0 TDI	CEGA	Diesel	1968	4	41
08/05→10/10	Jetta III 2.0 TDI 16V	BKD	Diesel	1968	4	39
08/05→10/10	Jetta III 2.0 TDI 16V	CBDB	Diesel	1968	4	41
08/05→10/10	Jetta III 2.0 TDI 16V	CJAA	Diesel	1968	4	40
10/05→10/10	Jetta III 2.0 TFSI	AXX	Petrol	1984	4	44
10/05→10/10	Jetta III 2.0 TFSI	BPY	Petrol	1984	4	44
10/05→10/10	Jetta III 2.0 TFSI	BWA	Petrol	1984	4	44
04/11→	Jetta IV 1.4 TSI	CAVA	Petrol	1390	4	18
04/11→	Jetta IV 1.4 TSI	CAVD	Petrol	1390	4	18
05/11→	Jetta IV 1.4 TSI	CAXA	Petrol	1390	4	17
05/11→	Jetta IV 1.4 TSI	CMSB	Petrol	1390	4	17
04/11→	Jetta IV 1.4 TSI	CTHA	Petrol	1390	4	18
02/11→	Jetta IV 1.6 TDI	CAYC	Diesel	1598	4	25
06/10→	Jetta IV 2.0	CBPA	Petrol	1984	4	43
02/11→	Jetta IV 2.0 TDI	CFFB	Diesel	1968	4	41
02/11→	Jetta IV 2.0 TDI	CFHC	Diesel	1968	4	41
02/11→	Jetta IV 2.0 TDI	CJAA	Diesel	1968	4	40
10/10→	Jetta IV 2.0 TDI	CLCA	Diesel	1968	4	41
02/11→	Jetta IV 2.0 TDI	CLCB	Diesel	1968	4	41

MODEL INDEX

Modelverzeichnis • Index de modele • Índice de Modelo
Indeks modelu • Модель автомобиля • دليل الموديل



CCM

x



9

01/60→12/85	Kaefer 1200 1.2	D	Diesel	1192	B4	19
01/70→01/73	Kaefer 1300 1.3	AB	Petrol	1285	B4	19
08/65→07/70	Kaefer 1300 1.3	E	Petrol	1285	B4	19
01/65→07/70	Kaefer 1300 1.3	F	Petrol	1285	B4	19
08/69→08/72	Kaefer 1302 1.2	D	Diesel	1192	B4	19
08/70→08/72	Kaefer 1302 1.3	AB	Petrol	1285	B4	19
07/71→07/74	Kaefer 1302 1.6	AE	Petrol	1584	B4	51
07/71→07/74	Kaefer 1302 1.6	AH	Petrol	1584	B4	51
07/71→07/74	Kaefer 1302 1.6	AK	Petrol	1584	B4	51
07/72→02/76	Kaefer 1303 1.2	D	Diesel	1192	B4	19
08/72→07/75	Kaefer 1303 1.3	AB	Petrol	1285	B4	19
08/72→12/79	Kaefer 1303 LS, S 1.6	AJ	Petrol	1584	B4	51
08/72→12/79	Kaefer 1303 LS, S 1.6	AS	Petrol	1584	B4	51
08/66→11/73	Kaefer 1500 1.5	H	Diesel	1493	B4	48
10/92→07/03	Kaefer 1600 i	ACD	Petrol	1584	B4	52
04/75→12/79	Kaefer Convertible 1303 1.2	D	Diesel	1192	B4	19
07/70→03/81	Kaefer Convertible 1303 1.3	AB	Petrol	1285	B4	19
08/70→07/74	Kaefer Convertible 1303 1.6	AE	Petrol	1584	B4	51
08/70→07/74	Kaefer Convertible 1303 1.6	AH	Petrol	1584	B4	51
08/70→07/74	Kaefer Convertible 1303 1.6	AK	Petrol	1584	B4	51
01/66→12/70	Kaefer Convertible 1500 1.5	H	Diesel	1493	B4	48
07/69→07/70	Kaefer Convertible 1500 1.6	B	Diesel	1584	B4	51
07/64→07/70	Kaefer Convertible Karmann 1.3	F	Petrol	1285	B4	19
09/57→12/64	Karmann Ghia Convertible 1200	D	Diesel	1192	B4	19
07/64→07/74	Karmann Ghia Convertible 1500	F	Petrol	1285	B4	19
01/66→12/69	Karmann Ghia Convertible 1500	H	Diesel	1493	B4	48
07/70→07/74	Karmann Ghia Coupe 1300	AB	Petrol	1285	B4	19
01/66→12/69	Karmann Ghia Coupe 1500	H	Diesel	1493	B4	48
07/71→07/74	Karmann Ghia Coupe 1600	AL	Petrol	1584	B4	51
04/75→09/83	LT 28-35 I Box 2.0	CH	Petrol	1984	4	53
07/90→05/96	LT 28-35 I Box 2.4 D	1S	Diesel	2383	6	10
07/90→05/96	LT 28-35 I Box 2.4 D	ACT	Diesel	2384	6	10
01/79→07/92	LT 28-35 I Box 2.4 D	CP	Diesel	2383	6	10
01/79→07/92	LT 28-35 I Box 2.4 D	DW	Diesel	2383	6	10
08/88→08/92	LT 28-35 I Box 2.4 TD	1G	Diesel	2383	6	9
06/92→05/96	LT 28-35 I Box 2.4 TD	ACL	Diesel	2384	6	9
02/86→08/92	LT 28-35 I Box 2.4 TD	DV	Diesel	2383	6	9
08/92→04/96	LT 28-35 I Box 2.4 TD Syncro	ACL	Diesel	2384	6	9
04/75→09/83	LT 28-35 I Bus 2.0	CH	Petrol	1984	4	53
08/89→06/96	LT 28-35 I Bus 2.4 D	1S	Diesel	2383	6	10
08/89→06/96	LT 28-35 I Bus 2.4 D	ACT	Diesel	2384	6	10
01/79→07/92	LT 28-35 I Bus 2.4 D	CP	Diesel	2383	6	10
01/79→07/92	LT 28-35 I Bus 2.4 D	DW	Diesel	2383	6	10
08/89→08/92	LT 28-35 I Bus 2.4 TD	1G	Diesel	2383	6	9
09/92→06/96	LT 28-35 I Bus 2.4 TD	ACL	Diesel	2384	6	9
12/82→07/89	LT 28-35 I Bus 2.4 TD	DV	Diesel	2383	6	9
08/91→07/92	LT 28-35 I Platform/Chassis 2.4 TD Syncro	1G	Diesel	2383	6	9
08/92→04/96	LT 28-35 I Platform/Chassis 2.4 TD Syncro	ACL	Diesel	2384	6	9
08/91→07/92	LT 28-35 I Platform/Chassis 2.4 TD Syncro	DV	Diesel	2383	6	9
04/75→09/83	LT 28-35 I Platform/Chassis 2.0	CH	Petrol	1984	4	53
08/90→06/96	LT 28-35 I Platform/Chassis 2.4 D	1S	Diesel	2383	6	10
08/90→06/96	LT 28-35 I Platform/Chassis 2.4 D	ACT	Diesel	2384	6	10
12/78→02/91	LT 28-35 I Platform/Chassis 2.4 D	CP	Diesel	2383	6	10
12/78→02/91	LT 28-35 I Platform/Chassis 2.4 D	DW	Diesel	2383	6	10
08/91→07/92	LT 28-35 I Platform/Chassis 2.4 D Syncro	1S	Diesel	2383	6	10
08/91→07/92	LT 28-35 I Platform/Chassis 2.4 D Syncro	DW	Diesel	2383	6	10
08/90→08/92	LT 28-35 I Platform/Chassis 2.4 TD	1G	Diesel	2383	6	9
08/92→06/96	LT 28-35 I Platform/Chassis 2.4 TD	ACL	Diesel	2384	6	9
12/82→09/93	LT 28-35 I Platform/Chassis 2.4 TD	DV	Diesel	2383	6	9



CCM

x



9

07/96→07/06	LT 28-35 II Bus 2.5 SDI	AGX	Diesel	2459	5	34
05/96→08/99	LT 28-35 II Bus 2.5 TDI	AHD	Diesel	2459	5	34
05/99→07/06	LT 28-35 II Bus 2.5 TDI	ANJ	Diesel	2461	5	34
05/99→07/06	LT 28-35 II Bus 2.5 TDI	APA	Diesel	2461	5	34
05/99→07/06	LT 28-35 II Bus 2.5 TDI	AVR	Diesel	2461	5	34
05/01→07/06	LT 28-35 II Bus 2.5 TDI	BBE	Diesel	2461	5	34
05/01→07/06	LT 28-35 II Bus 2.5 TDI	BBF	Diesel	2461	5	34
05/99→07/06	LT 28-35 II Bus 2.5 TDI	BBR	Diesel	2461	5	34
02/97→12/98	LT 28-35 II Bus 2.8 TDI	AGK	Diesel	2799	4	56
01/99→01/02	LT 28-35 II Bus 2.8 TDI	ATA	Diesel	2799	4	56
05/01→06/06	LT 28-35 II Bus 2.8 TDI	BCQ	Diesel	2798	4	56
09/96→07/06	LT 28-46 II Box 2.5 SDI	AGX	Diesel	2459	5	34
05/96→08/99	LT 28-46 II Box 2.5 TDI	AHD	Diesel	2459	5	34
05/99→07/06	LT 28-46 II Box 2.5 TDI	ANJ	Diesel	2461	5	34
05/99→07/06	LT 28-46 II Box 2.5 TDI	APA	Diesel	2461	5	34
05/99→07/06	LT 28-46 II Box 2.5 TDI	AVR	Diesel	2461	5	34
05/01→07/06	LT 28-46 II Box 2.5 TDI	BBE	Diesel	2461	5	34
05/01→07/06	LT 28-46 II Box 2.5 TDI	BBF	Diesel	2461	5	34
06/97→12/98	LT 28-46 II Box 2.8 TDI	AGK	Diesel	2799	4	56
01/99→07/06	LT 28-46 II Box 2.8 TDI	ATA	Diesel	2799	4	56
04/02→07/06	LT 28-46 II Box 2.8 TDI	AUH	Diesel	2799	4	56
04/02→07/06	LT 28-46 II Box 2.8 TDI	BCQ	Diesel	2798	4	56
05/99→07/06	LT 28-46 II Bus 2.5 TDI	BBR	Diesel	2461	5	34
09/96→07/06	LT 28-46 II Platform/Chassis 2.5 SDI	AGX	Diesel	2459	5	34
06/96→08/99	LT 28-46 II Platform/Chassis 2.5 TDI	AHD	Diesel	2459	5	34
05/99→07/06	LT 28-46 II Platform/Chassis 2.5 TDI	ANJ	Diesel	2461	5	34
05/99→07/06	LT 28-46 II Platform/Chassis 2.5 TDI	APA	Diesel	2461	5	34
05/99→07/06	LT 28-46 II Platform/Chassis 2.5 TDI	AVR	Diesel	2461	5	34
05/01→07/06	LT 28-46 II Platform/Chassis 2.5 TDI	BBE	Diesel	2461	5	34
05/01→07/06	LT 28-46 II Platform/Chassis 2.5 TDI	BBF	Diesel	2461	5	34
05/99→07/06	LT 28-46 II Platform/Chassis 2.5 TDI	BBR	Diesel	2461	5	34
06/97→12/98	LT 28-46 II Platform/Chassis 2.8 TDI	AGK	Diesel	2799	4	56
01/99→07/06	LT 28-46 II Platform/Chassis 2.8 TDI	ATA	Diesel	2799	4	56
04/02→07/06	LT 28-46 II Platform/Chassis 2.8 TDI	AUH	Diesel	2799	4	56
04/02→07/06	LT 28-46 II Platform/Chassis 2.8 TDI	BCQ	Diesel	2798	4	56
04/75→09/83	LT 40-55 I Box 2.0	CH	Petrol	1984	4	53
07/90→05/96	LT 40-55 I Box 2.4 D	1S	Diesel	2383	6	10
07/90→05/96	LT 40-55 I Box 2.4 D	ACT	Diesel	2384	6	10
01/79→07/92	LT 40-55 I Box 2.4 D	CP	Diesel	2383	6	10
01/79→07/92	LT 40-55 I Box 2.4 D	DW	Diesel	2383	6	10
01/79→03/86	LT 40-55 I Box 2.4 D 4WD	DW	Diesel	2383	6	10
08/88→08/92	LT 40-55 I Box 2.4 TD	1G	Diesel	2383	6	9
06/92→05/96	LT 40-55 I Box 2.4 TD	ACL	Diesel	2384	6	9
02/86→08/92	LT 40-55 I Box 2.4 TD	DV	Diesel	2383	6	9
08/78→07/92	LT 40-55 I Box 2.4 TD 4WD	DV	Diesel	2383	6	9
08/92→04/96	LT 40-55 I Box 2.4 TD Syncro	ACL	Diesel	2384	6	9
04/75→09/83	LT 40-55 I Platform/Chassis 2.0	CH	Petrol	1984	4	53
08/91→07/92	LT 40-55 I Platform/Chassis 2.4 TD Syncro	1G	Diesel	2383	6	9
08/92→04/96	LT 40-55 I Platform/Chassis 2.4 TD Syncro	ACL	Diesel	2384	6	9
08/91→07/92	LT 40-55 I Platform/Chassis 2.4 TD Syncro	DV	Diesel	2383	6	9
08/90→06/96	LT 40-55 I Platform/Chassis 2.4 D	1S	Diesel	2383	6	10
08/90→06/96	LT 40-55 I Platform/Chassis 2.4 D	ACT	Diesel	2384	6	10
12/78→02/91	LT 40-55 I Platform/Chassis 2.4 D	CP	Diesel	2383	6	10
12/78→02/91	LT 40-55 I Platform/Chassis 2.4 D	DW	Diesel	2383	6	10
08/88→07/91	LT 40-55 I Platform/Chassis 2.4 TD	1G	Diesel	2383	6	9
08/92→06/96	LT 40-55 I Platform/Chassis 2.4 TD	ACL	Diesel	2384	6	9
12/82→09/93	LT 40-55 I Platform/Chassis 2.4 TD	DV	Diesel	2383	6	9
09/98→07/05	Lupo 1.0	AER	Petrol	999	4	1
09/98→07/05	Lupo 1.0	ALD	Petrol	999	4	1

MODEL INDEX

Modelverzeichnis • Index de modele • Índice de Modelo
Indeks modelu • Модель автомобиля • دليل الموديل



CCM

x



9

09/98→07/05	Lupo 1.0	ALL	Petrol	999	4	1
09/98→07/05	Lupo 1.0	ANV	Petrol	999	4	1
09/98→07/05	Lupo 1.0	AUC	Petrol	999	4	1
07/99→07/05	Lupo 1.2 TDI 3L	ANY	Diesel	1191	3	14
07/99→07/05	Lupo 1.2 TDI 3L	AYZ	Diesel	1191	3	14
10/00→07/05	Lupo 1.4	AUD	Petrol	1390	4	13
08/99→07/05	Lupo 1.4 16V	AFK	Petrol	1390	4	13
09/98→07/05	Lupo 1.4 16V	AHW	Petrol	1390	4	13
09/98→07/05	Lupo 1.4 16V	AKQ	Petrol	1390	4	13
09/98→07/05	Lupo 1.4 16V	APE	Petrol	1390	4	13
08/99→07/05	Lupo 1.4 16V	AQQ	Petrol	1390	4	13
09/98→07/05	Lupo 1.4 16V	AUA	Petrol	1390	4	13
08/99→07/05	Lupo 1.4 16V	AUB	Petrol	1390	4	13
09/98→07/05	Lupo 1.4 16V	BBY	Petrol	1390	4	13
01/99→07/05	Lupo 1.4 TDI	AMF	Diesel	1422	3	22
10/98→05/99	Lupo 1.4i 16V	ANM	Petrol	1390	4	13
09/00→07/05	Lupo 1.6 GTI	AVY	Petrol	1598	4	13
09/98→07/05	Lupo 1.7 SDI	AKU	Diesel	1716	4	22
04/03→11/09	Multivan V 1.9 TDI	AXB	Diesel	1896	4	22
04/03→11/09	Multivan V 1.9 TDI	AXC	Diesel	1896	4	22
01/06→11/09	Multivan V 1.9 TDI	BRR	Diesel	1896	4	24
06/06→11/09	Multivan V 1.9 TDI	BRS	Diesel	1896	4	24
11/03→	Multivan V 2.0	AXA	Petrol	1984	4	43
09/09→	Multivan V 2.0 BiTDI	CFCA Euro 5	Diesel	1968	4	40
09/09→	Multivan V 2.0 BiTDI 4motion	CFCA Euro 5	Diesel	1968	4	40
09/09→	Multivan V 2.0 TDI	CAAA Euro 5	Diesel	1968	4	40
09/09→	Multivan V 2.0 TDI	CAAB Euro 5	Diesel	1968	4	40
09/09→	Multivan V 2.0 TDI	CAAC Euro 5	Diesel	1968	4	40
05/11→	Multivan V 2.0 TDI	CAAD	Diesel	1968	4	40
05/10→	Multivan V 2.0 TDI	CAAE	Diesel	1968	4	40
09/09→	Multivan V 2.0 TDI	CCHA	Diesel	1968	4	40
05/10→	Multivan V 2.0 TDI	CCHB	Diesel	1968	4	40
09/09→	Multivan V 2.0 TDI 4motion	CAAC Euro 5	Diesel	1968	4	40
05/10→	Multivan V 2.0 TDI 4motion	CAAE	Diesel	1968	4	40
09/09→	Multivan V 2.0 TDI 4motion	CCHA	Diesel	1968	4	40
05/10→	Multivan V 2.0 TDI 4motion	CCHB	Diesel	1968	4	40
04/03→11/09	Multivan V 2.5 TDI	AXD	Diesel	2461	5	37
04/03→11/09	Multivan V 2.5 TDI	AXE	Diesel	2461	5	37
11/03→11/09	Multivan V 2.5 TDI	BLJ	Diesel	2461	5	37
04/03→11/09	Multivan V 2.5 TDI	BNZ	Diesel	2460	5	40
07/04→11/09	Multivan V 2.5 TDI 4motion	AXD	Diesel	2461	5	37
07/04→11/09	Multivan V 2.5 TDI 4motion	AXE	Diesel	2461	5	37
07/04→11/09	Multivan V 2.5 TDI 4motion	BNZ	Diesel	2460	5	40
02/04→06/04	Multivan V 3.2 V6	BDL	Petrol	3189	V6	49
02/04→11/09	Multivan V 3.2 V6	BKK	Petrol	3189	V6	49
02/04→11/09	Multivan V 3.2 V6	CFLA	Petrol	3189	V6	49
07/04→11/09	Multivan V 3.2 V6 4motion	BKK	Petrol	3189	V6	49
07/04→11/09	Multivan V 3.2 V6 4motion	CFLA	Petrol	3189	V6	49
11/01→	New Beetle 1.4	BCA	Petrol	1390	4	15
10/99→09/00	New Beetle 1.6	AWH	Petrol	1595	4	35
06/00→	New Beetle 1.6	AYD	Petrol	1595	4	38
06/00→	New Beetle 1.6	BFS	Petrol	1595	4	38
10/99→	New Beetle 1.8 T	AGU	Petrol	1781	4	36
10/99→	New Beetle 1.8 T	APH	Petrol	1781	4	36
10/99→	New Beetle 1.8 T	AVC	Petrol	1781	4	36
01/98→06/04	New Beetle 1.9 TDI	ALH	Diesel	1896	4	22
02/01→	New Beetle 1.9 TDI	ATD	Diesel	1896	4	22
02/01→	New Beetle 1.9 TDI	BEW	Diesel	1896	4	24
07/05→	New Beetle 1.9 TDI	BSW	Diesel	1896	4	24



CCM

x



01/98→	New Beetle 2.0	AEG	Petrol	1984	4	43
01/98→	New Beetle 2.0	APK	Petrol	1984	4	43
01/98→	New Beetle 2.0	AQY	Petrol	1984	4	43
01/98→	New Beetle 2.0	AZJ	Petrol	1984	4	43
01/98→	New Beetle 2.0	BEJ	Petrol	1984	4	43
01/98→	New Beetle 2.0	BER	Petrol	1984	4	43
01/98→	New Beetle 2.0	BHP	Petrol	1984	4	43
01/98→	New Beetle 2.0	CBPA	Petrol	1984	4	43
10/00→	New Beetle 2.3 V5	AQN	Petrol	2324	V5	32
07/05→	New Beetle 2.5	BPR	Petrol	2480	5	44
07/05→	New Beetle 2.5	BPS	Petrol	2480	5	44
01/03→09/10	New Beetle Convertible 1.4	BCA	Petrol	1390	4	15
01/03→09/10	New Beetle Convertible 1.6	BFS	Petrol	1595	4	38
06/03→09/10	New Beetle Convertible 1.9 TDI	AXR	Diesel	1896	4	22
07/05→09/10	New Beetle Convertible 1.9 TDI	BSW	Diesel	1896	4	24
09/02→10/10	New Beetle Convertible 2.0	AZJ	Petrol	1984	4	43
07/05→09/10	New Beetle Convertible 2.5	BPR	Petrol	2480	5	44
07/05→09/10	New Beetle Convertible 2.5	BPS	Petrol	2480	5	44
04/00→05/01	New Beetle RSI 3.2 4motion	AXJ	Petrol	3189	V6	49
08/02→	Parati 1.9 SDI	BGG	Diesel	1896	4	23
01/83→12/87	Passat	DTA	Petrol	1595	4	30
08/80→07/86	Passat 1.3	EP	Petrol	1297	4	6
08/80→07/86	Passat 1.3	EU	Petrol	1272	4	6
05/73→07/83	Passat 1.3	FY	Petrol	1272	4	7
01/78→07/86	Passat 1.3	FZ	Petrol	1272	4	7
05/73→01/78	Passat 1.3	ZA	Petrol	1297	4	8
05/73→01/78	Passat 1.3	ZF	Petrol	1297	4	8
05/07→	Passat 1.4 TSI	CAXA	Petrol	1390	4	17
08/77→07/80	Passat 1.5 D	CK	Diesel	1471	4	10
02/88→09/91	Passat 1.6	1F	Petrol	1595	4	30
02/88→12/88	Passat 1.6	ABN	Petrol	1595	4	30
10/96→11/00	Passat 1.6	ADP	Petrol	1595	4	35
10/94→08/96	Passat 1.6	AEK	Petrol	1595	4	35
10/94→08/96	Passat 1.6	AFT	Petrol	1595	4	35
10/96→11/00	Passat 1.6	AHL	Petrol	1595	4	35
11/00→05/05	Passat 1.6	ALZ	Petrol	1595	4	38
10/96→11/00	Passat 1.6	ANA	Petrol	1595	4	38
10/96→11/00	Passat 1.6	ARM	Petrol	1595	4	35
05/05→07/10	Passat 1.6	BSE	Petrol	1595	4	38
05/05→07/10	Passat 1.6	BSF	Petrol	1595	4	38
08/80→03/88	Passat 1.6	DT	Petrol	1595	4	30
02/88→09/91	Passat 1.6	EZ	Petrol	1595	4	30
	Passat 1.6	JU	Petrol	1595	4	30
08/87→03/88	Passat 1.6	PP	Petrol	1595	4	30
02/86→03/88	Passat 1.6	RL	Petrol	1595	4	30
08/80→03/88	Passat 1.6	WV	Petrol	1588	4	27
09/79→07/80	Passat 1.6	WY	Petrol	1588	4	27
09/79→07/80	Passat 1.6	WZ	Petrol	1588	4	27
09/75→07/80	Passat 1.6	YG	Petrol	1588	4	27
09/75→07/80	Passat 1.6	YH	Petrol	1588	4	27
09/75→07/80	Passat 1.6	YK	Petrol	1588	4	27
08/80→03/88	Passat 1.6	YN	Petrol	1588	4	27
08/75→02/83	Passat 1.6	YP	Petrol	1588	4	27
08/80→07/81	Passat 1.6	YY	Petrol	1588	4	27
08/80→03/88	Passat 1.6 D	CR	Diesel	1588	4	10
08/80→03/88	Passat 1.6 D	JK	Diesel	1588	4	10
03/05→06/08	Passat 1.6 FSI	BLF	Petrol	1598	4	17
08/77→07/80	Passat 1.6 GLi	YS	Petrol	1588	4	28
04/82→03/88	Passat 1.6 TD	CY	Diesel	1588	4	9

MODEL INDEX

Modelverzeichnis • Index de modele • Índice de Modelo
Indeks modelu • Модель автомобиля • دليل الموديل



CCM

x



9

05/86→09/93	Passat 1.6 TD	RA	Diesel	1588	4	9
08/88→09/93	Passat 1.6 TD	SB	Diesel	1588	4	9
08/09→	Passat 1.6 TDI	CAYC	Diesel	1598	4	25
08/90→08/96	Passat 1.8	AAM	Petrol	1781	4	30
02/88→08/96	Passat 1.8	ABS	Petrol	1781	4	31
10/96→11/00	Passat 1.8	ADR	Petrol	1781	4	36
02/88→08/96	Passat 1.8	ADZ	Petrol	1781	4	31
01/97→11/00	Passat 1.8	AFY	Petrol	1781	4	36
10/96→03/05	Passat 1.8	APT	Petrol	1781	4	36
10/96→11/00	Passat 1.8	ARG	Petrol	1781	4	36
01/83→03/88	Passat 1.8	DS	Petrol	1781	4	31
12/83→03/88	Passat 1.8	DZ	Petrol	1781	4	31
01/83→03/88	Passat 1.8	JN	Petrol	1781	4	30
01/83→03/88	Passat 1.8	JV	Petrol	1781	4	31
04/88→07/92	Passat 1.8	PB	Petrol	1781	4	31
04/88→07/93	Passat 1.8	PF	Petrol	1781	4	31
05/86→03/88	Passat 1.8	RM	Petrol	1781	4	30
02/88→08/96	Passat 1.8	RP	Petrol	1781	4	30
04/88→12/89	Passat 1.8 16V	KR	Petrol	1781	4	31
08/88→08/96	Passat 1.8 G60 Syncro	PG	Petrol	1781	4	31
08/91→09/93	Passat 1.8 GL	KR	Petrol	1781	4	31
10/96→11/00	Passat 1.8 Syncro/4motion	ADR	Petrol	1781	4	36
10/96→11/00	Passat 1.8 Syncro/4motion	APT	Petrol	1781	4	36
10/96→11/00	Passat 1.8 Syncro/4motion	ARG	Petrol	1781	4	36
10/96→11/00	Passat 1.8 T	AEB	Petrol	1781	4	36
10/96→11/00	Passat 1.8 T	ANB	Petrol	1781	4	36
10/96→11/00	Passat 1.8 T	APU	Petrol	1781	4	36
02/01→05/05	Passat 1.8 T	AWM	Petrol	1781	4	36
11/00→05/05	Passat 1.8 T 20V	AWT	Petrol	1781	4	36
03/01→05/05	Passat 1.8 T 4motion	AWM	Petrol	1781	4	36
11/96→08/00	Passat 1.8 T Syncro	AEB	Petrol	1781	4	36
01/81→07/83	Passat 1.9	WN	Petrol	1921	5	27
05/89→10/93	Passat 1.9 D	1Y	Diesel	1896	4	21
03/91→08/96	Passat 1.9 TD	AAZ	Diesel	1896	4	21
10/93→08/96	Passat 1.9 TDI	1Z	Diesel	1896	4	22
03/96→11/00	Passat 1.9 TDI	AFN	Diesel	1896	4	22
10/96→11/00	Passat 1.9 TDI	AHH	Diesel	1896	4	22
10/93→11/00	Passat 1.9 TDI	AHU	Diesel	1896	4	22
08/98→11/00	Passat 1.9 TDI	AJM	Diesel	1896	4	22
08/98→11/00	Passat 1.9 TDI	ATJ	Diesel	1896	4	22
02/00→05/05	Passat 1.9 TDI	AVB	Diesel	1896	4	22
11/00→05/05	Passat 1.9 TDI	AVF	Diesel	1896	4	22
10/96→11/00	Passat 1.9 TDI	AVG	Diesel	1896	4	22
11/00→05/05	Passat 1.9 TDI	AWX	Diesel	1896	4	22
03/05→11/08	Passat 1.9 TDI	BKC	Diesel	1896	4	24
03/05→11/08	Passat 1.9 TDI	BLS	Diesel	1896	4	24
04/08→07/08	Passat 1.9 TDI	BPZ	Diesel	1896	4	23
03/05→11/08	Passat 1.9 TDI	BXE	Diesel	1896	4	24
08/99→11/00	Passat 1.9 TDI 4motion	AJM	Diesel	1896	4	22
08/99→11/00	Passat 1.9 TDI 4motion	ATJ	Diesel	1896	4	22
11/00→05/05	Passat 1.9 TDI 4motion	AVF	Diesel	1896	4	22
10/96→11/00	Passat 1.9 TDI Syncro/4motion	AVG	Diesel	1896	4	22
10/96→11/00	Passat 1.9 TDI Syncro/4motion	AFN	Diesel	1896	4	22
02/90→08/96	Passat 2.0	2E	Petrol	1984	4	43
02/90→08/96	Passat 2.0	ADY	Petrol	1984	4	43
03/95→08/96	Passat 2.0	AEP	Petrol	1984	4	43
02/90→08/96	Passat 2.0	AGG	Petrol	1984	4	43
11/01→05/05	Passat 2.0	ALT	Petrol	1984	4	44
11/00→05/05	Passat 2.0	AZM	Petrol	1984	4	43



CCM

x



9

08/83→03/88	Passat 2.0	HP	Petrol	1994	5	30
08/83→03/88	Passat 2.0	JS	Petrol	1994	5	30
08/88→09/93	Passat 2.0 16V	9A	Petrol	1984	4	43
01/94→08/96	Passat 2.0 16V	ABF	Petrol	1984	4	43
11/00→05/05	Passat 2.0 4motion	AZM	Petrol	1984	4	43
01/09→	Passat 2.0 BlueTDI	CBAC	Diesel	1968	4	41
07/05→07/10	Passat 2.0 FSI	AXX	Petrol	1984	4	44
03/05→07/10	Passat 2.0 FSI	BLR	Petrol	1984	4	44
03/05→07/10	Passat 2.0 FSI	BLY	Petrol	1984	4	44
07/05→07/10	Passat 2.0 FSI	BPY	Petrol	1984	4	44
03/05→07/10	Passat 2.0 FSI	BVY	Petrol	1984	4	44
03/05→07/10	Passat 2.0 FSI	BVZ	Petrol	1984	4	44
07/05→07/10	Passat 2.0 FSI	BWA	Petrol	1984	4	44
09/05→07/10	Passat 2.0 FSI 4motion	BLX	Petrol	1984	4	44
09/05→07/10	Passat 2.0 FSI 4motion	BLY	Petrol	1984	4	44
09/05→07/10	Passat 2.0 FSI 4motion	BVX	Petrol	1984	4	44
10/90→08/96	Passat 2.0 Syncro	2E	Petrol	1984	4	43
10/90→08/96	Passat 2.0 Syncro	ADY	Petrol	1984	4	43
10/90→08/96	Passat 2.0 Syncro	AGG	Petrol	1984	4	43
12/03→05/05	Passat 2.0 TDI	BGW	Diesel	1968	4	39
03/05→11/10	Passat 2.0 TDI	BMA	Diesel	1968	4	39
03/05→	Passat 2.0 TDI	BMP	Diesel	1968	4	39
08/05→	Passat 2.0 TDI	BMR	Diesel	1968	4	39
08/05→	Passat 2.0 TDI	BUZ	Diesel	1968	4	39
08/05→07/06	Passat 2.0 TDI	BVE	Diesel	1968	4	39
11/05→05/07	Passat 2.0 TDI	BWV	Diesel	1968	4	39
03/05→11/10	Passat 2.0 TDI	CBAA	Diesel	1968	4	41
08/05→	Passat 2.0 TDI	CBBB	Diesel	1968	4	41
11/08→07/10	Passat 2.0 TDI	CBDC	Diesel	1968	4	41
08/10→	Passat 2.0 TDI	CFFA	Diesel	1968	4	41
08/10→	Passat 2.0 TDI	CFFB	Diesel	1968	4	41
08/10→	Passat 2.0 TDI	CFGB	Diesel	1968	4	41
12/12→	Passat 2.0 TDI	CFGC	Diesel	1968	4	41
08/10→	Passat 2.0 TDI	CLLA	Diesel	1968	4	41
03/05→	Passat 2.0 TDI 16V	BKP	Diesel	1968	4	39
03/05→	Passat 2.0 TDI 16V	CBAB	Diesel	1968	4	41
03/05→	Passat 2.0 TDI 16V 4motion	BKP	Diesel	1968	4	39
03/05→	Passat 2.0 TDI 16V 4motion	CBAB	Diesel	1968	4	41
03/05→	Passat 2.0 TDI 4motion	BMP	Diesel	1968	4	39
05/09→	Passat 2.0 TDI 4motion	CBBB	Diesel	1968	4	41
08/10→	Passat 2.0 TDI 4motion	CFFB	Diesel	1968	4	41
08/10→	Passat 2.0 TDI 4motion	CFGB	Diesel	1968	4	41
01/13→	Passat 2.0 TDI 4motion	CFGC	Diesel	1968	4	41
08/10→	Passat 2.0 TDI 4motion	CLLA	Diesel	1968	4	41
08/91→12/94	Passat 2.0i	ACX	Petrol	1984	4	43
01/81→07/83	Passat 2.1	WE	Petrol	2144	5	27
	Passat 2.2	KM	Petrol	2226	5	30
01/85→03/88	Passat 2.2	KV	Petrol	2226	5	30
08/85→03/88	Passat 2.2	KX	Petrol	2226	5	30
11/00→05/05	Passat 2.3 V5	AZX	Petrol	2324	V5	32
11/00→05/05	Passat 2.3 V5 4motion	AZX	Petrol	2324	V5	32
10/96→11/00	Passat 2.3 VR5	AGZ	Petrol	2324	V5	32
10/97→11/00	Passat 2.3 VR5 Syncro/4motion	AGZ	Petrol	2324	V5	32
07/98→05/05	Passat 2.5 TDI	AFB	Diesel	2496	V6	20
07/98→05/05	Passat 2.5 TDI	AKN	Diesel	2496	V6	20
05/03→05/05	Passat 2.5 TDI	BDG	Diesel	2496	V6	20
11/00→05/05	Passat 2.5 TDI 4motion	AFB	Diesel	2496	V6	20
11/00→05/05	Passat 2.5 TDI 4motion	AKN	Diesel	2496	V6	20
01/03→05/05	Passat 2.5 TDI 4motion	BAU	Diesel	2496	V6	20

MODEL INDEX

Modelverzeichnis • Index de modele • Índice de Modelo
Indeks modelu • Модель автомобиля • دليل الموديل



CCM

x



9

01/03→05/05	Passat 2.5 TDI 4motion	BDH	Diesel	2496	V6	20
12/98→11/00	Passat 2.5 TDI Syncro/4motion	AFB	Diesel	2496	V6	20
12/98→11/00	Passat 2.5 TDI Syncro/4motion	AKN	Diesel	2496	V6	20
11/00→05/05	Passat 2.8 4motion	AMX	Petrol	2771	V6	43
11/00→05/05	Passat 2.8 4motion	ATQ	Petrol	2771	V6	43
05/97→09/99	Passat 2.8 Syncro	AGE	Petrol	2771	V6	43
08/96→11/00	Passat 2.8 V6	ACK	Petrol	2771	V6	43
05/97→09/99	Passat 2.8 V6	AGE	Petrol	2771	V6	43
08/96→11/00	Passat 2.8 V6	APR	Petrol	2771	V6	43
08/96→11/00	Passat 2.8 V6	AQD	Petrol	2771	V6	43
09/99→11/00	Passat 2.8 V6	ATX	Petrol	2771	V6	43
09/99→11/00	Passat 2.8 V6	BBG	Petrol	2771	V6	43
10/96→11/00	Passat 2.8 V6 Syncro/4motion	ACK	Petrol	2771	V6	43
10/96→11/00	Passat 2.8 V6 Syncro/4motion	ALG	Petrol	2771	V6	43
10/96→11/00	Passat 2.8 V6 Syncro/4motion	APR	Petrol	2771	V6	43
10/96→11/00	Passat 2.8 V6 Syncro/4motion	AQD	Petrol	2771	V6	43
06/91→08/96	Passat 2.8 VR6	AAA	Petrol	2792	V6	32
01/12→	Passat AllTrack 2.0 TDI	CFFB	Diesel	1968	4	41
01/12→	Passat AllTrack 2.0 TDI 4motion	CFFB	Diesel	1968	4	41
01/12→	Passat AllTrack 2.0 TDI 4motion	CFGB	Diesel	1968	4	41
01/13→	Passat AllTrack 2.0 TDI 4motion	CFGC	Diesel	1968	4	41
05/09→11/10	Passat CC 2.0 BlueTDI	CBAC	Diesel	1968	4	41
06/08→05/11	Passat CC 2.0 TDI	CBAA	Diesel	1968	4	41
06/08→	Passat CC 2.0 TDI	CBAB	Diesel	1968	4	41
05/08→11/08	Passat CC 2.0 TDI	CBBA	Diesel	1968	4	41
06/08→	Passat CC 2.0 TDI	CBBB	Diesel	1968	4	41
06/08→05/11	Passat CC 2.0 TDI	CFFA	Diesel	1968	4	41
06/08→	Passat CC 2.0 TDI	CFFB	Diesel	1968	4	41
06/08→	Passat CC 2.0 TDI	CFGB	Diesel	1968	4	41
06/08→	Passat CC 2.0 TDI	CLLA	Diesel	1968	4	41
08/09→	Passat CC 2.0 TDI 4motion	CBAB	Diesel	1968	4	41
11/09→	Passat CC 2.0 TDI 4motion	CBBB	Diesel	1968	4	41
08/09→	Passat CC 2.0 TDI 4motion	CFFB	Diesel	1968	4	41
11/09→	Passat CC 2.0 TDI 4motion	CFGB	Diesel	1968	4	41
01/85→03/88	Passat Saloon 1.6	DT	Petrol	1595	4	30
	Passat Saloon 1.6	JU	Petrol	1595	4	30
08/87→03/88	Passat Saloon 1.6	PP	Petrol	1595	4	30
01/85→03/88	Passat Saloon 1.6	RL	Petrol	1595	4	30
01/85→03/88	Passat Saloon 1.6 TD	CY	Diesel	1588	4	9
01/85→03/88	Passat Saloon 1.8	DS	Petrol	1781	4	31
01/85→03/88	Passat Saloon 1.8	JN	Petrol	1781	4	30
05/86→03/88	Passat Saloon 1.8	RM	Petrol	1781	4	30
08/84→07/85	Passat Saloon 2.0	HP	Petrol	1994	5	30
08/84→07/85	Passat Saloon 2.0	JS	Petrol	1994	5	30
01/85→03/88	Passat Saloon 2.2	KX	Petrol	2226	5	30
08/80→07/86	Passat Variant 1.3	EP	Petrol	1297	4	6
08/80→07/86	Passat Variant 1.3	EU	Petrol	1272	4	6
05/73→07/83	Passat Variant 1.3	FY	Petrol	1272	4	7
08/80→07/86	Passat Variant 1.3	FZ	Petrol	1272	4	7
05/73→01/78	Passat Variant 1.3	ZA	Petrol	1297	4	8
10/73→01/78	Passat Variant 1.3	ZF	Petrol	1297	4	8
05/07→	Passat Variant 1.4 TSI	CAXA	Petrol	1390	4	17
02/77→07/80	Passat Variant 1.5 D	CK	Diesel	1471	4	10
04/88→09/91	Passat Variant 1.6	1F	Petrol	1595	4	30
06/97→11/00	Passat Variant 1.6	ADP	Petrol	1595	4	35
07/94→12/95	Passat Variant 1.6	AEK	Petrol	1595	4	35
07/94→12/95	Passat Variant 1.6	AFT	Petrol	1595	4	35
06/97→11/00	Passat Variant 1.6	AHL	Petrol	1595	4	35
11/00→05/05	Passat Variant 1.6	ALZ	Petrol	1595	4	38



CCM

x



06/97→11/00	Passat Variant 1.6	ANA	Petrol	1595	4	38
06/97→11/00	Passat Variant 1.6	ARM	Petrol	1595	4	35
08/05→11/10	Passat Variant 1.6	BSE	Petrol	1595	4	38
08/05→11/10	Passat Variant 1.6	BSF	Petrol	1595	4	38
08/80→03/88	Passat Variant 1.6	DT	Petrol	1595	4	30
04/88→09/91	Passat Variant 1.6	EZ	Petrol	1595	4	30
	Passat Variant 1.6	JU	Petrol	1595	4	30
08/87→03/88	Passat Variant 1.6	PP	Petrol	1595	4	30
02/86→03/88	Passat Variant 1.6	RL	Petrol	1595	4	30
08/80→03/88	Passat Variant 1.6	WV	Petrol	1588	4	27
02/76→03/88	Passat Variant 1.6	YN	Petrol	1588	4	27
08/75→02/83	Passat Variant 1.6	YP	Petrol	1588	4	27
02/79→03/88	Passat Variant 1.6 D	CR	Diesel	1588	4	10
08/80→03/88	Passat Variant 1.6 D	JK	Diesel	1588	4	10
08/05→06/08	Passat Variant 1.6 FSI	BLF	Petrol	1598	4	17
06/78→07/80	Passat Variant 1.6 i	YS	Petrol	1588	4	28
04/82→03/88	Passat Variant 1.6 TD	CY	Diesel	1588	4	9
08/88→09/93	Passat Variant 1.6 TD	RA	Diesel	1588	4	9
08/88→09/93	Passat Variant 1.6 TD	SB	Diesel	1588	4	9
08/09→	Passat Variant 1.6 TDI	CAYC	Diesel	1598	4	25
08/90→05/97	Passat Variant 1.8	AAM	Petrol	1781	4	30
02/88→05/97	Passat Variant 1.8	ABS	Petrol	1781	4	31
06/97→11/00	Passat Variant 1.8	ADR	Petrol	1781	4	36
02/88→05/97	Passat Variant 1.8	ADZ	Petrol	1781	4	31
06/97→11/00	Passat Variant 1.8	AFY	Petrol	1781	4	36
06/97→11/00	Passat Variant 1.8	APT	Petrol	1781	4	36
06/97→11/00	Passat Variant 1.8	ARG	Petrol	1781	4	36
01/83→03/88	Passat Variant 1.8	DS	Petrol	1781	4	31
12/83→03/88	Passat Variant 1.8	DZ	Petrol	1781	4	31
01/83→03/88	Passat Variant 1.8	JN	Petrol	1781	4	30
01/83→03/88	Passat Variant 1.8	JV	Petrol	1781	4	31
08/91→09/93	Passat Variant 1.8	KR	Petrol	1781	4	31
04/88→07/92	Passat Variant 1.8	PB	Petrol	1781	4	31
04/88→07/90	Passat Variant 1.8	PF	Petrol	1781	4	31
05/86→03/88	Passat Variant 1.8	RM	Petrol	1781	4	30
02/88→05/97	Passat Variant 1.8	RP	Petrol	1781	4	30
04/88→12/89	Passat Variant 1.8 16V	KR	Petrol	1781	4	31
03/01→05/05	Passat Variant 1.8 4motion	AWM	Petrol	1781	4	36
08/88→05/97	Passat Variant 1.8 G60 Syncro	PG	Petrol	1781	4	31
01/86→03/88	Passat Variant 1.8 Syncro	DS	Petrol	1781	4	31
01/86→03/88	Passat Variant 1.8 Syncro	JN	Petrol	1781	4	30
06/97→11/00	Passat Variant 1.8 Syncro/4motion	ADR	Petrol	1781	4	36
06/97→11/00	Passat Variant 1.8 Syncro/4motion	APT	Petrol	1781	4	36
06/97→11/00	Passat Variant 1.8 Syncro/4motion	ARG	Petrol	1781	4	36
06/97→11/00	Passat Variant 1.8 T	AEB	Petrol	1781	4	36
06/97→11/00	Passat Variant 1.8 T	ANB	Petrol	1781	4	36
06/97→11/00	Passat Variant 1.8 T	APU	Petrol	1781	4	36
05/02→08/05	Passat Variant 1.8 T	AWM	Petrol	1781	4	36
11/00→05/05	Passat Variant 1.8 T 20V	AWT	Petrol	1781	4	36
01/81→07/83	Passat Variant 1.9	WN	Petrol	1921	5	27
05/89→10/93	Passat Variant 1.9 D	1Y	Diesel	1896	4	21
03/91→05/97	Passat Variant 1.9 TD	AAZ	Diesel	1896	4	21
10/93→05/97	Passat Variant 1.9 TDI	1Z	Diesel	1896	4	22
03/96→11/00	Passat Variant 1.9 TDI	AFN	Diesel	1896	4	22
06/97→11/00	Passat Variant 1.9 TDI	AHH	Diesel	1896	4	22
10/93→11/00	Passat Variant 1.9 TDI	AHU	Diesel	1896	4	22
08/98→11/00	Passat Variant 1.9 TDI	AJM	Diesel	1896	4	22
08/98→11/00	Passat Variant 1.9 TDI	ATJ	Diesel	1896	4	22
02/00→05/05	Passat Variant 1.9 TDI	AVB	Diesel	1896	4	22

MODEL INDEX

Modelverzeichnis • Index de modele • Índice de Modelo
Indeks modelu • Модель автомобиля • دليل الموديل



CCM

x



9

11/00→05/05	Passat Variant 1.9 TDI	AVF	Diesel	1896	4	22
06/97→11/00	Passat Variant 1.9 TDI	AVG	Diesel	1896	4	22
11/00→05/05	Passat Variant 1.9 TDI	AWX	Diesel	1896	4	22
08/05→11/08	Passat Variant 1.9 TDI	BKC	Diesel	1896	4	24
08/05→11/08	Passat Variant 1.9 TDI	BLS	Diesel	1896	4	24
08/05→11/08	Passat Variant 1.9 TDI	BXE	Diesel	1896	4	24
08/99→11/00	Passat Variant 1.9 TDI 4motion	ATJ	Diesel	1896	4	22
11/00→05/05	Passat Variant 1.9 TDI 4motion	AVF	Diesel	1896	4	22
06/97→11/00	Passat Variant 1.9 TDI Syncro/4motion	AFN	Diesel	1896	4	22
06/97→11/00	Passat Variant 1.9 TDI Syncro/4motion	AVG	Diesel	1896	4	22
02/90→05/97	Passat Variant 2.0	2E	Petrol	1984	4	43
02/90→05/97	Passat Variant 2.0	ADY	Petrol	1984	4	43
03/95→08/96	Passat Variant 2.0	AEP	Petrol	1984	4	43
02/90→05/97	Passat Variant 2.0	AGG	Petrol	1984	4	43
11/01→05/05	Passat Variant 2.0	ALT	Petrol	1984	4	44
11/00→05/05	Passat Variant 2.0	AZM	Petrol	1984	4	43
08/83→03/88	Passat Variant 2.0	HP	Petrol	1994	5	30
08/83→03/88	Passat Variant 2.0	JS	Petrol	1994	5	30
08/88→09/93	Passat Variant 2.0 16V	9A	Petrol	1984	4	43
01/94→05/97	Passat Variant 2.0 16V	ABF	Petrol	1984	4	43
11/00→05/05	Passat Variant 2.0 4motion	AZM	Petrol	1984	4	43
01/09→	Passat Variant 2.0 BlueTDI	CBAC	Diesel	1968	4	41
08/05→11/10	Passat Variant 2.0 FSI	AXX	Petrol	1984	4	44
08/05→11/10	Passat Variant 2.0 FSI	BLR	Petrol	1984	4	44
08/05→11/10	Passat Variant 2.0 FSI	BLY	Petrol	1984	4	44
08/05→11/10	Passat Variant 2.0 FSI	BPY	Petrol	1984	4	44
08/05→11/10	Passat Variant 2.0 FSI	BVY	Petrol	1984	4	44
08/05→11/10	Passat Variant 2.0 FSI	BVZ	Petrol	1984	4	44
08/05→11/10	Passat Variant 2.0 FSI	BWA	Petrol	1984	4	44
09/05→11/10	Passat Variant 2.0 FSI 4motion	BLX	Petrol	1984	4	44
09/05→11/10	Passat Variant 2.0 FSI 4motion	BLY	Petrol	1984	4	44
09/05→11/10	Passat Variant 2.0 FSI 4motion	BVX	Petrol	1984	4	44
10/90→05/97	Passat Variant 2.0 Syncro	2E	Petrol	1984	4	43
10/90→05/97	Passat Variant 2.0 Syncro	ADY	Petrol	1984	4	43
10/90→05/97	Passat Variant 2.0 Syncro	AGG	Petrol	1984	4	43
05/84→03/88	Passat Variant 2.0 Syncro	JS	Petrol	1994	5	30
12/03→05/05	Passat Variant 2.0 TDI	BGW	Diesel	1968	4	39
08/05→11/10	Passat Variant 2.0 TDI	BMA	Diesel	1968	4	39
08/05→	Passat Variant 2.0 TDI	BMP	Diesel	1968	4	39
08/05→	Passat Variant 2.0 TDI	BMR	Diesel	1968	4	39
08/05→	Passat Variant 2.0 TDI	BUZ	Diesel	1968	4	39
08/05→02/06	Passat Variant 2.0 TDI	BVE	Diesel	1968	4	39
11/05→05/07	Passat Variant 2.0 TDI	BWV	Diesel	1968	4	39
08/05→11/10	Passat Variant 2.0 TDI	CBAA	Diesel	1968	4	41
08/05→	Passat Variant 2.0 TDI	CBBB	Diesel	1968	4	41
11/08→11/10	Passat Variant 2.0 TDI	CBDC	Diesel	1968	4	41
08/10→	Passat Variant 2.0 TDI	CFFA	Diesel	1968	4	41
08/10→	Passat Variant 2.0 TDI	CFFB	Diesel	1968	4	41
08/10→	Passat Variant 2.0 TDI	CFGB	Diesel	1968	4	41
12/12→	Passat Variant 2.0 TDI	CFGC	Diesel	1968	4	41
08/10→	Passat Variant 2.0 TDI	CLLA	Diesel	1968	4	41
08/05→	Passat Variant 2.0 TDI 16V	BKP	Diesel	1968	4	39
08/05→	Passat Variant 2.0 TDI 16V	CBAB	Diesel	1968	4	41
08/05→	Passat Variant 2.0 TDI 16V 4motion	BKP	Diesel	1968	4	39
08/05→	Passat Variant 2.0 TDI 16V 4motion	CBAB	Diesel	1968	4	41
08/05→	Passat Variant 2.0 TDI 4motion	BMP	Diesel	1968	4	39
05/09→	Passat Variant 2.0 TDI 4motion	CBBB	Diesel	1968	4	41
08/10→	Passat Variant 2.0 TDI 4motion	CFFB	Diesel	1968	4	41
08/10→	Passat Variant 2.0 TDI 4motion	CFGB	Diesel	1968	4	41



CCM

x



9

01/13→	Passat Variant 2.0 TDI 4motion	CFGC	Diesel	1968	4	41
08/10→	Passat Variant 2.0 TDI 4motion	CLLA	Diesel	1968	4	41
01/81→07/83	Passat Variant 2.1	WE	Petrol	2144	5	27
01/85→03/88	Passat Variant 2.2	KV	Petrol	2226	5	30
08/85→03/88	Passat Variant 2.2	KX	Petrol	2226	5	30
08/84→07/88	Passat Variant 2.2 Syncro	HY	Petrol	2226	5	30
08/85→03/88	Passat Variant 2.2 Syncro	JT	Petrol	2226	5	30
06/97→11/00	Passat Variant 2.3 VR5	AGZ	Petrol	2324	V5	32
11/00→05/05	Passat Variant 2.3 VR5	AZX	Petrol	2324	V5	32
11/00→05/05	Passat Variant 2.3 VR5 4motion	AZX	Petrol	2324	V5	32
10/97→11/00	Passat Variant 2.3 VR5 Syncro/4motion	AGZ	Petrol	2324	V5	32
07/98→05/05	Passat Variant 2.5 TDI	AFB	Diesel	2496	V6	20
07/98→05/05	Passat Variant 2.5 TDI	AKN	Diesel	2496	V6	20
05/03→05/05	Passat Variant 2.5 TDI	BDG	Diesel	2496	V6	20
11/00→05/05	Passat Variant 2.5 TDI 4motion	AFB	Diesel	2496	V6	20
11/00→05/05	Passat Variant 2.5 TDI 4motion	AKN	Diesel	2496	V6	20
01/03→05/05	Passat Variant 2.5 TDI 4motion	BAU	Diesel	2496	V6	20
01/03→05/05	Passat Variant 2.5 TDI 4motion	BDH	Diesel	2496	V6	20
12/98→11/00	Passat Variant 2.5 TDI Syncro/4motion	AFB	Diesel	2496	V6	20
12/98→11/00	Passat Variant 2.5 TDI Syncro/4motion	AKN	Diesel	2496	V6	20
11/00→05/05	Passat Variant 2.8 4motion	AMX	Petrol	2771	V6	43
11/00→05/05	Passat Variant 2.8 4motion	ATQ	Petrol	2771	V6	43
05/97→09/99	Passat Variant 2.8 Syncro	AGE	Petrol	2771	V6	43
06/97→11/00	Passat Variant 2.8 V6	ACK	Petrol	2771	V6	43
09/97→09/99	Passat Variant 2.8 V6	AGE	Petrol	2771	V6	43
06/97→11/00	Passat Variant 2.8 V6	APR	Petrol	2771	V6	43
06/97→11/00	Passat Variant 2.8 V6	AQD	Petrol	2771	V6	43
09/99→11/00	Passat Variant 2.8 V6	ATX	Petrol	2771	V6	43
09/99→11/00	Passat Variant 2.8 V6	BBG	Petrol	2771	V6	43
06/97→11/00	Passat Variant 2.8 V6 Syncro/4motion	ACK	Petrol	2771	V6	43
06/97→11/00	Passat Variant 2.8 V6 Syncro/4motion	ALG	Petrol	2771	V6	43
06/97→11/00	Passat Variant 2.8 V6 Syncro/4motion	APR	Petrol	2771	V6	43
06/97→11/00	Passat Variant 2.8 V6 Syncro/4motion	AQD	Petrol	2771	V6	43
06/91→05/97	Passat Variant 2.8 VR6	AAA	Petrol	2792	V6	32
01/94→05/97	Passat Variant 2.9 VR6 Syncro	ABV	Petrol	2861	V6	42
09/04→	Phaeton 3.0 V6 TDI 4motion	BMK	Diesel	2967	V6	45
11/08→	Phaeton 3.0 V6 TDI 4motion	CARB	Diesel	2967	V6	46
11/08→	Phaeton 3.0 V6 TDI 4motion	CEXA	Diesel	2967	V6	46
04/02→	Phaeton 3.2 V6	AYT	Petrol	3189	V6	49
04/02→	Phaeton 3.2 V6	BKL	Petrol	3189	V6	49
02/04→	Phaeton 3.2 V6 4motion	BKL	Petrol	3189	V6	49
02/04→	Phaeton 3.2 V6 4motion	BRK	Petrol	3189	V6	49
05/03→	Phaeton 4.2 V8 4motion	BGH	Petrol	4172	V8	50
05/03→	Phaeton 4.2 V8 4motion	BGJ	Petrol	4172	V8	50
11/02→	Phaeton 5.0 V10 TDI 4motion	AJS	Diesel	4921	V10	37
01/75→12/78	Polo	HD	Petrol	1093	4	2
09/75→12/81	Polo 0.9	HA	Petrol	895	4	2
10/99→09/01	Polo 1.0	ALD	Petrol	999	4	1
10/99→09/01	Polo 1.0	AUC	Petrol	999	4	1
10/81→10/86	Polo 1.0	GL	Petrol	1043	4	4
08/85→01/92	Polo 1.0	HZ	Petrol	1043	4	4
08/89→09/94	Polo 1.0 CAT	AAK	Petrol	1043	4	4
08/89→09/94	Polo 1.0 CAT	AAU	Petrol	1043	4	5
08/89→09/94	Polo 1.0 CAT	ACM	Petrol	1043	4	4
03/75→09/89	Polo 1.1	HB	Petrol	1093	4	2
03/75→09/81	Polo 1.1	HC	Petrol	1093	4	2
10/01→07/07	Polo 1.2 12V	AZQ	Petrol	1198	3	12
10/09→	Polo 1.2 TDI	CFWA	Diesel	1199	3	25
10/90→08/94	Polo 1.3	3F	Petrol	1272	4	5

MODEL INDEX

Modelverzeichnis • Index de modele • Índice de Modelo
Indeks modelu • Модель автомобиля • دليل الموديل



CCM

x



9

09/82→09/89	Polo 1.3	GK	Petrol	1272	4	4
08/82→07/88	Polo 1.3	GT	Petrol	1272	4	7
12/76→07/83	Polo 1.3	HH	Petrol	1272	4	7
08/82→07/88	Polo 1.3	HJ	Petrol	1272	4	7
08/83→07/88	Polo 1.3	HK	Petrol	1272	4	4
08/83→07/85	Polo 1.3	HW	Petrol	1272	4	4
08/83→07/88	Polo 1.3	MH	Petrol	1272	4	4
07/87→09/94	Polo 1.3 CAT	2G	Petrol	1272	4	4
10/89→03/91	Polo 1.3 CAT	3F	Petrol	1272	4	5
07/87→09/94	Polo 1.3 CAT	AAV	Petrol	1272	4	4
07/87→09/94	Polo 1.3 CAT	MH	Petrol	1272	4	4
07/87→09/94	Polo 1.3 CAT	NZ	Petrol	1272	4	4
08/86→07/90	Polo 1.3 D	MN	Diesel	1272	4	3
10/99→09/01	Polo 1.4	AKK	Petrol	1390	4	13
10/99→09/01	Polo 1.4	ANX	Petrol	1389	4	12
10/99→09/01	Polo 1.4	AUD	Petrol	1390	4	13
06/09→	Polo 1.4	CDDA	Petrol	1390	4	16
06/09→	Polo 1.4	CGGB	Petrol	1390	4	16
06/09→	Polo 1.4	CLPA	Petrol	1390	4	16
10/99→09/01	Polo 1.4 16V	AFK	Petrol	1390	4	13
10/99→09/01	Polo 1.4 16V	AHW	Petrol	1390	4	13
10/99→09/01	Polo 1.4 16V	APE	Petrol	1390	4	13
10/99→09/01	Polo 1.4 16V	AQQ	Petrol	1390	4	13
10/99→05/08	Polo 1.4 16V	AUA	Petrol	1390	4	13
10/99→05/08	Polo 1.4 16V	AUB	Petrol	1390	4	13
10/01→05/08	Polo 1.4 16V	BBY	Petrol	1390	4	13
10/01→05/08	Polo 1.4 16V	BBZ	Petrol	1390	4	13
10/01→05/08	Polo 1.4 16V	BKY	Petrol	1390	4	16
05/06→11/09	Polo 1.4 16V	BUD	Petrol	1390	4	16
10/90→09/94	Polo 1.4 D	1W	Diesel	1398	4	3
08/02→05/09	Polo 1.4 FSI 16V	BLM	Petrol	1390	4	13
05/10→	Polo 1.4 GTI	CAVE	Petrol	1390	4	18
05/10→	Polo 1.4 GTI	CTHE	Petrol	1390	4	18
10/99→06/05	Polo 1.4 TDI	AMF	Diesel	1422	3	22
01/00→10/00	Polo 1.4 TDi	ATL	Diesel	1422	3	22
10/01→06/05	Polo 1.4 TDI	BAY	Diesel	1422	3	22
04/05→11/09	Polo 1.4 TDI	BMS	Diesel	1422	3	22
04/05→11/09	Polo 1.4 TDI	BNM	Diesel	1422	3	22
04/05→11/09	Polo 1.4 TDI	BNV	Diesel	1422	3	22
04/05→11/09	Polo 1.4 TDI	BWB	Diesel	1422	3	22
10/99→09/01	Polo 1.6 16V GTI	ARC	Petrol	1598	4	13
10/99→09/01	Polo 1.6 16V GTI	AVY	Petrol	1598	4	13
06/09→	Polo 1.6 TDI	CAYA	Diesel	1598	4	25
06/09→	Polo 1.6 TDI	CAYB	Diesel	1598	4	25
06/09→	Polo 1.6 TDI	CAYC	Diesel	1598	4	25
06/09→	Polo 1.6 TDI	CLNA	Diesel	1598	4	25
04/97→10/99	Polo 1.7 SDI	AHG	Diesel	1716	4	22
10/99→09/01	Polo 1.7 SDI	AKU	Diesel	1716	4	22
10/99→09/01	Polo 1.9 D	AEF	Diesel	1896	4	21
10/99→09/01	Polo 1.9 SDI	AGD	Diesel	1896	4	22
10/99→09/01	Polo 1.9 SDI	ASX	Diesel	1896	4	22
10/01→11/09	Polo 1.9 SDI	ASY	Diesel	1896	4	22
11/03→11/09	Polo 1.9 TDI	ASZ	Diesel	1896	4	22
10/01→11/09	Polo 1.9 TDI	ATD	Diesel	1896	4	22
10/01→11/09	Polo 1.9 TDI	AXR	Diesel	1896	4	22
11/03→11/09	Polo 1.9 TDI	BLT	Diesel	1896	4	24
10/01→11/09	Polo 1.9 TDI	BMT	Diesel	1896	4	24
	Polo 1.9 TDI	BRM	Diesel	1896	4	24
04/02→11/09	Polo 2.0i	BBX	Petrol	1984	4	43



CCM

x



10/94→09/96	Polo 45 1.0	AEV	Petrol	1043	4	5
09/96→10/99	Polo 50 1.0	AER	Petrol	999	4	1
09/96→10/99	Polo 50 1.0	ALL	Petrol	999	4	1
10/94→07/95	Polo 55 1.3	ADX	Petrol	1296	4	12
08/95→10/99	Polo 55 1.4	AEX	Petrol	1390	4	12
07/95→10/99	Polo 60 1.4	AEX	Petrol	1390	4	12
07/95→10/99	Polo 60 1.4	AKV	Petrol	1390	4	12
07/95→10/99	Polo 60 1.4	APQ	Petrol	1390	4	12
08/97→10/99	Polo 60 1.7 SDI	AKU	Diesel	1716	4	22
10/94→10/99	Polo 64 1.9 D	AEF	Diesel	1896	4	21
07/96→10/99	Polo 64 1.9 SDI	AGD	Diesel	1896	4	22
10/94→10/99	Polo 75 1.6	AEA	Petrol	1598	4	12
10/94→10/99	Polo 75 1.6	AEE	Petrol	1598	4	12
10/94→10/99	Polo 75 1.6	AHS	Petrol	1588	4	12
04/96→10/99	Polo 100 1.4 16V	AFH	Petrol	1390	4	13
09/98→10/99	Polo 120 1.6 16V GTI	AJV	Petrol	1598	4	13
08/92→12/99	Polo Box 1.0	AAU	Petrol	1043	4	5
08/92→07/94	Polo Box 1.3	AAV	Petrol	1272	4	4
05/98→12/99	Polo Box 1.4	AEX	Petrol	1390	4	12
05/98→12/99	Polo Box 1.4	APQ	Petrol	1390	4	12
08/92→07/94	Polo Box 1.4 D	1W	Diesel	1398	4	3
08/97→12/99	Polo Box 1.7 SDI	AKU	Diesel	1716	4	22
10/94→12/99	Polo Box 1.9 D	AEF	Diesel	1896	4	21
07/96→12/99	Polo Box 1.9 SDI	AGD	Diesel	1896	4	22
01/85→09/94	Polo Classic 1.0	AAK	Petrol	1043	4	4
01/85→09/94	Polo Classic 1.0	AAU	Petrol	1043	4	5
01/85→10/86	Polo Classic 1.0	GL	Petrol	1043	4	4
01/85→09/94	Polo Classic 1.0	HZ	Petrol	1043	4	4
01/85→07/87	Polo Classic 1.3	HK	Petrol	1272	4	4
01/85→07/87	Polo Classic 1.3	MH	Petrol	1272	4	4
07/87→09/94	Polo Classic 1.3 CAT	MH	Petrol	1272	4	4
07/87→09/94	Polo Classic 1.3 CAT	NZ	Petrol	1272	4	4
08/86→12/88	Polo Classic 1.3 D	MN	Diesel	1272	4	3
10/90→09/94	Polo Classic 1.4 D	1W	Diesel	1398	4	3
06/96→09/01	Polo Classic 1.9 SDI	AEY	Diesel	1896	4	22
01/97→08/99	Polo Classic 1.9 TDI	AHU	Diesel	1896	4	22
01/98→08/99	Polo Classic 54 1.4	ANX	Petrol	1389	4	12
07/97→09/01	Polo Classic 57 1.7 SDI	AKW	Diesel	1716	4	22
12/95→09/01	Polo Classic 60 1.4	AEX	Petrol	1390	4	12
12/95→09/01	Polo Classic 60 1.4	AKK	Petrol	1390	4	13
12/95→09/01	Polo Classic 60 1.4	AKV	Petrol	1390	4	12
12/95→09/01	Polo Classic 60 1.4	ANW	Petrol	1390	4	13
12/95→09/01	Polo Classic 60 1.4	APQ	Petrol	1390	4	12
12/95→09/01	Polo Classic 60 1.4	AUD	Petrol	1390	4	13
01/96→10/96	Polo Classic 64 1.9 D	1Y	Diesel	1896	4	21
12/95→08/99	Polo Classic 64 1.9 SDI	AEY	Diesel	1896	4	22
08/99→01/02	Polo Classic 68 1.9 SDI	AGP	Diesel	1896	4	22
08/99→01/02	Polo Classic 68 1.9 SDI	AQM	Diesel	1896	4	22
10/99→09/01	Polo Classic 75 1.4 16V	APE	Petrol	1390	4	13
10/99→09/01	Polo Classic 75 1.4 16V	AUA	Petrol	1390	4	13
11/95→09/97	Polo Classic 75 1.6	1F	Petrol	1595	4	30
11/95→09/01	Polo Classic 75 1.6	AEE	Petrol	1598	4	12
11/95→09/01	Polo Classic 75 1.6	ALM	Petrol	1598	4	12
01/97→09/01	Polo Classic 90 1.8	ABS	Petrol	1781	4	31
01/97→09/01	Polo Classic 90 1.8	ADD	Petrol	1781	4	31
01/97→09/01	Polo Classic 90 1.8	ADZ	Petrol	1781	4	31
09/96→09/01	Polo Classic 90 1.9 TDI	AGR	Diesel	1896	4	22
09/96→09/01	Polo Classic 90 1.9 TDI	AHU	Diesel	1896	4	22
09/96→09/01	Polo Classic 90 1.9 TDI	ALE	Diesel	1896	4	22

MODEL INDEX

Modelverzeichnis • Index de modele • Índice de Modelo
Indeks modelu • Модель автомобиля • دليل الموديل



CCM

x



9

Year Range	Model Name	Code	Fuel Type	CCM	x	9
09/96→09/01	Polo Classic 90 1.9 TDI	ALH	Diesel	1896	4	22
12/95→09/01	Polo Classic 100 1.6	AEH	Petrol	1595	4	35
12/95→09/01	Polo Classic 100 1.6	AFT	Petrol	1595	4	35
12/95→09/01	Polo Classic 100 1.6	AKL	Petrol	1595	4	35
12/95→09/01	Polo Classic 100 1.6	APF	Petrol	1595	4	35
12/95→09/01	Polo Classic 100 1.6	AUR	Petrol	1595	4	35
06/98→01/02	Polo Classic 110 1.9 TDI	AFN	Diesel	1896	4	22
06/98→01/02	Polo Classic 110 1.9 TDI	ASV	Diesel	1896	4	22
05/82→10/86	Polo Coupe 1.0	GL	Petrol	1043	4	4
08/85→01/92	Polo Coupe 1.0	HZ	Petrol	1043	4	4
08/89→09/94	Polo Coupe 1.0 CAT	AAK	Petrol	1043	4	4
08/89→09/94	Polo Coupe 1.0 CAT	AAU	Petrol	1043	4	5
08/89→09/94	Polo Coupe 1.0 CAT	ACM	Petrol	1043	4	4
10/81→07/83	Polo Coupe 1.1	HB	Petrol	1093	4	2
03/91→09/94	Polo Coupe 1.3	3F	Petrol	1272	4	5
09/82→09/89	Polo Coupe 1.3	GK	Petrol	1272	4	4
08/82→07/88	Polo Coupe 1.3	GT	Petrol	1272	4	7
10/81→07/83	Polo Coupe 1.3	HH	Petrol	1272	4	7
08/83→06/87	Polo Coupe 1.3	HK	Petrol	1272	4	4
08/83→06/87	Polo Coupe 1.3	MH	Petrol	1272	4	4
07/87→08/94	Polo Coupe 1.3 CAT	2G	Petrol	1272	4	4
10/89→09/94	Polo Coupe 1.3 CAT	3F	Petrol	1272	4	5
07/87→08/94	Polo Coupe 1.3 CAT	AAV	Petrol	1272	4	4
07/87→08/94	Polo Coupe 1.3 CAT	MH	Petrol	1272	4	4
07/87→08/94	Polo Coupe 1.3 CAT	NZ	Petrol	1272	4	4
08/86→08/90	Polo Coupe 1.3 D	MN	Diesel	1272	4	3
01/87→09/94	Polo Coupe 1.3 G40	PY	Petrol	1272	4	4
08/90→09/94	Polo Coupe 1.4 D	1W	Diesel	1398	4	3
07/03→	Polo Saloon 1.4	BBY	Petrol	1390	4	13
11/03→	Polo Saloon 1.4	BBZ	Petrol	1390	4	13
07/03→	Polo Saloon 1.4	BKY	Petrol	1390	4	16
07/03→	Polo Saloon 1.4 TDI	BAY	Diesel	1422	3	22
09/02→	Polo Saloon 1.9 SDI	ASY	Diesel	1896	4	22
09/02→	Polo Saloon 1.9 TDi	ATD	Diesel	1896	4	22
12/03→11/09	Polo Sedan 1.4 FSI 16V	BLM	Petrol	1390	4	13
04/02→11/09	Polo Sedan 2.0i	BBX	Petrol	1984	4	43
05/97→09/01	Polo Variant 1.4	AEX	Petrol	1390	4	12
05/97→09/01	Polo Variant 1.4	AKK	Petrol	1390	4	13
05/97→09/01	Polo Variant 1.4	AKV	Petrol	1390	4	12
05/97→09/01	Polo Variant 1.4	ANW	Petrol	1390	4	13
05/97→09/01	Polo Variant 1.4	APQ	Petrol	1390	4	12
05/97→09/01	Polo Variant 1.4	AUD	Petrol	1390	4	13
10/99→09/01	Polo Variant 1.4 16V	APE	Petrol	1390	4	13
10/99→09/01	Polo Variant 1.4 16V	AUA	Petrol	1390	4	13
05/97→09/01	Polo Variant 1.6	AEE	Petrol	1598	4	12
05/97→09/01	Polo Variant 1.6	AEH	Petrol	1595	4	35
05/97→09/01	Polo Variant 1.6	AFT	Petrol	1595	4	35
05/97→09/01	Polo Variant 1.6	AKL	Petrol	1595	4	35
05/97→09/01	Polo Variant 1.6	ALM	Petrol	1598	4	12
05/97→09/01	Polo Variant 1.6	APF	Petrol	1595	4	35
05/97→09/01	Polo Variant 1.6	AUR	Petrol	1595	4	35
08/97→09/01	Polo Variant 1.7 SDI	AKW	Diesel	1716	4	22
05/97→09/01	Polo Variant 1.8	ADZ	Petrol	1781	4	31
06/97→09/01	Polo Variant 1.9 SDI	AEY	Diesel	1896	4	22
08/99→09/01	Polo Variant 1.9 SDI	AGP	Diesel	1896	4	22
08/99→09/01	Polo Variant 1.9 SDI	AQM	Diesel	1896	4	22
06/98→09/01	Polo Variant 1.9 TDI	AFN	Diesel	1896	4	22
05/97→09/01	Polo Variant 1.9 TDI	AGR	Diesel	1896	4	22
05/97→09/01	Polo Variant 1.9 TDI	AHU	Diesel	1896	4	22



CCM



Year Range	Model Name	Code	Fuel Type	CCM	Gear	Count
05/97→09/01	Polo Variant 1.9 TDI	ALE	Diesel	1896	4	22
05/97→09/01	Polo Variant 1.9 TDI	ALH	Diesel	1896	4	22
06/98→09/01	Polo Variant 1.9 TDI	ASV	Diesel	1896	4	22
08/77→07/79	Rabbit 1.5	EH	Petrol	1457	4	27
08/79→07/80	Rabbit 1.6	EJ	Petrol	1588	4	27
08/81→02/84	Rabbit 1.7	EN	Petrol	1716	4	27
01/83→12/87	Santana	DTA	Petrol	1595	4	30
08/81→07/83	Santana 1.3	FZ	Petrol	1272	4	7
08/81→12/84	Santana 1.6	DT	Petrol	1595	4	30
	Santana 1.6	JU	Petrol	1595	4	30
08/81→12/84	Santana 1.6	WV	Petrol	1588	4	27
08/81→12/82	Santana 1.6	YP	Petrol	1588	4	27
08/81→12/84	Santana 1.6 D	CR	Diesel	1588	4	10
08/81→12/84	Santana 1.6 D	JK	Diesel	1588	4	10
12/81→12/84	Santana 1.6 TD	CY	Diesel	1588	4	9
01/83→12/84	Santana 1.8	DS	Petrol	1781	4	31
08/81→07/83	Santana 1.9	WN	Petrol	1921	5	27
08/83→12/84	Santana 2.0	HP	Petrol	1994	5	30
08/83→12/84	Santana 2.0	JS	Petrol	1994	5	30
08/82→12/83	Santana 2.1	WE	Petrol	2144	5	27
02/76→07/77	Scirocco	EE	Petrol	1588	4	26
04/74→07/79	Scirocco 1.1	FA	Petrol	1093	4	2
08/79→12/83	Scirocco 1.3	GF	Petrol	1272	4	7
08/83→07/84	Scirocco 1.3	HK	Petrol	1272	4	4
05/08→	Scirocco 1.4 TSI	CAVD	Petrol	1390	4	18
08/08→	Scirocco 1.4 TSI	CAXA	Petrol	1390	4	17
08/08→	Scirocco 1.4 TSI	CMSB	Petrol	1390	4	17
05/08→	Scirocco 1.4 TSI	CNWA	Petrol	1390	4	18
08/76→07/80	Scirocco 1.5	EH	Petrol	1457	4	27
08/78→07/80	Scirocco 1.5	GH	Petrol	1457	4	27
08/77→12/83	Scirocco 1.5	JB	Petrol	1457	4	27
02/76→07/76	Scirocco 1.6	EF	Petrol	1588	4	27
06/76→07/82	Scirocco 1.6	EG	Petrol	1588	4	28
08/79→07/80	Scirocco 1.6	EJ	Petrol	1588	4	27
01/83→12/89	Scirocco 1.6	EW	Petrol	1595	4	30
08/75→07/79	Scirocco 1.6	FN	Petrol	1588	4	29
08/75→07/79	Scirocco 1.6	FP	Petrol	1588	4	27
08/75→07/77	Scirocco 1.6	FT	Petrol	1588	4	26
04/86→07/90	Scirocco 1.6	RE	Petrol	1595	4	30
08/75→04/84	Scirocco 1.6	FR	Diesel	1588	4	27
02/74→07/80	Scirocco 1.6i	FV	Petrol	1588	4	27
08/80→07/83	Scirocco 1.7i	EN	Petrol	1716	4	27
08/82→12/89	Scirocco 1.8	DX	Petrol	1781	4	31
08/82→12/89	Scirocco 1.8	EV	Petrol	1781	4	31
08/83→07/92	Scirocco 1.8	EX	Petrol	1781	4	31
11/85→07/92	Scirocco 1.8	JH	Petrol	1781	4	31
08/82→12/89	Scirocco 1.8	JJ	Petrol	1781	4	31
08/82→12/89	Scirocco 1.8	PB	Petrol	1781	4	31
10/85→07/89	Scirocco 1.8 16V	KR	Petrol	1781	4	31
03/86→07/92	Scirocco 1.8 16V	PL	Petrol	1781	4	31
05/09→	Scirocco 2.0 TDI	CBBB	Diesel	1968	4	41
08/08→	Scirocco 2.0 TDI	CBDB	Diesel	1968	4	41
05/09→	Scirocco 2.0 TDI	CFGB	Diesel	1968	4	41
01/13→	Scirocco 2.0 TDI	CFGC	Diesel	1968	4	41
11/10→	Scirocco 2.0 TDI	CFHB	Diesel	1968	4	41
08/08→	Scirocco 2.0 TDI	CFHC	Diesel	1968	4	41
05/10→	Sharan 1.4 TSI	CAVA	Petrol	1390	4	18
05/10→	Sharan 1.4 TSI	CNWB	Petrol	1390	4	18
05/10→	Sharan 1.4 TSI	CTHA	Petrol	1390	4	18

MODEL INDEX

Modelverzeichnis • Index de modele • Índice de Modelo
Indeks modelu • Модель автомобиля • دليل الموديل



CCM

x



9

09/97→03/10	Sharan 1.8 T 20V	AJH	Petrol	1781	4	36
09/97→03/10	Sharan 1.8 T 20V	AWC	Petrol	1781	4	36
09/95→03/10	Sharan 1.9 TDI	1Z	Diesel	1896	4	22
09/96→04/00	Sharan 1.9 TDI	AFN	Diesel	1896	4	22
09/95→03/10	Sharan 1.9 TDI	AHU	Diesel	1896	4	22
09/95→03/10	Sharan 1.9 TDI	ANU	Diesel	1896	4	22
11/02→03/10	Sharan 1.9 TDI	ASZ	Diesel	1896	4	22
04/00→03/10	Sharan 1.9 TDI	AUY	Diesel	1896	4	22
09/96→04/00	Sharan 1.9 TDI	AVG	Diesel	1896	4	22
06/05→03/10	Sharan 1.9 TDI	BTB	Diesel	1896	4	23
04/00→03/10	Sharan 1.9 TDI	BVK	Diesel	1896	4	24
04/00→03/10	Sharan 1.9 TDI 4motion	AUY	Diesel	1896	4	22
04/00→03/10	Sharan 1.9 TDI 4motion	BVK	Diesel	1896	4	24
09/95→03/10	Sharan 2.0	ADY	Petrol	1984	4	43
09/95→03/10	Sharan 2.0	ATM	Petrol	1984	4	43
09/95→02/00	Sharan 2.0 16V	ABF	Petrol	1984	4	43
04/06→03/10	Sharan 2.0 LPG	ATM	Petrol	1984	4	43
11/05→03/10	Sharan 2.0 TDI	BRT	Diesel	1968	4	39
05/10→	Sharan 2.0 TDI	CFFA	Diesel	1968	4	41
05/10→	Sharan 2.0 TDI	CFFB	Diesel	1968	4	41
05/11→	Sharan 2.0 TDI	CFFE	Diesel	1968	4	41
08/10→	Sharan 2.0 TDI	CFGB	Diesel	1968	4	41
01/13→	Sharan 2.0 TDI	CFGC	Diesel	1968	4	41
05/11→05/12	Sharan 2.0 TDI 4motion	CFFA	Diesel	1968	4	41
05/11→	Sharan 2.0 TDI 4motion	CFFB	Diesel	1968	4	41
04/00→03/10	Sharan 2.8 V6 24V	AYL	Petrol	2792	V6	32
04/00→03/10	Sharan 2.8 V6 24V 4motion	AYL	Petrol	2792	V6	32
09/95→04/00	Sharan 2.8 VR6	AAA	Petrol	2792	V6	32
09/95→04/00	Sharan 2.8 VR6	AMY	Petrol	2792	V6	32
11/96→04/00	Sharan 2.8 VR6 Syncro	AAA	Petrol	2792	V6	32
11/96→04/00	Sharan 2.8 VR6 Syncro	AMY	Petrol	2792	V6	32
	Stationary engine	ADF	Petrol	1781	4	30
	Stationary engine	BEF	Gas	1984	4	43
04/94→01/02	Stationary engine	ADE	Diesel	1896	4	21
04/94→01/02	Stationary engine	ADG	Diesel	1896	4	21
	Stationary engine	BCT (SDI 55-5)	Diesel	2461	5	37
	Stationary engine	BCU (TDI 100-5)	Diesel	2461	5	37
	Stationary engine	BCV	Diesel	2461	5	37
	Stationary engine	BEQ	Diesel	1896	4	23
	Stationary engine	BEU	Diesel	1896	4	24
	Stationary engine	BGL	Diesel	1896	4	23
	Stationary engine	BGM	Diesel	1896	4	23
	Stationary engine	BJC	Diesel	1896	4	23
	Stationary engine	BVD	Diesel	1968	4	39
	Stationary engine	BXT	Diesel	1896	4	23
	Stationary engine	CDXA	Diesel	1896	4	23
	Stationary engine	CDXB	Diesel	1896	4	23
09/79→12/82	T2 1.6	CZ	Petrol	1584	B4	51
06/89→03/97	Taro 2.4 D	2L	Diesel	2446	4	55
04/89→03/97	Taro 2.4 D 4x4	2L	Diesel	2446	4	55
05/08→	Tiguan 1.4 TSI	BWK	Petrol	1390	4	18
05/08→	Tiguan 1.4 TSI	CAVA	Petrol	1390	4	18
05/11→	Tiguan 1.4 TSI	CAVD	Petrol	1390	4	18
08/10→	Tiguan 1.4 TSI	CAXA	Petrol	1390	4	17
05/08→	Tiguan 1.4 TSI	CTHA	Petrol	1390	4	18
09/07→	Tiguan 1.4 TSI 4motion	BWK	Petrol	1390	4	18
09/07→	Tiguan 1.4 TSI 4motion	CAVA	Petrol	1390	4	18
05/11→	Tiguan 1.4 TSI 4motion	CAVD	Petrol	1390	4	18
09/07→	Tiguan 1.4 TSI 4motion	CTHA	Petrol	1390	4	18



CCM

x



9

03/08→	Tiguan 2.0 TDI	CBAB	Diesel	1968	4	41
03/08→	Tiguan 2.0 TDI	CFFB	Diesel	1968	4	41
05/10→	Tiguan 2.0 TDI	CFFD	Diesel	1968	4	41
11/07→	Tiguan 2.0 TDI 4motion	CBAА	Diesel	1968	4	41
09/07→	Tiguan 2.0 TDI 4motion	CBAB	Diesel	1968	4	41
02/08→08/09	Tiguan 2.0 TDI 4motion	CBBA	Diesel	1968	4	41
09/07→	Tiguan 2.0 TDI 4motion	CBBB	Diesel	1968	4	41
11/07→	Tiguan 2.0 TDI 4motion	CFFA	Diesel	1968	4	41
09/07→	Tiguan 2.0 TDI 4motion	CFFB	Diesel	1968	4	41
09/07→	Tiguan 2.0 TDI 4motion	CFGB	Diesel	1968	4	41
11/12→	Tiguan 2.0 TDI 4motion	CFGC	Diesel	1968	4	41
09/07→	Tiguan 2.0 TDI 4motion	CLJA	Diesel	1968	4	41
01/03→05/10	Touareg 2.5 R5 TDI	BAC	Diesel	2461	5	37
08/03→05/10	Touareg 2.5 R5 TDI	BLK	Diesel	2461	5	37
04/06→05/10	Touareg 3.0 TDI	BUN	Diesel	2967	V6	45
04/06→05/10	Touareg 3.0 TDI	CASB	Diesel	2967	V6	47
11/04→05/10	Touareg 3.0 V6 TDI	BKS	Diesel	2967	V6	45
11/07→	Touareg 3.0 V6 TDI	CASA	Diesel	2967	V6	46
11/07→05/10	Touareg 3.0 V6 TDI	CASC	Diesel	2967	V6	46
01/10→	Touareg 3.0 V6 TDI	CASD	Diesel	2967	V6	46
11/04→	Touareg 3.0 V6 TDI	CATA	Diesel	2967	V6	47
01/10→	Touareg 3.0 V6 TDI	CJMA	Diesel	2967	V6	46
10/02→11/06	Touareg 3.2 V6	AZZ	Petrol	3189	V6	49
10/02→11/06	Touareg 3.2 V6	BAA	Petrol	3189	V6	49
10/02→11/06	Touareg 3.2 V6	BKJ	Petrol	3189	V6	49
10/02→11/06	Touareg 3.2 V6	BMV	Petrol	3189	V6	49
10/02→11/06	Touareg 3.2 V6	BMX	Petrol	3189	V6	49
12/02→11/06	Touareg 4.2 V8	AXQ	Petrol	4172	V8	50
12/02→11/06	Touareg 4.2 V8	BHX	Petrol	4172	V8	50
08/07→05/10	Touareg 5.0 R50 TDI	CBWA	Diesel	4921	V10	37
10/02→05/10	Touareg 5.0 V10 TDI	AYH	Diesel	4921	V10	37
11/06→05/10	Touran 1.4 FSI	BLG	Petrol	1390	4	18
11/06→05/10	Touran 1.4 FSI	CAVB	Petrol	1390	4	18
02/06→05/10	Touran 1.4 TSI	BMV	Petrol	1390	4	18
05/10→	Touran 1.4 TSI	CAVB	Petrol	1390	4	18
02/06→	Touran 1.4 TSI	CAVC	Petrol	1390	4	18
07/03→05/10	Touran 1.6	BGU	Petrol	1595	4	38
07/03→05/10	Touran 1.6	BSE	Petrol	1595	4	38
07/03→05/10	Touran 1.6	BSF	Petrol	1595	4	38
02/03→01/07	Touran 1.6 FSI	BLF	Petrol	1598	4	17
02/03→01/07	Touran 1.6 FSI	BLP	Petrol	1598	4	17
05/10→	Touran 1.6 TDI	CAYB	Diesel	1598	4	25
05/10→	Touran 1.6 TDI	CAYC	Diesel	1598	4	25
02/03→05/04	Touran 1.9 TDI	AVQ	Diesel	1896	4	22
08/03→05/10	Touran 1.9 TDI	BKC	Diesel	1896	4	24
08/03→05/10	Touran 1.9 TDI	BLS	Diesel	1896	4	24
11/04→05/10	Touran 1.9 TDI	BRU	Diesel	1896	4	24
08/03→05/10	Touran 1.9 TDI	BXE	Diesel	1896	4	24
11/04→05/10	Touran 1.9 TDI	BXF	Diesel	1896	4	24
11/04→05/10	Touran 1.9 TDI	BXJ	Diesel	1896	4	24
10/03→11/05	Touran 2.0 FSI	AXW	Petrol	1984	4	44
10/03→11/05	Touran 2.0 FSI	BLR	Petrol	1984	4	44
10/03→11/05	Touran 2.0 FSI	BLX	Petrol	1984	4	44
10/03→11/05	Touran 2.0 FSI	BLY	Petrol	1984	4	44
10/03→11/05	Touran 2.0 FSI	BVY	Petrol	1984	4	44
10/03→11/05	Touran 2.0 FSI	BVZ	Petrol	1984	4	44
02/03→05/10	Touran 2.0 TDI	AZV	Diesel	1968	4	39
12/05→05/10	Touran 2.0 TDI	BMM	Diesel	1968	4	39
12/05→05/10	Touran 2.0 TDI	BMN	Diesel	1968	4	39

MODEL INDEX

Modelverzeichnis • Index de modele • Índice de Modelo
Indeks modelu • Модель автомобиля • دليل الموديل



CCM

x



9

05/10→	Touran 2.0 TDI	CFHC	Diesel	1968	4	41
12/05→	Touran 2.0 TDI	CFJA	Diesel	1968	4	41
01/13→	Touran 2.0 TDI	CFJB	Diesel	1968	4	41
11/10→	Touran 2.0 TDI	CLCA	Diesel	1968	4	41
08/03→05/10	Touran 2.0 TDI 16V	BKD	Diesel	1968	4	39
08/64→12/68	Transporter I Box 1.6	B	Diesel	1584	B4	51
06/66→07/67	Transporter I Bus 1.6	B	Diesel	1584	B4	51
08/70→04/79	Transporter II Box 1.6	AE	Petrol	1584	B4	51
08/70→04/79	Transporter II Box 1.6	AS	Petrol	1584	B4	51
11/73→07/75	Transporter II Box 1.8	AP	Petrol	1795	4	57
08/75→07/79	Transporter II Box 2.0	CJ	Petrol	1970	B4	58
08/75→07/79	Transporter II Box 2.0	GE	Petrol	1970	B4	58
08/70→04/79	Transporter II Bus 1.6	AH	Petrol	1584	B4	51
08/70→04/79	Transporter II Bus 1.6	AS	Petrol	1584	B4	51
11/73→07/75	Transporter II Bus 1.8	AP	Petrol	1795	4	57
08/75→04/79	Transporter II Bus 2.0	CJ	Petrol	1970	B4	58
08/75→04/79	Transporter II Bus 2.0	GE	Petrol	1970	B4	58
08/68→07/79	Transporter II Platform/Chassis 1.6	AS	Petrol	1584	B4	51
01/81→07/87	Transporter III Box 1.6 D	CS	Diesel	1588	4	10
10/84→07/92	Transporter III Box 1.6 TD	JX	Diesel	1588	4	9
03/86→07/92	Transporter III Box 1.6 TD Syncro	JX	Diesel	1588	4	9
08/85→07/92	Transporter III Box 1.7 D	KY	Diesel	1715	4	21
10/82→07/92	Transporter III Box 1.9	DF	Petrol	1915	4	58
10/84→02/89	Transporter III Box 1.9	DH	Petrol	1913	B4	58
08/83→02/89	Transporter III Box 1.9	GW	Petrol	1913	B4	58
10/82→07/92	Transporter III Box 1.9	DG	Diesel	1915	B4	58
11/84→07/92	Transporter III Box 1.9 Syncro	DG	Diesel	1915	B4	58
05/79→04/86	Transporter III Box 2.0	CU	Petrol	1970	B4	58
03/86→07/92	Transporter III Box 2.1	DJ	Petrol	2109	B4	59
08/85→07/92	Transporter III Box 2.1	MV	Petrol	2109	B4	59
07/89→07/92	Transporter III Box 2.1 i	SS	Diesel	2109	4	59
03/86→07/92	Transporter III Box 2.1 Syncro	DJ	Petrol	2109	B4	59
08/85→07/92	Transporter III Box 2.1 Syncro	MV	Petrol	2109	B4	59
01/81→07/87	Transporter III Bus 1.6 D	CS	Diesel	1588	4	10
08/84→07/92	Transporter III Bus 1.6 TD	JX	Diesel	1588	4	9
03/86→07/92	Transporter III Bus 1.6 TD Syncro	JX	Diesel	1588	4	9
10/86→07/92	Transporter III Bus 1.7 D	KY	Diesel	1715	4	21
08/82→07/92	Transporter III Bus 1.9	DF	Petrol	1915	4	58
01/83→07/85	Transporter III Bus 1.9	DH	Petrol	1913	B4	58
08/83→07/85	Transporter III Bus 1.9	GW	Petrol	1913	B4	58
	Transporter III Bus 1.9	SP	Petrol	1915	B4	58
08/82→07/92	Transporter III Bus 1.9	DG	Diesel	1915	B4	58
02/85→07/92	Transporter III Bus 1.9 Syncro	DG	Diesel	1915	B4	58
05/79→12/82	Transporter III Bus 2.0	CU	Petrol	1970	B4	58
05/79→12/82	Transporter III Bus 2.0	CV	Petrol	1970	B4	58
08/85→07/92	Transporter III Bus 2.1	DJ	Petrol	2109	B4	59
08/85→07/92	Transporter III Bus 2.1	MV	Petrol	2109	B4	59
10/86→07/92	Transporter III Bus 2.1	SR	Petrol	2109	4	59
06/89→07/92	Transporter III Bus 2.1 CAT	MV	Petrol	2109	B4	59
07/89→07/92	Transporter III Bus 2.1 i	SS	Diesel	2109	4	59
01/86→07/92	Transporter III Bus 2.1 Syncro	DJ	Petrol	2109	B4	59
08/85→07/92	Transporter III Bus 2.1 Syncro	MV	Petrol	2109	B4	59
10/86→07/92	Transporter III Bus 2.1 Syncro	SR	Petrol	2109	4	59
03/86→07/92	Transporter III Platform/Chassis 2.1 Syncro	DJ	Petrol	2109	B4	59
08/85→07/92	Transporter III Platform/Chassis 2.1 Syncro	MV	Petrol	2109	B4	59
12/84→07/92	Transporter III Platform/Chassis 1.9 Syncro	DG	Diesel	1915	B4	58
03/86→07/92	Transporter III Platform/Chassis 1.6 TD Syncro	JX	Diesel	1588	4	9
01/81→07/87	Transporter III Platform/Chassis 1.6 D	CS	Diesel	1588	4	10
10/84→07/92	Transporter III Platform/Chassis 1.6 TD	JX	Diesel	1588	4	9



CCM

x



08/85→07/92	Transporter III Platform/Chassis 1.7 D	KY	Diesel	1715	4	21
09/82→07/92	Transporter III Platform/Chassis 1.9	DF	Petrol	1915	4	58
10/84→02/89	Transporter III Platform/Chassis 1.9	DH	Petrol	1913	B4	58
08/82→07/92	Transporter III Platform/Chassis 1.9	DG	Diesel	1915	B4	58
05/79→04/86	Transporter III Platform/Chassis 2.0	CU	Petrol	1970	B4	58
03/86→07/92	Transporter III Platform/Chassis 2.1	DJ	Petrol	2109	B4	59
08/85→07/92	Transporter III Platform/Chassis 2.1	MV	Petrol	2109	B4	59
07/89→07/92	Transporter III Platform/Chassis 2.1 i	SS	Diesel	2109	4	59
07/90→12/95	Transporter IV Box 1.9 D	1X	Diesel	1896	4	21
10/92→04/03	Transporter IV Box 1.9 TD	ABL	Diesel	1896	4	21
07/90→04/03	Transporter IV Box 2.0	AAC	Petrol	1968	4	33
07/90→04/98	Transporter IV Box 2.4 D	AAB	Diesel	2370	5	21
08/97→04/03	Transporter IV Box 2.4 D	AJA	Diesel	2370	5	21
10/92→09/98	Transporter IV Box 2.4 D Syncro	AAB	Diesel	2370	5	21
11/90→04/03	Transporter IV Box 2.5	AAF	Petrol	2459	5	33
11/90→04/03	Transporter IV Box 2.5	ACU	Petrol	2459	5	33
08/96→04/03	Transporter IV Box 2.5	AET	Petrol	2461	5	33
11/90→04/03	Transporter IV Box 2.5	AEU	Petrol	2459	5	33
08/96→04/03	Transporter IV Box 2.5	APL	Petrol	2461	5	33
08/96→04/03	Transporter IV Box 2.5	AVT	Petrol	2461	5	33
10/92→04/03	Transporter IV Box 2.5 Syncro	AAF	Petrol	2459	5	33
10/92→04/03	Transporter IV Box 2.5 Syncro	ACU	Petrol	2459	5	33
08/96→04/03	Transporter IV Box 2.5 Syncro	AET	Petrol	2461	5	33
10/92→04/03	Transporter IV Box 2.5 Syncro	AEU	Petrol	2459	5	33
08/96→04/03	Transporter IV Box 2.5 Syncro	APL	Petrol	2461	5	33
08/96→04/03	Transporter IV Box 2.5 Syncro	AVT	Petrol	2461	5	33
09/95→04/03	Transporter IV Box 2.5 TDI	ACV	Diesel	2461	5	34
12/98→04/03	Transporter IV Box 2.5 TDI	AJT	Diesel	2461	5	34
09/95→04/03	Transporter IV Box 2.5 TDI	AUF	Diesel	2461	5	34
09/00→04/03	Transporter IV Box 2.5 TDI	AXG	Diesel	2461	5	34
09/95→04/03	Transporter IV Box 2.5 TDI	AYC	Diesel	2461	5	34
12/98→04/03	Transporter IV Box 2.5 TDI	AYY	Diesel	2461	5	34
09/95→04/03	Transporter IV Box 2.5 TDI Syncro	ACV	Diesel	2461	5	34
09/95→04/03	Transporter IV Box 2.5 TDI Syncro	AXL	Diesel	2461	5	34
05/96→05/00	Transporter IV Box 2.8 VR6	AES	Petrol	2792	V6	32
06/00→04/03	Transporter IV Box 2.8 VR6	AMV	Petrol	2792	V6	32
12/90→07/92	Transporter IV Bus 1.8	PD	Petrol	1781	4	33
09/90→12/95	Transporter IV Bus 1.9 D	1X	Diesel	1896	4	21
10/92→04/03	Transporter IV Bus 1.9 TD	ABL	Diesel	1896	4	21
09/90→04/03	Transporter IV Bus 2.0	AAC	Petrol	1968	4	33
09/90→04/98	Transporter IV Bus 2.4 D	AAB	Diesel	2370	5	21
08/97→04/03	Transporter IV Bus 2.4 D	AJA	Diesel	2370	5	21
10/92→09/98	Transporter IV Bus 2.4 D Syncro	AAB	Diesel	2370	5	21
11/90→04/03	Transporter IV Bus 2.5	AAF	Petrol	2459	5	33
11/90→04/03	Transporter IV Bus 2.5	ACU	Petrol	2459	5	33
08/96→04/03	Transporter IV Bus 2.5	AET	Petrol	2461	5	33
11/90→04/03	Transporter IV Bus 2.5	AEU	Petrol	2459	5	33
08/96→04/03	Transporter IV Bus 2.5	APL	Petrol	2461	5	33
08/96→04/03	Transporter IV Bus 2.5	AVT	Petrol	2461	5	33
11/92→04/03	Transporter IV Bus 2.5 Syncro	AAF	Petrol	2459	5	33
11/92→04/03	Transporter IV Bus 2.5 Syncro	ACU	Petrol	2459	5	33
07/96→04/03	Transporter IV Bus 2.5 Syncro	AET	Petrol	2461	5	33
11/92→04/03	Transporter IV Bus 2.5 Syncro	AEU	Petrol	2459	5	33
07/96→04/03	Transporter IV Bus 2.5 Syncro	APL	Petrol	2461	5	33
07/96→04/03	Transporter IV Bus 2.5 Syncro	AVT	Petrol	2461	5	33
09/95→04/03	Transporter IV Bus 2.5 TDI	ACV	Diesel	2461	5	34
05/98→04/03	Transporter IV Bus 2.5 TDI	AHY	Diesel	2461	5	34
05/98→04/03	Transporter IV Bus 2.5 TDI	AJT	Diesel	2461	5	34
09/95→04/03	Transporter IV Bus 2.5 TDI	AUF	Diesel	2461	5	34

MODEL INDEX

Modelverzeichnis • Index de modele • Índice de Modelo
Indeks modelu • Модель автомобиля • دليل الموديل



CCM

x



9

05/98→04/03	Transporter IV Bus 2.5 TDI	AXG	Diesel	2461	5	34
09/95→04/03	Transporter IV Bus 2.5 TDI	AYC	Diesel	2461	5	34
05/98→04/03	Transporter IV Bus 2.5 TDI	AYY	Diesel	2461	5	34
01/96→04/03	Transporter IV Bus 2.5 TDI Syncro	ACV	Diesel	2461	5	34
01/96→04/03	Transporter IV Bus 2.5 TDI Syncro	AXL	Diesel	2461	5	34
11/95→04/00	Transporter IV Bus 2.8 VR 6	AES	Petrol	2792	V6	32
04/00→04/03	Transporter IV Bus 2.8 VR6	AMV	Petrol	2792	V6	32
01/96→04/96	Transporter IV Bus 2.8 VR6 Syncro	AES	Petrol	2792	V6	32
10/92→04/03	Transporter IV Platform/Chassis 2.5 Syncro	AAF	Petrol	2459	5	33
10/92→04/03	Transporter IV Platform/Chassis 2.5 Syncro	ACU	Petrol	2459	5	33
08/96→04/03	Transporter IV Platform/Chassis 2.5 Syncro	AET	Petrol	2461	5	33
10/92→04/03	Transporter IV Platform/Chassis 2.5 Syncro	AEU	Petrol	2459	5	33
08/96→04/03	Transporter IV Platform/Chassis 2.5 Syncro	APL	Petrol	2461	5	33
08/96→04/03	Transporter IV Platform/Chassis 2.5 Syncro	AVT	Petrol	2461	5	33
10/92→09/98	Transporter IV Platform/Chassis 2.4 D Syncro	AAB	Diesel	2370	5	21
05/98→04/03	Transporter IV Platform/Chassis 2.5 TDI Syncro	ACV	Diesel	2461	5	34
05/98→04/03	Transporter IV Platform/Chassis 2.5 TDI Syncro	AXL	Diesel	2461	5	34
12/90→07/92	Transporter IV Platform/Chassis 1.8	PD	Petrol	1781	4	33
07/90→12/95	Transporter IV Platform/Chassis 1.9 D	1X	Diesel	1896	4	21
10/92→04/03	Transporter IV Platform/Chassis 1.9 TD	ABL	Diesel	1896	4	21
07/90→04/03	Transporter IV Platform/Chassis 2.0	AAC	Petrol	1968	4	33
09/90→04/98	Transporter IV Platform/Chassis 2.4 D	AAB	Diesel	2370	5	21
08/97→04/03	Transporter IV Platform/Chassis 2.4 D	AJA	Diesel	2370	5	21
11/90→04/03	Transporter IV Platform/Chassis 2.5	AAF	Petrol	2459	5	33
11/90→04/03	Transporter IV Platform/Chassis 2.5	ACU	Petrol	2459	5	33
08/96→04/03	Transporter IV Platform/Chassis 2.5	AET	Petrol	2461	5	33
11/90→04/03	Transporter IV Platform/Chassis 2.5	AEU	Petrol	2459	5	33
08/96→04/03	Transporter IV Platform/Chassis 2.5	APL	Petrol	2461	5	33
08/96→04/03	Transporter IV Platform/Chassis 2.5	AVT	Petrol	2461	5	33
09/95→04/03	Transporter IV Platform/Chassis 2.5 TDI	ACV	Diesel	2461	5	34
05/98→04/03	Transporter IV Platform/Chassis 2.5 TDI	AJT	Diesel	2461	5	34
09/95→04/03	Transporter IV Platform/Chassis 2.5 TDI	AUF	Diesel	2461	5	34
09/95→04/03	Transporter IV Platform/Chassis 2.5 TDI	AYC	Diesel	2461	5	34
05/98→04/03	Transporter IV Platform/Chassis 2.5 TDI	AYY	Diesel	2461	5	34
05/96→05/00	Transporter IV Platform/Chassis 2.8	AES	Petrol	2792	V6	32
06/00→04/03	Transporter IV Platform/Chassis 2.8 VR6	AMV	Petrol	2792	V6	32
04/03→11/09	Transporter V Box 1.9 TDI	AXB	Diesel	1896	4	22
04/03→11/09	Transporter V Box 1.9 TDI	AXC	Diesel	1896	4	22
01/06→11/09	Transporter V Box 1.9 TDI	BRR	Diesel	1896	4	24
06/06→11/09	Transporter V Box 1.9 TDI	BRS	Diesel	1896	4	24
11/03→	Transporter V Box 2.0	AXA	Petrol	1984	4	43
09/09→	Transporter V Box 2.0 BiTDI	CFCA Euro 5	Diesel	1968	4	40
09/09→	Transporter V Box 2.0 BiTDI 4motion	CFCA Euro 5	Diesel	1968	4	40
09/09→	Transporter V Box 2.0 TDI	CAAA Euro 5	Diesel	1968	4	40
09/09→	Transporter V Box 2.0 TDI	CAAB Euro 5	Diesel	1968	4	40
09/09→	Transporter V Box 2.0 TDI	CAAC Euro 5	Diesel	1968	4	40
05/11→	Transporter V Box 2.0 TDI	CAAD	Diesel	1968	4	40
05/10→	Transporter V Box 2.0 TDI	CAAE	Diesel	1968	4	40
09/09→	Transporter V Box 2.0 TDI	CCHA	Diesel	1968	4	40
05/10→	Transporter V Box 2.0 TDI	CCHB	Diesel	1968	4	40
09/09→	Transporter V Box 2.0 TDI 4motion	CAAC Euro 5	Diesel	1968	4	40
05/10→	Transporter V Box 2.0 TDI 4motion	CAAE	Diesel	1968	4	40
09/09→	Transporter V Box 2.0 TDI 4motion	CCHA	Diesel	1968	4	40
05/10→	Transporter V Box 2.0 TDI 4motion	CCHB	Diesel	1968	4	40
04/03→11/09	Transporter V Box 2.5 TDI	AXD	Diesel	2461	5	37
04/03→11/09	Transporter V Box 2.5 TDI	AXE	Diesel	2461	5	37
04/03→11/09	Transporter V Box 2.5 TDI	BNZ	Diesel	2460	5	40
07/04→11/09	Transporter V Box 2.5 TDI 4motion	AXD	Diesel	2461	5	37
07/04→11/09	Transporter V Box 2.5 TDI 4motion	AXE	Diesel	2461	5	37



CCM

x



9

07/04→11/09	Transporter V Box 2.5 TDI 4motion	BNZ	Diesel	2460	5	40
11/03→11/09	Transporter V Box 3.2 4motion	BKK	Petrol	3189	V6	49
11/03→11/09	Transporter V Box 3.2 4motion	CFLA	Petrol	3189	V6	49
04/03→06/04	Transporter V Box 3.2 V6	BDL	Petrol	3189	V6	49
02/04→11/09	Transporter V Box 3.2 V6	BKK	Petrol	3189	V6	49
02/04→11/09	Transporter V Box 3.2 V6	CFLA	Petrol	3189	V6	49
04/03→11/09	Transporter V Bus 1.9 TDI	AXB	Diesel	1896	4	22
04/03→11/09	Transporter V Bus 1.9 TDI	AXC	Diesel	1896	4	22
01/06→11/09	Transporter V Bus 1.9 TDI	BRR	Diesel	1896	4	24
06/06→11/09	Transporter V Bus 1.9 TDI	BRS	Diesel	1896	4	24
11/03→	Transporter V Bus 2.0	AXA	Petrol	1984	4	43
09/09→	Transporter V Bus 2.0 BiTDI	CFCA Euro 5	Diesel	1968	4	40
09/09→	Transporter V Bus 2.0 BiTDI 4motion	CFCA Euro 5	Diesel	1968	4	40
09/09→	Transporter V Bus 2.0 TDI	CAAA Euro 5	Diesel	1968	4	40
09/09→	Transporter V Bus 2.0 TDI	CAAB Euro 5	Diesel	1968	4	40
09/09→	Transporter V Bus 2.0 TDI	CAAC Euro 5	Diesel	1968	4	40
05/11→	Transporter V Bus 2.0 TDI	CAAD	Diesel	1968	4	40
05/10→	Transporter V Bus 2.0 TDI	CAAE	Diesel	1968	4	40
09/09→	Transporter V Bus 2.0 TDI	CCHA	Diesel	1968	4	40
05/10→	Transporter V Bus 2.0 TDI	CCHB	Diesel	1968	4	40
09/09→	Transporter V Bus 2.0 TDI 4motion	CAAC Euro 5	Diesel	1968	4	40
05/10→	Transporter V Bus 2.0 TDI 4motion	CAAE	Diesel	1968	4	40
09/09→	Transporter V Bus 2.0 TDI 4motion	CCHA	Diesel	1968	4	40
05/10→	Transporter V Bus 2.0 TDI 4motion	CCHB	Diesel	1968	4	40
04/03→11/09	Transporter V Bus 2.5 TDI	AXD	Diesel	2461	5	37
04/03→11/09	Transporter V Bus 2.5 TDI	AXE	Diesel	2461	5	37
11/03→11/09	Transporter V Bus 2.5 TDi	BLJ	Diesel	2461	5	37
04/03→11/09	Transporter V Bus 2.5 TDI	BNZ	Diesel	2460	5	40
07/04→11/09	Transporter V Bus 2.5 TDI 4motion	AXD	Diesel	2461	5	37
07/04→11/09	Transporter V Bus 2.5 TDI 4motion	AXE	Diesel	2461	5	37
07/04→11/09	Transporter V Bus 2.5 TDI 4motion	BNZ	Diesel	2460	5	40
02/04→06/04	Transporter V Bus 3.2 V6	BDL	Petrol	3189	V6	49
02/04→11/09	Transporter V Bus 3.2 V6	BKK	Petrol	3189	V6	49
02/04→11/09	Transporter V Bus 3.2 V6	CFLA	Petrol	3189	V6	49
11/03→11/09	Transporter V Bus 3.2 V6 4motion	BKK	Petrol	3189	V6	49
11/03→11/09	Transporter V Bus 3.2 V6 4motion	CFLA	Petrol	3189	V6	49
07/04→11/09	Transporter V Platform/Chassis 2.5 TDI 4motion	AXD	Diesel	2461	5	37
04/04→11/09	Transporter V Platform/Chassis 2.5 TDI 4motion	AXE	Diesel	2461	5	37
07/04→11/09	Transporter V Platform/Chassis 2.5 TDI 4motion	BNZ	Diesel	2460	5	40
09/09→	Transporter V Platform/Chassis 2.0 TDI 4motion	CAAC Euro 5	Diesel	1968	4	40
05/10→	Transporter V Platform/Chassis 2.0 TDI 4motion	CAAE	Diesel	1968	4	40
05/10→	Transporter V Platform/Chassis 2.0 TDI 4motion	CCHB	Diesel	1968	4	40
09/09→	Transporter V Platform/Chassis 2.0 BiTDI	CFCA Euro 5	Diesel	1968	4	40
09/09→	Transporter V Platform/Chassis 2.0 BiTDI 4motion	CFCA Euro 5	Diesel	1968	4	40
04/03→11/09	Transporter V Platform/Chassis 1.9 TDI	AXB	Diesel	1896	4	22
04/03→11/09	Transporter V Platform/Chassis 1.9 TDI	AXC	Diesel	1896	4	22
01/06→11/09	Transporter V Platform/Chassis 1.9 TDI	BRR	Diesel	1896	4	24
06/06→11/09	Transporter V Platform/Chassis 1.9 TDI	BRS	Diesel	1896	4	24
11/03→	Transporter V Platform/Chassis 2.0	AXA	Petrol	1984	4	43
09/09→	Transporter V Platform/Chassis 2.0 TDI	CAAA Euro 5	Diesel	1968	4	40
09/09→	Transporter V Platform/Chassis 2.0 TDI	CAAB Euro 5	Diesel	1968	4	40
09/09→	Transporter V Platform/Chassis 2.0 TDI	CAAC Euro 5	Diesel	1968	4	40
05/11→	Transporter V Platform/Chassis 2.0 TDI	CAAD	Diesel	1968	4	40
05/10→	Transporter V Platform/Chassis 2.0 TDI	CAAE	Diesel	1968	4	40
04/03→11/09	Transporter V Platform/Chassis 2.5 TDI	AXD	Diesel	2461	5	37
04/03→11/09	Transporter V Platform/Chassis 2.5 TDI	AXE	Diesel	2461	5	37
04/03→11/09	Transporter V Platform/Chassis 2.5 TDI	BNZ	Diesel	2460	5	40

MODEL INDEX

Modelverzeichnis • Index de modele • Índice de Modelo
Indeks modelu • Модель автомобиля • دليل الموديل



CCM

x



9

02/04→11/09	Transporter V Platform/Chassis 3.2 V6	BDL	Petrol	3189	V6	49
08/03→05/06	Transporter V Platform/Chassis 3.2 V6	BKK	Petrol	3189	V6	49
08/67→	Typ 1	211, 311	Petrol	1584	B4	51
08/67→	Typ 2	211, 311	Petrol	1584	B4	51
08/67→	Typ 3	211, 311	Petrol	1584	B4	51
01/67→12/75	Variant 1600 A	211, 311	Petrol	1584	B4	51
01/67→12/75	Variant 1600 L	211, 311	Petrol	1584	B4	51
01/67→12/75	Variant 1600 TL	211, 311	Petrol	1584	B4	51
11/91→09/98	Vento 1.4	ABD	Petrol	1391	4	5
11/91→09/98	Vento 1.4	AEX	Petrol	1390	4	12
09/92→09/98	Vento 1.6	ABU	Petrol	1598	4	11
09/92→09/98	Vento 1.6	AEA	Petrol	1598	4	12
09/92→09/98	Vento 1.6	AEE	Petrol	1598	4	12
10/94→09/98	Vento 1.6	AEK	Petrol	1595	4	35
10/94→09/98	Vento 1.6	AFT	Petrol	1595	4	35
11/91→09/98	Vento 1.8	AAM	Petrol	1781	4	30
11/91→09/98	Vento 1.8	ABS	Petrol	1781	4	31
11/91→09/98	Vento 1.8	ADZ	Petrol	1781	4	31
11/91→09/98	Vento 1.9 D	1Y	Diesel	1896	4	21
04/97→09/98	Vento 1.9 SDI	AEY	Diesel	1896	4	22
11/91→09/98	Vento 1.9 TD	AAZ	Diesel	1896	4	21
09/93→09/98	Vento 1.9 TDI	1Z	Diesel	1896	4	22
04/96→09/98	Vento 1.9 TDI	AFN	Diesel	1896	4	22
09/93→09/98	Vento 1.9 TDI	AHU	Diesel	1896	4	22
09/93→09/98	Vento 1.9 TDI	ALE	Diesel	1896	4	22
11/91→09/98	Vento 2.0	2E	Petrol	1984	4	43
11/91→09/98	Vento 2.0	ADY	Petrol	1984	4	43
11/91→09/98	Vento 2.0	AGG	Petrol	1984	4	43
11/91→09/98	Vento 2.0	AKR	Petrol	1984	4	43
11/91→07/98	Vento 2.0 GL	AAC	Petrol	1968	4	33
05/96→12/97	Vento 2.0 GL	AEP	Petrol	1984	4	43
01/92→09/98	Vento 2.8 VR6	AAA	Petrol	2792	V6	32
06/96→09/01	Voyage 1.9 D	1Y	Diesel	1896	4	21
09/99→09/01	Voyage 1.9 TDi	1Z	Diesel	1896	4	22
09/72→12/75	VW - Porsche 914 2.0	GB	Petrol	1971	B4	60

Motorverzeichnis • Index de moteur • Índice de Motor
Indeks silnika • Модель двигателя • دليل المحرك

ENGINE INDEX



CCM

x



9

1F	Petrol	1595	4	81.00	30
1G	Diesel	2383	6	76.50	9
1P	Petrol	1781	4	81.00	31
1S	Diesel	2383	6	76.50	10
1V	Diesel	1588	4	76.50	9
1W	Diesel	1398	4	75.00	3
1X	Diesel	1896	4	79.50	21
1Y	Diesel	1896	4	79.50	21
1Z	Diesel	1896	4	79.50	22
2C	Diesel	1272	4	75.00	4
2E	Petrol	1984	4	82.50	43
2G	Petrol	1272	4	75.00	4
2H	Diesel	1781	4	81.00	31
2L	Diesel	2446	4	92.00	55
3F	Petrol	1272	4	75.00	5
9A	Petrol	1984	4	82.50	43
113	Petrol	1285	4	77.00	19
211, 311	Petrol	1584	B4	85.50	51
AAA	Petrol	2792	V6	81.00	32
AAB	Diesel	2370	5	79.50	21
AAC	Petrol	1968	4	81.00	33
AAF	Petrol	2459	5	81.00	33
AAK	Petrol	1043	4	75.00	4
AAM	Petrol	1781	4	81.00	30
AAU	Petrol	1043	4	75.00	5
AAV	Petrol	1272	4	75.00	4
AAZ	Diesel	1896	4	79.50	21
AB	Petrol	1285	B4	77.00	19
ABD	Petrol	1391	4	75.00	5
ABF	Petrol	1984	4	82.50	43
ABL	Diesel	1896	4	79.50	21
ABN	Petrol	1595	4	81.00	30
ABS	Petrol	1781	4	81.00	31
ABU	Petrol	1598	4	76.50	11
ABV	Petrol	2861	V6	82.00	42
ACC	Petrol	1781	4	81.00	30
ACD	Petrol	1584	B4	85.50	52
ACK	Petrol	2771	V6	82.50	43
ACL	Diesel	2384	6	76.50	9
ACM	Petrol	1043	4	75.00	4
ACT	Diesel	2384	6	76.50	10
ACU	Petrol	2459	5	81.00	33
ACV	Diesel	2461	5	81.00	34
ACX	Petrol	1984	4	82.50	43
ADD	Petrol	1781	4	81.00	31
ADE	Diesel	1896	4	79.50	21
ADF	Petrol	1781	4	81.00	30
ADG	Diesel	1896	4	79.50	21
ADP	Petrol	1595	4	81.00	35
ADR	Petrol	1781	4	81.00	36
ADX	Petrol	1296	4	76.50	12
ADY	Petrol	1984	4	82.50	43
ADZ	Petrol	1781	4	81.00	31
AE	Petrol	1584	B4	85.50	51
AEA	Petrol	1598	4	76.50	12
AEB	Petrol	1781	4	81.00	36
AEE	Petrol	1598	4	76.50	12
AEF	Diesel	1896	4	79.50	21
AEG	Petrol	1984	4	82.50	43
AEH	Petrol	1595	4	81.00	35

ENGINE INDEX

Motorverzeichnis • Index de moteur • Índice de Motor
Indeks silnika • Модель двигателя • دليل المحرك



CCM



9

AEK	Petrol	1595	4	81.00	35
AEP	Petrol	1984	4	82.50	43
AER	Petrol	999	4	67.10	1
AES	Petrol	2792	V6	81.00	32
AET	Petrol	2461	5	81.00	33
AEU	Petrol	2459	5	81.00	33
AEV	Petrol	1043	4	75.00	5
AEX	Petrol	1390	4	76.50	12
AEY	Diesel	1896	4	79.50	22
AFB	Diesel	2496	V6	78.30	20
AFH	Petrol	1390	4	76.50	13
AFK	Petrol	1390	4	76.50	13
AFN	Diesel	1896	4	79.50	22
AFT	Petrol	1595	4	81.00	35
AFY	Petrol	1781	4	81.00	36
AGD	Diesel	1896	4	79.50	22
AGE	Petrol	2771	V6	82.50	43
AGG	Petrol	1984	4	82.50	43
AGK	Diesel	2799	4	93.00	56
AGN	Petrol	1781	4	81.00	36
AGP	Diesel	1896	4	79.50	22
AGR	Diesel	1896	4	79.50	22
AGU	Petrol	1781	4	81.00	36
AGX	Diesel	2459	5	81.00	34
AGZ	Petrol	2324	V5	81.00	32
AH	Petrol	1584	B4	85.50	51
AHB	Diesel	1716	4	79.50	22
AHD	Diesel	2459	5	81.00	34
AHF	Diesel	1896	4	79.50	22
AHG	Diesel	1716	4	79.50	22
AHH	Diesel	1896	4	79.50	22
AHL	Petrol	1595	4	81.00	35
AHS	Petrol	1588	4	76.50	12
AHU	Diesel	1896	4	79.50	22
AHW	Petrol	1390	4	76.50	13
AHY	Diesel	2461	5	81.00	34
AJ	Petrol	1584	B4	85.50	51
AJA	Diesel	2370	5	79.50	21
AJH	Petrol	1781	4	81.00	36
AJM	Diesel	1896	4	79.50	22
AJS	Diesel	4921	V10	81.00	37
AJT	Diesel	2461	5	81.00	34
AJV	Petrol	1598	4	76.50	13
AK	Petrol	1584	B4	85.50	51
AKK	Petrol	1390	4	76.50	13
AKL	Petrol	1595	4	81.00	35
AKN	Diesel	2496	V6	78.30	20
AKQ	Petrol	1390	4	76.50	13
AKR	Petrol	1984	4	82.50	43
AKS	Petrol	1588	4	81.00	35
AKU	Diesel	1716	4	79.50	22
AKV	Petrol	1390	4	76.50	12
AKW	Diesel	1716	4	79.50	22
AL	Petrol	1584	B4	85.50	51
ALD	Petrol	999	4	67.10	1
ALE	Diesel	1896	4	79.50	22
ALG	Petrol	2771	V6	82.50	43
ALH	Diesel	1896	4	79.50	22
ALL	Petrol	999	4	67.10	1
ALM	Petrol	1598	4	76.50	12

Motorverzeichnis • Index de moteur • Índice de Motor
Indeks silnika • Модель двигателя • دليل المحرك

ENGINE INDEX



CCM

x



9

ALT	Petrol	1984	4	82.50	44
ALZ	Petrol	1595	4	81.00	38
AM	Petrol	1584	B4	85.50	51
AMF	Diesel	1422	3	79.50	22
AMV	Petrol	2792	V6	81.00	32
AMX	Petrol	2771	V6	82.50	43
AMY	Petrol	2792	V6	81.00	32
AN	Petrol	1795	4	93.00	57
ANA	Petrol	1595	4	81.00	38
ANB	Petrol	1781	4	81.00	36
ANJ	Diesel	2461	5	81.00	34
ANM	Petrol	1390	4	76.50	13
ANN	Petrol	1781	4	81.00	31
ANP	Petrol	1781	4	81.00	31
ANU	Diesel	1896	4	79.50	22
ANV	Petrol	999	4	67.10	1
ANW	Petrol	1390	4	76.50	13
ANX	Petrol	1389	4	76.50	12
ANY	Diesel	1191	3	76.50	14
AP	Petrol	1795	4	93.00	57
APA	Diesel	2461	5	81.00	34
APE	Petrol	1390	4	76.50	13
APF	Petrol	1595	4	81.00	35
APH	Petrol	1781	4	81.00	36
APK	Petrol	1984	4	82.50	43
APL	Petrol	2461	5	81.00	33
APQ	Petrol	1390	4	76.50	12
APR	Petrol	2771	V6	82.50	43
APT	Petrol	1781	4	81.00	36
APU	Petrol	1781	4	81.00	36
AQA	Petrol	1781	4	81.00	36
AQD	Petrol	2771	V6	82.50	43
AQM	Diesel	1896	4	79.50	22
AQN	Petrol	2324	V5	81.00	32
AQP	Petrol	2792	V6	81.00	32
AQQ	Petrol	1390	4	76.50	13
AQY	Petrol	1984	4	82.50	43
ARC	Petrol	1598	4	76.50	13
ARG	Petrol	1781	4	81.00	36
ARL	Diesel	1896	4	79.50	22
ARM	Petrol	1595	4	81.00	35
ARX	Petrol	1781	4	81.00	36
ARZ	Petrol	1781	4	81.00	36
AS	Petrol	1584	B4	85.50	51
ASV	Diesel	1896	4	79.50	22
ASX	Diesel	1896	4	79.50	22
ASY	Diesel	1896	4	79.50	22
ASZ	Diesel	1896	4	79.50	22
AT	Petrol	1795	4	93.00	57
ATA	Diesel	2799	4	93.00	56
ATD	Diesel	1896	4	79.50	22
ATJ	Diesel	1896	4	79.50	22
ATL	Diesel	1422	3	79.50	22
ATM	Petrol	1984	4	82.50	43
ATN	Petrol	1595	4	76.50	13
ATQ	Petrol	2771	V6	82.50	43
ATX	Petrol	2771	V6	82.50	43
AUA	Petrol	1390	4	76.50	13
AUB	Petrol	1390	4	76.50	13
AUC	Petrol	999	4	67.10	1

ENGINE INDEX

Motorverzeichnis • Index de moteur • Índice de Motor
Indeks silnika • Модель двигателя • دليل المحرك



CCM



9

AUD	Petrol	1390	4	76.50	13
AUE	Petrol	2792	V6	81.00	32
AUF	Diesel	2461	5	81.00	34
AUH	Diesel	2799	4	93.00	56
AUM	Petrol	1781	4	81.00	36
AUQ	Petrol	1781	4	81.00	36
AUR	Petrol	1595	4	81.00	35
AUS	Petrol	1597	4	76.50	13
AUY	Diesel	1896	4	79.50	22
AVB	Diesel	1896	4	79.50	22
AVC	Petrol	1781	4	81.00	36
AVF	Diesel	1896	4	79.50	22
AVG	Diesel	1896	4	79.50	22
AVQ	Diesel	1896	4	79.50	22
AVR	Diesel	2461	5	81.00	34
AVT	Petrol	2461	5	81.00	33
AVU	Petrol	1595	4	81.00	38
AVY	Petrol	1598	4	76.50	13
AWC	Petrol	1781	4	81.00	36
AWD	Petrol	1781	4	81.00	36
AWH	Petrol	1595	4	81.00	35
AWM	Petrol	1781	4	81.00	36
AWT	Petrol	1781	4	81.00	36
AWX	Diesel	1896	4	79.50	22
AXA	Petrol	1984	4	82.50	43
AXB	Diesel	1896	4	79.50	22
AXC	Diesel	1896	4	79.50	22
AXD	Diesel	2461	5	81.00	37
AXE	Diesel	2461	5	81.00	37
AXG	Diesel	2461	5	81.00	34
AXJ	Petrol	3189	V6	84.00	49
AXL	Diesel	2461	5	81.00	34
AXP	Petrol	1390	4	76.50	13
AXQ	Petrol	4172	V8	84.50	50
AXR	Diesel	1896	4	79.50	22
AXW	Petrol	1984	4	82.50	44
AXX	Petrol	1984	4	82.50	44
AYC	Diesel	2461	5	81.00	34
AYD	Petrol	1595	4	81.00	38
AYH	Diesel	4921	V10	81.00	37
AYL	Petrol	2792	V6	81.00	32
AYQ	Diesel	1896	4	79.50	22
AYT	Petrol	3189	V6	84.00	49
AYY	Diesel	2461	5	81.00	34
AYZ	Diesel	1191	3	76.50	14
AZD	Petrol	1597	4	76.50	13
AZH	Petrol	1984	4	82.50	43
AZJ	Petrol	1984	4	82.50	43
AZM	Petrol	1984	4	82.50	43
AZQ	Petrol	1198	3	76.50	12
AZV	Diesel	1968	4	81.00	39
AZX	Petrol	2324	V5	81.00	32
AZZ	Petrol	3189	V6	84.00	49
B	Diesel	1584	B4	85.50	51
BAA	Petrol	3189	V6	84.00	49
BAC	Diesel	2461	5	81.00	37
BAU	Diesel	2496	V6	78.30	20
BAY	Diesel	1422	3	79.50	22
BBE	Diesel	2461	5	81.00	34
BBF	Diesel	2461	5	81.00	34



CCM

x



9

BBG	Petrol	2771	V6	82.50	43
BBR	Diesel	2461	5	81.00	34
BBX	Petrol	1984	4	82.50	43
BBY	Petrol	1390	4	76.50	13
BBZ	Petrol	1390	4	76.50	13
BCA	Petrol	1390	4	76.50	15
BCB	Petrol	1598	4	76.50	13
BCQ	Diesel	2798	4	93.00	56
BCT (SDI 55-5)	Diesel	2461	5	81.00	37
BCU (TDI 100-5)	Diesel	2461	5	81.00	37
BCV	Diesel	2461	5	81.00	37
BDE	Petrol	2792	V6	81.00	32
BDG	Diesel	2496	V6	78.30	20
BDH	Diesel	2496	V6	78.30	20
BDJ	Diesel	1968	4	81.00	39
BDK	Diesel	1968	4	81.00	39
BDL	Petrol	3189	V6	84.00	49
BEE	Diesel	1968	4	81.00	39
BEF	Gas	1984	4	82.50	43
BEH	Petrol	1984	4	82.50	43
BEJ	Petrol	1984	4	82.50	43
BEQ	Diesel	1896	4	79.50	23
BER	Petrol	1984	4	82.50	43
BEU	Diesel	1896	4	79.50	24
BEW	Diesel	1896	4	79.50	24
BFH	Petrol	3189	V6	84.00	49
BFQ	Petrol	1595	4	81.00	38
BFS	Petrol	1595	4	81.00	38
BGG	Diesel	1896	4	79.50	23
BGH	Petrol	4172	V8	84.50	50
BGJ	Petrol	4172	V8	84.50	50
BGL	Diesel	1896	4	79.50	23
BGM	Diesel	1896	4	79.50	23
BGU	Petrol	1595	4	81.00	38
BGW	Diesel	1968	4	81.00	39
BHP	Petrol	1984	4	82.50	43
BHX	Petrol	4172	V8	84.50	50
BJB	Diesel	1896	4	79.50	24
BJC	Diesel	1896	4	79.50	23
BJL	Diesel	2461	5	81.00	37
BJM	Diesel	2461	5	81.00	37
BKC	Diesel	1896	4	79.50	24
BKD	Diesel	1968	4	81.00	39
BKJ	Petrol	3189	V6	84.00	49
BKK	Petrol	3189	V6	84.00	49
BKL	Petrol	3189	V6	84.00	49
BKP	Diesel	1968	4	81.00	39
BKR	Petrol	1390	4	76.50	16
BKS	Diesel	2967	V6	83.00	45
BKY	Petrol	1390	4	76.50	16
BLF	Petrol	1598	4	76.50	17
BLG	Petrol	1390	4	76.50	18
BLJ	Diesel	2461	5	81.00	37
BLK	Diesel	2461	5	81.00	37
BLM	Petrol	1390	4	76.50	13
BLP	Petrol	1598	4	76.50	17
BLR	Petrol	1984	4	82.50	44
BLS	Diesel	1896	4	79.50	24
BLT	Diesel	1896	4	79.50	24
BLX	Petrol	1984	4	82.50	44

ENGINE INDEX

Motorverzeichnis • Index de moteur • Índice de Motor
Indeks silnika • Модель двигателя • دليل المحرك



CCM



9

BLY	Petrol	1984	4	82.50	44
BMA	Diesel	1968	4	81.00	39
BMK	Diesel	2967	V6	83.00	45
BML	Petrol	3189	V6	84.00	49
BMM	Diesel	1968	4	81.00	39
BMN	Diesel	1968	4	81.00	39
BMP	Diesel	1968	4	81.00	39
BMR	Diesel	1968	4	81.00	39
BMS	Diesel	1422	3	79.50	22
BMT	Diesel	1896	4	79.50	24
BMV	Petrol	3189	V6	84.00	49
BMX	Petrol	3189	V6	84.00	49
BYM	Petrol	1390	4	76.50	18
BNM	Diesel	1422	3	79.50	22
BNV	Diesel	1422	3	79.50	22
BNZ	Diesel	2460	5	81.00	40
BPF	Petrol	3189	V6	84.00	49
BPR	Petrol	2480	5	82.50	44
BPS	Petrol	2480	5	82.50	44
BPY	Petrol	1984	4	82.50	44
BPZ	Diesel	1896	4	79.50	23
BRK	Petrol	3189	V6	84.00	49
BRM	Diesel	1896	4	79.50	24
BRR	Diesel	1896	4	79.50	24
BRS	Diesel	1896	4	79.50	24
BRT	Diesel	1968	4	81.00	39
BRU	Diesel	1896	4	79.50	24
BSE	Petrol	1595	4	81.00	38
BSF	Petrol	1595	4	81.00	38
BST	Diesel	1968	4	81.00	39
BSU	Diesel	1896	4	79.50	24
BSW	Diesel	1896	4	79.50	24
BTB	Diesel	1896	4	79.50	23
BUB	Petrol	3189	V6	84.00	49
BUD	Petrol	1390	4	76.50	16
BUN	Diesel	2967	V6	83.00	45
BUZ	Diesel	1968	4	81.00	39
BVD	Diesel	1968	4	81.00	39
BVE	Diesel	1968	4	81.00	39
BVK	Diesel	1896	4	79.50	24
BVX	Petrol	1984	4	82.50	44
BVY	Petrol	1984	4	82.50	44
BVZ	Petrol	1984	4	82.50	44
BWA	Petrol	1984	4	82.50	44
BWB	Diesel	1422	3	79.50	22
BWK	Petrol	1390	4	76.50	18
BWV	Diesel	1968	4	81.00	39
BXE	Diesel	1896	4	79.50	24
BXF	Diesel	1896	4	79.50	24
BXJ	Diesel	1896	4	79.50	24
BXT	Diesel	1896	4	79.50	23
CAAA Euro 5	Diesel	1968	4	81.00	40
CAAB Euro 5	Diesel	1968	4	81.00	40
CAAC Euro 5	Diesel	1968	4	81.00	40
CAAD	Diesel	1968	4	81.00	40
CAAE	Diesel	1968	4	81.00	40
CARB	Diesel	2967	V6	83.00	46
CASA	Diesel	2967	V6	83.00	46
CASB	Diesel	2967	V6	83.00	47
CASC	Diesel	2967	V6	83.00	46

Motorverzeichnis • Index de moteur • Índice de Motor
Indeks silnika • Модель двигателя • دليل المحرك

ENGINE INDEX



CCM

x



9

CASD	Diesel	2967	V6	83.00	46
CATA	Diesel	2967	V6	83.00	47
CAVA	Petrol	1390	4	76.50	18
CAVB	Petrol	1390	4	76.50	18
CAVC	Petrol	1390	4	76.50	18
CAVD	Petrol	1390	4	76.50	18
CAVE	Petrol	1390	4	76.50	18
CAXA	Petrol	1390	4	76.50	17
CAYA	Diesel	1598	4	79.50	25
CAYB	Diesel	1598	4	79.50	25
CAYC	Diesel	1598	4	79.50	25
CAYD	Diesel	1598	4	79.50	25
CAYE	Diesel	1598	4	79.50	25
CBAA	Diesel	1968	4	81.00	41
CBAB	Diesel	1968	4	81.00	41
CBAC	Diesel	1968	4	81.00	41
CBBA	Diesel	1968	4	81.00	41
CBBB	Diesel	1968	4	81.00	41
CBDA	Diesel	1968	4	81.00	41
CBDB	Diesel	1968	4	81.00	41
CBDC	Diesel	1968	4	81.00	41
CBPA	Petrol	1984	4	82.50	43
CBR	Petrol	3189	V6	84.00	49
CBRA	Petrol	3189	V6	84.00	49
CBWA	Diesel	4921	V10	81.00	37
CCHA	Diesel	1968	4	81.00	40
CCHB	Diesel	1968	4	81.00	40
CCSA	Petrol	1595	4	81.00	38
CDBA	Diesel	1968	4	81.00	40
CDCA	Diesel	1968	4	81.00	40
CDDA	Petrol	1390	4	76.50	16
CDXA	Diesel	1896	4	79.50	23
CDXB	Diesel	1896	4	79.50	23
CECA	Diesel	2461	5	81.00	37
CECB	Diesel	2461	5	81.00	37
CEGA	Diesel	1968	4	81.00	41
CEXA	Diesel	2967	V6	83.00	46
CFCA Euro 5	Diesel	1968	4	81.00	40
CFFA	Diesel	1968	4	81.00	41
CFFB	Diesel	1968	4	81.00	41
CFFD	Diesel	1968	4	81.00	41
CFFE	Diesel	1968	4	81.00	41
CFGB	Diesel	1968	4	81.00	41
CFGC	Diesel	1968	4	81.00	41
CFHB	Diesel	1968	4	81.00	41
CFHC	Diesel	1968	4	81.00	41
CFHE	Diesel	1968	4	81.00	41
CFHF	Diesel	1968	4	81.00	41
CFJA	Diesel	1968	4	81.00	41
CFJB	Diesel	1968	4	81.00	41
CFLA	Petrol	3189	V6	84.00	49
CFWA	Diesel	1199	3	79.50	25
CGGA	Petrol	1390	4	76.50	16
CGGB	Petrol	1390	4	76.50	16
CH	Petrol	1984	4	86.50	53
CJ	Petrol	1970	B4	94.00	58
CJAA	Diesel	1968	4	81.00	40
CJMA	Diesel	2967	V6	83.00	46
CK	Diesel	1471	4	76.50	10
CKTB	Diesel	1968	4	81.00	40

ENGINE INDEX

Motorverzeichnis • Index de moteur • Índice de Motor
Indeks silnika • Модель двигателя • دليل المحرك



CCM



9

CKTC	Diesel	1968	4	81.00	40
CKUB	Diesel	1968	4	81.00	40
CKUC	Diesel	1968	4	81.00	40
CLCA	Diesel	1968	4	81.00	41
CLCB	Diesel	1968	4	81.00	41
CLJA	Diesel	1968	4	81.00	41
CLLA	Diesel	1968	4	81.00	41
CLNA	Diesel	1598	4	79.50	25
CLPA	Petrol	1390	4	76.50	16
CMSB	Petrol	1390	4	76.50	17
CNEA	Diesel	1968	4	81.00	40
CNFA	Diesel	1968	4	81.00	40
CNWA	Petrol	1390	4	76.50	18
CNWB	Petrol	1390	4	76.50	18
CP	Diesel	2383	6	76.50	10
CR	Diesel	1588	4	76.50	10
CS	Diesel	1588	4	76.50	10
CSHA	Diesel	1968	4	81.00	40
CTHA	Petrol	1390	4	76.50	18
CTHE	Petrol	1390	4	76.50	18
CU	Petrol	1970	B4	94.00	58
CV	Petrol	1970	B4	94.00	58
CY	Diesel	1588	4	76.50	9
CZ	Petrol	1584	B4	85.50	51
D	Diesel	1192	B4	77.00	19
DF	Petrol	1915	4	94.00	58
DG	Diesel	1915	B4	94.00	58
DH	Petrol	1913	B4	94.00	58
DJ	Petrol	2109	B4	94.00	59
DS	Petrol	1781	4	81.00	31
DT	Petrol	1595	4	81.00	30
DTA	Petrol	1595	4	81.00	30
DV	Diesel	2383	6	76.50	9
DW	Diesel	2383	6	76.50	10
DX	Petrol	1781	4	81.00	31
DZ	Petrol	1781	4	81.00	31
E	Petrol	1285	B4	77.00	19
EE	Petrol	1588	4	79.50	26
EF	Petrol	1588	4	79.50	27
EG	Petrol	1588	4	79.50	28
EH	Petrol	1457	4	79.50	27
EJ	Petrol	1588	4	79.50	27
EN	Petrol	1716	4	79.50	27
EP	Petrol	1297	4	75.00	6
EU	Petrol	1272	4	75.00	6
EV	Petrol	1781	4	81.00	31
EW	Petrol	1595	4	81.00	30
EX	Petrol	1781	4	81.00	31
EZ	Petrol	1595	4	81.00	30
EZA	Petrol	1595	4	81.00	30
F	Petrol	1285	B4	77.00	19
FA	Petrol	1093	4	69.50	2
FJ	Petrol	1093	4	69.50	2
FN	Petrol	1588	4	79.50	29
FP	Petrol	1588	4	79.50	27
FR	Diesel	1588	4	79.50	27
FT	Petrol	1588	4	79.50	26
FV	Petrol	1588	4	79.50	27
FY	Petrol	1272	4	75.00	7
FZ	Petrol	1272	4	75.00	7

Motorverzeichnis • Index de moteur • Índice de Motor
Indeks silnika • Модель двигателя • دليل المحرك

ENGINE INDEX



CCM

x



9

GB	Petrol	1971	B4	94.00	60
GE	Petrol	1970	B4	94.00	58
GF	Petrol	1272	4	75.00	7
GG	Petrol	1093	4	69.50	2
GH	Petrol	1457	4	79.50	27
GK	Petrol	1272	4	75.00	4
GL	Petrol	1043	4	75.00	4
GN	Petrol	1043	4	75.00	4
GS	Petrol	1272	4	75.00	7
GT	Petrol	1272	4	75.00	7
GU	Petrol	1781	4	81.00	31
GW	Petrol	1913	B4	94.00	58
GX	Petrol	1781	4	81.00	31
GZ	Petrol	1781	4	81.00	31
H	Diesel	1493	B4	83.00	48
HA	Petrol	895	4	69.50	2
HB	Petrol	1093	4	69.50	2
HC	Petrol	1093	4	69.50	2
HD	Petrol	1093	4	69.50	2
HH	Petrol	1272	4	75.00	7
HJ	Petrol	1272	4	75.00	7
HK	Petrol	1272	4	75.00	4
HM	Petrol	1595	4	81.00	30
HN	Petrol	1595	4	81.00	30
HP	Petrol	1994	5	81.00	30
HT	Petrol	1781	4	81.00	31
HV	Petrol	1781	4	81.00	31
HW	Petrol	1272	4	75.00	4
HY	Petrol	2226	5	81.00	30
HZ	Petrol	1043	4	75.00	4
JB	Petrol	1457	4	79.50	27
JH	Petrol	1781	4	81.00	31
JJ	Petrol	1781	4	81.00	31
JK	Diesel	1588	4	76.50	10
JN	Petrol	1781	4	81.00	30
JP	Diesel	1588	4	76.50	10
JR	Diesel	1588	4	76.50	9
JS	Petrol	1994	5	81.00	30
JT	Petrol	2226	5	81.00	30
JU	Petrol	1595	4	81.00	30
JV	Petrol	1781	4	81.00	31
JX	Diesel	1588	4	76.50	9
K	Petrol	1493	B4	83.00	48
KM	Petrol	2226	5	81.00	30
KR	Petrol	1781	4	81.00	31
KT	Petrol	1781	4	81.00	31
KV	Petrol	2226	5	81.00	30
KX	Petrol	2226	5	81.00	30
KY	Diesel	1715	4	79.50	21
ME	Diesel	1588	4	76.50	10
MF	Diesel	1588	4	76.50	9
MH	Petrol	1272	4	75.00	4
MN	Diesel	1272	4	75.00	3
MV	Petrol	2109	B4	94.00	59
NU	Petrol	1272	4	75.00	4
NZ	Petrol	1272	4	75.00	4
P	Petrol	1584	B4	85.50	51
PB	Petrol	1781	4	81.00	31
PD	Petrol	1781	4	81.00	33
PF	Petrol	1781	4	81.00	31

ENGINE INDEX

Motorverzeichnis • Index de moteur • Índice de Motor
Indeks silnika • Модель двигателя • دليل المحرك



CCM

x



9

PG	Petrol	1781	4	81.00	31
PL	Petrol	1781	4	81.00	31
PN	Diesel	1595	4	81.00	30
PP	Petrol	1595	4	81.00	30
PY	Petrol	1272	4	75.00	4
RA	Diesel	1588	4	76.50	9
RD	Petrol	1781	4	81.00	30
RE	Petrol	1595	4	81.00	30
RF	Diesel	1595	4	81.00	30
RG	Diesel	1781	4	81.00	31
RH	Petrol	1781	4	81.00	31
RL	Petrol	1595	4	81.00	30
RM	Petrol	1781	4	81.00	30
RP	Petrol	1781	4	81.00	30
RV	Petrol	1781	4	81.00	31
SB	Diesel	1588	4	76.50	9
SP	Petrol	1915	B4	94.00	58
SR	Petrol	2109	4	94.00	59
SS	Diesel	2109	4	94.00	59
T	Petrol	1584	B4	85.50	51
U	Petrol	1584	B4	85.50	51
V	Petrol	1679	4	90.00	54
W	Petrol	1679	4	90.00	54
WE	Petrol	2144	5	79.50	27
WN	Petrol	1921	5	79.50	27
WV	Petrol	1588	4	79.50	27
WY	Petrol	1588	4	79.50	27
WZ	Petrol	1588	4	79.50	27
YG	Petrol	1588	4	79.50	27
YH	Petrol	1588	4	79.50	27
YK	Petrol	1588	4	79.50	27
YN	Petrol	1588	4	79.50	27
YP	Petrol	1588	4	79.50	27
YS	Petrol	1588	4	79.50	28
YY	Petrol	1588	4	79.50	27
Z	Petrol	1679	4	90.00	54
ZA	Petrol	1297	4	75.00	8
ZF	Petrol	1297	4	75.00	8



Lupo 1.0 Polo 50 1.0	09/98→07/05 09/96→10/99	AER	4cyl. 999cc	37kW (50PS)	1	TD9519
Lupo 1.0 Polo 1.0	09/98→07/05 10/99→09/01	ALD	4cyl. 999cc	37kW (50PS)		TD11468
Lupo 1.0 Polo 50 1.0	09/98→07/05 09/96→10/99	ALL	4cyl. 999cc	37kW (50PS)		TD10609
Lupo 1.0	09/98→07/05	ANV	4cyl. 999cc	37kW (50PS)		TD11469
Lupo 1.0 Polo 1.0	09/98→07/05 10/99→09/01	AUC	4cyl. 999cc	37kW (50PS)		TD15491
08-101300-00 08-101307-00 <i>[R66690]</i>	STD 0.50mm	67.10	1.000 1.200 2.000	 	001 NT 005 P 236 P	ST STD GOE13
Golf I 1.1 Jetta I 1.1 Scirocco 1.1	04/74→07/83 08/78→02/84 04/74→07/79	FA	4cyl. 1093cc	37kW (50PS)	2	TD5001
Golf I 1.1	01/81→07/83	FJ	4cyl. 1093cc	38kW (52PS)		TD4082
Golf I 1.1 Jetta I 1.1	04/74→07/83 08/78→02/84	GG	4cyl. 1093cc	37kW (50PS)		TD4093
Derby 0.9 Polo 0.9	02/77→09/81 09/75→12/81	HA	4cyl. 895cc	29kW (39PS)		TD4104
Derby 1.1 Polo 1.1 Polo Coupe 1.1	02/77→07/83 03/75→09/89 10/81→07/83	HB	4cyl. 1093cc	37kW (50PS)		TD5008
Golf I 1.1 Polo 1.1	01/81→07/83 03/75→09/81	HC	4cyl. 1093cc	44kW (60PS)		TD5009





Derby, Polo			01/75→12/78	HD		4cyl. 1093cc	38kW (52PS)		
									TD21345
08-108500-00 →05/1975	STD	69.50	2.000		001 IF CR P				IKA
			2.500		026 P				STD
			4.000		712 CR				ST
08-108600-00 05/1975→07/1978	STD	69.50	1.750		001 IF CR P				IKA
			2.500		026 P				STD
			4.000		712 CR				ST
08-108700-00 08-108707-00 08/1978→07/1981	STD 0.50mm	69.50	1.750		001 IF CR P				IKA
			2.000		026 P				STD
			4.000		712 CR				ST
Polo 1.4 D			10/90→09/94	1W					
Polo Box 1.4 D			08/92→07/94			4cyl.			3
Polo Classic 1.4 D			10/90→09/94			1398cc	35kW (47PS)		
Polo Coupe 1.4 D			08/90→09/94	Diesel					TD4959
Polo 1.3 D			08/86→07/90	MN					
Polo Classic 1.3 D			08/86→12/88			4cyl.			
Polo Coupe 1.3 D			08/86→08/90			1272cc	33kW (45PS)		
				Diesel					TD4132
08-991300-00	STD	75.00	1.750		001 CR P				KV1
08-991307-00	0.50mm		2.000		005 IFU CR P				F12/F14
			3.000		231 CR P				STD
Golf			01/87→12/87	2C		4cyl.			4
						1272cc	44kW (60PS)		FM5436
Golf II 1.3 CAT			06/86→12/92	2G					
Golf III 1.3			08/91→07/92			4cyl.			
Jetta II 1.3 CAT			06/87→12/91			1272cc	40kW (54PS)		
Polo 1.3 CAT			07/87→09/94						
Polo Coupe 1.3 CAT			07/87→08/94						TD4964
Polo 1.0 CAT			08/89→09/94	AAK					
Polo Classic 1.0			01/85→09/94			4cyl.			
Polo Coupe 1.0 CAT			08/89→09/94			1043cc	33kW (45PS)		TD4003
Polo 1.3 CAT			07/87→09/94	AAV					
Polo Box 1.3			08/92→07/94			4cyl.			
Polo Coupe 1.3 CAT			07/87→08/94			1272cc	40kW (54PS)		TD5159
Polo 1.0 CAT, Polo Coupe 1.0 CAT			08/89→09/94	ACM		4cyl.			
						1043cc	33kW (45PS)		TD4013





Derby 1.3 Polo 1.3, Polo Coupe 1.3	09/82→12/84 09/82→09/89	GK	4cyl. 1272cc	55kW (75PS)	TD4094
Derby 1.0 Polo 1.0 Polo Classic 1.0 Polo Coupe 1.0	10/81→12/84 10/81→10/86 01/85→10/86 05/82→10/86	GL	4cyl. 1043cc	29kW (39PS)	TD5006
Golf II 1.0	11/83→08/85	GN	4cyl. 1043cc	33kW (45PS)	TD4095
Derby 1.3 Golf I Cabriolet 1.3 Golf II 1.3 Jetta II 1.3 Polo 1.3 Polo Classic 1.3 Polo Coupe 1.3 Scirocco 1.3	08/83→12/84 08/83→07/86 08/83→06/87 01/84→06/87 08/83→07/88 01/85→07/87 08/83→06/87 08/83→07/84	HK	4cyl. 1272cc	40kW (54PS)	TD5011
Derby 1.3 Polo 1.3	08/83→12/84 08/83→07/85	HW	4cyl. 1272cc	37kW (50PS)	TD4113
Derby 1.0 Golf II 1.0 Polo 1.0 Polo Classic 1.0 Polo Coupe 1.0	08/81→12/84 08/85→10/91 08/85→01/92 01/85→09/94 08/85→01/92	HZ	4cyl. 1043cc	33-37kW (45-50PS)	TD5012
Golf II 1.3 Golf II 1.3 CAT Jetta II 1.3 Jetta II 1.3 CAT Polo 1.3 Polo 1.3 CAT Polo Classic 1.3 Polo Classic 1.3 CAT Polo Coupe 1.3 Polo Coupe 1.3 CAT	08/83→06/87 06/86→12/92 01/84→06/87 06/87→12/91 08/83→07/88 07/87→09/94 01/85→07/87 07/87→09/94 08/83→06/87 07/87→08/94	MH	4cyl. 1272cc	40kW (54PS)	TD4131
Golf II 1.3	08/85→12/87	NU	4cyl. 1272cc	37kW (50PS)	TD4135
Golf II 1.3 CAT Jetta II 1.3 CAT Polo 1.3 CAT, Polo Classic 1.3 CAT Polo Coupe 1.3 CAT	06/86→12/92 06/87→12/91 07/87→09/94 07/87→08/94	NZ	4cyl. 1272cc	40kW (54PS)	TD4136
Polo Coupe 1.3 G40	01/87→09/94	PY	4cyl. 1272cc	85kW (116PS)	TD5023

08-406200-00	STD	75.00	1.750		001 IF CR P	IKA
08-406207-00	0.50mm				026 P	STD
08-406211-00	1.00mm		2.000		231 CR P	STD
[R46160]			3.000			



Polo 1.3		10/90→08/94	3F						
Polo 1.3 CAT		10/89→03/91		4cyl.					5
Polo Coupe 1.3		03/91→09/94		1272cc	55-57kW (75-78PS)				
Polo Coupe 1.3 CAT		10/89→09/94							TD4968
Polo 1.0 CAT		08/89→09/94	AAU						
Polo Box 1.0		08/92→12/99		4cyl.					
Polo Classic 1.0		01/85→09/94		1043cc	33kW (45PS)				
Polo Coupe 1.0 CAT		08/89→09/94							TD4971
Golf III 1.4		10/91→08/97	ABD						
Golf III Variant 1.4		07/93→04/99		4cyl.					
Vento 1.4		11/91→09/98		1391cc	40-44kW (55-60PS)				
									TD4973
Polo 45 1.0		10/94→09/96	AEV						
				4cyl.					
				1043cc	33kW (45PS)				
									TD4021
08-502200-00	STD	75.00	1.500		001 IF CR P			IKA	
08-502207-00	0.50mm		1.500		005 P			STD	
[R48010]			2.500		236 P			STD	
Passat 1.3, Passat Variant 1.3		08/80→07/86	EP						
				4cyl.					6
				1297cc	44kW (60PS)				
									TD5158
Passat 1.3, Passat Variant 1.3		08/80→07/86	EU						
				4cyl.					
				1272cc	44kW (60PS)				
									TD16428
08-408700-00	STD	75.00	1.500		001 IF CR P			IKA	
08-408707-00	0.50mm		1.750		026 P			STD	
			3.000		231 CR P			STD	
Passat 1.3, Passat Variant 1.3		05/73→07/83	FY						
				4cyl.					7
				1272cc	40kW (54PS)				
									TD5002
Passat 1.3		01/78→07/86	FZ						
Passat Variant 1.3		08/80→07/86		4cyl.					
Santana 1.3		08/81→07/83		1272cc	44kW (60PS)				
									TD5003
Golf I 1.3		08/79→07/83	GF						
Jetta I 1.3		08/79→02/84		4cyl.					
Scirocco 1.3		08/79→12/83		1272cc	44kW (60PS)				
									TD4092
Golf I 1.3		08/82→12/83	GS						
Jetta I 1.3		08/82→02/84		4cyl.					
				1272cc	43kW (58PS)				
									TD4096
Golf II 1.3		08/83→10/86	GT						
Jetta II 1.3		01/84→10/86		4cyl.					
Polo 1.3, Polo Coupe 1.3		08/82→07/88		1272cc	44kW (60PS)				
									TD4097





Derby 1.3			02/77→07/83		HH				
Polo 1.3			12/76→07/83			4cyl.			
Polo Coupe 1.3			10/81→07/83			1272cc	44kW (60PS)		TD5010
Derby 1.3			02/77→09/81		HJ				
Polo 1.3			08/82→07/88			4cyl.			
						1272cc	43kW (58PS)		TD4105
08-404200-00	STD	75.00	1.750		001 IF CR P			IKA	
08-404211-00	1.00mm		2.000		026 P			STD	
			4.000		712 CR			ST	
Passat 1.3, Passat Variant 1.3			05/73→01/78		ZA				8
						4cyl.			
						1297cc	40kW (54PS)		TD5036
Passat 1.3			05/73→01/78		ZF				
Passat Variant 1.3			10/73→01/78			4cyl.			
						1297cc	44kW (60PS)		TD5140
08-108800-00	STD	75.00	2.000		001 IF CR P			IKA	
08-108807-00	0.50mm		2.500		026 P			STD	
			4.000		712 CR			ST	
LT 28-35 I Box 2.4 TD			08/88→08/92		1G				9
LT 28-35 I Bus 2.4 TD			08/89→08/92			6cyl.			
LT 28-35 I Platform/Chassis 2.4 TD			08/90→08/92			2383cc	68kW (92PS)		
LT 28-35 I Platform/Chassis 2.4 TD Syncro			08/91→07/92		Diesel	Turbo			
LT 40-55 I Box 2.4 TD			08/88→08/92						
LT 40-55 I Platform/Chassis 2.4 TD			08/88→07/91						
LT 40-55 I Platform/Chassis 2.4 TD Syncro			08/91→07/92						TD3993
Golf II 1.6 TD			08/89→10/91		1V				
Jetta II 1.6 TD			01/90→10/91			4cyl.			
						1588cc	44kW (60PS)		
					Diesel	Turbo			TD3996
LT 28-35 I Box 2.4 TD			06/92→05/96		ACL				
LT 28-35 I Box 2.4 TD Syncro			08/92→04/96			6cyl.			
LT 28-35 I Bus 2.4 TD			09/92→06/96			2384cc	70kW (95PS)		
LT 28-35 I Platform/Chassis 2.4 TD			08/92→06/96		Diesel	Turbo			
LT 28-35 I Platform/Chassis 2.4 TD Syncro			08/92→04/96						
LT 40-55 I Box 2.4 TD			06/92→05/96						
LT 40-55 I Box 2.4 TD Syncro			08/92→04/96						
LT 40-55 I Platform/Chassis 2.4 TD			08/92→06/96						
LT 40-55 I Platform/Chassis 2.4 TD Syncro			08/92→04/96						TD4012
Golf I 1.6 TD			03/82→07/83		CY				
Jetta I 1.6 TD			03/82→02/84			4cyl.			
Passat 1.6 TD			04/82→03/88			1588cc	51kW (69PS)		
Passat Saloon 1.6 TD			01/85→03/88		Diesel	Turbo			
Passat Variant 1.6 TD			04/82→03/88						
Santana 1.6 TD			12/81→12/84						TD4052





LT 28-35 I Box 2.4 TD	02/86→08/92	DV				
LT 28-35 I Bus 2.4 TD	12/82→07/89		6cyl.			
LT 28-35 I Platform/Chassis 2.4 TD	12/82→09/93		2383cc	75-80kW (102-109PS)		
LT 28-35 I Platform/ Chassis 2.4 TD Syncro	08/91→07/92	Diesel	Turbo			
LT 40-55 I Box 2.4 TD	02/86→08/92					
LT 40-55 I Box 2.4 TD 4WD	08/78→07/92					
LT 40-55 I Platform/Chassis 2.4 TD	12/82→09/93					
LT 40-55 I Platform/ Chassis 2.4 TD Syncro	08/91→07/92					TD4061
Golf II 1.6 TD	08/83→10/91	JR				
Jetta II 1.6 TD	01/84→10/91		4cyl.			
			1588cc	51kW (69PS)		
		Diesel	Turbo			TD4121
Transporter III Box 1.6 TD	10/84→07/92	JX				
Transporter III Box 1.6 TD Syncro	03/86→07/92		4cyl.			
Transporter III Bus 1.6 TD	08/84→07/92		1588cc	50kW (68PS)		
Transporter III Bus 1.6 TD Syncro	03/86→07/92	Diesel	Turbo			
Transporter III Platform/Chassis 1.6 TD	10/84→07/92					
Transporter III Platform/ Chassis 1.6 TD Syncro	03/86→07/92					TD5018
Golf II 1.6 TD	08/83→10/91	MF				
Jetta II 1.6 TD	01/84→10/91		4cyl.			
			1588cc	51kW (69PS)		
		Diesel	Turbo			TD4130
Golf II 1.6 TD, Jetta II 1.6 TD	04/89→10/91	RA				
Passat 1.6 TD	05/86→09/93		4cyl.			
Passat Variant 1.6 TD	08/88→09/93		1588cc	59kW (80PS)		
		Diesel	Turbo Intercooled			TD5024
Golf II 1.6 TD, Jetta II 1.6 TD	04/89→10/91	SB				
Passat 1.6 TD, Passat Variant 1.6 TD	08/88→09/93		4cyl.			
			1588cc	59kW (80PS)		
		Diesel	Turbo Intercooled			TD5028
08-109800-00	STD	76.50	1.750		001 IF CR P	KV1
08-109807-00	0.50mm				005 IFU CR P	IKA
08-109811-00	1.00mm				231 CR P	STD
[R45270]			3.000			
LT 28-35 I Box 2.4 D	07/90→05/96	1S				10
LT 28-35 I Bus 2.4 D	08/89→06/96		6cyl.			
LT 28-35 I Platform/Chassis 2.4 D	08/90→06/96		2383cc	51kW (69PS)		
LT 28-35 I Platform/Chassis 2.4 D Syncro	08/91→07/92	Diesel				
LT 40-55 I Box 2.4 D	07/90→05/96					
LT 40-55 I Platform/Chassis 2.4 D	08/90→06/96					TD4958
LT 28-35 I Box 2.4 D	07/90→05/96	ACT				
LT 28-35 I Bus 2.4 D	08/89→06/96		6cyl.			
LT 28-35 I Platform/Chassis 2.4 D	08/90→06/96		2384cc	51kW (69PS)		
LT 40-55 I Box 2.4 D	07/90→05/96	Diesel				
LT 40-55 I Platform/Chassis 2.4 D	08/90→06/96					TD4014
Golf I 1.5 D	08/76→07/80	CK				
Jetta I 1.5 D	08/78→07/80		4cyl.			
Passat 1.5 D	08/77→07/80		1471cc	37kW (50PS)		
Passat Variant 1.5 D	02/77→07/80	Diesel				TD4046





LT 28-35 I Box 2.4 D, LT 28-35 I Bus 2.4 D		01/79→07/92	CP	6cyl. 2383cc	55kW (75PS)			
LT 28-35 I Platform/Chassis 2.4 D		12/78→02/91						
LT 40-55 I Box 2.4 D		01/79→07/92	Diesel					
LT 40-55 I Platform/Chassis 2.4 D		12/78→02/91				TD4047		
Golf I 1.6 D		08/80→07/83	CR	4cyl. 1588cc	40kW (54PS)			
Jetta I 1.6 D		08/80→02/84						
Passat 1.6 D		08/80→03/88						
Passat Variant 1.6 D		02/79→03/88	Diesel					
Santana 1.6 D		08/81→12/84				TD4992		
Transporter III Box 1.6 D, Transporter III Bus 1.6 D, Transporter III Platform/Chassis 1.6 D		01/81→07/87	CS	4cyl. 1588cc	37kW (50PS)			
			Diesel			TD4048		
LT 28-35 I Box 2.4 D, LT 28-35 I Bus 2.4 D		01/79→07/92	DW	6cyl. 2383cc	55-57kW (75-78PS)			
LT 28-35 I Platform/Chassis 2.4 D		12/78→02/91						
LT 28-35 I Platform/Chassis 2.4 D Syncro		08/91→07/92	Diesel					
LT 40-55 I Box 2.4 D		01/79→07/92						
LT 40-55 I Box 2.4 D 4WD		01/79→03/86						
LT 40-55 I Platform/Chassis 2.4 D		12/78→02/91				TD4062		
Caddy I 1.6 D		08/82→07/92	JK	4cyl. 1588cc	40kW (54PS)			
Golf I 1.6 D		08/80→07/83						
Jetta I 1.6 D		08/80→02/84						
Passat 1.6 D, Passat Variant 1.6 D		08/80→03/88	Diesel					
Santana 1.6 D		08/81→12/84				TD5013		
Golf II 1.6 D		08/83→10/91	JP	4cyl. 1588cc	40kW (54PS)			
Jetta II 1.6 D		01/84→10/91						
			Diesel			TD4120		
Caddy I 1.6 D		08/82→07/92	ME	4cyl. 1588cc	40kW (54PS)			
Golf II 1.6 D		08/83→10/91						
Jetta II 1.6 D		01/84→10/91						
			Diesel			TD4129		
08-109500-00	STD	76.50	1.750		001 IF CR P	KV1		
08-109505-00	0.25mm				005 IFU P	STD		
08-109507-00	0.50mm				231 CR P	STD		
08-109511-00	1.00mm							
12/1981→			3.000					
[R43850]								
08-405200-00	STD	76.50	1.750		001 IF CR P	KV1		
08-405205-00	0.25mm				005 IF P	STD		
08-405207-00	0.50mm				231 CR P	STD		
08-405211-00	1.00mm							
08/1976→			3.000					
Golf III 1.6		09/92→08/97	ABU	4cyl. 1598cc	55kW (75PS)			
Vento 1.6		09/92→09/98				11		
						TD4976		
08-502400-00	STD	76.50	1.500		001 CR P	IKA		
[R67010]					1.500		026 P	STD
					2.500		712 CR	ST



Polo 55 1.3	10/94→07/95	ADX	4cyl. 1296cc	40kW (54PS)	12
					TD4017
Golf III 1.6	09/92→08/97	AEA	4cyl.		
Polo 75 1.6	10/94→10/99		1598cc	55kW (75PS)	
Vento 1.6	09/92→09/98				TD4019
Caddy II Box 75 1.6	11/95→09/00	AEE	4cyl.		
Caddy II Estate 1.6	06/97→09/00		1598cc	55kW (75PS)	
Caddy II Pickup 1.6	06/96→12/00				
Golf III 1.6	09/92→08/97				
Polo 75 1.6	10/94→10/99				
Polo Classic 75 1.6	11/95→09/01				
Polo Variant 1.6	05/97→09/01				
Vento 1.6	09/92→09/98				TD4981
Caddy II Box 60 1.4, Caddy II Estate 1.4	11/95→01/04	AEX	4cyl.		
Golf III 1.4	10/91→08/97		1390cc	40-44kW (54-60PS)	
Golf III Variant 1.4	07/93→04/99				
Polo 55 1.4	08/95→10/99				
Polo 60 1.4	07/95→10/99				
Polo Box 1.4	05/98→12/99				
Polo Classic 60 1.4	12/95→09/01				
Polo Variant 1.4	05/97→09/01				
Vento 1.4	11/91→09/98				TD4984
Polo 75 1.6	10/94→10/99	AHS	4cyl. 1588cc	55kW (75PS)	
					TD12948
Caddy II Estate 1.4	11/95→01/04	AKV	4cyl.		
Polo 60 1.4	07/95→10/99		1390cc	44kW (60PS)	
Polo Classic 60 1.4	12/95→09/01				
Polo Variant 1.4	05/97→09/01				TD9688
Polo Classic 75 1.6	11/95→09/01	ALM	4cyl.		
Polo Variant 1.6	05/97→09/01		1598cc	55kW (75PS)	
					TD15610
Polo 1.4	10/99→09/01	ANX	4cyl.		
Polo Classic 54 1.4	01/98→08/99		1389cc	44kW (60PS)	
					TD15613
Caddy II Box 60 1.4, Caddy II Estate 1.4	11/95→01/04	APQ	4cyl.		
Golf III Variant 1.4	07/93→04/99		1390cc	44kW (60PS)	
Polo 60 1.4	07/95→10/99				
Polo Box 1.4	05/98→12/99				
Polo Classic 60 1.4	12/95→09/01				
Polo Variant 1.4	05/97→09/01				TD15614





Polo 1.2 12V			10/01→07/07	AZQ	3cyl. 1198cc	47kW (64PS)	TD16333
08-103100-00	STD	76.50	1.200		001 NT		ST
			1.500		005 P		STD
			2.500		236 P		STD
08-502800-00	STD	76.50	1.200		001 NT		ST
08-502807-00	0.50mm		1.500		026 P		STD
[R60280]			2.500		712 CR		ST
Polo 100 1.4 16V			04/96→10/99	AFH	4cyl. 1390cc	74kW (100PS)	13 TD4986
Lupo 1.4 16V			08/99→07/05	AFK	4cyl. 1390cc	74kW (100PS)	TD12028
Polo 1.4 16V			10/99→09/01				
Bora 1.4 16V			03/00→05/05	AHW	4cyl. 1390cc	55kW (75PS)	TD9453
Bora Estate 1.4 16V			09/01→05/05				
Golf IV 1.4 16V			08/97→06/05				
Golf IV Variant 1.4 16V			05/99→06/06				
Lupo 1.4 16V			09/98→07/05				
Polo 1.4 16V			10/99→09/01				
Polo 120 1.6 16V GTI			09/98→10/99	AJV	4cyl. 1598cc	88kW (120PS)	TD11247
Polo 1.4			10/99→09/01	AKK	4cyl. 1390cc	44kW (60PS)	TD13768
Polo Classic 60 1.4			12/95→09/01				
Polo Variant 1.4			05/97→09/01				
Bora 1.4 16V			03/00→05/05	AKQ	4cyl. 1390cc	55kW (75PS)	TD9454
Golf IV 1.4 16V			08/97→06/05				
Golf IV Variant 1.4 16V			05/99→06/06				
Lupo 1.4 16V			09/98→07/05				
Lupo 1.4i 16V			10/98→05/99	ANM	4cyl. 1390cc	74kW (100PS)	TD13470
Polo Classic 60 1.4			12/95→09/01	ANW	4cyl. 1390cc	44kW (60PS)	TD15568
Polo Variant 1.4			05/97→09/01				
Bora 1.4 16V			03/00→05/05	APE	4cyl. 1390cc	55kW (75PS)	TD13468
Golf IV 1.4 16V			08/97→06/05				
Golf IV Variant 1.4 16V			05/99→06/06				
Lupo 1.4 16V			09/98→07/05				
Polo 1.4 16V, Polo Classic 75 1.4 16V, Polo Variant 1.4 16V			10/99→09/01				





Lupo 1.4 16V Polo 1.4 16V	08/99→07/05 10/99→09/01	AQQ	4cyl. 1390cc	74kW (100PS)	TD13469
Polo 1.6 16V GTI	10/99→09/01	ARC	4cyl. 1598cc	92kW (125PS)	TD14169
Bora 1.6 16V Bora Estate 1.6 16V Golf IV 1.6 16V Golf IV Variant 1.6 16V	05/00→05/05 02/00→05/05 02/00→06/05 02/00→06/06	ATN	4cyl. 1595cc	77kW (105PS)	TD15476
Caddy II Box 1.4, Caddy II Estate 1.4 16V Lupo 1.4 16V Polo 1.4 16V Polo Classic 75 1.4 16V, Polo Variant 1.4 16V	08/00→01/04 09/98→07/05 10/99→05/08 10/99→09/01	AUA	4cyl. 1390cc	55kW (75PS)	TD13771
Lupo 1.4 16V Polo 1.4 16V	08/99→07/05 10/99→05/08	AUB	4cyl. 1390cc	74kW (100PS)	TD13772
Caddy II Box 60 1.4, Caddy II Estate 1.4 Lupo 1.4 Polo 1.4 Polo Classic 60 1.4 Polo Variant 1.4	11/95→01/04 10/00→07/05 10/99→09/01 12/95→09/01 05/97→09/01	AUD	4cyl. 1390cc	44kW (60PS)	TD13770
Bora 1.6 16V Bora Estate 1.6 16V Golf IV 1.6 16V Golf IV Variant 1.6 16V	05/00→05/05 02/00→05/05 02/00→06/05 02/00→06/06	AUS	4cyl. 1597cc	77kW (105PS)	TD15477
Lupo 1.6 GTI Polo 1.6 16V GTI	09/00→07/05 10/99→09/01	AVY	4cyl. 1598cc	92kW (125PS)	TD15493
Bora 1.4 16V Bora Estate 1.4 16V Golf IV 1.4 16V Golf IV Variant 1.4 16V	03/00→05/05 09/01→05/05 08/97→06/05 05/99→06/06	AXP	4cyl. 1390cc	55kW (75PS)	TD15474
Bora 1.6 16V Bora Estate 1.6 16V Golf IV 1.6 16V Golf IV Variant 1.6 16V	05/00→05/05 02/00→05/05 02/00→06/05 02/00→06/06	AZD	4cyl. 1597cc	77kW (105PS)	TD15478
Lupo 1.4 16V Polo 1.4 16V Polo Saloon 1.4	09/98→07/05 10/01→05/08 07/03→	BBY	4cyl. 1390cc	55kW (75PS)	TD16335
Polo 1.4 16V Polo Saloon 1.4	10/01→05/08 11/03→	BBZ	4cyl. 1390cc	74kW (100PS)	TD16540
Bora 1.6 16V Bora Estate 1.6 16V Golf IV 1.6 16V Golf IV Variant 1.6 16V	05/00→05/05 02/00→05/05 02/00→06/05 02/00→06/06	BCB	4cyl. 1598cc	77kW (105PS)	TD16387





Polo 1.4 FSI 16V			08/02→05/09	BLM				
Polo Sedan 1.4 FSI 16V			12/03→11/09		4cyl.			
					1390cc	63kW (86PS)		TD21076
08-116100-00	STD	76.50	1.200		001 NT			ST
08-116107-00	0.50mm		1.500		005 P			STD
			2.500		712 CR			ST
Lupo 1.2 TDI 3L			07/99→07/05	ANY				14
					3cyl.			
					1191cc	45kW (61PS)		
					Diesel	Turbo Intercooled		TD12029
Lupo 1.2 TDI 3L			07/99→07/05	AYZ				
					3cyl.			
					1191cc	45kW (61PS)		
					Diesel	Turbo Intercooled		TD15494
08-120100-00	STD	76.50	1.750		001 CK P			KV1
08-120107-00	0.50mm		2.000		005 IFU P			IKA
[R60520]			3.000		231 CR P			STD
Bora 1.4 16V			03/00→05/05	BCA				15
Bora Estate 1.4 16V			09/01→05/05		4cyl.			
Caddy III Box 1.4, Caddy III Estate 1.4			03/04→05/06		1390cc	55kW (75PS)		
Golf IV 1.4 16V			08/97→06/05					
Golf IV Variant 1.4 16V			05/99→06/06					
Golf Plus 1.4 16V			01/05→					
Golf V 1.4 16V			10/03→05/06					
New Beetle 1.4			11/01→					
New Beetle Convertible 1.4			01/03→09/10					TD16386
08-116100-00	STD	76.50	1.200		001 NT			ST
08-116107-00	0.50mm		1.500		005 P			STD
			2.500		712 CR			ST
08-436900-00	STD	76.50	1.200		001 NT			ST
			1.200		005 P			GOE13
			2.000		712 CR			ST
Fox 1.4			04/05→	BKR				16
					4cyl.			
					1390cc	55kW (75PS)		
								TD18271
Polo 1.4 16V			10/01→05/08	BKY				
Polo Saloon 1.4			07/03→		4cyl.			
					1390cc	55kW (75PS)		
								TD18154





Caddy III Box 1.4 16V, Caddy III Estate 1.4 16V	05/06→08/10	BUD	4cyl.			
Golf Plus 1.4 16V	05/06→		1390cc	59kW (80PS)		
Golf V 1.4 16V	05/06→11/08					
Golf V Variant 1.4	06/07→					
Golf VI Variant 1.4	07/09→					
Polo 1.4 16V	05/06→11/09					TD18909
Polo 1.4	06/09→	CDDA	4cyl.			
			1390cc	63kW (86PS)		TD25789
Golf Plus 1.4 16V	05/06→	CGGA	4cyl.			
Golf VI 1.4	10/08→11/12		1390cc	59kW (80PS)		TD20791
Golf VI Variant 1.4	07/09→					
Polo 1.4	06/09→	CGGB	4cyl.			
			1390cc	63kW (86PS)		TD23103
Polo 1.4	06/09→	CLPA	4cyl.			
			1390cc	63kW (86PS)		TD26336
08-436900-00	STD	76.50	1.200		001 NT	ST
			1.200		005 P	GOE13
			2.000		712 CR	ST
Eos 1.6 FSI	06/06→05/08	BLF	4cyl.			17
Golf Plus 1.6 FSI	01/05→05/08		1598cc	85kW (116PS)		
Golf V 1.6 FSI	10/03→07/08					
Jetta III 1.6 FSI	09/05→10/10					
Passat 1.6 FSI	03/05→06/08					
Passat Variant 1.6 FSI	08/05→06/08					
Touran 1.6 FSI	02/03→01/07					TD18100
Golf V 1.6 FSI	10/03→07/08	BLP	4cyl.			
Touran 1.6 FSI	02/03→01/07		1598cc	85kW (116PS)		TD18202
Eos 1.4 TSI	11/07→	CAXA	4cyl.			
Golf Plus 1.4 TSI	06/07→		1390cc	90kW (122PS)		
Golf V 1.4 TSI	05/07→11/08		Turbo Intercooled			
Golf V Variant 1.4 TSI	06/07→					
Golf VI 1.4 TSI	10/08→11/12					
Golf VI Convertible 1.4 TSI	11/11→					
Golf VI Variant 1.4 TSI	07/09→					
Jetta III 1.4 TSI	05/07→10/10					
Jetta IV 1.4 TSI	05/11→					
Passat 1.4 TSI, Passat Variant 1.4 TSI	05/07→					
Scirocco 1.4 TSI	08/08→					
Tiguan 1.4 TSI	08/10→					TD20606





Jetta IV 1.4 TSI		05/11→	CMSB		4cyl.				
Scirocco 1.4 TSI		08/08→			1390cc	90kW (122PS)			
					Turbo Intercooled			TD25468	
08-429900-00	STD	76.50	1.200		001 NT			ST	
08-429907-00	0.50mm		1.200		005 P			GOE13	
			2.000		712 NT			ST	
Golf Plus 1.4 TSI		05/06→06/08	BLG					18	
Golf V 1.4 TSI		11/05→11/08			4cyl.				
Golf V Variant 1.4 TSI		06/07→			1390cc	125kW (170PS)			
Jetta III 1.4 TSI		07/06→10/10			Turbo & Supercharged				
Touran 1.4 FSI		11/06→05/10					TD18470		
Golf Plus 1.4 TSI		05/06→06/08	BMV					TD18910	
Golf V 1.4 TSI		05/06→11/08			4cyl.				
Golf V Variant 1.4 TSI		06/07→			1390cc	103kW (140PS)			
Jetta III 1.4 TSI		07/06→10/10			Turbo & Supercharged				
Touran 1.4 TSI		02/06→05/10							
Tiguan 1.4 TSI		05/08→	BWK					TD20734	
Tiguan 1.4 TSI 4motion		09/07→			4cyl.	1390cc 110kW (150PS)			
Tiguan 1.4 TSI 4motion		09/07→			Turbo Intercooled				
Jetta IV 1.4 TSI		04/11→	CAVA					TD22452	
Sharan 1.4 TSI		05/10→			4cyl.				
Tiguan 1.4 TSI		05/08→			1390cc	110kW (150PS)			
Tiguan 1.4 TSI 4motion		09/07→			Turbo & Supercharged				
Touran 1.4 FSI		11/06→05/10	CAVB					TD22173	
Touran 1.4 TSI		05/10→			4cyl.	1390cc 125kW (170PS)			
Touran 1.4 TSI		02/06→	CAVC					TD22174	
Touran 1.4 TSI		02/06→			4cyl.	1390cc 103kW (140PS)			
Touran 1.4 TSI		02/06→			Turbo Intercooled				
Beetle 1.4 TSI		04/11→	CAVD					TD20792	
Beetle Convertible 1.4 TSI		12/12→			4cyl.				
Eos 1.4 TSI		05/08→			1390cc	118kW (160PS)			
Golf Plus 1.4 TSI		06/08→			Turbo & Supercharged				
Golf V Variant 1.4 TSI		07/08→							
Golf VI 1.4 TSI		10/08→11/12							
Golf VI Convertible 1.4 TSI		03/11→							
Golf VI Variant 1.4 TSI		07/09→							
Jetta III 1.4 TSI		07/08→10/10							
Jetta IV 1.4 TSI		04/11→							
Scirocco 1.4 TSI		05/08→							
Tiguan 1.4 TSI, Tiguan 1.4 TSI 4motion		05/11→							
Polo 1.4 GTI		05/10→	CAVE						TD24000
Polo 1.4 GTI		05/10→			4cyl.	1390cc 132kW (180PS)			
Polo 1.4 GTI		05/10→			Turbo & Supercharged				





Beetle 1.4 TSI		04/11→		CNWA				
Beetle Convertible 1.4 TSI		12/12→			4cyl.			
Golf Plus 1.4 TSI		06/08→			1390cc	118kW (160PS)		
Golf VI 1.4 TSI		10/08→11/12			Turbo & Supercharged			
Golf VI Convertible 1.4 TSI		03/11→						
Golf VI Variant 1.4 TSI		07/09→						
Scirocco 1.4 TSI		05/08→						TD24834
Sharan 1.4 TSI		05/10→		CNWB				
					4cyl.			
					1390cc	110kW (150PS)		
					Turbo & Supercharged			TD27017
Jetta IV 1.4 TSI		04/11→		CTHA				
Sharan 1.4 TSI		05/10→			4cyl.			
Tiguan 1.4 TSI		05/08→			1390cc	110kW (150PS)		
Tiguan 1.4 TSI 4motion		09/07→			Turbocharger/Compressor			TD26573
Polo 1.4 GTI		05/10→		CTHE				
					4cyl.			
					1390cc	132kW (180PS)		
					Turbo & Supercharged			TD27355
08-433900-00	STD	76.50	1.200		001 NT			ST
08-433907-00	0.50mm		1.500		005 P			GOE13
			2.000		712 NT			ST
1200, 1200A, 1300, 1300A Ghia, Beetle		01/65→12/77		113				19
					4cyl.			
					1285cc	30kW (41PS)		FM1798
Kaefer 1300 1.3		01/70→01/73		AB				
Kaefer 1302 1.3		08/70→08/72			B4cyl.			
Kaefer 1303 1.3		08/72→07/75			1285cc	32kW (44PS)		
Kaefer Convertible 1303 1.3		07/70→03/81						
Karmann Ghia Coupe 1300		07/70→07/74						TD4005
Kaefer 1200 1.2		01/60→12/85		D				
Kaefer 1302 1.2		08/69→08/72			B4cyl.			
Kaefer 1303 1.2		07/72→02/76			1192cc	25kW (34PS)		
Kaefer Convertible 1303 1.2		04/75→12/79						
Karmann Ghia Convertible 1200		09/57→12/64						TD4054
Kaefer 1300 1.3		08/65→07/70		E				
					B4cyl.			
					1285cc	27kW (37PS)		TD5132





Kaefer 1300 1.3	01/65→07/70	F			
Kaefer Convertible Karmann 1.3	07/64→07/70		B4cyl.		
Karmann Ghia Convertible 1500	07/64→07/74		1285cc	29kW (39PS)	
					TD4076

08-390200-00	STD	77.00	2.500		005 IF P	STD	
08-390205-00	0.25mm				026 P	STD	
08-390207-10 →07/1972	0.50mm			4.000		712 CR	ST
08-394500-00	STD	77.00	2.000		005 IF P	STD	
08-394505-00	0.25mm			2.000		026 P	STD
08-394507-00 08/1972→	0.50mm			4.000		231 P	STD
<i>[R46210]</i>							

Passat 2.5 TDI	07/98→05/05	AFB			
Passat 2.5 TDI 4motion	11/00→05/05		V6cyl.		
Passat 2.5 TDI Syncro/4motion	12/98→11/00		2496cc	110kW (150PS)	
Passat Variant 2.5 TDI	07/98→05/05	Diesel	Turbo Intercooled		
Passat Variant 2.5 TDI 4motion	11/00→05/05				
Passat Variant 2.5 TDI Syncro/4motion	12/98→11/00				TD11499

20

Passat 2.5 TDI	07/98→05/05	AKN			
Passat 2.5 TDI 4motion	11/00→05/05		V6cyl.		
Passat 2.5 TDI Syncro/4motion	12/98→11/00		2496cc	110kW (150PS)	
Passat Variant 2.5 TDI	07/98→05/05	Diesel	Turbo Intercooled		
Passat Variant 2.5 TDI 4motion	11/00→05/05				
Passat Variant 2.5 TDI Syncro/4motion	12/98→11/00				TD11498

Passat 2.5 TDI 4motion, Passat Variant 2.5 TDI 4motion	01/03→05/05	BAU			
			V6cyl.		
			2496cc	132kW (180PS)	
		Diesel	Turbo Intercooled		
					TD17046

Passat 2.5 TDI, Passat Variant 2.5 TDI	05/03→05/05	BDG			
			V6cyl.		
			2496cc	120kW (163PS)	
		Diesel	Turbo Intercooled		
					TD16985

Passat 2.5 TDI 4motion, Passat Variant 2.5 TDI 4motion	01/03→05/05	BDH			
			V6cyl.		
			2496cc	132kW (180PS)	
		Diesel	Turbo Intercooled		
					TD17047

08-103000-00	STD	78.30	1.750		001 CK P	KV1	
08-103007-00	0.50mm			2.000		005 IFU P	IKA
				3.000		231 CR P	STD
<i>[R66900]</i>							

Transporter IV Box 1.9 D	07/90→12/95	1X			
Transporter IV Bus 1.9 D	09/90→12/95		4cyl.		
Transporter IV Platform/Chassis 1.9 D	07/90→12/95		1896cc	44kW (60PS)	
		Diesel			TD3997

21

Caddy II Box 1.9 D, Caddy II Estate 1.9 D	11/95→01/04	1Y			
Golf III 1.9 D	11/91→08/97		4cyl.		
Golf III Variant 1.9 D	07/93→04/99		1896cc	47-50kW (64-68PS)	
Passat 1.9 D, Passat Variant 1.9 D	05/89→10/93	Diesel			
Polo Classic 64 1.9 D	01/96→10/96				
Vento 1.9 D	11/91→09/98				
Voyage 1.9 D	06/96→09/01				TD4960





Transporter IV Box 2.4 D	07/90→04/98	AAB					
Transporter IV Box 2.4 D Syncro	10/92→09/98		5cyl.				
Transporter IV Bus 2.4 D	09/90→04/98		2370cc	57kW (77PS)			
Transporter IV Bus 2.4 D Syncro	10/92→09/98	Diesel					
Transporter IV Platform/Chassis 2.4 D	09/90→04/98						
Transporter IV Platform/ Chassis 2.4 D Syncro	10/92→09/98				TD4000		
Golf III 1.9 TD, GTD	11/91→08/97	AAZ					
Golf III Variant 1.9 TD	07/93→04/99		4cyl.				
Golf IV 1.9 TD	10/97→09/99		1896cc	55kW (75PS)			
Passat 1.9 TD	03/91→08/96	Diesel	Turbo				
Passat Variant 1.9 TD	03/91→05/97						
Vento 1.9 TD	11/91→09/98				TD4972		
Transporter IV Box 1.9 TD, Transporter IV Bus 1.9 TD, Transporter IV Platform/Chassis 1.9 TD	10/92→04/03	ABL	4cyl.				
			1896cc	50kW (68PS)			
		Diesel	Turbo		TD4009		
Stationary engine	04/94→01/02	ADE	4cyl.				
			1896cc	55kW (75PS)			
		Diesel	Turbo		TD20097		
Stationary engine	04/94→01/02	ADG	4cyl.				
			1896cc	48kW (65PS)			
		Diesel			TD20098		
Caddy II Pickup 1.9 D	06/96→12/00	AEF					
Polo 1.9 D	10/99→09/01		4cyl.				
Polo 64 1.9 D	10/94→10/99		1896cc	47kW (64PS)			
Polo Box 1.9 D	10/94→12/99	Diesel			TD4020		
Transporter IV Box 2.4 D, Transporter IV Bus 2.4 D, Transporter IV Platform/Chassis 2.4 D	08/97→04/03	AJA	5cyl.				
			2370cc	55kW (75PS)			
		Diesel			TD11049		
Transporter III Box 1.7 D	08/85→07/92	KY					
Transporter III Bus 1.7 D	10/86→07/92		4cyl.				
Transporter III Platform/Chassis 1.7 D	08/85→07/92		1715cc	42kW (57PS)			
		Diesel			TD4126		
08-990100-00	STD	79.50	1.750		001 CR P	KV1	
08-990105-00	0.25mm				005 IFU P	STD	
08-990107-00	0.50mm		2.000				
08-990111-00	1.00mm		3.000		231 CR P	STD	
<i>[R45120]</i>							
Caddy II Box 1.9 TDI	09/96→01/04	1Z					
Golf III 1.9 TDI	09/93→08/97		4cyl.				
Golf III 1.9 TDI Syncro	08/95→08/97		1896cc	66kW (89PS)			
Golf III Cabriolet 1.9 TDI	08/95→05/98	Diesel	Turbo Intercooled				
Golf III Variant 1.9 TDI	03/94→04/99						
Golf III Variant 1.9 TDI Syncro	07/95→04/99						
Passat 1.9 TDI	10/93→08/96						
Passat Variant 1.9 TDI	10/93→05/97						
Sharan 1.9 TDI	09/95→03/10						
Vento 1.9 TDI	09/93→09/98						
Voyage 1.9 TDi	09/99→09/01					TD4961	





Caddy II Box 1.9 SDI, Caddy II Estate 1.9 SDI	11/95→01/04	AEY	4cyl.		
Golf III 1.9 SDI	07/95→08/97		1896cc	47kW (64PS)	
Golf III Variant 1.9 SDI	07/95→04/99	Diesel			
Polo Classic 1.9 SDI	06/96→09/01				
Polo Classic 64 1.9 SDI	12/95→08/99				
Polo Variant 1.9 SDI	06/97→09/01				
Vento 1.9 SDI	04/97→09/98				TD4985
Golf III 1.9 TDI	04/96→08/97	AFN	4cyl.		
Golf III Cabriolet 1.9 TDI	07/96→05/98		1896cc	81kW (110PS)	
Golf III Variant 1.9 TDI	04/96→04/99				
Golf IV Cabriolet 1.9 TDI	06/98→06/02	Diesel	Turbo Intercooled		
Passat 1.9 TDI	03/96→11/00				
Passat 1.9 TDI Syncro/4motion	10/96→11/00				
Passat Variant 1.9 TDI	03/96→11/00				
Passat Variant 1.9 TDI Syncro/4motion	06/97→11/00				
Polo Classic 110 1.9 TDI	06/98→01/02				
Polo Variant 1.9 TDI	06/98→09/01				
Sharan 1.9 TDI	09/96→04/00				
Vento 1.9 TDI	04/96→09/98				TD4987
Polo 1.9 SDI	10/99→09/01	AGD	4cyl.		
Polo 64 1.9 SDI	07/96→10/99		1896cc	47kW (64PS)	
Polo Box 1.9 SDI	07/96→12/99	Diesel			TD9372
Bora 1.9 SDI	10/98→05/05	AGP	4cyl.		
Golf IV 1.9 SDI	08/97→06/05		1896cc	50kW (68PS)	
Golf IV Variant 1.9 SDI	05/99→06/06				
Polo Classic 68 1.9 SDI	08/99→01/02	Diesel			
Polo Variant 1.9 SDI	08/99→09/01				TD9452
Bora 1.9 TDI	10/98→06/01	AGR	4cyl.		
Bora 1.9 TDI 4motion	02/99→06/01		1896cc	66kW (89PS)	
Bora Estate 1.9 TDI	07/04→05/05				
Golf IV 1.9 TDI	10/97→05/04	Diesel	Turbo Intercooled		
Golf IV 1.9 TDI 4motion	07/98→04/02				
Golf IV Variant 1.9 TDI	05/99→05/06				
Golf IV Variant 1.9 TDI 4motion	05/99→04/02				
Polo Classic 90 1.9 TDI	09/96→09/01				
Polo Variant 1.9 TDI	05/97→09/01				TD9364
Caddy II Box 1.7 SDI, Caddy II Estate 1.7 SDI	07/96→09/00	AHB	4cyl.		
			1716cc	42kW (57PS)	
		Diesel			TD15028
Bora 1.9 TDI	10/98→06/01	AHF	4cyl.		
Bora Estate 1.9 TDI	05/99→06/01		1896cc	81kW (110PS)	
Golf IV 1.9 TDI	08/97→05/04				
Golf IV Variant 1.9 TDI	05/99→06/01	Diesel	Turbo Intercooled		TD9788
Polo 1.7 SDI	04/97→10/99	AHG	4cyl.		
			1716cc	42kW (57PS)	
		Diesel			TD11207
Passat 1.9 TDI	10/96→11/00	AHH	4cyl.		
Passat Variant 1.9 TDI	06/97→11/00		1896cc	66kW (89PS)	
		Diesel	Turbo Intercooled		TD10927





Caddy II Box 1.9 TDI	09/96→01/04	AHU			
Caddy II Estate 1.9 TDI	10/96→01/04		4cyl.		
Golf III 1.9 TDI	09/93→08/97		1896cc	66kW (89PS)	
Golf III 1.9 TDI Syncro	08/95→08/97	Diesel	Turbo Intercooled		
Golf III Cabriolet 1.9 TDI	08/95→05/98				
Golf III Variant 1.9 TDI	03/94→04/99				
Golf III Variant 1.9 TDI Syncro	07/95→04/99				
Golf IV Cabriolet 1.9 TDI	06/98→06/02				
Passat 1.9 TDI, Passat Variant 1.9 TDI	10/93→11/00				
Polo Classic 1.9 TDI	01/97→08/99				
Polo Classic 90 1.9 TDI	09/96→09/01				
Polo Variant 1.9 TDI	05/97→09/01				
Sharan 1.9 TDI	09/95→03/10				
Vento 1.9 TDI	09/93→09/98				TD4990
Bora 1.9 TDI	12/98→01/02	AJM			
Bora 1.9 TDI 4motion	02/99→06/01		4cyl.		
Bora Estate 1.9 TDI,	05/99→06/01		1896cc	85kW (116PS)	
Bora Estate 1.9 TDI 4motion		Diesel	Turbo Intercooled		
Golf IV 1.9 TDI	12/98→06/01				
Golf IV 1.9 TDI 4motion	09/99→06/01				
Golf IV Variant 1.9 TDI	08/99→06/01				
Golf IV Variant 1.9 TDI 4motion	05/99→06/01				
Passat 1.9 TDI	08/98→11/00				
Passat 1.9 TDI 4motion	08/99→11/00				
Passat Variant 1.9 TDI	08/98→11/00				TD12588
Lupo 1.7 SDI	09/98→07/05	AKU			
Polo 1.7 SDI	10/99→09/01		4cyl.		
Polo 60 1.7 SDI	08/97→10/99		1716cc	44kW (60PS)	
Polo Box 1.7 SDI	08/97→12/99	Diesel			TD9513
Polo Classic 57 1.7 SDI	07/97→09/01	AKW			
Polo Variant 1.7 SDI	08/97→09/01		4cyl.		
			1716cc	42kW (57PS)	
		Diesel			TD9687
Caddy II Estate 1.9 TDI	10/96→01/04	ALE			
Golf III 1.9 TDI	09/93→08/97		4cyl.		
Golf III 1.9 TDI Syncro	08/95→08/97		1896cc	66kW (89PS)	
Golf III Cabriolet 1.9 TDI	08/95→05/98	Diesel	Turbo Intercooled		
Golf III Variant 1.9 TDI	03/94→04/99				
Golf III Variant 1.9 TDI Syncro	07/95→04/99				
Golf IV Cabriolet 1.9 TDI	06/98→06/02				
Polo Classic 90 1.9 TDI	09/96→09/01				
Polo Variant 1.9 TDI	05/97→09/01				
Vento 1.9 TDI	09/93→09/98				TD9512
Bora 1.9 TDI	10/98→06/01	ALH			
Caddy II Box 1.9 TDI	09/96→01/04		4cyl.		
Caddy II Estate 1.9 TDI	10/96→01/04		1896cc	66kW (89PS)	
Golf IV 1.9 TDI	10/97→05/04	Diesel	Turbo Intercooled		
Golf IV 1.9 TDI 4motion	07/98→04/02				
Golf IV Variant 1.9 TDI	05/99→05/06				
Golf IV Variant 1.9 TDI 4motion	05/99→04/02				
New Beetle 1.9 TDI	01/98→06/04				
Polo Classic 90 1.9 TDI	09/96→09/01				
Polo Variant 1.9 TDI	05/97→09/01				TD9455
Lupo 1.4 TDI	01/99→07/05	AMF			
Polo 1.4 TDI	10/99→06/05		3cyl.		
			1422cc	55kW (75PS)	
		Diesel	Turbo Intercooled		TD12589





Sharan 1.9 TDI	09/95→03/10	ANU	4cyl. 1896cc 66kW (89PS)	Diesel	Turbo Intercooled	TD13443
Bora 1.9 SDI	10/98→05/05	AQM	4cyl. 1896cc 50kW (68PS)	Diesel	Turbo Intercooled	TD11351
Golf IV 1.9 SDI	08/97→06/05					
Golf IV Variant 1.9 SDI	05/99→06/06					
Polo Classic 68 1.9 SDI	08/99→01/02					
Polo Variant 1.9 SDI	08/99→09/01					
Bora 1.9 TDI, Bora 1.9 TDI 4motion	05/00→05/05	ARL	4cyl. 1896cc 110kW (150PS)	Diesel	Turbo Intercooled	TD15484
Bora Estate 1.9 TDI,	05/01→05/05					
Bora Estate 1.9 TDI 4motion						
Golf IV 1.9 TDI	05/00→06/05					
Golf IV 1.9 TDI 4motion	02/00→06/05					
Golf IV Variant 1.9 TDI 4motion	05/02→06/05					
Bora 1.9 TDI	10/98→06/01	ASV	4cyl. 1896cc 81kW (110PS)	Diesel	Turbo Intercooled	TD13773
Bora Estate 1.9 TDI	05/99→06/01					
Golf IV 1.9 TDI	08/97→05/04					
Golf IV Variant 1.9 TDI	05/99→06/01					
Polo Classic 110 1.9 TDI	06/98→01/02					
Polo Variant 1.9 TDI	06/98→09/01					
Polo 1.9 SDI	10/99→09/01	ASX	4cyl. 1896cc 47kW (64PS)	Diesel		TD15495
Polo 1.9 SDI	10/01→11/09	ASY	4cyl. 1896cc 47kW (64PS)	Diesel		TD16338
Polo Saloon 1.9 SDI	09/02→					
Bora 1.9 TDI, Bora 1.9 TDI 4motion,	11/00→05/05	ASZ	4cyl. 1896cc 96kW (131PS)	Diesel	Turbo Intercooled	TD16231
Bora Estate 1.9 TDI,						
Bora Estate 1.9 TDI 4motion						
Golf IV 1.9 TDI, Golf IV 1.9 TDI 4motion	11/00→06/05					
Golf IV Variant 1.9 TDI,	11/00→06/06					
Golf IV Variant 1.9 TDI 4motion						
Polo 1.9 TDI	11/03→11/09					
Sharan 1.9 TDI	11/02→03/10					
Bora 1.9 TDI, Bora 1.9 TDI 4motion,	09/00→05/05	ATD	4cyl. 1896cc 74kW (100PS)	Diesel	Turbo Intercooled	TD15473
Bora Estate 1.9 TDI,						
Bora Estate 1.9 TDI 4motion						
Golf IV 1.9 TDI, Golf IV 1.9 TDI 4motion	09/00→06/05					
Golf IV Variant 1.9 TDI,	09/00→06/06					
Golf IV Variant 1.9 TDI 4motion						
New Beetle 1.9 TDI	02/01→					
Polo 1.9 TDI	10/01→11/09					
Polo Saloon 1.9 TDi	09/02→					
Passat 1.9 TDI	08/98→11/00	ATJ	4cyl. 1896cc 85kW (116PS)	Diesel	Turbo Intercooled	TD16258
Passat 1.9 TDI 4motion	08/99→11/00					
Passat Variant 1.9 TDI	08/98→11/00					
Passat Variant 1.9 TDI 4motion	08/99→11/00					
Polo 1.4 TDi	01/00→10/00	ATL	3cyl. 1422cc 66kW (89PS)	Diesel	Turbo Intercooled	TD21352





Bora 1.9 TDI	12/98→01/02	AUY			
Bora 1.9 TDI 4motion	02/99→06/01		4cyl.		
Bora Estate 1.9 TDI,	05/99→06/01		1896cc	85kW (116PS)	
Bora Estate 1.9 TDI 4motion		Diesel	Turbo Intercooled		
Golf IV 1.9 TDI	12/98→06/01				
Golf IV 1.9 TDI 4motion	09/99→06/01				
Golf IV Variant 1.9 TDI	08/99→06/01				
Sharan 1.9 TDI, Sharan 1.9 TDI 4motion	04/00→03/10				TD14915
Passat 1.9 TDI, Passat Variant 1.9 TDI	02/00→05/05	AVB			
			4cyl.		
			1896cc	74kW (100PS)	
		Diesel	Turbo Intercooled		TD15152
Passat 1.9 TDI, Passat 1.9 TDI 4motion, Passat Variant 1.9 TDI, Passat Variant 1.9 TDI 4motion	11/00→05/05	AVF			
			4cyl.		
			1896cc	96kW (131PS)	
		Diesel	Turbo Intercooled		TD15153
Golf IV Cabriolet 1.9 TDI	06/98→06/02	AVG			
Passat 1.9 TDI, Passat 1.9 TDI Syncro/ 4motion	10/96→11/00		4cyl.		
Passat Variant 1.9 TDI,	06/97→11/00	Diesel	1896cc	81kW (110PS)	
Passat Variant 1.9 TDI Syncro/4motion			Turbo Intercooled		
Sharan 1.9 TDI	09/96→04/00				TD14988
Touran 1.9 TDI	02/03→05/04	AVQ			
			4cyl.		
			1896cc	74kW (100PS)	
		Diesel	Turbo Intercooled		TD16861
Passat 1.9 TDI, Passat Variant 1.9 TDI	11/00→05/05	AWX			
			4cyl.		
			1896cc	96kW (131PS)	
		Diesel	Turbo Intercooled		TD15154
Multivan V 1.9 TDI, Transporter V Box 1.9 TDI, Transporter V Bus 1.9 TDI, Transporter V Platform/Chassis 1.9 TDI	04/03→11/09	AXB			
			4cyl.		
			1896cc	77kW (105PS)	
		Diesel	Turbo Intercooled		TD16867
Multivan V 1.9 TDI, Transporter V Box 1.9 TDI, Transporter V Bus 1.9 TDI, Transporter V Platform/Chassis 1.9 TDI	04/03→11/09	AXC			
			4cyl.		
			1896cc	63kW (86PS)	
		Diesel	Turbo Intercooled		TD16881
Bora 1.9 TDI, Bora Estate 1.9 TDI	09/00→05/05	AXR			
Golf IV 1.9 TDI	09/00→06/05		4cyl.		
Golf IV Variant 1.9 TDI	09/00→06/06		1896cc	74kW (100PS)	
New Beetle Convertible 1.9 TDI	06/03→09/10	Diesel	Turbo Intercooled		
Polo 1.9 TDI	10/01→11/09				TD16337
Caddy II Box 1.9 SDI, Caddy II Estate 1.9 SDI	11/95→01/04	AYQ			
			4cyl.		
			1896cc	47kW (64PS)	
		Diesel			TD16863
Polo 1.4 TDI	10/01→06/05	BAY			
Polo Saloon 1.4 TDI	07/03→		3cyl.		
			1422cc	55kW (75PS)	
		Diesel	Turbo Intercooled		TD16336
Polo 1.4 TDI	04/05→11/09	BMS			
			3cyl.		
			1422cc	59kW (80PS)	
		Diesel	Turbo Intercooled		TD18157





Fox 1.4 TDI		04/05→	BNM		3cyl.			
Polo 1.4 TDI		04/05→11/09			1422cc	51kW (69PS)		
			Diesel	Turbo Intercooled				TD18159
Polo 1.4 TDI		04/05→11/09	BNV		3cyl.			
					1422cc	59kW (80PS)		
			Diesel	Turbo Intercooled				TD18158
Polo 1.4 TDI		04/05→11/09	BWB		3cyl.			
					1422cc	51kW (69PS)		
			Diesel	Turbo Intercooled				TD20514
08-114900-00	STD	79.50	1.750		001 CK P			KV1
08-114905-00	0.25mm		2.000		005 IFU P			STD
08-114907-00	0.50mm		3.000		231 CR P			STD
08-114911-00	1.00mm							
[R60370]								
Stationary engine			BEQ		4cyl.			23
					1896cc	33kW (45PS)		
			Diesel					TD20100
Parati 1.9 SDI		08/02→	BGG		4cyl.			
					1896cc	47kW (64PS)		
			Diesel					TD21349
Stationary engine			BGL		4cyl.			
					1896cc	37kW (50PS)		
			Diesel					TD25870
Stationary engine			BGM		4cyl.			
					1896cc	29kW (39PS)		
			Diesel					TD25871
Stationary engine			BJC		4cyl.			
					1896cc	53kW (72PS)		
			Diesel	Turbo Intercooled				TD22453
Passat 1.9 TDI		04/08→07/08	BPZ		4cyl.			
					1896cc	85kW (116PS)		
			Diesel	Turbo Intercooled				TD25766
Sharan 1.9 TDI		06/05→03/10	BTB		4cyl.			
					1896cc	110kW (150PS)		
			Diesel	Turbo Intercooled				TD18232
Stationary engine			BXT		4cyl.			
					1896cc	30kW (41PS)		
			Diesel					TD25869
Stationary engine			CDXA		4cyl.			
					1896cc	55kW (75PS)		
			Diesel					TD23291





Stationary engine				CDXB		
				4cyl.		
				1896cc 29kW (39PS)		
				Diesel		
				TD23292		
08-433000-00	STD	79.50	1.750		001 GDC P	KV4
08-433007-00	0.50mm		2.000		005 IFU P	F12/F14
with DPF			3.000		231 LKZ CR P	GOE13

Stationary engine			BEU		24
			4cyl.		
			1896cc 33kW (45PS)		
			Diesel		TD20101
New Beetle 1.9 TDI		02/01→	BEW		
			4cyl.		
			1896cc 74kW (100PS)		
			Diesel Turbo Intercooled		TD19255
Caddy III Box 1.9 TDI, Caddy III Estate 1.9 TDI		04/04→08/10	BJB		
			4cyl.		
			1896cc 77kW (105PS)		
			Diesel Turbo Intercooled		TD17078
Golf Plus 1.9 TDI		01/05→01/09	BKC		
Golf V 1.9 TDI		10/03→11/08	4cyl.		
Golf V 1.9 TDI 4motion		08/04→11/08	1896cc 77kW (105PS)		
Jetta III 1.9 TDI		08/05→10/10	Diesel Turbo Intercooled		
Passat 1.9 TDI		03/05→11/08			
Passat Variant 1.9 TDI		08/05→11/08			
Touran 1.9 TDI		08/03→05/10	TD17079		
Caddy III Box 1.9 TDI		04/04→08/10	BLS		
Caddy III Box 1.9 TDI 4motion		11/08→08/10	4cyl.		
Caddy III Estate 1.9 TDI		04/04→08/10	1896cc 77kW (105PS)		
Caddy III Estate 1.9 TDI 4motion		05/08→08/10	Diesel Turbo Intercooled		
Golf Plus 1.9 TDI		01/05→01/09			
Golf V 1.9 TDI		10/03→11/08			
Golf V 1.9 TDI 4motion		08/04→11/08			
Golf V Variant 1.9 TDI		06/07→			
Golf V Variant 1.9 TDI 4motion		01/08→			
Jetta III 1.9 TDI		08/05→10/10			
Passat 1.9 TDI		03/05→11/08			
Passat Variant 1.9 TDI		08/05→11/08			
Touran 1.9 TDI		08/03→05/10	TD18224		
Polo 1.9 TDI		11/03→11/09	BLT		
			4cyl.		
			1896cc 96kW (131PS)		
			Diesel Turbo Intercooled		TD17467
Polo 1.9 TDI		10/01→11/09	BMT		
			4cyl.		
			1896cc 74kW (100PS)		
			Diesel Turbo Intercooled		TD20494
Polo 1.9 TDI			BRM		
			4cyl.		
			1896cc 74kW (100PS)		
			Diesel Turbo Intercooled		TD20629





Multivan V 1.9 TDI, Transporter V Box 1.9 TDI, Transporter V Bus 1.9 TDI, Transporter V Platform/Chassis 1.9 TDI	01/06→11/09	BRR	4cyl. 1896cc 62kW (84PS)	Diesel Turbo Intercooled	TD20159
Multivan V 1.9 TDI, Transporter V Box 1.9 TDI, Transporter V Bus 1.9 TDI, Transporter V Platform/Chassis 1.9 TDI	06/06→11/09	BRS	4cyl. 1896cc 75kW (102PS)	Diesel Turbo Intercooled	TD18994
Golf Plus 1.9 TDI Golf V 1.9 TDI Touran 1.9 TDI	05/05→12/08 05/04→11/08 11/04→05/10	BRU	4cyl. 1896cc 66kW (89PS)	Diesel Turbo Intercooled	TD17468
Caddy III Box 1.9 TDI, Caddy III Estate 1.9 TDI	09/05→08/10	BSU	4cyl. 1896cc 55kW (75PS)	Diesel Turbo Intercooled	TD18755
New Beetle 1.9 TDI New Beetle Convertible 1.9 TDI	07/05→ 07/05→09/10	BSW	4cyl. 1896cc 77kW (105PS)	Diesel Turbo Intercooled	TD18771
Sharan 1.9 TDI, Sharan 1.9 TDI 4motion	04/00→03/10	BVK	4cyl. 1896cc 85kW (116PS)	Diesel Turbo Intercooled	TD20489
Golf Plus 1.9 TDI Golf V 1.9 TDI Golf V 1.9 TDI 4motion Golf V Variant 1.9 TDI Jetta III 1.9 TDI Passat 1.9 TDI Passat Variant 1.9 TDI Touran 1.9 TDI	01/05→01/09 10/03→11/08 08/04→11/08 06/07→ 08/05→10/10 03/05→11/08 08/05→11/08 08/03→05/10	BXE	4cyl. 1896cc 77kW (105PS)	Diesel Turbo Intercooled	TD18908
Golf Plus 1.9 TDI Golf V 1.9 TDI Touran 1.9 TDI	05/05→12/08 05/04→11/08 11/04→05/10	BXF	4cyl. 1896cc 66kW (89PS)	Diesel Turbo Intercooled	TD18907
Golf Plus 1.9 TDI Golf V 1.9 TDI Touran 1.9 TDI	05/05→12/08 05/04→11/08 11/04→05/10	BXJ	4cyl. 1896cc 66kW (89PS)	Diesel Turbo Intercooled	TD20493

08-114900-00	STD	79.50	1.750		001 CK P	KV1	
08-114905-00	0.25mm				005 IFU P	STD	
08-114907-00	0.50mm		2.000				
08-114911-00	1.00mm		3.000		231 CR P	STD	
[R60370]							
08-433000-00	STD	79.50	1.750		001 GDC P	KV4	
08-433007-00	0.50mm				005 IFU P	F12/F14	
01/2006→ with DPF			2.000				
			3.000		231 LKZ CR P	GOE13	



Polo 1.6 TDI	06/09→	CAYA	4cyl. 1598cc 55kW (75PS)	25
		Diesel	Turbo Intercooled	TD23105
Golf Plus 1.6 TDI	02/09→	CAYB	4cyl. 1598cc 66kW (89PS)	
Golf VI 1.6 TDI	02/09→11/12			
Golf VI Variant 1.6 TDI	12/09→			
Jetta III 1.6 TDI	12/09→10/10	Diesel	Turbo Intercooled	
Polo 1.6 TDI	06/09→			
Touran 1.6 TDI	05/10→			TD22638
Beetle 1.6 TDI	10/11→	CAYC	4cyl. 1598cc 77kW (105PS)	
Beetle Convertible 1.6 TDI	12/12→			
Golf Plus 1.6 TDI	03/09→			
Golf VI 1.6 TDI	02/09→11/12	Diesel	Turbo Intercooled	
Golf VI Convertible 1.6 TDI	03/11→			
Golf VI Variant 1.6 TDI, Golf VI Variant 1.6 TDI 4motion	07/09→			
Jetta III 1.6 TDI	06/09→10/10			
Jetta IV 1.6 TDI	02/11→			
Passat 1.6 TDI, Passat Variant 1.6 TDI	08/09→			
Polo 1.6 TDI	06/09→			
Touran 1.6 TDI	05/10→			TD22639
Caddy III Box 1.6 TDI, Caddy III Estate 1.6 TDI	08/10→	CAYD	4cyl. 1598cc 75kW (102PS)	
		Diesel	Turbo Intercooled	TD24364
Caddy III Box 1.6 TDI, Caddy III Estate 1.6 TDI	08/10→	CAYE	4cyl. 1598cc 55kW (75PS)	
		Diesel	Turbo Intercooled	TD24365
Polo 1.2 TDI	10/09→	CFWA	3cyl. 1199cc 55kW (75PS)	
		Diesel	Turbo Intercooled	TD23610
Polo 1.6 TDI	06/09→	CLNA	4cyl. 1598cc 77kW (105PS)	
		Diesel	Turbo Intercooled	TD25704

08-432900-00	STD	79.50	1.750		001 GDC P	KV4
08-432907-00	0.50mm		2.000		005 IFU P	F12/F14
			3.000		231 LKZ CR P	STD



Golf, Scirocco	02/76→07/77	EE	4cyl. 1588cc 60kW (81PS)	26
				TD4065
Golf I 1.6, Scirocco 1.6	08/75→07/77	FT	4cyl. 1588cc 51kW (69PS)	
				TD4089

08-399200-00	STD	79.50	1.750		001 IF CR P	IKA
08/1975→07/1977			2.500		026 P	STD
[R46220]			5.000		236 P	STD



Scirocco 1.6	02/76→07/76	EF	4cyl. 1588cc	60kW (81PS)	27 TD4066
Golf 1.5, Rabbit 1.5 Scirocco 1.5	08/77→07/79 08/76→07/80	EH	4cyl. 1457cc	57kW (77PS)	TD21347
Golf 1.6, Jetta 1.6, Rabbit 1.6, Scirocco 1.6	08/79→07/80	EJ	4cyl. 1588cc	61kW (82PS)	TD4067
Golf 1.7i Jetta 1.7 Rabbit 1.7 Scirocco 1.7i	08/80→12/83 08/80→02/84 08/81→02/84 08/80→07/83	EN	4cyl. 1716cc	57kW (77PS)	TD22652
Golf I 1.6 Scirocco 1.6	08/75→02/84 08/75→07/79	FP	4cyl. 1588cc	55kW (75PS)	TD4086
Jetta I 1.6 Scirocco 1.6	08/78→02/84 08/75→04/84	FR	4cyl. 1588cc	63kW (86PS)	TD4088
Golf 1.6i Scirocco 1.6i	01/76→07/79 02/74→07/80	FV	4cyl. 1588cc	51kW (69PS)	TD4090
Golf 1.5, Jetta 1.5 Scirocco 1.5	08/79→07/80 08/78→07/80	GH	4cyl. 1457cc	48kW (65PS)	TD22653
Caddy I 1.5 Golf I 1.5 Golf I Cabriolet 1.5 Jetta I 1.5 Scirocco 1.5	08/82→07/83 08/77→07/83 01/79→11/83 08/78→02/84 08/77→12/83	JB	4cyl. 1457cc	51kW (69PS)	TD4115
Passat 2.1, Passat Variant 2.1 Santana 2.1	01/81→07/83 08/82→12/83	WE	5cyl. 2144cc	85kW (116PS)	TD16427
Passat 1.9, Passat Variant 1.9 Santana 1.9	01/81→07/83 08/81→07/83	WN	5cyl. 1921cc	85kW (116PS)	TD5031
Passat 1.6, Passat Variant 1.6 Santana 1.6	08/80→03/88 08/81→12/84	WV	4cyl. 1588cc	55kW (75PS)	TD5032
Passat 1.6	09/79→07/80	WY	4cyl. 1588cc	55kW (75PS)	TD21343
Passat 1.6	09/79→07/80	WZ	4cyl. 1588cc	55kW (75PS)	TD4171











Passat 1.6		09/75→07/80	YG	4cyl. 1588cc	61kW (82PS)	TD19257	
Passat 1.6		09/75→07/80	YH	4cyl. 1588cc	60-61kW (81-83PS)	TD4175	
Passat 1.6		09/75→07/80	YK	4cyl. 1588cc	60-61kW (81-83PS)	TD4176	
Passat 1.6		08/80→03/88	YN	4cyl. 1588cc	55kW (75PS)	TD5034	
Passat Variant 1.6		02/76→03/88					
Passat 1.6, Passat Variant 1.6		08/75→02/83	YP	4cyl. 1588cc	63kW (86PS)	TD5035	
Santana 1.6		08/81→12/82					
Passat 1.6		08/80→07/81	YY	4cyl. 1588cc	51kW (69PS)	TD22655	
08-404100-00	STD	79.50	1.750		001 IF CR P	IKA	
08/1977→08/1984				2.000		026 P	STD
[R40200]				4.000		712 CR	ST
Golf I 1.6 GTI		08/76→07/82	EG	4cyl. 1588cc	81kW (110PS)	TD4999	
Golf I Cabriolet 1.6		08/79→07/82					
Jetta I 1.6 GLI		08/78→07/82					
Scirocco 1.6		06/76→07/82					
Passat 1.6 GLi		08/77→07/80	YS	4cyl. 1588cc	81kW (110PS)	TD9378	
Passat Variant 1.6 i		06/78→07/80					
08-405000-00	STD	79.50	1.750		001 IF MO P	IKA	
				2.000		026 P	STD
				4.000		712 CR	ST

28



Golf I 1.6		08/75→02/84	FN						29
Scirocco 1.6		08/75→07/79		4cyl.					
				1588cc	51kW (69PS)				TD4085
08-399200-00	STD	79.50	1.750		001 IF CR P				IKA
08/1975→07/1977			2.500		026 P				STD
[R46220]			5.000		236 P				STD
08-404100-00	STD	79.50	1.750		001 IF CR P				IKA
08/1977→05/1984			2.000		026 P				STD
[R40200]			4.000		712 CR				ST
Caddy II Box 75 1.6, Caddy II Estate 1.6		11/95→05/97	1F						30
Passat 1.6		02/88→09/91		4cyl.					
Passat Variant 1.6		04/88→09/91		1595cc	53-55kW (72-75PS)				TD4957
Polo Classic 75 1.6		11/95→09/97							
Golf III 1.8		11/91→08/97	AAM						
Golf III Cabriolet 1.8		07/93→05/98		4cyl.					
Golf III Variant 1.8		07/93→04/99		1781cc	55kW (75PS)				
Golf IV Cabriolet 1.8		06/98→06/02							
Passat 1.8		08/90→08/96							
Passat Variant 1.8		08/90→05/97							
Vento 1.8		11/91→09/98							TD4004
Golf II 1.6		08/83→07/92	ABN						
Jetta II 1.6		01/84→07/92		4cyl.					
Passat 1.6		02/88→12/88		1595cc	55kW (75PS)				TD4974
Golf III 1.8		11/91→08/97	ACC						
Golf IV 1.8		10/97→09/99		4cyl.					
				1781cc	66kW (89PS)				TD4011
Stationary engine			ADF						
				4cyl.					
				1781cc	55kW (75PS)				TD21353
Passat 1.6		08/80→03/88	DT						
Passat Saloon 1.6		01/85→03/88		4cyl.					
Passat Variant 1.6		08/80→03/88		1595cc	55kW (75PS)				TD4997
Santana 1.6		08/81→12/84							
Passat, Santana		01/83→12/87	DTA						
				4cyl.					
				1595cc	55kW (75PS)				FM7114
Caddy I 1.6		01/83→07/92	EW						
Golf I 1.6		01/83→02/84		4cyl.					
Golf I Cabriolet 1.6		08/83→04/92		1595cc	55kW (75PS)				
Jetta I 1.6		08/82→07/83							
Scirocco 1.6		01/83→12/89							TD4070
Golf II 1.6		08/83→07/92	EZ						
Jetta II 1.6		01/84→07/92		4cyl.					
Passat 1.6		02/88→09/91		1595cc	55kW (75PS)				TD4074
Passat Variant 1.6		04/88→09/91							





Golf 1.6i, Jetta 1.6i	08/85→07/87	EZA	4cyl. 1595cc	51kW (69PS)	TD4075
Golf II 1.6 Jetta II 1.6	08/83→07/92 01/84→07/92	HM	4cyl. 1595cc	55kW (75PS)	TD9523
Golf I 1.6 Golf I Cabriolet 1.6	01/83→02/84 08/83→04/92	HN	4cyl. 1595cc	55kW (75PS)	TD4107
Passat 2.0 Passat Saloon 2.0 Passat Variant 2.0 Santana 2.0	08/83→03/88 08/84→07/85 08/83→03/88 08/83→12/84	HP	5cyl. 1994cc	85kW (116PS)	TD16429
Passat Variant 2.2 Syncro	08/84→07/88	HY	5cyl. 2226cc	100kW (136PS)	TD21344
Passat 1.8 Passat Saloon 1.8 Passat Variant 1.8 Passat Variant 1.8 Syncro	01/83→03/88 01/85→03/88 01/83→03/88 01/86→03/88	JN	4cyl. 1781cc	66kW (89PS)	TD5014
Passat 2.0 Passat Saloon 2.0 Passat Variant 2.0 Passat Variant 2.0 Syncro Santana 2.0	08/83→03/88 08/84→07/85 08/83→03/88 05/84→03/88 08/83→12/84	JS	5cyl. 1994cc	85kW (116PS)	TD5015
Passat Variant 2.2 Syncro	08/85→03/88	JT	5cyl. 2226cc	88kW (120PS)	TD5016
Passat 1.6, Passat Saloon 1.6, Passat Variant 1.6, Santana 1.6		JU	4cyl. 1595cc	55kW (75PS)	TD12532
Passat 2.2		KM	5cyl. 2226cc	77kW (105PS)	TD4123
Passat 2.2, Passat Variant 2.2	01/85→03/88	KV	5cyl. 2226cc	100kW (136PS)	TD4125
Passat 2.2 Passat Saloon 2.2 Passat Variant 2.2	08/85→03/88 01/85→03/88 08/85→03/88	KX	5cyl. 2226cc	85kW (116PS)	TD5020
Golf II 1.6 Jetta II 1.6	10/86→12/92 10/86→10/91	PN	4cyl. 1595cc	51kW (69PS)	TD4141
Passat 1.6, Passat Saloon 1.6, Passat Variant 1.6	08/87→03/88	PP	4cyl. 1595cc	51kW (69PS)	TD5022





Golf II 1.8 GTI, Jetta II 1.8	08/85→10/87	RD	4cyl. 1781cc	79kW (107PS)	TD4143
Golf I Cabriolet 1.6 Scirocco 1.6	04/86→02/90 04/86→07/90	RE	4cyl. 1595cc	53kW (72PS)	TD4145
Golf II 1.6 Jetta II 1.6	02/86→10/91 03/86→10/91	RF	4cyl. 1595cc	53kW (72PS)	TD5025
Passat 1.6 Passat Saloon 1.6 Passat Variant 1.6	02/86→03/88 01/85→03/88 02/86→03/88	RL	4cyl. 1595cc	53kW (72PS)	TD4148
Gol 1.8 Passat 1.8, Passat Saloon 1.8, Passat Variant 1.8	05/84→09/94 05/86→03/88	RM	4cyl. 1781cc	64kW (87PS)	TD4149
Golf II 1.8 i CAT, Golf II 1.8 i Syncro CAT, Jetta II 1.8 CAT Jetta II 1.8 Syncro Passat 1.8 Passat Variant 1.8	08/87→10/91 08/87→12/88 02/88→08/96 02/88→05/97	RP	4cyl. 1781cc	66kW (89PS)	TD5027
08-109700-00 STD	81.00	1.500		001 IF CR P	IKA
08-109705-00 0.25mm		1.750		026 P	STD
08-109707-00 0.50mm		3.000		231 CR P	STD
[R48000]					
Golf II 1.8 Syncro, Jetta II 1.8 Syncro	08/88→07/91	1P	4cyl. 1781cc	72kW (98PS)	TD3995
Golf I Cabriolet 1.8	08/89→03/93	2H	4cyl. 1781cc	72kW (98PS)	TD4965
Golf III 1.8 Golf III 1.8 Syncro Golf III Cabriolet 1.8 Golf III Variant 1.8 Passat 1.8 Passat Variant 1.8 Polo Classic 90 1.8 Vento 1.8	11/91→08/97 01/93→08/97 07/93→05/98 07/93→04/99 02/88→08/96 02/88→05/97 01/97→09/01 11/91→09/98	ABS	4cyl. 1781cc	66kW (89PS)	TD4975
Polo Classic 90 1.8	01/97→09/01	ADD	4cyl. 1781cc	66kW (89PS)	TD15496

31





Golf III 1.8	11/91→08/97	ADZ			
Golf III 1.8 Syncro	01/93→08/97		4cyl.		
Golf III Cabriolet 1.8	07/93→05/98		1781cc	66kW (89PS)	
Golf III Variant 1.8	07/93→04/99				
Golf III Variant 1.8 Syncro	10/94→04/99				
Golf IV Cabriolet 1.8	06/98→06/02				
Passat 1.8	02/88→08/96				
Passat Variant 1.8	02/88→05/97				
Polo Classic 90 1.8	01/97→09/01				
Polo Variant 1.8	05/97→09/01				
Vento 1.8	11/91→09/98				TD4980
Golf III Variant 1.8	07/93→04/99	ANN			
Golf IV Cabriolet 1.8	06/98→06/02		4cyl.		
			1781cc	55kW (75PS)	
					TD10847
Golf III Variant 1.8	07/93→04/99	ANP			
Golf IV Cabriolet 1.8	06/98→06/02		4cyl.		
			1781cc	66kW (89PS)	
					TD10848
Passat 1.8	01/83→03/88	DS			
Passat Saloon 1.8	01/85→03/88		4cyl.		
Passat Variant 1.8	01/83→03/88		1781cc	66kW (89PS)	
Passat Variant 1.8 Syncro	01/86→03/88				
Santana 1.8	01/83→12/84				TD4996
Golf I 1.8 GTI	08/82→12/83	DX			
Golf I Cabriolet 1.8	08/82→12/92		4cyl.		
Golf II 1.8 GTI	08/83→10/91		1781cc	82kW (111PS)	
Jetta I 1.8	08/82→02/84				
Scirocco 1.8	08/82→12/89				TD4063
Passat 1.8, Passat Variant 1.8	12/83→03/88	DZ			
			4cyl.		
			1781cc	82kW (111PS)	
					TD4998
Golf I Cabriolet 1.8	08/82→12/89	EV			
Golf II 1.8 GTI	08/83→10/91		4cyl.		
Jetta II 1.8	01/84→10/91		1781cc	82kW (111PS)	
Scirocco 1.8	08/82→12/89				TD4069
Golf I Cabriolet 1.8	08/83→09/92	EX			
Scirocco 1.8	08/83→07/92		4cyl.		
			1781cc	66kW (89PS)	
					TD5000
Golf II 1.8	08/84→10/91	GU			
Golf II 1.8 Syncro	02/86→07/91		4cyl.		
Jetta II 1.8	08/84→10/91		1781cc	66kW (89PS)	
Jetta II 1.8 Syncro	08/87→12/88				TD5007
Golf II 1.8	08/84→10/91	GX			
Golf II 1.8 i CAT	08/87→10/91		4cyl.		
Golf II 1.8 Syncro	02/86→07/91		1781cc	66kW (89PS)	
Jetta II 1.8	08/84→10/91				
Jetta II 1.8 CAT	08/87→10/91				TD4100
Golf II 1.8 GTI	08/83→10/91	GZ			
Jetta II 1.8	01/84→10/91		4cyl.		
			1781cc	66kW (89PS)	
					TD4102
Golf II 1.8 GTI	01/85→07/85	HT			
			4cyl.		
			1781cc	74-77kW (100-104PS)	
					TD4109







Golf II 1.8, Jetta II 1.8	08/84→10/91	HV	4cyl. 1781cc	66kW (89PS)	TD4111
Caddy I 1.8	08/85→07/92	JH	4cyl. 1781cc	70kW (95PS)	TD4117
Golf I Cabriolet 1.8	08/83→04/93				
Scirocco 1.8	11/85→07/92				
Golf I 1.8 GTI	08/82→12/83	JJ	4cyl. 1781cc	82kW (111PS)	TD4118
Jetta I 1.8	08/82→02/84				
Scirocco 1.8	08/82→12/89				
Passat 1.8, Passat Variant 1.8	01/83→03/88	JV	4cyl. 1781cc	66kW (89PS)	TD5017
Corrado 1.8 16V	04/89→07/92	KR	4cyl. 1781cc	98kW (133PS)	TD5019
Golf II 1.8 GTI 16V	02/86→06/90				
Jetta II 1.8 16V	06/87→12/89				
Passat 1.8 16V	04/88→12/89				
Passat 1.8 GL, Passat Variant 1.8	08/91→09/93				
Passat Variant 1.8 16V	04/88→12/89				
Scirocco 1.8 16V	10/85→07/89				
Golf II 1.8 GTI		KT	4cyl. 1781cc	82kW (111PS)	TD4124
Golf I Cabriolet 1.8	08/82→12/89	PB	4cyl. 1781cc	82kW (111PS)	TD9367
Golf II 1.8 GTI	08/83→10/91				
Jetta II 1.8	01/84→10/91				
Passat 1.8, Passat Variant 1.8	04/88→07/92				
Scirocco 1.8	08/82→12/89				
Golf II 1.8 GTI CAT, Jetta II 1.8 CAT	01/87→10/91	PF	4cyl. 1781cc	79kW (107PS)	TD4139
Passat 1.8	04/88→07/93				
Passat Variant 1.8	04/88→07/90				
Corrado 1.8 G60	09/88→09/93	PG	4cyl. 1781cc	118kW (160PS) Supercharged	TD4140
Golf II 1.8 GTI G60	04/90→07/91				
Golf II 1.8 GTI G60 Syncro	08/88→07/91				
Passat 1.8 G60 Syncro	08/88→08/96				
Passat Variant 1.8 G60 Syncro	08/88→05/97				
Golf II 1.8 GTI 16V	02/86→10/91	PL	4cyl. 1781cc	95kW (129PS)	TD5021
Jetta II 1.8 16V	08/86→10/91				
Scirocco 1.8 16V	03/86→07/92				
Golf II 1.8 GTI		RG	4cyl. 1781cc	79kW (107PS)	TD4146
Golf II 1.8	08/86→01/90	RH	4cyl. 1781cc	62kW (84PS)	TD5026
Golf II 1.8 Syncro	08/87→07/88				
Jetta II 1.8	08/86→01/90				
Jetta II 1.8 Syncro	08/87→07/88				





Golf II 1.8 GTI		01/85→07/85	RV	4cyl. 1781cc	77kW (105PS)	TD4151
08-109400-10	STD	81.00	1.500		005 P PS	KV1
08-109407-10	0.50mm		1.750		026 P	STD
[R40850]			3.000		231 CR P	STD
Golf III 2.8 VR6		01/92→09/97	AAA	V6cyl. 2792cc	128kW (174PS)	32 TD3999
Passat 2.8 VR6		06/91→08/96				
Passat Variant 2.8 VR6		06/91→05/97				
Sharan 2.8 VR6		09/95→04/00				
Sharan 2.8 VR6 Syncro		11/96→04/00				
Vento 2.8 VR6		01/92→09/98				
Transporter IV Box 2.8 VR6		05/96→05/00	AES	V6cyl. 2792cc	103kW (140PS)	TD9346
Transporter IV Bus 2.8 VR 6		11/95→04/00				
Transporter IV Bus 2.8 VR6 Syncro		01/96→04/96				
Transporter IV Platform/Chassis 2.8		05/96→05/00				
Bora 2.3 V5		10/98→10/00	AGZ	V5cyl. 2324cc	110kW (150PS)	
Bora 2.3 V5 4motion		12/98→10/00				
Bora Estate 2.3 V5,		05/99→10/00				
Bora Estate 2.3 V5 4motion						
Golf IV 2.3 V5		08/97→10/00				
Golf IV 2.3 V5 4motion		12/98→10/00				
Golf IV Variant 2.3 V5,		05/99→06/06				
Golf IV Variant 2.3 V5 4motion						
Passat 2.3 VR5		10/96→11/00				
Passat 2.3 VR5 Syncro/4motion		10/97→11/00				
Passat Variant 2.3 VR5		06/97→11/00				
Passat Variant 2.3 VR5 Syncro/4motion		10/97→11/00				TD5559
Transporter IV Box 2.8 VR6		06/00→04/03	AMV	V6cyl. 2792cc	150kW (204PS)	TD15128
Transporter IV Bus 2.8 VR6		04/00→04/03				
Transporter IV Platform/Chassis 2.8 VR6		06/00→04/03				
Sharan 2.8 VR6		09/95→04/00	AMY	V6cyl. 2792cc	128kW (174PS)	TD17199
Sharan 2.8 VR6 Syncro		11/96→04/00				
Bora 2.3 V5, Bora 2.3 V5 4motion,		10/00→05/05	AQN	V5cyl. 2324cc	125kW (170PS)	
Bora Estate 2.3 V5,						
Bora Estate 2.3 V5 4motion						
Golf IV 2.3 V5, Golf IV 2.3 V5 4motion		10/00→06/05				
Golf IV Variant 2.3 V5,		10/00→06/06				
Golf IV Variant 2.3 V5 4motion						
New Beetle 2.3 V5		10/00→				TD15472
Bora 2.8 V6 4motion		03/99→05/05	AQP	V6cyl. 2792cc	150kW (204PS)	TD12849
Bora Estate 2.8 V6 4motion		05/99→05/05				
Golf IV 2.8 V6 4motion		03/99→06/05				
Golf IV Variant 2.8 V6 4motion		05/99→06/06				
Bora 2.8 V6 4motion		03/99→05/05	AUE	V6cyl. 2792cc	150kW (204PS)	TD15482
Bora Estate 2.8 V6 4motion		05/99→05/05				
Bora Estate 2.8 VR6		03/00→05/00				
Golf IV 2.8 V6 4motion		03/99→06/05				
Golf IV Variant 2.8 V6 4motion		05/99→06/06				





Sharan 2.8 V6 24V, Sharan 2.8 V6 24V 4motion		04/00→03/10	AYL	V6cyl. 2792cc	150kW (204PS)	TD14916
Passat 2.3 V5, Passat 2.3 V5 4motion, Passat Variant 2.3 VR5, Passat Variant 2.3 VR5 4motion		11/00→05/05	AZX	V5cyl. 2324cc	125kW (170PS)	TD15151
Bora 2.8 V6 4motion Bora Estate 2.8 V6 4motion Golf IV 2.8 V6 4motion Golf IV Variant 2.8 V6 4motion		03/99→05/05 05/99→05/05 03/99→06/05 05/99→06/06	BDE	V6cyl. 2792cc	150kW (204PS)	TD16390
08-501900-00	STD	81.00	1.500		001 P PS	KV1
08-501907-00	0.50mm		1.750		026 P	STD
[R60300]			3.000		231 CR P	STD
Transporter IV Box 2.0 Transporter IV Bus 2.0 Transporter IV Platform/Chassis 2.0 Vento 2.0 GL		07/90→04/03 09/90→04/03 07/90→04/03 11/91→07/98	AAC	4cyl. 1968cc	62kW (84PS)	33 TD4001
Transporter IV Box 2.5 Transporter IV Box 2.5 Syncro Transporter IV Bus 2.5 Transporter IV Bus 2.5 Syncro Transporter IV Platform/Chassis 2.5 Transporter IV Platform/ Chassis 2.5 Syncro		11/90→04/03 10/92→04/03 11/90→04/03 11/92→04/03 11/90→04/03 10/92→04/03	AAF	5cyl. 2459cc	81kW (110PS)	TD4002
Transporter IV Box 2.5 Transporter IV Box 2.5 Syncro Transporter IV Bus 2.5 Transporter IV Bus 2.5 Syncro Transporter IV Platform/Chassis 2.5 Transporter IV Platform/ Chassis 2.5 Syncro		11/90→04/03 10/92→04/03 11/90→04/03 11/92→04/03 11/90→04/03 10/92→04/03	ACU	5cyl. 2459cc	81kW (110PS)	TD4015
Transporter IV Box 2.5, Transporter IV Box 2.5 Syncro, Transporter IV Bus 2.5 Transporter IV Bus 2.5 Syncro Transporter IV Platform/Chassis 2.5, Transporter IV Platform/ Chassis 2.5 Syncro		08/96→04/03 07/96→04/03 08/96→04/03	AET	5cyl. 2461cc	81kW (110PS)	TD4983
Transporter IV Box 2.5 Transporter IV Box 2.5 Syncro Transporter IV Bus 2.5 Transporter IV Bus 2.5 Syncro Transporter IV Platform/Chassis 2.5 Transporter IV Platform/ Chassis 2.5 Syncro		11/90→04/03 10/92→04/03 11/90→04/03 11/92→04/03 11/90→04/03 10/92→04/03	AEU	5cyl. 2459cc	81kW (110PS)	TD9344
Transporter IV Box 2.5, Transporter IV Box 2.5 Syncro, Transporter IV Bus 2.5 Transporter IV Bus 2.5 Syncro Transporter IV Platform/Chassis 2.5, Transporter IV Platform/ Chassis 2.5 Syncro		08/96→04/03 07/96→04/03 08/96→04/03	APL	5cyl. 2461cc	85kW (116PS)	TD15288





Transporter IV Box 2.5, Transporter IV Box 2.5 Syncro, Transporter IV Bus 2.5	08/96→04/03	AVT	5cyl. 2461cc	85kW (116PS)	
Transporter IV Bus 2.5 Syncro	07/96→04/03				
Transporter IV Platform/Chassis 2.5, Transporter IV Platform/ Chassis 2.5 Syncro	08/96→04/03				TD15370

Transporter IV Bus 1.8, Transporter IV Platform/Chassis 1.8	12/90→07/92	PD	4cyl. 1781cc	49kW (67PS)	TD4138
--	-------------	-----------	------------------------	--------------------	---------------

08-502000-00	STD	81.00	1.750		001 IF CR P	IKA
			2.000		026 P	STD
			3.000		712 CR	ST

Transporter IV Box 2.5 TDI, Transporter IV Box 2.5 TDI Syncro, Transporter IV Bus 2.5 TDI	09/95→04/03	ACV	5cyl. 2461cc	74kW (100PS)	34
Transporter IV Bus 2.5 TDI Syncro	01/96→04/03	Diesel	Turbo Intercooled		
Transporter IV Platform/Chassis 2.5 TDI	09/95→04/03				
Transporter IV Platform/ Chassis 2.5 TDI Syncro	05/98→04/03				TD4978

LT 28-35 II Bus 2.5 SDI, LT 28-46 II Box 2.5 SDI, LT 28-46 II Platform/Chassis 2.5 SDI	07/96→07/06 09/96→07/06	AGX	5cyl. 2459cc	55kW (75PS)	TD9295
		Diesel			

LT 28-35 II Bus 2.5 TDI, LT 28-46 II Box 2.5 TDI, LT 28-46 II Platform/Chassis 2.5 TDI	05/96→08/99 06/96→08/99	AHD	5cyl. 2459cc	75kW (102PS)	TD9294
		Diesel	Turbo Intercooled		

Transporter IV Bus 2.5 TDI	05/98→04/03	AHY	5cyl. 2461cc	111kW (151PS)	TD10748
		Diesel	Turbo Intercooled		

Transporter IV Box 2.5 TDI, Transporter IV Bus 2.5 TDI, Transporter IV Platform/Chassis 2.5 TDI	12/98→04/03 05/98→04/03	AJT	5cyl. 2461cc	65kW (88PS)	TD10747
		Diesel	Turbo Intercooled		

LT 28-35 II Bus 2.5 TDI, LT 28-46 II Box 2.5 TDI, LT 28-46 II Platform/Chassis 2.5 TDI	05/99→07/06	ANJ	5cyl. 2461cc	80kW (109PS)	TD13446
		Diesel	Turbo Intercooled		

LT 28-35 II Bus 2.5 TDI, LT 28-46 II Box 2.5 TDI, LT 28-46 II Platform/Chassis 2.5 TDI	05/99→07/06	APA	5cyl. 2461cc	66kW (89PS)	TD13445
		Diesel	Turbo Intercooled		

Transporter IV Box 2.5 TDI, Transporter IV Bus 2.5 TDI, Transporter IV Platform/Chassis 2.5 TDI	09/95→04/03	AUF	5cyl. 2461cc	75kW (102PS)	TD16857
		Diesel	Turbo Intercooled		

LT 28-35 II Bus 2.5 TDI, LT 28-46 II Box 2.5 TDI, LT 28-46 II Platform/Chassis 2.5 TDI	05/99→07/06	AVR	5cyl. 2461cc	80kW (109PS)	TD15497
		Diesel	Turbo Intercooled		





Transporter IV Box 2.5 TDI Transporter IV Bus 2.5 TDI	09/00→04/03 05/98→04/03	AXG	5cyl. 2461cc 111kW (151PS)	Diesel Turbo Intercooled	TD17505
Transporter IV Box 2.5 TDI Syncro Transporter IV Bus 2.5 TDI Syncro Transporter IV Platform/ Chassis 2.5 TDI Syncro	09/95→04/03 01/96→04/03 05/98→04/03	AXL	5cyl. 2461cc 75kW (102PS)	Diesel Turbo Intercooled	TD18687
Transporter IV Box 2.5 TDI, Transporter IV Bus 2.5 TDI, Transporter IV Platform/Chassis 2.5 TDI	09/95→04/03	AYC	5cyl. 2461cc 75kW (102PS)	Diesel Turbo Intercooled	TD17504
Transporter IV Box 2.5 TDI Transporter IV Bus 2.5 TDI, Transporter IV Platform/Chassis 2.5 TDI	12/98→04/03 05/98→04/03	AYY	5cyl. 2461cc 65kW (88PS)	Diesel Turbo Intercooled	TD17503
LT 28-35 II Bus 2.5 TDI, LT 28-46 II Box 2.5 TDI, LT 28-46 II Platform/Chassis 2.5 TDI	05/01→07/06	BBE	5cyl. 2461cc 61kW (82PS)	Diesel Turbo Intercooled	TD16451
LT 28-35 II Bus 2.5 TDI, LT 28-46 II Box 2.5 TDI, LT 28-46 II Platform/Chassis 2.5 TDI	05/01→07/06	BBF	5cyl. 2461cc 70kW (95PS)	Diesel Turbo Intercooled	TD16452
LT 28-35 II Bus 2.5 TDI, LT 28-46 II Bus 2.5 TDI, LT 28-46 II Platform/Chassis 2.5 TDI	05/99→07/06	BBR	5cyl. 2461cc 80kW (109PS)	Diesel Turbo Intercooled	TD22627
08-501500-00 STD 81.00 08-501507-00 0.50mm [R60330]	2.500 2.000 3.000	 	001 P PS 005 IFU CR P 231 CR P	KV1 STD STD	
Passat 1.6 Passat Variant 1.6	10/96→11/00 06/97→11/00	ADP	4cyl. 1595cc 75kW (102PS)		35 TD16253
Bora 1.6 Bora Estate 1.6 Golf IV 1.6 Golf IV Variant 1.6 Polo Classic 100 1.6 Polo Variant 1.6	10/98→05/05 05/99→05/05 08/97→05/04 05/99→04/02 12/95→09/01 05/97→09/01	AEH	4cyl. 1595cc 74kW (100PS)		TD9450
Golf III 1.6 Golf III Cabriolet 1.6 Golf III Variant 1.6 Passat 1.6 Passat Variant 1.6 Vento 1.6	07/95→08/97 10/94→05/98 07/94→04/99 10/94→08/96 07/94→12/95 10/94→09/98	AEK	4cyl. 1595cc 74kW (100PS)		TD4982





Golf III 1.6	07/95→08/97	AFT				
Golf III Cabriolet 1.6	10/94→05/98		4cyl.			
Golf III Variant 1.6	07/94→04/99		1595cc	74kW (100PS)		
Golf IV Cabriolet 1.6	06/98→06/02					
Passat 1.6	10/94→08/96					
Passat Variant 1.6	07/94→12/95					
Polo Classic 100 1.6	12/95→09/01					
Polo Variant 1.6	05/97→09/01					
Vento 1.6	10/94→09/98					TD4988
Passat 1.6	10/96→11/00	AHL				
Passat Variant 1.6	06/97→11/00		4cyl.			
			1595cc	74kW (100PS)		
						TD5556
Bora 1.6	10/98→05/05	AKL				
Bora Estate 1.6	05/99→05/05		4cyl.			
Golf IV 1.6	08/97→05/04		1595cc	74kW (100PS)		
Golf IV Variant 1.6	05/99→04/02					
Polo Classic 100 1.6	12/95→09/01					
Polo Variant 1.6	05/97→09/01					TD9451
Golf III 1.6	07/95→08/97	AKS				
Golf III Cabriolet 1.6	10/94→05/98		4cyl.			
Golf III Variant 1.6	07/94→04/99		1588cc	74kW (100PS)		
Golf IV Cabriolet 1.6	06/98→06/02					TD9991
Bora 1.6	10/98→05/05	APF				
Bora Estate 1.6	05/99→05/05		4cyl.			
Golf IV 1.6	08/97→05/04		1595cc	74kW (100PS)		
Golf IV Variant 1.6	05/99→04/02					
Polo Classic 100 1.6	12/95→09/01					
Polo Variant 1.6	05/97→09/01					TD12848
Passat 1.6	10/96→11/00	ARM				
Passat Variant 1.6	06/97→11/00		4cyl.			
			1595cc	74kW (100PS)		
						TD16255
Polo Classic 100 1.6	12/95→09/01	AUR				
Polo Variant 1.6	05/97→09/01		4cyl.			
			1595cc	74kW (100PS)		
						TD15611
New Beetle 1.6	10/99→09/00	AWH				
			4cyl.			
			1595cc	74kW (100PS)		
						TD15465
08-105900-00	STD	81.00	1.200		001 NT	ST
08-105907-00	0.50mm		1.500		026 P	STD
[R60290]			2.000		712 CR	ST
Passat 1.8, Passat 1.8 Syncro/4motion	10/96→11/00	ADR				
Passat Variant 1.8,	06/97→11/00		4cyl.			
Passat Variant 1.8 Syncro/4motion			1781cc	92kW (125PS)		
						TD5557
Passat 1.8 T	10/96→11/00	AEB				
Passat 1.8 T Syncro	11/96→08/00		4cyl.			
Passat Variant 1.8 T	06/97→11/00		1781cc	110kW (150PS)		
			Turbo Intercooled			TD5558





Passat 1.8 Passat Variant 1.8	01/97→11/00 06/97→11/00	AFY	4cyl. 1781cc	85kW (116PS)	TD16244
Bora 1.8 Bora 1.8 4motion Bora Estate 1.8 4motion Golf IV 1.8 Golf IV 1.8 4motion Golf IV Variant 1.8 4motion	10/98→05/05 02/99→05/05 05/99→05/05 08/97→06/05 05/98→06/05 05/99→06/06	AGN	4cyl. 1781cc	92kW (125PS)	TD9363
Bora 1.8 T, Bora Estate 1.8 T Golf IV 1.8 T Golf IV Variant 1.8 T New Beetle 1.8 T	05/00→05/05 08/97→06/05 05/00→06/06 10/99→	AGU	4cyl. 1781cc	110kW (150PS) Turbo Intercooled	TD9456
Sharan 1.8 T 20V	09/97→03/10	AJH	4cyl. 1781cc	110kW (150PS) Turbo Intercooled	TD10887
Passat 1.8 T Passat Variant 1.8 T	10/96→11/00 06/97→11/00	ANB	4cyl. 1781cc	110kW (150PS) Turbo Intercooled	TD16256
New Beetle 1.8 T	10/99→	APH	4cyl. 1781cc	110kW (150PS) Turbo Intercooled	TD13441
Passat 1.8 Passat 1.8 Syncro/4motion Passat Variant 1.8, Passat Variant 1.8 Syncro/4motion	10/96→03/05 10/96→11/00 06/97→11/00	APT	4cyl. 1781cc	92kW (125PS)	TD11497
Passat 1.8 T Passat Variant 1.8 T	10/96→11/00 06/97→11/00	APU	4cyl. 1781cc	110kW (150PS) Turbo Intercooled	TD16257
Golf IV 1.8 T Golf IV Variant 1.8 T	08/97→06/05 05/00→06/06	AQA	4cyl. 1781cc	110kW (150PS) Turbo Intercooled	TD22620
Passat 1.8, Passat 1.8 Syncro/4motion Passat Variant 1.8, Passat Variant 1.8 Syncro/4motion	10/96→11/00 06/97→11/00	ARG	4cyl. 1781cc	92kW (125PS)	TD16237
Bora 1.8 T, Bora Estate 1.8 T	05/00→05/05	ARX	4cyl. 1781cc	110kW (150PS) Turbo Intercooled	TD15485
Golf IV 1.8 T Golf IV Variant 1.8 T	08/97→06/05 05/00→06/06	ARZ	4cyl. 1781cc	110kW (150PS) Turbo Intercooled	TD16385
Bora 1.8 T, Bora Estate 1.8 T Golf IV 1.8 T Golf IV Variant 1.8 T	05/00→05/05 08/97→06/05 05/00→06/06	AUM	4cyl. 1781cc	110kW (150PS) Turbo Intercooled	TD15486





Bora 1.8 T	03/02→05/05	AUQ	4cyl.			
Bora Estate 1.8 T	05/02→05/05			1781cc	132kW (180PS)	
Golf IV 1.8 T GTI	08/01→06/05				Turbo Intercooled	TD16420
New Beetle 1.8 T	10/99→	AVC	4cyl.			
				1781cc	110kW (150PS)	
					Turbo Intercooled	TD15467
Sharan 1.8 T 20V	09/97→03/10	AWC	4cyl.			
				1781cc	110kW (150PS)	
					Turbo Intercooled	TD14914
Golf IV 1.8 T	08/97→06/05	AWD	4cyl.			
Golf IV Variant 1.8 T	05/00→06/06			1781cc	110kW (150PS)	
					Turbo Intercooled	TD20628
Passat 1.8 T	02/01→05/05	AWM	4cyl.			
Passat 1.8 T 4motion,	03/01→05/05			1781cc	125kW (170PS)	
Passat Variant 1.8 4motion					Turbo Intercooled	TD16423
Passat Variant 1.8 T	05/02→08/05					
Passat 1.8 T 20V,	11/00→05/05	AWT	4cyl.			
Passat Variant 1.8 T 20V				1781cc	110kW (150PS)	
					Turbo Intercooled	TD15149

08-502900-00	STD	81.00	1.500		001 CK P	KV1
08-502905-00	0.25mm				026 P	GOE13
08-502907-00	0.50mm				231 CR P	KV1
[R60320]			2.000			

Phaeton 5.0 V10 TDI 4motion	11/02→	AJS	V10cyl.			37
				4921cc	230kW (313PS)	
		Diesel			Bi-Turbo Intercooled	TD16530
Multivan V 2.5 TDI	04/03→11/09	AXD	5cyl.			
Multivan V 2.5 TDI 4motion	07/04→11/09			2461cc	96kW (131PS)	
Transporter V Box 2.5 TDI	04/03→11/09				Turbo Intercooled	
Transporter V Box 2.5 TDI 4motion	07/04→11/09	Diesel				
Transporter V Bus 2.5 TDI	04/03→11/09					
Transporter V Bus 2.5 TDI 4motion	07/04→11/09					
Transporter V Platform/Chassis 2.5 TDI	04/03→11/09					
Transporter V Platform/	07/04→11/09					
Chassis 2.5 TDI 4motion						TD16868
Multivan V 2.5 TDI	04/03→11/09	AXE	5cyl.			
Multivan V 2.5 TDI 4motion	07/04→11/09			2461cc	128kW (174PS)	
Transporter V Box 2.5 TDI	04/03→11/09				Turbo Intercooled	
Transporter V Box 2.5 TDI 4motion	07/04→11/09	Diesel				
Transporter V Bus 2.5 TDI	04/03→11/09					
Transporter V Bus 2.5 TDI 4motion	07/04→11/09					
Transporter V Platform/Chassis 2.5 TDI	04/03→11/09					
Transporter V Platform/	04/04→11/09					
Chassis 2.5 TDI 4motion						TD16869
Touareg 5.0 V10 TDI	10/02→05/10	AYH	V10cyl.			
				4921cc	230kW (313PS)	
		Diesel			Bi-Turbo Intercooled	TD17043





Touareg 2.5 R5 TDI		01/03→05/10	BAC	5cyl. 2461cc	128kW (174PS)	
			Diesel	Turbo Intercooled		TD16855
Stationary engine			BCT (SDI 55-5)	5cyl. 2461cc	40kW (54PS)	
			Diesel			TD22630
Stationary engine			BCU (TDI 100-5)	5cyl. 2461cc	74kW (100PS)	
			Diesel	Turbo		TD22631
Stationary engine			BCV	5cyl. 2461cc	108kW (147PS)	
			Diesel	Turbo Intercooled		TD22632
Crafter 30-35 Bus 2.5 TDI, Crafter 30-50 Box 2.5 TDI, Crafter 30-50 Platform/Chassis 2.5 TDI		04/06→	BJL	5cyl. 2461cc	100kW (136PS)	
			Diesel	Turbo Intercooled		TD18893
Crafter 30-35 Bus 2.5 TDI, Crafter 30-50 Box 2.5 TDI, Crafter 30-50 Platform/Chassis 2.5 TDI		04/06→07/11	BJM	5cyl. 2461cc	120kW (163PS)	
			Diesel	Turbo Intercooled		TD18894
Multivan V 2.5 TDI, Transporter V Bus 2.5 TDI		11/03→11/09	BLJ	5cyl. 2461cc	120kW (163PS)	
			Diesel	Turbo Intercooled		TD20505
Touareg 2.5 R5 TDI		08/03→05/10	BLK	5cyl. 2461cc	120kW (163PS)	
			Diesel	Turbo Intercooled		TD20506
Touareg 5.0 R50 TDI		08/07→05/10	CBWA	V10cyl. 4921cc	230-257kW (313-350PS)	
			Diesel	Bi-Turbo Intercooled		TD21348
Crafter 30-35 Bus 2.5 TDI, Crafter 30-50 Box 2.5 TDI, Crafter 30-50 Platform/Chassis 2.5 TDI		04/06→	CECA	5cyl. 2461cc	100kW (136PS)	
			Diesel	Turbo Intercooled		TD24721
Crafter 30-35 Bus 2.5 TDI, Crafter 30-50 Box 2.5 TDI, Crafter 30-50 Platform/Chassis 2.5 TDI		04/06→07/11	CECB	5cyl. 2461cc	120kW (163PS)	
			Diesel	Turbo Intercooled		TD24722
08-421000-00	STD	81.00	2.500		001 IW CK P	KV1
08-421007-00	0.50mm		2.000		005 IFU P	F12/F14
			3.000		231 CR P	GOE13



Passat 1.6, Passat Variant 1.6	11/00→05/05	ALZ	4cyl. 1595cc	74kW (100PS)	38 TD15148
Passat 1.6 Passat Variant 1.6	10/96→11/00 06/97→11/00	ANA	4cyl. 1595cc	74kW (100PS)	TD16254
Bora 1.6, Bora Estate 1.6 Golf IV 1.6 Golf IV Variant 1.6	08/00→05/05 08/00→06/05 08/00→06/06	AVU	4cyl. 1595cc	75kW (102PS)	TD15475
New Beetle 1.6	06/00→	AYD	4cyl. 1595cc	75kW (102PS)	TD15466
Bora 1.6, Bora Estate 1.6 Golf IV 1.6 Golf IV Variant 1.6	08/00→05/05 08/00→06/05 08/00→06/06	BFQ	4cyl. 1595cc	75kW (102PS)	TD18137
New Beetle 1.6 New Beetle Convertible 1.6	06/00→ 01/03→09/10	BFS	4cyl. 1595cc	75kW (102PS)	TD16743
Caddy III Box 1.6, Caddy III Estate 1.6 Golf V 1.6 Jetta III 1.6 Touran 1.6	04/04→ 01/04→11/08 10/05→10/10 07/03→05/10	BGU	4cyl. 1595cc	75kW (102PS)	TD17067
Caddy III Box 1.6, Caddy III Estate 1.6 Golf Plus 1.6 Golf V 1.6 Golf V Variant 1.6 Golf VI 1.6 Golf VI Variant 1.6 Jetta III 1.6 Passat 1.6 Passat Variant 1.6 Touran 1.6	04/04→ 05/05→ 01/04→11/08 06/07→ 10/08→11/12 07/09→ 10/05→10/10 05/05→07/10 08/05→11/10 07/03→05/10	BSE	4cyl. 1595cc	75kW (102PS)	TD18222
Caddy III Box 1.6, Caddy III Estate 1.6 Golf Plus 1.6 Golf V 1.6 Golf V Variant 1.6 Golf VI 1.6 Golf VI Variant 1.6 Jetta III 1.6 Passat 1.6 Passat Variant 1.6 Touran 1.6	04/04→ 05/05→ 01/04→11/08 06/07→ 10/08→11/12 07/09→ 10/05→10/10 05/05→07/10 08/05→11/10 07/03→05/10	BSF	4cyl. 1595cc	75kW (102PS)	TD18223





Golf Plus 1.6	05/05→	CCSA			
Golf Plus 1.6 MultiFuel	11/07→		4cyl.		
Golf V 1.6 MultiFuel	10/07→11/08		1595cc	75kW (102PS)	
Golf V Variant 1.6	06/07→				
Golf V Variant 1.6 MultiFuel	11/07→				
Golf VI 1.6, Golf VI 1.6 MultiFuel	10/08→11/12				
Golf VI Variant 1.6	07/09→				
Jetta III 1.6	10/05→10/10				
Jetta III 1.6 MultiFuel	01/08→10/10				TD20780

08-148300-00	STD	81.00	1.000		001 NT	ST
			1.200		023 P	GOE13
			2.000		231 CR P	KV1

Golf Plus 2.0 TDI	05/05→	AZV				39
Golf V 2.0 TDI	10/03→11/08		4cyl.			
Golf V Variant 2.0 TDI,	06/07→		1968cc	100kW (136PS)		
Golf V Variant 2.0 TDI 4motion		Diesel	Turbo Intercooled			
Jetta III 2.0 TDI	09/05→10/10					
Touran 2.0 TDI	02/03→05/10					TD16862

Caddy III Box 2.0 SDI,	03/04→08/10	BDJ				
Caddy III Estate 2.0 SDI			4cyl.			
			1968cc	51kW (69PS)		
		Diesel	Turbo Intercooled			TD17358

Golf V 2.0 SDI	01/04→11/08	BDK				
			4cyl.			
			1968cc	55kW (75PS)		
		Diesel	Turbo Intercooled			TD17359

Golf Plus 2.0 TDI	05/05→05/07	BEE				
			4cyl.			
			1968cc	96kW (131PS)		
		Diesel	Turbo Intercooled			TD24836

Passat 2.0 TDI, Passat Variant 2.0 TDI	12/03→05/05	BGW				
			4cyl.			
			1968cc	100kW (136PS)		
		Diesel	Turbo Intercooled			TD18539

Golf Plus 2.0 TDI 16V	01/05→	BKD				
Golf V 2.0 TDI 16V	10/03→11/08		4cyl.			
Golf V 2.0 TDI 16V 4motion	08/04→11/08		1968cc	103kW (140PS)		
Golf V Variant 2.0 TDI 16V	06/07→	Diesel	Turbo Intercooled			
Jetta III 2.0 TDI 16V	08/05→10/10					
Touran 2.0 TDI 16V	08/03→05/10					TD17080

Passat 2.0 TDI 16V,	03/05→	BKP				
Passat 2.0 TDI 16V 4motion			4cyl.			
Passat Variant 2.0 TDI 16V,	08/05→		1968cc	103kW (140PS)		
Passat Variant 2.0 TDI 16V 4motion		Diesel	Turbo Intercooled			TD18135

Passat 2.0 TDI	03/05→11/10	BMA				
Passat Variant 2.0 TDI	08/05→11/10		4cyl.			
			1968cc	100kW (136PS)		
		Diesel	Turbo Intercooled			TD18225





Caddy III Box 2.0 TDI, Caddy III Estate 2.0 TDI	09/07→08/10	BMM	4cyl.			
Eos 2.0 TDI	06/06→05/08		1968cc	103kW (140PS)		
Golf Plus 2.0 TDI	12/05→05/09	Diesel	Turbo Intercooled			
Golf V 2.0 TDI	12/04→11/08					
Golf V 2.0 TDI 4motion	08/04→11/08					
Golf V Variant 2.0 TDI	06/07→					
Golf VI Variant 2.0 TDI	07/09→					
Jetta III 2.0 TDI	10/05→10/10					
Touran 2.0 TDI	12/05→05/10					TD18482
Golf V 2.0 TDI	11/05→11/08	BMN	4cyl.			
Jetta III 2.0 TDI	10/06→10/10		1968cc	125kW (170PS)		
Touran 2.0 TDI	12/05→05/10	Diesel	Turbo Intercooled			TD18471
Passat 2.0 TDI, Passat 2.0 TDI 4motion	03/05→	BMP	4cyl.			
Passat Variant 2.0 TDI, Passat Variant 2.0 TDI 4motion	08/05→		1968cc	103kW (140PS)		
		Diesel	Turbo Intercooled			TD18136
Passat 2.0 TDI, Passat Variant 2.0 TDI	08/05→	BMR	4cyl.			
			1968cc	125kW (170PS)		
		Diesel	Turbo Intercooled			TD18188
Sharan 2.0 TDI	11/05→03/10	BRT	4cyl.			
			1968cc	103kW (140PS)		
		Diesel	Turbo Intercooled			TD19105
Caddy III Box 2.0 SDI, Caddy III Estate 2.0 SDI	03/04→08/10	BST	4cyl.			
			1968cc	51kW (69PS)		
		Diesel				TD20501
Passat 2.0 TDI, Passat Variant 2.0 TDI	08/05→	BUZ	4cyl.			
			1968cc	120kW (163PS)		
		Diesel	Turbo Intercooled			TD20499
Stationary engine		BVD	4cyl.			
			1968cc	90kW (122PS)		
		Diesel	Turbo Intercooled			TD18542
Passat 2.0 TDI	08/05→07/06	BVE	4cyl.			
Passat Variant 2.0 TDI	08/05→02/06		1968cc	90kW (122PS)		
		Diesel	Turbo Intercooled			TD18543
Passat 2.0 TDI, Passat Variant 2.0 TDI	11/05→05/07	BWV	4cyl.			
			1968cc	88kW (120PS)		
		Diesel	Turbo Intercooled			TD20498

08-139500-00	STD	81.00	1.750		001 CK P	
08-139507-00	0.50mm		2.000		005 IFU P	F12/F14
			3.000		231 CR P	STD



Multivan V 2.5 TDI	04/03→11/09	BNZ			40
Multivan V 2.5 TDI 4motion	07/04→11/09		5cyl.		
Transporter V Box 2.5 TDI	04/03→11/09		2460cc	96kW (131PS)	
Transporter V Box 2.5 TDI 4motion	07/04→11/09	Diesel	Turbo Intercooled		
Transporter V Bus 2.5 TDI	04/03→11/09				
Transporter V Bus 2.5 TDI 4motion	07/04→11/09				
Transporter V Platform/Chassis 2.5 TDI	04/03→11/09				
Transporter V Platform/ Chassis 2.5 TDI 4motion	07/04→11/09				
Multivan V 2.0 TDI,	09/09→	CAAA Euro 5			TD23411
Transporter V Box 2.0 TDI,			4cyl.		
Transporter V Bus 2.0 TDI,			1968cc	62kW (84PS)	
Transporter V Platform/Chassis 2.0 TDI		Diesel	Turbo Intercooled		
Multivan V 2.0 TDI,	09/09→	CAAB Euro 5			TD23412
Transporter V Box 2.0 TDI,			4cyl.		
Transporter V Bus 2.0 TDI,			1968cc	75kW (102PS)	
Transporter V Platform/Chassis 2.0 TDI		Diesel	Turbo Intercooled		
Multivan V 2.0 TDI,	09/09→	CAAC Euro 5			TD23414
Multivan V 2.0 TDI 4motion,			4cyl.		
Transporter V Box 2.0 TDI,			1968cc	103kW (140PS)	
Transporter V Box 2.0 TDI 4motion,		Diesel	Turbo Intercooled		
Transporter V Bus 2.0 TDI,					
Transporter V Bus 2.0 TDI 4motion,					
Transporter V Platform/Chassis 2.0 TDI,					
Transporter V Platform/ Chassis 2.0 TDI 4motion					
Multivan V 2.0 TDI,	05/11→	CAAD			TD26334
Transporter V Box 2.0 TDI,			4cyl.		
Transporter V Bus 2.0 TDI,			1968cc	84kW (114PS)	
Transporter V Platform/Chassis 2.0 TDI		Diesel	Turbo Intercooled		
Multivan V 2.0 TDI,	05/10→	CAAE			TD24473
Multivan V 2.0 TDI 4motion,			4cyl.		
Transporter V Box 2.0 TDI,			1968cc	100kW (136PS)	
Transporter V Box 2.0 TDI 4motion,		Diesel	Turbo Intercooled		
Transporter V Bus 2.0 TDI,					
Transporter V Bus 2.0 TDI 4motion,					
Transporter V Platform/Chassis 2.0 TDI,					
Transporter V Platform/ Chassis 2.0 TDI 4motion					
Multivan V 2.0 TDI,	09/09→	CCHA			TD24471
Multivan V 2.0 TDI 4motion,			4cyl.		
Transporter V Box 2.0 TDI,			1968cc	103kW (140PS)	
Transporter V Box 2.0 TDI 4motion,		Diesel	Turbo Intercooled		
Transporter V Bus 2.0 TDI,					
Transporter V Bus 2.0 TDI 4motion					
Multivan V 2.0 TDI,	05/10→	CCHB			TD24474
Multivan V 2.0 TDI 4motion,			4cyl.		
Transporter V Box 2.0 TDI,			1968cc	100kW (136PS)	
Transporter V Box 2.0 TDI 4motion,		Diesel	Turbo Intercooled		
Transporter V Bus 2.0 TDI,					
Transporter V Bus 2.0 TDI 4motion,					
Transporter V Platform/ Chassis 2.0 TDI 4motion					
Amarok 2.0 TDI, Amarok 2.0 TDI 4motion	09/10→	CDBA			TD24402
			4cyl.		
			1968cc	90kW (122PS)	
		Diesel	Turbo Intercooled		





Amarok 2.0 BiTDI, Amarok 2.0 BiTDI 4motion	09/10→	CDCA	4cyl. 1968cc	120kW (163PS)	Diesel	Turbo Intercooled	TD24403
Multivan V 2.0 BiTDI, Multivan V 2.0 BiTDI 4motion, Transporter V Box 2.0 BiTDI, Transporter V Box 2.0 BiTDI 4motion, Transporter V Bus 2.0 BiTDI, Transporter V Bus 2.0 BiTDI 4motion, Transporter V Platform/ Chassis 2.0 BiTDI, Transporter V Platform/ Chassis 2.0 BiTDI 4motion	09/09→	CFCA Euro 5	4cyl. 1968cc	132kW (180PS)	Diesel	Bi-Turbo Intercooled	TD23421
Beetle 2.0 TDI Beetle Convertible 2.0 TDI Golf VI 2.0 TDI Golf VI Variant 2.0 TDI 16V Jetta III 2.0 TDI 16V Jetta IV 2.0 TDI	04/11→ 12/12→ 10/08→05/13 07/09→ 08/05→10/10 02/11→	CJAA	4cyl. 1968cc	103kW (140PS)	Diesel	Turbo Intercooled	TD23179
Crafter 30-35 Bus 2.0 TDI, Crafter 30-50 Box 2.0 TDI, Crafter 30-50 Platform/Chassis 2.0 TDI	05/11→	CKTB	4cyl. 1968cc	80kW (109PS)	Diesel	Turbo Intercooled	TD25415
Crafter 30-35 Bus 2.0 TDI, Crafter 30-50 Box 2.0 TDI, Crafter 30-50 Platform/Chassis 2.0 TDI	05/11→	CKTC	4cyl. 1968cc	100kW (136PS)	Diesel	Turbo Intercooled	TD25416
Crafter 30-35 Bus 2.0 TDI Crafter 30-35 Bus 2.0 TDI 4motion Crafter 30-50 Box 2.0 TDI Crafter 30-50 Box 2.0 TDI 4motion Crafter 30-50 Platform/Chassis 2.0 TDI Crafter 30-50 Platform/ Chassis 2.0 TDI 4motion	07/11→ 11/11→ 07/11→ 11/11→ 07/11→ 11/11→	CKUB	4cyl. 1968cc	120kW (163PS)	Diesel	Bi-Turbo Intercooled	TD25417
Crafter 30-35 Bus 2.0 TDI, Crafter 30-50 Box 2.0 TDI, Crafter 30-50 Platform/Chassis 2.0 TDI	10/11→	CKUC	4cyl. 1968cc	105kW (143PS)	Diesel	Turbo Intercooled	TD25418
Amarok 2.0 BiTDI, Amarok 2.0 BiTDI 4motion	11/11→	CNEA	4cyl. 1968cc	132kW (180PS)	Diesel	Bi-Turbo Intercooled	TD26330
Amarok 2.0 TDI, Amarok 2.0 TDI 4motion	09/10→	CNFA	4cyl. 1968cc	90kW (122PS)	Diesel	Turbo Intercooled	TD26995





Amarok 2.0 BiTDI, Amarok 2.0 BiTDI 4motion	11/11→	CSHA	4cyl. 1968cc 132kW (180PS)	
		Diesel	Bi-Turbo Intercooled	TD26331

08-432300-10 STD	81.00	1.750		001 GDC P	KV1
		2.000		005 IFU MO P	KV1
		3.000		231 LKZ CR P	GOE13

Only fit to pistons equivalent to OE 03L 107065 AG, 03L 1070 65 S

Nur gepasst worden zu den Kolben gleichwertig mit OE 03L 107 065 AG und 03L 107065 S

Seulement adapté aux pistons équivalents à OE 03L 107065 AG et 03L 107065 S

Cabido solamente a los pistones equivalentes a OE 03L 107065 AG y 03L 107065 S

08-432300-10 OE: 03L198151C

Golf VI 2.0 TDI	10/08→11/12	CBAA	4cyl.		41
Passat 2.0 TDI	03/05→11/10		1968cc 100kW (136PS)		
Passat CC 2.0 TDI	06/08→05/11	Diesel	Turbo Intercooled		
Passat Variant 2.0 TDI	08/05→11/10				
Tiguan 2.0 TDI 4motion	11/07→				TD20798

Eos 2.0 TDI 16V	05/08→	CBAB	4cyl.		
Golf VI 2.0 TDI	10/08→05/13		1968cc 103kW (140PS)		
Golf VI 2.0 TDI 4motion	05/09→11/12	Diesel	Turbo Intercooled		
Passat 2.0 TDI 16V, Passat 2.0 TDI 16V 4motion	03/05→				
Passat CC 2.0 TDI	06/08→				
Passat CC 2.0 TDI 4motion	08/09→				
Passat Variant 2.0 TDI 16V, Passat Variant 2.0 TDI 16V 4motion	08/05→				
Tiguan 2.0 TDI	03/08→				
Tiguan 2.0 TDI 4motion	09/07→				TD20799

Passat 2.0 BlueTDI	01/09→	CBAC	4cyl.		
Passat CC 2.0 BlueTDI	05/09→11/10		1968cc 105kW (143PS)		
Passat Variant 2.0 BlueTDI	01/09→	Diesel	Turbo Intercooled		TD20800

Passat CC 2.0 TDI	05/08→11/08	CBBA	4cyl.		
Tiguan 2.0 TDI 4motion	02/08→08/09		1968cc 120kW (163PS)		
		Diesel	Turbo Intercooled		TD21661

Golf VI 2.0 TDI	04/09→11/12	CBBB	4cyl.		
Passat 2.0 TDI	08/05→		1968cc 125kW (170PS)		
Passat 2.0 TDI 4motion	05/09→	Diesel	Turbo Intercooled		
Passat CC 2.0 TDI	06/08→				
Passat CC 2.0 TDI 4motion	11/09→				
Passat Variant 2.0 TDI	08/05→				
Passat Variant 2.0 TDI 4motion, Scirocco 2.0 TDI	05/09→				
Tiguan 2.0 TDI 4motion	09/07→				TD20949

Golf Plus 2.0 TDI	05/05→	CBDA	4cyl.		
Golf V 2.0 TDI	10/03→11/08		1968cc 100kW (136PS)		
Golf VI Variant 2.0 TDI	07/09→	Diesel	Turbo Intercooled		TD22715
Jetta III 2.0 TDI	09/05→10/10				

Golf Plus 2.0 TDI 16V	01/05→	CBDB	4cyl.		
Golf V Variant 2.0 TDI 16V	06/07→		1968cc 103kW (140PS)		
Golf VI Variant 2.0 TDI 16V	07/09→	Diesel	Turbo Intercooled		TD21070
Jetta III 2.0 TDI 16V	08/05→10/10				
Scirocco 2.0 TDI	08/08→				





Golf Plus 2.0 TDI	01/09→	CBDC			
Golf VI 2.0 TDI	10/08→11/12		4cyl.		
Passat 2.0 TDI	11/08→07/10		1968cc	81kW (110PS)	
Passat Variant 2.0 TDI	11/08→11/10	Diesel	Turbo Intercooled		TD21109
Jetta III 2.0 TDI	10/06→10/10	CEGA			
			4cyl.		
			1968cc	125kW (170PS)	
		Diesel	Turbo Intercooled		TD24125
CC 2.0 TDI	11/11→	CFFA			
Eos 2.0 TDI	11/10→		4cyl.		
Golf VI 2.0 TDI	10/08→11/12		1968cc	100kW (136PS)	
Passat 2.0 TDI	08/10→	Diesel	Turbo Intercooled		
Passat CC 2.0 TDI	06/08→05/11				
Passat Variant 2.0 TDI	08/10→				
Sharan 2.0 TDI	05/10→				
Sharan 2.0 TDI 4motion	05/11→05/12				
Tiguan 2.0 TDI 4motion	11/07→				TD23312
Beetle 2.0 TDI	04/11→	CFFB			
Beetle Convertible 2.0 TDI	12/12→		4cyl.		
CC 2.0 TDI, CC 2.0 TDI 4motion	11/11→		1968cc	103kW (140PS)	
Eos 2.0 TDI 16V	05/08→	Diesel	Turbo Intercooled		
Golf VI 2.0 TDI	10/08→05/13				
Golf VI 2.0 TDI 4motion	05/09→11/12				
Jetta IV 2.0 TDI	02/11→				
Passat 2.0 TDI, Passat 2.0 TDI 4motion	08/10→				
Passat AllTrack 2.0 TDI,	01/12→				
Passat AllTrack 2.0 TDI 4motion					
Passat CC 2.0 TDI	06/08→				
Passat CC 2.0 TDI 4motion	08/09→				
Passat Variant 2.0 TDI,	08/10→				
Passat Variant 2.0 TDI 4motion					
Sharan 2.0 TDI	05/10→				
Sharan 2.0 TDI 4motion	05/11→				
Tiguan 2.0 TDI	03/08→				
Tiguan 2.0 TDI 4motion	09/07→				TD23178
Tiguan 2.0 TDI	05/10→	CFFD			
			4cyl.		
			1968cc	81kW (110PS)	
		Diesel	Turbo Intercooled		TD24215
Sharan 2.0 TDI	05/11→	CFFE			
			4cyl.		
			1968cc	85kW (116PS)	
		Diesel	Turbo Intercooled		TD25739
CC 2.0 TDI, CC 2.0 TDI 4motion	11/11→	CFGB			
Golf VI 2.0 TDI	04/09→11/12		4cyl.		
Passat 2.0 TDI, Passat 2.0 TDI 4motion	08/10→		1968cc	125kW (170PS)	
Passat AllTrack 2.0 TDI 4motion	01/12→	Diesel	Turbo Intercooled		
Passat CC 2.0 TDI	06/08→				
Passat CC 2.0 TDI 4motion	11/09→				
Passat Variant 2.0 TDI,	08/10→				
Passat Variant 2.0 TDI 4motion					
Scirocco 2.0 TDI	05/09→				
Sharan 2.0 TDI	08/10→				
Tiguan 2.0 TDI 4motion	09/07→				TD23180





CC 2.0 TDI, CC 2.0 TDI 4motion, Passat 2.0 TDI	12/12→	CFGC	4cyl.		
Passat 2.0 TDI 4motion, Passat AllTrack 2.0 TDI 4motion	01/13→	Diesel	1968cc	130kW (177PS)	
Passat Variant 2.0 TDI	12/12→		Turbo Intercooled		
Passat Variant 2.0 TDI 4motion, Scirocco 2.0 TDI, Sharan 2.0 TDI	01/13→				
Tiguan 2.0 TDI 4motion	11/12→				TD26990
Golf Plus 2.0 TDI	05/05→	CFHB	4cyl.		
Golf VI Variant 2.0 TDI	07/09→		1968cc	100kW (136PS)	
Scirocco 2.0 TDI	11/10→	Diesel	Turbo Intercooled		TD24314
Caddy III Box 2.0 TDI 16V, Caddy III Box 2.0 TDI 16V 4motion, Caddy III Estate 2.0 TDI 16V, Caddy III Estate 2.0 TDI 16V 4motion	11/10→	CFHC	4cyl.		
Golf Plus 2.0 TDI 16V	01/05→		1968cc	103kW (140PS)	
Golf VI Convertible 2.0 TDI	11/11→		Turbo Intercooled		
Golf VI Variant 2.0 TDI 16V	07/09→	Diesel			
Jetta IV 2.0 TDI	02/11→				
Scirocco 2.0 TDI	08/08→				
Touran 2.0 TDI	05/10→				TD24315
Caddy III Box 2.0 TDI	11/10→	CFHE	4cyl.		
Caddy III Box 2.0 TDI 4motion	12/10→		1968cc	62kW (84PS)	
		Diesel	Turbo Intercooled		TD25438
Caddy III Box 2.0 TDI 4motion, Caddy III Estate 2.0 TDI 4motion	08/10→	CFHF	4cyl.		
			1968cc	81kW (110PS)	
		Diesel	Turbo Intercooled		TD24366
Caddy III Box 2.0 TDI, Caddy III Estate 2.0 TDI	05/12→	CFJA	4cyl.		
Touran 2.0 TDI	12/05→		1968cc	125kW (170PS)	
		Diesel	Turbo Intercooled		TD24994
Touran 2.0 TDI	01/13→	CFJB	4cyl.		
			1968cc	96kW (131PS)	
		Diesel	Turbo Direct Injection		TD27973
Caddy III Box 2.0 TDI, Caddy III Estate 2.0 TDI	08/10→	CLCA	4cyl.		
Golf Plus 2.0 TDI	01/09→		1968cc	81kW (110PS)	
Golf VI 2.0 TDI	10/08→11/12	Diesel	Turbo Intercooled		
Golf VI Variant 2.0 TDI	01/10→				
Jetta IV 2.0 TDI	10/10→				
Touran 2.0 TDI	11/10→				TD24835
Caddy III Box 2.0 TDI 16V, Caddy III Estate 2.0 TDI 16V	11/10→	CLCB	4cyl.		
Golf VI Variant 2.0 TDI 16V	07/09→		1968cc	103kW (140PS)	
Jetta IV 2.0 TDI	02/11→	Diesel	Turbo Intercooled		TD24600
Tiguan 2.0 TDI 4motion	09/07→	CLJA	4cyl.		
			1968cc	103kW (140PS)	
		Diesel	Turbo Intercooled		TD24963





CC 2.0 TDI	11/11→	CLLA		
Passat 2.0 TDI, Passat 2.0 TDI 4motion	08/10→		4cyl.	
Passat CC 2.0 TDI	06/08→		1968cc	125kW (170PS)
Passat Variant 2.0 TDI,	08/10→	Diesel	Turbo Intercooled	
Passat Variant 2.0 TDI 4motion				TD24441

08-432300-00	STD	81.00	1.750		001 GDC P	KV4
08-432307-00	0.50mm		2.000		005 IFU P	F12/F14
			3.000		231 LKZ CR P	GOE13

08-432300-00 OE: 03L198151A

Corrado 2.9 VR6	08/91→12/95	ABV		
Golf III 2.9 VR6 Syncro	10/94→08/97		V6cyl.	
Golf III Variant 2.9 VR6,	10/94→04/99		2861cc	140kW (190PS)
Golf III Variant 2.9 VR6 Syncro				
Passat Variant 2.9 VR6 Syncro	01/94→05/97			TD4977

42

08-502300-00	STD	82.00	1.500		001 P PS	KV1
			1.750		026 P	STD
			3.000		231 CR P	STD

Corrado 2.0 i	04/93→12/95	2E		
Golf III 2.0	11/91→08/97		4cyl.	
Golf III Cabriolet 2.0	07/93→05/98		1984cc	85kW (116PS)
Golf III Variant 2.0	07/93→04/99			
Passat 2.0	02/90→08/96			
Passat 2.0 Syncro	10/90→08/96			
Passat Variant 2.0	02/90→05/97			
Passat Variant 2.0 Syncro	10/90→05/97			
Vento 2.0	11/91→09/98			TD4963

43

Corrado 2.0 i 16V	08/91→12/95	9A		
Passat 2.0 16V, Passat Variant 2.0 16V	08/88→09/93		4cyl.	
			1984cc	100kW (136PS)
				TD3998

Golf III 2.0 GTI 16V	08/92→08/97	ABF		
Passat 2.0 16V	01/94→08/96		4cyl.	
Passat Variant 2.0 16V	01/94→05/97		1984cc	110kW (150PS)
Sharan 2.0 16V	09/95→02/00			TD4007

Passat 2.8 V6	08/96→11/00	ACK		
Passat 2.8 V6 Syncro/4motion	10/96→11/00		V6cyl.	
Passat Variant 2.8 V6,	06/97→11/00		2771cc	142kW (193PS)
Passat Variant 2.8 V6 Syncro/4motion				TD5560

Passat 2.0i	08/91→12/94	ACX		
			4cyl.	
			1984cc	78kW (106PS)
				TD21354





Corrado 2.0 i	04/93→12/95	ADY		
Golf III 2.0	11/91→08/97		4cyl.	
Golf III Cabriolet 2.0	07/93→05/98		1984cc	85kW (116PS)
Golf III Variant 2.0	07/93→04/99			
Passat 2.0	02/90→08/96			
Passat 2.0 Syncro	10/90→08/96			
Passat Variant 2.0	02/90→05/97			
Passat Variant 2.0 Syncro	10/90→05/97			
Sharan 2.0	09/95→03/10			
Vento 2.0	11/91→09/98			TD4979
New Beetle 2.0	01/98→	AEG		
			4cyl.	
			1984cc	85kW (116PS)
				TD13442
Golf III 2.0 GL	08/95→09/97	AEP		
Golf III Variant 2.0	08/95→04/96		4cyl.	
Passat 2.0, Passat Variant 2.0	03/95→08/96		1984cc	79kW (107PS)
Vento 2.0 GL	05/96→12/97			TD11448
Passat 2.8 Syncro, Passat 2.8 V6,	05/97→09/99	AGE		
Passat Variant 2.8 Syncro			V6cyl.	
Passat Variant 2.8 V6	09/97→09/99		2771cc	132kW (180PS)
				TD16251
Golf III 2.0	11/91→08/97	AGG		
Golf III 2.0 Syncro	08/95→08/97		4cyl.	
Golf III Cabriolet 2.0	07/93→05/98		1984cc	85kW (116PS)
Golf III Variant 2.0	07/93→04/99			
Golf III Variant 2.0 Syncro	08/95→04/99			
Golf IV Cabriolet 2.0	06/98→06/02			
Passat 2.0	02/90→08/96			
Passat 2.0 Syncro	10/90→08/96			
Passat Variant 2.0	02/90→05/97			
Passat Variant 2.0 Syncro	10/90→05/97			
Vento 2.0	11/91→09/98			TD4989
Golf III 2.0	11/91→08/97	AKR		
Golf III Cabriolet 2.0	07/93→05/98		4cyl.	
Golf III Variant 2.0	07/93→04/99		1984cc	85kW (116PS)
Golf IV Cabriolet 2.0	06/98→06/02			
Vento 2.0	11/91→09/98			TD11354
Passat 2.8 V6 Syncro/4motion	10/96→11/00	ALG		
Passat Variant 2.8 V6 Syncro/4motion	06/97→11/00		V6cyl.	
			2771cc	142kW (193PS)
				TD16260
Passat 2.8 4motion,	11/00→05/05	AMX		
Passat Variant 2.8 4motion			V6cyl.	
			2771cc	142kW (193PS)
				TD15155
Bora 2.0	10/98→05/05	APK		
Bora Estate 2.0	05/99→05/05		4cyl.	
Golf IV 2.0	07/98→05/04		1984cc	85kW (116PS)
Golf IV Variant 2.0	05/99→06/06			
New Beetle 2.0	01/98→			TD11927
Passat 2.8 V6	08/96→11/00	APR		
Passat 2.8 V6 Syncro/4motion	10/96→11/00		V6cyl.	
Passat Variant 2.8 V6,	06/97→11/00		2771cc	142kW (193PS)
Passat Variant 2.8 V6 Syncro/4motion				TD15808







Passat 2.8 V6	08/96→11/00	AQD			
Passat 2.8 V6 Syncro/4motion	10/96→11/00		V6cyl.		
Passat Variant 2.8 V6,	06/97→11/00		2771cc	142kW (193PS)	
Passat Variant 2.8 V6 Syncro/4motion					TD16259
Bora 2.0	10/98→05/05	AQY			
Bora Estate 2.0	05/99→05/05		4cyl.		
Golf IV 2.0	07/98→05/04		1984cc	85kW (116PS)	
Golf IV Variant 2.0	05/99→06/06				
New Beetle 2.0	01/98→				TD10607
Sharan 2.0	09/95→03/10	ATM			
Sharan 2.0 LPG	04/06→03/10		4cyl.		
			1984cc	85kW (116PS)	TD14913
Passat 2.8 4motion,	11/00→05/05	ATQ			
Passat Variant 2.8 4motion			V6cyl.		
			2771cc	142kW (193PS)	TD16422
Passat 2.8 V6, Passat Variant 2.8 V6	09/99→11/00	ATX			
			V6cyl.		
			2771cc	140kW (190PS)	TD16252
Multivan V 2.0, Transporter V Box 2.0,	11/03→	AXA			
Transporter V Bus 2.0,			4cyl.		
Transporter V Platform/Chassis 2.0			1984cc	85kW (116PS)	TD16866
Bora 2.0	10/98→05/05	AZH			
Bora 2.0 4motion	04/00→05/05		4cyl.		
Bora Estate 2.0	05/99→05/05		1984cc	85kW (116PS)	
Bora Estate 2.0 4motion	04/00→05/05				
Golf IV 2.0 4motion	10/00→06/05				
Golf IV Variant 2.0 4motion	10/00→06/06				TD15479
Bora 2.0	10/98→05/05	AZJ			
Bora 2.0 4motion	04/00→05/05		4cyl.		
Bora Estate 2.0	05/99→05/05		1984cc	85kW (116PS)	
Bora Estate 2.0 4motion	04/00→05/05				
Golf IV 2.0	07/98→05/04				
Golf IV 2.0 4motion	10/00→06/05				
Golf IV Variant 2.0	05/99→06/06				
Golf IV Variant 2.0 4motion	10/00→06/06				
New Beetle 2.0	01/98→				
New Beetle Convertible 2.0	09/02→10/10				TD16419
Passat 2.0, Passat 2.0 4motion,	11/00→05/05	AZM			
Passat Variant 2.0,			4cyl.		
Passat Variant 2.0 4motion			1984cc	85kW (116PS)	TD15150
Passat 2.8 V6, Passat Variant 2.8 V6	09/99→11/00	BBG			
			V6cyl.		
			2771cc	140kW (190PS)	TD17913
Polo 2.0i, Polo Sedan 2.0i	04/02→11/09	BBX			
			4cyl.		
			1984cc	85kW (116PS)	TD21077
Stationary engine		BEF			
			4cyl.		
			1984cc	43kW (58PS)	TD25872





Golf IV Variant 2.0 Bi-Fuel		02/02→06/06	BEH	4cyl. 1984cc	85kW (116PS)	TD16527
New Beetle 2.0		01/98→	BEJ	4cyl. 1984cc	85kW (116PS)	TD21073
New Beetle 2.0		01/98→	BER	4cyl. 1984cc	85kW (116PS)	TD18049
New Beetle 2.0		01/98→	BHP	4cyl. 1984cc	85kW (116PS)	TD21074
Jetta IV 2.0 New Beetle 2.0		06/10→ 01/98→	CBPA	4cyl. 1984cc	85kW (116PS)	TD21075
08-501800-00	STD	82.50	1.200		005 PS	KV1
08-501807-00	0.50mm		1.500		005 IW P	STD
[R60310]			2.000		231 CR P	KV1
Passat 2.0, Passat Variant 2.0		11/01→05/05	ALT	4cyl. 1984cc	96kW (131PS)	44 TD17040
Golf V 2.0 FSI Touran 2.0 FSI		01/04→11/08 10/03→11/05	AXW	4cyl. 1984cc	110kW (150PS) Turbo Intercooled	TD17081
Golf V 2.0 GTI Jetta III 2.0 TFSI Passat 2.0 FSI Passat Variant 2.0 FSI		10/04→02/09 10/05→10/10 07/05→07/10 08/05→11/10	AXX	4cyl. 1984cc	147kW (200PS) Turbo Intercooled	TD18540
Golf Plus 2.0 FSI Golf V 2.0 FSI Jetta III 2.0 FSI Passat 2.0 FSI Passat Variant 2.0 FSI Touran 2.0 FSI		05/05→06/08 01/04→11/08 08/05→10/10 03/05→07/10 08/05→11/10 10/03→11/05	BLR	4cyl. 1984cc	110kW (150PS)	TD18134
Golf V 2.0 FSI Golf V 2.0 FSI 4motion Jetta III 2.0 FSI Passat 2.0 FSI 4motion Passat Variant 2.0 FSI 4motion Touran 2.0 FSI		01/04→11/08 08/04→11/08 08/05→10/10 09/05→07/10 09/05→11/10 10/03→11/05	BLX	4cyl. 1984cc	110kW (150PS)	TD17985





Golf Plus 2.0 FSI	05/05→06/08	BLY			
Golf V 2.0 FSI	01/04→11/08		4cyl.		
Jetta III 2.0 FSI	08/05→10/10		1984cc	110kW (150PS)	
Passat 2.0 FSI	03/05→07/10				
Passat 2.0 FSI 4motion	09/05→07/10				
Passat Variant 2.0 FSI	08/05→11/10				
Passat Variant 2.0 FSI 4motion	09/05→11/10				
Touran 2.0 FSI	10/03→11/05				TD17986
New Beetle 2.5	07/05→	BPR			
New Beetle Convertible 2.5	07/05→09/10		5cyl.		
			2480cc	110kW (150PS)	
					TD19260
New Beetle 2.5	07/05→	BPS			
New Beetle Convertible 2.5	07/05→09/10		5cyl.		
			2480cc	110kW (150PS)	
					TD19261
Eos 2.0 TFSI	03/06→	BPY			
Golf V 2.0 GTI	10/04→02/09		4cyl.		
Jetta III 2.0 TFSI	10/05→10/10		1984cc	147kW (200PS)	
Passat 2.0 FSI	07/05→07/10		Turbo Intercooled		
Passat Variant 2.0 FSI	08/05→11/10				TD18883
Golf V 2.0 FSI	01/04→11/08	BVX			
Golf V 2.0 FSI 4motion	08/04→11/08		4cyl.		
Passat 2.0 FSI 4motion	09/05→07/10		1984cc	110kW (150PS)	
Passat Variant 2.0 FSI 4motion	09/05→11/10				TD18912
Eos 2.0 FSI	03/06→05/08	BVY			
Golf Plus 2.0 FSI	05/05→06/08		4cyl.		
Golf V 2.0 FSI	01/04→11/08		1984cc	110kW (150PS)	
Jetta III 2.0 FSI	08/05→10/10				
Passat 2.0 FSI	03/05→07/10				
Passat Variant 2.0 FSI	08/05→11/10				
Touran 2.0 FSI	10/03→11/05				TD18468
Eos 2.0 FSI	03/06→05/08	BVZ			
Golf Plus 2.0 FSI	05/05→06/08		4cyl.		
Golf V 2.0 FSI	01/04→11/08		1984cc	110kW (150PS)	
Jetta III 2.0 FSI	08/05→10/10				
Passat 2.0 FSI	03/05→07/10				
Passat Variant 2.0 FSI	08/05→11/10				
Touran 2.0 FSI	10/03→11/05				TD18469
Eos 2.0 TFSI	03/06→	BWA			
Golf V 2.0 GTI	10/04→02/09		4cyl.		
Golf V Variant 2.0	06/07→		1984cc	147kW (200PS)	
Jetta III 2.0 TFSI	10/05→10/10		Turbo Intercooled		
Passat 2.0 FSI	07/05→07/10				
Passat Variant 2.0 FSI	08/05→11/10				TD18541

08-435100-10	STD	82.50	1.200		001 NT PVD	ST
			1.500		026	GOE13
			2.000		231 CR	KV1



Touareg 3.0 V6 TDI		11/04→05/10	BKS	V6cyl. 2967cc 165kW (224PS)		45
			Diesel	Turbo Intercooled		TD18031
Phaeton 3.0 V6 TDI 4motion		09/04→	BMK	V6cyl. 2967cc 165kW (224PS)		
			Diesel	Turbo Intercooled		TD18023
Touareg 3.0 TDI		04/06→05/10	BUN	V6cyl. 2967cc 155kW (211PS)		
			Diesel	Turbo Intercooled		TD21182
08-434300-00	STD	83.00	2.000		001 CK	KV1
08-434307-00	0.50mm		2.000		001 IFU	KV1
			3.000		231 CR	GOE13
Phaeton 3.0 V6 TDI 4motion		11/08→	CARB	V6cyl. 2967cc 176kW (239PS)		46
			Diesel	Turbo Intercooled		TD22605
Touareg 3.0 V6 TDI		11/07→	CASA	V6cyl. 2967cc 176kW (239PS)		
			Diesel	Turbo Intercooled		TD20865
Touareg 3.0 V6 TDI		11/07→05/10	CASC	V6cyl. 2967cc 176kW (239PS)		
			Diesel	Turbo Intercooled		TD22560
Touareg 3.0 V6 TDI		01/10→	CASD	V6cyl. 2967cc 150kW (204PS)		
			Diesel	Turbo Intercooled		TD24893
Phaeton 3.0 V6 TDI 4motion		11/08→	CEXA	V6cyl. 2967cc 176kW (239PS)		
			Diesel	Turbo Intercooled		TD22389
Touareg 3.0 V6 TDI		01/10→	CJMA	V6cyl. 2967cc 150kW (204PS)		
			Diesel	Turbo Intercooled		TD24892
08-433100-00	STD	83.00	1.750		001 GDC	ST
08-433105-00	0.25mm		2.000		005 IF MO P	KV1
08-433107-00	0.50mm		3.000		231 CR P	GOE13



Touareg 3.0 TDI	04/06→05/10	CASB	V6cyl. 2967cc 155kW (211PS)	47
		Diesel	Turbo Intercooled	TD22636

Touareg 3.0 V6 TDI	11/04→	CATA	V6cyl. 2967cc 165kW (224PS)	
		Diesel	Turbo Intercooled	TD22637

08-433100-00	STD	83.00	1.750		001 GDC	ST
08-433105-00	0.25mm		2.000		005 IF MO P	KV1
08-433107-00	0.50mm		3.000		231 CR P	GOE13
				GDC		
08-434300-00	STD	83.00	2.000		001 CK	KV1
08-434307-00	0.50mm		2.000		001 IFU	KV1
			3.000		231 CR	GOE13

181 1.5	09/69→07/70	H	B4cyl. 1493cc 32kW (44PS)	48
Kafer 1500 1.5	08/66→11/73			
Kafer Convertible 1500 1.5	01/66→12/70			
Karmann Ghia Convertible 1500,	01/66→12/69			
Karmann Ghia Coupe 1500				TD4103

1500, 1600 1.5	04/61→07/73	K	B4cyl. 1493cc 33kW (45PS)	
1500, 1600 Hatchback 1.5 L	07/68→07/73			
1500, 1600 Variant 1.5	04/61→07/73			TD4122

08-394800-00	STD	83.00	2.000		005 IF P	IKA
			2.000		026 P	STD
			4.000		712 CR	ST

New Beetle RSI 3.2 4motion	04/00→05/01	AXJ	V6cyl. 3189cc 165kW (224PS)	49
				TD15471

Phaeton 3.2 V6	04/02→	AYT	V6cyl. 3189cc 177kW (240PS)	
				TD16481

Touareg 3.2 V6	10/02→11/06	AZZ	V6cyl. 3189cc 162kW (220PS)	
				TD17041

Touareg 3.2 V6	10/02→11/06	BAA	V6cyl. 3189cc 162kW (220PS)	
				TD20531

Multivan V 3.2 V6	02/04→06/04	BDL	V6cyl. 3189cc 170kW (231PS)	
Transporter V Box 3.2 V6	04/03→06/04			
Transporter V Bus 3.2 V6	02/04→06/04			
Transporter V Platform/Chassis 3.2 V6	02/04→11/09			TD16870





Golf IV 3.2 R32 4motion	09/02→06/05	BFH	V6cyl. 3189cc	177kW (240PS)	TD16526
Touareg 3.2 V6	10/02→11/06	BKJ	V6cyl. 3189cc	162kW (220PS)	TD17042
Multivan V 3.2 V6	02/04→11/09	BKK	V6cyl. 3189cc	173kW (235PS)	TD17186
Multivan V 3.2 V6 4motion	07/04→11/09				
Transporter V Box 3.2 4motion	11/03→11/09				
Transporter V Box 3.2 V6,	02/04→11/09				
Transporter V Bus 3.2 V6					
Transporter V Bus 3.2 V6 4motion	11/03→11/09				
Transporter V Platform/Chassis 3.2 V6	08/03→05/06				
Phaeton 3.2 V6	04/02→	BKL	V6cyl. 3189cc	177kW (240PS)	TD18024
Phaeton 3.2 V6 4motion	02/04→				
Golf IV 3.2 R32 4motion	09/02→06/05	BML	V6cyl. 3189cc	177kW (240PS)	TD20523
Touareg 3.2 V6	10/02→11/06	BMV	V6cyl. 3189cc	162kW (220PS)	TD20525
Touareg 3.2 V6	10/02→11/06	BMX	V6cyl. 3189cc	177kW (240PS)	TD19256
Golf IV 3.2 R32 4motion		BPF	V6cyl. 3189cc	184kW (250PS)	TD20524
Phaeton 3.2 V6 4motion	02/04→	BRK	V6cyl. 3189cc	177kW (240PS)	TD18025
Eos 3.2 V6	06/06→05/09	BUB	V6cyl. 3189cc	184kW (250PS)	TD18472
Golf V 3.2	09/05→11/08				
Golf V 3.2 R32 4motion	11/05→11/08				
Eos 3.2 V6	06/06→05/09	CBR	V6cyl. 3189cc	184kW (250PS)	TD20023
Golf V 3.2 R32 4motion	11/05→11/08				
Eos 3.2 V6	06/06→05/09	CBRA	V6cyl. 3189cc	184kW (250PS)	TD22178
Golf V 3.2 R32 4motion	11/05→11/08				





Multivan V 3.2 V6		02/04→11/09	CFLA			
Multivan V 3.2 V6 4motion		07/04→11/09		V6cyl.		
Transporter V Box 3.2 4motion		11/03→11/09		3189cc	173kW (235PS)	
Transporter V Box 3.2 V6,		02/04→11/09				
Transporter V Bus 3.2 V6						
Transporter V Bus 3.2 V6 4motion		11/03→11/09				TD20920
08-137400-00	STD	84.00	1.200		001 NT	ST
			1.500		026 P	F12/F14
			2.000		712 CR	ST
<hr/>						
Touareg 4.2 V8		12/02→11/06	AXQ			50
				V8cyl.		
				4172cc	228kW (310PS)	TD16853
<hr/>						
Phaeton 4.2 V8 4motion		05/03→	BGH			
				V8cyl.		
				4172cc	246kW (335PS)	TD17018
<hr/>						
Phaeton 4.2 V8 4motion		05/03→	BGJ			
				V8cyl.		
				4172cc	246kW (335PS)	TD18026
<hr/>						
Touareg 4.2 V8		12/02→11/06	BHX			
				V8cyl.		
				4172cc	228kW (310PS)	TD16854
<hr/>						
08-139600-00	STD	84.50	1.200		001 NT	ST
			1.500		026 P	F12/F14
			3.000		231 NT	ST
<hr/>						
1200		01/65→12/79	211, 311			51
1302S		01/67→12/75		B4cyl.		
1303S		01/72→12/79		1584cc		
1600 Karmann Ghia		01/67→12/75				
1600 Transporter		01/68→12/79				
1600TL		01/66→12/75				
Industrial Eng. 126		01/65→12/79				
Typ 1, Typ 2, Typ 3		08/67→				
Variant 1600 A, Variant 1600 L,		01/67→12/75				
Variant 1600 TL						FM1803
<hr/>						
Kaefer 1302 1.6		07/71→07/74	AE			
Kaefer Convertible 1303 1.6		08/70→07/74		B4cyl.		
Transporter II Box 1.6		08/70→04/79		1584cc	35-37kW (48-50PS)	TD5133
<hr/>						
Kaefer 1302 1.6		07/71→07/74	AH			
Kaefer Convertible 1303 1.6		08/70→07/74		B4cyl.		
Transporter II Bus 1.6		08/70→04/79		1584cc	35-37kW (48-50PS)	TD4018
<hr/>						
Kaefer 1303 LS, S 1.6		08/72→12/79	AJ			
				B4cyl.		
				1584cc	37kW (50PS)	TD4024





Kaefer 1302 1.6 Kaefer Convertible 1303 1.6		07/71→07/74 08/70→07/74	AK	B4cyl. 1584cc	35kW (47PS)	TD5134
181 1.6 Karmann Ghia Coupe 1600		03/73→02/79 07/71→07/74	AL	B4cyl. 1584cc	35kW (47PS)	TD14189
181 1.6		03/73→02/79	AM	B4cyl. 1584cc	35kW (47PS)	TD14190
Kaefer 1303 LS, S 1.6 Transporter II Box 1.6, Transporter II Bus 1.6 Transporter II Platform/Chassis 1.6		08/72→12/79 08/70→04/79 08/68→07/79	AS	B4cyl. 1584cc	37kW (50PS)	TD4030
Kaefer Convertible 1500 1.6 Transporter I Box 1.6 Transporter I Bus 1.6		07/69→07/70 08/64→12/68 06/66→07/67	B	B4cyl. 1584cc	35kW (47PS)	TD5137
T2 1.6		09/79→12/82	CZ	B4cyl. 1584cc	34kW (46PS)	TD4053
1500, 1600 1.6 L		07/64→07/73	P	B4cyl. 1584cc	37kW (50PS)	TD5139
1500, 1600 1.6, 1500, 1600 1.6 TL, 1500, 1600 Hatchback 1.6 TL, 1500, 1600 Variant 1.6 L		08/65→07/73	T	B4cyl. 1584cc	40kW (54PS)	TD5029
1500, 1600 1.6, 1500, 1600 1.6 TL, 1500, 1600 Hatchback 1.6 TL, 1500, 1600 Variant 1.6 L		08/65→07/73	U	B4cyl. 1584cc	40kW (54PS)	TD5030
08-394600-00 08-394614-10	STD 1.50mm	85.50	2.000 2.000 5.000	 	005 IF P 026 P 236 P	IKA STD STD
Kaefer 1600 i		10/92→07/03	ACD	B4cyl. 1584cc	34kW (46PS)	TD9471
08-405300-10 08-405314-10 08/1979→	STD 1.50mm	85.50	1.750 2.000 5.000	 	005 IF P 026 P 236 P	IKA STD STD



LT 28-35 I Box 2.0, LT 28-35 I Bus 2.0, LT 28-35 I Platform/Chassis 2.0, LT 40-55 I Box 2.0, LT 40-55 I Platform/ Chassis 2.0	04/75→09/83	CH	4cyl. 1984cc	55kW (75PS)	53
					TD4044

08-399700-10	STD	86.50	2.000		001 IF CR P	KV1
08-399707-10	0.50mm		2.500		005 IF P	STD
			5.000		231 CR P	STD

411, 412 1.7	07/68→08/73	V	4cyl. 1679cc	59kW (80PS)	54
					TD5120

411, 412 1.7 412 Variant 1.7	09/69→08/73 01/72→12/73	W	4cyl. 1679cc	59kW (80PS)	54
					TD4170

411, 412 1.7	07/68→08/73	Z	4cyl. 1679cc	59kW (80PS)	54
					TD4179

08-397900-00	STD	90.00	2.000		005 IF P	IKA
			2.000		026 P	STD
			5.000		236 P	STD

Taro 2.4 D Taro 2.4 D 4x4	06/89→03/97 04/89→03/97	2L	4cyl. 2446cc	58kW (79PS)	55
					TD4966
				Diesel	

08-373800-00	STD	92.00	2.000		007 CR P	KV1
08-373807-00	0.50mm		2.000		005 P	STD
[R42780]			4.000		231 CR P	STD

LT 28-35 II Bus 2.8 TDI LT 28-46 II Box 2.8 TDI, LT 28-46 II Platform/Chassis 2.8 TDI	02/97→12/98 06/97→12/98	AGK	4cyl. 2799cc	92kW (125PS)	56
				Turbo Intercooled	TD9522
				Diesel	

LT 28-35 II Bus 2.8 TDI LT 28-46 II Box 2.8 TDI, LT 28-46 II Platform/Chassis 2.8 TDI	01/99→01/02 01/99→07/06	ATA	4cyl. 2799cc	96kW (131PS)	56
				Turbo Intercooled	TD13444
				Diesel	

LT 28-46 II Box 2.8 TDI, LT 28-46 II Platform/Chassis 2.8 TDI	04/02→07/06	AUH	4cyl. 2799cc	116kW (158PS)	56
				Turbo Intercooled	TD16450
				Diesel	





LT 28-35 II Bus 2.8 TDI			05/01→06/06	BCQ				
LT 28-46 II Box 2.8 TDI,			04/02→07/06		4cyl.			
LT 28-46 II Platform/Chassis 2.8 TDI					2798cc	116kW (158PS)		
				Diesel	Turbo Intercooled			TD20509
08-143000-00	STD	93.00	2.500		008 IW CR P			KV1
			2.000		005 IFU P			IKA
			3.000		231 CR P			STD
411, 412 1.8, 412 Variant 1.8 E, LE			07/73→03/75	AN				57
					4cyl.			
					1795cc	63kW (86PS)		TD5130
Transporter II Box 1.8,			11/73→07/75	AP				
Transporter II Bus 1.8					4cyl.			
					1795cc	50-63kW (68-85PS)		TD4991
411, 412 1.8, 412 Variant 1.8 E, LE			07/73→03/75	AT				
					4cyl.			
					1795cc	55kW (75PS)		TD5131
08-398800-00	STD	93.00	2.000		005 IF P			IKA
			2.000		026 P			STD
			4.000		712 CR			ST
Transporter II Box 2.0			08/75→07/79	CJ				58
Transporter II Bus 2.0			08/75→04/79		B4cyl.			
					1970cc	51kW (69PS)		TD4045
Transporter III Box 2.0			05/79→04/86	CU				
Transporter III Bus 2.0			05/79→12/82		B4cyl.			
Transporter III Platform/Chassis 2.0			05/79→04/86		1970cc	51kW (69PS)		TD4050
Transporter III Bus 2.0			05/79→12/82	CV				
					B4cyl.			
					1970cc	51kW (69PS)		TD4051
Transporter III Box 1.9			10/82→07/92	DF				
Transporter III Bus 1.9			08/82→07/92		4cyl.			
Transporter III Platform/Chassis 1.9			09/82→07/92		1915cc	44kW (60PS)		TD4058
Transporter III Box 1.9			10/82→07/92	DG				
Transporter III Box 1.9 Syncro			11/84→07/92		B4cyl.			
Transporter III Bus 1.9			08/82→07/92		1915cc	57kW (77PS)		
Transporter III Bus 1.9 Syncro			02/85→07/92					
Transporter III Platform/Chassis 1.9			08/82→07/92					
Transporter III Platform/Chassis 1.9 Syncro			12/84→07/92					TD4993
Transporter III Box 1.9			10/84→02/89	DH				
Transporter III Bus 1.9			01/83→07/85		B4cyl.			
Transporter III Platform/Chassis 1.9			10/84→02/89		1913cc	60kW (81PS)		TD4994





Transporter II Box 2.0		08/75→07/79	GE					
Transporter II Bus 2.0		08/75→04/79		B4cyl.	1970cc	51kW (69PS)		
TD5005								
Transporter III Box 1.9		08/83→02/89	GW					
Transporter III Bus 1.9		08/83→07/85		B4cyl.	1913cc	66kW (89PS)		
TD4099								
Transporter III Bus 1.9			SP					
				B4cyl.	1915cc	54kW (73PS)		
TD4152								
08-399100-00	STD	94.00	1.750		005 IF P		IKA	
08-399105-00	0.25mm				026 P		STD	
08-399107-00	0.50mm			2.000		231 P		STD
08-399111-00	1.00mm			4.000				
Transporter III Box 2.1,		03/86→07/92	DJ				59	
Transporter III Box 2.1 Syncro				B4cyl.				
Transporter III Bus 2.1		08/85→07/92		2109cc	82kW (111PS)			
Transporter III Bus 2.1 Syncro		01/86→07/92						
Transporter III Platform/Chassis 2.1,		03/86→07/92						
Transporter III Platform/ Chassis 2.1 Syncro						TD4059		
Transporter III Box 2.1,		08/85→07/92	MV					
Transporter III Box 2.1 Syncro,				B4cyl.				
Transporter III Bus 2.1				2109cc	70kW (95PS)			
Transporter III Bus 2.1 CAT		06/89→07/92						
Transporter III Bus 2.1 Syncro,		08/85→07/92						
Transporter III Platform/Chassis 2.1,								
Transporter III Platform/ Chassis 2.1 Syncro							TD4133	
Transporter III Bus 2.1,		10/86→07/92	SR					
Transporter III Bus 2.1 Syncro				4cyl.	2109cc	64kW (87PS)		
TD4153								
Transporter III Box 2.1 i,		07/89→07/92	SS					
Transporter III Bus 2.1 i,				4cyl.				
Transporter III Platform/Chassis 2.1 i				2109cc	68kW (92PS)			
TD4154								
08-990000-00	STD	94.00	1.750		001 IF CR P		IKA	
				2.000		026 P		STD
				3.500		712 CR		ST



VW - Porsche 914 2.0	09/72→12/75	GB	B4cyl. 1971cc	74kW (100PS)	60	TD5004
----------------------	-------------	----	------------------	--------------	----	--------

08-318600-10	STD	94.00	1.500		005 IW P	F12/F14
			1.750		005 IW	STD
			4.000		231 P	STD
08-399100-00	STD	94.00	1.750		005 IF P	IKA
08-399105-00	0.25mm					
08-399107-00	0.50mm		2.000		026 P	STD
08-399111-00	1.00mm		4.000		231 P	STD

MODEL INDEX

Modelverzeichnis • Index de modele • Índice de Modelo
Indeks modelu • Модель автомобиля • دليل الموديل



CCM

x



9

08/75→08/78	66 1.1	B 10 E	Petrol	1108	4	1
08/75→08/78	66 1.3	B 13 E	Petrol	1289	4	2
08/75→08/78	66 DL 1.1	B 10	Petrol	1108	4	1
10/75→11/79	66 Estate DL 1.1	B 10	Petrol	1108	4	1
10/75→11/79	66 Estate GL 1.3	B 130	Petrol	1289	4	2
08/75→08/78	66 GL 1.3	B 130	Petrol	1289	4	2
08/68→07/74	140 2.0	B 20 A	Petrol	1998	4	21
09/70→04/75	140 2.0	B 20 E	Petrol	1998	4	21
11/68→09/72	140 2.0 S	B 20 B	Petrol	1998	4	21
08/68→07/74	140 Estate 2.0 S	B 20 A	Petrol	1998	4	21
08/72→07/74	140 Estate 2.0 S	B 20 B	Petrol	1998	4	21
08/72→07/73	140 Estate 2.0 S	B 20 E	Petrol	1998	4	21
08/72→07/74	164 2.9	B 30 E	Petrol	2979	6	21
08/68→07/73	164 2.9 E	B 30 A	Petrol	2979	6	21
08/76→08/83	240 2.0	B 19 A	Petrol	1986	4	20
09/88→12/93	240 2.0	B 19 E	Petrol	1986	4	20
08/74→07/76	240 2.0	B 20 A	Petrol	1998	4	21
09/84→12/93	240 2.0	B 200 E	Petrol	1986	4	22
09/88→12/93	240 2.0	B 200 F	Petrol	1986	4	22
08/84→07/85	240 2.0	B 200 K	Petrol	1986	4	22
08/74→07/84	240 2.1	B 21 A	Petrol	2127	4	25
08/74→07/80	240 2.1	B 21 E	Petrol	2127	4	25
08/84→07/86	240 2.3	B 230 A	Petrol	2316	4	26
08/83→07/85	240 2.3	B 230 E	Petrol	2316	4	27
08/86→07/87	240 2.3	B 230 F	Petrol	2316	4	26
08/86→12/88	240 2.3	B 230 K	Petrol	2316	4	26
08/86→07/93	240 2.3 i CAT	B 230 F	Petrol	2316	4	26
08/78→08/93	240 2.4 Diesel	D 24	Diesel	2383	6	5
08/79→07/80	240 2.7 GLT6	B 27 E	Petrol	2664	V6	19
10/82→09/84	240 2.8	B 28 E	Petrol	2849	V6	24
08/76→12/84	240 Kombi 2.0	B 19 A	Petrol	1986	4	20
08/74→07/75	240 Kombi 2.0	B 20 A	Petrol	1998	4	21
08/83→07/93	240 Kombi 2.0	B 200 E	Petrol	1986	4	22
09/88→12/93	240 Kombi 2.0	B 200 F	Petrol	1986	4	22
08/84→07/85	240 Kombi 2.0	B 200 K	Petrol	1986	4	22
08/74→07/84	240 Kombi 2.1	B 21 A	Petrol	2127	4	25
08/74→07/79	240 Kombi 2.1	B 21 E	Petrol	2127	4	25
08/84→07/86	240 Kombi 2.3	B 230 A	Petrol	2316	4	26
08/84→07/85	240 Kombi 2.3	B 230 E	Petrol	2316	4	27
08/86→07/87	240 Kombi 2.3	B 230 F	Petrol	2316	4	26
08/86→12/88	240 Kombi 2.3	B 230 K	Petrol	2316	4	26
08/91→07/92	240 Kombi 2.3 CAT	B 230 F	Petrol	2316	4	26
08/86→07/93	240 Kombi 2.3 i CAT	B 230 F	Petrol	2316	4	26
04/79→08/93	240 Kombi 2.4 Diesel	D 24	Diesel	2383	6	5
08/79→07/80	240 Kombi 2.7 GLT6	B 27 E	Petrol	2664	V6	19
10/80→09/82	240 Kombi 2.8	B 28 E	Petrol	2849	V6	24
08/76→07/82	260 2.7	B 27 A	Petrol	2664	V6	19
08/74→07/82	260 2.7	B 27 E	Petrol	2664	V6	19
08/80→07/82	260 2.8	B 28 E	Petrol	2849	V6	24
08/77→07/78	260 Coupe 2.7	B 27 E	Petrol	2664	V6	19
08/75→07/77	260 Estate 2.7	B 27 A	Petrol	2664	V6	19
07/75→07/82	260 Estate 2.7	B 27 E	Petrol	2664	V6	19
10/78→07/82	260 Estate 2.7	B 27 F	Petrol	2664	V6	19
01/89→12/90	340-360 1.3	B 13	Petrol	1289	4	2
08/75→12/88	340-360 1.4	B 14.4 S	Petrol	1397	4	4
08/79→08/85	340-360 1.4	B 143 E	Petrol	1397	4	4
08/84→07/91	340-360 1.6 Diesel	D 16	Diesel	1595	4	7
08/85→07/91	340-360 1.7	B 17 2 K	Petrol	1721	4	10
08/80→07/84	340-360 2.0	B 19 A	Petrol	1986	4	20
08/82→07/84	340-360 2.0	B 19 E	Petrol	1986	4	20



CCM

x



08/84→07/88	340-360 2.0	B 200 E	Petrol	1986	4	22
08/86→07/89	340-360 2.0	B 200 F	Petrol	1986	4	22
08/80→07/87	340-360 2.0	B 200 K	Petrol	1986	4	22
08/81→07/82	340-360 2.1	B 21 E	Petrol	2127	4	25
01/89→12/90	340-360 Saloon 1.3	B 13	Petrol	1289	4	2
08/83→12/88	340-360 Saloon 1.4	B 14.4 S	Petrol	1397	4	4
01/83→12/86	340-360 Saloon 1.4	B 143 E	Petrol	1397	4	4
08/84→07/91	340-360 Saloon 1.6 Diesel	D 16	Diesel	1595	4	7
08/85→07/91	340-360 Saloon 1.7	B 17 2 K	Petrol	1721	4	10
08/82→07/84	340-360 Saloon 2.0	B 19 A	Petrol	1986	4	20
08/83→07/84	340-360 Saloon 2.0	B 19 E	Petrol	1986	4	20
08/84→07/86	340-360 Saloon 2.0	B 200 E	Petrol	1986	4	22
08/88→07/89	340-360 Saloon 2.0	B 200 F	Petrol	1986	4	22
08/84→07/90	340-360 Saloon 2.0	B 200 K	Petrol	1986	4	22
02/76→07/79	343 1.4			1397	4	4
02/76→07/79	345 1.4			1397	4	4
08/84→07/89	360 2.0 i	B 200 KE	Petrol	1986	4	22
08/84→07/89	440 2.0 i	B 200 KE	Petrol	1986	4	22
09/88→12/96	440 K 1.7	B 18 EP	Petrol	1721	4	10
08/88→07/89	440 K 1.7	B 18 F	Petrol	1721	4	10
08/89→12/96	440 K 1.7	B 18 FP	Petrol	1721	4	10
09/88→08/89	440 K 1.7	B 18 K	Petrol	1721	4	10
09/88→12/96	440 K 1.7	B 18 KP	Petrol	1721	4	10
08/88→12/96	440 K 1.7 Turbo	B 18 FT	Petrol	1721	4	10
08/91→12/96	440 K 1.8	B 18 U	Petrol	1794	4	14
07/94→12/96	440 K 1.9 Turbo-Diesel	D 19 T	Diesel	1870	4	8
08/92→07/96	440 K 2.0	B 20 F	Petrol	1998	4	14
08/89→07/92	460 L 1.7	B 18 E	Petrol	1721	4	10
08/89→07/92	460 L 1.7	B 18 EP	Petrol	1721	4	10
09/88→07/96	460 L 1.7	B 18 KP	Petrol	1721	4	10
08/89→07/96	460 L 1.7 Turbo	B 18 FT	Petrol	1721	4	10
08/91→07/96	460 L 1.8	B 18 U	Petrol	1794	4	14
07/94→07/96	460 L 1.9 Turbo-Diesel	D 19 T	Diesel	1870	4	8
	460 L 1.9 Turbo-Diesel	F8Q 768	Diesel	1870	4	9
08/92→07/96	460 L 2.0	B 20 F	Petrol	1998	4	14
04/86→07/89	480 E 1.7	B 18 E	Petrol	1721	4	10
08/89→07/96	480 E 1.7	B 18 EP	Petrol	1721	4	10
08/87→07/89	480 E 1.7	B 18 F	Petrol	1721	4	10
08/87→07/96	480 E 1.7 Turbo	B 18 FT	Petrol	1721	4	10
08/92→09/95	480 E 2.0	B 20 F	Petrol	1998	4	14
01/87→08/88	740 2.0	B 200 E	Petrol	1986	4	22
01/85→08/90	740 2.0	B 200 ET	Petrol	1986	4	23
09/90→08/92	740 2.0	B 200 F	Petrol	1986	4	22
08/85→07/92	740 2.0	B 200 G	Petrol	1986	4	22
09/88→08/90	740 2.0	B 200 K	Petrol	1986	4	22
04/83→07/84	740 2.0 GLE	B 19 E	Petrol	1986	4	20
09/90→08/91	740 2.0 Turbo	B 200 FT	Petrol	1986	4	23
08/84→07/86	740 2.3	B 230 A	Petrol	2316	4	26
08/84→07/88	740 2.3	B 230 E	Petrol	2316	4	27
08/84→07/92	740 2.3	B 230 F	Petrol	2316	4	26
08/88→07/90	740 2.3	B 230 FB	Petrol	2316	4	26
08/86→07/88	740 2.3	B 230 K	Petrol	2316	4	26
08/87→08/92	740 2.3	B 234 F	Petrol	2316	4	26
08/85→12/88	740 2.3 Turbo	B 230 ET	Petrol	2316	4	28
08/86→08/91	740 2.3 Turbo	B 230 FT	Petrol	2316	4	28
08/84→07/92	740 2.4 Diesel	D 24	Diesel	2383	6	5
08/84→07/90	740 2.4 TD	D 24 T	Diesel	2383	6	6
08/86→10/88	740 2.4 TD	D 24 TIC	Diesel	2383	6	6
08/85→07/92	740 Kombi 2.0	B 200 E	Petrol	1986	4	22
08/89→07/91	740 Kombi 2.0	B 200 F	Petrol	1986	4	22

MODEL INDEX

Modelverzeichnis • Index de modele • Índice de Modelo
Indeks modelu • Модель автомобиля • دليل الموديل



CCM

x



9

08/85→07/92	740 Kombi 2.0	B 200 G	Petrol	1986	4	22
09/88→08/90	740 Kombi 2.0	B 200 K	Petrol	1986	4	22
05/85→08/90	740 Kombi 2.0 Turbo	B 200 ET	Petrol	1986	4	23
09/90→08/91	740 Kombi 2.0 Turbo	B 200 FT	Petrol	1986	4	23
08/85→07/86	740 Kombi 2.3	B 230 A	Petrol	2316	4	26
08/85→07/88	740 Kombi 2.3	B 230 E	Petrol	2316	4	27
08/85→07/92	740 Kombi 2.3	B 230 F	Petrol	2316	4	26
08/89→07/90	740 Kombi 2.3	B 230 FB	Petrol	2316	4	26
09/85→07/90	740 Kombi 2.3	B 230 K	Petrol	2316	4	26
08/87→08/92	740 Kombi 2.3	B 234 F	Petrol	2316	4	26
08/84→08/87	740 Kombi 2.3 GL	B 230 E	Petrol	2316	4	27
08/85→07/88	740 Kombi 2.3 Turbo	B 230 ET	Petrol	2316	4	28
08/86→08/91	740 Kombi 2.3 Turbo	B 230 FT	Petrol	2316	4	28
08/89→07/90	740 Kombi 2.3 Turbo	B 230 GT	Petrol	2316	4	28
08/85→07/88	740 Kombi 2.4 Diesel	D 24	Diesel	2383	6	5
08/86→07/88	740 Kombi 2.4 TD Interc.	D 24 TIC	Diesel	2383	6	6
09/85→07/92	740 Kombi 2.4 Turbo-Diesel	D 24 T	Diesel	2383	6	6
08/84→08/87	760 2.3	B 230 ET	Petrol	2316	4	28
01/88→07/92	760 2.3	B 230 FT	Petrol	2316	4	28
08/84→08/87	760 2.3	B 230 K	Petrol	2316	4	26
08/84→10/88	760 2.3 Turbo	B 230 ET	Petrol	2316	4	28
09/87→08/90	760 2.3 Turbo	B 230 FT	Petrol	2316	4	28
01/82→07/92	760 2.4 D	D 24	Diesel	2383	6	5
08/87→07/92	760 2.4 TD Interc.	D 24 TIC	Diesel	2383	6	6
08/82→07/92	760 2.4 Turbo Diesel	D 24 T	Diesel	2383	6	6
08/81→07/88	760 2.8	B 28 E	Petrol	2849	V6	24
08/84→08/87	760 Kombi 2.3	B 230 K	Petrol	2316	4	26
08/84→08/90	760 Kombi 2.3 Turbo	B 230 ET	Petrol	2316	4	28
09/87→08/90	760 Kombi 2.3 Turbo	B 230 FT	Petrol	2316	4	28
01/82→07/92	760 Kombi 2.4 D	D 24	Diesel	2383	6	5
08/87→07/92	760 Kombi 2.4 TD Interc.	D 24 TIC	Diesel	2383	6	6
08/86→08/90	760 Kombi 2.8	B 28 E	Petrol	2849	V6	24
04/86→07/90	780 2.4 D	D 24 TIC	Diesel	2383	6	6
09/93→10/96	850 2.0 Turbo	B 5204 T2	Petrol	1984	5	11
08/95→12/96	850 2.3 T5-R	B 5234 T4	Petrol	2319	5	11
06/95→10/96	850 2.3 Turbo R	B 5234 T5	Petrol	2319	5	11
09/93→10/97	850 2.4 GLE	B 5254 T	Petrol	2435	5	15
09/92→08/97	850 2.4 i	B 5252 S	Petrol	2435	5	16
06/91→07/94	850 2.5	B 5252	Petrol	2435	5	16
08/95→12/96	850 2.5 TDI	D 5252 T	Diesel	2461	5	13
09/93→10/97	850 Estate 2.0 Turbo	B 5204 T2	Petrol	1984	5	11
08/95→12/96	850 Estate 2.3 T5-R	B 5234 T4	Petrol	2319	5	11
06/95→10/97	850 Estate 2.3 Turbo R	B 5234 T5	Petrol	2319	5	11
09/93→10/97	850 Estate 2.4 GLE	B 5254 T	Petrol	2435	5	15
08/92→07/94	850 Estate 2.5	B 5252	Petrol	2435	5	16
04/96→12/96	850 Estate 2.5 AWD	B 5254 T	Petrol	2435	5	15
08/95→12/96	850 Estate 2.5 TDI	D 5252 T	Diesel	2461	5	13
09/90→09/93	940 2.0	B 200 E	Petrol	1986	4	22
01/92→07/94	940 2.0	B 200 F	Petrol	1986	4	22
09/90→09/93	940 2.0	B 200 G	Petrol	1986	4	22
09/90→09/93	940 2.0	B 204 FT	Petrol	1986	4	23
08/90→12/94	940 2.0 Turbo	B 200 FT	Petrol	1986	4	23
08/90→12/94	940 2.3	B 230 E	Petrol	2316	4	27
08/90→12/94	940 2.3	B 230 FB	Petrol	2316	4	26
09/90→09/93	940 2.3	B 230 FT	Petrol	2316	4	28
08/90→07/91	940 2.3	B 234 F	Petrol	2316	4	26
08/90→07/94	940 2.3 Turbo	B 230 FT	Petrol	2316	4	28
08/90→12/94	940 2.4 D	D 24	Diesel	2383	6	5
08/90→12/94	940 2.4 TD Intercooler	D 24 TIC	Diesel	2383	6	6
08/90→12/94	940 2.4 Turbo Diesel	D 24 T	Diesel	2383	6	6



CCM

x



11/94→12/95	940 II 2.0	B 200 G	Petrol	1986	4	22
10/94→05/97	940 II 2.0	B 204 FT	Petrol	1986	4	23
04/96→10/98	940 II 2.0 Turbo	B 200 FT	Petrol	1986	4	23
08/94→10/98	940 II 2.3	B 230 FB	Petrol	2316	4	26
08/94→12/98	940 II 2.3 Turbo	B 230 FT	Petrol	2316	4	28
08/94→10/98	940 II 2.4 TD Interc.	D 24 TIC	Diesel	2383	6	6
11/94→12/95	940 II Estate 2.0	B 200 G	Petrol	1986	4	22
10/94→05/97	940 II Estate 2.0	B 204 FT	Petrol	1986	4	23
04/96→10/98	940 II Estate 2.0 Turbo	B 200 FT	Petrol	1986	4	23
08/94→10/98	940 II Estate 2.3	B 230 FB	Petrol	2316	4	26
08/94→10/98	940 II Estate 2.3 Turbo	B 230 FT	Petrol	2316	4	28
08/94→10/98	940 II Estate 2.4 TD Interc.	D 24 TIC	Diesel	2383	6	6
01/92→07/94	940 Kombi 2.0	B 200 F	Petrol	1986	4	22
09/90→09/93	940 Kombi 2.0	B 200 G	Petrol	1986	4	22
01/91→07/95	940 Kombi 2.0 Turbo	B 200 FT	Petrol	1986	4	23
08/90→12/94	940 Kombi 2.3	B 230 FB	Petrol	2316	4	26
08/90→07/91	940 Kombi 2.3	B 234 F	Petrol	2316	4	26
08/90→07/94	940 Kombi 2.3 Turbo	B 230 FT	Petrol	2316	4	28
08/90→07/95	940 Kombi 2.4 D	D 24	Diesel	2383	6	5
08/90→08/94	940 Kombi 2.4 TD Intercooler	D 24 TIC	Diesel	2383	6	6
08/90→07/94	940 Kombi 2.4 Turbo Diesel	D 24 T	Diesel	2383	6	6
09/90→09/93	960 2.0	B 200 F	Petrol	1986	4	22
08/90→09/93	960 2.0	B 204 FT	Petrol	1986	4	23
09/90→08/93	960 2.3 Turbo	B 230 FT	Petrol	2316	4	28
09/91→07/94	960 2.4 TD Interc.	D 24 TIC	Diesel	2383	6	6
08/90→07/94	960 2.9	B 6304 F	Petrol	2922	6	16
08/90→09/93	960 Kombi 2.0	B 204 FT	Petrol	1986	4	23
09/90→08/93	960 Kombi 2.3 Turbo	B 230 FT	Petrol	2316	4	28
09/91→07/94	960 Kombi 2.4 TD Interc.	D 24 TIC	Diesel	2383	6	6
09/90→08/93	960 Kombi 2.4 Tdi	D 24 TIC	Diesel	2383	6	6
08/90→07/94	960 Kombi 2.9	B 6304 F	Petrol	2922	6	16
10/10→12/12	C30 1.6 D2	D 4162 T	Diesel	1560	4	3
10/06→12/12	C30 2.0	B 4204 S3	Petrol	1999	4	18
10/06→12/12	C30 2.0 D	D 4204 T	Diesel	1998	4	17
03/98→10/05	C70 I Convertible 2.0	B 5204 T2	Petrol	1984	5	11
03/98→10/05	C70 I Convertible 2.3 T-5	B 5234 T3	Petrol	2319	5	11
03/98→10/05	C70 I Convertible 2.5 T	B 5254 T	Petrol	2435	5	15
03/97→09/02	C70 I Coupe 2.0	B 5204 T2	Petrol	1984	5	11
03/97→09/02	C70 I Coupe 2.3 T-5	B 5234 T3	Petrol	2319	5	11
03/97→09/02	C70 I Coupe 2.5 T	B 5254 T	Petrol	2435	5	15
01/08→	C70 II Convertible 2.0 D	D 4204 T	Diesel	1998	4	17
11/68→05/71	P 121 2.0	B 20 A	Petrol	1998	4	21
11/68→05/71	P 122 S Amazon 2.0	B 20 B	Petrol	1998	4	21
04/72→11/73	P 1800 2.0 ES	B 20 E	Petrol	1998	4	21
09/95→08/99	S40 I 1.6	B 4164 S	Petrol	1587	4	11
07/95→08/99	S40 I 1.8	B 4184 S	Petrol	1783	4	15
05/97→07/00	S40 I 1.9 T4	B 4194 T	Petrol	1855	4	11
07/95→08/99	S40 I 1.9 TD	D 4192 T	Diesel	1870	4	8
07/95→12/03	S40 I 2.0	B 4204 S	Petrol	1948	4	15
10/97→12/03	S40 I 2.0 T	B 4204 T	Petrol	1948	4	15
10/10→	S40 II 1.6 D2	D 4162 T	Diesel	1560	4	3
10/06→	S40 II 2.0	B 4204 S3	Petrol	1999	4	18
01/04→	S40 II 2.0 D	D 4204 T	Diesel	1998	4	17
07/00→09/02	S60 2.3 T5	B 5234 T7	Petrol	2319	5	11
07/01→04/10	S60 2.4 D5	D 5244 T	Diesel	2401	5	12
01/11→	S60 II DRIVE / D2	D 4162 T	Diesel	1560	4	3
11/00→04/10	S60 T5	B 5234 T3	Petrol	2319	5	11
01/97→11/00	S70 2.0	B 5204 T2	Petrol	1984	5	11
11/96→11/00	S70 2.3	B 5234 T3	Petrol	2319	5	11
04/99→09/00	S70 2.3	B 5234 T7	Petrol	2319	5	11

MODEL INDEX

Modelverzeichnis • Index de modele • Índice de Modelo
Indeks modelu • Модель автомобиля • دليل الموديل



CCM

x



9

01/97→11/00	S70 2.3 T-5	B 5234 T3	Petrol	2319	5	11
11/96→09/98	S70 2.3 T5 AWD	B 5234 T3	Petrol	2319	5	11
07/97→09/00	S70 2.3 T5 AWD	B 5234 T4	Petrol	2319	5	11
11/96→04/99	S70 2.4 T5 AWD	B 5254 T	Petrol	2435	5	15
01/97→11/00	S70 2.4 Turbo	B 5254 T	Petrol	2435	5	15
01/97→07/99	S70 2.5 i	B 5252 S	Petrol	2435	5	16
01/97→11/00	S70 2.5 TDI	D 5252 T	Diesel	2461	5	13
10/99→09/00	S70 2.5 TDi AWD	D 5252 T	Diesel	2461	5	13
08/01→07/06	S80 I 2.4 D5	D 5244 T	Diesel	2401	5	12
01/99→07/06	S80 I 2.5 TDI	D 5252 T	Diesel	2461	5	13
06/11→	S80 II 1.6 DRIVe	D 4162 T	Diesel	1560	4	3
01/08→	S80 II 2.0	B 4204 S3	Petrol	1999	4	18
02/08→	S80 II 2.0 TDi	D 4204 T	Diesel	1998	4	17
03/06→	S80 II 2.4 D	D 5244 T	Diesel	2401	5	12
01/97→05/98	S90 2.9	B 6304 G	Petrol	2922	6	16
12/95→08/99	V40 Estate 1.6	B 4164 S	Petrol	1587	4	11
07/95→08/99	V40 Estate 1.8	B 4184 S	Petrol	1783	4	15
05/97→07/00	V40 Estate 1.9 T4	B 4194 T	Petrol	1855	4	11
07/95→08/99	V40 Estate 1.9 TD	D 4192 T	Diesel	1870	4	8
07/95→06/04	V40 Estate 2.0	B 4204 S	Petrol	1948	4	15
10/97→07/00	V40 Estate 2.0 T	B 4204 T	Petrol	1948	4	15
03/12→	V40 Hatchback D2	D 4162 T	Diesel	1560	4	3
01/10→	V50 1.6 D2	D 4162 T	Diesel	1560	4	3
10/06→	V50 2.0	B 4204 S3	Petrol	1999	4	18
04/04→	V50 2.0 D	D 4204 T	Diesel	1998	4	17
06/11→	V60 1.6 DRIVe	D 4162 T	Diesel	1560	4	3
01/97→03/00	V70 2.5 i	B 5252 S	Petrol	2435	5	16
01/97→03/00	V70 I 2.0	B 5204 T2	Petrol	1984	5	11
11/96→11/00	V70 I 2.3	B 5234 T3	Petrol	2319	5	11
04/97→09/98	V70 I 2.3 AWD	B 5234 T3	Petrol	2319	5	11
12/98→02/00	V70 I 2.3 AWD	B 5234 T7	Petrol	2319	5	11
01/97→03/00	V70 I 2.3 T-5	B 5234 T3	Petrol	2319	5	11
01/97→03/00	V70 I 2.3 T-5 AWD	B 5234 T3	Petrol	2319	5	11
01/97→03/00	V70 I 2.4 Turbo	B 5254 T	Petrol	2435	5	15
01/97→05/00	V70 I 2.5 TDI	D 5252 T	Diesel	2461	5	13
11/96→02/00	V70 I 2.5 TDi AWD	D 5252 T	Diesel	2461	5	13
01/97→05/00	V70 I 2.5 Turbo AWD	B 5254 T	Petrol	2435	5	15
10/00→09/04	V70 II 2.3	B 5234 T7	Petrol	2319	5	11
10/00→09/04	V70 II 2.3 AWD	B 5234 T7	Petrol	2319	5	11
03/00→08/07	V70 II 2.3 T5	B 5234 T3	Petrol	2319	5	11
03/00→08/07	V70 II 2.3 T5	B 5234 T4	Petrol	2319	5	11
08/01→08/07	V70 II 2.4 D5	D 5244 T	Diesel	2401	5	12
03/00→08/07	V70 II 2.5 TDI	D 5252 T	Diesel	2461	5	13
06/11→	V70 III 1.6 DRIVe / D2	D 4162 T	Diesel	1560	4	3
10/07→	V70 III 2.0	B 4204 S3	Petrol	1999	4	18
10/07→	V70 III 2.0 D	D 4204 T	Diesel	1998	4	17
01/97→12/98	V90 Estate 2.9	B 6304 G	Petrol	2922	6	16
09/02→08/07	XC70 Cross Country 2.4 D5 XC AWD	D 5244 T	Diesel	2401	5	12
11/97→09/02	XC70 Cross Country 2.4 T XC AWD	B 5254 T	Petrol	2435	5	15
10/02→	XC90 D5	D 5244 T	Diesel	2401	5	12



CCM

x



9

B 10	Petrol	1108	4	70.00	1
B 10 E	Petrol	1108	4	70.00	1
B 13	Petrol	1289	4	73.00	2
B 13 E	Petrol	1289	4	73.00	2
B 14.4 S	Petrol	1397	4	76.00	4
B 17 2 K	Petrol	1721	4	81.00	10
B 18 E	Petrol	1721	4	81.00	10
B 18 EP	Petrol	1721	4	81.00	10
B 18 F	Petrol	1721	4	81.00	10
B 18 FP	Petrol	1721	4	81.00	10
B 18 FT	Petrol	1721	4	81.00	10
B 18 K	Petrol	1721	4	81.00	10
B 18 KP	Petrol	1721	4	81.00	10
B 18 U	Petrol	1794	4	82.70	14
B 19 A	Petrol	1986	4	88.90	20
B 19 E	Petrol	1986	4	88.90	20
B 20 A	Petrol	1998	4	88.90	21
B 20 B	Petrol	1998	4	88.90	21
B 20 E	Petrol	1998	4	88.90	21
B 20 F	Petrol	1998	4	82.70	14
B 21 A	Petrol	2127	4	92.00	25
B 21 E	Petrol	2127	4	92.00	25
B 27 A	Petrol	2664	V6	88.00	19
B 27 E	Petrol	2664	V6	88.00	19
B 27 F	Petrol	2664	V6	88.00	19
B 28 E	Petrol	2849	V6	91.00	24
B 30 A	Petrol	2979	6	88.90	21
B 30 E	Petrol	2979	6	88.90	21
B 130	Petrol	1289	4	73.00	2
B 143 E	Petrol	1397	4	76.00	4
B 200 E	Petrol	1986	4	88.90	22
B 200 ET	Petrol	1986	4	88.90	23
B 200 F	Petrol	1986	4	88.90	22
B 200 FT	Petrol	1986	4	88.90	23
B 200 G	Petrol	1986	4	88.90	22
B 200 K	Petrol	1986	4	88.90	22
B 200 KE	Petrol	1986	4	88.90	22
B 204 FT	Petrol	1986	4	88.90	23
B 230 A	Petrol	2316	4	96.00	26
B 230 E	Petrol	2316	4	96.00	27
B 230 ET	Petrol	2316	4	96.00	28
B 230 F	Petrol	2316	4	96.00	26
B 230 FB	Petrol	2316	4	96.00	26
B 230 FT	Petrol	2316	4	96.00	28
B 230 GT	Petrol	2316	4	96.00	28
B 230 K	Petrol	2316	4	96.00	26
B 234 F	Petrol	2316	4	96.00	26
B 4164 S	Petrol	1587	4	81.00	11
B 4184 S	Petrol	1783	4	83.00	15
B 4194 T	Petrol	1855	4	81.00	11
B 4204 S	Petrol	1948	4	83.00	15
B 4204 S3	Petrol	1999	4	87.50	18
B 4204 T	Petrol	1948	4	83.00	15
B 5204 T2	Petrol	1984	5	81.00	11
B 5234 T3	Petrol	2319	5	81.00	11
B 5234 T4	Petrol	2319	5	81.00	11
B 5234 T5	Petrol	2319	5	81.00	11
B 5234 T7	Petrol	2319	5	81.00	11
B 5252	Petrol	2435	5	83.00	16
B 5252 S	Petrol	2435	5	83.00	16

ENGINE INDEX

Motorverzeichnis • Index de moteur • Índice de Motor
Indeks silnika • Модель двигателя • دليل المحرك



CCM

x



9

B 5254 T	Petrol	2435	5	83.00	15
B 6304 F	Petrol	2922	6	83.00	16
B 6304 G	Petrol	2922	6	83.00	16
D 16	Diesel	1595	4	78.00	7
D 19 T	Diesel	1870	4	80.00	8
D 24	Diesel	2383	6	76.50	5
D 24 T	Diesel	2383	6	76.50	6
D 24 TIC	Diesel	2383	6	76.50	6
D 4162 T	Diesel	1560	4	75.00	3
D 4192 T	Diesel	1870	4	80.00	8
D 4204 T	Diesel	1998	4	85.00	17
D 5244 T	Diesel	2401	5	81.00	12
D 5252 T	Diesel	2461	5	81.00	13
F8Q 768	Diesel	1870	4	80.00	9



66 DL 1.1 66 Estate DL 1.1	08/75→08/78 10/75→11/79	B 10	4cyl. 1108cc	33kW (45PS)	1
					TD3980

66 1.1	08/75→08/78	B 10 E	4cyl. 1108cc	33-35kW (45-48PS)	TD21325
---------------	-------------	---------------	------------------------	--------------------------	----------------

08-334600-00	STD	70.00	1.750		001 IF CR P	IKA
<i>[R66160]</i>			2.000		026 P	STD
			3.500		712 CR	ST

340-360 1.3,340-360 Saloon 1.3	01/89→12/90	B 13	4cyl. 1289cc	49kW (67PS)	2
					TD3987

66 1.3	08/75→08/78	B 13 E	4cyl. 1289cc	42kW (57PS)	TD21326
---------------	-------------	---------------	------------------------	--------------------	----------------

66 GL 1.3 66 Estate GL 1.3	08/75→08/78 10/75→11/79	B 130	4cyl. 1289cc	42kW (57PS)	TD3904
---	----------------------------	--------------	------------------------	--------------------	---------------

08-333400-10	STD	73.00	1.750		001 IF CR P	IKA
<i>[R66220]</i>			2.000		026 P	STD
			4.000		712 CR	ST

C30 1.6 D2 S40 II 1.6 D2 S60 II DRIVe / D2 S80 II 1.6 DRIVe V40 Hatchback D2 V50 1.6 D2 V60 1.6 DRIVe, V70 III 1.6 DRIVe / D2	10/10→12/12 10/10→ 01/11→ 06/11→ 03/12→ 01/10→ 06/11→	D 4162 T	4cyl. 1560cc	84kW (114PS)	3
					TD23981
			Diesel	Turbo Intercooled	

08-433600-00	STD	75.00	2.500		008 CK P	KV1
08-433607-00	0.50mm		1.950		026 P	F12/F14
			2.000		231 LKZ CR P	KV1



343 1.4	02/76→07/79	B 14 OE	4
345 1.4	02/76→07/79	4cyl.	
		1397cc 51kW (69PS)	
TD23445			

340-360 1.4	08/75→12/88	B 14.4 S	
340-360 Saloon 1.4	08/83→12/88	4cyl.	
		1397cc 50-53kW (68-72PS)	
TD5142			

340-360 1.4	08/79→08/85	B 143 E	
340-360 Saloon 1.4	01/83→12/86	4cyl.	
		1397cc 46-53kW (63-72PS)	
TD3988			

08-333500-00	STD	76.00	1.750		001 IF CR P	IKA
08-333505-00	0.25mm				026 P	STD
08-333507-00	0.50mm				712 CR	ST
[R66190]			4.000			

240 2.4 Diesel	08/78→08/93	D 24	5
240 Kombi 2.4 Diesel	04/79→08/93	6cyl.	
740 2.4 Diesel	08/84→07/92	2383cc 58-60kW (79-82PS)	
740 Kombi 2.4 Diesel	08/85→07/88	Diesel	
760 2.4 D,760 Kombi 2.4 D	01/82→07/92		
940 2.4 D	08/90→12/94		
940 Kombi 2.4 D	08/90→07/95		TD3984

08-109500-00	STD	76.50	1.750		001 IF CR P	KV1
08-109505-00	0.25mm				005 IFU P	STD
08-109507-00	0.50mm				231 CR P	STD
08-109511-00	1.00mm		3.000			
[R43850]						

740 2.4 TD	08/84→07/90	D 24 T	6
740 Kombi 2.4 Turbo-Diesel	09/85→07/92	6cyl.	
760 2.4 Turbo Diesel	08/82→07/92	2383cc 79-82kW (107-112PS)	
940 2.4 Turbo Diesel	08/90→12/94	Diesel Turbo	
940 Kombi 2.4 Turbo Diesel	08/90→07/94		TD3985

740 2.4 TD	08/86→10/88	D 24 TIC	
740 Kombi 2.4 TD Interc.	08/86→07/88	6cyl.	
760 2.4 TD Interc.,	08/87→07/92	2383cc 85-95kW (115-129PS)	
760 Kombi 2.4 TD Interc.		Diesel Turbo Intercooled	
780 2.4 D	04/86→07/90		
940 2.4 TD Intercooler	08/90→12/94		
940 II 2.4 TD Interc.,	08/94→10/98		
940 II Estate 2.4 TD Interc.			
940 Kombi 2.4 TD Intercooler	08/90→08/94		
960 2.4 TD Interc.,	09/91→07/94		
960 Kombi 2.4 TD Interc.			
960 Kombi 2.4 Tdi	09/90→08/93		TD3986

08-109800-00	STD	76.50	1.750		001 IF CR P	KV1
08-109807-00	0.50mm				005 IFU CR P	IKA
08-109811-00	1.00mm				231 CR P	STD
[R45270]			3.000			



340-360 1.6 Diesel, 340-360 Saloon 1.6 Diesel		08/84→07/91	D 16	4cyl. 1595cc	40kW (54PS)	7
			Diesel			TD3981

08-335000-10	STD	78.00	2.000		001 CR P	KV1
08-335003-10	0.125mm		2.000		005 IF P	STD
08-335005-10	0.25mm		3.000		231 CR P	STD
08-335007-10	0.50mm					
[R66350]						

440 K 1.9 Turbo-Diesel 460 L 1.9 Turbo-Diesel		07/94→12/96 07/94→07/96	D 19 T	4cyl. 1870cc	60-85kW (82-116PS)	8
			Diesel	Turbo		TD5044

S40 I 1.9 TD,V40 Estate 1.9 TD		07/95→08/99	D 4192 T	4cyl. 1870cc	66kW (89PS)	9
			Diesel	Turbo		TD5550

08-103400-00	STD	80.00	2.500		008 P PS	KV1
→eng.37920			2.000		005 IFU NT	IKA
[R67490]			3.000		231 CR P	GOE13
08-103500-00	STD	80.00	2.500		001 IF CK P	KV1
08-103507-00	0.50mm		2.000		005 IFU NT	IKA
eng.37921→			3.000		231 CR P	GOE13
[R67500]						

460 L 1.9 Turbo-Diesel			F8Q 768	4cyl. 1870cc	66kW (89PS)	9
			Diesel	Turbo		TD19235

08-105100-00	STD	80.00	2.000		001 IF CK P	KV1
08-105107-00	0.50mm		2.000		005 IFU P	IKA
[R60270]			3.000		231 CR P	STD



340-360 1.7,340-360 Saloon 1.7	08/85→07/91	B 17 2 K	4cyl. 1721cc	60kW (81PS)	10	TD3991
460 L 1.7 480 E 1.7	08/89→07/92 04/86→07/89	B 18 E	4cyl. 1721cc	75kW (102PS)		TD3907
440 K 1.7 460 L 1.7 480 E 1.7	09/88→12/96 08/89→07/92 08/89→07/96	B 18 EP	4cyl. 1721cc	75kW (102PS)		TD3908
440 K 1.7 480 E 1.7	08/88→07/89 08/87→07/89	B 18 F	4cyl. 1721cc	70-75kW (95-102PS)		TD3909
440 K 1.7	08/89→12/96	B 18 FP	4cyl. 1721cc	75kW (102PS)		TD3910
440 K 1.7 Turbo 460 L 1.7 Turbo 480 E 1.7 Turbo	08/88→12/96 08/89→07/96 08/87→07/96	B 18 FT	4cyl. 1721cc Turbo	88kW (120PS)		TD3911
440 K 1.7	09/88→08/89	B 18 K	4cyl. 1721cc	58-60kW (79-82PS)		TD3912
440 K 1.7 460 L 1.7	09/88→12/96 09/88→07/96	B 18 KP	4cyl. 1721cc	64-66kW (87-90PS)		TD3913
08-335100-00 08-335105-00 08-335107-00 [R66260]	STD 0.25mm 0.50mm	81.00	1.750 2.000 3.000	 	001 IF MO P 026 P 712 CR	IKA STD ST
S40 I 1.6 V40 Estate 1.6	09/95→08/99 12/95→08/99	B 4164 S	4cyl. 1587cc	80kW (109PS)	11	TD5549
S40 I 1.9 T4,V40 Estate 1.9 T4	05/97→07/00	B 4194 T	4cyl. 1855cc	147kW (200PS) Turbo Intercooled		TD18003
850 2.0 Turbo 850 Estate 2.0 Turbo C70 I Convertible 2.0 C70 I Coupe 2.0 S70 2.0 V70 I 2.0	09/93→10/96 09/93→10/97 03/98→10/05 03/97→09/02 01/97→11/00 01/97→03/00	B 5204 T2	5cyl. 1984cc	132kW (180PS) Turbo Intercooled		TD5554





C70 I Convertible 2.3 T-5	03/98→10/05	B 5234 T3				
C70 I Coupe 2.3 T-5	03/97→09/02		5cyl.			
S60 T5	11/00→04/10		2319cc	176-184kW (239-250PS)		
S70 2.3	11/96→11/00		Turbo Intercooled			
S70 2.3 T-5	01/97→11/00					
S70 2.3 T5 AWD	11/96→09/98					
V70 I 2.3	11/96→11/00					
V70 I 2.3 AWD	04/97→09/98					
V70 I 2.3 T-5, V70 I 2.3 T-5 AWD	01/97→03/00					
V70 II 2.3 T5	03/00→08/07					TD5401

850 2.3 T5-R, 850 Estate 2.3 T5-R	08/95→12/96	B 5234 T4				
S70 2.3 T5 AWD	07/97→09/00		5cyl.			
V70 II 2.3 T5	03/00→08/07		2319cc	176-184kW (239-250PS)		
			Turbo Intercooled			TD17848

850 2.3 Turbo R	06/95→10/96	B 5234 T5				
850 Estate 2.3 Turbo R	06/95→10/97		5cyl.			
			2319cc	177kW (240PS)		
			Turbo Intercooled			TD19264

S60 2.3 T5	07/00→09/02	B 5234 T7				
S70 2.3	04/99→09/00		5cyl.			
V70 I 2.3 AWD	12/98→02/00		2319cc	195kW (265PS)		
V70 II 2.3, V70 II 2.3 AWD	10/00→09/04		Turbo Intercooled			TD19340

08-102400-00	STD	81.00	1.200		005 NT	ST
[R67510]			1.500		026 P	STD
			2.500		712 CR	ST

S60 2.4 D5	07/01→04/10	D 5244 T				12
S80 I 2.4 D5	08/01→07/06		5cyl.			
S80 II 2.4 D	03/06→		2401cc	120kW (163PS)		
V70 II 2.4 D5	08/01→08/07	Diesel	Turbo Intercooled			
XC70 Cross Country 2.4 D5 XC AWD	09/02→08/07					
XC90 D5	10/02→					TD16325

08-139800-00	STD	81.00	2.000		001 IF CK P	KV1
[R67420]			1.750		005 IFU P	KV1
			3.000		231 CR P	GOE13

850 2.5 TDI, 850 Estate 2.5 TDI	08/95→12/96	D 5252 T				13
S70 2.5 TDI	01/97→11/00		5cyl.			
S70 2.5 TDi AWD	10/99→09/00		2461cc	103kW (140PS)		
S80 I 2.5 TDI	01/99→07/06	Diesel	Turbo Intercooled			
V70 I 2.5 TDI	01/97→05/00					
V70 I 2.5 TDi AWD	11/96→02/00					
V70 II 2.5 TDI	03/00→08/07					TD5145

08-501500-00	STD	81.00	2.500		001 P PS	KV1
08-501507-00	0.50mm		2.000		005 IFU CR P	STD
[R60330]			3.000		231 CR P	STD



440 K 1.8 460 L 1.8	08/91→12/96 08/91→07/96	B 18 U	4cyl. 1794cc	66kW (89PS)	14
					TD3914

440 K 2.0,460 L 2.0 480 E 2.0	08/92→07/96 08/92→09/95	B 20 F	4cyl. 1998cc	80-85kW (108-115PS)	
					TD3924

08-337400-00 01/1993→ [R67580]	STD	82.70	1.500		001 IW P PS	KV1
			1.750		005 IFU P	STD
			3.000		231 CR P	STD

S40 I 1.8,V40 Estate 1.8	07/95→08/99	B 4184 S	4cyl. 1783cc	85kW (116PS)	15
					TD5152

S40 I 2.0 V40 Estate 2.0	07/95→12/03 07/95→06/04	B 4204 S	4cyl. 1948cc	100kW (136PS)	
					TD5153

S40 I 2.0 T V40 Estate 2.0 T	10/97→12/03 10/97→07/00	B 4204 T	4cyl. 1948cc	118kW (160PS) Turbo Intercooled	
					TD11287

850 2.4 GLE,850 Estate 2.4 GLE 850 Estate 2.5 AWD C70 I Convertible 2.5 T C70 I Coupe 2.5 T S70 2.4 T5 AWD S70 2.4 Turbo V70 I 2.4 Turbo V70 I 2.5 Turbo AWD XC70 Cross Country 2.4 T XC AWD	09/93→10/97 04/96→12/96 03/98→10/05 03/97→09/02 11/96→04/99 01/97→11/00 01/97→03/00 01/97→05/00 11/97→09/02	B 5254 T	5cyl. 2435cc	142-154kW (193-210PS) Turbo Intercooled	
					TD9366

08-102500-00 [R67530]	STD	83.00	1.200		005 NT	ST
			1.500		026 P	STD
			2.500		712 CR	ST



850 2.5 850 Estate 2.5	06/91→07/94 08/92→07/94	B 5252	5cyl. 2435cc	105kW (143PS)	16
TD5144					
850 2.4 i S70 2.5 i V70 2.5 i	09/92→08/97 01/97→07/99 01/97→03/00	B 5252 S	5cyl. 2435cc	103-106kW (140-144PS)	16
TD5146					
960 2.9,960 Kombi 2.9	08/90→07/94	B 6304 F	6cyl. 2922cc	150kW (204PS)	16
TD5042					
S90 2.9 V90 Estate 2.9	01/97→05/98 01/97→12/98	B 6304 G	6cyl. 2922cc	150kW (204PS)	16
TD5042					

08-502100-00 08-502107-00	STD 0.50mm	83.00	1.500 1.750 3.000	 	001 CR P 026 P 236 P	KV1 STD STD
<i>[R67540]</i>						

C30 2.0 D C70 II Convertible 2.0 D S40 II 2.0 D S80 II 2.0 TDi V50 2.0 D V70 III 2.0 D	10/06→12/12 01/08→ 01/04→ 02/08→ 04/04→ 10/07→	D 4204 T	4cyl. 1998cc	100kW (136PS)	17	
TD18993						
08-114700-00 08-114708-00	STD 0.60mm	85.00	3.500 2.000 3.000	 	008 CK P 005 IFU P 231 CR P	KV1 STD STD
<i>[R60410]</i>						

C30 2.0 S40 II 2.0 S80 II 2.0 V50 2.0 V70 III 2.0	10/06→12/12 10/06→ 01/08→ 10/06→ 10/07→	B 4204 S3	4cyl. 1999cc	107kW (146PS)	18
TD19659					



08-423400-00 08-423407-00	STD 0.50mm	87.50	1.200 1.200 2.500	 	001 CR P 026 P 712 CR	ST STD ST
------------------------------	---------------	--------------	-------------------------	----------	-----------------------------	-----------------





260 2.7		08/76→07/82	B 27 A						
260 Estate 2.7		08/75→07/77		V6cyl.					19
				2664cc	92kW (125PS)				TD3958
240 2.7 GLT6,240 Kombi 2.7 GLT6		08/79→07/80	B 27 E						
260 2.7		08/74→07/82		V6cyl.					
260 Coupe 2.7		08/77→07/78		2664cc	103-109kW (140-148PS)				
260 Estate 2.7		07/75→07/82							TD3959
260 Estate 2.7		10/78→07/82	B 27 F						
				V6cyl.					
				2664cc	109kW (148PS)				TD3960
08-316900-00	STD	88.00	1.500		001 IF CR P				IKA
08-316907-00	0.50mm		2.000		026 P				STD
[R66110]			4.000		712 CR				ST
240 2.0		08/76→08/83	B 19 A						
240 Kombi 2.0		08/76→12/84		4cyl.					20
340-360 2.0		08/80→07/84		1986cc	65-71kW (88-97PS)				
340-360 Saloon 2.0		08/82→07/84							TD3915
240 2.0		09/88→12/93	B 19 E						
340-360 2.0		08/82→07/84		4cyl.					
340-360 Saloon 2.0		08/83→07/84		1986cc	83-86kW (113-117PS)				
740 2.0 GLE		04/83→07/84							TD3916
08-406300-10	STD	88.90	1.750		001 IW CR P				KV1
08-406306-10	.015		2.000		026 P				STD
08-406309-10	.030		4.000		712 CR				ST
[R34146]									
140 2.0,140 Estate 2.0 S		08/68→07/74	B 20 A						
240 2.0		08/74→07/76		4cyl.					21
240 Kombi 2.0		08/74→07/75		1998cc	60kW (81PS)				
P 121 2.0		11/68→05/71							TD3919
140 2.0 S		11/68→09/72	B 20 B						
140 Estate 2.0 S		08/72→07/74		4cyl.					
P 122 S Amazon 2.0		11/68→05/71		1998cc	73-74kW (100-101PS)				TD3920
140 2.0		09/70→04/75	B 20 E						
140 Estate 2.0 S		08/72→07/73		4cyl.					
P 1800 2.0 ES		04/72→11/73		1998cc	91kW (124PS)				TD3922
164 2.9 E		08/68→07/73	B 30 A						
				6cyl.					
				2979cc	96kW (131PS)				TD3967
164 2.9		08/72→07/74	B 30 E						
				6cyl.					
				2979cc	118kW (160PS)				TD3968
08-406900-10	STD	88.90	2.000		001 IF CR P				IKA
[R40100]			2.000		005 IF				STD
			4.747		231				STD



240 2.0	09/84→12/93	B 200 E				22
240 Kombi 2.0	08/83→07/93		4cyl.			
340-360 2.0	08/84→07/88		1986cc	82-87kW (112-118PS)		
340-360 Saloon 2.0	08/84→07/86					
740 2.0	01/87→08/88					
740 Kombi 2.0	08/85→07/92					
940 2.0	09/90→09/93				TD3925	
240 2.0, 240 Kombi 2.0	09/88→12/93	B 200 F				
340-360 2.0	08/86→07/89		4cyl.			
340-360 Saloon 2.0	08/88→07/89		1986cc	82kW (111PS)		
740 2.0	09/90→08/92					
740 Kombi 2.0	08/89→07/91					
940 2.0, 940 Kombi 2.0	01/92→07/94					
960 2.0	09/90→09/93					TD3927
740 2.0, 740 Kombi 2.0	08/85→07/92	B 200 G				
940 2.0	09/90→09/93		4cyl.			
940 II 2.0, 940 II Estate 2.0	11/94→12/95		1986cc	80-89kW (109-121PS)		
940 Kombi 2.0	09/90→09/93					TD3929
240 2.0, 240 Kombi 2.0	08/84→07/85	B 200 K				
340-360 2.0	08/80→07/87		4cyl.			
340-360 Saloon 2.0	08/84→07/90		1986cc	70-77kW (95-105PS)		
740 2.0, 740 Kombi 2.0	09/88→08/90					TD3930
360 2.0 i	08/84→07/89	B 200 KE				
440 2.0 i	08/84→07/89		4cyl.			
			1986cc	84-86kW (114-117PS)		
						TD21328

08-408500-00	STD	88.90	1.750		001 CR P	KV1
<i>[R34176]</i>			1.750		026 P	STD
			3.500		712 CR	ST

740 2.0	01/85→08/90	B 200 ET				23
740 Kombi 2.0 Turbo	05/85→08/90		4cyl.	1986cc	118kW (160PS)	
					Turbo Intercooled	TD3926
740 2.0 Turbo, 740 Kombi 2.0 Turbo	09/90→08/91	B 200 FT				
940 2.0 Turbo	08/90→12/94		4cyl.			
940 II 2.0 Turbo, 940 II Estate 2.0 Turbo	04/96→10/98		1986cc	105-114kW (143-155PS)		
940 Kombi 2.0 Turbo	01/91→07/95			Turbo Intercooled		TD3928
940 2.0	09/90→09/93	B 204 FT				
940 II 2.0, 940 II Estate 2.0	10/94→05/97		4cyl.			
960 2.0, 960 Kombi 2.0	08/90→09/93		1986cc	147kW (200PS)		
				Turbo Intercooled		TD3932

08-408400-00	STD	88.90	1.750		001 MOL P	KV1
			1.750		026 P	STD
			3.500		712 CR	ST



240 2.8			10/82→09/84	B 28 E				24
240 Kombi 2.8			10/80→09/82		V6cyl.			
260 2.8			08/80→07/82		2849cc	108-114kW (147-155PS)		
760 2.8			08/81→07/88					
760 Kombi 2.8			08/86→08/90				TD3963	

08-408800-00	STD	91.00	1.500		001 IF CR P		IKA
			2.000		026 P		STD
			4.000		712 CR		ST

240 2.1,240 Kombi 2.1			08/74→07/84	B 21 A				25
					4cyl.	2127cc	71-80kW (97-108PS)	
								TD3934

240 2.1			08/74→07/80	B 21 E				25
240 Kombi 2.1			08/74→07/79		4cyl.			
340-360 2.1			08/81→07/82		2127cc	90kW (122PS)		
								TD3935

08-399000-10	STD	92.00	2.000		001 IW CR P		KV1
			2.000		026 P		STD
			4.000		231 CR P		STD
08-399007-10 01/1974→	0.50mm	92.00	2.000		001 IW CR P		KV1
			2.000		026 P		STD
			4.000		231 CR P		STD
			4.000		712 CR		ST
08-407600-10 08-407605-10 08-407607-10 08-407611-10 01/1979→	STD	92.00	1.750		001 IW CR P		KV1
			2.000		026 P		STD
			4.000		712 CR		ST
			4.000		712 CR		ST

[R34136]

240 2.3,240 Kombi 2.3,740 2.3			08/84→07/86	B 230 A				26
740 Kombi 2.3			08/85→07/86		4cyl.	2316cc	81-86kW (110-117PS)	
								TD3945

240 2.3			08/86→07/87	B 230 F				26
240 2.3 i CAT			08/86→07/93		4cyl.			
240 Kombi 2.3			08/86→07/87		2316cc	81-100kW (110-136PS)		
240 Kombi 2.3 CAT			08/91→07/92					
240 Kombi 2.3 i CAT			08/86→07/93					
740 2.3			08/84→07/92					
740 Kombi 2.3			08/85→07/92				TD3948	

740 2.3			08/88→07/90	B 230 FB				26
740 Kombi 2.3			08/89→07/90		4cyl.			
940 2.3			08/90→12/94		2316cc	96kW (131PS)		
940 II 2.3,940 II Estate 2.3			08/94→10/98					
940 Kombi 2.3			08/90→12/94				TD5157	

240 2.3,240 Kombi 2.3			08/86→12/88	B 230 K				26
740 2.3			08/86→07/88		4cyl.			
740 Kombi 2.3			09/85→07/90		2316cc	85kW (116PS)		
760 2.3,760 Kombi 2.3			08/84→08/87				TD3955	





740 2.3,740 Kombi 2.3	08/87→08/92	B 234 F	4cyl.			
940 2.3,940 Kombi 2.3	08/90→07/91		2316cc	111-117kW (151-159PS)		TD3956

08-408100-00	STD	96.00	1.750		001 CR P	KV1
08-408108-00	0.60mm		1.750		026 P	STD
[R34166]			3.500		712 CR	ST

240 2.3	08/83→07/85	B 230 E	4cyl.			27
240 Kombi 2.3	08/84→07/85		2316cc	96-98kW (131-133PS)		
740 2.3	08/84→07/88					
740 Kombi 2.3	08/85→07/88					
740 Kombi 2.3 GL	08/84→08/87					
940 2.3	08/90→12/94					TD5038

08-407700-10	STD	96.00	1.750		001 IW CR P	KV1
08-407708-10	0.60mm		2.000		026 P	STD
08-407722-10	0.30mm		4.000		712 CR	ST
[R34156]						

740 2.3 Turbo	08/85→12/88	B 230 ET	4cyl.			28
740 Kombi 2.3 Turbo	08/85→07/88		2316cc	134kW (182PS)		
760 2.3	08/84→08/87			Turbo Intercooled		
760 2.3 Turbo	08/84→10/88					
760 Kombi 2.3 Turbo	08/84→08/90					TD3947

740 2.3 Turbo,740 Kombi 2.3 Turbo	08/86→08/91	B 230 FT	4cyl.			
760 2.3	01/88→07/92		2316cc	115-151kW (156-205PS)		
760 2.3 Turbo,760 Kombi 2.3 Turbo	09/87→08/90		Turbo			
940 2.3	09/90→09/93					
940 2.3 Turbo	08/90→07/94					
940 II 2.3 Turbo	08/94→12/98					
940 II Estate 2.3 Turbo	08/94→10/98					
940 Kombi 2.3 Turbo	08/90→07/94					
960 2.3 Turbo,960 Kombi 2.3 Turbo	09/90→08/93					TD3950

740 Kombi 2.3 Turbo	08/89→07/90	B 230 GT	4cyl.			
			2316cc	121kW (165PS)		
			Turbo Intercooled			TD5039

08-408200-00	STD	96.00	1.750		001 MOL P	KV1
			1.750		026 P	STD
			3.500		712 CR	ST

ENGINE INDEX

Motorverzeichnis • Index de moteur • Índice de Motor
Indeks silnika • Модель двигателя • دليل المحرك



CCM

x



9

4.236	Diesel	3866	4	98.48	8
15W37 WB15 (Air Compressor)			2	75.00	1
D 7 B260 Euro 2	Diesel	6730	6	104.775	10
D 16A	Diesel	16123	6	144.00	32
D 50 A	Diesel	5100	6	95.25	5
D 50 B	Diesel	5100	6	95.25	5
D 60	Diesel	5480	6	98.43	6
D 67	Diesel	6730	6	104.775	9
D 67 A	Diesel	6730	6	104.775	9
D 67 C	Diesel	6730	6	104.775	9
D 70 A	Diesel	6730	6	104.775	9
D 70 B	Diesel	6730	6	104.775	9
D 100 A	Diesel	9600	6	120.65	20
D 100 B	Diesel	9600	6	120.65	20
D6A180 Euro 3	Diesel	5480	6	98.43	7
D6A210 Euro 3	Diesel	5480	6	98.43	7
D6A230 Euro 3	Diesel	5480	6	98.43	7
D6A250 Euro 3	Diesel	5480	6	98.43	7
D6AHP Euro 2	Diesel	5480	6	98.43	7
D6ALP Euro 2	Diesel	5480	6	98.43	7
D6B Euro 3	Diesel	5480	6	98.43	7
D7A285 Euro 2	Diesel	6730	6	104.775	10
D7B230 Euro 2	Diesel	6730	6	104.775	10
D7B260 Euro 2	Diesel	6730	6	104.775	10
D7C215 Euro 2	Diesel	7300	6	107.00	15
D7C250 Euro 2	Diesel	7300	6	107.00	15
D7C290 Euro 2	Diesel	7300	6	107.00	15
D7C310 Euro 2	Diesel	7300	6	107.00	15
D7E240 Euro 4	Diesel	7100	6	108.00	16
D7E280 Euro 4	Diesel	7100	6	108.00	16
D7E290 Euro 4	Diesel	7100	6	108.00	16
D7E320 Euro 4	Diesel	7100	6	108.00	16
D9A260 Euro 3	Diesel	9364	6	120.00	18
D9A300 Euro 3	Diesel	9364	6	120.00	18
D9A340 Euro 3	Diesel	9364	6	120.00	18
D9A380 Euro 3	Diesel	9364	6	120.00	18
D9B260 Euro 4/5	Diesel	9364	6	120.01	19
D9B300 Euro 4	Diesel	9364	6	120.01	19
D9B310 Euro 4/5	Diesel	9364	6	120.01	19
D9B340 Euro 4	Diesel	9364	6	120.01	19
D9B360 Euro 4/5	Diesel	9364	6	120.01	19
D9B380 Euro 4	Diesel	9364	6	120.01	19
D11C330 Euro 5	Diesel	10800	6	123.00	27
D11C370 Euro 5	Diesel	10800	6	123.00	27
D11C410 Euro 5	Diesel	10800	6	123.00	27
D12A340 Euro 2	Diesel	12100	6	131.00	30
D12A380 Euro 2	Diesel	12110	6	131.00	30
D12A420 Euro 2	Diesel	12100	6	131.00	30
D12C340 Euro 2	Diesel	12100	6	131.00	30
D12C380	Diesel	12100	6	131.00	30
D12C420	Diesel	12100	6	131.00	30
D12C460	Diesel	12100	6	131.00	30
D12D340 Euro 3	Diesel	12100	6	131.00	30
D12D380 Euro 3	Diesel	12100	6	131.00	30
D12D420 Euro 3	Diesel	12100	6	131.00	30
D12D460 Euro 3	Diesel	12100	6	131.00	30
D12D500 Euro 3	Diesel	12100	6	131.00	30
D13A360 Euro 5	Diesel	12800	6	131.00	31
D13A400 Euro 5	Diesel	12800	6	131.00	31
D13A440 Euro 5	Diesel	12800	6	131.00	31

Motorverzeichnis • Index de moteur • Índice de Motor
Indeks silnika • Модель двигателя • دليل المحرك

ENGINE INDEX



CCM

x



9

D13A480 Euro 5	Diesel	12800	6	131.00	31
D13A520 Euro 5	Diesel	12800	6	131.00	31
D13C380 Euro 5	Diesel	12800	6	131.00	31
D13C420 Euro 5	Diesel	12800	6	131.00	31
D13C460 Euro 5	Diesel	12800	6	131.00	31
D13C500 Euro 5	Diesel	12800	6	131.00	31
D13C540 Euro 5	Diesel	12800	6	131.00	31
D16A470 Euro 2	Diesel	16120	6	144.00	32
D16A520	Diesel	16120	6	144.00	32
D16B520	Diesel	16120	6	144.00	32
D42	Diesel	4200	4	105.57	14
D45	Diesel	4500	4	105.57	14
D60	Diesel	5480	6	98.43	6
D100BHC	Diesel	9600	6	120.65	20
D100BRC	Diesel	9600	6	120.65	20
D1051	Diesel	1120	1	104.775	9
D1052	Diesel	2240	2	104.775	9
D1053	Diesel	3360	3	104.775	9
D1054	Diesel	4480	4	104.775	9
D1113	Diesel	3780	3	111.12	17
D1114	Diesel	5040	4	111.12	17
DH10A Euro 2	Diesel	9600	6	120.65	21
DH12D420 Euro 3	Diesel	12100	6	131.00	30
HD 100 A	Diesel	9600	6	120.65	20
HD 100 D	Diesel	9600	6	120.65	20
MD 1B	Diesel	560	1	88.90	2
MD 2B	Diesel	1120	2	88.90	2
MD 3B	Diesel	1680	3	88.90	2
MD 11C	Diesel	1120	2	88.90	2
MD 17C	Diesel	1680	3	88.90	2
MD 21A	Diesel	2112	4	90.00	3
MD 32A	Diesel	3168	6	90.00	3
MD 40	Diesel	3600	6	92.00	4
MD 70	Diesel	6730	6	104.775	11
MD 100A	Diesel	9600	6	120.65	20
MD 100B	Diesel	9600	6	120.65	20
TAMD 40	Diesel	3600	6	92.00	4
TAMD 70	Diesel	6730	6	104.775	11
TAMD 71	Diesel	6730	6	104.775	11
TAMD 120 A	Diesel	11977	6	130.175	28
TAMD 120 B	Diesel	11977	6	130.175	28
TAMD 121	Diesel	11975	6	130.175	28
TD 40 A	Diesel	3590	6	92.00	4
TD 41	Diesel	3600	6	92.00	4
TD 42	Diesel	4200	4	105.57	14
TD 45	Diesel	4500	4	105.57	14
TD 50 A	Diesel	5100	6	95.25	5
TD 50 B	Diesel	5100	6	95.25	5
TD 60 A	Diesel	5480	6	98.43	6
TD 60 B	Diesel	5480	6	98.43	6
TD 60 C	Diesel	5480	6	98.43	6
TD 60 D	Diesel	5480	6	98.43	6
TD 60 DG	Diesel	5480	6	98.43	6
TD 61 B	Diesel	5480	6	98.43	6
TD 61 F	Diesel	5480	6	98.43	6
TD 61 FB	Diesel	5480	6	98.43	6
TD 61 G	Diesel	5480	6	98.43	6
TD 61 GA	Diesel	5480	6	98.43	6
TD 61 GB	Diesel	5480	6	98.43	6
TD 61 GC	Diesel	5480	6	98.43	6

ENGINE INDEX

Motorverzeichnis • Index de moteur • Índice de Motor
Indeks silnika • Модель двигателя • دليل المحرك



CCM

x



9

TD 61 GE	Diesel	5480	6	98.43	6
TD 61 GS	Diesel	5480	6	98.43	6
TD 63 E	Diesel	5480	6	98.43	7
TD 63 ES	Diesel	5480	6	98.43	7
TD 70 A	Diesel	6730	6	104.775	11
TD 70 B	Diesel	6730	6	104.775	11
TD 70 C	Diesel	6730	6	104.775	11
TD 70 CHC	Diesel	6730	6	104.775	11
TD 70 CR C	Diesel	6730	6	104.775	11
TD 70 E	Diesel	6730	6	104.775	11
TD 70 F	Diesel	6730	6	104.775	11
TD 70 FS	Diesel	6730	6	104.775	11
TD 70 G	Diesel	6730	6	104.775	11
TD 70 H	Diesel	6730	6	104.775	11
TD 71 A	Diesel	6730	6	104.775	11
TD 71 ACE	Diesel	6730	6	104.775	12
TD 71 AG	Diesel	6730	6	104.775	12
TD 71 AGP	Diesel	6730	6	104.775	12
TD 71 AP	Diesel	6730	6	104.775	12
TD 71 APB	Diesel	6730	6	104.775	12
TD 71 AW	Diesel	6730	6	104.775	12
TD 71 E	Diesel	6730	6	104.775	12
TD 71 F	Diesel	6730	6	104.775	12
TD 71 FA	Diesel	6730	6	104.775	12
TD 71 FC	Diesel	6730	6	104.775	12
TD 71 FD	Diesel	6730	6	104.775	12
TD 71 FQ	Diesel	6730	6	104.775	12
TD 71 FS	Diesel	6730	6	104.775	12
TD 71 FSO	Diesel	6730	6	104.775	12
TD 71 FSQ	Diesel	6730	6	104.775	12
TD 71 G	Diesel	6730	6	104.775	12
TD 73 E Euro 1	Diesel	6730	6	104.775	13
TD 73 EA	Diesel	6730	6	104.775	13
TD 73 EB	Diesel	6730	6	104.775	13
TD 73 ES	Diesel	6730	6	104.775	13
TD 100 A	Diesel	9600	6	120.65	20
TD 100 AHC	Diesel	9600	6	120.65	20
TD 100 ARC	Diesel	9600	6	120.65	20
TD 100 B	Diesel	9600	6	120.65	22
TD 100 CHC	Diesel	9600	6	120.65	22
TD 100 F	Diesel	9600	6	120.65	22
TD 100 G	Diesel	9600	6	120.65	22
TD 100 GA	Diesel	9600	6	120.65	22
TD 100 GB	Diesel	9600	6	120.65	22
TD 100 GG	Diesel	9600	6	120.65	22
TD 101	Diesel	9599	6	120.65	22
TD 101 F	Diesel	9600	6	120.65	22
TD 101 FA	Diesel	9600	6	120.65	22
TD 101 FC	Diesel	9600	6	120.65	22
TD 101 FD	Diesel	9600	6	120.65	22
TD 101 G	Diesel	9600	6	120.65	22
TD 101 GA	Diesel	9600	6	120.65	22
TD 102 F	Diesel	9600	6	120.65	23
TD 102 FAQ	Diesel	9600	6	120.65	23
TD 102 FBQ	Diesel	9600	6	120.65	23
TD 102 FCQ	Diesel	9600	6	120.65	23
TD 102 FD Euro 1	Diesel	9600	6	120.65	23
TD 102 FDQ	Diesel	9600	6	120.65	23
TD 102 FEQ	Diesel	9600	6	120.65	23
TD 102 FF	Diesel	9600	6	120.65	24

Motorverzeichnis • Index de moteur • Índice de Motor
Indeks silnika • Модель двигателя • دليل المحرك

ENGINE INDEX



CCM

x



9

TD 102 FGQ	Diesel	9600	6	120.65	23
TD 102 FH	Diesel	9600	6	120.65	24
TD 102 FL Euro 1	Diesel	9600	6	120.65	24
TD 102 FM	Diesel	9600	6	120.65	24
TD 102 FS	Diesel	9600	6	120.65	23
TD 102 FT	Diesel	9595	6	120.65	23
TD 103	Diesel	9599	6	120.65	25
TD 103 D10 Euro 2	Diesel	9600	6	120.65	21
TD 103 E	Diesel	9600	6	120.65	25
TD 103 EA Euro 1	Diesel	9600	6	120.65	25
TD 103 ES Euro 1	Diesel	9600	6	120.65	25
TD 103 KBE Euro 1	Diesel	9600	6	120.65	25
TD 103 KF Euro 1	Diesel	9600	6	120.65	25
TD 120 A	Diesel	12000	6	130.175	28
TD 120 C	Diesel	12000	6	130.175	28
TD 120 D	Diesel	11980	6	130.175	28
TD 120 F	Diesel	11980	6	130.175	28
TD 120 FC	Diesel	11980	6	130.175	28
TD 120 G	Diesel	11980	6	130.175	28
TD 120 GA	Diesel	11980	6	130.175	28
TD 120 GG	Diesel	11977	6	130.175	28
TD 121	Diesel	11977	6	130.175	28
TD 121 F	Diesel	11980	6	130.175	28
TD 121 FD	Diesel	11980	6	130.175	28
TD 121 G	Diesel	11980	6	130.175	28
TD 121 GD	Diesel	11980	6	130.175	28
TD 122	Diesel	11980	6	130.175	28
TD 122 F	Diesel	11980	6	130.175	28
TD 122 FA	Diesel	11980	6	130.175	28
TD 122 FH Euro 1	Diesel	11980	6	130.175	28
TD 122 FK	Diesel	11980	6	130.175	28
TD 122 FL	Diesel	11980	6	130.175	28
TD 122 FR	Diesel	11980	6	130.175	28
TD 122 FS	Diesel	11980	6	130.175	28
TD 123	Diesel	11977	6	130.175	29
TD 161	Diesel		6	144.00	33
TD 162 F	Diesel	16123	6	144.00	33
TD 162 FL	Diesel	16120	6	144.00	33
TD 162 FS	Diesel	16123	6	144.00	33
TD 163	Diesel	16120	6	144.00	34
TD 163 ES	Diesel	16123	6	144.00	34
TD67 C	Diesel	6730	6	104.775	9
THD 100 A	Diesel	9600	6	120.65	20
THD 100 D	Diesel	9600	6	120.65	20
THD 100 DB	Diesel	9600	6	120.65	22
THD 100 DC	Diesel	9600	6	120.65	22
THD 100 DD	Diesel	9600	6	120.65	22
THD 100 E	Diesel	9600	6	120.65	22
THD 100 EA	Diesel	9600	6	120.65	22
THD 100 EB	Diesel	9600	6	120.65	22
THD 100 EC	Diesel	9600	6	120.65	22
THD 100 ED	Diesel	9600	6	120.65	22
THD 100 EE	Diesel	9600	6	120.65	22
THD 100 EK	Diesel	9600	6	120.65	22
THD 101	Diesel	9599	6	120.65	22
THD 101 B	Diesel	9600	6	120.65	20
THD 101 G	Diesel	9600	6	120.65	22
THD 101 GB	Diesel	9600	6	120.65	22
THD 101 GC	Diesel	9600	6	120.65	22
THD 101 GD	Diesel	9600	6	120.65	22

ENGINE INDEX

Motorverzeichnis • Index de moteur • Índice de Motor
Indeks silnika • Модель двигателя • دليل المحرك



CCM

x



9

THD 101 KB	Diesel	9600	6	120.65	22
THD 101 KC	Diesel	9600	6	120.65	22
THD 101 KE	Diesel	9600	6	120.65	22
THD 101 KF	Diesel	9600	6	120.65	22
THD 102 KA	Diesel	9600	6	120.65	26
THD 102 KB Euro 1	Diesel	9600	6	120.65	26
THD 102 KD	Diesel	9600	6	120.65	26
THD 102 KF	Diesel	9600	6	120.65	26
THD 102 KJ	Diesel	9600	6	120.65	26
THD 103 KB	Diesel	9600	6	120.65	25
THD 103 KD	Diesel	9600	6	120.65	25
TID 61	Diesel	5480	6	98.43	6
TID 100	Diesel	9600	6	120.65	22
TID 120 F	Diesel	11977	6	130.175	28
TID 121 B	Diesel	11979	6	130.175	29
TID 121 KG	Diesel	11979	6	130.175	29
TID 121 KP	Diesel	11979	6	130.175	29
TID 121 LG	Diesel	11979	6	130.175	29
TID 121 LP	Diesel	11979	6	130.175	29
TID 121 P	Diesel	11979	6	130.175	29
TMD 40	Diesel	3600	6	92.00	4
TMD 70	Diesel	6730	6	104.775	11
TMD 100 A	Diesel	9600	6	120.65	20
TMD 120 A	Diesel	11977	6	130.175	28
TWD 121 G	Diesel	11979	6	130.175	29



1

15W37 WB15 (Air Compressor)		2cyl.					FM1846
08-990700-00	STD	75.00	2.385		005 P		STD
08-990705-00	0.25mm				026 P		STD
08-990707-00	0.50mm		2.385		032 P		STD
[R32840]			3.947				

2

MD 11C		2cyl.	1120cc	17-18kW (23-25PS)	Diesel		FM6253
MD 17C		3cyl.	1680cc	28kW (36PS)	Diesel		FM6255
MD 1B		1cyl.	560cc	8kW (10PS)	Diesel		FM6251
MD 2B		2cyl.	1120cc	19kW (26PS)	Diesel		FM6252
MD 3B		3cyl.	1680cc	26kW (35PS)	Diesel		FM6254
08-405900-00	STD	88.90	2.000		001 CR P		KV1
			2.000		005 IF		STD
			2.000		026		STD
			5.000		231		STD





3

MD 21A		4cyl.	2112cc		Diesel		FM6238
MD 32A		6cyl.	3168cc	78kW (106PS)	Diesel		FM6256
08-314900-10	STD	90.00	2.000		001 IW CR P		KV1
[R66070]			2.000		001 P		STD
			2.000		023 P		STD
			4.500		231 CR P		STD



4

MD 40		6cyl.	3600cc	30-59kW (42-85PS)	Diesel		FM6257
TAMD 40		6cyl.	3600cc	114kW (155PS)	Diesel Turbo Intercooled		FM6259
TD 40 A		6cyl.	3590cc	80-88kW (110-125PS)	Diesel Turbo		TD9145
TD 41		6cyl.	3600cc		Diesel Turbo		FM6219
TMD 40		6cyl.	3600cc	67-100kW (91-136PS)	Diesel		FM6258
08-409400-00	STD	92.00	2.500		008 MO P		KV1
			2.500		005 IW MO P		STD
			4.000		231 CR P		STD

5

D 50 A	6cyl.	5100cc	79kW (107PS)	Diesel		TD9126
D 50 B	6cyl.	5100cc	86kW (117PS)	Diesel		TD9202
TD 50 A	6cyl.	5100cc	108kW (147PS)	Diesel	Turbo	TD9127
TD 50 B	6cyl.	5100cc	121kW (165PS)	Diesel	Turbo	TD9207
08-399400-10	STD	95.25	2.385		001 IF CR P	KV1
[R43880]			3.160		001 IF MO P	STD
			3.160		005 P	STD
			4.747		231 CR P	STD



6

D 60	6cyl.	5480cc	88kW (120PS)	Diesel		TD9146
D60	6cyl.	5480cc	89kW (121PS)	Diesel		FM3150
TD 60 A	6cyl.	5480cc	132kW (180PS)	Diesel	Turbo	TD9095
TD 60 B	6cyl.	5480cc	128-132kW (174-180PS)	Diesel	Turbo	TD9096
TD 60 C	6cyl.	5480cc	108-113kW (147-154PS)	Diesel	Turbo	TD9147
TD 60 D	6cyl.	5480cc	108-113kW (147-154PS)	Diesel	Turbo Intercooled	TD23336
TD 60 DG	6cyl.	5480cc	108-113kW (147-154PS)	Diesel	Turbo Intercooled	TD23337
TD 61 B	6cyl.	5480cc	132kW (180PS)	Diesel	Turbo	FM5040
TD 61 F	6cyl.	5480cc	150-152kW (204-207PS)	Diesel	Turbo Intercooled	TD9225
TD 61 FB	6cyl.	5480cc	153kW (208PS)	Diesel	Turbo Intercooled	TD9211
TD 61 G	6cyl.	5480cc	108-152kW (147-207PS)	Diesel	Turbo Intercooled	TD9221
TD 61 GA	6cyl.	5480cc	112kW (152PS)	Diesel	Turbo	TD9222
TD 61 GB	6cyl.	5480cc	131-132kW (179-180PS)	Diesel	Turbo	TD6249
TD 61 GC	6cyl.	5480cc	132kW (180PS)	Diesel	Turbo	TD9226
TD 61 GE	6cyl.	5480cc	130kW (177PS)	Diesel	Turbo	TD9210
TD 61 GS	6cyl.	5480cc	131-132kW (179-180PS)	Diesel	Turbo	TD5902
TID 61	6cyl.	5480cc	150kW (204PS)	Diesel	Turbo Intercooled	FM6260
08-405500-10	STD	98.43	2.385		001 CR P	KV1
[R43480]			3.160		005 IF P	STD
			4.747		231 CR P	STD











7

D6A180 Euro 3	6cyl.	5480cc	132kW (180PS)	Diesel	Turbo Intercooled	TD9219
D6A210 Euro 3	6cyl.	5480cc	154kW (210PS)	Diesel	Turbo Intercooled	TD9220
D6A230 Euro 3	6cyl.	5480cc	169kW (230PS)	Diesel	Turbo Intercooled	TD9227
D6A250 Euro 3	6cyl.	5480cc	184kW (250PS)	Diesel	Turbo Intercooled	TD9228
D6AHP Euro 2	6cyl.	5480cc		Diesel		FM18640
D6ALP Euro 2	6cyl.	5480cc		Diesel		FM8640
D6B Euro 3	6cyl.	5480cc	132-184kW (180-250PS)	Diesel	Turbo Intercooled	TD17367
TD 63 E	6cyl.	5480cc	132kW (180PS)	Diesel	Turbo Intercooled	TD9223
TD 63 ES	6cyl.	5480cc	154kW (210PS)	Diesel	Turbo Intercooled	TD9224

08-142500-00	STD	98.43	3.500		008 IF MOL	KV1
<i>[R45750]</i>			2.500		005 IF	F12/F14
			3.500		231 CR	STD

8

4.236			4cyl.	3866cc	Diesel	FM1360
08-107200-00	STD	98.48	2.385		001 IF CR P	STD
08-107209-00	.030		2.385		001 IF P	STD
<i>[R34760K]</i>			2.385		023 P	STD
			6.335		231 CR P	STD
			6.335		031 P	STD
08-318900-10	STD	98.48	2.385		001 IF CR P	KV1
08-318905-10	0.25mm		2.385		005 IW P	STD
<i>[R34740/2K]</i>			4.747		231 CR P	STD



9

D 67	6cyl.	6730cc	84kW (114PS)	Diesel	TD9139
D 67 A	6cyl.	6730cc	84kW (114PS)	Diesel	TD9244
D 67 C	6cyl.	6730cc	92kW (125PS)	Diesel	TD9247
D 70 A	6cyl.	6730cc	106kW (144PS)	Diesel	TD9128
D 70 B	6cyl.	6730cc	110kW (150PS)	Diesel	TD9129
D1051	1cyl.	1120cc	9kW (12PS)	Diesel	FM6241
D1052	2cyl.	2240cc	22kW (30PS)	Diesel	FM6242
D1053	3cyl.	3360cc	32kW (44PS)	Diesel	FM6243
D1054	4cyl.	4480cc	42kW (57PS)	Diesel	FM6244
TD67 C	6cyl.	6730cc		Diesel	FM5584

08-392000-10	STD	104.775	2.385		001 IF CR P	IKA
08-392005-10	0.25mm		3.160		001 P	STD
<i>[R43870]</i>			3.160		023 P	STD
			4.747		231 CR P	STD
			4.747		030 P	STD





10

D 7 B260 Euro 2	6cyl.	6730cc	191kW (260PS)	Diesel	Turbo Intercooled	TD9231
D7A285 Euro 2	6cyl.	6730cc	210kW (286PS)	Diesel	Turbo Intercooled	TD9229
D7B230 Euro 2	6cyl.	6730cc	169kW (230PS)	Diesel	Turbo Intercooled	TD9242
D7B260 Euro 2	6cyl.	6730cc	191kW (260PS)	Diesel	Turbo Intercooled	TD9243



08-142800-00	STD	104.775	3.500		008 IF CK P	KV1
			2.500		005 IFU P	F12/F14
			3.500		231 CR P	STD



11

MD 70	6cyl.	6730cc	102-106kW (139-145PS)	Diesel		FM6261
TAMD 70	6cyl.	6730cc	206kW (280PS)	Diesel	Turbo	FM6263
TAMD 71	6cyl.	6730cc	163-262kW (222-357PS)	Diesel	Turbo Intercooled	FM6264
TD 70 A	6cyl.	6730cc	136kW (185PS)	Diesel	Turbo	TD9131
TD 70 B	6cyl.	6730cc	152kW (207PS)	Diesel	Turbo	TD9132
TD 70 C	6cyl.	6730cc	149-152kW (202-207PS)	Diesel	Turbo	TD9208
TD 70 CHC	6cyl.	6730cc		Diesel	Turbo	FM5110
TD 70 CR C	6cyl.	6730cc		Diesel	Turbo	FM5111
TD 70 E	6cyl.	6730cc	154kW (210PS)	Diesel	Turbo	TD9133
TD 70 F	6cyl.	6730cc	162-174kW (220-237PS)	Diesel	Turbo	TD9148
TD 70 FS	6cyl.	6730cc	180kW (245PS)	Diesel	Turbo	TD9150
TD 70 G	6cyl.	6730cc	147-156kW (200-212PS)	Diesel	Turbo	TD9151
TD 70 H	6cyl.	6730cc	157kW (214PS)	Diesel	Turbo	TD9097
TD 71 A	6cyl.	6730cc	169kW (230PS)	Diesel	Turbo Intercooled	TD23335
TMD 70	6cyl.	6730cc	110-147kW (150-200PS)	Diesel	Turbo	FM6262
08-407000-10	STD	104.775	2.385		001 CR P	KV1
[R43890]			3.160		005 P	STD
			3.160		005 IF P	STD
			4.747		231 CR P	STD

12

TD 71 ACE	6cyl.	6730cc	169kW (230PS)	Diesel	Turbo Intercooled	TD23334
TD 71 AG	6cyl.	6730cc	169kW (230PS)	Diesel	Turbo Intercooled	TD23333
TD 71 AGP	6cyl.	6730cc	169kW (230PS)	Diesel	Turbo Intercooled	TD23332
TD 71 AP	6cyl.	6730cc	169kW (230PS)	Diesel	Turbo Intercooled	TD23331
TD 71 APB	6cyl.	6730cc	169kW (230PS)	Diesel	Turbo Intercooled	TD23330
TD 71 AW	6cyl.	6730cc	169kW (230PS)	Diesel	Turbo Intercooled	TD23329
TD 71 E	6cyl.	6730cc	180kW (245PS)	Diesel	Turbo Intercooled	FM5113
TD 71 F	6cyl.	6730cc	169-180kW (220-245PS)	Diesel	Turbo Intercooled	TD5903
TD 71 FA	6cyl.	6730cc	173kW (235PS)	Diesel	Turbo Intercooled	TD9212
TD 71 FC	6cyl.	6730cc	173kW (235PS)	Diesel	Turbo Intercooled	TD9213
TD 71 FD	6cyl.	6730cc	180kW (245PS)	Diesel	Turbo Intercooled	TD9232
TD 71 FQ	6cyl.	6730cc	169-173kW (220-235PS)	Diesel	Turbo Intercooled	TD6250
TD 71 FS	6cyl.	6730cc	178-184kW (242-250PS)	Diesel	Turbo Intercooled	TD5904
TD 71 FSO	6cyl.	6730cc	177kW (240PS)	Diesel	Turbo Intercooled	FM5165
TD 71 FSQ	6cyl.	6730cc	169-184kW (230-250PS)	Diesel	Turbo Intercooled	TD6251
TD 71 G	6cyl.	6730cc	178-184kW (242-250PS)	Diesel	Turbo Intercooled	TD26265
08-501400-00	STD	104.775	2.385		001 MOL P	KV1
[R43490]			3.160		005 IF CR P	STD
			4.747		231 CR P	STD



13

TD 73 E Euro 1		6cyl.	6730cc	169kW (230PS)	Diesel	Turbo Intercooled	TD9233
TD 73 EA		6cyl.	6730cc	160kW (218PS)	Diesel	Turbo Intercooled	TD9234
TD 73 EB		6cyl.	6730cc	184kW (250PS)	Diesel	Turbo Intercooled	TD9235
TD 73 ES		6cyl.	6730cc	191kW (260PS)	Diesel	Turbo Intercooled	TD9236
08-502700-00	STD	104.775	3.000		008 MOL P		KV1
[R67910]	2.500			005 P		STD	
	4.000			231 CR P		STD	

14

D42		4cyl.	4200cc		Diesel		FM6245
D45		4cyl.	4500cc	63kW (86PS)	Diesel		FM6247
TD 42		4cyl.	4200cc		Diesel	Turbo	FM6246
TD 45		4cyl.	4500cc	83kW (113PS)	Diesel	Turbo	FM6248
08-990600-00	STD	105.57	2.385		001 CR P		IKA
			3.160		005 P		STD
			3.160		005 P		STD
			4.747		231 CR P		STD

15

D7C215 Euro 2		6cyl.	7300cc	158kW (215PS)	Diesel	Turbo Intercooled	TD18725
D7C250 Euro 2		6cyl.	7300cc	184kW (250PS)	Diesel	Turbo Intercooled	TD11770
D7C290 Euro 2		6cyl.	7300cc	213kW (290PS)	Diesel	Turbo Intercooled	TD11771
D7C310 Euro 2		6cyl.	7300cc	228kW (310PS)	Diesel	Turbo Intercooled	TD16726
08-141900-00	STD	107.00	3.500		008 IF CK P		KV1
[R67710]	2.500			005 IFU P			
	3.500			231 CR P		STD	

16

D7E240 Euro 4		6cyl.	7100cc	177kW (240PS)	Diesel	Turbo Intercooled	TD18965
D7E280 Euro 4		6cyl.	7100cc	206kW (280PS)	Diesel	Turbo Intercooled	TD18964
D7E290 Euro 4		6cyl.	7100cc	213kW (290PS)	Diesel	Turbo Intercooled	TD20460
D7E320 Euro 4		6cyl.	7100cc	235kW (320PS)	Diesel	Turbo Intercooled	TD18963
08-430000-00	STD	108.00	3.000		008 CK		KV1
	2.000			005 IFU		F12/F14	
	3.500			231 CR			

17

D1113		3cyl.	3780cc	41kW (55PS)	Diesel	FM6249
D1114		4cyl.	5040cc	55kW (75PS)	Diesel	FM6250
08-125300-00	STD	111.12	2.385		001 CR P	STD
			3.160		005 IF P	STD
			3.160		005 IF P	STD
			4.747		031 P	STD
			4.747		031 P	STD

18

D9A260 Euro 3		6cyl.	9364cc	191kW (260PS)	Diesel Turbo Intercooled	TD16780
D9A300 Euro 3		6cyl.	9364cc	221kW (300PS)	Diesel Turbo Intercooled	TD16781
D9A340 Euro 3		6cyl.	9364cc	250kW (340PS)	Diesel Turbo Intercooled	TD16782
D9A380 Euro 3		6cyl.	9364cc	279kW (380PS)	Diesel Turbo Intercooled	TD16783
08-142000-00	STD	120.00	4.000		008 IF CK P	KV1
			3.000		005 IFU P	GOE13
			3.000		231 NT	ST

19

D9B260 Euro 4/5		6cyl.	9364cc	191kW (260PS)	Diesel Turbo Intercooled	TD21048
D9B300 Euro 4		6cyl.	9364cc	221kW (300PS)	Diesel Turbo Intercooled	TD18978
D9B310 Euro 4/5		6cyl.	9364cc	228kW (310PS)	Diesel Turbo Intercooled	TD21049
D9B340 Euro 4		6cyl.	9364cc	250kW (340PS)	Diesel Turbo Intercooled	TD18979
D9B360 Euro 4/5		6cyl.	9364cc	265kW (360PS)	Diesel Turbo Intercooled	TD21050
D9B380 Euro 4		6cyl.	9364cc	280kW (381PS)	Diesel Turbo Intercooled	TD18980
08-438900-00	STD	120.01	3.500		008 IF PVD	ST
			2.500		005 IFU NT	ST
			3.000		231 NT	ST



20

D 100 A	6cyl.	9600cc	122-147kW (166-200PS)	Diesel		TD9204
D 100 B	6cyl.	9600cc	147kW (200PS)	Diesel		TD9205
D100BHC	6cyl.	9600cc		Diesel		FM5114
D100BRC	6cyl.	9600cc		Diesel		FM5115
HD 100 A	6cyl.	9600cc	129kW (175PS)	Diesel		TD9134
HD 100 D	6cyl.	9600cc	132kW (180PS)	Diesel		TD9135
MD 100A	6cyl.	9600cc		Diesel		FM5116
MD 100B	6cyl.	9600cc		Diesel		FM5117
TD 100 A	6cyl.	9600cc	176-190kW (239-258PS)	Diesel Turbo		TD9152
TD 100 AHC	6cyl.	9600cc		Diesel Turbo		FM5118
TD 100 ARC	6cyl.	9600cc		Diesel Turbo		FM5119
THD 100 A	6cyl.	9600cc	139-191kW (200-260PS)	Diesel Turbo		TD9136
THD 100 D	6cyl.	9600cc	155-177kW (211-241PS)	Diesel Turbo		TD9119
THD 101 B	6cyl.	9600cc	169-191kW (230-260PS)	Diesel Turbo		TD23324
TMD 100 A	6cyl.	9600cc		Diesel Turbo		FM5048

08-396300-10	STD	120.65	2.385		001 IF CR P	KV1
08-396305-10	0.25mm		3.160		023 P	STD
[R43860]			3.160		023 P	STD
			4.747		231 CR P	STD

21

DH10A Euro 2	6cyl.	9600cc	180-265kW (245-360PS)	Diesel Turbo Intercooled		FM45043
TD 103 D10 Euro 2	6cyl.	9600cc	265kW (360PS)	Diesel Turbo Intercooled		FM35043
08-136800-00	STD	120.65	4.000		008 IF MOL P	KV1
[R67030]			3.160		005 IFU P	GOE13
			4.747		231 CR P	STD

22

TD 100 B	6cyl.	9600cc	206-220kW (280-299PS)	Diesel Turbo		TD9153
TD 100 CHC	6cyl.	9600cc	200kW (272PS)	Diesel Turbo		TD21338
TD 100 F	6cyl.	9600cc	200kW (272PS)	Diesel Turbo		TD21339
TD 100 G	6cyl.	9600cc	192-202kW (261-275PS)	Diesel Turbo		TD9154
TD 100 GA	6cyl.	9600cc	200kW (272PS)	Diesel Turbo		TD9155
TD 100 GB	6cyl.	9600cc	207-220kW (280-300PS)	Diesel Turbo		FM3723
TD 100 GG	6cyl.	9600cc		Diesel Turbo		FM5047
TD 101	6cyl.	9599cc	200kW (272PS)	Diesel Turbo Intercooled		FM6227
TD 101 F	6cyl.	9600cc	215-220kW (292-299PS)	Diesel Turbo Intercooled		TD9156
TD 101 FA	6cyl.	9600cc	220kW (299PS)	Diesel Turbo Intercooled		TD9157
TD 101 FC	6cyl.	9600cc	221kW (300PS)	Diesel Turbo Intercooled		TD9237
TD 101 FD	6cyl.	9600cc	220-222kW (299-302PS)	Diesel Turbo Intercooled		TD9238
TD 101 G	6cyl.	9600cc	192-202kW (261-275PS)	Diesel Turbo		TD9158
TD 101 GA	6cyl.	9600cc	200kW (272PS)	Diesel Turbo Intercooled		TD9159





THD 100 DB		6cyl.	9600cc	160-203kW (218-276PS)	Diesel	Turbo Intercooled	TD9120
THD 100 DC		6cyl.	9600cc	160-203kW (218-276PS)	Diesel	Turbo Intercooled	TD9104
THD 100 DD		6cyl.	9600cc	203kW (275PS)	Diesel	Turbo	TD9105
THD 100 E		6cyl.	9600cc	160-203kW (218-276PS)	Diesel	Turbo Intercooled	TD9137
THD 100 EA		6cyl.	9600cc	133-180kW (180-245PS)	Diesel	Turbo	TD9106
THD 100 EB		6cyl.	9600cc	160-203kW (218-276PS)	Diesel	Turbo	TD9107
THD 100 EC		6cyl.	9600cc	160-203kW (218-276PS)	Diesel	Turbo	TD9108
THD 100 ED		6cyl.	9600cc	160-203kW (218-276PS)	Diesel	Turbo Intercooled	TD9109
THD 100 EE		6cyl.	9600cc	212kW (288PS)	Diesel	Turbo	TD9110
THD 100 EK		6cyl.	9600cc	179kW (243PS)	Diesel	Turbo	TD9111
THD 101		6cyl.	9599cc	203-228kW (276-310PS)	Diesel	Turbo Intercooled	FM6228
THD 101 G		6cyl.	9600cc	203kW (275PS)	Diesel	Turbo	FM5168
THD 101 GB		6cyl.	9600cc	160kW (218PS)	Diesel	Turbo	TD9112
THD 101 GC		6cyl.	9600cc	180kW (245PS)	Diesel	Turbo	TD9113
THD 101 GD		6cyl.	9600cc	160-203kW (218-276PS)	Diesel	Turbo	TD9114
THD 101 KB		6cyl.	9600cc	210kW (286PS)	Diesel	Turbo Intercooled	TD9115
THD 101 KC		6cyl.	9600cc	228kW (310PS)	Diesel	Turbo Intercooled	TD9116
THD 101 KE		6cyl.	9600cc	235kW (320PS)	Diesel	Bi-Turbo Intercooled	TD9117
THD 101 KF		6cyl.	9600cc	228kW (310PS)	Diesel	Turbo Intercooled	FM5161
TID 100		6cyl.	9600cc		Diesel	Turbo Intercooled	FM6265
08-407100-10	STD	120.65	2.385		001 CR P	KV1	
08-407105-10	0.25mm		3.160		001 IW CR P	STD	
→06/1986			4.747		231 CR P	STD	
[R43500]							
08-407100-20	STD	120.65	2.385		001 CR	KV1	
→06/1986			3.160		001 IW CR	STD	
[R66880]			4.747		231 CR	STD	
08-501600-00	STD	120.65	2.385		001 MOL P	KV1	
06/1986→			3.160		001 IW CR P	STD	
[R67978]			4.747		231 CR P	STD	



23

TD 102 F	6cyl.	9600cc	230-234kW (313-318PS)	Diesel	Turbo Intercooled	TD9160
TD 102 FAQ	6cyl.	9600cc	221kW (300PS)	Diesel	Turbo Intercooled	TD9161
TD 102 FBQ	6cyl.	9600cc	228kW (310PS)	Diesel	Turbo Intercooled	TD9162
TD 102 FCQ	6cyl.	9600cc	220kW (299PS)	Diesel	Turbo Intercooled	TD9163
TD 102 FD Euro 1	6cyl.	9600cc	234kW (318PS)	Diesel	Turbo Intercooled	TD21341
TD 102 FDQ	6cyl.	9600cc	232-234kW (316-318PS)	Diesel	Turbo Intercooled	TD9164
TD 102 FEQ	6cyl.	9600cc	191kW (260PS)	Diesel	Turbo Intercooled	TD9165
TD 102 FGQ	6cyl.	9600cc	205kW (279PS)	Diesel	Turbo Intercooled	TD9167
TD 102 FS	6cyl.	9600cc	250kW (340PS)	Diesel	Turbo Intercooled	TD9264
TD 102 FT	6cyl.	9595cc	228kW (310PS)	Diesel	Turbo Intercooled	TD9262

08-431300-00	STD	120.65	3.000		001 CK P	KV1
			3.160		005 IW CR P	GOE12
			4.747		231 CR P	STD

24

TD 102 FF	6cyl.	9600cc	230-234kW (313-318PS)	Diesel	Turbo Intercooled	TD9166
TD 102 FH	6cyl.	9600cc	210-234kW (286-318PS)	Diesel	Turbo Intercooled	TD9168
TD 102 FL Euro 1	6cyl.	9600cc	234kW (318PS)	Diesel	Turbo Intercooled	TD9169
TD 102 FM	6cyl.	9600cc	230-252kW (313-343PS)	Diesel	Turbo Intercooled	TD9170

08-500500-00	STD	120.65	3.000		001 CR P	KV1
			3.160		005 CR P	STD
			4.747		231 CR P	STD



25

TD 103	6cyl.	9599cc		Diesel	Turbo Intercooled	FM6231
TD 103 E	6cyl.	9600cc	210-235kW (286-320PS)	Diesel	Turbo Intercooled	TD5900
TD 103 EA Euro 1	6cyl.	9600cc	235kW (320PS)	Diesel	Turbo Intercooled	TD21342
TD 103 ES Euro 1	6cyl.	9600cc	210-235kW (286-320PS)	Diesel	Turbo Intercooled	TD6247
TD 103 KBE Euro 1	6cyl.	9600cc	210kW (286PS)	Diesel	Turbo Intercooled	TD19062
TD 103 KF Euro 1	6cyl.	9600cc	210kW (286PS)	Diesel	Turbo Intercooled	TD19063
THD 103 KB	6cyl.	9600cc	210kW (286PS)	Diesel	Turbo Intercooled	TD9098
THD 103 KD	6cyl.	9600cc	250kW (340PS)	Diesel	Turbo Intercooled	TD9099



08-502600-00 01/1992→ [R66660]	STD	120.65	3.500		008 IF MOL P	KV1
			3.160		005 IW CR P	STD
			4.747		231 CR P	STD



26

THD 102 KA		6cyl.	9600cc	210kW (286PS)	Diesel	Turbo Intercooled	TD23325
THD 102 KB Euro 1		6cyl.	9600cc	210kW (286PS)	Diesel	Turbo Intercooled	TD23326
THD 102 KD		6cyl.	9600cc	252kW (343PS)	Diesel	Turbo Intercooled	TD9118
THD 102 KF		6cyl.	9600cc	180-210kW (250-286PS)	Diesel	Turbo Intercooled	TD9121
THD 102 KJ		6cyl.	9600cc	158kW (215PS)	Diesel	Turbo Intercooled	TD9138
08-501600-00	STD	120.65	2.385		001 MOL P		KV1
06/1986→			3.160		001 IW CR P		STD
[R67978]			4.747		231 CR P		STD

27

D11C330 Euro 5		6cyl.	10800cc	243kW (330PS)	Diesel	Turbo Intercooled	TD22373
D11C370 Euro 5		6cyl.	10800cc	272kW (370PS)	Diesel	Turbo Intercooled	TD22374
D11C410 Euro 5		6cyl.	10800cc	302kW (410PS)	Diesel	Turbo Intercooled	TD22376
08-438800-00	STD	123.00	3.500		008 IF PVD		ST
			2.500		005 IFU NT		ST
			3.000		231 NT		ST



28

TAMD 120 A	6cyl.	11977cc	225-243kW (306-330PS)	Diesel	Turbo	FM5133
TAMD 120 B	6cyl.	11977cc		Diesel	Turbo	FM5134
TAMD 121	6cyl.	11975cc	217-310kW (295-420PS)	Diesel	Turbo	FM6266
TD 120 A	6cyl.	12000cc	243kW (330PS)	Diesel	Turbo	TD9206
TD 120 C	6cyl.	12000cc	260kW (354PS)	Diesel	Turbo	TD9171
TD 120 D	6cyl.	11980cc	273kW (371PS)	Diesel	Turbo	TD9172
TD 120 F	6cyl.	11980cc	265kW (360PS)	Diesel	Turbo Intercooled	TD9174
TD 120 FC	6cyl.	11980cc	265kW (360PS)	Diesel	Turbo Intercooled	TD9175
TD 120 G	6cyl.	11980cc	226-243kW (307-330PS)	Diesel	Turbo	TD9177
TD 120 GA	6cyl.	11980cc	227kW (310PS)	Diesel	Turbo	TD9178
TD 120 GG	6cyl.	11977cc		Diesel	Turbo	FM5138
TD 121	6cyl.	11977cc	243-283kW (330-385PS)	Diesel	Turbo Intercooled	FM13885
TD 121 F	6cyl.	11980cc	272-283kW (370-385PS)	Diesel	Turbo Intercooled	TD9179
TD 121 FD	6cyl.	11980cc	283kW (385PS)	Diesel	Turbo Intercooled	TD9180
TD 121 G	6cyl.	11980cc	235-243kW (320-330PS)	Diesel	Turbo	TD9183
TD 121 GD	6cyl.	11980cc	243kW (330PS)	Diesel	Turbo	TD9143
TD 122	6cyl.	11980cc	309kW (420PS)	Diesel	Turbo Intercooled	TD9184
TD 122 F	6cyl.	11980cc	257-262kW (350-356PS)	Diesel	Turbo	TD9186
TD 122 FA	6cyl.	11980cc	272kW (370PS)	Diesel	Turbo	TD9187
TD 122 FH Euro 1	6cyl.	11980cc	262kW (356PS)	Diesel	Turbo Intercooled	TD9122
TD 122 FK	6cyl.	11980cc	287-291kW (390-396PS)	Diesel	Turbo Intercooled	TD9191
TD 122 FL	6cyl.	11980cc	291kW (396PS)	Diesel	Turbo Intercooled	TD9123
TD 122 FR	6cyl.	11980cc	262-291kW (356-396PS)	Diesel	Turbo Intercooled	TD9193
TD 122 FS	6cyl.	11980cc	287-291kW (395-396PS)	Diesel	Turbo Intercooled	TD9194
TID 120 F	6cyl.	11977cc		Diesel	Turbo	FM5045
TMD 120 A	6cyl.	11977cc	225-243kW (306-330PS)	Diesel		FM5132
08-405600-10	STD	130.175	2.385		001 CR P	KV1
[R43510]			3.160		005 IW CR P	STD
			4.747		231 CR P	STD
08-405600-20	STD	130.175	2.385		001 CR	KV1
[R66870]			3.160		005 IW CR	STD
			4.747		231 CR	STD



29

TD 123		6cyl.	11977cc		Diesel	Turbo Intercooled	FM15046
TID 121 B		6cyl.	11979cc	217-305kW (295-415PS)	Diesel	Turbo Intercooled	FM26267
TID 121 KG		6cyl.	11979cc	217-305kW (295-415PS)	Diesel	Turbo Intercooled	FM36267
TID 121 KP		6cyl.	11979cc	217-305kW (295-415PS)	Diesel	Turbo Intercooled	FM46267
TID 121 LG		6cyl.	11979cc	217-305kW (295-415PS)	Diesel	Turbo Intercooled	FM6267
TID 121 LP		6cyl.	11979cc	217-305kW (295-415PS)	Diesel	Turbo Intercooled	FM16267
TID 121 P		6cyl.	11979cc	217-305kW (295-415PS)	Diesel	Turbo Intercooled	FM56267
TWD 121 G		6cyl.	11979cc	217-305kW (295-415PS)	Diesel	Turbo Intercooled	FM66267
08-501300-00	STD	130.175	3.500		008 MO P		KV1
[R67550]			3.160		005 IW CR P		STD
			4.747		231 CR P		STD

30

D12A340 Euro 2		6cyl.	12100cc	250kW (340PS)	Diesel	Turbo Intercooled	TD11727
D12A380 Euro 2		6cyl.	12110cc	279kW (380PS)	Diesel	Turbo Intercooled	TD9215
D12A420 Euro 2		6cyl.	12100cc	309kW (420PS)	Diesel	Turbo Intercooled	TD9216
D12C340 Euro 2		6cyl.	12100cc	250kW (340PS)	Diesel	Turbo Intercooled	TD11731
D12C380		6cyl.	12100cc	279kW (380PS)	Diesel	Turbo Intercooled	TD11728
D12C420		6cyl.	12100cc	309kW (420PS)	Diesel	Turbo Intercooled	TD11729
D12C460		6cyl.	12100cc	338kW (460PS)	Diesel	Turbo Intercooled	TD11730
D12D340 Euro 3		6cyl.	12100cc	250kW (340PS)	Diesel	Turbo Intercooled	TD16784
D12D380 Euro 3		6cyl.	12100cc	279kW (380PS)	Diesel	Turbo Intercooled	TD16785
D12D420 Euro 3		6cyl.	12100cc	309kW (420PS)	Diesel	Turbo Intercooled	TD16786
D12D460 Euro 3		6cyl.	12100cc	338kW (460PS)	Diesel	Turbo Intercooled	TD16787
D12D500 Euro 3		6cyl.	12100cc	368kW (500PS)	Diesel	Turbo Intercooled	TD16508
DH12D420 Euro 3		6cyl.	12100cc	309kW (420PS)	Diesel	Turbo Intercooled	TD16513
08-123200-00	STD	131.00	4.000		008 IF CK P		KV1
[R67840]			3.000		005 IWU P		GOE13
			4.000		231 NT		ST



31

D13A360 Euro 5	6cyl.	12800cc	264kW (359PS)	Diesel	Turbo Intercooled	TD18826
D13A400 Euro 5	6cyl.	12800cc	294kW (400PS)	Diesel	Turbo Intercooled	TD18827
D13A440 Euro 5	6cyl.	12800cc	324kW (440PS)	Diesel	Turbo Intercooled	TD18828
D13A480 Euro 5	6cyl.	12800cc	353kW (480PS)	Diesel	Turbo Intercooled	TD18829
D13A520 Euro 5	6cyl.	12800cc	382kW (520PS)	Diesel	Turbo Intercooled	TD18830
D13C380 Euro 5	6cyl.	12800cc	280kW (381PS)	Diesel	Turbo Intercooled	TD22378
D13C420 Euro 5	6cyl.	12800cc	309kW (420PS)	Diesel	Turbo Intercooled	TD22150
D13C460 Euro 5	6cyl.	12800cc	338kW (460PS)	Diesel	Turbo Intercooled	TD22151
D13C500 Euro 5	6cyl.	12800cc	368kW (500PS)	Diesel	Turbo Intercooled	TD22152
D13C540 Euro 5	6cyl.	12800cc	397kW (540PS)	Diesel	Turbo Intercooled	TD22153

08-434400-00	STD	131.00	3.500		008 IF NT PVD	ST
			2.500		005 IFU NT	ST
			3.000		231 NT	ST

32

D 16A	6cyl.	16123cc	346-382kW (470-520PS)	Diesel	Turbo Intercooled	TD9217
D16A470 Euro 2	6cyl.	16120cc	346kW (471PS)	Diesel	Turbo Intercooled	TD17534
D16A520	6cyl.	16120cc	382kW (520PS)	Diesel	Turbo Intercooled	TD11767
D16B520	6cyl.	16120cc	382kW (520PS)	Diesel	Turbo Intercooled	TD11768

08-101100-00	STD	144.00	4.500		008 IW MOL P	KV1
			3.500		005 P	STD
			5.000		231 CR P	STD

33

TD 161	6cyl.			Diesel	Turbo Intercooled	FM6233
TD 162 F	6cyl.	16123cc	330-357kW (450-485PS)	Diesel	Turbo Intercooled	TD5901
TD 162 FL	6cyl.	16120cc	330-357kW (450-485PS)	Diesel	Turbo	TD6313
TD 162 FS	6cyl.	16123cc	330-357kW (450-485PS)	Diesel	Turbo Intercooled	TD6327

08-500300-00	STD	144.00	2.960		001 MO P	KV1	
			[R67210]	3.460		005 IW CR P	STD
			5.000		231 CR P	STD	

34

TD 163	6cyl.	16120cc	346-382kW (470-520PS)	Diesel	Turbo Intercooled	FM6235
TD 163 ES	6cyl.	16123cc	368kW (500PS)	Diesel	Turbo Intercooled	TD9200

08-502500-00	STD	144.00	4.000		008 IW MOL P	KV1	
			[R67220]	3.500		005 P	STD
			5.000		231 CR P	STD	



1

MD, TMD 60		6cyl.	5480cc	113kW (154PS)	Diesel	Turbo	FM5101
08-405500-10	STD	98.43	2.385		001 CR P		KV1
[R43480]	3.160			005 IF P		STD	
	4.747			231 CR P		STD	

2

MD, TMD 70		6cyl.	6730cc		Diesel	Turbo	FM5108
08-392000-10	STD	104.775	2.385		001 IF CR P		IKA
08-392005-10	0.25mm		3.160		001 P		STD
[R43870]			3.160		023 P		STD
			4.747		231 CR P		STD
			4.747		030 P		STD

3

MD, TMD 100		6cyl.	9600cc		Diesel		FM5116
08-396300-10	STD	120.65	2.385		001 IF CR P		KV1
08-396305-10	0.25mm		3.160		023 P		STD
[R43860]			3.160		023 P		STD
			4.747		231 CR P		STD

4

MD, TAMD 120, TMD		6cyl.	11977cc		Diesel	Turbo	FM3027
08-405600-10	STD	130.175	2.385		001 CR P		KV1
[R43510]			3.160		005 IW CR P		STD
			4.747		231 CR P		STD
08-405600-20	STD	130.175	2.385		001 CR		KV1
[R66870]			3.160		005 IW CR		STD
			4.747		231 CR		STD

ENGINE INDEX

Motorverzeichnis • Index de moteur • Índice de Motor
Indeks silnika • Модель двигателя • دليل المحرك



CCM

x



9

Engine Model	Fuel Type	CCM	Value	Page
3FT120T	Petrol	3	92.00	8
3TNE83-N	Petrol	3	83.00	3
3TS86R-K	Petrol	2	86.00	6
4TN100-M	Petrol	4	100.00	9
4TNE62-S	Petrol	4	62.00	1
TS70	Diesel	4	80.00	2
TS105	Diesel		85.00	4
TS1610	Petrol	2	85.00	5
TS1700	Petrol	2	86.00	7



4TNE62-S						4cyl.	1	FM6284
08-960100-00	STD	62.00	1.500		001 CR P		IKA	
[R48510]			1.500		005 P		STD	
			2.800		236 P		STD	

TS70						4cyl.	Diesel	2	FM9026
08-114000-00	STD	80.00	2.500		001 CR P		STD		
			2.500		005 P		STD		
			2.500		026 P		STD		
			4.000		031 CR P		STD		

3TNE83-N						3cyl.	3	FM6285
08-292800-00	STD	83.00	2.500		001 IF CR P		KV1	
[R39150]			2.000		005 IF		STD	
			2.000		005 IF		STD	
			4.500		231 CR P		STD	
			4.500		031		STD	

TS105							Diesel	4	FM9025
08-114100-00	STD	85.00	2.500		001 CR P		STD		
			2.500		005 P		STD		
			2.500		026 P		STD		
			4.000		031 CR P		STD		

TS1610						2cyl.	5	FM6286
08-295400-00	STD	85.00	2.000		001 IF CR P		KV1	
[R42720]			2.000		005 IF P		STD	
			4.000		231 CR P		STD	



6

3TS86R-K

2cyl.

FM6288

08-283600-00	STD	86.00	2.000		001 CR P	KV1
08-283607-00	0.50mm				005 IW P	STD
08-283611-00	1.00mm					231 CR P
[R42580]			4.000			

7

TS1700

2cyl.

FM6287

08-247200-00 ¹	STD	86.00	2.000		001 CR P	KV1	
08-247207-00	0.50mm			2.000		005 P	STD
08-247211-00	1.00mm			2.000		005 P	STD
			5.000		231 CR P	STD	
08-247200-10	STD	86.00	2.000		001	STD	
[R40320]				2.000		023	STD
				2.000		023	STD
				5.000		231	STD

¹ For Cast Iron Bores only

¹ Nur für Gußeisenbohrungen

¹ Pour intérieur cylindre seulement

¹ Para diámetro internos de hierro fundido solamente

8

3FT120T

3cyl.

FM6289

08-373800-00	STD	92.00	2.000		007 CR P	KV1	
[R42780]				2.000		005 P	STD
				4.000		231 CR P	STD

9

4TN100-M

4cyl.

FM6290

08-288200-00	STD	100.00	3.000		007 CR P	KV1	
[R42660]				2.000		005 P	STD
				5.000		231 CR P	STD

Motorverzeichnis • Index de moteur • Índice de Motor
Indeks silnika • Модель двигателя • دليل المحرك

ENGINE INDEX



CCM

x



9

100 GL. 0.64	Petrol	1116	4	65.00	1
128 A.000	Petrol	1116	4	80.00	4
128 A.064	Petrol	1116	4	80.00	4
128 AC 5000	Petrol	1116	4	80.00	4
160 A1.000	Petrol	1372	4	80.50	5
188 A4.000	Petrol	1242	4	70.80	2
TU1JP	Petrol	1124	4	72.00	3



Yugo 1.1 60 EFI	08/91→06/95	100 GL. 0.64	4cyl. 1116cc	44kW (60PS)	1
					TD9410

08-209800-00	STD	65.00	1.750		001 IF CR P	IKA
08-209806-00	0.40mm		2.000		026 P	STD
08-209808-00	0.60mm		3.947		231 P	STD
<i>[R46550]</i>						

10 1.2 60	10/05→	188 A4.000	4cyl. 1242cc	44kW (60PS)	2
					TD24580

08-138400-00	STD	70.80	1.190		001 P NT	KV1
08-138406-00	0.40mm		1.200		005 P	STD
08-138408-00	0.60mm		2.500		231 P	GOE12
<i>[R66670]</i>						

Koral 1.1	10/02→11/08	TU1JP	4cyl. 1124cc	44kW (60PS)	3
					TD26420

08-426300-00	STD	72.00	1.500		001 NT	KV1
			1.500		026 P	GOE13
			2.500		236 P	GOE13

101 1.1	06/73→01/90	128 A.000	4cyl. 1116cc	41-44kW (56-60PS)	4
					TD4183

101 1.1	05/75→12/93	128 A.064	4cyl. 1116cc	41kW (55PS)	
					TD9409

101 1.1 Super	07/79→09/81	128 AC 5000	4cyl. 1116cc	47kW (64PS)	
					TD5045

08-203100-00	STD	80.00	1.500		001 IF CR P	IKA
08-203104-00	0.20mm		2.000		026 P	STD
08-203106-00	0.40mm		3.947		232 P	STD
08-203108-00	0.60mm					
08-203110-00	0.80mm					
08-203111-00	1.00mm					
<i>[R47750]</i>						



Yugo Florida 1.4	10/88→06/95	160 A1.000							
Yugo Florida 1.4 CAT	10/88→		4cyl.						5
			1372cc	52kW (71PS)					TD21694

08-783600-00	STD	80.50	1.500		001 IF CR P	IKA	
08-783606-00	0.40mm				026 P	STD	
08-783608-00	0.60mm		1.750		712 CR	ST	
08-783610-00	0.80mm						
08-783611-00	1.00mm		3.000				
[R46940]							



Tavrija 1.1

01/89→

MEMZ-245

1

4cyl.

1091cc

37kW (50PS)

TD9494

08-374600-00	STD	72.00	1.500		001 CR P	IKA
			2.000		026 P	STD
			4.000		712 CR	ST



1

2001			2cyl.							FM6294
3001			3cyl.	2340cc						FM6295
4001			4cyl.	3120cc						FM6296
5501			6cyl.	3120cc						FM6297
08-343700-00	STD	95.00		3.000		001 IF CR P		STD		
				3.000		001 P		STD		
				3.000		023 P		STD		
				5.000		231		STD		
				5.000		031 P		STD		

2









4701			3cyl.	2590cc						FM6298
6701			4cyl.	3456cc						FM6299
08-347200-00	STD	100.00		3.000		001 IW CR P		STD		
				3.000		001 P		STD		
				3.000		023 P		STD		
				5.000		231 CR P		STD		
				5.000		030 P		STD		









3

4901			3cyl.	2697cc						FM6300
6901			4cyl.	3595cc						FM6302
Z 5201 T			3cyl.	2696cc	41kW (55PS)	Diesel	Turbo			TD19420
Z 7201			4cyl.	3595cc	46kW (63PS)	Diesel				TD19421
08-348300-00	STD	102.00		3.000		001 CR P		STD		
				3.000		005 IF P		STD		
				3.000		005 IF P		STD		
				5.000		231 CR P		STD		

NUMERICAL PARTS LIST









Nummerische Teilenummernliste • Liste des références produits
Liste da referencias



   9				   9				   9			
08-100100-00	FORD TRACTOR	379	5	08-103906-00	IVECO	425	23	08-106100-00	KUBOTA	452	1
		380	7	08-103908-00	IVECO	425	23	08-106300-00	MERCEDES BENZ	614	50
08-100107-00	FORD TRACTOR	379	5	08-103910-00	IVECO	425	23	08-106500-00	BMW	125	9
		380	7	08-104000-00	CITROEN	177	26	08-106507-00	BMW	125	9
08-100109-00	FORD TRACTOR	379	5		FIAT	278	39	08-106700-00	AUSTIN MORRIS	96	4
		380	7		PEUGEOT	793	27		MG	646	2
08-100111-00	FORD TRACTOR	379	5	08-104008-00	CITROEN	177	26	08-106800-00	NISSAN	687	19
		380	7		FIAT	278	39	08-106807-00	NISSAN	687	19
08-101000-00	LEYLAND	493	6		PEUGEOT	793	27	08-106900-00	IVECO	420	15
	PERKINS	758	14	08-104100-00	NISSAN	680	2		NEW HOLLAND	666	5
		759	15			680	3	08-107000-00	FORD EUROPE	352	26
08-101100-00	VOLVO COMMERCIAL	1256	32		RENAULT	871	4	08-107007-00	FORD EUROPE	352	26
08-101200-00	MERCEDES BENZ	572	3	08-104105-00	NISSAN	680	2	08-107011-00	FORD EUROPE	352	26
08-101300-00	SEAT	977	2			680	3	08-107100-00	ALFA ROMEO	22	24
	VOLKSWAGEN	1159	1		RENAULT	871	4	08-107100-10	ALFA ROMEO	22	24
08-101307-00	SEAT	977	2	08-104107-00	NISSAN	680	2	08-107200-00	PERKINS	756	12
	VOLKSWAGEN	1159	1			680	3			757	13
08-101400-00	CITROEN	186	42		RENAULT	871	4			758	14
	PEUGEOT	803	44	08-104200-00	DACIA	202	6		VOLVO COMMERCIAL	1245	8
08-101500-00	RENAULT	897	24		NISSAN	685	13	08-107209-00	PERKINS	756	12
08-101507-00	RENAULT	897	24		RENAULT	888	19			757	13
08-101600-00	RENAULT	912	35			892	20			758	14
08-101700-00	PERKINS	760	21	08-104207-00	DACIA	202	6		VOLVO COMMERCIAL	1245	8
08-102200-00	FORD EUROPE	331	2		NISSAN	685	13	08-107300-00	FORD EUROPE	348	22
08-102207-00	FORD EUROPE	331	2		RENAULT	888	19	08-107307-00	FORD EUROPE	348	22
08-102300-00	FORD EUROPE	338	10			892	20	08-107400-00	FORD EUROPE	358	33
08-102307-00	FORD EUROPE	338	10	08-104300-00	MAN	532	26	08-107600-00	FORD EUROPE	365	45
08-102400-00	VOLVO	1230	11	08-104300-20	MAN	532	26	08-107607-00	FORD EUROPE	365	45
08-102500-00	VOLVO	1232	15	08-104500-00	RENAULT	905	29	08-107800-10	ALFA ROMEO	15	11
08-102700-00	OPEL	719	9	08-104700-00	RENAULT	915	38	08-107900-00	ALFA ROMEO	17	13
	VAUXHALL	1087	10	08-105000-00	RENAULT	874	7		FIAT	276	35
08-102707-00	OPEL	719	9	08-105100-00	RENAULT	895	22		LANCIA	471	24
	VAUXHALL	1087	10		VOLVO	1229	9	08-107908-00	ALFA ROMEO	17	13
08-102800-00	OPEL	735	39	08-105107-00	RENAULT	895	22		FIAT	276	35
	VAUXHALL	1100	40		VOLVO	1229	9		LANCIA	471	24
08-102807-00	OPEL	735	39	08-105200-00	DACIA	202	6	08-108000-00	ALFA ROMEO	19	17
	VAUXHALL	1100	40		RENAULT	888	19		FIAT	275	33
08-102900-00	OPEL	735	38	08-105207-00	DACIA	202	6		LANCIA	470	21
	VAUXHALL	1100	39		RENAULT	888	19	08-108008-00	ALFA ROMEO	19	17
08-102907-00	OPEL	735	38	08-105400-00	MERCEDES BENZ	573	4		FIAT	275	33
	VAUXHALL	1100	39	08-105500-00	CITROEN	180	31		LANCIA	470	21
08-103000-00	AUDI	62	11		FIAT	282	47	08-108200-00	CITROEN	189	53
	SKODA	1008	12		LADA	457	6		FIAT	295	71
	VOLKSWAGEN	1173	20		PEUGEOT	797	33		IVECO	419	11
08-103007-00	AUDI	62	11		SUZUKI	1034	13		PEUGEOT	809	59
	SKODA	1008	12	08-105507-00	CITROEN	180	31		RENAULT TRUCKS	930	5
	VOLKSWAGEN	1173	20		FIAT	282	47	08-108208-00	CITROEN	189	53
08-103100-00	SEAT	979	8		LADA	457	6		FIAT	295	71
	SKODA	1006	6		PEUGEOT	797	33		IVECO	419	11
	VOLKSWAGEN	1166	12	08-105510-00	SUZUKI	1034	13		PEUGEOT	809	59
08-103200-00	DEUTZ KHD	221	2		CITROEN	180	31		RENAULT TRUCKS	930	5
08-103207-00	DEUTZ KHD	221	2		FIAT	282	47	08-108500-00	AUDI	59	1
08-103400-00	VOLVO	1229	8		LADA	457	6		VOLKSWAGEN	1159	2
08-103500-00	RENAULT	895	22		PEUGEOT	797	33	08-108600-00	AUDI	59	1
	VOLVO	1229	8	08-105900-00	SUZUKI	1034	13		VOLKSWAGEN	1159	2
08-103507-00	RENAULT	895	22		AUDI	73	21	08-108700-00	AUDI	59	1
	VOLVO	1229	8		SEAT	989	21		VOLKSWAGEN	1159	2
08-103700-00	JELCZ	446	1		SKODA	1013	19	08-108707-00	AUDI	59	1
08-103800-00	CITROEN	175	21						VOLKSWAGEN	1159	2
	PEUGEOT	790	20	08-105907-00	VOLKSWAGEN	1193	35	08-108800-00	AUDI	60	4
08-103806-00	CITROEN	175	21		AUDI	73	21		VOLKSWAGEN	1163	8
	PEUGEOT	790	20		SEAT	989	21	08-108807-00	AUDI	60	4
08-103900-00	IVECO	425	23		SKODA	1013	19		VOLKSWAGEN	1163	8
					VOLKSWAGEN	1193	35				

   9				   9				   9			
08-109000-10	ALFA ROMEO	23	27	08-110200-00	ALFA ROMEO	22	25			65	14
08-109008-10	ALFA ROMEO	23	27	08-110300-00	ALFA ROMEO	24	29		FORD EUROPE	344	17
08-109100-00	MERCEDES BENZ	605	37	08-110500-00	ALFA ROMEO	25	30		SEAT	983	15
	SSANGYONG	1021	3		FIAT	291	61			986	16
08-109107-00	MERCEDES BENZ	605	37	08-110700-00	BMW	131	22		SKODA	1009	14
	SSANGYONG	1021	3	08-110900-00	ALFA ROMEO	21	22			1010	15
08-109200-00	SCANIA	958	4	08-110906-00	ALFA ROMEO	21	22		VOLKSWAGEN	1174	22
08-109400-10	AUDI	72	20	08-111100-00	MINISUBISHI	657	16			1180	24
	SEAT	988	20	08-111200-00	NISSAN	692	34	08-114905-00	AUDI	63	13
	VOLKSWAGEN	1187	31	08-111600-00	MINISUBISHI	657	15			65	14
08-109407-10	AUDI	72	20	08-111800-00	RENAULT	895	22		FORD EUROPE	344	17
	SEAT	988	20	08-111807-00	RENAULT	895	22		SEAT	983	15
	VOLKSWAGEN	1187	31	08-111900-00	KIA	450	10			986	16
08-109500-00	AUDI	61	8		MAZDA	542	14		SKODA	1009	14
	PEGASO	748	1	08-112100-00	SCANIA	961	9			1010	15
	VOLKSWAGEN	1164	10	08-112300-00	MINISUBISHI	657	15		VOLKSWAGEN	1174	22
	VOLVO	1228	5	08-112400-00	CITROEN	187	45			1180	24
08-109505-00	AUDI	61	8		PEUGEOT	806	50	08-114907-00	AUDI	63	13
	PEGASO	748	1	08-112407-00	CITROEN	187	45			65	14
	VOLKSWAGEN	1164	10		PEUGEOT	806	50		FORD EUROPE	344	17
	VOLVO	1228	5	08-112500-00	PORSCHE	826	28		SEAT	983	15
08-109507-00	AUDI	61	8	08-112700-00	FORD EUROPE	360	36			986	16
	PEGASO	748	1	08-112707-00	FORD EUROPE	360	36		SKODA	1009	14
	VOLKSWAGEN	1164	10	08-113500-00	FORD EUROPE	366	46			1010	15
	VOLVO	1228	5	08-113507-00	FORD EUROPE	366	46		VOLKSWAGEN	1174	22
08-109511-00	AUDI	61	8	08-113511-00	FORD EUROPE	366	46			1180	24
	PEGASO	748	1	08-113700-00	NISSAN	685	15	08-114911-00	AUDI	63	13
	VOLKSWAGEN	1164	10		OPEL	729	28			65	14
	VOLVO	1228	5		RENAULT	897	24		FORD EUROPE	344	17
08-109600-00	BMW	140	36		VAUXHALL	1095	29		SEAT	983	15
08-109700-00	AUDI	69	18	08-114000-00	YANMAR	1259	2			986	16
	SEAT	988	19	08-114100-00	YANMAR	1259	4		SKODA	1009	14
	VOLKSWAGEN	1185	30	08-114400-00	BMW	126	12			1010	15
08-109705-00	AUDI	69	18		LAND ROVER	482	6		VOLKSWAGEN	1174	22
	SEAT	988	19		ROVER	944	10			1180	24
	VOLKSWAGEN	1185	30	08-114400-10	BMW	126	12	08-115700-00	PORSCHE	828	31
08-109707-00	AUDI	69	18		ROVER	944	10	08-115800-00	MERCEDES BENZ COMMERCIAL	638	20
	SEAT	988	19	08-114400-40	BMW	127	14	08-115900-00	AUDI	77	24
	VOLKSWAGEN	1185	30			130	19		SEAT	991	25
08-109800-00	ARO	31	3			131	20	08-116100-00	AUDI	60	6
	AUDI	62	10	08-114400-45	BMW	127	13		SEAT	980	9
	VOLKSWAGEN	1163	9	08-114400-55	BMW	131	20			982	10
	VOLVO	1228	6	08-114405-00	BMW	126	12		SKODA	1006	7
08-109807-00	ARO	31	3		LAND ROVER	482	6			1007	8
	AUDI	62	10		ROVER	944	10		VOLKSWAGEN	1167	13
	VOLKSWAGEN	1163	9	08-114405-40	BMW	127	14			1169	15
	VOLVO	1228	6			130	19	08-116107-00	AUDI	60	6
08-109811-00	ARO	31	3			131	20		SEAT	980	9
	AUDI	62	10	08-114700-00	CITROEN	182	34			982	10
	VOLKSWAGEN	1163	9		FIAT	287	53		SKODA	1006	7
	VOLVO	1228	6		FORD EUROPE	359	34			1007	8
08-109900-00	BMW	131	22		LANCIA	475	29		VOLKSWAGEN	1167	13
08-110000-00	ALFA ROMEO	26	32		PEUGEOT	799	37			1169	15
	VM	1111	1		SUZUKI	1034	14	08-117700-00	KOMATSU	451	2
08-110100-00	ALFA ROMEO	27	33		VOLVO	1233	17	08-117900-00	MERCEDES BENZ	591	26
	CHRYSLER	148	10	08-114708-00	CITROEN	182	34	08-117907-00	MERCEDES BENZ	591	26
	FORD EUROPE	371	53		FIAT	287	53	08-118000-00	ALFA ROMEO	18	15
	LAND ROVER	485	16		FORD EUROPE	359	34			18	16
	OPEL	744	56		LANCIA	475	29		FIAT	274	31
	ROVER	946	15		PEUGEOT	799	37		LANCIA	468	17
	UAZ	1067	2		SUZUKI	1034	14	08-118006-00	ALFA ROMEO	18	15
	VAUXHALL	1107	55		VOLVO	1233	17			18	16
	VM	1111	2	08-114900-00	AUDI	63	13		FIAT	274	31

NUMERICAL PARTS LIST









Nummerische Teilenummernliste • Liste des références produits
Liste da referencias

				9					9					9
08-118008-00	LANCIA		468	17	08-123407-30	RENAULT		882	14	08-126100-00	OPEL		734	36
	ALFA ROMEO		18	15	08-123700-00	FORD EUROPE		374	58		VAUXHALL		1099	37
			18	16				375	59	08-126107-00	OPEL		734	36
	FIAT		274	31	08-123711-00	FORD EUROPE		374	58		VAUXHALL		1099	37
	LANCIA		468	17				375	59	08-126200-00	OPEL		742	48
08-118700-00	RENAULT		913	36	08-123721-00	FORD EUROPE		374	58		VAUXHALL		1106	48
08-118800-00	RENAULT		913	36				375	59	08-126207-00	OPEL		742	48
08-118900-00	CITROEN		187	46	08-123800-00	DEUTZ KHD		229	25		VAUXHALL		1106	48
	PEUGEOT		806	51	08-123900-00	DEUTZ KHD		234	39	08-126300-10	BEDFORD		106	11
08-118907-00	CITROEN		187	46	08-123900-10	DEUTZ KHD		234	39	08-126305-10	BEDFORD		106	11
	PEUGEOT		806	51	08-124000-00	ALFA ROMEO		17	13	08-126307-10	BEDFORD		106	11
08-119000-00	MERCEDES BENZ		603	36		FIAT		275	34	08-126309-10	BEDFORD		106	11
08-119005-00	MERCEDES BENZ		603	36				276	35	08-126311-10	BEDFORD		106	11
08-119007-00	MERCEDES BENZ		603	36				276	36	08-126314-10	BEDFORD		106	11
08-119800-00	HONDA		387	7		LANCIA		469	19	08-126600-00	CITROEN		184	37
	LAND ROVER		482	7				471	24		FIAT		288	54
	ROVER		944	11		OPEL		732	32		LANCIA		475	30
08-119807-00	HONDA		387	7		SAAB		949	5		PEUGEOT		802	40
	LAND ROVER		482	7		VAUXHALL		1097	33	08-126608-00	CITROEN		184	37
	ROVER		944	11	08-124006-00	ALFA ROMEO		17	13		FIAT		288	54
08-120100-00	AUDI		60	5		FIAT		275	34		LANCIA		475	30
	VOLKSWAGEN		1169	14				276	35		PEUGEOT		802	40
08-120107-00	AUDI		60	5				276	36	08-127300-00	BMW		139	34
	VOLKSWAGEN		1169	14		LANCIA		469	19	08-127400-00	NISSAN		689	24
08-121100-00	SCANIA		960	8				471	24		OPEL		741	47
08-121200-00	SCANIA		962	11		OPEL		732	32		RENAULT		913	37
08-121600-00	DAF		210	13		SAAB		949	5		VAUXHALL		1105	47
08-121700-00	COMPRESSOR		196	25		VAUXHALL		1097	33	08-127407-00	NISSAN		689	24
08-121800-00	IVECO		429	32	08-124008-00	ALFA ROMEO		17	13		OPEL		741	47
08-121900-00	IVECO		433	43		FIAT		275	34		RENAULT		913	37
08-122000-00	IVECO		434	47				276	35		VAUXHALL		1105	47
08-122008-00	IVECO		434	47				276	36	08-127700-00	MERCEDES BENZ COMMERCIAL		628	9
08-122100-00	DEUTZ KHD		225	15		LANCIA		469	19	08-127800-00	DEUTZ KHD		223	11
08-122200-00	CITROEN		189	52				471	24	08-127900-00	DEUTZ KHD		226	18
	FIAT		295	69		OPEL		732	32	08-128200-10	BMW		125	8
			295	70		SAAB		949	5	08-128205-10	BMW		125	8
	IVECO		418	9		VAUXHALL		1097	33	08-128207-10	BMW		125	8
			418	10	08-124200-00	MERCEDES BENZ		610	44	08-129500-00	BMW		138	31
	OPEL		745	59	08-124500-00	MAN		529	22	08-129505-00	BMW		138	31
	PEUGEOT		809	58	08-124600-00	ALFA ROMEO		26	31	08-129507-00	BMW		138	31
	RENAULT		925	51	08-124700-00	ALFA ROMEO		21	23	08-130200-00	BELARUS		107	1
	RENAULT TRUCKS		930	4	08-124706-00	ALFA ROMEO		21	23	08-131300-00	BMW		122	1
	VAUXHALL		1108	57	08-124708-00	ALFA ROMEO		21	23	08-131305-00	BMW		122	1
08-122208-00	CITROEN		189	52	08-124800-00	FIAT		273	28	08-131307-00	BMW		122	1
	FIAT		295	69		LANCIA		468	15	08-131500-10	RENAULT TRUCKS		933	12
			295	70	08-124806-00	FIAT		273	28				933	13
	IVECO		418	9		LANCIA		468	15	08-131900-00	COMPRESSOR		194	13
			418	10	08-124808-00	FIAT		273	28	08-132000-10	RENAULT TRUCKS		933	12
	OPEL		745	59		LANCIA		468	15	08-132100-10	RENAULT TRUCKS		936	19
	PEUGEOT		809	58	08-125300-00	VOLVO COMMERCIAL		1249	17	08-132200-10	RENAULT TRUCKS		937	23
	RENAULT		925	51	08-125600-00	OPEL		727	22	08-132900-00	BMW		139	32
	RENAULT TRUCKS		930	4		VAUXHALL		1094	23	08-132905-00	BMW		139	32
	VAUXHALL		1108	57	08-125607-00	OPEL		727	22	08-132907-00	BMW		139	32
08-123200-00	VOLVO COMMERCIAL		1255	30		VAUXHALL		1094	23	08-133100-10	BMW		122	2
08-123400-00	DACIA		201	5	08-125700-00	PORSCHE		828	32	08-133105-10	BMW		122	2
	NISSAN		683	8				828	33	08-133107-10	BMW		122	2
	RENAULT		884	15	08-125800-00	RENAULT TRUCKS		932	11	08-133200-10	BMW		126	10
	SUZUKI		1033	9	08-126000-00	OPEL		736	40	08-133300-10	BMW		141	38
08-123400-30	RENAULT		882	14		SAAB		950	7	08-133900-00	BMW		140	35
08-123407-00	DACIA		201	5		VAUXHALL		1100	41	08-133907-00	BMW		140	35
	NISSAN		683	8	08-126007-00	OPEL		736	40	08-134000-00	UTB		1069	2
	RENAULT		884	15		SAAB		950	7	08-134100-00	CHRYSLER		148	9
	SUZUKI		1033	9		VAUXHALL		1100	41		JEEP		445	5

											
9				9				9			
	VM	1112	4	RENAULT	920	43	08-140507-00	COMPRESSOR	197	26	
08-134200-00	BMW	124	6	VAUXHALL	1106	52	08-140600-00	SMART	1018	2	
08-134800-00	DAEWOO	204	3	08-137600-00	FIAT	261	6	08-140700-00	FORD EUROPE	360	36
08-135000-00	DEUTZ KHD	227	19		LANCIA	464	3	08-140707-00	FORD EUROPE	360	36
08-135300-00	CITROEN	167	6		OPEL	717	2	08-140800-00	FORD EUROPE	360	36
	FORD EUROPE	332	3		SUBARU	1027	1	08-140807-00	FORD EUROPE	360	36
	MAZDA	539	1		SUZUKI	1031	4	08-141200-00	OPEL	730	30
	PEUGEOT	784	8		VAUXHALL	1085	3		SAAB	949	2
	TOYOTA	1053	8	08-137606-00	FIAT	261	6		VAUXHALL	1096	31
08-135305-00	CITROEN	167	6		LANCIA	464	3	08-141207-00	OPEL	730	30
	FORD EUROPE	332	3		OPEL	717	2		SAAB	949	2
	MAZDA	539	1		SUBARU	1027	1		VAUXHALL	1096	31
	PEUGEOT	784	8		SUZUKI	1031	4	08-141300-00	FORD EUROPE	342	14
	TOYOTA	1053	8		VAUXHALL	1085	3	08-141307-00	FORD EUROPE	342	14
08-135307-00	CITROEN	167	6	08-138000-00	FIAT	291	62	08-141400-00	FIAT	280	44
	FORD EUROPE	332	3		IVECO	415	3	08-141800-00	MERCEDES BENZ COMMERCIAL	637	19
	MAZDA	539	1	08-138006-00	FIAT	291	62	08-141900-00	VOLVO COMMERCIAL	1248	15
	PEUGEOT	784	8		IVECO	415	3	08-142000-00	VOLVO COMMERCIAL	1249	18
	TOYOTA	1053	8	08-138008-00	FIAT	291	62	08-142100-00	DEUTZ KHD	222	6
08-135400-00	BMW	124	6		IVECO	415	3	08-142107-00	DEUTZ KHD	222	6
08-135500-00	RENAULT TRUCKS	935	15	08-138200-00	FIAT	268	16	08-142200-00	BMW	136	28
08-135500-10	RENAULT TRUCKS	935	15	08-138400-00	CHRYSLER	146	2	08-142300-00	FIAT	264	11
08-135800-00	CITROEN	187	47		FIAT	264	12		LANCIA	465	7
	PEUGEOT	806	52		LANCIA	466	8	08-142306-00	FIAT	264	11
08-135807-00	CITROEN	187	47		ZASTAVA	1262	2		LANCIA	465	7
	PEUGEOT	806	52	08-138406-00	CHRYSLER	146	2	08-142308-00	FIAT	264	11
08-136000-00	MERCEDES BENZ COMMERCIAL	643	27		FIAT	264	12		LANCIA	465	7
08-136200-00	COMPRESSOR	196	21		LANCIA	466	8	08-142400-00	ALFA ROMEO	24	28
08-136300-00	MERCEDES BENZ	583	16		ZASTAVA	1262	2		FIAT	286	52
08-136400-00	MERCEDES BENZ	594	28	08-138408-00	CHRYSLER	146	2		LANCIA	474	28
08-136400-10	MERCEDES BENZ	593	27		FIAT	264	12	08-142406-00	ALFA ROMEO	24	28
08-136407-00	MERCEDES BENZ	594	28		LANCIA	466	8		FIAT	286	52
08-136500-00	MAN	519	5		ZASTAVA	1262	2		LANCIA	474	28
08-136500-10	MAN	519	5	08-138700-00	DEUTZ KHD	227	19	08-142500-00	VOLVO COMMERCIAL	1245	7
08-136500-30	MAN	520	6	08-138800-00	ALFA ROMEO	29	38	08-142800-00	VOLVO COMMERCIAL	1246	10
08-136600-00	FORD EUROPE	348	22		LANCIA	477	37	08-142900-00	IVECO	427	28
08-136607-00	FORD EUROPE	348	22	08-138900-00	CITROEN	173	15	08-143000-00	VOLKSWAGEN	1216	56
08-136700-00	MERCEDES BENZ	572	1		PEUGEOT	788	13	08-143600-00	SCANIA	961	9
	SMART	1018	1	08-139400-00	CITROEN	174	20	08-143600-10	SCANIA	961	9
08-136705-00	MERCEDES BENZ	572	1		PEUGEOT	791	21		962	10	
	SMART	1018	1	08-139406-00	CITROEN	174	20	08-143800-00	MAN	531	24
08-136707-00	MERCEDES BENZ	572	1		PEUGEOT	791	21	08-144200-00	OPEL	723	14
	SMART	1018	1	08-139407-00	CITROEN	174	20		VAUXHALL	1090	15
08-136800-00	VOLVO COMMERCIAL	1250	21		PEUGEOT	791	21	08-144207-00	OPEL	723	14
08-136900-00	DEUTZ KHD	229	26	08-139500-00	AUDI	78	25		VAUXHALL	1090	15
08-137100-00	MERCEDES BENZ COMMERCIAL	641	25		MITSUBISHI	653	6	08-144700-00	CITROEN	167	7
		643	27		SEAT	992	26		168	10	
08-137200-00	BMW	136	29		SKODA	1013	21	08-145000-00	CUMMINS	198	2
08-137400-00	AUDI	90	36		VOLKSWAGEN	1199	39		DAF	208	7
	PORSCHE	818	6	08-139507-00	AUDI	78	25		IVECO	422	18
	VOLKSWAGEN	1212	49		MITSUBISHI	653	6	08-145007-00	CUMMINS	198	2
08-137500-00	OPEL	742	51		SEAT	992	26		DAF	208	7
	RENAULT	920	42		SKODA	1013	21		IVECO	422	18
	VAUXHALL	1106	51	08-139600-00	AUDI	90	37	08-145008-00	CUMMINS	198	2
08-137500-10	NISSAN	689	25		VOLKSWAGEN	1214	50		DAF	208	7
	OPEL	742	52	08-139800-00	VOLVO	1231	12		IVECO	422	18
	RENAULT	920	43	08-139900-00	COMPRESSOR	194	14	08-145100-00	FIAT	260	2
	VAUXHALL	1106	52		IVECO	415	1	08-145100-10	FIAT	260	2
08-137507-00	OPEL	742	51	08-140000-00	LAND ROVER	482	7	08-145106-00	FIAT	260	2
	RENAULT	920	42	08-140007-00	LAND ROVER	482	7	08-145108-00	FIAT	260	2
	VAUXHALL	1106	51	08-140200-00	DAF	209	12	08-145200-00	ALFA ROMEO	20	21
08-137507-10	NISSAN	689	25	08-140500-00	COMPRESSOR	197	26	08-145206-00	ALFA ROMEO	20	21
	OPEL	742	52					08-145300-00	ALFA ROMEO	21	23

NUMERICAL PARTS LIST









Nummerische Teilenummernliste • Liste des références produits
Liste da referencias









   9				   9				   9			
08-145306-00	ALFA ROMEO	21	23		FIAT	282	48		TALBOT	1038	4
08-145400-00	ALFA ROMEO	17	14		LADA	457	5	08-154500-00	CITROEN	173	16
		18	16		LDV	488	2		PEUGEOT	788	14
	FIAT	277	37		PEUGEOT	796	32		ROVER	943	4
	LANCIA	471	22		ROVER	944	9	08-154600-00	CITROEN	184	39
08-145406-00	ALFA ROMEO	17	14		SUZUKI	1033	12		FIAT	288	56
		18	16		TALBOT	1039	7		LANCIA	475	31
	FIAT	277	37	08-152007-00	CITROEN	179	30		PEUGEOT	802	42
	LANCIA	471	22		FIAT	282	48	08-154605-00	CITROEN	184	39
08-145900-00	MERCEDES BENZ COMMERCIAL	642	26		LADA	457	5		FIAT	288	56
08-146100-00	ALFA ROMEO	16	12		LDV	488	2		LANCIA	475	31
	FIAT	277	38		PEUGEOT	796	32		PEUGEOT	802	42
	LANCIA	471	23		ROVER	944	9	08-154608-00	CITROEN	184	39
	OPEL	732	33		SUZUKI	1033	12		FIAT	288	56
	SAAB	949	4		TALBOT	1039	7		LANCIA	475	31
	VAUXHALL	1097	34	08-152010-00	CITROEN	179	30		PEUGEOT	802	42
08-146106-00	ALFA ROMEO	16	12		FIAT	282	48	08-154700-00	CITROEN	185	40
	FIAT	277	38		LADA	457	5		PEUGEOT	803	43
	LANCIA	471	23		LDV	488	2	08-154900-00	CITROEN	184	36
	OPEL	732	33		PEUGEOT	796	32		FIAT	288	54
	SAAB	949	4		ROVER	944	9		PEUGEOT	801	39
	VAUXHALL	1097	34		SUZUKI	1033	12	08-154908-00	CITROEN	184	36
08-146108-00	ALFA ROMEO	16	12		TALBOT	1039	7		FIAT	288	54
	FIAT	277	38	08-152011-00	CITROEN	179	30		PEUGEOT	801	39
	LANCIA	471	23		FIAT	282	48	08-155200-00	CUMMINS	198	1
	OPEL	732	33		LADA	457	5	08-155600-10	CUMMINS	198	4
	SAAB	949	4		LDV	488	2	08-160800-00	DEUTZ KHD	230	28
	VAUXHALL	1097	34		PEUGEOT	796	32	08-160807-00	DEUTZ KHD	230	28
08-146300-00	MERCEDES BENZ COMMERCIAL	628	7		ROVER	944	9	08-160811-00	DEUTZ KHD	230	28
08-146300-10	MERCEDES BENZ COMMERCIAL	628	7		SUZUKI	1033	12	08-160814-00	DEUTZ KHD	230	28
08-146400-00	MERCEDES BENZ COMMERCIAL	628	8		TALBOT	1039	7	08-163500-00	MERCEDES BENZ	572	2
08-146500-00	DEUTZ KHD	222	8	08-152700-00	CITROEN	188	49	08-163511-00	MERCEDES BENZ	572	2
08-146507-00	DEUTZ KHD	222	8		FIAT	294	68	08-163600-00	MERCEDES BENZ	581	13
08-147100-00	CITROEN	167	7		PEUGEOT	807	54	08-164400-00	DEUTZ KHD	223	9
08-147300-10	CITROEN	188	49		TALBOT	1040	10	08-164407-00	DEUTZ KHD	223	9
	PEUGEOT	807	54	08-152707-00	CITROEN	188	49	08-164411-00	DEUTZ KHD	223	9
	RENAULT	923	49		FIAT	294	68	08-164500-10	DAF	208	6
	RENAULT TRUCKS	929	3		PEUGEOT	807	54	08-165800-00	COMPRESSOR	194	12
	TALBOT	1040	10		TALBOT	1040	10	08-165805-00	COMPRESSOR	194	12
08-147800-00	CITROEN	168	9	08-152900-00	CITROEN	188	50	08-166400-00	DEUTZ KHD	223	10
08-147900-00	CITROEN	175	22		PEUGEOT	807	55	08-166407-00	DEUTZ KHD	223	10
08-148100-00	FORD EUROPE	367	47		TALBOT	1040	9	08-166411-00	DEUTZ KHD	223	10
	LAND ROVER	483	9	08-154200-00	CITROEN	165	1	08-167600-10	DEUTZ KHD	232	33
08-148105-00	FORD EUROPE	367	47		FIAT	263	10			232	34
	LAND ROVER	483	9		LANCIA	465	6	08-167607-10	DEUTZ KHD	232	33
08-148107-00	FORD EUROPE	367	47		PEUGEOT	782	2			232	34
	LAND ROVER	483	9	08-154206-00	CITROEN	165	1	08-167611-10	DEUTZ KHD	232	33
08-148300-00	AUDI	76	23		FIAT	263	10			232	34
	SEAT	991	24		LANCIA	465	6	08-167700-00	DEUTZ KHD	231	30
	SKODA	1013	20		PEUGEOT	782	2	08-170600-10	MERCEDES BENZ	589	23
	VOLKSWAGEN	1198	38	08-154208-00	CITROEN	165	1		SEAT	996	33
08-150900-00	CITROEN	174	19		FIAT	263	10	08-170607-10	MERCEDES BENZ	589	23
08-151200-00	CITROEN	177	27		LANCIA	465	6		SEAT	996	33
	PEUGEOT	793	29		PEUGEOT	782	2	08-170611-10	MERCEDES BENZ	589	23
08-152000-00	CITROEN	179	30	08-154300-00	CITROEN	166	3		SEAT	996	33
	FIAT	282	48		PEUGEOT	783	5	08-170700-10	MERCEDES BENZ	587	22
	LADA	457	5	08-154307-00	CITROEN	166	3			589	23
	LDV	488	2		PEUGEOT	783	5		SEAT	996	33
	PEUGEOT	796	32	08-154400-00	CITROEN	171	14	08-170707-10	MERCEDES BENZ	587	22
	ROVER	944	9		PEUGEOT	786	12			589	23
	SUZUKI	1033	12		TALBOT	1038	4		SEAT	996	33
	TALBOT	1039	7	08-154407-00	CITROEN	171	14	08-170711-10	MERCEDES BENZ	587	22
08-152003-00	CITROEN	179	30		PEUGEOT	786	12			589	23

08-171200-10	SEAT	996	33	08-176411-10	MERCEDES BENZ COMMERCIAL	628	10	08-181400-10	MERCEDES BENZ	597	32
08-171600-10	MERCEDES BENZ COMMERCIAL	633	14	08-176411-30	MERCEDES BENZ COMMERCIAL	628	10	08-181407-10	MERCEDES BENZ	597	32
08-171607-10	MERCEDES BENZ COMMERCIAL	628	10	08-176414-10	MERCEDES BENZ COMMERCIAL	628	10	08-181500-10	MERCEDES BENZ	583	17
08-171611-10	MERCEDES BENZ COMMERCIAL	628	10	08-176414-30	MERCEDES BENZ COMMERCIAL	628	10	08-181600-10 1	MERCEDES BENZ	584	18
08-171614-10	MERCEDES BENZ COMMERCIAL	628	10	08-176600-00	MERCEDES BENZ	581	15	08-181607-10	MERCEDES BENZ	584	18
08-172500-00	DEUTZ KHD	224	12	08-176607-00	MERCEDES BENZ COMMERCIAL	581	15	08-181611-10	MERCEDES BENZ	584	18
		225	15	08-176611-00	MERCEDES BENZ	581	15	08-181700-00	MERCEDES BENZ COMMERCIAL	636	16
08-172507-00	DEUTZ KHD	224	12	08-176700-00	MERCEDES BENZ	606	38	08-181700-20	MERCEDES BENZ COMMERCIAL	636	16
		225	15			607	39	08-181800-00	JOHN DEERE	447	1
08-172511-00	DEUTZ KHD	224	12	08-176707-00	MERCEDES BENZ	606	38	08-182400-10	MERCEDES BENZ	612	48
		225	15			607	39	08-182500-10	DAF	209	11
08-172600-00	DEUTZ KHD	235	40	08-176708-00	MERCEDES BENZ	606	38	08-182700-00	MERCEDES BENZ	613	49
08-172700-00	MERCEDES BENZ COMMERCIAL	631	13			607	39	08-182707-00	MERCEDES BENZ	613	49
08-172800-10	DEUTZ KHD	231	31	08-176711-00	MERCEDES BENZ	606	38	08-182711-00	MERCEDES BENZ	613	49
08-172900-10	DEUTZ KHD	232	32			607	39	08-182800-00	MERCEDES BENZ	608	41
08-173800-00	MERCEDES BENZ	607	39	08-176800-10	MERCEDES BENZ COMMERCIAL	631	13	08-182900-00	MERCEDES BENZ	589	24
		608	40	08-176800-20	MERCEDES BENZ COMMERCIAL	631	13	08-182907-00	MERCEDES BENZ	589	24
08-173805-00	MERCEDES BENZ	607	39	08-176807-20	MERCEDES BENZ COMMERCIAL	631	13	08-183000-00	MERCEDES BENZ	596	30
		608	40	08-176900-10	MERCEDES BENZ COMMERCIAL	633	14	08-183007-00	MERCEDES BENZ	596	30
08-173807-00	MERCEDES BENZ	607	39	08-176900-80	MERCEDES BENZ COMMERCIAL	633	14	08-183100-00	MERCEDES BENZ	575	7
		608	40	08-176907-10	MERCEDES BENZ COMMERCIAL	633	14	08-183107-00	MERCEDES BENZ	575	7
08-173811-00	MERCEDES BENZ	607	39	08-176907-80	MERCEDES BENZ COMMERCIAL	633	14	08-183111-00	MERCEDES BENZ	575	7
		608	40	08-176911-10	MERCEDES BENZ COMMERCIAL	633	14	08-183200-00	MERCEDES BENZ	584	19
08-174100-10	DAF	210	14	08-176911-80	MERCEDES BENZ COMMERCIAL	633	14	08-183207-00	MERCEDES BENZ	584	19
	LEYLAND	495	11	08-176914-10	MERCEDES BENZ COMMERCIAL	633	14	08-183300-00	MERCEDES BENZ	586	21
08-174300-10	MERCEDES BENZ COMMERCIAL	625	2	08-177400-00	COMPRESSOR	196	24	08-183307-00	MERCEDES BENZ	586	21
		626	3	08-177405-00	COMPRESSOR	196	24	08-202400-10	FORD COMMERCIAL	298	8
08-174300-70	MERCEDES BENZ COMMERCIAL	625	2	08-177407-00	COMPRESSOR	196	24		FORD TRACTOR	379	6
		626	3	08-177800-00	DEUTZ KHD	232	33			380	7
08-174305-10	MERCEDES BENZ COMMERCIAL	625	2	08-178200-00	MERCEDES BENZ COMMERCIAL	625	2		PERKINS	761	26
		626	3	08-178207-00	MERCEDES BENZ COMMERCIAL	625	2	08-202407-10	FORD COMMERCIAL	298	8
08-174305-70	MERCEDES BENZ COMMERCIAL	625	2	08-178211-00	MERCEDES BENZ COMMERCIAL	625	2		FORD TRACTOR	379	6
		626	3	08-178300-00	MERCEDES BENZ COMMERCIAL	636	16			380	7
08-174307-10	MERCEDES BENZ COMMERCIAL	625	2	08-178400-10	DEUTZ KHD	227	19		PERKINS	761	26
		626	3			227	20	08-202409-10	FORD COMMERCIAL	298	8
08-174307-70	MERCEDES BENZ COMMERCIAL	625	2	08-178407-10	DEUTZ KHD	227	19		FORD TRACTOR	379	6
		626	3			227	20			380	7
08-174309-10	MERCEDES BENZ COMMERCIAL	625	2	08-178500-10	MERCEDES BENZ	609	43		PERKINS	761	26
		626	3	08-178800-00	MERCEDES BENZ COMMERCIAL	626	3	08-202800-00	FORD COMMERCIAL	297	3
08-174311-10	MERCEDES BENZ COMMERCIAL	625	2	08-178807-00	MERCEDES BENZ COMMERCIAL	626	3	08-202807-00	FORD COMMERCIAL	297	3
		626	3	08-178811-00	MERCEDES BENZ COMMERCIAL	626	3	08-202809-00	FORD COMMERCIAL	297	3
08-174311-70	MERCEDES BENZ COMMERCIAL	625	2	08-178900-10	MERCEDES BENZ	610	46	08-202811-00	FORD COMMERCIAL	297	3
		626	3	08-178906-10	MERCEDES BENZ	610	46	08-203100-00	FIAT	270	24
08-174314-10	MERCEDES BENZ COMMERCIAL	625	2	08-178910-10	MERCEDES BENZ	610	46		LANCIA	467	13
		626	3	08-178911-10	MERCEDES BENZ	610	46		SEAT	988	18
08-174600-10	DEUTZ KHD	228	22	08-179000-10	DAF	208	9		ZASTAVA	1262	4
		228	24	08-179300-10	MERCEDES BENZ COMMERCIAL	635	15	08-203104-00	FIAT	270	24
08-174607-10	DEUTZ KHD	228	22	08-179300-20	MERCEDES BENZ COMMERCIAL	635	15		LANCIA	467	13
		228	24	08-179400-00	DEUTZ KHD	225	15		SEAT	988	18
08-175000-00	DEUTZ KHD	222	5			225	16		ZASTAVA	1262	4
08-175500-00	MERCEDES BENZ	584	18	08-179407-00	DEUTZ KHD	225	15	08-203106-00	FIAT	270	24
08-175507-00	MERCEDES BENZ	584	18			225	16		LANCIA	467	13
08-175511-00	MERCEDES BENZ	584	18	08-179411-00	DEUTZ KHD	225	15		SEAT	988	18
						225	16		ZASTAVA	1262	4
08-176000-00	MERCEDES BENZ COMMERCIAL	630	12	08-179500-00	MERCEDES BENZ	597	32	08-203108-00	FIAT	270	24
08-176000-20	MERCEDES BENZ COMMERCIAL	630	12	08-179505-00	MERCEDES BENZ	597	32		LANCIA	467	13
08-176300-00	COMPRESSOR	196	22	08-179507-00	MERCEDES BENZ	597	32		SEAT	988	18
08-176307-00	COMPRESSOR	196	22	08-179511-00	MERCEDES BENZ	597	32		ZASTAVA	1262	4
08-176311-00	COMPRESSOR	196	22	08-179700-00	MERCEDES BENZ	611	47	08-203110-00	FIAT	270	24
08-176400-10	MERCEDES BENZ COMMERCIAL	628	10	08-179707-00	MERCEDES BENZ	611	47		LANCIA	467	13
08-176400-30	MERCEDES BENZ COMMERCIAL	628	10	08-179711-00	MERCEDES BENZ	611	47		SEAT	988	18
08-176407-10	MERCEDES BENZ COMMERCIAL	628	10	08-181000-00	MERCEDES BENZ COMMERCIAL	629	11		ZASTAVA	1262	4
08-176407-30	MERCEDES BENZ COMMERCIAL	628	10	08-181100-00	JOHN DEERE	447	2	08-203111-00	FIAT	270	24

NUMERICAL PARTS LIST









Nummerische Teilenummernliste • Liste des références produits
Liste da referencias









   9	   9	   9
LANCIA 467 13	08-207800-30 IVECO 435 48	08-214811-10 FORD COMMERCIAL 298 7
SEAT 988 18	NEW HOLLAND 669 20	FORD TRACTOR 379 4
ZASTAVA 1262 4	08-208100-00 FORD COMMERCIAL 298 5	08-214900-10 DEUTZ KHD 230 29
08-203500-10 FORD COMMERCIAL 297 1	FORD TRACTOR 378 3	IVECO 428 29
297 1	08-208107-00 FORD COMMERCIAL 298 5	NEW HOLLAND 668 15
FORD TRACTOR 378 2	FORD TRACTOR 378 3	08-215100-10 FIAT 281 45
08-204500-00 FORD EUROPE 367 48	08-208109-00 FORD COMMERCIAL 298 5	SEAT 995 31
SAAB 952 11	FORD TRACTOR 378 3	08-215108-10 FIAT 281 45
08-205800-00 FORD EUROPE 364 42	08-208111-00 FORD COMMERCIAL 298 5	SEAT 995 31
08-205807-00 FORD EUROPE 364 42	FORD TRACTOR 378 3	08-215110-10 FIAT 281 45
08-206600-00 FORD EUROPE 368 50	08-208800-00 FORD EUROPE 332 5	SEAT 995 31
08-206607-00 FORD EUROPE 368 50	08-208807-00 FORD EUROPE 332 5	08-215200-10 FIAT 269 20
08-206611-00 FORD EUROPE 368 50	08-208811-00 FORD EUROPE 332 5	08-215206-10 FIAT 269 20
08-206617-00 FORD EUROPE 368 50	08-209700-00 FIAT 289 57	08-215208-10 FIAT 269 20
08-206800-00 IVECO 420 14	LANCIA 476 33	08-215211-10 FIAT 269 20
422 17	08-209706-00 FIAT 289 57	08-215300-10 ALFA ROMEO 23 26
NEW HOLLAND 665 4	LANCIA 476 33	FIAT 284 51
666 6	08-209708-00 FIAT 289 57	LANCIA 472 27
08-206800-40 IVECO 420 14	LANCIA 476 33	SEAT 995 32
422 17	08-209800-00 FIAT 259 1	UAZ 1067 1
NEW HOLLAND 665 4	LANCIA 464 1	08-215306-10 ALFA ROMEO 23 26
666 6	SEAT 977 1	FIAT 284 51
08-206808-00 IVECO 420 14	ZASTAVA 1262 1	LANCIA 472 27
422 17	08-209806-00 FIAT 259 1	SEAT 995 32
NEW HOLLAND 665 4	LANCIA 464 1	UAZ 1067 1
666 6	SEAT 977 1	08-215308-10 ALFA ROMEO 23 26
08-206808-40 IVECO 420 14	ZASTAVA 1262 1	FIAT 284 51
422 17	08-209808-00 FIAT 259 1	LANCIA 472 27
NEW HOLLAND 665 4	LANCIA 464 1	SEAT 995 32
666 6	SEAT 977 1	UAZ 1067 1
08-207000-00 COMPRESSOR 193 5	ZASTAVA 1262 1	08-215500-10 FORD EUROPE 347 21
08-207200-00 IVECO 419 12	08-214100-00 FORD EUROPE 345 19	08-215507-10 FORD EUROPE 347 21
NEW HOLLAND 665 3	08-214107-00 FORD EUROPE 345 19	08-215511-10 FORD EUROPE 347 21
UTB 1069 1	08-214109-00 FORD EUROPE 345 19	08-227700-00 HONDA 386 4
08-207208-00 IVECO 419 12	08-214111-00 FORD EUROPE 345 19	08-227800-00 HONDA 386 6
NEW HOLLAND 665 3	08-214400-10 CITROEN 188 49	08-228300-00 HONDA 385 1
UTB 1069 1	FIAT 293 66	TRIUMPH 1065 1
08-207300-10 FORD EUROPE 373 56	IVECO 417 7	08-228400-00 HONDA 385 2
08-207311-10 FORD EUROPE 373 56	PEUGEOT 807 54	08-241300-00 IHC 396 1
08-207321-10 FORD EUROPE 373 56	RENAULT 923 49	08-243300-00 IHC 396 2
08-207400-00 FORD EUROPE 349 23	RENAULT TRUCKS 929 3	08-243400-00 IHC 396 4
08-207500-00 IVECO 427 27	SEAT 996 34	08-243600-00 IHC 396 3
NEW HOLLAND 667 12	TALBOT 1040 10	08-244500-00 IVECO 426 24
08-207600-00 FIAT 283 50	08-214500-10 ALFA ROMEO 28 35	NEW HOLLAND 667 10
284 51	FIAT 293 66	08-244600-00 IHC 397 6
LANCIA 472 27	IVECO 417 7	08-244800-00 IHC 397 5
SEAT 995 32	RENAULT 923 49	08-245200-00 ALFA ROMEO 27 34
08-207604-00 FIAT 283 50	RENAULT TRUCKS 929 3	FIAT 292 64
284 51	SEAT 996 34	IVECO 416 5
LANCIA 472 27	08-214508-10 ALFA ROMEO 28 35	LANCIA 477 35
SEAT 995 32	FIAT 293 66	NEW HOLLAND 665 2
08-207606-00 FIAT 283 50	IVECO 417 7	RENAULT 922 47
284 51	RENAULT 923 49	08-245208-00 ALFA ROMEO 27 34
LANCIA 472 27	RENAULT TRUCKS 929 3	FIAT 292 64
SEAT 995 32	SEAT 996 34	IVECO 416 5
08-207608-00 FIAT 283 50	08-214700-00 FORD EUROPE 372 55	LANCIA 477 35
284 51	RELIANT 832 3	RENAULT 922 47
LANCIA 472 27	08-214800-10 FORD COMMERCIAL 298 7	08-245300-00 IFA 394 1
SEAT 995 32	FORD TRACTOR 379 4	08-245311-00 IFA 394 1
08-207700-00 IVECO 431 37	08-214807-10 FORD COMMERCIAL 298 7	08-245400-00 ISUZU 403 3
08-207800-10 IVECO 436 49	FORD TRACTOR 379 4	08-245500-00 IVECO 429 30
NEW HOLLAND 669 20	08-214809-10 FORD COMMERCIAL 298 7	NEW HOLLAND 668 16
670 21	FORD TRACTOR 379 4	08-246200-00 ISUZU 405 7

   9				   9				   9			
08-246900-00	IFA	394	1	08-267411-00	LOMBARDINI	500	2	08-283100-00	MAN	529	23
		394	2	08-267500-00	LOMBARDINI	500	3	08-283100-30	MAN	529	23
08-246907-00	IFA	394	1	08-267507-00	LOMBARDINI	500	3	08-283300-00	MAN	516	2
		394	2	08-267511-00	LOMBARDINI	500	3	08-283600-00	FORD EUROPE	363	39
08-246911-00	IFA	394	1	08-267600-00	LOMBARDINI	500	4		ISEKI	399	5
		394	2	08-267607-00	LOMBARDINI	500	4		KIA	450	7
08-247000-00	BEDFORD	104	6	08-267611-00	LOMBARDINI	500	4		MAZDA	541	10
	ISUZU	403	2	08-267700-00	LOMBARDINI	501	5		SUZUKI	1034	15
08-247200-00	BEDFORD	105	8	08-267707-00	LOMBARDINI	501	5		YANMAR	1260	6
	ISEKI	399	4	08-267711-00	LOMBARDINI	501	5	08-283607-00	FORD EUROPE	363	39
	ISUZU	404	4	08-268300-00	LOMBARDINI	500	1		ISEKI	399	5
	YANMAR	1260	7	08-268307-00	LOMBARDINI	500	1		KIA	450	7
08-247200-10	BEDFORD	105	8	08-268311-00	LOMBARDINI	500	1		MAZDA	541	10
	ISUZU	404	4	08-269400-00	COMPRESSOR	193	6		SUZUKI	1034	15
	YANMAR	1260	7	08-269700-00	FIAT	268	19		YANMAR	1260	6
08-247207-00	BEDFORD	105	8		LADA	455	1	08-283611-00	FORD EUROPE	363	39
	ISEKI	399	4	08-269704-00	FIAT	268	19		ISEKI	399	5
	ISUZU	404	4		LADA	455	1		KIA	450	7
	YANMAR	1260	7	08-269706-00	FIAT	268	19		MAZDA	541	10
08-247211-00	BEDFORD	105	8		LADA	455	1		SUZUKI	1034	15
	ISEKI	399	4	08-269710-00	FIAT	268	19		YANMAR	1260	6
	ISUZU	404	4		LADA	455	1	08-283700-00	MAZDA	540	8
	YANMAR	1260	7	08-269800-00	LADA	456	2	08-283800-00	MAZDA	540	7
08-247300-00	BEDFORD	105	8		MOSKVIC	658	1	08-283900-00	FORD EUROPE	340	12
	ISUZU	404	4	08-269806-00	LADA	456	2		MAZDA	540	5
08-247600-00	ISUZU	404	5		MOSKVIC	658	1	08-284100-00	MAZDA	542	13
		404	6	08-269820-00	LADA	456	2	08-285400-00	HYUNDAI	391	6
	OPEL	742	49		MOSKVIC	658	1		MITSUBISHI	652	2
	VAUXHALL	1106	49	08-269900-00	LADA	456	3	08-285500-00	MAN	523	11
08-247800-00	IVECO	424	22		MOSKVIC	658	2	08-285505-00	MAN	523	11
	NEW HOLLAND	667	9	08-269906-00	LADA	456	3	08-285600-00	MWM	663	9
08-247808-00	IVECO	424	22		MOSKVIC	658	2	08-285800-00	MAN	516	3
	NEW HOLLAND	667	9	08-269910-00	LADA	456	3	08-285900-00	MAN	517	4
08-248000-00	ISUZU	405	7		MOSKVIC	658	2	08-286700-00	HYUNDAI	390	2
08-248000-10	ISUZU	405	7	08-273400-10	MAN	516	1		MITSUBISHI	652	1
08-248200-00	COMPRESSOR	192	4	08-273800-00	MWM	661	3		PROTON	830	1
08-248207-00	COMPRESSOR	192	4	08-274100-10	MAN	521	7	08-287000-00	MITSUBISHI	653	4
08-251000-00	COMPRESSOR	195	19	08-274200-10	MAN	525	14	08-287100-00	HYUNDAI	392	10
08-251007-00	COMPRESSOR	195	19		RAB UNGARN	831	2		MITSUBISHI	655	10
08-251011-00	COMPRESSOR	195	19	08-274207-10	RAB UNGARN	831	2	08-287107-00	HYUNDAI	392	10
08-251300-10	BARRERAS	101	1	08-274800-10	MAN	525	14		MITSUBISHI	655	10
	DEUTZ KHD	235	41			525	15	08-287200-00	MITSUBISHI	653	5
08-252200-00	DEUTZ KHD	221	4	08-275000-10	MAN	521	7	08-287400-00	MERCEDES BENZ	598	33
08-252300-00	DEUTZ KHD	221	3	08-275800-00	MALKOTSIS	505	1	08-287500-00	MERCEDES BENZ	601	35
08-252500-00	DEUTZ KHD	221	4	08-277000-00	MOSKVIC	658	2		SSANGYONG	1021	2
08-252507-00	DEUTZ KHD	221	4	08-278000-00	MWM	660	2	08-287505-00	MERCEDES BENZ	601	35
08-252600-00	DEUTZ KHD	227	19	08-278100-00	MWM	662	6		SSANGYONG	1021	2
08-252800-00	DEUTZ KHD	222	7	08-278200-00	MWM	660	1	08-287507-00	MERCEDES BENZ	601	35
08-252807-00	DEUTZ KHD	222	7	08-279200-10	MAN	526	17		SSANGYONG	1021	2
08-252900-00	DEUTZ KHD	221	1	08-279400-00	MWM	661	4	08-287600-00	CHRYSLER	147	7
08-253200-00	KIA	449	4	08-279600-00	MWM	662	6		HYUNDAI	392	11
08-253300-00	MAZDA	541	11			662	7	08-287700-00	MERCEDES BENZ	596	31
08-253400-00	KOMATSU	451	1	08-280000-10	MAN	521	7	08-287800-00	MERCEDES BENZ	610	44
08-263100-00	LAND ROVER	483	10	08-280200-00	MAN	527	19			610	45
	ROVER	946	14	08-280400-10	MAN	528	20	08-287900-00	MERCEDES BENZ	581	14
08-263107-00	LAND ROVER	483	10	08-280500-00	MWM	662	8	08-288000-00	HYUNDAI	392	9
	ROVER	946	14	08-281500-00	MWM	661	5		MITSUBISHI	654	9
08-265100-10	LAND ROVER	484	11	08-281511-00	MWM	661	5	08-288000-10	MITSUBISHI	654	9
08-265107-10	LAND ROVER	484	11	08-282200-10	MAN	532	25	08-288007-10	MITSUBISHI	654	9
08-265109-10	LAND ROVER	484	11	08-282400-10	MAN	526	18	08-288200-00	HYUNDAI	393	12
08-265111-10	LAND ROVER	484	11		PEGASO	749	6		ISEKI	400	7
08-267400-00	LOMBARDINI	500	2	08-282700-10	KIA	450	6		MITSUBISHI	656	12
08-267407-00	LOMBARDINI	500	2		MAZDA	541	9		YANMAR	1260	9

NUMERICAL PARTS LIST









Nummerische Teilenummernliste • Liste des références produits
Liste da referencias









   9				   9				   9			
08-288300-00	mitsubishi	656	14	08-305507-00	Opel	720	11		Vauxhall	1104	46
08-288307-00	MITSUBISHI	656	14		Vauxhall	1088	12	08-306900-00	BEDFORD	103	3
08-288800-00	MERCEDES BENZ COMMERCIAL	626	4	08-305600-00	OPEL	729	26		OPEL	724	18
08-288807-00	MERCEDES BENZ COMMERCIAL	626	4		Vauxhall	1095	27		Vauxhall	1091	19
08-288900-00	MOSKVICH	658	3	08-305607-00	OPEL	729	26	08-306907-00	BEDFORD	103	3
08-289000-00	MAZ	535	1		Vauxhall	1095	27		OPEL	724	18
08-289100-00	MAZ	535	1	08-305611-00	OPEL	729	26		Vauxhall	1091	19
08-289200-00	MAHINDRA	504	1		Vauxhall	1095	27	08-307000-00	ISUZU	403	1
08-289300-00	MERCEDES BENZ COMMERCIAL	627	6	08-305900-10	BEDFORD	104	5		OPEL	721	12
08-289300-30	MERCEDES BENZ COMMERCIAL	627	6		OPEL	728	25		Vauxhall	1089	13
08-289400-00	MAN	533	29		Vauxhall	1095	26	08-307007-00	ISUZU	403	1
08-289600-00	MERCEDES BENZ COMMERCIAL	641	25	08-305907-10	BEDFORD	104	5		OPEL	721	12
08-289700-00	MERCEDES BENZ	611	47		OPEL	728	25		Vauxhall	1089	13
08-291400-00	NISSAN	680	4		Vauxhall	1095	26	08-307011-00	ISUZU	403	1
08-291900-10	LEYLAND	494	8	08-305911-10	BEDFORD	104	5		OPEL	721	12
	NUFFIELD TRACTOR	693	1		OPEL	728	25		Vauxhall	1089	13
08-292800-00	ISEKI	399	2		Vauxhall	1095	26	08-307100-00	OPEL	721	13
	NISSAN	686	17	08-306000-00	OPEL	736	41		Vauxhall	1089	14
	YANMAR	1259	3		Vauxhall	1101	42	08-307107-00	OPEL	721	13
08-293400-00	NISSAN	684	12	08-306007-00	OPEL	736	41		Vauxhall	1089	14
08-293500-10	NISSAN	687	20		Vauxhall	1101	42	08-307200-00	OPEL	736	41
08-294400-00	NISSAN	681	6	08-306100-00	OPEL	736	41			737	42
08-294500-00	NISSAN	690	28		Vauxhall	1101	42		Vauxhall	1101	42
08-294700-00	NISSAN	680	1	08-306200-00	OPEL	723	16			1102	43
08-294707-00	NISSAN	680	1		Vauxhall	1091	17	08-307207-00	OPEL	736	41
08-294800-00	NISSAN	685	14	08-306300-00	BEDFORD	103	2			737	42
08-294900-00	NISSAN	681	5		OPEL	720	11		Vauxhall	1101	42
08-295100-00	NISSAN	691	32		Vauxhall	1088	12			1102	43
08-295200-00	NISSAN	692	33	08-306307-00	BEDFORD	103	2	08-307300-00	OPEL	746	62
08-295400-00	ISEKI	399	3		OPEL	720	11		Vauxhall	1109	59
	NISSAN	687	21		Vauxhall	1088	12	08-307307-00	OPEL	746	62
	YANMAR	1259	5	08-306311-00	BEDFORD	103	2		Vauxhall	1109	59
08-302200-00	OPEL	718	4		OPEL	720	11	08-307400-00	OPEL	742	50
	Vauxhall	1086	5		Vauxhall	1088	12		Vauxhall	1106	50
08-302207-00	OPEL	718	4	08-306400-00	OPEL	723	15	08-307500-00	OPEL	718	5
	Vauxhall	1086	5			723	16		Vauxhall	1087	8
08-302600-00	OPEL	744	57		Vauxhall	1090	16	08-307507-00	OPEL	718	5
08-303200-00	OPEL	741	46			1091	17		Vauxhall	1087	8
08-304000-00	OPEL	738	43	08-306500-00	OPEL	746	61	08-307600-00	MAZDA	540	6
	Vauxhall	1103	44	08-306600-00	OPEL	743	55		OPEL	725	19
08-304200-00	OPEL	723	17		Vauxhall	1107	54		Vauxhall	1092	20
	Vauxhall	1091	18	08-306607-00	OPEL	743	55	08-307607-00	MAZDA	540	6
08-304207-00	OPEL	723	17		Vauxhall	1107	54		OPEL	725	19
	Vauxhall	1091	18	08-306700-00	BEDFORD	104	7		Vauxhall	1092	20
08-304211-00	OPEL	723	17		OPEL	732	34	08-307700-00	OPEL	731	31
	Vauxhall	1091	18		Vauxhall	1098	35		SAAB	949	3
08-305000-00	BEDFORD	105	10	08-306707-00	BEDFORD	104	7		Vauxhall	1097	32
	OPEL	745	60		OPEL	732	34	08-307707-00	OPEL	731	31
	Vauxhall	1108	58		Vauxhall	1098	35		SAAB	949	3
08-305007-00	BEDFORD	105	10	08-306711-00	BEDFORD	104	7		Vauxhall	1097	32
	OPEL	745	60		OPEL	732	34	08-307711-00	OPEL	731	31
	Vauxhall	1108	58		Vauxhall	1098	35		SAAB	949	3
08-305400-10	BEDFORD	105	9	08-306800-00	LADA	457	7		Vauxhall	1097	32
	OPEL	743	54		OPEL	739	45	08-307800-00	OPEL	727	21
	Vauxhall	1107	53		SAAB	950	8		Vauxhall	1093	22
08-305407-10	BEDFORD	105	9		Vauxhall	1104	46	08-307807-00	OPEL	727	21
	OPEL	743	54	08-306807-00	LADA	457	7		Vauxhall	1093	22
	Vauxhall	1107	53		OPEL	739	45	08-307811-00	OPEL	727	21
08-305411-10	BEDFORD	105	9		SAAB	950	8		Vauxhall	1093	22
	OPEL	743	54		Vauxhall	1104	46	08-313100-00	PERKINS	752	4
	Vauxhall	1107	53	08-306811-00	LADA	457	7			753	5
08-305500-00	OPEL	720	11		OPEL	739	45			754	6
	Vauxhall	1088	12		SAAB	950	8	08-313400-00	ALFA ROMEO	13	8

   9				   9				   9			
	BEDFORD	104	4		SSANGYONG	1022	5			757	13
	FORD EUROPE	344	16		TALBOT	1040	11			759	16
	PERKINS	751	1		UAZ	1067	3		URSUS	1068	2
08-313800-10	FORD EUROPE	365	44		VOLGA	1113	3		VOLVO COMMERCIAL	1245	8
	PEUGEOT	804	46	08-318704-10	ARO	32	5	08-318905-10	LEYLAND	494	7
	VOLGA	1113	1		CITROEN	189	51		PERKINS	755	10
08-314600-00	FORD TRACTOR	378	1		DAF	207	4			757	13
	PERKINS	752	4		FORD EUROPE	376	61			759	16
		753	5		LDV	489	6		URSUS	1068	2
		754	6		PEUGEOT	807	56		VOLVO COMMERCIAL	1245	8
		755	8		SSANGYONG	1022	5	08-319000-10	PERKINS	759	15
	URSUS	1068	1		TALBOT	1040	11			760	17
08-314900-10	ARO	31	4		UAZ	1067	3	08-319005-10	PERKINS	759	15
	FORD EUROPE	368	49		VOLGA	1113	3			760	17
	OPEL	743	53	08-318706-10	ARO	32	5	08-319100-10	PEUGEOT	791	22
	PEUGEOT	805	48		CITROEN	189	51	08-319300-10	PEGASO	749	7
	VOLVO COMMERCIAL	1243	3		DAF	207	4	08-319400-00	CITROEN	166	5
08-315000-10	LEYLAND	494	7		FORD EUROPE	376	61		PEUGEOT	783	7
	PERKINS	756	12		LDV	489	6		TALBOT	1037	2
		758	14		PEUGEOT	807	56	08-319500-10	PORSCHE	817	3
		759	15		SSANGYONG	1022	5	08-319600-10	PORSCHE	817	4
		759	16		TALBOT	1040	11	08-319700-10	PORSCHE	819	10
08-315007-10	PERKINS	756	12		UAZ	1067	3	08-319800-10	PORSCHE	819	9
		758	14		VOLGA	1113	3	08-319900-10	PORSCHE	821	16
		759	15	08-318707-10	ARO	32	5	08-320000-10	PORSCHE	820	14
		759	16		CITROEN	189	51			821	17
08-315200-00	ALFA ROMEO	13	8		DAF	207	4	08-320100-00	PEUGEOT	789	18
	BEDFORD	104	4		FORD EUROPE	376	61	08-320200-10	DAF	207	5
	FORD EUROPE	344	16		LDV	489	6		FORD EUROPE	376	60
	PERKINS	751	2		PEUGEOT	807	56		LDV	489	7
08-315300-00	CITROEN	181	32		SSANGYONG	1022	5		PEUGEOT	808	57
	PEUGEOT	798	35		TALBOT	1040	11		SSANGYONG	1022	4
08-315307-00	CITROEN	181	32		UAZ	1067	3		TALBOT	1040	12
	PEUGEOT	798	35		VOLGA	1113	3	08-320204-10	DAF	207	5
08-316900-00	CITROEN	186	44	08-318708-10	ARO	32	5		FORD EUROPE	376	60
	FIAT	290	60		CITROEN	189	51		LDV	489	7
	PEUGEOT	804	47		DAF	207	4		PEUGEOT	808	57
	RENAULT	915	39		FORD EUROPE	376	61		SSANGYONG	1022	4
	TALBOT	1039	8		LDV	489	6		TALBOT	1040	12
	VOLVO	1234	19		PEUGEOT	807	56	08-320206-10	DAF	207	5
08-316907-00	CITROEN	186	44		SSANGYONG	1022	5		FORD EUROPE	376	60
	FIAT	290	60		TALBOT	1040	11		LDV	489	7
	PEUGEOT	804	47		UAZ	1067	3		PEUGEOT	808	57
	RENAULT	915	39		VOLGA	1113	3		SSANGYONG	1022	4
	TALBOT	1039	8	08-318710-10	ARO	32	5		TALBOT	1040	12
	VOLVO	1234	19		CITROEN	189	51	08-320208-10	DAF	207	5
08-317200-00	PERKINS	751	3		DAF	207	4		FORD EUROPE	376	60
08-317300-00	CITROEN	165	1		FORD EUROPE	376	61		LDV	489	7
	PEUGEOT	782	3		LDV	489	6		PEUGEOT	808	57
	TALBOT	1037	1		PEUGEOT	807	56		SSANGYONG	1022	4
08-317600-10	PEUGEOT	790	19		SSANGYONG	1022	5		TALBOT	1040	12
08-318000-10	PERKINS	761	22		TALBOT	1040	11	08-320211-10	DAF	207	5
		761	23		UAZ	1067	3		FORD EUROPE	376	60
08-318400-00	PEGASO	748	3		VOLGA	1113	3		LDV	489	7
08-318500-00	PEGASO	748	4	08-318711-10	ARO	32	5		PEUGEOT	808	57
08-318600-10	PORSCHE	820	13		DAF	207	4		SSANGYONG	1022	4
	VOLKSWAGEN	1219	60		FORD EUROPE	376	61		TALBOT	1040	12
08-318700-10	ARO	32	5		LDV	489	6	08-320300-10	PORSCHE	823	22
	CITROEN	189	51		PEUGEOT	807	56	08-320400-10	PORSCHE	825	25
	DAF	207	4		SSANGYONG	1022	5			826	26
	FORD EUROPE	376	61		TALBOT	1040	11	08-320500-10	PORSCHE	818	7
	LDV	489	6	08-318900-10	LEYLAND	494	7	08-320600-10	PORSCHE	816	2
	PEUGEOT	807	56		PERKINS	755	10	08-320700-10	PORSCHE	816	1

NUMERICAL PARTS LIST













Nummerische Teilenummernliste • Liste des références produits
Liste da referencias

   9				   9				   9			
08-320900-10	PORSCHE	821	15	08-325900-00	PORSCHE	828	33	08-335100-00	RENAULT	899	25
08-321200-00	PORSCHE	824	23	08-326100-00	PORSCHE	826	28		VOLVO	1230	10
08-321500-00	CITROEN	176	23	08-326200-00	PORSCHE	827	29	08-335105-00	RENAULT	899	25
	PEUGEOT	791	23	08-326300-00	CITROEN	187	46		VOLVO	1230	10
08-321507-00	CITROEN	176	23			187	48	08-335107-00	RENAULT	899	25
	PEUGEOT	791	23		DAF	207	3		VOLVO	1230	10
08-321510-00	CITROEN	176	23		PEUGEOT	806	51	08-335300-00	RENAULT TRUCKS	937	22
	PEUGEOT	791	23			806	53	08-335400-00	CHRYSLER	147	6
08-321600-00	RENAULT	921	44	08-326307-00	CITROEN	187	46		JEEP	444	2
08-321700-00	PORSCHE	821	17			187	48		RENAULT	909	33
08-322000-00	PERKINS	752	4		DAF	207	3	08-335500-00	RENAULT	874	7
		753	5		PEUGEOT	806	51	08-335600-00	RENAULT	879	12
		754	7			806	53	08-335800-00	RENAULT TRUCKS	931	9
		755	8	08-331600-10	RENAULT	869	1	08-335900-00	RENAULT TRUCKS	936	21
08-322100-00	LEYLAND	493	5	08-332200-00	RENAULT	874	6	08-336300-00	RENAULT	915	40
	PERKINS	755	11	08-333300-00	RENAULT	869	1			919	41
08-322300-00	PERKINS	762	27	08-333400-10	ARO	31	1	08-336400-00	RENAULT	877	11
08-322400-00	CITROEN	178	28		DACIA	201	3	08-336407-00	RENAULT	877	11
	PEUGEOT	794	30		DAF	207	2	08-336500-00	DACIA	203	7
08-322700-00	PERKINS	761	23		RENAULT	875	8		OPEL	729	27
08-323300-00	PORSCHE	824	24		VOLVO	1227	2		RENAULT	893	21
		826	26	08-333500-00	ARO	31	2		VAUXHALL	1095	28
08-323400-00	CITROEN	179	29		DACIA	201	4	08-336505-00	DACIA	203	7
	FIAT	283	49		RENAULT	880	13		OPEL	729	27
	PEUGEOT	793	28		VOLVO	1228	4		RENAULT	893	21
		795	31	08-333505-00	ARO	31	2		VAUXHALL	1095	28
08-323600-00	CITROEN	176	24		DACIA	201	4	08-336507-00	DACIA	203	7
	HONDA	386	5		RENAULT	880	13		OPEL	729	27
	PEUGEOT	792	24		VOLVO	1228	4		RENAULT	893	21
	ROVER	944	8	08-333507-00	ARO	31	2		VAUXHALL	1095	28
08-323607-00	CITROEN	176	24		DACIA	201	4	08-336510-00	DACIA	203	7
	HONDA	386	5		RENAULT	880	13		OPEL	729	27
	PEUGEOT	792	24		VOLVO	1228	4		RENAULT	893	21
	ROVER	944	8	08-334000-00	RENAULT	869	2		VAUXHALL	1095	28
08-323700-00	PEGASO	748	5	08-334200-00	CITROEN	168	11	08-336600-00	RENAULT	903	26
08-323800-00	PEGASO	749	8		PEUGEOT	788	15	08-337000-00	RENAULT	909	33
08-324300-00	PERKINS	760	19		RENAULT	877	10	08-337100-00	CHRYSLER	147	6
08-324400-00	PEGASO	749	9		TALBOT	1038	4		JEEP	444	3
08-324500-00	PORSCHE	829	35	08-334207-00	CITROEN	168	11		RENAULT	911	34
08-325000-00	PERKINS	756	12		PEUGEOT	788	15	08-337300-00	RENAULT	876	9
		757	13		RENAULT	877	10	08-337400-00	RENAULT	903	27
					TALBOT	1038	4		VOLVO	1232	14
08-325100-00	PORSCHE	826	27		TALBOT	1038	4	08-337500-00	RENAULT TRUCKS	934	14
08-325300-00	PORSCHE	818	5	08-334300-00	RENAULT	887	18	08-337600-00	RAB UNGARN	831	1
08-325400-00	COMPRESSOR	193	7	08-334400-00	CITROEN	186	43	08-337700-00	RENAULT	905	28
08-325405-00	COMPRESSOR	193	7		JEEP	444	4	08-343500-10	SCANIA	957	2
08-325407-00	COMPRESSOR	193	7		PEUGEOT	803	45			957	3
08-325500-00	CITROEN	180	31		RENAULT	915	40	08-343700-00	ZETOR	1265	1
	FIAT	282	47	08-334500-00	RENAULT	886	16	08-344500-00	CITROEN	168	8
	PEUGEOT	797	33	08-334600-00	DACIA	201	2		PEUGEOT	784	9
	SUZUKI	1034	13		DAF	207	1		TALBOT	1037	3
08-325507-00	CITROEN	180	31		RENAULT	872	5	08-344800-00	SKODA	1005	2
	FIAT	282	47		VOLVO	1227	1	08-346000-00	CITROEN	174	17
	PEUGEOT	797	33	08-334700-10	RENAULT	909	32		PEUGEOT	789	16
	SUZUKI	1034	13	08-334704-10	RENAULT	909	32		TALBOT	1038	5
08-325600-00	PERKINS	760	20	08-334707-10	RENAULT	909	32	08-346500-10	RENAULT TRUCKS	930	6
08-325800-00	CITROEN	174	18	08-335000-10	RENAULT	887	17	08-347000-00	SAAB	950	9
	NISSAN	684	10		VOLVO	1229	7	08-347100-10	SCANIA	963	12
	PEUGEOT	789	17	08-335003-10	RENAULT	887	17	08-347200-00	ZETOR	1265	2
	ROVER	943	5		VOLVO	1229	7	08-347900-10	RENAULT TRUCKS	931	7
08-325806-00	CITROEN	174	18	08-335005-10	RENAULT	887	17	08-348000-10	SCANIA	959	7
	NISSAN	684	10		VOLVO	1229	7			963	12
	PEUGEOT	789	17	08-335007-10	RENAULT	887	17	08-348200-00	PEUGEOT	792	25
	ROVER	943	5		VOLVO	1229	7				













						9							9							9
	TALBOT		1039		6			VOLKSWAGEN		1217		58			SEAT		978		5	
08-348300-00	ZETOR		1265		3					1219		60			VOLKSWAGEN		1160		4	
08-348600-00	SKODA		1005		3	08-399107-00	PORSCHE		820		13			08-406300-10	VOLVO		1234		20	
08-348700-00	SKODA		1005		1		VOLKSWAGEN		1217		58			08-406306-10	VOLVO		1234		20	
08-349200-00	SEAT		978		3				1219		60			08-406309-10	VOLVO		1234		20	
08-349300-00	SEAT		995		30	08-399111-00	PORSCHE		820		13			08-406900-10	VOLVO		1234		21	
08-349700-00	SKODA		1005		4		VOLKSWAGEN		1217		58			08-407000-10	VOLVO COMMERCIAL		1247		11	
08-361900-00	STEYR		1024		1				1219		60			08-407100-10	VOLVO COMMERCIAL		1250		22	
08-362000-00	STEYR		1024		2	08-399200-00	VOLKSWAGEN		1182		26			08-407100-20	VOLVO COMMERCIAL		1250		22	
08-362100-10	STEYR		1025		4				1185		29			08-407105-10	VOLVO COMMERCIAL		1250		22	
08-362200-10	STEYR		1024		3	08-399400-10	VOLVO COMMERCIAL		1244		5			08-407600-10	VOLVO		1236		25	
08-371600-10	TOYOTA		1051		4	08-399600-10	NISSAN		691		30			08-407605-10	VOLVO		1236		25	
08-371700-00	DAIHATSU		214		3		PERKINS		755		9			08-407607-10	VOLVO		1236		25	
	TOYOTA		1055		11	08-399700-10	AUDI		91		39			08-407611-10	VOLVO		1236		25	
08-372100-10	TOYOTA		1061		24		PORSCHE		819		8			08-407700-10	VOLVO		1237		27	
08-373000-00	TOYOTA		1051		2		VOLKSWAGEN		1216		53			08-407708-10	VOLVO		1237		27	
08-373100-00	TOYOTA		1055		13	08-399707-10	AUDI		91		39			08-407722-10	VOLVO		1237		27	
08-373200-00	TOYOTA		1057		16		PORSCHE		819		8			08-408100-00	VOLVO		1236		26	
08-373207-00	TOYOTA		1057		16		VOLKSWAGEN		1216		53			08-408108-00	VOLVO		1236		26	
08-373600-00	TOYOTA		1062		26	08-400600-20	COMPRESSOR		192		1			08-408200-00	VOLVO		1237		28	
08-373700-00	TOYOTA		1062		26	08-401000-00	COMPRESSOR		195		17			08-408400-00	VOLVO		1235		23	
08-373800-00	ISEKI		400		6	08-401200-00	COMPRESSOR		193		10			08-408500-00	VOLVO		1235		22	
	TOYOTA		1063		28	08-403200-00	COMPRESSOR		192		1			08-408600-00	COMPRESSOR		192		2	
	VOLKSWAGEN		1216		55	08-403600-00	COMPRESSOR		193		9			08-408605-00	COMPRESSOR		192		2	
	YANMAR		1260		8	08-403607-00	COMPRESSOR		193		9			08-408607-00	COMPRESSOR		192		2	
08-373807-00	TOYOTA		1063		28	08-404100-00	AUDI		66		16			08-408700-00	AUDI		59		2	
	VOLKSWAGEN		1216		55		VOLKSWAGEN		1183		27				VOLKSWAGEN		1162		6	
08-374000-00	HINO		382		2				1185		29			08-408707-00	AUDI		59		2	
	TOYOTA		1064		32	08-404200-00	AUDI		59		3				VOLKSWAGEN		1162		6	
08-374300-00	TOYOTA		1059		20		VOLKSWAGEN		1162		7			08-408800-00	PEUGEOT		806		49	
08-374400-00	TOYOTA		1052		7	08-404211-00	AUDI		59		3				RENAULT		921		45	
08-374407-00	TOYOTA		1052		7		VOLKSWAGEN		1162		7				VOLVO		1236		24	
08-374600-00	ZAZ		1264		1	08-404500-00	COMPRESSOR		196		21			08-409400-00	VOLVO COMMERCIAL		1243		4	
08-381100-00	UTB		1069		3	08-405000-00	AUDI		68		17			08-420000-00	MERCEDES BENZ COMMERCIAL		639		21	
08-381111-00	UTB		1069		3		VOLKSWAGEN		1184		28			08-420100-00	IVECO		433		45	
08-390200-00	VOLKSWAGEN		1172		19	08-405200-00	AUDI		61		8			08-420108-00	IVECO		433		45	
08-390205-00	VOLKSWAGEN		1172		19		PEGASO		748		2			08-420200-00	IVECO		433		45	
08-390207-10	VOLKSWAGEN		1172		19		VOLKSWAGEN		1164		10			08-420208-00	IVECO		433		45	
08-392000-10	VOLVO COMMERCIAL		1246		9	08-405205-00	AUDI		61		8			08-420900-00	MERCEDES BENZ COMMERCIAL		644		28	
	VOLVO-PENTA		1257		2		PEGASO		748		2			08-421000-00	VOLKSWAGEN		1196		37	
08-392005-10	VOLVO COMMERCIAL		1246		9		VOLKSWAGEN		1164		10			08-421007-00	VOLKSWAGEN		1196		37	
	VOLVO-PENTA		1257		2	08-405207-00	AUDI		61		8			08-421600-00	IVECO		419		13	
08-394500-00	VOLKSWAGEN		1172		19		PEGASO		748		2			08-421700-00	MERCEDES BENZ		580		12	
08-394505-00	VOLKSWAGEN		1172		19		VOLKSWAGEN		1164		10			08-421800-00	BMW		129		18	
08-394507-00	VOLKSWAGEN		1172		19	08-405211-00	AUDI		61		8						130		19	
08-394600-00	VOLKSWAGEN		1214		51		PEGASO		748		2			08-422000-00	NISSAN		686		18	
08-394614-10	VOLKSWAGEN		1214		51		VOLKSWAGEN		1164		10				OPEL		734		37	
08-394800-00	VOLKSWAGEN		1212		48	08-405300-10	VOLKSWAGEN		1215		52				RENAULT		905		30	
08-396300-10	VOLVO COMMERCIAL		1250		20	08-405314-10	VOLKSWAGEN		1215		52				VAUXHALL		1099		38	
	VOLVO-PENTA		1257		3	08-405500-10	VOLVO COMMERCIAL		1244		6			08-422007-00	NISSAN		686		18	
08-396305-10	VOLVO COMMERCIAL		1250		20		VOLVO-PENTA		1257		1				OPEL		734		37	
	VOLVO-PENTA		1257		3	08-405600-10	VOLVO COMMERCIAL		1254		28				RENAULT		905		30	
08-397900-00	VOLKSWAGEN		1216		54		VOLVO-PENTA		1257		4				VAUXHALL		1099		38	
08-398300-00	VOLGA		1113		2	08-405600-20	VOLVO COMMERCIAL		1254		28			08-422100-00	PERKINS		760		18	
08-398307-00	VOLGA		1113		2		VOLVO-PENTA		1257		4			08-422200-00	BMW		123		5	
08-398800-00	PORSCHE		819		11	08-405900-00	VOLVO COMMERCIAL		1243		2			08-422207-00	BMW		123		5	
	VOLKSWAGEN		1217		57	08-406200-00	BARKAS		100		1			08-422300-00	RENAULT		896		23	
08-399000-10	VOLVO		1236		25		SEAT		978		5			08-422307-00	RENAULT		896		23	
08-399007-10	VOLVO		1236		25		VOLKSWAGEN		1160		4			08-422400-00	TOYOTA		1064		30	
08-399100-00	PORSCHE		820		13	08-406207-00	BARKAS		100		1			08-422407-00	TOYOTA		1064		30	
	VOLKSWAGEN		1217		58		SEAT		978		5			08-423000-00	MAN		523		12	
			1219		60		VOLKSWAGEN		1160		4			08-423100-00	CHRYSLER		147		8	
08-399105-00	PORSCHE		820		13	08-406211-00	BARKAS		100		1				LDV		489		5	

NUMERICAL PARTS LIST

Nummerische Teilenummernliste • Liste des références produits
Liste da referencias













											
	LTI	503	1	08-426100-00	FORD EUROPE	338	9	08-429300-00	ALFA ROMEO	14	9
	VM	1111	3		MAZDA	540	4		CHRYSLER	146	4
08-423200-00	VM	1112	4	08-426107-00	FORD EUROPE	338	9		FIAT	270	23
08-423400-00	FORD EUROPE	363	41		MAZDA	540	4		LANCIA	467	12
	MAZDA	542	12	08-426200-00	PERKINS	761	25	08-429400-00	FORD EUROPE	356	30
	VOLVO	1233	18	08-426300-00	CITROEN	166	4	08-429407-00	FORD EUROPE	356	30
08-423407-00	FORD EUROPE	363	41		PEUGEOT	783	6	08-429500-00	OPEL	720	10
	MAZDA	542	12		ZASTAVA	1262	3		SUZUKI	1032	6
	VOLVO	1233	18	08-426500-00	TOYOTA	1051	1		VAUXHALL	1088	11
08-424000-00	CITROEN	169	12	08-426507-00	TOYOTA	1051	1	08-429507-00	OPEL	720	10
	FIAT	268	18	08-426600-00	TOYOTA	1059	19		SUZUKI	1032	6
	FORD EUROPE	336	7	08-426607-00	TOYOTA	1059	19		VAUXHALL	1088	11
	MAZDA	539	3	08-426700-00	LOTUS	502	1	08-429600-00	RENAULT TRUCKS	935	17
	MINI	648	2		TOYOTA	1056	14	08-429800-00	BMW	132	25
	PEUGEOT	785	10	08-426707-00	LOTUS	502	1	08-429900-00	AUDI	60	7
	SUZUKI	1032	8		TOYOTA	1056	14		SEAT	983	13
08-424007-00	CITROEN	169	12	08-426800-00	DAEWOO	204	1		SKODA	1008	10
	FIAT	268	18	08-426807-00	DAEWOO	204	1		VOLKSWAGEN	1170	17
	FORD EUROPE	336	7	08-427000-00	MERCEDES BENZ COMMERCIAL	637	18	08-429907-00	AUDI	60	7
	MAZDA	539	3	08-427100-00	SMART	1018	3		SEAT	983	13
	MINI	648	2	08-427105-00	SMART	1018	3		SKODA	1008	10
	PEUGEOT	785	10	08-427107-00	SMART	1018	3		VOLKSWAGEN	1170	17
	SUZUKI	1032	8	08-427300-00	BMW	136	30	08-430000-00	DEUTZ KHD	229	27
08-424008-00	CITROEN	169	12	08-427400-00	MERCEDES BENZ	576	10		RENAULT TRUCKS	932	10
	FIAT	268	18	08-427407-00	MERCEDES BENZ	576	10		VOLVO COMMERCIAL	1248	16
	FORD EUROPE	336	7	08-427500-00	MERCEDES BENZ	575	9	08-431000-00	MAN	528	21
	MAZDA	539	3		MITSUBISHI	653	7	08-431100-00	IVECO	429	33
	MINI	648	2		SMART	1019	4	08-431200-00	PORSCHE	820	12
	PEUGEOT	785	10	08-427507-00	MERCEDES BENZ	575	9	08-431300-00	VOLVO COMMERCIAL	1252	23
	SUZUKI	1032	8		MITSUBISHI	653	7	08-431400-00	PORSCHE	822	19
08-425000-00	FIAT	291	63		SMART	1019	4	08-431600-00	MAN	522	9
	IVECO	416	4	08-427600-00	MERCEDES BENZ	574	6	08-431700-00	HYUNDAI	392	8
	RENAULT	921	46	08-427600-10	MERCEDES BENZ	573	5	08-431707-00	KIA	450	8
	RENAULT TRUCKS	929	1	08-427700-00	CITROEN	184	38		HYUNDAI	392	8
08-425008-00	FIAT	291	63		FIAT	288	55		KIA	450	8
	IVECO	416	4		FORD EUROPE	362	38	08-431800-00	KIA	450	9
	RENAULT	921	46		JAGUAR	441	5	08-431807-00	KIA	450	9
	RENAULT TRUCKS	929	1	08-427707-00	PEUGEOT	802	41	08-431900-00	HYUNDAI	391	7
08-425100-00	PORSCHE	827	30		CITROEN	184	38		KIA	449	5
08-425200-00	LADA	457	4		FIAT	288	55	08-431907-00	HYUNDAI	391	7
08-425300-00	BMW	128	17		FORD EUROPE	362	38		KIA	449	5
08-425400-00	PERKINS	761	24		JAGUAR	441	5	08-432200-00	BMW	134	27
08-425407-00	PERKINS	761	24		PEUGEOT	802	41	08-432300-00	AUDI	79	26
08-425411-00	PERKINS	761	24	08-427800-00	OPEL	728	23		SEAT	992	27
08-425600-00	FIAT	262	7		VAUXHALL	1094	24		SKODA	1014	22
	LANCIA	465	4	08-427807-00	OPEL	728	23		VOLKSWAGEN	1203	41
	OPEL	717	3		VAUXHALL	1094	24	08-432300-10	VOLKSWAGEN	1201	40
	SUZUKI	1031	5	08-427900-00	IVECO	423	19	08-432307-00	AUDI	79	26
	VAUXHALL	1086	4	08-428000-00	IVECO	434	46		SEAT	992	27
08-425606-00	FIAT	262	7	08-428100-00	FORD EUROPE	343	15		SKODA	1014	22
	LANCIA	465	4	08-428200-00	PORSCHE	822	18		VOLKSWAGEN	1203	41
	OPEL	717	3	08-428300-00	TOYOTA	1058	17	08-432400-00	CITROEN	176	25
	SUZUKI	1031	5	08-428307-00	TOYOTA	1058	17		JAGUAR	440	1
	VAUXHALL	1086	4	08-428400-00	TOYOTA	1053	9		LAND ROVER	481	4
08-425608-00	FIAT	262	7	08-428407-00	TOYOTA	1053	9		PEUGEOT	792	26
	LANCIA	465	4	08-428500-00	PORSCHE	823	20	08-432500-00	DAF	211	15
	OPEL	717	3	08-428600-00	MAN	524	13	08-432600-00	BMW	140	37
	SUZUKI	1031	5	08-428700-00	MERCEDES BENZ	595	29	08-432700-00	IVECO	426	25
	VAUXHALL	1086	4	08-428707-00	MERCEDES BENZ	595	29	08-432800-00	MAN	533	27
08-425700-00	BMW	133	26	08-428800-00	IVECO	430	34	08-432900-00	AUDI	66	15
08-425707-00	BMW	133	26	08-429100-00	MAN	522	8		SEAT	987	17
08-425800-00	MAN	533	28	08-429200-00	LDV	489	5		SKODA	1011	17
08-425900-00	MAN	522	9		VM	1111	3		VOLKSWAGEN	1182	25









9		9		9							
08-432907-00	AUDI	66	15	SKODA	1008	11	08-436007-00	NISSAN	690	27	
	SEAT	987	17	VOLKSWAGEN	1171	18	08-436100-00	NISSAN	691	29	
	SKODA	1011	17	08-433907-00	AUDI	61	9	08-436107-00	NISSAN	691	29
	VOLKSWAGEN	1182	25		SEAT	982	12	08-436200-00	NISSAN	692	35
08-433000-00	AUDI	65	14		SKODA	1008	11	08-436300-00	LEXUS	490	1
	SEAT	986	16		VOLKSWAGEN	1171	18		TOYOTA	1060	22
	SKODA	1010	15	08-434100-00	IVECO	433	44	08-436400-00	LEXUS	490	2
		1011	16	08-434300-00	AUDI	87	33		TOYOTA	1062	25
	VOLKSWAGEN	1179	23			89	35	08-436500-00	ALFA ROMEO	20	20
		1180	24		VOLKSWAGEN	1211	45		CHRYSLER	147	5
08-433007-00	AUDI	65	14			1212	47		FIAT	281	46
	SEAT	986	16	08-434307-00	AUDI	87	33		LANCIA	472	26
	SKODA	1010	15			89	35		OPEL	733	35
		1011	16		VOLKSWAGEN	1211	45		SAAB	950	6
	VOLKSWAGEN	1179	23			1212	47		SUZUKI	1033	11
		1180	24	08-434400-00	RENAULT TRUCKS	935	18		VAUXHALL	1098	36
08-433100-00	AUDI	87	34		VOLVO COMMERCIAL	1256	31	08-436506-00	ALFA ROMEO	20	20
		89	35	08-434600-00	BMW	132	24		CHRYSLER	147	5
	VOLKSWAGEN	1211	46	08-434800-00	COMPRESSOR	196	23		FIAT	281	46
		1212	47	08-435000-00	RENAULT TRUCKS	931	8		LANCIA	472	26
08-433105-00	AUDI	87	34	08-435100-10	AUDI	85	31		OPEL	733	35
		89	35		SEAT	994	29		SAAB	950	6
	VOLKSWAGEN	1211	46		SKODA	1016	24		SUZUKI	1033	11
		1212	47		VOLKSWAGEN	1209	44		VAUXHALL	1098	36
08-433107-00	AUDI	87	34	08-435200-00	NISSAN	688	22	08-436700-00	CITROEN	183	35
		89	35		OPEL	738	44		FORD EUROPE	359	35
	VOLKSWAGEN	1211	46		RENAULT	908	31		JAGUAR	440	4
		1212	47		VAUXHALL	1103	45		MINISUBISHI	654	8
08-433200-00	ALFA ROMEO	12	4	08-435207-00	NISSAN	688	22		PEUGEOT	801	38
	FIAT	266	13		OPEL	738	44	08-436800-00	ALFA ROMEO	12	3
	LANCIA	466	9		RENAULT	908	31		FIAT	266	14
	OPEL	718	7		VAUXHALL	1103	45		LANCIA	467	11
	VAUXHALL	1086	7	08-435300-00	OPEL	728	24	08-436806-00	ALFA ROMEO	12	3
08-433206-00	ALFA ROMEO	12	4		VAUXHALL	1094	25		FIAT	266	14
	FIAT	266	13	08-435307-00	OPEL	728	24		LANCIA	467	11
	LANCIA	466	9		VAUXHALL	1094	25	08-436900-00	SEAT	982	10
	OPEL	718	7	08-435400-00	HYUNDAI	390	4			982	11
	VAUXHALL	1086	7	08-435407-00	HYUNDAI	390	4		SKODA	1007	8
08-433300-00	DAF	212	17	08-435500-00	OPEL	726	20			1007	9
08-433400-00	JEEP	444	1		SAAB	949	1		VOLKSWAGEN	1169	15
	MERCEDES BENZ	579	11		VAUXHALL	1093	21			1169	16
08-433405-00	JEEP	444	1	08-435507-00	OPEL	726	20	08-437000-00	FORD EUROPE	352	27
	MERCEDES BENZ	579	11		SAAB	949	1	08-437007-00	FORD EUROPE	352	27
08-433407-00	JEEP	444	1		VAUXHALL	1093	21	08-437100-00	MERCEDES BENZ	575	8
	MERCEDES BENZ	579	11	08-435700-00	ALFA ROMEO	11	1	08-437300-00	AUDI	91	38
08-433500-00	MINI	648	3		CHRYSLER	146	1	08-437400-00	OPEL	719	8
08-433505-00	MINI	648	3		FIAT	262	8		VAUXHALL	1087	9
08-433507-00	MINI	648	3		LANCIA	465	5	08-437500-00	DAF	211	15
08-433600-00	CITROEN	170	13		OPEL	717	1	08-437600-00	SCANIA	964	16
	FORD EUROPE	337	8		PEUGEOT	782	1	08-438300-00	ALFA ROMEO	11	2
	PEUGEOT	785	11		VAUXHALL	1085	2		CHRYSLER	146	3
	TOYOTA	1055	12	08-435706-00	ALFA ROMEO	11	1		FIAT	267	15
	VOLVO	1227	3		CHRYSLER	146	1		LANCIA	466	10
08-433607-00	CITROEN	170	13		FIAT	262	8		OPEL	718	6
	FORD EUROPE	337	8		LANCIA	465	5		VAUXHALL	1086	6
	PEUGEOT	785	11		OPEL	717	1	08-438306-00	ALFA ROMEO	11	2
	TOYOTA	1055	12		PEUGEOT	782	1		CHRYSLER	146	3
	VOLVO	1227	3		VAUXHALL	1085	2		FIAT	267	15
08-433700-00	HONDA	385	3	08-435800-00	NISSAN	685	16		LANCIA	466	10
08-433707-00	HONDA	385	3	08-435807-00	NISSAN	685	16		OPEL	718	6
08-433800-00	MAN	533	28	08-435900-00	NISSAN	690	26		VAUXHALL	1086	6
08-433900-00	AUDI	61	9	08-435907-00	NISSAN	690	26	08-438600-00	DAEWOO	204	2
	SEAT	982	12	08-436000-00	NISSAN	690	27	08-438605-00	DAEWOO	204	2

											
08-523108-00	LANCIA	470	20	08-525100-00	FORD TRACTOR	378	1	08-527808-00	IVECO	415	2
	FIAT	275	32		PERKINS	752	4		NEW HOLLAND	665	1
	LANCIA	470	20			753	5	08-527900-00	IVECO	431	39
08-523200-00	SAME	953	1			755	8	08-528000-00	IVECO	429	31
08-523300-00	SAME	953	2		URSUS	1068	1		NEW HOLLAND	669	17
08-523307-00	SAME	953	2	08-525200-00	LEYLAND	494	7	08-528100-00	IVECO	427	26
08-523400-00	LEYLAND	494	9		PERKINS	757	13		NEW HOLLAND	667	11
08-523500-00	FORD COMMERCIAL	297	4			758	14	08-528200-00	IVECO	432	40
08-523600-00	JAGUAR	441	8			759	16	08-528300-00	FIAT	263	9
08-523700-00	TRIUMPH MOTORCYCLE	1066	3	08-525209-00	LEYLAND	494	7	08-528306-00	FIAT	263	9
08-523707-00	TRIUMPH MOTORCYCLE	1066	3		PERKINS	757	13	08-528400-00	FIAT	268	17
08-523800-00	LISTER	497	3			758	14	08-528406-00	FIAT	268	17
08-523807-00	LISTER	497	3			759	16	08-528408-00	FIAT	268	17
08-523811-00	LISTER	497	3	08-525300-00	LEYLAND	492	2	08-528500-00	ALFA ROMEO	14	10
08-523900-00	RELIANT	832	1			492	3	08-528600-00	MARELLI	534	1
08-524000-00	JAGUAR	442	10	08-525400-00	TRIUMPH MOTORCYCLE	1066	2	08-528607-00	MARELLI	534	1
08-524007-00	JAGUAR	442	10	08-525407-00	TRIUMPH MOTORCYCLE	1066	2	08-528700-00	MARELLI	534	2
08-524100-00	AUSTIN MORRIS	97	5	08-525411-00	TRIUMPH MOTORCYCLE	1066	2	08-528707-00	MARELLI	534	2
	MG	646	2	08-525414-00	TRIUMPH MOTORCYCLE	1066	2	08-528800-00	TOYOTA	1064	31
		646	3	08-525500-00	JAGUAR	441	7	08-528807-00	TOYOTA	1064	31
	ROVER	941	2	08-525507-00	JAGUAR	441	7	08-529000-00	FORD EUROPE	347	20
08-524107-00	AUSTIN MORRIS	97	5	08-525509-00	JAGUAR	441	7	08-529007-00	FORD EUROPE	347	20
	MG	646	2	08-525600-00	LEYLAND	495	10	08-529100-00	FORD EUROPE	370	52
		646	3	08-525700-00	TRIUMPH	1065	2	08-529200-00	COMPRESSOR	194	15
	ROVER	941	2	08-525707-00	TRIUMPH	1065	2		MARELLI	534	4
08-524111-00	AUSTIN MORRIS	97	5	08-525709-00	TRIUMPH	1065	2	08-529204-00	COMPRESSOR	194	15
	MG	646	2	08-525711-00	TRIUMPH	1065	2		MARELLI	534	4
		646	3	08-525800-00	TRIUMPH MOTORCYCLE	1066	1	08-529207-00	COMPRESSOR	194	15
	ROVER	941	2	08-525807-00	TRIUMPH MOTORCYCLE	1066	1		MARELLI	534	4
08-524114-00	AUSTIN MORRIS	97	5	08-525900-00	AUSTIN MORRIS	98	7	08-529300-00	FIAT	274	29
	MG	646	2		LDV	488	1		LANCIA	468	16
		646	3	08-525907-00	AUSTIN MORRIS	98	7	08-529306-00	FIAT	274	29
	ROVER	941	2		LDV	488	1		LANCIA	468	16
08-524200-00	AUSTIN MORRIS	99	9	08-525909-00	AUSTIN MORRIS	98	7	08-529700-00	AUSTIN MORRIS	95	1
	LAND ROVER	485	15		LDV	488	1		MG	646	1
08-524207-00	AUSTIN MORRIS	99	9	08-525911-00	AUSTIN MORRIS	98	7	08-529907-00	JAGUAR	440	2
	LAND ROVER	485	15		LDV	488	1	08-529909-00	JAGUAR	440	2
08-524211-00	AUSTIN MORRIS	99	9	08-525914-00	AUSTIN MORRIS	98	7	08-529911-00	JAGUAR	440	2
	LAND ROVER	485	15		LDV	488	1	08-530100-00	AUSTIN MORRIS	99	8
08-524300-10	AUSTIN MORRIS	95	2	08-526000-00	LISTER	497	1		MG	647	8
	ROVER	941	1	08-526200-00	LEYLAND	493	4	08-530107-00	AUSTIN MORRIS	99	8
08-524307-10	AUSTIN MORRIS	95	2	08-526300-00	HINO	382	1		MG	647	8
	ROVER	941	1		TOYOTA	1063	29	08-530109-00	AUSTIN MORRIS	99	8
08-524311-10	AUSTIN MORRIS	95	2	08-526400-00	LAND ROVER	484	11		MG	647	8
	ROVER	941	1	08-526411-00	LAND ROVER	484	11	08-530400-00	ALFA ROMEO	12	5
08-524314-10	AUSTIN MORRIS	95	2	08-526500-00	BEDFORD	106	12	08-700000-00	BMW MOTORCYCLE	143	1
	ROVER	941	1	08-526600-00	AUSTIN MORRIS	98	6	08-700100-00	BMW	141	38
08-524400-00	LAND ROVER	484	12		MG	646	4	08-700200-00	BMW	139	33
08-524407-00	LAND ROVER	484	12	08-526700-00	JAGUAR	442	9	08-700300-00	BMW MOTORCYCLE	143	2
08-524500-00	LAND ROVER	486	17	08-526800-00	TOYOTA	1062	27	08-700400-00	BMW MOTORCYCLE	143	2
08-524600-00	ROVER	945	12	08-526900-00	SCANIA	964	13			143	3
08-524607-00	ROVER	945	12	08-527000-00	NISSAN	682	7	08-700411-00	BMW MOTORCYCLE	143	2
08-524700-00	IVECO	429	30	08-527200-00	ALFA ROMEO	13	6			143	3
	NEW HOLLAND	668	16	08-527300-00	ALFA ROMEO	13	7	08-700800-00	BMW MOTORCYCLE	144	5
08-524800-00	MARELLI	534	3	08-527500-00	ALFA ROMEO	28	37	08-700900-00	BMW MOTORCYCLE	144	6
08-524804-00	MARELLI	534	3		LANCIA	477	36	08-700905-00	BMW MOTORCYCLE	144	6
08-524807-00	MARELLI	534	3	08-527600-00	FIAT	261	5	08-701000-00	BMW MOTORCYCLE	144	6
08-524811-00	MARELLI	534	3	08-527606-00	FIAT	261	5	08-701100-00	BMW MOTORCYCLE	143	4
08-524900-00	FIAT	272	26	08-527608-00	FIAT	261	5	08-701200-00	BMW MOTORCYCLE	143	4
08-525000-00	LISTER	497	2	08-527700-00	IVECO	431	38	08-702300-00	RENAULT TRUCKS	936	20
08-525007-00	LISTER	497	2		NEW HOLLAND	669	19	08-702600-00	BMW	125	9
08-525011-00	LISTER	497	2	08-527800-00	IVECO	415	2	08-702605-00	BMW	125	9
08-525014-00	LISTER	497	2		NEW HOLLAND	665	1	08-702607-00	BMW	125	9

NUMERICAL PARTS LIST







Nummerische Teilenummernliste • Liste des références produits
Liste da referencias







											
08-702800-00	BMW	131	23	08-742100-00	CUMMINS	198	3	08-781107-00	FORD EUROPE	341	13
08-703400-00	LEYLAND	492	1		DAF	208	8		RELIANT	832	2
		492	2	08-742300-00	MERCEDES BENZ COMMERCIAL	637	17	08-781111-00	FORD EUROPE	341	13
		492	3			641	23		RELIANT	832	2
		493	4			641	24	08-781500-00	FAP-FAMOS	236	2
08-704200-00	BMW	126	11	08-742300-20	MERCEDES BENZ COMMERCIAL	637	17	08-781600-00	FAP-FAMOS	236	1
08-704207-00	BMW	126	11			641	23	08-781800-00	FAP-FAMOS	236	3
08-704400-00	BMW	141	39			641	24	08-781900-00	IVECO	420	15
08-704500-00	BMW	122	3	08-742500-00	COMPRESSOR	193	8			421	16
	LAND ROVER	481	2	08-742600-00	COMPRESSOR	195	20			422	17
	OPEL	730	29	08-742605-00	COMPRESSOR	195	20		NEW HOLLAND	665	4
	VAUXHALL	1096	30	08-743100-00	MERCEDES BENZ	598	34			666	5
08-704507-00	BMW	122	3		SSANGYONG	1021	1	08-781908-00	IVECO	420	15
	LAND ROVER	481	2	08-743107-00	MERCEDES BENZ	598	34			421	16
	OPEL	730	29		SSANGYONG	1021	1			422	17
	VAUXHALL	1096	30	08-743120-00	MERCEDES BENZ	598	34		NEW HOLLAND	665	4
08-704800-00	BMW	131	21		SSANGYONG	1021	1			666	5
08-704900-00	BMW	123	4	08-743200-00	MERCEDES BENZ COMMERCIAL	639	22	08-782000-00	IVECO	423	20
08-705000-00	BMW	123	4	08-743400-00	DAF	212	16		NEW HOLLAND	666	7
08-705007-00	BMW	123	4	08-743500-00	DEUTZ KHD	233	36	08-782008-00	IVECO	423	20
08-705100-00	BMW	128	15	08-743600-00	MERCEDES BENZ	584	19		NEW HOLLAND	666	7
08-705107-00	BMW	128	15			585	20	08-782100-00	IVECO	437	51
08-705200-00	BMW	128	16	08-743607-00	MERCEDES BENZ	584	19	08-782300-00	FIAT	278	40
08-705207-00	BMW	128	16			585	20	08-782308-00	FIAT	278	40
08-714400-00	LAND ROVER	484	13	08-743800-00	DAIHATSU	214	1	08-782400-00	FORD EUROPE	357	31
	LDV	488	4			216	1	08-782500-00	FORD EUROPE	371	54
08-714407-00	LAND ROVER	484	13	08-744000-00	DAIHATSU	215	7	08-782600-00	FIAT	261	4
	LDV	488	4	08-744100-00	DEUTZ KHD	228	21		LANCIA	464	2
08-714411-00	LAND ROVER	484	13			228	23	08-782606-00	FIAT	261	4
	LDV	488	4	08-744107-00	DEUTZ KHD	228	21		LANCIA	464	2
08-740000-00	MERCEDES BENZ COMMERCIAL	627	5			228	23	08-782608-00	FIAT	261	4
08-740007-00	MERCEDES BENZ COMMERCIAL	627	5	08-744400-00	DAIHATSU	215	5		LANCIA	464	2
08-740300-00	DEUTZ KHD	233	35	08-744600-00	DEUTZ KHD	224	14	08-782700-00	FIAT	261	3
08-740307-00	DEUTZ KHD	233	35			225	15	08-782800-00	FORD COMMERCIAL	297	2
08-740311-00	DEUTZ KHD	233	35	08-744607-00	DEUTZ KHD	224	14	08-782900-00	FORD COMMERCIAL	298	6
08-740400-00	DEUTZ KHD	234	38			225	15	08-782906-00	FORD COMMERCIAL	298	6
08-740500-00	DEUTZ KHD	233	36	08-744611-00	DEUTZ KHD	224	14	08-782910-00	FORD COMMERCIAL	298	6
08-740900-00	DEUTZ KHD	228	23			225	15	08-783000-00	IVECO	436	50
08-740907-00	DEUTZ KHD	228	23	08-744700-00	DEUTZ KHD	227	19	08-783200-00	FIAT	270	22
08-741100-00	MERCEDES BENZ	609	42	08-744707-00	DEUTZ KHD	227	19	08-783300-00	ALFA ROMEO	28	36
		610	44	08-780000-00	FORD EUROPE	363	40		FIAT	294	67
08-741200-00	COMPRESSOR	195	18	08-780007-00	FORD EUROPE	363	40		IVECO	417	8
	MERCEDES BENZ COMMERCIAL	625	1	08-780100-00	FORD EUROPE	373	57		OPEL	744	58
08-741204-00	COMPRESSOR	195	18	08-780111-00	FORD EUROPE	373	57		RENAULT	924	50
	MERCEDES BENZ COMMERCIAL	625	1	08-780121-00	FORD EUROPE	373	57		VAUXHALL	1108	56
08-741205-00	COMPRESSOR	195	18	08-780200-00	FORD EUROPE	357	32	08-783308-00	ALFA ROMEO	28	36
	MERCEDES BENZ COMMERCIAL	625	1	08-780300-00	FORD EUROPE	369	51		FIAT	294	67
08-741207-00	COMPRESSOR	195	18	08-780307-00	FORD EUROPE	369	51		IVECO	417	8
	MERCEDES BENZ COMMERCIAL	625	1	08-780309-00	FORD EUROPE	369	51		OPEL	744	58
08-741600-00	DAF	209	10	08-780311-00	FORD EUROPE	369	51		RENAULT	924	50
08-741700-00	COMPRESSOR	195	16	08-780314-00	FORD EUROPE	369	51		VAUXHALL	1108	56
08-741800-00	DEUTZ KHD	224	13	08-780500-00	FORD EUROPE	364	42	08-783400-00	FIAT	280	43
		224	14			365	43	08-783500-00	FORD EUROPE	355	29
		225	15	08-780600-10	FORD EUROPE	349	23	08-783507-00	FORD EUROPE	355	29
		226	17	08-780607-10	FORD EUROPE	349	23	08-783511-00	FORD EUROPE	355	29
08-741807-00	DEUTZ KHD	224	13	08-780609-10	FORD EUROPE	349	23	08-783600-00	FIAT	272	27
		224	14	08-780611-10	FORD EUROPE	349	23		LANCIA	468	14
		225	15	08-780614-10	FORD EUROPE	349	23		ZASTAVA	1263	5
		226	17	08-780617-10	FORD EUROPE	349	23	08-783606-00	FIAT	272	27
08-741811-00	DEUTZ KHD	224	13	08-780700-00	FIAT	271	25		LANCIA	468	14
		224	14	08-781000-00	IVECO	432	41		ZASTAVA	1263	5
		225	15	08-781100-00	FORD EUROPE	341	13	08-783608-00	FIAT	272	27
		226	17		RELIANT	832	2		LANCIA	468	14

			9				9				9
	ZASTAVA	1263	5	08-785508-00	FIAT	269	21		VAUXHALL	1085	1
08-783610-00	FIAT	272	27	08-786000-00	FORD EUROPE	348	22	08-960300-00	SUBARU	1027	5
	LANCIA	468	14	08-786007-00	FORD EUROPE	348	22	08-960500-00	SUBARU	1028	7
	ZASTAVA	1263	5	08-786300-00	FORD EUROPE	339	11	08-960800-00	SCANIA	964	14
08-783611-00	FIAT	272	27	08-786307-00	FORD EUROPE	339	11	08-960900-00	SCANIA	959	6
	LANCIA	468	14	08-786400-00	FORD EUROPE	358	33	08-961000-00	SCANIA	957	3
	ZASTAVA	1263	5	08-786407-00	FORD EUROPE	358	33			958	5
08-783700-00	CITROEN	186	41	08-786500-00	FORD EUROPE	348	22	08-961600-00	MAN	526	16
	FIAT	289	58	08-786507-00	FORD EUROPE	348	22	08-961700-00	MAN	523	10
	LANCIA	476	34	08-786600-00	FORD EUROPE	339	11	08-961800-00	SUZUKI	1032	7
08-783706-00	CITROEN	186	41	08-786607-00	FIAT	272	27	08-961807-00	SUZUKI	1032	7
	FIAT	289	58		LANCIA	468	14	08-961900-00	SCANIA	960	8
	LANCIA	476	34	08-786800-00	FIAT	290	59	08-962000-00	SCANIA	962	11
08-783708-00	CITROEN	186	41		LANCIA	476	32	08-962100-00	SCANIA	964	15
	FIAT	289	58	08-786806-00	FIAT	290	59	08-962600-00	SKODA	1006	5
	LANCIA	476	34		LANCIA	476	32	08-962800-00	DAIHATSU	214	4
08-783711-00	CITROEN	186	41	08-786900-00	FORD EUROPE	339	11		SUBARU	1027	4
	FIAT	289	58	08-787000-00	ALFA ROMEO	19	18	08-962900-00	SUZUKI	1031	3
	LANCIA	476	34		FIAT	274	30	08-963300-00	SAAB	951	10
08-783800-00	ALFA ROMEO	19	19		LANCIA	469	18	08-990000-00	VOLKSWAGEN	1218	59
	FIAT	279	41	08-787006-00	ALFA ROMEO	19	18	08-990100-00	AUDI	63	12
		280	44		FIAT	274	30		SEAT	983	14
	LANCIA	471	25		LANCIA	469	18		SKODA	1009	13
08-783808-00	ALFA ROMEO	19	19	08-848300-50	HYUNDAI	391	5		VOLKSWAGEN	1173	21
	FIAT	279	41		KIA	449	3	08-990105-00	AUDI	63	12
		280	44	08-848307-50	HYUNDAI	391	5		SEAT	983	14
	LANCIA	471	25		KIA	449	3		SKODA	1009	13
08-783900-00	IVECO	424	21	08-849000-00	HYUNDAI	390	1		VOLKSWAGEN	1173	21
	NEW HOLLAND	666	8		KIA	449	1	08-990107-00	AUDI	63	12
08-784100-00	FORD EUROPE	331	1	08-849007-00	HYUNDAI	390	1		SEAT	983	14
08-784107-00	FORD EUROPE	331	1		KIA	449	1		SKODA	1009	13
08-784111-00	FORD EUROPE	331	1	08-849200-50	HYUNDAI	390	3		VOLKSWAGEN	1173	21
08-784200-00	FORD EUROPE	361	37		KIA	449	2	08-990111-00	AUDI	63	12
08-784207-00	FORD EUROPE	361	37	08-849207-50	HYUNDAI	390	3		SEAT	983	14
08-784600-00	FORD EUROPE	351	25		KIA	449	2		SKODA	1009	13
08-784607-00	FORD EUROPE	351	25	08-854700-00	FIAT	295	69		VOLKSWAGEN	1173	21
08-784611-00	FORD EUROPE	351	25		IVECO	418	9	08-990500-00	SCANIA	960	8
08-784700-00	IVECO	424	22		OPEL	745	59	08-990600-00	VOLVO COMMERCIAL	1248	14
08-784800-00	FORD EUROPE	373	57		RENAULT	925	51	08-990700-00	COMPRESSOR	194	11
		374	58		RENAULT TRUCKS	930	4		SCANIA	957	1
08-784811-00	FORD EUROPE	373	57		VAUXHALL	1108	57		VOLVO COMMERCIAL	1243	1
		374	58	08-854708-00	FIAT	295	69	08-990705-00	COMPRESSOR	194	11
08-784821-00	FORD EUROPE	373	57		IVECO	418	9		SCANIA	957	1
		374	58		OPEL	745	59		VOLVO COMMERCIAL	1243	1
08-785000-00	FORD EUROPE	333	6		RENAULT	925	51	08-990707-00	COMPRESSOR	194	11
	MAZDA	539	2		RENAULT TRUCKS	930	4		SCANIA	957	1
08-785007-00	FORD EUROPE	333	6		VAUXHALL	1108	57		VOLVO COMMERCIAL	1243	1
	MAZDA	539	2	08-873400-00	MINI	648	1	08-990800-00	COMPRESSOR	192	3
08-785011-00	FORD EUROPE	333	6	08-873407-00	MINI	648	1	08-990805-00	COMPRESSOR	192	3
	MAZDA	539	2	08-898400-00	MINI	648	1	08-990807-00	COMPRESSOR	192	3
08-785100-00	FORD EUROPE	345	18		SUBARU	1027	3	08-991000-00	AUDI	84	28
08-785107-00	FORD EUROPE	345	18		TOYOTA	1052	6			86	32
08-785200-00	FORD EUROPE	354	28	08-898407-00	MINI	648	1	08-991300-00	SEAT	978	4
08-785207-00	FORD EUROPE	354	28		SUBARU	1027	3		VOLKSWAGEN	1160	3
08-785300-00	IVECO	430	35		TOYOTA	1052	6	08-991307-00	SEAT	978	4
	NEW HOLLAND	669	18	08-960100-00	ISEKI	399	1		VOLKSWAGEN	1160	3
08-785400-00	FIAT	278	40		SUZUKI	1031	1	08-991400-00	AUDI	84	30
		280	42		YANMAR	1259	1	08-991407-00	AUDI	84	30
08-785408-00	FIAT	278	40	08-960200-00	BEDFORD	103	1				
		280	42		SUZUKI	1031	2				
08-785500-00	FIAT	269	21		VAUXHALL	1085	1				
08-785506-00	FIAT	269	21	08-960207-00	BEDFORD	103	1				
08-785507-00	FIAT	269	21		SUZUKI	1031	2				

CYLINDER BORE → GOETZE PART NO







Zylinderbohrung → Goetze Artikel-Nr. • Alésage de cylindre → Réf. Goetze
 Diámetro del cilindro → Referencia Goetze







					
58.00	08-331600-10	RENAULT		08-960200-00	BEDFORD
	08-333300-00	RENAULT			SUZUKI
60.00	08-400600-20	COMPRESSOR		08-960207-00	VAUXHALL
	08-403200-00	COMPRESSOR			BEDFORD
62.00	08-960100-00	ISEKI			SUZUKI
		SUZUKI			VAUXHALL
		YANMAR			
62.50	08-523900-00	RELIANT	66.50	08-427100-00	SMART
62.92	08-529700-00	AUSTIN MORRIS		08-427105-00	SMART
		MG		08-427107-00	SMART
63.50	08-136700-00	MERCEDES-BENZ	66.69	08-522200-00	CLAYTON DEWANDRE
		SMART	66.96	08-525800-00	TRIUMPH MOTORCYCLE
	08-136705-00	MERCEDES-BENZ	08-525807-00	TRIUMPH MOTORCYCLE	
	SMART	67.10	08-101300-00	SEAT	
08-136707-00	MERCEDES-BENZ		08-101307-00	SEAT	
	SMART		VOLKSWAGEN		
	08-408600-00	COMPRESSOR	67.20	08-782600-00	FIAT
	08-408605-00	COMPRESSOR		08-782606-00	FIAT
	08-408607-00	COMPRESSOR		LANCIA	
	08-990800-00	COMPRESSOR		LANCIA	
	08-990805-00	COMPRESSOR		08-782608-00	FIAT
	08-990807-00	COMPRESSOR		LANCIA	
64.56	08-522300-00	AUSTIN MORRIS	67.40	08-527600-00	FIAT
	08-522307-00	AUSTIN MORRIS		08-527606-00	FIAT
	08-522309-00	AUSTIN MORRIS		08-527608-00	FIAT
	08-522311-00	AUSTIN MORRIS	68.00	08-294700-00	NISSAN
	08-522314-00	AUSTIN MORRIS		08-294707-00	NISSAN
	08-522400-00	AUSTIN MORRIS		08-348700-00	SKODA
		ROVER	68.50	08-426800-00	DAEWOO
	08-522407-00	AUSTIN MORRIS		08-426807-00	DAEWOO
		ROVER		08-962900-00	SUZUKI
	08-522411-00	AUSTIN MORRIS	68.70	08-784100-00	FORD EUROPE
		ROVER		08-784107-00	FORD EUROPE
	08-522414-00	AUSTIN MORRIS		08-784111-00	FORD EUROPE
		ROVER	69.00	08-104100-00	NISSAN
	08-524300-10	AUSTIN MORRIS			08-104105-00
		ROVER		RENAULT	
	08-524307-10	AUSTIN MORRIS		08-104107-00	NISSAN
		ROVER		RENAULT	
	08-524311-10	AUSTIN MORRIS		08-426500-00	TOYOTA
		ROVER		08-426507-00	TOYOTA
	08-524314-10	AUSTIN MORRIS		08-450000-00	DACIA
		ROVER		RENAULT	
65.00	08-145100-00	FIAT		08-450007-00	DACIA
	08-145100-10	FIAT		RENAULT	
	08-145106-00	FIAT	69.50	08-108500-00	AUDI
	08-145108-00	FIAT		VOLKSWAGEN	
	08-209800-00	FIAT		08-108600-00	AUDI
		LANCIA		VOLKSWAGEN	
		SEAT		08-108700-00	AUDI
		ZASTAVA		VOLKSWAGEN	
	08-209806-00	FIAT		08-108707-00	AUDI
		LANCIA		VOLKSWAGEN	
		SEAT	69.60	08-137600-00	FIAT
		ZASTAVA		LANCIA	
	08-209808-00	FIAT		OPEL	
		LANCIA		SUBARU	
		SEAT		SUZUKI	
		ZASTAVA		VAUXHALL	
	08-334000-00	RENAULT		08-137606-00	FIAT
	08-528600-00	MARELLI		LANCIA	
	08-528607-00	MARELLI		OPEL	
	08-782700-00	FIAT		SUBARU	
65.50	08-140600-00	SMART			

					
		SUZUKI	70.62	08-106700-00	AUSTIN MORRIS
		VAUXHALL			MG
	08-425600-00	FIAT		08-521700-00	AUSTIN MORRIS
		LANCIA			MG
		OPEL			ROVER
		SUZUKI		08-521707-00	AUSTIN MORRIS
		VAUXHALL			MG
	08-425606-00	FIAT			ROVER
		LANCIA		08-521711-00	AUSTIN MORRIS
		OPEL			MG
		SUZUKI			ROVER
		VAUXHALL		08-521714-00	AUSTIN MORRIS
	08-425608-00	FIAT			MG
		LANCIA			ROVER
		OPEL		08-524100-00	AUSTIN MORRIS
		SUZUKI			MG
		VAUXHALL			ROVER
	08-435700-00	ALFA ROMEO		08-524107-00	AUSTIN MORRIS
		CHRYSLER			MG
		FIAT			ROVER
		LANCIA		08-524111-00	AUSTIN MORRIS
		OPEL			MG
		PEUGEOT			ROVER
		VAUXHALL		08-524114-00	AUSTIN MORRIS
	08-435706-00	ALFA ROMEO			MG
		CHRYSLER			ROVER
		FIAT	70.80	08-138400-00	CHRYSLER
		LANCIA			FIAT
		OPEL			LANCIA
		PEUGEOT			ZASTAVA
		VAUXHALL		08-138406-00	CHRYSLER
70.00	08-142300-00	FIAT			FIAT
		LANCIA			LANCIA
	08-142306-00	FIAT			ZASTAVA
		LANCIA		08-138408-00	CHRYSLER
	08-142308-00	FIAT			FIAT
		LANCIA			LANCIA
	08-154200-00	CITROEN			ZASTAVA
		FIAT	70.99	08-525400-00	TRIUMPH MOTORCYCLE
		LANCIA		08-525407-00	TRIUMPH MOTORCYCLE
		PEUGEOT		08-525411-00	TRIUMPH MOTORCYCLE
	08-154206-00	CITROEN		08-525414-00	TRIUMPH MOTORCYCLE
		FIAT	71.00	08-439600-00	CITROEN
		LANCIA			DAIHATSU
		PEUGEOT			PEUGEOT
	08-154208-00	CITROEN			SUBARU
		FIAT			TOYOTA
		LANCIA	71.50	08-105000-00	RENAULT
		PEUGEOT		08-335500-00	RENAULT
	08-207000-00	COMPRESSOR	71.90	08-102200-00	FORD EUROPE
	08-248200-00	COMPRESSOR		08-102207-00	FORD EUROPE
	08-248207-00	COMPRESSOR	72.00	08-138200-00	FIAT
	08-317300-00	CITROEN		08-154300-00	CITROEN
		PEUGEOT			PEUGEOT
		TALBOT		08-154307-00	CITROEN
	08-332200-00	RENAULT			PEUGEOT
	08-334600-00	DACIA		08-228300-00	HONDA
		DAF			TRIUMPH CAR
		RENAULT		08-252900-00	DEUTZ / KHD
		VOLVO		08-269400-00	COMPRESSOR
	08-528700-00	MARELLI		08-302200-00	OPEL
	08-528707-00	MARELLI			VAUXHALL
	08-743800-00	DAIHATSU		08-302207-00	OPEL
70.50	08-373000-00	TOYOTA			VAUXHALL

CYLINDER BORE → GOETZE PART NO







Zylinderbohrung → Goetze Artikel-Nr. • Alésage de cylindre → Réf. Goetze
Diámetro del cilindro → Referencia Goetze







					
	08-307500-00	OPEL			SUZUKI
		VAUXHALL			VAUXHALL
	08-307507-00	OPEL		08-429507-00	OPEL
		VAUXHALL			SUZUKI
	08-319400-00	CITROEN			VAUXHALL
		PEUGEOT	73.50	08-526600-00	AUSTIN MORRIS
		TALBOT			MG
	08-344800-00	SKODA		08-528400-00	FIAT
	08-348600-00	SKODA		08-528406-00	FIAT
	08-371600-10	TOYOTA		08-528408-00	FIAT
	08-374600-00	ZAZ	73.70	08-135300-00	CITROEN
	08-426300-00	CITROEN			FORD EUROPE
		PEUGEOT			MAZDA
		ZASTAVA			PEUGEOT
	08-433200-00	ALFA ROMEO			TOYOTA
		FIAT		08-135305-00	CITROEN
		LANCIA			FORD EUROPE
		OPEL			MAZDA
		VAUXHALL			PEUGEOT
	08-433206-00	ALFA ROMEO			TOYOTA
		FIAT		08-135307-00	CITROEN
		LANCIA			FORD EUROPE
		OPEL			MAZDA
		VAUXHALL			PEUGEOT
	08-436800-00	ALFA ROMEO			TOYOTA
		FIAT	74.00	08-144700-00	CITROEN
		LANCIA		08-147100-00	CITROEN
	08-436806-00	ALFA ROMEO		08-147800-00	CITROEN
		FIAT		08-208800-00	FORD EUROPE
		LANCIA		08-208807-00	FORD EUROPE
	08-438300-00	ALFA ROMEO		08-208811-00	FORD EUROPE
		CHRYSLER		08-228400-00	HONDA
		FIAT		08-337300-00	RENAULT
		LANCIA		08-344500-00	CITROEN
		OPEL			PEUGEOT
		VAUXHALL			TALBOT
	08-438306-00	ALFA ROMEO		08-428400-00	TOYOTA
		CHRYSLER		08-428407-00	TOYOTA
		FIAT		08-449000-00	FORD EUROPE
		LANCIA		08-449007-00	FORD EUROPE
		OPEL		08-530400-00	ALFA ROMEO
		VAUXHALL		08-785000-00	FORD EUROPE
	08-439800-00	TOYOTA			MAZDA
72.50	08-102700-00	OPEL		08-785007-00	FORD EUROPE
		VAUXHALL			MAZDA
	08-102707-00	OPEL		08-785011-00	FORD EUROPE
		VAUXHALL			MAZDA
	08-437400-00	OPEL		08-961800-00	SUZUKI
		VAUXHALL		08-961807-00	SUZUKI
73.00	08-291400-00	NISSAN	74.70	08-525700-00	TRIUMPH CAR
	08-333400-10	ARO		08-525707-00	TRIUMPH CAR
		DACIA		08-525709-00	TRIUMPH CAR
		DAF		08-525711-00	TRIUMPH CAR
		RENAULT	75.00	08-108800-00	AUDI
		VOLVO			VOLKSWAGEN
	08-374400-00	TOYOTA		08-108807-00	AUDI
	08-374407-00	TOYOTA			VOLKSWAGEN
	08-898400-00	MINI		08-138900-00	CITROEN
		SUBARU			PEUGEOT
		TOYOTA		08-154400-00	CITROEN
	08-898407-00	MINI			PEUGEOT
		SUBARU			TALBOT
		TOYOTA		08-154407-00	CITROEN
73.40	08-429500-00	OPEL			PEUGEOT

					
		TALBOT			MINI
08-154500-00		CITROEN			PEUGEOT
		PEUGEOT			SUZUKI
		ROVER		08-424008-00	CITROEN
08-163500-00		MERCEDES-BENZ			FIAT
08-163511-00		MERCEDES-BENZ			FORD EUROPE
08-305500-00		OPEL			MAZDA
		VAUXHALL			MINI
08-305507-00		OPEL			PEUGEOT
		VAUXHALL			SUZUKI
08-306300-00		BEDFORD		08-433600-00	CITROEN
		OPEL			FORD EUROPE
		VAUXHALL			PEUGEOT
08-306307-00		BEDFORD			TOYOTA
		OPEL			VOLVO
		VAUXHALL		08-433607-00	CITROEN
08-306311-00		BEDFORD			FORD EUROPE
		OPEL			PEUGEOT
		VAUXHALL			TOYOTA
08-325400-00		COMPRESSOR			VOLVO
08-325405-00		COMPRESSOR		08-433700-00	HONDA
08-325407-00		COMPRESSOR		08-433707-00	HONDA
08-334200-00		CITROEN		08-440000-00	TOYOTA
		PEUGEOT		08-502200-00	SEAT
		RENAULT			VOLKSWAGEN
		TALBOT		08-502207-00	SEAT
08-334207-00		CITROEN			VOLKSWAGEN
		PEUGEOT		08-520500-00	MG
		RENAULT			ROVER
		TALBOT		08-742500-00	COMPRESSOR
08-349200-00		SEAT		08-849000-00	HYUNDAI
08-371700-00		DAIHATSU			KIA
		TOYOTA		08-849007-00	HYUNDAI
08-401200-00		COMPRESSOR			KIA
08-403600-00		COMPRESSOR		08-990700-00	COMPRESSOR
08-403607-00		COMPRESSOR			SCANIA
08-404200-00		AUDI			VOLVO COMMERCIAL
		VOLKSWAGEN		08-990705-00	COMPRESSOR
08-404211-00		AUDI			SCANIA
		VOLKSWAGEN			VOLVO COMMERCIAL
08-406200-00		BARKAS		08-990707-00	COMPRESSOR
		SEAT			SCANIA
		VOLKSWAGEN			VOLVO COMMERCIAL
08-406207-00		BARKAS		08-991300-00	SEAT
		SEAT			VOLKSWAGEN
		VOLKSWAGEN		08-991307-00	SEAT
08-406211-00		BARKAS			VOLKSWAGEN
		SEAT	75.50	08-286700-00	HYUNDAI
		VOLKSWAGEN			MITSUBISHI
08-408700-00		AUDI			PROTON
		VOLKSWAGEN		08-349700-00	SKODA
08-408707-00		AUDI		08-435400-00	HYUNDAI
		VOLKSWAGEN		08-435407-00	HYUNDAI
08-424000-00		CITROEN		08-849200-50	HYUNDAI
		FIAT			KIA
		FORD EUROPE		08-849207-50	HYUNDAI
		MAZDA			KIA
		MINI		08-962600-00	SKODA
		PEUGEOT	75.80	08-336400-00	RENAULT
		SUZUKI		08-336407-00	RENAULT
08-424007-00		CITROEN	75.97	08-523700-00	TRIUMPH MOTORCYCLE
		FIAT		08-523707-00	TRIUMPH MOTORCYCLE
		FORD EUROPE	76.00	08-102300-00	FORD EUROPE
		MAZDA		08-102307-00	FORD EUROPE

CYLINDER BORE → GOETZE PART NO







Zylinderbohrung → Goetze Artikel-Nr. • Alésage de cylindre → Réf. Goetze
 Diámetro del cilindro → Referencia Goetze







					
	08-106100-00	KUBOTA		08-109500-00	AUDI
	08-123400-00	DACIA			PEGASO
		NISSAN			VOLKSWAGEN
		RENAULT			VOLVO
	08-123400-30	RENAULT		08-109505-00	AUDI
	08-123407-00	DACIA			PEGASO
		NISSAN			VOLKSWAGEN
		RENAULT			VOLVO
		SUZUKI		08-109507-00	AUDI
	08-123407-30	RENAULT			PEGASO
	08-215200-10	FIAT			VOLKSWAGEN
	08-215206-10	FIAT			VOLVO
	08-215208-10	FIAT		08-109511-00	AUDI
	08-215211-10	FIAT			PEGASO
	08-269700-00	FIAT			VOLKSWAGEN
		LADA			VOLVO
	08-269704-00	FIAT		08-109800-00	ARO
		LADA			AUDI
	08-269706-00	FIAT			VOLKSWAGEN
		LADA			VOLVO
	08-269710-00	FIAT		08-109807-00	ARO
		LADA			AUDI
	08-294400-00	NISSAN			VOLKSWAGEN
	08-294900-00	NISSAN			VOLVO
	08-307000-00	ISUZU		08-109811-00	ARO
		OPEL			AUDI
		VAUXHALL			VOLKSWAGEN
	08-307007-00	ISUZU		08-116100-00	VOLVO
		OPEL			AUDI
		VAUXHALL			SEAT
	08-307011-00	ISUZU			SKODA
		OPEL		08-116107-00	VOLKSWAGEN
		VAUXHALL			AUDI
	08-333500-00	ARO			SEAT
		DACIA			SKODA
		RENAULT			VOLKSWAGEN
		VOLVO		08-120100-00	VOLKSWAGEN
	08-333505-00	ARO			AUDI
		DACIA		08-120107-00	VOLKSWAGEN
		RENAULT			AUDI
		VOLVO		08-346000-00	VOLKSWAGEN
	08-333507-00	ARO		08-405200-00	CITROEN
		DACIA			AUDI
		RENAULT			PEGASO
		VOLVO			VOLKSWAGEN
	08-335600-00	RENAULT		08-405205-00	AUDI
	08-373100-00	TOYOTA			PEGASO
	08-426100-00	FORD EUROPE			VOLKSWAGEN
		MAZDA			VOLKSWAGEN
	08-426107-00	FORD EUROPE		08-405211-00	AUDI
		MAZDA			PEGASO
	08-439400-00	NISSAN			VOLKSWAGEN
	08-527000-00	NISSAN		08-405207-00	AUDI
	08-744400-00	DAIHATSU			PEGASO
	08-786300-00	FORD EUROPE			VOLKSWAGEN
	08-786307-00	FORD EUROPE			VOLKSWAGEN
	08-786600-00	FORD EUROPE		08-429907-00	AUDI
	08-786900-00	FORD EUROPE			SEAT
	08-962800-00	DAIHATSU			SKODA
		SUBARU			VOLKSWAGEN
76.50	08-103100-00	SEAT		08-433900-00	AUDI
		SKODA			SEAT
		VOLKSWAGEN			SKODA

					
		VOLKSWAGEN			VAUXHALL
	08-433907-00	AUDI		08-307100-00	OPEL
		SEAT			VAUXHALL
		SKODA		08-307107-00	OPEL
		VOLKSWAGEN			VAUXHALL
	08-436900-00	SEAT	77.80	08-306200-00	OPEL
		SKODA			VAUXHALL
		VOLKSWAGEN		08-306400-00	OPEL
	08-438600-00	DAEWOO			VAUXHALL
	08-438605-00	DAEWOO	78.00	08-253200-00	KIA
	08-438607-00	DAEWOO		08-293400-00	NISSAN
	08-502400-00	SEAT		08-317600-10	PEUGEOT
		VOLKSWAGEN		08-320100-00	PEUGEOT
	08-502800-00	SEAT		08-335000-10	RENAULT
		SKODA			VOLVO
		VOLKSWAGEN		08-335003-10	RENAULT
	08-502807-00	SEAT			VOLVO
		SKODA		08-335005-10	RENAULT
		VOLKSWAGEN			VOLVO
	08-848300-50	HYUNDAI		08-335007-10	RENAULT
		KIA			VOLVO
	08-848307-50	HYUNDAI		08-440100-00	NISSAN
		KIA			NISSAN
76.70	08-346000-00	PEUGEOT		08-440200-00	SUBARU
		TALBOT			SUZUKI
76.90	08-285400-00	HYUNDAI		08-527200-00	ALFA ROMEO
		MITSUBISHI		08-527300-00	ALFA ROMEO
77.00	08-150900-00 1	CITROEN		08-783200-00	FIAT
	08-165800-00	COMPRESSOR		08-960300-00	SUBARU
	08-165805-00	COMPRESSOR	78.30	08-103000-00	AUDI
	08-227700-00	HONDA			SKODA
	08-283900-00	FORD EUROPE			VOLKSWAGEN
		MAZDA		08-103007-00	AUDI
	08-325800-00	CITROEN			SKODA
		NISSAN			VOLKSWAGEN
		PEUGEOT	78.50	08-103800-00	CITROEN
		ROVER			PEUGEOT
	08-325806-00	CITROEN		08-103806-00	CITROEN
		NISSAN			PEUGEOT
		PEUGEOT		08-139400-00	CITROEN
		ROVER			PEUGEOT
	08-334500-00	RENAULT		08-139406-00	CITROEN
	08-390200-00	VOLKSWAGEN			PEUGEOT
	08-390205-00	VOLKSWAGEN		08-139407-00	CITROEN
	08-390207-10	VOLKSWAGEN			PEUGEOT
	08-394500-00	VOLKSWAGEN	79.00	08-125600-00	OPEL
	08-394505-00	VOLKSWAGEN			VAUXHALL
	08-394507-00	VOLKSWAGEN		08-125607-00	OPEL
	08-433500-00	MINI			VAUXHALL
	08-433505-00	MINI		08-141300-00	FORD EUROPE
	08-433507-00	MINI		08-141307-00	FORD EUROPE
	08-785500-00	FIAT		08-269800-00	LADA
	08-785506-00	FIAT			MOSKVICH
	08-785507-00	FIAT		08-269806-00	LADA
	08-785508-00	FIAT			MOSKVICH
77.24	08-781100-00	FORD EUROPE		08-269820-00	LADA
		RELIANT			MOSKVICH
	08-781107-00	FORD EUROPE		08-304200-00	OPEL
		RELIANT			VAUXHALL
	08-781111-00	FORD EUROPE		08-304207-00	OPEL
		RELIANT			VAUXHALL
77.60	08-144200-00	OPEL		08-304211-00	OPEL
		VAUXHALL			VAUXHALL
	08-144207-00	OPEL		08-306900-00	BEDFORD

CYLINDER BORE → GOETZE PART NO







Zylinderbohrung → Goetze Artikel-Nr. • Alésage de cylindre → Réf. Goetze
 Diámetro del cilindro → Referencia Goetze







					
		OPEL			SKODA
		VAUXHALL			VOLKSWAGEN
08-306907-00		BEDFORD		08-114907-00	AUDI
		OPEL			FORD EUROPE
		VAUXHALL			SEAT
08-307600-00		MAZDA			SKODA
		OPEL			VOLKSWAGEN
		VAUXHALL		08-114911-00	AUDI
08-307607-00		MAZDA			FORD EUROPE
		OPEL			SEAT
		VAUXHALL			SKODA
08-307800-00		OPEL			VOLKSWAGEN
		VAUXHALL		08-399200-00	VOLKSWAGEN
08-307807-00		OPEL		08-404100-00	AUDI
		VAUXHALL			VOLKSWAGEN
08-307811-00		OPEL		08-405000-00	AUDI
		VAUXHALL			VOLKSWAGEN
08-334300-00		RENAULT		08-429300-00	ALFA ROMEO
08-426700-00		LOTUS			CHRYSLER
		TOYOTA			FIAT
08-426707-00		LOTUS			LANCIA
		TOYOTA		08-432900-00	AUDI
08-427800-00		OPEL			SEAT
		VAUXHALL			SKODA
08-427807-00		OPEL			VOLKSWAGEN
		VAUXHALL		08-432907-00	AUDI
08-428100-00		FORD EUROPE			SEAT
08-435300-00		OPEL			SKODA
		VAUXHALL			VOLKSWAGEN
08-435307-00		OPEL		08-433000-00	AUDI
		VAUXHALL			SEAT
08-435500-00		OPEL			SKODA
		SAAB			VOLKSWAGEN
		VAUXHALL		08-433007-00	AUDI
08-435507-00		OPEL			SEAT
		SAAB			SKODA
		VAUXHALL			VOLKSWAGEN
79.38	08-313400-00	ALFA ROMEO		08-990100-00	AUDI
		BEDFORD			SEAT
		FORD EUROPE			SKODA
		PERKINS			VOLKSWAGEN
	08-315200-00	ALFA ROMEO		08-990105-00	AUDI
		BEDFORD			SEAT
		FORD EUROPE			SKODA
79.39	08-315200-00	PERKINS			VOLKSWAGEN
79.40	08-147900-00	CITROEN		08-990107-00	AUDI
79.50	08-104200-00	DACIA			SEAT
		NISSAN			SKODA
		RENAULT			VOLKSWAGEN
	08-104207-00	DACIA		08-990111-00	AUDI
		NISSAN			SEAT
		RENAULT			SKODA
	08-105200-00	DACIA			VOLKSWAGEN
		RENAULT	79.94	08-785100-00	FORD EUROPE
	08-105207-00	DACIA		08-785107-00	FORD EUROPE
		RENAULT	79.96	08-214100-00	FORD EUROPE
	08-114900-00	AUDI		08-214107-00	FORD EUROPE
		FORD EUROPE		08-214109-00	FORD EUROPE
		SEAT		08-214111-00	FORD EUROPE
		SKODA		08-529000-00	FORD EUROPE
		VOLKSWAGEN		08-529007-00	FORD EUROPE
	08-114905-00	AUDI	80.00	08-101200-00	MERCEDES-BENZ
		FORD EUROPE		08-101500-00	RENAULT
		SEAT		08-101507-00	RENAULT

					
	08-103400-00	VOLVO			VAUXHALL
	08-103500-00	RENAULT		08-305907-10	BEDFORD
		VOLVO			OPEL
	08-103507-00	RENAULT			VAUXHALL
		VOLVO		08-305911-10	BEDFORD
	08-105100-00	RENAULT			OPEL
		VOLVO			VAUXHALL
	08-105107-00	RENAULT		08-319100-10	PEUGEOT
		VOLVO		08-320700-10	PORSCHE
	08-105400-00	MERCEDES-BENZ		08-321500-00	CITROEN
	08-107800-10	ALFA ROMEO			PEUGEOT
	08-111800-00	RENAULT		08-321507-00	CITROEN
	08-111807-00	RENAULT			PEUGEOT
	08-113700-00	NISSAN		08-321510-00	CITROEN
		OPEL			PEUGEOT
		RENAULT		08-323600-00	CITROEN
		VAUXHALL			HONDA
	08-114000-00	YANMAR			PEUGEOT
	08-131300-00	BMW			ROVER
	08-131305-00	BMW		08-323607-00	CITROEN
	08-131307-00	BMW			HONDA
	08-131900-00	COMPRESSOR			PEUGEOT
	08-133100-10	BMW			ROVER
	08-133105-10	BMW		08-336500-00	DACIA
	08-133107-10	BMW			OPEL
	08-134200-00	BMW			RENAULT
	08-135400-00	BMW			VAUXHALL
	08-203100-00	FIAT		08-336505-00	DACIA
		LANCIA			OPEL
		SEAT			RENAULT
		ZASTAVA			VAUXHALL
	08-203104-00	FIAT		08-336507-00	DACIA
		LANCIA			OPEL
		SEAT			RENAULT
		ZASTAVA			VAUXHALL
	08-203106-00	FIAT		08-336510-00	DACIA
		LANCIA			OPEL
		SEAT			RENAULT
		ZASTAVA			VAUXHALL
	08-203108-00	FIAT		08-422200-00	BMW
		LANCIA		08-422207-00	BMW
		SEAT		08-422300-00	RENAULT
		ZASTAVA		08-422307-00	RENAULT
	08-203110-00	FIAT		08-435800-00	NISSAN
		LANCIA		08-435807-00	NISSAN
		SEAT		08-521600-00	LAND ROVER
		ZASTAVA			MG
	08-203111-00	FIAT			ROVER
		LANCIA		08-522700-00	LAND ROVER
		SEAT			LOTUS
		ZASTAVA			MG
	08-215500-10	FORD EUROPE			ROVER
	08-215507-10	FORD EUROPE		08-524800-00	MARELLI
	08-215511-10	FORD EUROPE		08-524804-00	MARELLI
	08-283800-00	MAZDA		08-524807-00	MARELLI
	08-294800-00	NISSAN		08-524811-00	MARELLI
	08-305600-00	OPEL		08-528500-00	ALFA ROMEO
		VAUXHALL		08-704500-00	BMW
	08-305607-00	OPEL			LAND ROVER
		VAUXHALL			OPEL
	08-305611-00	OPEL			VAUXHALL
		VAUXHALL		08-704507-00	BMW
	08-305900-10	BEDFORD			LAND ROVER
		OPEL			OPEL

CYLINDER BORE → GOETZE PART NO







Zylinderbohrung → Goetze Artikel-Nr. • Alésage de cylindre → Réf. Goetze
Diámetro del cilindro → Referencia Goetze







							
		VAUXHALL				08-780614-10	FORD EUROPE
	08-704900-00	BMW				08-780617-10	FORD EUROPE
	08-705000-00	BMW		81.00		08-102400-00	VOLVO
	08-705007-00	BMW				08-105900-00	AUDI
80.25	08-525900-00	AUSTIN MORRIS					SEAT
		LDV					SKODA
	08-525907-00	AUSTIN MORRIS					VOLKSWAGEN
		LDV			08-105907-00		AUDI
	08-525909-00	AUSTIN MORRIS					SEAT
		LDV					SKODA
	08-525911-00	AUSTIN MORRIS					VOLKSWAGEN
		LDV			08-109400-10		AUDI
	08-525914-00	AUSTIN MORRIS					SEAT
		LDV					VOLKSWAGEN
80.50	08-124800-00	FIAT			08-109407-10		AUDI
		LANCIA					SEAT
	08-124806-00	FIAT					VOLKSWAGEN
		LANCIA			08-109700-00		AUDI
	08-124808-00	FIAT					SEAT
		LANCIA					VOLKSWAGEN
	08-141200-00	OPEL			08-109705-00		AUDI
		SAAB					SEAT
		VAUXHALL					VOLKSWAGEN
	08-141207-00	OPEL			08-109707-00		AUDI
		SAAB					SEAT
		VAUXHALL					VOLKSWAGEN
	08-439300-00	LOTUS			08-115900-00		AUDI
		TOYOTA					SEAT
	08-524900-00	FIAT			08-139500-00		AUDI
	08-780700-00	FIAT					MITSUBISHI
	08-783600-00	FIAT					SEAT
		LANCIA					SKODA
		ZASTAVA					VOLKSWAGEN
	08-783606-00	FIAT			08-139507-00		AUDI
		LANCIA					MITSUBISHI
		ZASTAVA					SEAT
	08-783608-00	FIAT					SKODA
		LANCIA					VOLKSWAGEN
		ZASTAVA			08-139800-00		VOLVO
	08-783610-00	FIAT			08-148300-00		AUDI
		LANCIA					SEAT
		ZASTAVA					SKODA
	08-783611-00	FIAT					VOLKSWAGEN
		LANCIA			08-283700-00		MAZDA
		ZASTAVA			08-335100-00		RENAULT
	08-786700-00	FIAT					VOLVO
		LANCIA			08-335105-00		RENAULT
80.60	08-107300-00	FORD EUROPE					VOLVO
	08-107307-00	FORD EUROPE			08-335107-00		RENAULT
	08-136600-00	FORD EUROPE					VOLVO
	08-136607-00	FORD EUROPE			08-373200-00		TOYOTA
	08-287000-00	MITSUBISHI			08-373207-00		TOYOTA
	08-287200-00	MITSUBISHI			08-421000-00		VOLKSWAGEN
	08-348200-00	PEUGEOT			08-421007-00		VOLKSWAGEN
		TALBOT			08-428300-00		TOYOTA
	08-786000-00	FORD EUROPE			08-428307-00		TOYOTA
	08-786007-00	FORD EUROPE			08-432300-00		AUDI
	08-786500-00	FORD EUROPE					SEAT
	08-786507-00	FORD EUROPE					SKODA
80.98	08-207400-00	FORD EUROPE					VOLKSWAGEN
	08-780600-10	FORD EUROPE			08-432300-10		VOLKSWAGEN
	08-780607-10	FORD EUROPE			08-432307-00		AUDI
	08-780609-10	FORD EUROPE					SEAT
	08-780611-10	FORD EUROPE					SKODA

					
		VOLKSWAGEN			FIAT
	08-432400-00	CITROEN			LANCIA
		JAGUAR			OPEL
		LAND ROVER			SAAB
		PEUGEOT			VAUXHALL
	08-501500-00	AUDI		08-124006-00	ALFA ROMEO
		VOLKSWAGEN			FIAT
		VOLVO			LANCIA
	08-501507-00	AUDI			OPEL
		VOLKSWAGEN			SAAB
		VOLVO			VAUXHALL
	08-501900-00	FORD EUROPE		08-124008-00	ALFA ROMEO
		SEAT			FIAT
		VOLKSWAGEN			LANCIA
	08-501907-00	FORD EUROPE			OPEL
		SEAT			SAAB
		VOLKSWAGEN			VAUXHALL
	08-502000-00	VOLKSWAGEN		08-139900-00	COMPRESSOR
	08-502900-00	AUDI			IVECO
		SEAT		08-145400-00	ALFA ROMEO
		SKODA			FIAT
		VOLKSWAGEN			LANCIA
	08-502905-00	AUDI		08-145406-00	ALFA ROMEO
		SEAT			FIAT
		SKODA			LANCIA
		VOLKSWAGEN		08-146100-00	ALFA ROMEO
	08-502907-00	AUDI			FIAT
		SEAT			LANCIA
		SKODA			OPEL
		VOLKSWAGEN			SAAB
81.30	08-784600-00	FORD EUROPE			VAUXHALL
	08-784607-00	FORD EUROPE		08-146106-00	ALFA ROMEO
	08-784611-00	FORD EUROPE			FIAT
81.60	08-307700-00	OPEL			LANCIA
		SAAB			OPEL
		VAUXHALL			SAAB
	08-307707-00	OPEL			VAUXHALL
		SAAB		08-146108-00	ALFA ROMEO
		VAUXHALL			FIAT
	08-307711-00	OPEL			LANCIA
		SAAB			OPEL
		VAUXHALL			SAAB
82.00	08-107900-00	ALFA ROMEO			VAUXHALL
		FIAT		08-247000-00	BEDFORD
		LANCIA			ISUZU
	08-107908-00	ALFA ROMEO		08-268300-00	LOMBARDINI
		FIAT		08-268307-00	LOMBARDINI
		LANCIA		08-268311-00	LOMBARDINI
	08-108000-00	ALFA ROMEO		08-269900-00	LADA
		FIAT			MOSKVICH
		LANCIA		08-269906-00	LADA
	08-108008-00	ALFA ROMEO			MOSKVICH
		FIAT		08-269910-00	LADA
		LANCIA			MOSKVICH
	08-118000-00	ALFA ROMEO		08-277000-00	MOSKVICH
		FIAT		08-336600-00	RENAULT
		LANCIA		08-425200-00	LADA
	08-118006-00	ALFA ROMEO		08-427600-00	MERCEDES-BENZ
		FIAT		08-427600-10	MERCEDES-BENZ
		LANCIA		08-439500-00	LOTUS
	08-118008-00	ALFA ROMEO			TOYOTA
		FIAT		08-440700-00	BMW
		LANCIA		08-502300-00	VOLKSWAGEN
	08-124000-00	ALFA ROMEO		08-523100-00	FIAT

CYLINDER BORE → GOETZE PART NO







Zylinderbohrung → Goetze Artikel-Nr. • Alésage de cylindre → Réf. Goetze
 Diámetro del cilindro → Referencia Goetze







					
		LANCIA	82.55	08-526000-00	LISTER
	08-523108-00	FIAT	82.60	08-141400-00	FIAT
		LANCIA		08-782300-00	FIAT
	08-529200-00	COMPRESSOR		08-782308-00	FIAT
		MARELLI		08-783400-00	FIAT
	08-529204-00	COMPRESSOR		08-783800-00	ALFA ROMEO
		MARELLI			FIAT
	08-529207-00	COMPRESSOR			LANCIA
		MARELLI		08-783808-00	ALFA ROMEO
	08-529300-00	FIAT			FIAT
		LANCIA			LANCIA
	08-529306-00	FIAT		08-785400-00	FIAT
		LANCIA		08-785408-00	FIAT
	08-787000-00	ALFA ROMEO	82.70	08-227800-00	HONDA
		FIAT		08-323400-00	PEUGEOT
		LANCIA		08-337400-00	RENAULT
	08-787006-00	ALFA ROMEO			VOLVO
		FIAT		08-337700-00	RENAULT
		LANCIA	82.90	08-183100-00	MERCEDES-BENZ
82.20	08-104000-00	CITROEN		08-183107-00	MERCEDES-BENZ
		FIAT		08-183111-00	MERCEDES-BENZ
		PEUGEOT	82.99	08-529907-00	JAGUAR
	08-104008-00	CITROEN		08-529909-00	JAGUAR
		FIAT		08-529911-00	JAGUAR
		PEUGEOT	83.00	08-102500-00	VOLVO
	08-426600-00	TOYOTA		08-104500-00	RENAULT
	08-426607-00	TOYOTA		08-105500-00	CITROEN
82.50	08-107000-00	FORD EUROPE			FIAT
	08-107007-00	FORD EUROPE			LADA
	08-107011-00	FORD EUROPE			PEUGEOT
	08-306700-00	BEDFORD			SUZUKI
		OPEL		08-105507-00	CITROEN
		VAUXHALL			FIAT
	08-306707-00	BEDFORD			LADA
		OPEL			PEUGEOT
		VAUXHALL			SUZUKI
	08-306711-00	BEDFORD		08-105510-00	CITROEN
		OPEL			FIAT
		VAUXHALL			LADA
	08-320600-10	PORSCHE			PEUGEOT
	08-435100-10	AUDI			SUZUKI
		SEAT		08-110900-00	ALFA ROMEO
		SKODA		08-110906-00	ALFA ROMEO
		VOLKSWAGEN		08-124700-00	ALFA ROMEO
	08-437000-00	FORD EUROPE		08-124706-00	ALFA ROMEO
	08-437007-00	FORD EUROPE		08-124708-00	ALFA ROMEO
	08-500600-00	AUDI		08-145200-00	ALFA ROMEO
	08-501200-00	AUDI		08-145206-00	ALFA ROMEO
	08-501800-00	AUDI		08-145300-00	ALFA ROMEO
		SEAT		08-145306-00	ALFA ROMEO
		SKODA		08-151200-00	CITROEN
		VOLKSWAGEN			PEUGEOT
	08-501807-00	AUDI		08-152000-00	CITROEN
		SEAT			FIAT
		SKODA			LADA
		VOLKSWAGEN			LDV
	08-783500-00	FORD EUROPE			PEUGEOT
	08-783507-00	FORD EUROPE			ROVER
	08-783511-00	FORD EUROPE			SUZUKI
	08-785200-00	FORD EUROPE			TALBOT
	08-785207-00	FORD EUROPE		08-152003-00	CITROEN
	08-991000-00	AUDI			FIAT
	08-991400-00	AUDI			LADA
	08-991407-00	AUDI			LDV

					
		PEUGEOT			KIA
		ROVER		08-431907-00	HYUNDAI
		SUZUKI			KIA
		TALBOT		08-433100-00	AUDI
08-152007-00		CITROEN			VOLKSWAGEN
		FIAT		08-433105-00	AUDI
		LADA			VOLKSWAGEN
		LDV		08-433107-00	AUDI
		PEUGEOT			VOLKSWAGEN
		ROVER		08-433400-00	JEEP
		SUZUKI			MERCEDES-BENZ
		TALBOT		08-433405-00	JEEP
08-152010-00		CITROEN			MERCEDES-BENZ
		FIAT		08-433407-00	JEEP
		LADA			MERCEDES-BENZ
		LDV		08-434300-00	AUDI
		PEUGEOT			VOLKSWAGEN
		ROVER		08-434307-00	AUDI
		SUZUKI			VOLKSWAGEN
		TALBOT		08-436500-00	ALFA ROMEO
08-152011-00		CITROEN			CHRYSLER
		FIAT			FIAT
		LADA			LANCIA
		LDV			OPEL
		PEUGEOT			SAAB
		ROVER			SUZUKI
		SUZUKI			VAUXHALL
		TALBOT		08-436506-00	ALFA ROMEO
08-215100-10		FIAT			CHRYSLER
		SEAT			FIAT
08-215108-10		FIAT			LANCIA
		SEAT			OPEL
08-215110-10		FIAT			SAAB
		SEAT			SUZUKI
08-292800-00		ISEKI			VAUXHALL
		NISSAN		08-437100-00	MERCEDES-BENZ
		YANMAR		08-502100-00	VOLVO
08-322400-00		CITROEN		08-502107-00	VOLVO
		PEUGEOT	83.20	08-126100-00	OPEL
08-323400-00		CITROEN			VAUXHALL
		FIAT		08-126107-00	OPEL
		PEUGEOT			VAUXHALL
08-325500-00		CITROEN		08-421700-00	MERCEDES-BENZ
		FIAT	83.32	08-530100-00	AUSTIN MORRIS
		PEUGEOT			MG
		SUZUKI		08-530107-00	AUSTIN MORRIS
08-325507-00		CITROEN			MG
		FIAT		08-530109-00	AUSTIN MORRIS
		PEUGEOT			MG
		SUZUKI	84.00	08-102800-00	OPEL
08-349300-00		SEAT			VAUXHALL
08-374300-00		TOYOTA		08-102807-00	OPEL
08-394800-00		VOLKSWAGEN			VAUXHALL
08-427400-00		MERCEDES-BENZ		08-102900-00	OPEL
08-427407-00		MERCEDES-BENZ			VAUXHALL
08-427500-00		MERCEDES-BENZ		08-102907-00	OPEL
		MITSUBISHI			VAUXHALL
		SMART		08-106500-00	BMW
08-427507-00		MERCEDES-BENZ		08-106507-00	BMW
		MITSUBISHI		08-107100-00	ALFA ROMEO
		SMART		08-107100-10	ALFA ROMEO
08-429400-00		FORD EUROPE		08-109000-10	ALFA ROMEO
08-429407-00		FORD EUROPE		08-109008-10	ALFA ROMEO
08-431900-00		HYUNDAI		08-109900-00	BMW

CYLINDER BORE → GOETZE PART NO







Zylinderbohrung → Goetze Artikel-Nr. • Alésage de cylindre → Réf. Goetze
 Diámetro del cilindro → Referencia Goetze







					
08-110200-00	ALFA ROMEO			08-319600-10	PORSCHE
08-110700-00	BMW			08-325300-00	PORSCHE
08-114400-00	BMW			08-421800-00	BMW
	ROVER			08-422000-00	NISSAN
08-114400-10	BMW				OPEL
	ROVER				RENAULT
08-114400-40	BMW				VAUXHALL
08-114400-45	BMW		08-422007-00		NISSAN
08-114400-55	BMW				OPEL
08-114405-00	BMW				RENAULT
	ROVER				VAUXHALL
08-114405-40	BMW		08-425300-00		BMW
08-126000-00	OPEL		08-425700-00		BMW
	SAAB		08-425707-00		BMW
	VAUXHALL		08-429800-00		BMW
08-126007-00	OPEL		08-432200-00		BMW
	SAAB		08-434600-00		BMW
	VAUXHALL		08-439100-00		CITROEN
08-128200-10	BMW				JAGUAR
08-128205-10	BMW				LAND ROVER
08-128207-10	BMW				PEUGEOT
08-133200-10	BMW		08-520300-00		PEUGEOT
08-137400-00	AUDI		08-702600-00		BMW
	PORSCHE		08-702605-00		BMW
	VOLKSWAGEN		08-702607-00		BMW
08-142400-00	ALFA ROMEO		08-702800-00		BMW
	FIAT		08-704200-00		BMW
	LANCIA		08-704207-00		BMW
08-142406-00	ALFA ROMEO		08-704800-00		BMW
	FIAT		08-705100-00		BMW
	LANCIA		08-705107-00		BMW
08-207600-00	FIAT		08-705200-00		BMW
	LANCIA		08-705207-00		BMW
	SEAT		08-780200-00		FORD EUROPE
08-207604-00	FIAT		08-782400-00		FORD EUROPE
	LANCIA	84.45	08-119800-00		HONDA
	SEAT				LAND ROVER
08-207606-00	FIAT				ROVER
	LANCIA		08-119807-00		HONDA
	SEAT				LAND ROVER
08-207608-00	FIAT				ROVER
	LANCIA		08-140000-00		LAND ROVER
	SEAT		08-140007-00		LAND ROVER
08-215300-10	ALFA ROMEO		08-524600-00		ROVER
	FIAT		08-524607-00		ROVER
	LANCIA	84.50	08-106800-00		NISSAN
	SEAT		08-106807-00		NISSAN
	UAZ		08-139600-00		AUDI
08-215306-10	ALFA ROMEO				VOLKSWAGEN
	FIAT		08-437300-00		AUDI
	LANCIA	84.80	08-107400-00		FORD EUROPE
	SEAT		08-306000-00		OPEL
	UAZ				VAUXHALL
08-215308-10	ALFA ROMEO		08-306007-00		OPEL
	FIAT				VAUXHALL
	LANCIA		08-306100-00		OPEL
	SEAT				VAUXHALL
	UAZ		08-307200-00		OPEL
08-245400-00	ISUZU				VAUXHALL
08-315300-00	CITROEN		08-307207-00		OPEL
	PEUGEOT				VAUXHALL
08-315307-00	CITROEN		08-701100-00		BMW MOTORCYCLE
	PEUGEOT		08-701200-00		BMW MOTORCYCLE
08-319500-10	PORSCHE		08-786400-00		FORD EUROPE

					
85.00	08-786407-00	FORD EUROPE	85.30	08-741204-00	MERCEDES-BENZ COMMERCIAL
	08-114100-00	YANMAR		08-741205-00	COMPRESSOR
	08-114700-00	CITROEN		08-741207-00	MERCEDES-BENZ COMMERCIAL
		FIAT		08-741700-00	COMPRESSOR
		FORD EUROPE		08-287900-00	MERCEDES-BENZ COMMERCIAL
		LANCIA		08-741207-00	COMPRESSOR
		PEUGEOT		08-741700-00	MERCEDES-BENZ COMMERCIAL
		SUZUKI		08-741700-00	COMPRESSOR
		VOLVO		08-287900-00	MERCEDES-BENZ
					08-394600-00
08-114708-00	CITROEN		85.50	08-394614-10	VOLKSWAGEN
	FIAT			08-405300-10	VOLKSWAGEN
	FORD EUROPE			08-405314-10	VOLKSWAGEN
	LANCIA			08-405314-10	VOLKSWAGEN
	PEUGEOT		86.00	08-112700-00	FORD EUROPE
	SUZUKI			08-112707-00	FORD EUROPE
	VOLVO			08-129500-00	BMW
				08-129505-00	BMW
	08-126600-00	CITROEN		08-129507-00	BMW
		FIAT		08-136300-00	MERCEDES-BENZ
08-126608-00	LANCIA			08-140700-00	FORD EUROPE
	PEUGEOT			08-140707-00	FORD EUROPE
	CITROEN			08-140800-00	FORD EUROPE
	FIAT			08-140807-00	FORD EUROPE
	LANCIA			08-140807-00	FORD EUROPE
	PEUGEOT			08-154600-00	CITROEN
					FIAT
	08-137200-00	BMW			LANCIA
	08-142200-00	BMW			PEUGEOT
	08-154900-00	CITROEN			CITROEN
	FIAT		08-154605-00	FIAT	
	PEUGEOT			LANCIA	
08-154908-00	CITROEN			PEUGEOT	
	FIAT			CITROEN	
	PEUGEOT			08-154608-00	FIAT
					LANCIA
	08-163600-00	MERCEDES-BENZ			PEUGEOT
	08-267400-00	LOMBARDINI			CITROEN
	08-267407-00	LOMBARDINI			PEUGEOT
	08-267411-00	LOMBARDINI		08-154700-00	CITROEN
	08-288900-00	MOSKVIC			PEUGEOT
	08-293500-10	NISSAN		08-176600-00	MERCEDES-BENZ
08-295400-00	ISEKI			08-176607-00	MERCEDES-BENZ
	NISSAN			08-176611-00	MERCEDES-BENZ
	YANMAR			08-247200-00	BEDFORD
					ISEKI
	08-304000-00	OPEL			ISUZU
		VAUXHALL			YANMAR
	08-401000-00	COMPRESSOR			ISUZU
	08-427300-00	BMW		08-247200-10	BEDFORD
	08-435200-00	NISSAN			ISUZU
		OPEL			YANMAR
08-435207-00	RENAULT			08-247207-00	BEDFORD
	VAUXHALL				ISEKI
	NISSAN				ISUZU
	OPEL				YANMAR
	RENAULT			08-247211-00	BEDFORD
	VAUXHALL				ISEKI
	CITROEN				ISUZU
	FORD EUROPE				YANMAR
	JAGUAR			08-247300-00	BEDFORD
	08-436700-00	LANCIA			ISUZU
	FIAT			MAZDA	
	PEUGEOT		08-253300-00	MAZDA	
08-439000-00	HONDA			08-282700-10	KIA
	08-527800-00	IVECO			MAZDA
		NEW HOLLAND		08-283600-00	FORD EUROPE
	08-527808-00	IVECO			ISEKI
		NEW HOLLAND			KIA
	08-741200-00	COMPRESSOR			MAZDA

CYLINDER BORE → GOETZE PART NO







Zylinderbohrung → Goetze Artikel-Nr. • Alésage de cylindre → Réf. Goetze
Diámetro del cilindro → Referencia Goetze







					
		SUZUKI			FIAT
		YANMAR			LANCIA
08-283607-00		FORD EUROPE		08-783706-00	CITROEN
		ISEKI			FIAT
		KIA			LANCIA
		MAZDA		08-783708-00	CITROEN
		SUZUKI			FIAT
		YANMAR			LANCIA
08-283611-00		FORD EUROPE		08-783711-00	CITROEN
		ISEKI			FIAT
		KIA			LANCIA
		MAZDA		08-786800-00	FIAT
		SUZUKI			LANCIA
		YANMAR		08-786806-00	FIAT
08-306800-00		LADA			LANCIA
		OPEL	86.50	08-181500-10	MERCEDES-BENZ
		SAAB		08-320500-10	PORSCHE
		VAUXHALL		08-399700-10	AUDI
08-306807-00		LADA			PORSCHE
		OPEL			VOLKSWAGEN
		SAAB		08-399707-10	AUDI
		VAUXHALL			PORSCHE
08-306811-00		LADA			VOLKSWAGEN
		OPEL	86.99	08-522600-00	JAGUAR
		SAAB		08-522607-00	JAGUAR
		VAUXHALL		08-525500-00	JAGUAR
08-334700-10		RENAULT		08-525507-00	JAGUAR
08-334704-10		RENAULT		08-525509-00	JAGUAR
08-334707-10		RENAULT	87.00	08-101400-00	CITROEN
08-335400-00		CHRYSLER			PEUGEOT
		JEEP		08-101600-00	RENAULT
		RENAULT		08-104700-00	RENAULT
08-337000-00		RENAULT		08-110300-00	ALFA ROMEO
08-337100-00		CHRYSLER		08-118700-00	RENAULT
		JEEP		08-118800-00	RENAULT
		RENAULT		08-127400-00	NISSAN
08-427700-00		CITROEN			OPEL
		FIAT			RENAULT
		FORD EUROPE			VAUXHALL
		JAGUAR		08-127407-00	NISSAN
		PEUGEOT			OPEL
08-427707-00		CITROEN			RENAULT
		FIAT			VAUXHALL
		FORD EUROPE		08-170600-10	MERCEDES-BENZ
		JAGUAR			SEAT
		PEUGEOT		08-170607-10	MERCEDES-BENZ
08-436300-00		LEXUS			SEAT
		TOYOTA		08-170611-10	MERCEDES-BENZ
08-439700-00		DAIHATSU			SEAT
		TOYOTA		08-170700-10	MERCEDES-BENZ
08-439900-00		TOYOTA			SEAT
08-440300-00		NISSAN		08-170707-10	MERCEDES-BENZ
08-440300-10		NISSAN			SEAT
08-784200-00		FORD EUROPE		08-170711-10	MERCEDES-BENZ
08-784207-00		FORD EUROPE			SEAT
86.20	08-780000-00	FORD EUROPE		08-175500-00	MERCEDES-BENZ
	08-780007-00	FORD EUROPE		08-175507-00	MERCEDES-BENZ
86.40	08-209700-00	FIAT		08-175511-00	MERCEDES-BENZ
		LANCIA		08-181600-10	MERCEDES-BENZ
08-209706-00		FIAT		08-181607-10	MERCEDES-BENZ
		LANCIA		08-181611-10	MERCEDES-BENZ
08-209708-00		FIAT		08-183200-00	MERCEDES-BENZ
		LANCIA		08-183207-00	MERCEDES-BENZ
08-783700-00		CITROEN		08-183300-00	MERCEDES-BENZ

							
		08-183307-00	MERCEDES-BENZ				RENAULT
		08-303200-00	OPEL			08-336300-00	RENAULT
		08-743600-00	MERCEDES-BENZ			08-372100-10	TOYOTA
		08-743607-00	MERCEDES-BENZ			08-428700-00	MERCEDES-BENZ
87.31		08-241300-00	IHC			08-428707-00	MERCEDES-BENZ
87.32		08-525000-00	LISTER			08-440900-00	MERCEDES-BENZ
		08-525007-00	LISTER			08-742600-00	COMPRESSOR
		08-525011-00	LISTER			08-742605-00	COMPRESSOR
		08-525014-00	LISTER	88.50		08-183000-00	MERCEDES-BENZ
87.50		08-126200-00	OPEL			08-183007-00	MERCEDES-BENZ
			VAUXHALL			08-287700-00	MERCEDES-BENZ
		08-126207-00	OPEL			08-436400-00	LEXUS
			VAUXHALL				TOYOTA
		08-423400-00	FORD EUROPE	88.80		08-307400-00	OPEL
			MAZDA				VAUXHALL
			VOLVO	88.86		08-520100-00	LAND ROVER
		08-423407-00	FORD EUROPE				LDV
			MAZDA				ROVER
			VOLVO			08-520107-00	LAND ROVER
87.65		08-205800-00	FORD EUROPE				LDV
		08-205807-00	FORD EUROPE				ROVER
		08-780500-00	FORD EUROPE	88.90		08-284100-00	MAZDA
88.00		08-110000-00	ALFA ROMEO			08-289200-00	MAHINDRA
			VM			08-317200-00	PERKINS
		08-110500-00	ALFA ROMEO			08-405900-00	VOLVO COMMERCIAL
			FIAT			08-406300-10	VOLVO
		08-117900-00	MERCEDES-BENZ			08-406306-10	VOLVO
		08-117907-00	MERCEDES-BENZ			08-406309-10	VOLVO
		08-124600-00	ALFA ROMEO			08-406900-10	VOLVO
		08-136400-00	MERCEDES-BENZ			08-408400-00	VOLVO
		08-136400-10	MERCEDES-BENZ			08-408500-00	VOLVO
		08-136407-00	MERCEDES-BENZ	89.00		08-127300-00	BMW
		08-138000-00	FIAT			08-132900-00	BMW
			IVECO			08-132905-00	BMW
		08-138006-00	FIAT			08-132907-00	BMW
			IVECO			08-137500-00	OPEL
		08-138008-00	FIAT				RENAULT
			IVECO				VAUXHALL
		08-182900-00	MERCEDES-BENZ			08-137500-10	NISSAN
		08-182907-00	MERCEDES-BENZ				OPEL
		08-247600-00	ISUZU				RENAULT
			OPEL				VAUXHALL
			VAUXHALL			08-137507-00	OPEL
		08-251000-00	COMPRESSOR				RENAULT
		08-251007-00	COMPRESSOR				VAUXHALL
		08-251011-00	COMPRESSOR			08-137507-10	NISSAN
		08-313800-10	FORD EUROPE				OPEL
			PEUGEOT				RENAULT
			VOLGA				VAUXHALL
		08-316900-00	CITROEN			08-179500-00	MERCEDES-BENZ
			FIAT			08-179505-00	MERCEDES-BENZ
			PEUGEOT			08-179507-00	MERCEDES-BENZ
			RENAULT			08-179511-00	MERCEDES-BENZ
			TALBOT			08-181400-10	MERCEDES-BENZ
			VOLVO			08-181407-10	MERCEDES-BENZ
		08-316907-00	CITROEN			08-287400-00	MERCEDES-BENZ
			FIAT			08-294500-00	NISSAN
			PEUGEOT			08-435900-00	NISSAN
			RENAULT			08-435907-00	NISSAN
			TALBOT			08-436000-00	NISSAN
			VOLVO			08-436007-00	NISSAN
		08-334400-00	CITROEN			08-436100-00	NISSAN
			JEEP			08-436107-00	NISSAN
			PEUGEOT			08-700200-00	BMW

CYLINDER BORE → GOETZE PART NO







Zylinderbohrung → Goetze Artikel-Nr. • Alésage de cylindre → Réf. Goetze
Diámetro del cilindro → Referencia Goetze







					
	08-743100-00	MERCEDES-BENZ SSANGYONG		08-524211-00	AUSTIN MORRIS LAND ROVER
	08-743107-00	MERCEDES-BENZ SSANGYONG		08-524400-00	LAND ROVER
	08-743120-00	MERCEDES-BENZ SSANGYONG		08-524407-00	LAND ROVER
89.60	08-107600-00	FORD EUROPE		08-526400-00	LAND ROVER
	08-107607-00	FORD EUROPE		08-526411-00	LAND ROVER
89.90	08-113500-00	FORD EUROPE		08-714400-00	LAND ROVER LDV
	08-113507-00	FORD EUROPE		08-714407-00	LAND ROVER LDV
	08-113511-00	FORD EUROPE		08-714411-00	LAND ROVER LDV
	08-119000-00	MERCEDES-BENZ			
	08-119005-00	MERCEDES-BENZ	90.80	08-206600-00	FORD EUROPE
	08-119007-00	MERCEDES-BENZ		08-206607-00	FORD EUROPE
	08-148100-00	FORD EUROPE LAND ROVER		08-206611-00	FORD EUROPE
	08-148105-00	FORD EUROPE LAND ROVER		08-206617-00	FORD EUROPE
	08-148107-00	FORD EUROPE LAND ROVER		08-780300-00	FORD EUROPE
	08-287500-00	MERCEDES-BENZ SSANGYONG		08-780307-00	FORD EUROPE
	08-287505-00	MERCEDES-BENZ SSANGYONG	90.82	08-780309-00	FORD EUROPE
	08-287507-00	MERCEDES-BENZ SSANGYONG	90.90	08-780311-00	FORD EUROPE
				08-780314-00	FORD EUROPE
90.00	08-136200-00	COMPRESSOR		08-529100-00	FORD EUROPE
	08-176300-00	COMPRESSOR		08-109100-00	MERCEDES-BENZ SSANGYONG
	08-176307-00	COMPRESSOR		08-109107-00	MERCEDES-BENZ SSANGYONG
	08-176311-00	COMPRESSOR		08-173800-00	MERCEDES-BENZ
	08-204500-00	FORD EUROPE SAAB		08-173805-00	MERCEDES-BENZ
	08-278200-00	MWM		08-173807-00	MERCEDES-BENZ
	08-314900-10	ARO		08-173811-00	MERCEDES-BENZ
		FORD EUROPE OPEL PEUGEOT VOLVO COMMERCIAL	91.00	08-176700-00	MERCEDES-BENZ
	08-319700-10	PORSCHE		08-176707-00	MERCEDES-BENZ
	08-319800-10	PORSCHE		08-176708-00	MERCEDES-BENZ
	08-347000-00	SAAB		08-176711-00	MERCEDES-BENZ
	08-373600-00	TOYOTA		08-103200-00	DEUTZ / KHD
	08-373700-00	TOYOTA		08-103207-00	DEUTZ / KHD
	08-397900-00	VOLKSWAGEN		08-173800-00	MERCEDES-BENZ
	08-404500-00	COMPRESSOR		08-173805-00	MERCEDES-BENZ
	08-523600-00	JAGUAR		08-173807-00	MERCEDES-BENZ
	08-526700-00	JAGUAR		08-173811-00	MERCEDES-BENZ
	08-700800-00	BMW MOTORCYCLE		08-176700-00	MERCEDES-BENZ
	08-963300-00	SAAB		08-176707-00	MERCEDES-BENZ
90.47	08-263100-00	LAND ROVER ROVER		08-176708-00	MERCEDES-BENZ
	08-263107-00	LAND ROVER ROVER		08-176711-00	MERCEDES-BENZ
	08-265100-10	LAND ROVER		08-103207-00	DEUTZ / KHD
	08-265107-10	LAND ROVER		08-252200-00	DEUTZ / KHD
	08-265109-10	LAND ROVER		08-252300-00	DEUTZ / KHD
	08-265111-10	LAND ROVER		08-252500-00	DEUTZ / KHD
	08-521800-20	LAND ROVER		08-252507-00	DEUTZ / KHD
	08-521807-20	LAND ROVER		08-321600-00	RENAULT
	08-521811-20	LAND ROVER		08-408800-00	PEUGEOT RENAULT VOLVO
	08-524200-00	AUSTIN MORRIS LAND ROVER		08-431700-00	HYUNDAI KIA
	08-524207-00	AUSTIN MORRIS LAND ROVER		08-431707-00	HYUNDAI KIA
		LAND ROVER		08-526800-00	TOYOTA
		LAND ROVER	91.10	08-287100-00	HYUNDAI
		LAND ROVER		08-287107-00	HYUNDAI
		LAND ROVER		08-287107-00	HYUNDAI
		LAND ROVER		08-287107-00	HYUNDAI
		LAND ROVER		08-287600-00	CHRYSLER
		LAND ROVER		08-288000-00	HYUNDAI

					
		mitsubishi			DAF
	08-288000-10	MITSUBISHI			PEUGEOT
	08-288007-10	MITSUBISHI		08-326307-00	CITROEN
	08-521200-00	HYUNDAI			DAF
		MITSUBISHI			PEUGEOT
	08-521207-00	HYUNDAI		08-373800-00	ISEKI
		MITSUBISHI			TOYOTA
	08-873400-00	MITSUBISHI			VOLKSWAGEN
	08-873407-00	MITSUBISHI			YANMAR
91.49	08-313100-00	PERKINS		08-373807-00	TOYOTA
	08-314600-00	FORD TRACTOR			VOLKSWAGEN
		PERKINS		08-398300-00	VOLGA
		URSUS		08-398307-00	VOLGA
	08-322000-00	PERKINS		08-399000-10	VOLVO
	08-525100-00	FORD TRACTOR		08-399007-10	VOLVO
		PERKINS		08-399600-10	NISSAN
		URSUS			PERKINS
92.00	08-109600-00	BMW		08-407600-10	VOLVO
	08-110100-00	ALFA ROMEO		08-407605-10	VOLVO
		CHRYSLER		08-407607-10	VOLVO
		FORD EUROPE		08-407611-10	VOLVO
		LAND ROVER		08-409400-00	VOLVO COMMERCIAL
		OPEL		08-423100-00	CHRYSLER
		ROVER			LDV
		UAZ			LTI
		VAUXHALL			VM
		VM		08-423200-00	VM
	08-112400-00	CITROEN		08-429200-00	LDV
		PEUGEOT			VM
	08-112407-00	CITROEN		08-432600-00	BMW
		PEUGEOT		08-434800-00	COMPRESSOR
	08-118900-00	CITROEN		08-741100-00	MERCEDES-BENZ
		PEUGEOT		08-744000-00	DAIHATSU
	08-118907-00	CITROEN		08-960500-00	SUBARU
		PEUGEOT	92.07	08-524000-00	JAGUAR
	08-124200-00	MERCEDES-BENZ		08-524007-00	JAGUAR
	08-133900-00	BMW	92.90	08-521100-00	NISSAN
	08-133907-00	BMW	93.00	08-138800-00	ALFA ROMEO
	08-134100-00	CHRYSLER			LANCIA
		JEEP		08-143000-00	VOLKSWAGEN
		VM		08-147300-10	CITROEN
	08-135800-00	CITROEN			PEUGEOT
		PEUGEOT			RENAULT
	08-135807-00	CITROEN			RENAULT TRUCKS
		PEUGEOT			TALBOT
	08-175000-00	DEUTZ / KHD		08-152700-00	CITROEN
	08-178500-10	MERCEDES-BENZ			FIAT
	08-182800-00	MERCEDES-BENZ			PEUGEOT
	08-275800-00	MALKOTSI			TALBOT
	08-287800-00	MERCEDES-BENZ		08-152707-00	CITROEN
	08-305400-10	BEDFORD			FIAT
		OPEL			PEUGEOT
		VAUXHALL			TALBOT
	08-305407-10	BEDFORD		08-152900-00	CITROEN
		OPEL			PEUGEOT
		VAUXHALL			TALBOT
	08-305411-10	BEDFORD		08-214400-10	CITROEN
		OPEL			FIAT
		VAUXHALL			IVECO
	08-306600-00	OPEL			PEUGEOT
		VAUXHALL			RENAULT
	08-306607-00	OPEL			RENAULT TRUCKS
		VAUXHALL			SEAT
	08-326300-00	CITROEN			TALBOT

CYLINDER BORE → GOETZE PART NO







Zylinderbohrung → Goetze Artikel-Nr. • Alésage de cylindre → Réf. Goetze
Diámetro del cilindro → Referencia Goetze







					
	08-214500-10	ALFA ROMEO		08-123721-00	FORD EUROPE
		FIAT		08-207300-10	FORD EUROPE
		IVECO		08-207311-10	FORD EUROPE
		RENAULT		08-207321-10	FORD EUROPE
		RENAULT TRUCKS		08-780100-00	FORD EUROPE
		SEAT		08-780111-00	FORD EUROPE
	08-214508-10	ALFA ROMEO		08-780121-00	FORD EUROPE
		FIAT		08-784800-00	FORD EUROPE
		IVECO		08-784811-00	FORD EUROPE
		RENAULT		08-784821-00	FORD EUROPE
		RENAULT TRUCKS	93.75	08-178900-10	MERCEDES-BENZ
		SEAT		08-178906-10	MERCEDES-BENZ
	08-214700-00	FORD EUROPE		08-178910-10	MERCEDES-BENZ
		RELIANT		08-178911-10	MERCEDES-BENZ
	08-245200-00	ALFA ROMEO	94.00	08-142100-00	DEUTZ / KHD
		FIAT		08-142107-00	DEUTZ / KHD
		IVECO		08-146500-00	DEUTZ / KHD
		LANCIA		08-146507-00	DEUTZ / KHD
		NEW HOLLAND		08-177400-00	COMPRESSOR
		RENAULT		08-177405-00	COMPRESSOR
	08-245208-00	ALFA ROMEO		08-177407-00	COMPRESSOR
		FIAT		08-252800-00	DEUTZ / KHD
		IVECO		08-252807-00	DEUTZ / KHD
		LANCIA		08-295100-00	NISSAN
		RENAULT		08-295200-00	NISSAN
	08-246200-00	ISUZU		08-318600-10	PORSCHE
	08-248000-00	ISUZU			VOLKSWAGEN
	08-248000-10	ISUZU		08-318700-10	ARO
	08-302600-00	OPEL			CITROEN
	08-398800-00	PORSCHE			DAF
		VOLKSWAGEN			FORD EUROPE
	08-425000-00	FIAT			LDV
		IVECO			PEUGEOT
		RENAULT			TALBOT
		RENAULT TRUCKS			UAZ
	08-425008-00	FIAT			VOLGA
		IVECO		08-318704-10	ARO
		RENAULT			CITROEN
		RENAULT TRUCKS			DAF
	08-431200-00	PORSCHE			FORD EUROPE
	08-520200-00	FIAT			LDV
		IVECO			PEUGEOT
		RENAULT			TALBOT
		RENAULT TRUCKS			UAZ
	08-527500-00	ALFA ROMEO			VOLGA
		LANCIA		08-318706-10	ARO
	08-782500-00	FORD EUROPE			CITROEN
	08-783300-00	ALFA ROMEO			DAF
		FIAT			FORD EUROPE
		IVECO			LDV
		OPEL			PEUGEOT
		RENAULT			TALBOT
		VAUXHALL			UAZ
	08-783308-00	ALFA ROMEO			VOLGA
		FIAT		08-318707-10	ARO
		IVECO			CITROEN
		OPEL			DAF
		RENAULT			FORD EUROPE
		VAUXHALL			LDV
93.40	08-133300-10	BMW			PEUGEOT
	08-700100-00	BMW			TALBOT
	08-704400-00	BMW			UAZ
93.67	08-123700-00	FORD EUROPE			VOLGA
	08-123711-00	FORD EUROPE		08-318708-10	ARO

					
		CITROEN		08-700905-00	BMW MOTORCYCLE
		DAF		08-701000-00	BMW MOTORCYCLE
		FORD EUROPE		08-990000-00	VOLKSWAGEN
		LDV	94.40	08-108200-00	CITROEN
		PEUGEOT			FIAT
		TALBOT			IVECO
		UAZ			PEUGEOT
		VOLGA			RENAULT TRUCKS
08-318710-10		ARO		08-108208-00	CITROEN
		CITROEN			FIAT
		DAF			IVECO
		FORD EUROPE			PEUGEOT
		LDV			RENAULT TRUCKS
		PEUGEOT		08-122200-00	CITROEN
		TALBOT			FIAT
		UAZ			IVECO
		VOLGA			OPEL
08-318711-10		ARO			PEUGEOT
		DAF			RENAULT
		FORD EUROPE			RENAULT TRUCKS
		LDV			VAUXHALL
		PEUGEOT		08-122208-00	CITROEN
		TALBOT			FIAT
08-320200-10		DAF			IVECO
		FORD EUROPE			OPEL
		LDV			PEUGEOT
		PEUGEOT			RENAULT
		SSANGYONG			RENAULT TRUCKS
		TALBOT			VAUXHALL
08-320204-10		DAF		08-854700-00	FIAT
		FORD EUROPE			IVECO
		LDV			OPEL
		PEUGEOT			RENAULT
		SSANGYONG			RENAULT TRUCKS
		TALBOT			VAUXHALL
08-320206-10		DAF		08-854708-00	FIAT
		FORD EUROPE			IVECO
		LDV			OPEL
		PEUGEOT			RENAULT
		SSANGYONG			RENAULT TRUCKS
		TALBOT			VAUXHALL
08-320208-10		DAF	94.50	08-431800-00	KIA
		FORD EUROPE		08-431807-00	KIA
		LDV	95.00	08-164400-00	DEUTZ / KHD
		PEUGEOT		08-164407-00	DEUTZ / KHD
		SSANGYONG		08-164411-00	DEUTZ / KHD
		TALBOT		08-166400-00	DEUTZ / KHD
08-320211-10		DAF		08-166407-00	DEUTZ / KHD
		FORD EUROPE		08-166411-00	DEUTZ / KHD
		LDV		08-207200-00	IVECO
		PEUGEOT			NEW HOLLAND
		SSANGYONG			UTB
		TALBOT		08-207208-00	IVECO
08-399100-00		PORSCHE			NEW HOLLAND
		VOLKSWAGEN			UTB
08-399105-00		PORSCHE		08-253400-00	KOMATSU
		VOLKSWAGEN		08-267500-00	LOMBARDINI
08-399107-00		PORSCHE		08-267507-00	LOMBARDINI
		VOLKSWAGEN		08-267511-00	LOMBARDINI
08-399111-00		PORSCHE		08-278000-00	MWM
		VOLKSWAGEN		08-305000-00	BEDFORD
08-521500-00		LAND ROVER			OPEL
08-524500-00		LAND ROVER			VAUXHALL
08-700900-00		BMW MOTORCYCLE		08-305007-00	BEDFORD

CYLINDER BORE → GOETZE PART NO







Zylinderbohrung → Goetze Artikel-Nr. • Alésage de cylindre → Réf. Goetze
 Diámetro del cilindro → Referencia Goetze







					
		OPEL		08-740000-00	MERCEDES-BENZ COMMERCIAL
		VAUXHALL		08-740007-00	MERCEDES-BENZ COMMERCIAL
	08-306500-00	OPEL	98.00	08-127800-00	DEUTZ / KHD
	08-307300-00	OPEL		08-273800-00	MWM
		VAUXHALL		08-525300-00	LEYLAND
	08-307307-00	OPEL		08-526200-00	LEYLAND
		VAUXHALL		08-703400-00	LEYLAND
	08-319900-10	PORSCHE	98.42	08-243300-00	IHC
	08-320000-10	PORSCHE		08-243600-00	IHC
	08-320900-10	PORSCHE	98.43	08-142500-00	VOLVO COMMERCIAL
	08-321700-00	PORSCHE		08-405500-10	VOLVO COMMERCIAL
	08-343700-00	ZETOR			VOLVO-PENTA
	08-526300-00	HINO	98.48	08-101000-00	LEYLAND
		TOYOTA			PERKINS
95.25	08-399400-10	VOLVO COMMERCIAL		08-107200-00	PERKINS
	08-523800-00	LISTER			VOLVO COMMERCIAL
	08-523807-00	LISTER		08-107209-00	PERKINS
	08-523811-00	LISTER			VOLVO COMMERCIAL
95.50	08-179700-00	MERCEDES-BENZ		08-315000-10	LEYLAND
	08-179707-00	MERCEDES-BENZ			PERKINS
	08-179711-00	MERCEDES-BENZ		08-315007-10	PERKINS
	08-182400-10	MERCEDES-BENZ		08-318900-10	LEYLAND
	08-289700-00	MERCEDES-BENZ			PERKINS
95.80	08-421600-00	IVECO			URSUS
96.00	08-111200-00	NISSAN			VOLVO COMMERCIAL
	08-407700-10	VOLVO		08-318905-10	LEYLAND
	08-407708-10	VOLVO			PERKINS
	08-407722-10	VOLVO			URSUS
	08-408100-00	VOLVO			VOLVO COMMERCIAL
	08-408108-00	VOLVO		08-319000-10	PERKINS
	08-408200-00	VOLVO		08-319005-10	PERKINS
	08-422400-00	TOYOTA		08-322100-00	LEYLAND
	08-422407-00	TOYOTA			PERKINS
	08-428200-00	PORSCHE		08-325000-00	PERKINS
	08-428500-00	PORSCHE		08-525200-00	LEYLAND
	08-431400-00	PORSCHE			PERKINS
	08-436200-00	NISSAN		08-525209-00	LEYLAND
	08-441000-00	PORSCHE			PERKINS
	08-528800-00	TOYOTA	100.00	08-101700-00	PERKINS
	08-528807-00	TOYOTA		08-106900-00	IVECO
96.50	08-182700-00	MERCEDES-BENZ			NEW HOLLAND
	08-182707-00	MERCEDES-BENZ		08-111900-00	KIA
	08-182711-00	MERCEDES-BENZ			MAZDA
97.00	08-106300-00	MERCEDES-BENZ		08-112500-00	PORSCHE
	08-174300-10	MERCEDES-BENZ COMMERCIAL		08-115700-00	PORSCHE
	08-174300-70	MERCEDES-BENZ COMMERCIAL		08-121700-00	COMPRESSOR
	08-174305-10	MERCEDES-BENZ COMMERCIAL		08-122100-00	DEUTZ / KHD
	08-174305-70	MERCEDES-BENZ COMMERCIAL		08-140500-00	COMPRESSOR
	08-174307-10	MERCEDES-BENZ COMMERCIAL		08-140507-00	COMPRESSOR
	08-174307-70	MERCEDES-BENZ COMMERCIAL		08-172500-00	DEUTZ / KHD
	08-174309-10	MERCEDES-BENZ COMMERCIAL		08-172507-00	DEUTZ / KHD
	08-174311-10	MERCEDES-BENZ COMMERCIAL		08-172511-00	DEUTZ / KHD
	08-174311-70	MERCEDES-BENZ COMMERCIAL		08-179400-00	DEUTZ / KHD
	08-174314-10	MERCEDES-BENZ COMMERCIAL		08-179407-00	DEUTZ / KHD
	08-178200-00	MERCEDES-BENZ COMMERCIAL		08-179411-00	DEUTZ / KHD
	08-178207-00	MERCEDES-BENZ COMMERCIAL		08-203500-10	FORD COMMERCIAL
	08-178211-00	MERCEDES-BENZ COMMERCIAL			FORD TRACTOR
	08-178800-00	MERCEDES-BENZ COMMERCIAL		08-206800-00	IVECO
	08-178807-00	MERCEDES-BENZ COMMERCIAL			NEW HOLLAND
	08-178811-00	MERCEDES-BENZ COMMERCIAL		08-206800-40	IVECO
	08-320300-10	PORSCHE			NEW HOLLAND
	08-321200-00	PORSCHE		08-206808-00	IVECO
97.50	08-288800-00	MERCEDES-BENZ COMMERCIAL			NEW HOLLAND
	08-288807-00	MERCEDES-BENZ COMMERCIAL		08-206808-40	IVECO

					
		NEW HOLLAND		08-178400-10	DEUTZ / KHD
	08-243400-00	IHC		08-178407-10	DEUTZ / KHD
	08-244800-00	IHC		08-181800-00	JOHN DEERE
	08-267600-00	LOMBARDINI		08-252600-00	DEUTZ / KHD
	08-267607-00	LOMBARDINI		08-267700-00	LOMBARDINI
	08-267611-00	LOMBARDINI		08-267707-00	LOMBARDINI
	08-273400-10	MAN		08-267711-00	LOMBARDINI
	08-279400-00	MWM		08-281500-00	MWM
	08-288200-00	HYUNDAI		08-281511-00	MWM
		ISEKI		08-283300-00	MAN
		MITSUBISHI		08-289300-00	MERCEDES-BENZ COMMERCIAL
		YANMAR		08-289300-30	MERCEDES-BENZ COMMERCIAL
	08-291900-10	LEYLAND		08-325900-00	PORSCHE
		NUFFIELD TRACTOR		08-335800-00	RENAULT TRUCKS
	08-320400-10	PORSCHE		08-346500-10	RENAULT TRUCKS
	08-323300-00	PORSCHE		08-347900-10	RENAULT TRUCKS
	08-324300-00	PERKINS		08-348300-00	ZETOR
	08-325100-00	PORSCHE		08-374000-00	HINO
	08-325600-00	PERKINS			TOYOTA
	08-326100-00	PORSCHE		08-427900-00	IVECO
	08-326200-00	PORSCHE		08-435000-00	RENAULT TRUCKS
	08-347200-00	ZETOR		08-522500-00	ISUZU
	08-361900-00	STEYR		08-522900-00	RENAULT TRUCKS
	08-362000-00	STEYR		08-740900-00	DEUTZ / KHD
	08-422100-00	PERKINS		08-740907-00	DEUTZ / KHD
	08-425100-00	PORSCHE		08-742100-00	CUMMINS
	08-520400-00	HYUNDAI			DAF
		MITSUBISHI		08-744100-00	DEUTZ / KHD
	08-741800-00	DEUTZ / KHD		08-744107-00	DEUTZ / KHD
	08-741807-00	DEUTZ / KHD		08-744700-00	DEUTZ / KHD
	08-741811-00	DEUTZ / KHD		08-744707-00	DEUTZ / KHD
	08-744600-00	DEUTZ / KHD	102.70	08-439200-00	PORSCHE
	08-744607-00	DEUTZ / KHD	103.00	08-425400-00	PERKINS
	08-744611-00	DEUTZ / KHD		08-425407-00	PERKINS
	08-781900-00	IVECO		08-425411-00	PERKINS
		NEW HOLLAND		08-782000-00	IVECO
	08-781908-00	IVECO			NEW HOLLAND
		NEW HOLLAND		08-782008-00	IVECO
100.04	08-520600-00	DAVID BROWN			NEW HOLLAND
	08-520607-00	DAVID BROWN		08-783900-00	IVECO
	08-520611-00	DAVID BROWN			NEW HOLLAND
100.62	08-164500-10	DAF	103.19	08-126300-10	BEDFORD
101.00	08-127900-00	DEUTZ / KHD		08-126305-10	BEDFORD
101.05	08-318000-10	PERKINS		08-126307-10	BEDFORD
101.054	08-318000-10	PERKINS		08-126309-10	BEDFORD
	08-322700-00	PERKINS		08-126311-10	BEDFORD
102.00	08-125700-00	PORSCHE		08-126314-10	BEDFORD
	08-134000-00	UTB	104.00	08-103900-00	IVECO
	08-135000-00	DEUTZ / KHD		08-103906-00	IVECO
	08-138700-00	DEUTZ / KHD		08-103908-00	IVECO
	08-145000-00	CUMMINS		08-103910-00	IVECO
		DAF		08-244500-00	IVECO
		IVECO			NEW HOLLAND
	08-145007-00	CUMMINS		08-247800-00	IVECO
		DAF			NEW HOLLAND
		IVECO		08-247808-00	IVECO
	08-145008-00	CUMMINS			NEW HOLLAND
		DAF		08-288300-00	MITSUBISHI
		IVECO		08-288307-00	MITSUBISHI
	08-146300-00	MERCEDES-BENZ COMMERCIAL		08-324500-00	PORSCHE
	08-146300-10	MERCEDES-BENZ COMMERCIAL		08-432700-00	IVECO
	08-155200-00	CUMMINS		08-784700-00	IVECO
	08-174600-10	DEUTZ / KHD	104.18	08-179000-10	DAF
	08-174607-10	DEUTZ / KHD		08-741600-00	DAF

CYLINDER BORE → GOETZE PART NO







Zylinderbohrung → Goetze Artikel-Nr. • Alésage de cylindre → Réf. Goetze
Diámetro del cilindro → Referencia Goetze

					
104.77	08-202800-00	FORD COMMERCIAL			RENAULT TRUCKS
	08-202807-00	FORD COMMERCIAL			VOLVO COMMERCIAL
	08-202809-00	FORD COMMERCIAL		08-431600-00	MAN
	08-202811-00	FORD COMMERCIAL		08-522100-00	LISTER
	08-520900-00	FORD COMMERCIAL		08-522107-00	LISTER
	08-523500-00	FORD COMMERCIAL		08-528100-00	IVECO
	08-782800-00	FORD COMMERCIAL			NEW HOLLAND
104.775	08-142800-00	VOLVO COMMERCIAL	109.23	08-244600-00	IHC
	08-392000-10	VOLVO COMMERCIAL	110.00	08-130200-00	BELARUS
		VOLVO-PENTA		08-160800-00	DEUTZ / KHD
	08-392005-10	VOLVO COMMERCIAL		08-160807-00	DEUTZ / KHD
		VOLVO-PENTA		08-160811-00	DEUTZ / KHD
	08-407000-10	VOLVO COMMERCIAL		08-160814-00	DEUTZ / KHD
	08-501400-00	VOLVO COMMERCIAL		08-207500-00	IVECO
	08-502700-00	VOLVO COMMERCIAL			NEW HOLLAND
105.00	08-117700-00	KOMATSU	111.00	08-961700-00	MAN
	08-278100-00	MWM	111.12	08-125300-00	VOLVO COMMERCIAL
	08-279600-00	MWM	111.77	08-100100-00	FORD TRACTOR
	08-426200-00	PERKINS		08-100107-00	FORD TRACTOR
	08-523200-00	SAME		08-100109-00	FORD TRACTOR
	08-523300-00	SAME		08-100111-00	FORD TRACTOR
	08-523307-00	SAME		08-202400-10	FORD COMMERCIAL
105.57	08-990600-00	VOLVO COMMERCIAL			FORD TRACTOR
106.00	08-127700-00	MERCEDES-BENZ COMMERCIAL			PERKINS
	08-146400-00	MERCEDES-BENZ COMMERCIAL		08-202407-10	FORD COMMERCIAL
106.50	08-181100-00	JOHN DEERE			FORD TRACTOR
106.69	08-208100-00	FORD COMMERCIAL			PERKINS
		FORD TRACTOR		08-202409-10	FORD COMMERCIAL
	08-208107-00	FORD COMMERCIAL			FORD TRACTOR
		FORD TRACTOR			PERKINS
	08-208109-00	FORD COMMERCIAL		08-521300-00	NEW HOLLAND
		FORD TRACTOR		08-521307-00	NEW HOLLAND
	08-208111-00	FORD COMMERCIAL		08-521400-00	NEW HOLLAND
		FORD TRACTOR		08-521407-00	NEW HOLLAND
107.00	08-141900-00	VOLVO COMMERCIAL	112.00	08-142900-00	IVECO
107.18	08-782900-00	FORD COMMERCIAL		08-285500-00	MAN
	08-782906-00	FORD COMMERCIAL		08-285505-00	MAN
	08-782910-00	FORD COMMERCIAL		08-781600-00	FAP-FAMOS
107.19	08-318400-00	PEGASO	114.00	08-155600-10	CUMMINS
107.21	08-214800-10	FORD COMMERCIAL	114.30	08-322300-00	PERKINS
		FORD TRACTOR	115.00	08-109200-00	SCANIA
	08-214807-10	FORD COMMERCIAL		08-121800-00	IVECO
		FORD TRACTOR		08-167700-00	DEUTZ / KHD
	08-214809-10	FORD COMMERCIAL		08-171600-10	MERCEDES-BENZ COMMERCIAL
		FORD TRACTOR		08-171607-10	MERCEDES-BENZ COMMERCIAL
	08-214811-10	FORD COMMERCIAL		08-171611-10	MERCEDES-BENZ COMMERCIAL
		FORD TRACTOR		08-171614-10	MERCEDES-BENZ COMMERCIAL
107.22	08-523400-00	LEYLAND		08-176400-10	MERCEDES-BENZ COMMERCIAL
	08-525600-00	LEYLAND		08-176400-30	MERCEDES-BENZ COMMERCIAL
108.00	08-123800-00	DEUTZ / KHD		08-176407-10	MERCEDES-BENZ COMMERCIAL
	08-136500-00	MAN		08-176407-30	MERCEDES-BENZ COMMERCIAL
	08-136500-10	MAN		08-176411-10	MERCEDES-BENZ COMMERCIAL
	08-136500-30	MAN		08-176411-30	MERCEDES-BENZ COMMERCIAL
	08-136900-00	DEUTZ / KHD		08-176414-10	MERCEDES-BENZ COMMERCIAL
	08-274100-10	MAN		08-176414-30	MERCEDES-BENZ COMMERCIAL
	08-275000-10	MAN		08-214900-10	DEUTZ / KHD
	08-280000-10	MAN			IVECO
	08-285800-00	MAN			NEW HOLLAND
	08-285900-00	MAN		08-245500-00	IVECO
	08-381100-00	UTB			NEW HOLLAND
	08-381111-00	UTB		08-343500-10	SCANIA
	08-425900-00	MAN		08-431100-00	IVECO
	08-429100-00	MAN		08-523000-00	DEUTZ / KHD
	08-430000-00	DEUTZ / KHD			IVECO









					
		NEW HOLLAND	124.00	08-429600-00	RENAULT TRUCKS
	08-524700-00	IVECO	125.00	08-121900-00	IVECO
		NEW HOLLAND		08-172700-00	MERCEDES-BENZ COMMERCIAL
	08-528000-00	IVECO		08-176000-00	MERCEDES-BENZ COMMERCIAL
		NEW HOLLAND		08-176000-20	MERCEDES-BENZ COMMERCIAL
	08-960900-00	SCANIA		08-176800-10	MERCEDES-BENZ COMMERCIAL
	08-961000-00	SCANIA		08-176800-20	MERCEDES-BENZ COMMERCIAL
115.88	08-526500-00	BEDFORD		08-176807-20	MERCEDES-BENZ COMMERCIAL
117.00	08-428800-00	IVECO		08-181000-00	MERCEDES-BENZ COMMERCIAL
117.47	08-520800-00	CUMMINS		08-279200-10	MAN
118.00	08-121600-00	DAF		08-280200-00	MAN
	08-140200-00	DAF		08-280400-10	MAN
	08-182500-10	DAF		08-282400-10	MAN
	08-318500-00	PEGASO			PEGASO
120.00	08-125800-00	RENAULT TRUCKS		08-434100-00	IVECO
	08-131500-10	RENAULT TRUCKS		08-440400-00	DEUTZ / KHD
	08-132000-10	RENAULT TRUCKS			IVECO
	08-142000-00	VOLVO COMMERCIAL		08-440407-00	DEUTZ / KHD
	08-167600-10	DEUTZ / KHD			IVECO
	08-167607-10	DEUTZ / KHD		08-440411-00	DEUTZ / KHD
	08-167611-10	DEUTZ / KHD			IVECO
	08-172800-10	DEUTZ / KHD		08-520700-00	NISSAN
	08-172900-10	DEUTZ / KHD		08-527700-00	IVECO
	08-177800-00	DEUTZ / KHD			NEW HOLLAND
	08-245300-00	IFA		08-527900-00	IVECO
	08-245311-00	IFA		08-528200-00	IVECO
	08-246900-00	IFA		08-740300-00	DEUTZ / KHD
	08-246907-00	IFA		08-740307-00	DEUTZ / KHD
	08-246911-00	IFA		08-740311-00	DEUTZ / KHD
	08-280500-00	MWM		08-740500-00	DEUTZ / KHD
	08-323700-00	PEGASO		08-743500-00	DEUTZ / KHD
	08-337500-00	RENAULT TRUCKS		08-781000-00	IVECO
	08-423000-00	MAN		08-781800-00	FAP-FAMOS
	08-428600-00	MAN	126.00	08-362100-10	STEYR
	08-451000-00	IVECO		08-362200-10	STEYR
	08-785300-00	IVECO		08-431000-00	MAN
		NEW HOLLAND	127.00	08-103700-00	JELCZ
120.01	08-438900-00	VOLVO COMMERCIAL		08-112100-00	SCANIA
120.65	08-136800-00	VOLVO COMMERCIAL		08-121100-00	SCANIA
	08-396300-10	VOLVO COMMERCIAL		08-121200-00	SCANIA
		VOLVO-PENTA		08-143600-00	SCANIA
	08-396305-10	VOLVO COMMERCIAL		08-143600-10	SCANIA
		VOLVO-PENTA		08-347100-10	SCANIA
	08-407100-10	VOLVO COMMERCIAL		08-348000-10	SCANIA
	08-407100-20	VOLVO COMMERCIAL		08-437600-00	SCANIA
	08-407105-10	VOLVO COMMERCIAL		08-526900-00	SCANIA
	08-431300-00	VOLVO COMMERCIAL		08-960800-00	SCANIA
	08-500500-00	VOLVO COMMERCIAL		08-961900-00	SCANIA
	08-501600-00	VOLVO COMMERCIAL		08-962000-00	SCANIA
	08-502600-00	VOLVO COMMERCIAL		08-962100-00	SCANIA
	08-522000-00	GARDNER		08-990500-00	SCANIA
	08-522009-00	GARDNER	128.00	08-104300-00	MAN
121.00	08-274200-10	MAN		08-104300-20	MAN
		RABA UNGARN		08-115800-00	MERCEDES-BENZ COMMERCIAL
	08-274207-10	RABA UNGARN		08-124500-00	MAN
	08-274800-10	MAN		08-134800-00	DAEWOO
	08-337600-00	RABA UNGARN		08-141800-00	MERCEDES-BENZ COMMERCIAL
122.00	08-207700-00	IVECO		08-143800-00	MAN
123.00	08-135500-00	RENAULT TRUCKS		08-171200-10	MERCEDES-BENZ COMMERCIAL
	08-135500-10	RENAULT TRUCKS		08-176900-10	MERCEDES-BENZ COMMERCIAL
	08-438800-00	RENAULT TRUCKS		08-176900-80	MERCEDES-BENZ COMMERCIAL
		VOLVO COMMERCIAL		08-176907-10	MERCEDES-BENZ COMMERCIAL
	08-781500-00	FAP-FAMOS		08-176907-80	MERCEDES-BENZ COMMERCIAL
	08-961600-00	MAN		08-176911-10	MERCEDES-BENZ COMMERCIAL

CYLINDER BORE → GOETZE PART NO

Zylinderbohrung → Goetze Artikel-Nr. • Alésage de cylindre → Réf. Goetze
Diámetro del cilindro → Referencia Goetze









					
	08-176911-80	MERCEDES-BENZ COMMERCIAL		08-335900-00	RENAULT TRUCKS
	08-176914-10	MERCEDES-BENZ COMMERCIAL		08-428000-00	IVECO
	08-178300-00	MERCEDES-BENZ COMMERCIAL		08-702300-00	RENAULT TRUCKS
	08-179300-10	MERCEDES-BENZ COMMERCIAL	137.00	08-207800-10	IVECO
	08-179300-20	MERCEDES-BENZ COMMERCIAL			NEW HOLLAND
	08-181700-00	MERCEDES-BENZ COMMERCIAL		08-207800-30	IVECO
	08-181700-20	MERCEDES-BENZ COMMERCIAL			NEW HOLLAND
	08-282200-10	MAN		08-783000-00	IVECO
	08-283100-00	MAN	142.00	08-251300-10	BARRERAS
	08-283100-30	MAN			DEUTZ / KHD
	08-285600-00	MWM	144.00	08-101100-00	VOLVO COMMERCIAL
	08-289400-00	MAN		08-500300-00	VOLVO COMMERCIAL
	08-420000-00	MERCEDES-BENZ COMMERCIAL		08-502500-00	VOLVO COMMERCIAL
	08-425800-00	MAN	145.00	08-782100-00	IVECO
	08-427000-00	MERCEDES-BENZ COMMERCIAL			
	08-432800-00	MAN			
	08-433800-00	MAN			
	08-740400-00	DEUTZ / KHD			
	08-742300-00	MERCEDES-BENZ COMMERCIAL			
	08-742300-20	MERCEDES-BENZ COMMERCIAL			
130.00	08-111100-00	mitsubishi			
	08-111600-00	mitsubishi			
	08-112300-00	mitsubishi			
	08-136000-00	MERCEDES-BENZ COMMERCIAL			
	08-137100-00	MERCEDES-BENZ COMMERCIAL			
	08-145900-00	MERCEDES-BENZ COMMERCIAL			
	08-174100-10	DAF			
		LEYLAND			
	08-289000-00	MAZ			
	08-289100-00	MAZ			
	08-289600-00	MERCEDES-BENZ COMMERCIAL			
	08-319300-10	PEGASO			
	08-323800-00	PEGASO			
	08-324400-00	PEGASO			
	08-420100-00	IVECO			
	08-420108-00	IVECO			
	08-420200-00	IVECO			
	08-420208-00	IVECO			
	08-420900-00	MERCEDES-BENZ COMMERCIAL			
	08-432500-00	DAF			
	08-433300-00	DAF			
	08-437500-00	DAF			
	08-521000-00	LEYLAND			
	08-742300-00	MERCEDES-BENZ COMMERCIAL			
	08-742300-20	MERCEDES-BENZ COMMERCIAL			
	08-743200-00	MERCEDES-BENZ COMMERCIAL			
	08-743400-00	DAF			
130.175	08-405600-10	VOLVO COMMERCIAL			
		VOLVO-PENTA			
	08-405600-20	VOLVO COMMERCIAL			
		VOLVO-PENTA			
	08-501300-00	VOLVO COMMERCIAL			
131.00	08-123200-00	VOLVO COMMERCIAL			
	08-434400-00	RENAULT TRUCKS			
		VOLVO COMMERCIAL			
132.00	08-123900-00	DEUTZ / KHD			
	08-123900-10	DEUTZ / KHD			
	08-440600-00	MERCEDES-BENZ COMMERCIAL			
135.00	08-122000-00	IVECO			
	08-122008-00	IVECO			
	08-132100-10	RENAULT TRUCKS			
	08-132200-10	RENAULT TRUCKS			
	08-172600-00	DEUTZ / KHD			
	08-335300-00	RENAULT TRUCKS			

Lista zamienników z numerów AE na Goetze **INTERCHANGE AE → GOETZE**
 Взаимозаменяемость AE → Goetze ← AE تبادل

 ref	New  Rings ref	*	 ref	New  Rings ref	*	 ref	New  Rings ref	*	 ref	New  Rings ref	*
R47200 0.60MM	08-247808-00	1	R48280STD	08-528700-00	1	R49750 STD	08-102200-00	4	R60210 STD	08-154600-00	4
R47200 STD	08-247800-00	1	R48290 0.50MM	08-524807-00	1	R49760 0.50MM	08-102307-00	4	R60220 0.25MM	08-114405-00	4
R47210 STD	08-244500-00	1	R48290 1.00MM	08-524811-00	1	R49760 STD	08-102300-00	4	R60220 STD	08-114400-00	4
R47220 STD	08-783000-00	6	R48290 STD	08-524800-00	1	R49770 0.50MM	08-141307-00	4	R60230 0.60MM	08-104008-00	4
R47230 STD	08-785300-00	6	R48380 0.50MM	08-307807-00	4	R49770 STD	08-141300-00	4	R60230 STD	08-104000-00	4
R47250 0.60MM	08-425008-00	4	R48380 STD	08-307800-00	4	R49790 0.50MM	08-107307-00	4	R60240 0.50MM	08-104207-00	4
R47250 STD	08-425000-00	4	R48400 0.50MM	08-307607-00	4	R49790 STD	08-107300-00	4	R60240 STD	08-104200-00	4
R47260 0.40MM	08-269706-00	4	R48400 STD	08-307600-00	4	R49820 0.50MM	08-107607-00	4	R60250 0.50MM	08-106807-00	4
R47260 STD	08-269700-00	4	R48450 .020	08-521307-00	1	R49820 STD	08-107600-00	4	R60250 STD	08-106800-00	4
R47270 0.40MM	08-269806-00	4	R48450 STD	08-521300-00	1	R49830 0.50MM	08-102807-00	4	R60260 0.50MM	08-101507-00	4
R47270 STD	08-269800-00	4	R48460 .020	08-521407-00	1	R49830 STD	08-102800-00	4	R60260 STD	08-101500-00	4
R47310 0.50MM	08-267607-00	1	R48460 STD	08-521400-00	1	R49840 0.50MM	08-102907-00	4	R60270 0.50MM	08-105107-00	4
R47310 1.00MM	08-267611-00	1	R48480 0.40MM	08-142306-00	4	R49840 STD	08-102900-00	4	R60270 STD	08-105100-00	4
R47310 STD	08-267600-00	1	R48480 0.60MM	08-142308-00	4	R49850 0.60MM	08-107908-00	1	R60280 0.50MM	08-502807-00	4
R47330 0.50MM	08-267407-00	1	R48480 STD	08-142300-00	4	R49850 STD	08-107900-00	1	R60280 STD	08-502800-00	4
R47330 1.00MM	08-267411-00	1	R48500 0.60MM	08-103908-00	1	R49860 0.60MM	08-523108-00	1	R60290 0.50MM	08-105907-00	4
R47330 STD	08-267400-00	1	R48500 STD	08-103900-00	1	R49860 STD	08-523100-00	1	R60290 STD	08-105900-00	4
R47460 STD	08-207500-00	1	R48510 STD	08-960100-00	1	R49870 0.60MM	08-108008-00	1	R60300 0.50MM	08-501907-00	6
R47470 STD	08-207500-00	1	R48560 STD	08-783000-00	1	R49870 STD	08-108000-00	1	R60300 STD	08-501900-00	6
R47490 STD	08-528000-00	1	R48590 0.40MM	08-787006-00	1	R49900 0.50MM	08-704507-00	1	R60310 0.50MM	08-501807-00	4
R47500 STD	08-528100-00	4	R48590 STD	08-787000-00	1	R49900 STD	08-704500-00	1	R60310 STD	08-501800-00	4
R47510 STD	08-523300-00	1	R48660 0.50MM	08-528807-00	4	R49910 0.50MM	08-323607-00	4	R60320 STD	08-502900-00	4
R47520 STD	08-524700-00	1	R48660 STD	08-528800-00	4	R49910 STD	08-323600-00	4	R60330 0.50MM	08-501507-00	5
R47530 STD	08-214900-10	1	R48700 STD	08-782100-00	2	R49920 0.50MM	08-325507-00	4	R60330 STD	08-501500-00	5
R47550 STD	08-245500-00	1	R48730 .020	08-521807-20	1	R49920 STD	08-325500-00	4	R60340 STD	08-176000-00	1
R47650 0.50MM	08-523307-00	1	R48730 .040	08-521811-20	1	R49960 0.40MM	08-325806-00	4	R60350 STD	08-289600-00	1
R47650 STD	08-523300-00	1	R48730 STD	08-521800-20	1	R49960 STD	08-325800-00	4	R60360 STD	08-289300-00	1
R47680 STD	08-523200-00	1	R48750 0.50MM	08-306707-00	4	R49970 0.50MM	08-787006-00	4	R60370 0.50MM	08-114907-00	4
R47700 STD	08-528200-00	6	R48750 STD	08-306700-00	4	R49970 STD	08-787000-00	4	R60370 STD	08-114900-00	4
R47710 STD	08-110000-00	1	R48830 STD	08-325600-00	1	R49990 0.50MM	08-102707-00	1	R60380 STD	08-783000-00	1
R47730 STD	08-110100-00	1	R49310 0.50MM	08-529007-00	1	R49990 STD	08-102700-00	1	R60390 STD	08-101600-00	4
R47750 0.40MM	08-203106-00	4	R49310 STD	08-529000-00	1	R60000 0.40MM	08-118006-00	4	R60400 STD	08-117900-00	1
R47750 0.60MM	08-203108-00	4	R49350 STD	08-520200-00	4	R60000 STD	08-118000-00	4	R60410 0.60MM	08-114708-00	4
R47750 1.00MM	08-203111-00	4	R49360 STD	08-244500-00	1	R60020 0.40MM	08-110906-00	4	R60410 STD	08-114700-00	4
R47750 STD	08-203100-00	4	R49390 0.50MM	08-119807-00	1	R60020 STD	08-110900-00	4	R60440 0.50MM	08-112707-00	4
R47760 0.40MM	08-528306-00	2	R49390 STD	08-119800-00	1	R60030 0.40MM	08-142406-00	4	R60440 STD	08-112700-00	4
R47760 STD	08-528300-00	2	R49420 STD	08-529100-00	4	R60030 STD	08-142400-00	4	R60450 0.50MM	08-118907-00	4
R47770 0.40MM	08-528406-00	2	R49430 0.50MM	08-306807-00	4	R60060 0.60MM	08-108208-00	4	R60450 STD	08-118900-00	4
R47770 0.60MM	08-528408-00	2	R49430 STD	08-306800-00	4	R60060 STD	08-108200-00	4	R60460 STD	08-337300-00	4
R47770 STD	08-528400-00	2	R49500 STD	08-521500-00	8	R60070 0.60MM	08-122208-00	4	R60470 0.40MM	08-118006-00	1
R47780 0.40MM	08-209706-00	4	R49520 0.65MM	08-123721-00	4	R60070 STD	08-122200-00	4	R60470 STD	08-118000-00	1
R47780 0.60MM	08-209708-00	4	R49520 1.00MM	08-123711-00	4	R60080 0.50MM	08-107007-00	4	R60490 STD	08-109200-00	1
R47830 STD	08-528500-00	4	R49520 STD	08-123700-00	4	R60080 1.00MM	08-107011-00	4	R60500 0.50MM	08-111807-00	4
R47970 STD	08-142400-00	4	R49540 STD	08-522700-00	4	R60080 STD	08-107000-00	4	R60500 STD	08-111800-00	4
R47990 0.50MM	08-784207-00	4	R49590 0.50MM	08-307507-00	4	R60090 0.50MM	08-113507-00	4	R60510 0.25MM	08-104105-00	1
R47990 STD	08-784200-00	4	R49590 STD	08-307500-00	4	R60090 1.00MM	08-113511-00	4	R60510 STD	08-104100-00	1
R48000 0.50MM	08-109707-00	1	R49600 0.50MM	08-307707-00	1	R60090 STD	08-113500-00	4	R60520 0.50MM	08-120107-00	3
R48000 STD	08-109700-00	1	R49600 STD	08-307700-00	1	R60100 0.40MM	08-786806-00	4	R60520 STD	08-120100-00	3
R48010 0.50MM	08-502207-00	1	R49610 0.50MM	08-307307-00	4	R60100 STD	08-786800-00	4	R60550 0.60MM	08-154908-00	4
R48010 STD	08-502200-00	1	R49610 STD	08-307300-00	4	R60120 STD	08-121800-00	1	R60550 STD	08-154900-00	4
R48040 STD	08-743600-00	1	R49630 0.20MM	08-529204-00	1	R60130 0.40MM	08-529306-00	5	R60570 0.50MM	08-125607-00	4
R48050 0.50MM	08-181407-10	1	R49630 0.50MM	08-529207-00	1	R60130 STD	08-529300-00	5	R60570 STD	08-125600-00	4
R48050 STD	08-181400-10	1	R49630 STD	08-529200-00	1	R60140 0.50MM	08-105507-00	4	R60580 0.60MM	08-124008-00	4
R48060 0.40MM	08-203106-00	2	R49640 0.50MM	08-306807-00	4	R60140 0.80MM	08-105510-00	4	R60580 STD	08-124000-00	4
R48060 0.60MM	08-203108-00	2	R49640 1.00MM	08-306811-00	4	R60140 STD	08-105500-00	4	R60590 0.40MM	08-124806-00	4
R48060 STD	08-203100-00	2	R49640 STD	08-306800-00	4	R60150 STD	08-524900-00	4	R60590 STD	08-124800-00	4
R48110 0.50MM	08-786407-00	4	R49650 STD	08-520500-00	4	R60160 STD	08-103900-00	1	R60600 0.40MM	08-145406-00	4
R48110 STD	08-786400-00	4	R49690 0.60MM	08-854708-00	4	R60190 STD	08-323400-00	4	R60600 STD	08-145400-00	4
R48270 0.50MM	08-528607-00	1	R49690 STD	08-854700-00	4	R60200 STD	08-425000-00	4	R60610 0.50MM	08-126007-00	4
R48270 STD	08-528600-00	1	R49740 STD	08-521600-00	6	R60210 0.25MM	08-154605-00	4	R60610 STD	08-126000-00	4
R48280 0.50MM	08-528707-00	1	R49750 0.50MM	08-102207-00	4	R60210 0.60MM	08-154608-00	4	R60620 0.50mm	08-123407-00	1









INTERCHANGE AE → GOETZE

Vergleichsliste AE → Goetze • Références croisées AE → Goetze
Intercambio entre AE y Goetze

	ref		New GOETZE Rings ref	*		ref		New GOETZE Rings ref	*		ref		New GOETZE Rings ref	*		ref		New GOETZE Rings ref	*
R60620 STD	08-123400-00	4	R66260 0.50MM	08-335107-00	4	R66640 STD	08-126100-00	6	R67480 STD	08-782400-00	6								
R60630 STD	08-118700-00	4	R66260 STD	08-335100-00	4	R66650 STD	08-135800-00	4	R67490 STD	08-103400-00	4								
R60640 STD	08-118800-00	4	R66270 STD	08-334300-00	4	R66660 STD	08-502600-00	1	R67500 STD	08-103500-00	4								
R60660 STD	08-105200-00	4	R66280 STD	08-336600-00	4	R66670 0.40MM	08-138406-00	4	R67510 STD	08-102400-00	1								
R60670 0.60MM	08-126608-00	4	R66290 STD	08-316900-00	6	R66670 STD	08-138400-00	4	R67520 STD	08-132200-10	1								
R60670 STD	08-126600-00	4	R66300 STD	08-334400-00	4	R66680 0.50MM	08-136607-00	4	R67530 STD	08-102500-00	1								
R60710 STD	08-125800-00	1	R66310 STD	08-214500-10	1	R66680 STD	08-136600-00	4	R67540 STD	08-502100-00	1								
R60720 STD	08-335300-00	1	R66320 STD	08-334200-00	4	R66690 0.50MM	08-101307-00	4	R67550 STD	08-501300-00	1								
R60730 STD	08-702300-00	1	R66330 0.25MM	08-336505-00	4	R66690 STD	08-101300-00	4	R67560 STD	08-112100-00	1								
R60740 STD	08-335900-00	1	R66330 0.50MM	08-336507-00	4	R66700 STD	08-337500-00	1	R67570 STD	08-786900-00	4								
R60750 STD	08-131500-10	1	R66330 STD	08-336500-00	4	R66710 STD	08-135500-00	1	R67580 STD	08-337400-00	4								
R60760 STD	08-132000-10	1	R66340 STD	08-337100-00	4	R66720 STD	08-137500-00	1	R67590 STD	08-121900-00	1								
R60800 STD	08-347900-10	1	R66350 0.50MM	08-335007-10	4	R66730 STD	08-145000-00	1	R67600 STD	08-122000-00	1								
R60820 STD	08-346500-10	1	R66350 STD	08-335000-10	4	R66740 STD	08-103800-00	4	R67680 STD	08-141400-00	4								
R60830 STD	08-335800-00	1	R66360 STD	08-337100-00	4	R66750 STD	08-101400-00	1	R67690 STD	08-134200-00	6								
R60840 STD	08-522900-00	1	R66370 STD	08-344500-00	4	R66760 STD	08-104500-00	1	R67700 STD	08-135400-00	6								
R60850 STD	08-154200-00	4	R66380 STD	08-346000-00	4	R66770 STD	08-135300-00	1	R67710 STD	08-141900-00	1								
R60860 STD	08-154300-00	4	R66390 0.50MM	08-152007-00	4	R66780 STD	08-127400-00	1	R67720 0.50MM	08-140007-00	5								
R60870 STD	08-154400-00	4	R66390 0.80MM	08-152010-00	4	R66790 0.40MM	08-124706-00	4	R67720 STD	08-140000-00	5								
R60880 STD	08-154400-00	4	R66390 STD	08-152000-00	4	R66790 0.60MM	08-124708-00	4	R67730 STD	08-142900-00	6								
R60900 STD	08-144700-00	2	R66400 0.50MM	08-321507-00	4	R66790 STD	08-124700-00	4	R67770 STD	08-123500-00	1								
R60910 STD	08-144700-00	2	R66400 0.80MM	08-321510-00	4	R66800 0.60MM	08-138008-00	4	R67780 STD	08-318900-10	1								
R60930 STD	08-147100-00	2	R66400 STD	08-321500-00	4	R66800 STD	08-138000-00	4	R67790 STD	08-118600-00	1								
R60940 STD	08-151200-00	4	R66410 STD	08-150900-00	2	R66820 STD	08-138200-00	4	R67800 STD	08-990500-00	1								
R60950 STD	08-322400-00	4	R66420 STD	08-335400-00	4	R66830 0.40MM	08-137606-00	4	R67810 STD	08-741200-00	1								
R60960 STD	08-214400-10	4	R66430 STD	08-337000-00	4	R66830 STD	08-137600-00	4	R67820 STD	08-403600-10	1								
R60970 0.50MM	08-152707-00	4	R66450 0.50MM	08-991407-00	1	R66860 0.25MM	08-136705-00	3	R67830 STD	08-500500-20	1								
R60970 STD	08-152700-00	4	R66450 STD	08-991400-00	1	R66860 0.50MM	08-136707-00	3	R67840 STD	08-123200-00	1								
R60980 STD	08-154500-00	4	R66460 STD	08-991000-00	4	R66860 STD	08-136700-00	3	R67850 STD	08-374300-00	4								
R60990 STD	08-152900-00	4	R66470 0.50MM	08-705007-00	6	R66870 STD	08-405600-20	1	R67890 STD	08-374000-00	4								
R66000 STD	08-320200-10	4	R66470 STD	08-705000-00	6	R66880 STD	08-407100-20	1	R67910 STD	08-502700-00	1								
R66020 STD	08-312900-00	4	R66480 0.50MM	08-702607-00	4	R66890 STD	08-396300-20	1	R67923 0.40MM	08-145206-00	1								
R66030 STD	08-319100-10	4	R66480 STD	08-702600-00	4	R66900 STD	08-103000-00	6	R67923 STD	08-145200-00	1								
R66050 STD	08-313800-10	4	R66490 0.50MM	08-704207-00	4	R67000 STD	08-124600-00	6	R67924 0.40MM	08-145306-00	1								
R66060 0.50MM	08-315307-00	4	R66490 STD	08-704200-00	4	R67010 STD	08-502400-00	4	R67924 STD	08-145300-00	1								
R66060 STD	08-315300-00	4	R66500 0.50MM	08-705107-00	6	R67020 STD	08-138900-00	4	R67925 0.60MM	08-146108-00	1								
R66070 STD	08-314900-10	4	R66500 STD	08-705100-00	6	R67030 STD	08-136800-00	1	R67925 STD	08-146100-00	1								
R66090 STD	08-319400-00	4	R66510 0.50MM	08-132907-00	4	R67080 STD	08-373600-00	4	R67927 0.40MM	08-145406-00	1								
R66100 STD	08-317300-00	4	R66510 STD	08-132900-00	4	R67210 STD	08-500300-00	1	R67927 STD	08-145400-00	1								
R66110 0.50MM	08-316907-00	4	R66520 0.50MM	08-744607-00	1	R67220 STD	08-502500-00	1	R67928 0.40MM	08-145106-00	1								
R66110 STD	08-316900-00	4	R66520 STD	08-744600-00	1	R67230 STD	08-207200-00	1	R67928 0.60MM	08-145108-00	1								
R66120 STD	08-317600-10	4	R66530 0.50MM	08-740907-00	1	R67240 STD	08-325400-00	1	R67928 STD	08-145100-00	1								
R66130 STD	08-320100-00	4	R66530 STD	08-740900-00	1	R67250 STD	08-139400-00	4	R67931 STD	08-252800-00	1								
R66140 0.40MM	08-318706-10	4	R66540 0.50MM	08-744107-00	1	R67340 STD	08-138800-00	2	R67932 STD	08-136500-00	1								
R66140 0.60MM	08-318708-10	4	R66540 STD	08-744100-00	1	R67370 STD	08-134100-00	4	R67933 STD	08-124500-00	1								
R66140 0.80MM	08-318710-10	4	R66550 STD	08-283300-00	6	R67380 0.50MM	08-112407-00	4	R67934 0.50MM	08-136407-00	1								
R66140 1.00MM	08-318711-10	4	R66560 STD	08-285800-00	4	R67380 STD	08-112400-00	4	R67934 STD	08-136400-00	1								
R66140 STD	08-318700-10	4	R66570 STD	08-283100-00	1	R67390 0.20MM	08-139904-00	1	R67936 STD	08-119000-00	1								
R66150 STD	08-332200-00	4	R66580 0.50MM	08-170707-10	4	R67390 0.50MM	08-139907-00	1	R67937 STD	08-141800-00	1								
R66160 STD	08-334600-00	4	R66580 STD	08-170700-10	4	R67390 STD	08-139900-00	1	R67938 STD	08-136000-00	1								
R66170 STD	08-335500-00	4	R66590 0.50MM	08-183307-00	1	R67400 0.50MM	08-140707-00	4	R67970 STD	08-146400-00	1								
R66180 STD	08-331600-10	4	R66590 STD	08-183300-00	1	R67400 STD	08-140700-00	4	R67972 STD	08-115600-00	1								
R66190 0.50MM	08-333507-00	4	R66600 0.50MM	08-287507-00	1	R67410 0.50MM	08-140807-00	1	R67975 STD	08-742600-00	1								
R66190 STD	08-333500-00	4	R66600 STD	08-287500-00	1	R67410 STD	08-140800-00	1	R67977 STD	08-782100-00	1								
R66200 STD	08-336400-00	4	R66610 0.50MM	08-109107-00	4	R67420 STD	08-139800-00	5	R67978 STD	08-501600-00	1								
R66210 STD	08-333300-00	4	R66610 STD	08-109100-00	4	R67430 0.50MM	08-326307-00	4	R8576 STD	08-529700-00	4								
R66220 0.50MM	08-333407-10	4	R66620 0.50MM	08-288807-00	1	R67430 STD	08-326300-00	4											
R66220 STD	08-333400-10	4	R66620 STD	08-288800-00	1	R67440 STD	08-154700-00	4											
R66240 STD	08-334000-00	4	R66630 0.50MM	08-126207-00	6	R67450 STD	08-337700-00	4											
R66250 STD	08-334500-00	4	R66630 STD	08-126200-00	6	R67460 STD	08-786600-00	4											
R66260 0.25MM	08-335105-00	4	R66640 0.50MM	08-126107-00	6	R67470 STD	08-782500-00	6											









* For AE® ref multiply New Goetze® ref by / Für AE-Ref. bitte die Goetze-Ref. mit x multiplizieren / Pour obtenir les anciennes réf. AE®, multipliez les nouvelles réf. Goetze® par / Para referencia AE® multiplicar la referencia nueva de Goetze® por / Dla uzyskania ilości wg nr ref. AE® należy pomnożyć nowy nr ref. Goetze® przez / Homep AE®
المراجع القديم AE® مضاعف المرجع الجديد من Goetze® /

NURAL PISTONS FITTED WITH GOETZE RING SETS

 Nural Piston	 GOETZE Rings Set	 Nural Piston	 GOETZE Rings Set	 Nural Piston	 GOETZE Rings Set	 Nural Piston	 GOETZE Rings Set
87-100100-00	08-100100-00	87-107600-00	08-107600-00	87-114700-10	08-114700-00	87-117907-10	08-117907-00
87-101300-00	08-101300-00	87-107607-00	08-107607-00	87-114700-30	08-114700-00	87-117907-20	08-117907-00
87-101307-00	08-101307-00	87-107900-00	08-107900-00	87-114700-40	08-114700-00	87-118000-00	08-118000-00
87-101500-00	08-101500-00	87-107908-00	08-107908-00	87-114708-30	08-114708-00	87-118000-10	08-118000-00
87-101507-00	08-101507-00	87-108000-00	08-108000-00	87-114900-05	08-114900-00	87-118000-30	08-118000-00
87-101600-00	08-101600-00	87-108008-00	08-108008-00	87-114900-15	08-114900-00	87-118006-00	08-118006-00
87-101700-00	08-101700-00	87-108200-00	08-108200-00	87-114900-20	08-114900-00	87-118006-10	08-118006-00
87-102300-00	08-102300-00	87-108208-00	08-108208-00	87-114900-25	08-114900-00	87-118006-30	08-118006-00
87-102307-00	08-102307-00	87-108700-00	08-108700-00	87-114900-30	08-114900-00	87-119000-00	08-119000-00
87-102700-00	08-102700-00	87-108707-00	08-108707-00	87-114900-35	08-114900-00	87-119800-00	08-119800-00
87-102700-10	08-102700-10	87-109100-00	08-109100-00	87-114900-40	08-114900-00	87-119807-00	08-119807-00
87-102707-00	08-102707-00	87-109100-10	08-109100-00	87-114900-45	08-114900-00	87-121800-00	08-121800-00
87-102707-10	08-102707-00	87-109107-00	08-109107-00	87-114900-46	08-114900-00	87-121800-10	08-121800-00
87-102800-10	08-102800-00	87-109107-10	08-109107-00	87-114900-50	08-114900-00	87-121900-00	08-121900-00
87-102807-10	08-102807-00	87-109200-00	08-109200-00	87-114900-55	08-114900-00	87-122000-00	08-122000-00
87-102900-10	08-102900-00	87-109400-10	08-109400-10	87-114900-56	08-114900-00	87-122200-00	08-122200-00
87-102907-10	08-102907-00	87-109400-50	08-109400-10	87-114900-60	08-114900-00	87-122200-10	08-122200-00
87-103000-00	08-103000-00	87-109407-50	08-109407-10	87-114900-65	08-114900-00	87-122200-20	08-122200-00
87-103000-10	08-103000-00	87-109500-00	08-109500-00	87-114900-66	08-114900-00	87-122208-00	08-122208-00
87-103000-30	08-103000-00	87-109505-00	08-109505-00	87-114900-70	08-114900-00	87-122208-10	08-122208-00
87-103000-40	08-103000-00	87-109507-00	08-109507-00	87-114900-80	08-114900-00	87-123200-00	08-123200-00
87-103200-00	08-103200-00	87-109511-00	08-109511-00	87-114900-85	08-114900-00	87-123200-10	08-123200-00
87-103207-00	08-103207-00	87-109700-00	08-109700-00	87-114900-90	08-114900-00	87-123200-40	08-123200-00
87-103500-00	08-103500-00	87-109700-20	08-109700-00	87-114900-95	08-114900-00	87-123400-00	08-123400-00
87-103507-00	08-103507-00	87-109700-30	08-109700-00	87-114905-60	08-114905-00	87-123400-10	08-123400-00
87-103800-00	08-103800-00	87-109705-20	08-109705-00	87-114905-70	08-114905-00	87-123400-20	08-123400-00
87-103806-00	08-103806-00	87-109705-30	08-109705-00	87-114905-90	08-114905-00	87-123400-30	08-123400-30
87-103900-00	08-103900-00	87-109707-00	08-109707-00	87-114905-95	08-114905-00	87-123400-40	08-123400-30
87-103900-10	08-103900-00	87-109707-10	08-109707-00	87-114907-05	08-114907-00	87-123400-50	08-123400-30
87-103900-30	08-103900-00	87-109707-20	08-109707-00	87-114907-15	08-114907-00	87-123407-00	08-123407-00
87-103900-40	08-103900-00	87-109707-30	08-109707-00	87-114907-20	08-114907-00	87-123407-10	08-123407-00
87-103908-00	08-103908-00	87-109800-10	08-109800-00	87-114907-25	08-114907-00	87-123407-20	08-123407-00
87-103908-40	08-103908-00	87-109807-10	08-109807-00	87-114907-30	08-114907-00	87-123407-30	08-123407-30
87-104000-00	08-104000-00	87-109811-10	08-109811-00	87-114907-35	08-114907-00	87-123407-40	08-123407-30
87-104008-00	08-104008-00	87-110100-00	08-110100-00	87-114907-40	08-114907-00	87-123407-50	08-123407-30
87-104100-00	08-104100-00	87-110200-30	08-110200-00	87-114907-45	08-114907-00	87-123700-00	08-123700-00
87-104105-00	08-104105-00	87-110200-40	08-110200-00	87-114907-46	08-114907-00	87-123700-10	08-123700-00
87-104107-00	08-104107-00	87-110500-30	08-110500-00	87-114907-50	08-114907-00	87-123700-30	08-123700-00
87-104200-00	08-104200-00	87-110900-00	08-110900-00	87-114907-55	08-114907-00	87-123711-00	08-123711-00
87-104200-10	08-104200-00	87-110906-00	08-110906-00	87-114907-56	08-114907-00	87-123711-10	08-123711-00
87-104200-30	08-104200-00	87-111200-00	08-111200-00	87-114907-60	08-114907-00	87-123711-30	08-123711-00
87-104200-40	08-104200-00	87-111900-00	08-111900-00	87-114907-65	08-114907-00	87-123721-00	08-123721-00
87-104207-00	08-104207-00	87-112400-00	08-112400-00	87-114907-66	08-114907-00	87-123721-10	08-123721-00
87-104207-10	08-104207-00	87-112407-00	08-112407-00	87-114907-70	08-114907-00	87-123721-30	08-123721-00
87-104207-40	08-104207-00	87-113500-00	08-113500-00	87-114907-80	08-114907-00	87-124000-00	08-124000-00
87-104300-00	08-104300-00	87-113500-10	08-113500-00	87-114907-85	08-114907-00	87-124000-10	08-124000-00
87-104300-10	08-104300-00	87-113507-00	08-113507-00	87-114907-90	08-114907-00	87-124000-30	08-124000-00
87-105500-00	08-105500-00	87-113507-10	08-113507-00	87-114907-95	08-114907-00	87-124008-00	08-124008-00
87-105507-00	08-105507-00	87-113511-00	08-113511-00	87-114911-20	08-114911-00	87-124008-10	08-124008-00
87-105900-00	08-105900-00	87-113511-10	08-113511-00	87-114911-30	08-114911-00	87-124008-30	08-124008-00
87-105907-00	08-105907-00	87-114400-00	08-114400-00	87-114911-60	08-114911-00	87-124500-00	08-124500-00
87-107000-00	08-107000-00	87-114400-10	08-114400-00	87-114911-70	08-114911-00	87-124500-10	08-124500-00
87-107000-10	08-107000-00	87-114400-30	08-114400-00	87-114911-90	08-114911-00	87-124500-20	08-124500-00
87-107007-00	08-107007-00	87-114400-40	08-114400-40	87-114911-95	08-114911-00	87-124500-30	08-124500-00
87-107007-10	08-107007-00	87-114400-60	08-114400-40	87-115800-00	08-115800-00	87-124800-00	08-124800-00
87-107011-10	08-107011-00	87-114405-00	08-114405-00	87-116100-00	08-116100-00	87-124806-00	08-124806-00
87-107100-30	08-107100-00	87-114405-10	08-114405-00	87-116107-00	08-116107-00	87-125600-00	08-125600-00
87-107100-40	08-107100-10	87-114405-30	08-114405-00	87-117900-00	08-117900-00	87-125607-00	08-125607-00
87-107200-00	08-107200-00	87-114405-40	08-114405-40	87-117900-10	08-117900-00	87-126000-00	08-126000-00
87-107200-10	08-107200-00	87-114405-60	08-114405-40	87-117900-20	08-117900-00	87-126000-10	08-126000-00
87-107209-00	08-107209-00	87-114700-00	08-114700-00	87-117907-00	08-117907-00	87-126007-00	08-126007-00









Nüral Kolben ausgestattet mit Goetze Kolbenringsätzen
Pistons Nüral équipés de jeux de segments Goetze
Pistones Nüral equipados con conjuntos de segmentos Goetze

Łłoki Nüral z zamontowanymi zestawami pierścieni Goetze
Porшни Nüral, оснащаемые кольцами Goetze
Goetze يتم تركيب كباسات Nüral باستخدام مجموعات حلقات

 Nüral Piston	 GOETZE Rings Set	 Nüral Piston	 GOETZE Rings Set	 Nüral Piston	 GOETZE Rings Set	 Nüral Piston	 GOETZE Rings Set
87-126007-10	08-126007-00	87-136900-00	08-136900-00	87-142900-00	08-142900-00	87-154200-10	08-154200-00
87-126200-00	08-126200-00	87-137500-10	08-137500-10	87-143200-00	08-143200-00	87-154200-30	08-154200-00
87-126207-00	08-126207-00	87-137507-10	08-137507-10	87-143207-00	08-143207-00	87-154206-00	08-154206-00
87-126300-10	08-126300-10	87-137600-00	08-137600-00	87-143300-00	08-143300-00	87-154206-10	08-154206-00
87-126307-10	08-126307-10	87-137606-00	08-137606-00	87-143307-00	08-143307-00	87-154206-30	08-154206-00
87-126309-10	08-126309-10	87-138000-00	08-138000-00	87-143400-00	08-143400-00	87-154208-00	08-154208-00
87-126311-10	08-126311-10	87-138000-10	08-138000-00	87-143407-00	08-143407-00	87-154208-10	08-154208-00
87-126600-00	08-126600-00	87-138006-00	08-138006-00	87-143500-00	08-143500-00	87-154208-30	08-154208-00
87-126608-00	08-126608-00	87-138006-10	08-138006-00	87-143507-00	08-143507-00	87-154300-00	08-154300-00
87-127400-00	08-127400-00	87-138008-00	08-138008-00	87-143600-00	08-143600-10	87-154400-00	08-154400-00
87-127400-10	08-127400-00	87-138008-10	08-138008-00	87-143600-10	08-143600-10	87-154600-00	08-154600-00
87-127407-00	08-127407-00	87-138400-00	08-138400-00	87-143600-30	08-143600-10	87-154608-00	08-154608-00
87-127407-10	08-127407-00	87-138400-10	08-138400-00	87-143600-40	08-143600-10	87-167600-00	08-167600-10
87-127800-00	08-127800-00	87-138400-30	08-138400-00	87-143800-00	08-143800-00	87-167607-00	08-167607-10
87-127900-00	08-127900-00	87-138400-40	08-138400-00	87-143800-10	08-143800-00	87-167611-10	08-167611-10
87-131300-00	08-131300-00	87-138406-00	08-138406-00	87-143800-20	08-143800-00	87-170700-00	08-170700-10
87-131305-00	08-131305-00	87-138406-10	08-138406-00	87-143800-30	08-143800-00	87-170707-00	08-170707-10
87-131307-00	08-131307-00	87-138406-30	08-138406-00	87-143800-40	08-143800-00	87-172500-00	08-172500-00
87-131500-00	08-131500-10	87-138406-40	08-138406-00	87-143800-50	08-143800-00	87-172507-00	08-172507-00
87-132900-00	08-132900-00	87-138408-10	08-138408-00	87-143800-60	08-143800-00	87-172511-00	08-172511-00
87-132900-10	08-132900-00	87-138900-10	08-138900-00	87-143800-70	08-143800-00	87-173800-10	08-173800-00
87-132907-00	08-132907-00	87-138900-30	08-138900-00	87-144200-02	08-144200-50	87-173805-10	08-173805-00
87-132907-10	08-132907-00	87-139400-00	08-139400-00	87-144207-02	08-144200-50	87-173807-10	08-173807-00
87-133100-00	08-133100-10	87-139407-00	08-139407-00	87-145000-00	08-145000-00	87-174100-00	08-174100-10
87-133105-00	08-133105-10	87-139500-00	08-139500-00	87-145007-00	08-145007-00	87-174100-30	08-174100-10
87-133107-00	08-133107-10	87-139500-10	08-139500-00	87-145100-00	08-145100-00	87-174300-00	08-174300-10
87-133900-00	08-133900-00	87-139500-20	08-139500-00	87-145106-00	08-145106-00	87-174300-10	08-174300-10
87-133900-10	08-133900-00	87-139500-30	08-139500-00	87-145108-00	08-145108-00	87-174307-00	08-174307-10
87-135300-00	08-135300-00	87-139500-40	08-139500-00	87-145200-00	08-145200-00	87-174307-10	08-174307-10
87-135300-10	08-135300-00	87-139507-00	08-139507-00	87-145206-00	08-145206-00	87-174311-00	08-174311-10
87-135305-00	08-135305-00	87-139507-10	08-139507-00	87-145300-00	08-145300-00	87-174311-10	08-174311-10
87-135307-00	08-135307-00	87-139507-20	08-139507-00	87-145306-00	08-145306-00	87-174314-00	08-174314-10
87-135307-10	08-135307-00	87-139507-30	08-139507-00	87-145400-00	08-145400-00	87-174600-00	08-174600-10
87-135500-00	08-135500-00	87-139507-40	08-139507-00	87-145400-10	08-145400-10	87-174600-10	08-174600-10
87-135500-10	08-135500-10	87-139900-00	08-139900-00	87-145400-30	08-145400-00	87-174600-30	08-174600-10
87-135800-00	08-135800-00	87-139904-00	08-139904-00	87-145406-00	08-145406-00	87-174607-00	08-174607-10
87-136000-00	08-136000-00	87-139907-00	08-139907-00	87-145406-10	08-145406-00	87-174607-10	08-174607-10
87-136000-10	08-136000-00	87-140000-00	08-140000-00	87-145406-30	08-145406-00	87-174607-30	08-174607-10
87-136400-00	08-136400-00	87-140007-00	08-140007-00	87-145900-00	08-145900-00	87-176000-00	08-176000-00
87-136407-00	08-136407-00	87-140500-00	08-140500-00	87-146100-00	08-146100-00	87-176000-01	08-176000-00
87-136500-00	08-136500-00	87-140507-00	08-140507-00	87-146100-10	08-146100-00	87-176000-10	08-176000-00
87-136500-10	08-136500-10	87-140600-00	08-140600-00	87-146106-10	08-146106-00	87-176400-00	08-176400-10
87-136500-30	08-136500-30	87-140800-00	08-140800-00	87-146108-00	08-146108-00	87-176407-00	08-176407-10
87-136500-40	08-136500-30	87-140800-10	08-140800-00	87-146500-00	08-146500-00	87-176411-00	08-176411-10
87-136500-50	08-136500-30	87-140807-00	08-140807-00	87-146507-00	08-146507-00	87-176600-00	08-176600-00
87-136500-60	08-136500-30	87-140807-10	08-140807-00	87-148100-00	08-148100-00	87-176607-00	08-176607-00
87-136500-65	08-136500-30	87-141300-00	08-141300-00	87-148100-10	08-148100-00	87-176611-00	08-176611-00
87-136500-70	08-136500-30	87-141307-00	08-141307-00	87-148100-30	08-148100-00	87-176700-00	08-176700-00
87-136500-75	08-136500-30	87-141800-00	08-141800-00	87-148100-40	08-148100-00	87-176700-10	08-176700-00
87-136500-80	08-136500-30	87-141900-00	08-141900-00	87-148105-00	08-148105-00	87-176708-00	08-176708-00
87-136500-85	08-136500-30	87-142000-00	08-142000-00	87-148105-10	08-148105-00	87-176800-00	08-176800-10
87-136500-90	08-136500-30	87-142100-00	08-142100-00	87-148107-00	08-148107-00	87-176800-30	08-176800-10
87-136500-91	08-136500-30	87-142107-00	08-142107-00	87-148107-10	08-148107-00	87-176800-40	08-176800-10
87-136600-00	08-136600-00	87-142300-00	08-142300-00	87-148107-30	08-148107-00	87-176900-00	08-176900-10
87-136607-00	08-136607-00	87-142306-00	08-142306-00	87-148107-40	08-148107-00	87-176900-10	08-176900-10
87-136700-00	08-136700-00	87-142308-00	08-142308-00	87-152000-10	08-152000-00	87-176907-00	08-176907-10
87-136705-00	08-136705-00	87-142400-00	08-142400-00	87-152007-00	08-152007-00	87-176907-10	08-176907-10
87-136707-00	08-136707-00	87-142406-00	08-142406-00	87-152010-10	08-152010-00	87-176911-00	08-176911-10
87-136800-10	08-136800-00	87-142500-00	08-142500-00	87-152700-00	08-152700-00	87-176911-10	08-176911-10
87-136800-30	08-136800-00	87-142500-10	08-142500-00	87-152707-00	08-152707-00	87-176914-00	08-176914-10
87-136800-40	08-136800-00	87-142800-00	08-142800-00	87-154200-00	08-154200-00	87-176914-10	08-176914-10











NURAL PISTONS FITTED WITH GOETZE RING SETS









 Nural Piston	 GOETZE Rings Set	 Nural Piston	 GOETZE Rings Set	 Nural Piston	 GOETZE Rings Set	 Nural Piston	 GOETZE Rings Set
87-178200-20	08-178200-00	87-202407-10	08-202407-10	87-214809-10	08-214809-10	87-283100-10	08-283100-00
87-178207-20	08-178207-00	87-202409-10	08-202409-10	87-214811-10	08-214811-10	87-283100-30	08-283100-00
87-178211-20	08-178211-00	87-202411-00	08-202411-10	87-214900-10	08-214900-10	87-283100-40	08-283100-00
87-178400-00	08-178400-10	87-202411-10	08-202411-10	87-215100-10	08-215100-10	87-283100-50	08-283100-00
87-178407-00	08-178407-10	87-202800-00	08-202800-00	87-215108-10	08-215108-10	87-283100-60	08-283100-00
87-178800-00	08-178800-00	87-202807-00	08-202807-00	87-215200-00	08-215200-10	87-283100-70	08-283100-00
87-178807-00	08-178807-00	87-202809-00	08-202809-00	87-215208-00	08-215208-10	87-283100-80	08-283100-00
87-178811-00	08-178811-00	87-202811-00	08-202811-00	87-215300-00	08-215300-10	87-283100-85	08-283100-00
87-179000-10	08-179000-10	87-203100-00	08-203100-00	87-215300-10	08-215300-10	87-283100-86	08-283100-00
87-179300-05	08-179300-10	87-203106-00	08-203106-00	87-215306-10	08-215306-10	87-283300-00	08-283300-00
87-179300-06	08-179300-10	87-203106-10	08-203106-00	87-215308-00	08-215308-10	87-283600-00	08-283600-00
87-179300-10	08-179300-10	87-203108-00	08-203108-00	87-215308-10	08-215308-10	87-283607-00	08-283607-00
87-179300-15	08-179300-10	87-203108-10	08-203108-00	87-215507-00	08-215507-10	87-283611-00	08-283611-00
87-179300-16	08-179300-10	87-203500-00	08-203500-10	87-243300-00	08-243300-00	87-285800-00	08-285800-00
87-179300-20	08-179300-10	87-205800-00	08-205800-00	87-243600-00	08-243600-00	87-285900-00	08-285900-00
87-179300-25	08-179300-10	87-205807-00	08-205807-00	87-244500-10	08-244500-10	87-285900-05	08-285900-00
87-179300-30	08-179300-10	87-206600-00	08-206600-00	87-244500-30	08-244500-00	87-285900-06	08-285900-00
87-179300-40	08-179300-10	87-206600-10	08-206600-00	87-244500-40	08-244500-00	87-285900-10	08-285900-00
87-179300-50	08-179300-10	87-206607-00	08-206607-00	87-245200-30	08-245200-00	87-285900-15	08-285900-00
87-179300-55	08-179300-10	87-206607-10	08-206607-00	87-245200-40	08-245200-00	87-285900-16	08-285900-00
87-179300-60	08-179300-10	87-206611-00	08-206611-00	87-245200-50	08-245200-00	87-285900-30	08-285900-00
87-179300-65	08-179300-10	87-206611-10	08-206611-00	87-245200-60	08-245200-00	87-285900-40	08-285900-00
87-179300-67	08-179300-10	87-206617-10	08-206617-00	87-245208-30	08-245208-00	87-287100-00	08-287100-00
87-179300-70	08-179300-10	87-206800-00	08-206800-00	87-245208-40	08-245208-00	87-287100-10	08-287100-00
87-179300-80	08-179300-10	87-206800-10	08-206800-00	87-245208-50	08-245208-00	87-287100-30	08-287100-00
87-179300-85	08-179300-10	87-206800-30	08-206800-00	87-245500-00	08-245500-00	87-287107-00	08-287107-00
87-179300-87	08-179300-10	87-206808-00	08-206808-00	87-245500-10	08-245500-00	87-287107-10	08-287107-00
87-179300-90	08-179300-10	87-206808-10	08-206808-00	87-247200-00	08-247200-10	87-287107-30	08-287107-00
87-179400-00	08-179400-00	87-206808-30	08-206808-00	87-247600-00	08-247600-00	87-287500-00	08-287500-00
87-179500-00	08-179500-00	87-207200-00	08-207200-00	87-247600-10	08-247600-00	87-287500-10	08-287500-00
87-179500-10	08-179500-00	87-207208-00	08-207208-00	87-247800-00	08-247800-00	87-287500-20	08-287500-00
87-179507-00	08-179507-00	87-207311-00	08-207311-10	87-247800-10	08-247800-00	87-287500-30	08-287500-00
87-179507-10	08-179507-00	87-207321-00	08-207321-10	87-247808-00	08-247808-00	87-287500-40	08-287500-00
87-179511-00	08-179511-00	87-207500-00	08-207500-00	87-247808-10	08-247808-00	87-287505-10	08-287505-00
87-179511-10	08-179511-00	87-207500-10	08-207500-00	87-248000-00	08-248000-10	87-287505-30	08-287505-00
87-179700-00	08-179700-00	87-207500-30	08-207500-00	87-248000-10	08-248000-10	87-287507-00	08-287507-00
87-179700-10	08-179700-00	87-207700-00	08-207700-00	87-248000-30	08-248000-10	87-287507-20	08-287507-00
87-179707-00	08-179707-00	87-207800-00	08-207800-30	87-252500-10	08-252500-00	87-287507-30	08-287507-00
87-179707-10	08-179707-00	87-207800-10	08-207800-10	87-252507-00	08-252507-00	87-287507-40	08-287507-00
87-179711-00	08-179711-00	87-207800-30	08-207800-10	87-252800-00	08-252800-00	87-288200-00	08-288200-00
87-179711-10	08-179711-00	87-208100-10	08-208100-00	87-263100-00	08-263100-00	87-288200-10	08-288200-00
87-181100-10	08-181100-00	87-208800-00	08-208800-00	87-263100-10	08-263100-00	87-288300-00	08-288300-00
87-181100-20	08-181100-00	87-208807-00	08-208807-00	87-263107-00	08-263107-00	87-288300-10	08-288300-00
87-181100-30	08-181100-00	87-208811-00	08-208811-00	87-263107-10	08-263107-00	87-288307-00	08-288307-00
87-181600-00	08-181600-10	87-209800-00	08-209800-00	87-269700-00	08-269700-00	87-288307-10	08-288307-00
87-181607-00	08-181607-10	87-209800-10	08-209800-00	87-269706-00	08-269706-00	87-288800-00	08-288800-00
87-181611-00	08-181611-10	87-209800-30	08-209800-00	87-269800-00	08-269800-00	87-288807-00	08-288807-00
87-181700-00	08-181700-00	87-209806-00	08-209806-00	87-269806-00	08-269806-00	87-289300-00	08-289300-00
87-181800-00	08-181800-00	87-209806-10	08-209806-00	87-269900-00	08-269900-00	87-289300-10	08-289300-00
87-181800-10	08-181800-00	87-209806-30	08-209806-00	87-269906-00	08-269906-00	87-289600-00	08-289600-00
87-183000-00	08-183000-00	87-209808-00	08-209808-00	87-274800-00	08-274800-10	87-289600-20	08-289600-00
87-183007-00	08-183007-00	87-209808-10	08-209808-00	87-274800-10	08-274800-10	87-295400-00	08-295400-00
87-183100-00	08-183100-00	87-214100-10	08-214100-00	87-274800-20	08-274800-10	87-304207-00	08-304207-00
87-183107-00	08-183107-00	87-214107-00	08-214107-00	87-274800-30	08-274800-10	87-305607-10	08-305607-00
87-183111-00	08-183111-00	87-214107-10	08-214107-00	87-279600-10	08-279600-00	87-305900-00	08-305900-10
87-183300-00	08-183300-00	87-214111-00	08-214111-00	87-280000-00	08-280000-10	87-305907-00	08-305907-00
87-183307-00	08-183307-00	87-214111-10	08-214111-00	87-280200-10	08-280200-10	87-305911-00	08-305911-10
87-202400-00	08-202400-10	87-214500-00	08-214500-10	87-280200-20	08-280200-00	87-306300-00	08-306300-00
87-202400-10	08-202400-10	87-214508-00	08-214508-10	87-280400-00	08-280400-10	87-306307-00	08-306307-00
87-202400-30	08-202400-10	87-214800-10	08-214800-10	87-283100-00	08-283100-00	87-306311-00	08-306311-00
87-202407-00	08-202407-10	87-214807-10	08-214807-10	87-283100-01	08-283100-00	87-306700-00	08-306700-00

Nüral Kolben ausgestattet mit Goetze Kolbenringsätzen
 Pistons Nüral équipés de jeux de segments Goetze
 Pistones Nüral equipados con conjuntos de segmentos Goetze

Łłoki Nüral z zamontowanymi zestawami pierścieni Goetze
 Поршни Nüral, оснащаемые кольцами Goetze
 Goetze Nüral باستخدام مجموعات حلقات Nürال تركيب كباسات









 Nüral Piston	 GOETZE Rings Set	 Nüral Piston	 GOETZE Rings Set	 Nüral Piston	 GOETZE Rings Set	 Nüral Piston	 GOETZE Rings Set
87-306700-10	08-306700-00	87-318711-00	08-318711-10	87-396300-00	08-396300-10	87-425707-00	08-425707-00
87-306707-00	08-306707-00	87-318900-10	08-318900-10	87-404500-00	08-404500-00	87-426100-00	08-426100-00
87-306707-10	08-306707-00	87-319000-00	08-319000-10	87-404500-20	08-404500-00	87-426107-00	08-426107-00
87-306711-00	08-306711-00	87-319000-10	08-319000-10	87-404503-00	08-404503-00	87-426200-00	08-426200-00
87-306711-10	08-306711-00	87-321500-10	08-321500-00	87-404507-00	08-404507-00	87-426300-00	08-426300-00
87-306800-10	08-306800-00	87-321507-10	08-321507-00	87-404507-20	08-404507-00	87-426600-00	08-426600-00
87-306800-20	08-306800-00	87-321510-10	08-321510-00	87-404511-00	08-404511-00	87-426700-00	08-426700-00
87-306800-30	08-306800-00	87-322000-00	08-322000-00	87-404511-20	08-404511-00	87-426707-00	08-426707-00
87-306800-40	08-306800-00	87-322000-10	08-322000-00	87-405200-00	08-405200-00	87-427000-00	08-427000-00
87-306807-10	08-306807-00	87-322100-00	08-322100-00	87-405207-00	08-405207-00	87-427100-00	08-427100-00
87-306807-20	08-306807-00	87-322700-00	08-322700-00	87-405211-00	08-405211-00	87-427105-00	08-427105-00
87-306807-30	08-306807-00	87-323600-00	08-323600-00	87-405500-00	08-405500-10	87-427107-00	08-427107-00
87-306807-40	08-306807-00	87-323607-00	08-323607-00	87-405500-10	08-405500-10	87-427400-00	08-427400-00
87-306811-30	08-306811-00	87-325600-00	08-325600-00	87-405600-60	08-405600-10	87-427400-10	08-427400-00
87-306900-00	08-306900-00	87-325600-10	08-325600-00	87-405600-70	08-405600-10	87-427400-20	08-427400-00
87-306900-10	08-306900-00	87-325800-00	08-325800-00	87-407000-00	08-407000-10	87-427400-30	08-427400-00
87-306900-20	08-306900-00	87-325806-00	08-325806-00	87-407100-00	08-407100-10	87-427407-00	08-427407-00
87-306907-00	08-306907-00	87-326300-00	08-326300-00	87-407100-10	08-407100-10	87-427407-10	08-427407-00
87-306907-10	08-306907-00	87-326307-00	08-326307-00	87-410900-10	08-420900-00	87-427500-00	08-427500-00
87-306907-20	08-306907-00	87-333300-00	08-333300-00	87-420100-00	08-420100-00	87-427507-00	08-427507-00
87-307000-20	08-307000-00	87-333400-00	08-333400-10	87-420108-00	08-420108-00	87-427600-10	08-427600-10
87-307007-20	08-307007-00	87-333500-00	08-333500-00	87-420200-00	08-420200-00	87-427700-10	08-427700-00
87-307100-20	08-307100-00	87-334300-00	08-334300-00	87-420900-00	08-420900-00	87-427700-30	08-427700-00
87-307100-30	08-307100-00	87-334400-00	08-334400-00	87-420900-10	08-420900-00	87-427707-10	08-427707-00
87-307107-20	08-307107-00	87-334600-00	08-334600-00	87-421000-10	08-421000-00	87-428000-00	08-428000-00
87-307107-30	08-307107-00	87-335000-00	08-335000-10	87-421000-20	08-421000-00	87-428600-00	08-428600-00
87-307200-00	08-307200-00	87-335000-10	08-335000-00	87-421000-30	08-421000-00	87-428600-01	08-428600-00
87-307200-10	08-307200-00	87-335007-00	08-335007-10	87-421007-10	08-421007-00	87-428600-00	08-428600-00
87-307207-00	08-307207-00	87-335007-10	08-335007-10	87-421007-20	08-421007-00	87-428707-00	08-428707-00
87-307207-10	08-307207-00	87-335100-10	08-335100-00	87-421007-30	08-421007-00	87-428800-00	08-428800-00
87-307600-10	08-307600-00	87-335107-10	08-335107-00	87-421600-00	08-421600-00	87-428900-00	08-428900-00
87-307600-20	08-307600-00	87-335300-00	08-335300-00	87-421900-00	08-421900-00	87-429100-00	08-429100-00
87-307600-30	08-307600-00	87-335800-00	08-335800-00	87-421904-00	08-421904-00	87-429200-00	08-429200-00
87-307600-40	08-307600-00	87-335900-00	08-335900-00	87-421906-00	08-421906-00	87-429400-00	08-429400-00
87-307607-10	08-307607-00	87-335900-10	08-335900-00	87-422000-00	08-422000-00	87-429407-00	08-429407-00
87-307607-20	08-307607-00	87-335900-30	08-335900-00	87-422007-00	08-422007-00	87-429500-00	08-429500-00
87-307607-30	08-307607-00	87-336500-00	08-336500-00	87-422100-00	08-422100-00	87-429507-00	08-429507-00
87-307607-40	08-307607-00	87-336500-10	08-336500-00	87-422200-10	08-422200-00	87-429900-00	08-429900-00
87-307700-00	08-307700-00	87-336505-00	08-336505-00	87-422207-10	08-422207-00	87-430000-00	08-430000-00
87-307700-10	08-307700-00	87-336507-00	08-336507-00	87-422300-00	08-422300-00	87-431000-00	08-431000-00
87-307707-00	08-307707-00	87-336507-10	08-336507-00	87-422307-00	08-422307-00	87-431000-10	08-431000-00
87-307707-10	08-307707-00	87-336510-00	08-336510-00	87-422400-00	08-422400-00	87-431300-00	08-431300-00
87-307800-10	08-307800-00	87-336600-00	08-336600-00	87-422407-00	08-422407-00	87-431600-00	08-431600-00
87-307807-10	08-307807-00	87-337100-00	08-337100-00	87-423000-00	08-423000-00	87-431700-00	08-431700-00
87-313400-00	08-313400-00	87-337300-00	08-337300-00	87-423000-01	08-423000-00	87-431707-00	08-431707-00
87-314600-00	08-314600-00	87-337500-00	08-337500-00	87-423000-10	08-423000-00	87-431800-00	08-431800-00
87-314600-10	08-314600-00	87-337500-10	08-337500-00	87-423000-11	08-423000-00	87-432200-00	08-432200-00
87-315000-00	08-315000-10	87-337500-30	08-337500-00	87-423400-00	08-423400-00	87-432300-00	08-432300-00
87-315200-00	08-315200-00	87-337500-50	08-337500-00	87-424000-00	08-424000-00	87-432300-10	08-432300-10
87-318000-00	08-318000-10	87-337600-00	08-337600-00	87-424008-00	08-424008-00	87-432400-00	08-432400-00
87-318700-00	08-318700-10	87-337600-10	08-337600-00	87-425000-00	08-425000-00	87-433300-00	08-433300-00
87-318700-10	08-318700-10	87-361900-00	08-361900-00	87-425000-10	08-425000-00	87-433400-00	08-433400-00
87-318700-30	08-318700-10	87-373700-00	08-373700-00	87-425008-00	08-425008-00	87-433405-00	08-433405-00
87-318706-00	08-318706-10	87-373800-00	08-373800-00	87-425008-10	08-425008-00	87-433407-00	08-433407-00
87-318706-10	08-318706-10	87-373800-10	08-373800-00	87-425200-00	08-425200-00	87-433500-00	08-433500-00
87-318706-30	08-318706-10	87-373800-30	08-373800-00	87-425400-00	08-425400-00	87-433505-00	08-433505-00
87-318708-00	08-318708-10	87-373800-40	08-373800-00	87-425407-00	08-425407-00	87-433507-00	08-433507-00
87-318708-10	08-318708-10	87-373807-00	08-373807-00	87-425411-00	08-425411-00	87-433600-00	08-433600-00
87-318708-30	08-318708-10	87-373807-30	08-373807-00	87-425600-00	08-425600-00	87-433607-00	08-433607-00
87-318710-10	08-318710-10	87-373807-40	08-373807-00	87-425606-00	08-425606-00	87-433700-00	08-433700-00
87-318710-30	08-318710-10	87-374407-00	08-374407-00	87-425700-00	08-425700-00	87-433707-00	08-433707-00

NURAL PISTONS FITTED WITH GOETZE RING SETS

 Nural Piston	 GOETZE Rings Set	 Nural Piston	 GOETZE Rings Set	 Nural Piston	 GOETZE Rings Set	 Nural Piston	 GOETZE Rings Set
87-433800-00	08-433800-00	87-502905-10	08-502905-00	87-523807-00	08-523807-00	87-526800-10	08-526800-00
87-433900-00	08-433900-00	87-502907-00	08-502907-00	87-523811-00	08-523811-00	87-527200-00	08-527200-00
87-433907-00	08-433907-00	87-502907-10	08-502907-00	87-524000-00	08-524000-00	87-527300-00	08-527300-00
87-434300-00	08-434300-00	87-520100-00	08-520100-00	87-524000-10	08-524000-00	87-527500-00	08-527500-00
87-434307-00	08-434307-00	87-520100-10	08-520100-00	87-524007-00	08-524007-00	87-527600-00	08-527600-00
87-434400-00	08-434400-00	87-520107-00	08-520107-00	87-524007-10	08-524007-00	87-527606-00	08-527606-00
87-434600-00	08-434600-00	87-520107-10	08-520107-00	87-524100-00	08-524100-00	87-527608-00	08-527608-00
87-434600-10	08-434600-00	87-520200-00	08-520200-00	87-524107-00	08-524107-00	87-527800-00	08-527800-00
87-435000-00	08-435000-00	87-520400-00	08-520400-00	87-524111-00	08-524111-00	87-527808-00	08-527808-00
87-435000-10	08-435000-00	87-520500-00	08-520500-00	87-524114-00	08-524114-00	87-527900-00	08-527900-00
87-435300-00	08-435300-00	87-520600-00	08-520600-00	87-524200-00	08-524200-00	87-528000-00	08-528000-00
87-435307-00	08-435307-00	87-520607-00	08-520607-00	87-524207-00	08-524207-00	87-528100-00	08-528100-00
87-435400-00	08-435400-00	87-520611-00	08-520611-00	87-524211-00	08-524211-00	87-528200-00	08-528200-00
87-435407-00	08-435407-00	87-520900-00	08-520900-00	87-524307-00	08-524307-00	87-528300-00	08-528300-00
87-435500-00	08-435500-00	87-521000-00	08-521000-00	87-524307-10	08-524307-10	87-528306-00	08-528306-00
87-435507-00	08-435507-00	87-521100-00	08-521100-00	87-524311-00	08-524311-00	87-528400-00	08-528400-00
87-436500-00	08-436500-00	87-521200-00	08-521200-00	87-524311-10	08-524311-10	87-528406-00	08-528406-00
87-436700-00	08-436700-00	87-521207-00	08-521207-00	87-524314-10	08-524314-10	87-528408-00	08-528408-00
87-436800-00	08-436800-00	87-521300-00	08-521300-00	87-524400-00	08-524400-00	87-528500-00	08-528500-00
87-436806-00	08-436806-00	87-521300-10	08-521300-00	87-524407-00	08-524407-00	87-528600-00	08-528600-00
87-436900-00	08-436900-00	87-521307-00	08-521307-00	87-524500-00	08-524500-00	87-528607-00	08-528607-00
87-437000-00	08-437000-00	87-521307-10	08-521307-00	87-524500-10	08-524500-00	87-528700-00	08-528700-00
87-437000-10	08-437000-00	87-521400-00	08-521400-00	87-524800-00	08-524800-00	87-528707-00	08-528707-00
87-437007-00	08-437007-00	87-521407-00	08-521407-00	87-524800-10	08-524800-00	87-528800-00	08-528800-00
87-437007-10	08-437007-00	87-521500-00	08-521500-00	87-524804-00	08-524804-00	87-528807-00	08-528807-00
87-437400-00	08-437400-00	87-521500-10	08-521500-00	87-524807-00	08-524807-00	87-529000-00	08-529000-00
87-437600-00	08-437600-00	87-521600-00	08-521600-00	87-524807-10	08-524807-00	87-529007-00	08-529007-00
87-438800-00	08-438800-00	87-521700-00	08-521700-00	87-524811-00	08-524811-00	87-529200-00	08-529200-00
87-438900-00	08-438900-00	87-521707-00	08-521707-00	87-525000-00	08-525000-00	87-529204-00	08-529204-00
87-501300-00	08-501300-00	87-521707-10	08-521707-00	87-525007-00	08-525007-00	87-529207-00	08-529207-00
87-501400-00	08-501400-00	87-521711-00	08-521711-00	87-525011-00	08-525011-00	87-529300-00	08-529300-00
87-501500-00	08-501500-00	87-521714-00	08-521714-00	87-525014-00	08-525014-00	87-529306-00	08-529306-00
87-501500-10	08-501500-00	87-521800-20	08-521800-20	87-525100-00	08-525100-00	87-529907-00	08-529907-00
87-501500-20	08-501500-00	87-521807-20	08-521807-20	87-525100-10	08-525100-00	87-529909-00	08-529909-00
87-501500-30	08-501500-00	87-521811-20	08-521811-20	87-525200-00	08-525200-00	87-529911-00	08-529911-00
87-501500-40	08-501500-00	87-522200-00	08-522200-00	87-525209-00	08-525209-00	87-530100-00	08-530100-00
87-501507-00	08-501507-00	87-522307-00	08-522307-00	87-525300-00	08-525300-00	87-530107-00	08-530107-00
87-501507-10	08-501507-00	87-522309-00	08-522309-00	87-525400-00	08-525400-00	87-530109-00	08-530109-00
87-501507-20	08-501507-00	87-522311-00	08-522311-00	87-525407-00	08-525407-00	87-530400-00	08-530400-00
87-501507-30	08-501507-00	87-522314-00	08-522314-00	87-525411-00	08-525411-00	87-702605-00	08-702605-00
87-501507-40	08-501507-00	87-522400-00	08-522400-00	87-525414-00	08-525414-00	87-702607-00	08-702607-00
87-501800-10	08-501800-00	87-522407-00	08-522407-00	87-525500-00	08-525500-00	87-704200-10	08-704200-00
87-501800-20	08-501800-00	87-522411-00	08-522411-00	87-525507-00	08-525507-00	87-704207-10	08-704207-00
87-501800-40	08-501800-00	87-522414-00	08-522414-00	87-525509-00	08-525509-00	87-704500-00	08-704500-00
87-501800-50	08-501800-00	87-522600-00	08-522600-00	87-525700-00	08-525700-00	87-704507-00	08-704507-00
87-501800-60	08-501800-00	87-522607-00	08-522607-00	87-525707-00	08-525707-00	87-705000-00	08-705000-00
87-501800-70	08-501800-00	87-522700-00	08-522700-00	87-525709-00	08-525709-00	87-705007-00	08-705007-00
87-501807-10	08-501807-00	87-522700-10	08-522700-00	87-525711-00	08-525711-00	87-705100-00	08-705100-00
87-501807-20	08-501807-00	87-522900-00	08-522900-00	87-525711-00	08-525711-00	87-705107-00	08-705107-00
87-501807-60	08-501807-00	87-522900-10	08-522900-00	87-525900-00	08-525900-00	87-705107-00	08-705107-00
87-501900-00	08-501900-00	87-522900-30	08-522900-00	87-525907-00	08-525907-00	87-714400-00	08-714400-00
87-501907-00	08-501907-00	87-522900-40	08-522900-00	87-525909-00	08-525909-00	87-714407-00	08-714407-00
87-502600-00	08-502600-00	87-523000-00	08-523000-00	87-525911-00	08-525911-00	87-714411-00	08-714411-00
87-502700-00	08-502700-00	87-523000-10	08-523000-00	87-525914-00	08-525914-00	87-740000-00	08-740000-00
87-502800-00	08-502800-00	87-523100-00	08-523100-00	87-525914-00	08-525914-00	87-740000-01	08-740000-00
87-502800-10	08-502800-00	87-523108-00	08-523108-00	87-526107-00	08-526107-00	87-740000-10	08-740000-00
87-502807-00	08-502807-00	87-523300-00	08-523300-00	87-526109-00	08-526109-00	87-740000-20	08-740000-00
87-502807-10	08-502807-00	87-523307-00	08-523307-00	87-526300-00	08-526300-00	87-740000-40	08-740000-00
87-502900-00	08-502900-00	87-523500-00	08-523500-00	87-526400-00	08-526400-00	87-740000-41	08-740000-00
87-502900-10	08-502900-00	87-523600-00	08-523600-00	87-526411-00	08-526411-00	87-740000-50	08-740000-00
87-502900-20	08-502900-00	87-523800-00	08-523800-00	87-526600-00	08-526600-00	87-740000-51	08-740000-00
				87-526800-00	08-526800-00	87-740007-10	08-740007-00

Nüral Kolben ausgestattet mit Goetze Kolbenringsätzen
 Pistons Nüral équipés de jeux de segments Goetze
 Pistones Nüral equipados con conjuntos de segmentos Goetze

Łłoki Nüral z zamontowanymi zestawami pierścieni Goetze
 Поршни Nüral, оснащаемые кольцами Goetze
 Goetze يتتركيب كباسات Nüral باستخدام مجموعات حلقات

 Nüral Piston	 GOETZE Rings Set	 Nüral Piston	 GOETZE Rings Set	 Nüral Piston	 GOETZE Rings Set	 Nüral Piston	 GOETZE Rings Set
87-740007-20	08-740007-00	87-780311-30	08-780311-00	87-783900-00	08-783900-00	87-898407-02	08-898407-00
87-740007-40	08-740007-00	87-780314-10	08-780314-00	87-783900-10	08-783900-00	87-960200-00	08-960200-00
87-740007-50	08-740007-00	87-780314-30	08-780314-00	87-784100-00	08-784100-00	87-960207-00	08-960207-00
87-740300-00	08-740300-00	87-780600-10	08-780600-10	87-784100-10	08-784100-00	87-960800-10	08-960800-00
87-740300-10	08-740300-00	87-780600-20	08-780600-10	87-784107-00	08-784107-00	87-960900-00	08-960900-00
87-740307-00	08-740307-00	87-780607-00	08-780607-10	87-784107-10	08-784107-00	87-960900-10	08-960900-00
87-740311-00	08-740311-00	87-780607-10	08-780607-10	87-784200-00	08-784200-00	87-961000-00	08-961000-00
87-740900-00	08-740900-00	87-780607-20	08-780607-10	87-784200-10	08-784200-00	87-961000-10	08-961000-00
87-740900-10	08-740900-00	87-780609-00	08-780609-10	87-784207-00	08-784207-00	87-962000-00	08-962000-00
87-740900-20	08-740900-00	87-780609-10	08-780609-10	87-784207-10	08-784207-00	87-962000-10	08-962000-00
87-740900-30	08-740900-00	87-780609-20	08-780609-10	87-784600-00	08-784600-00	87-962000-30	08-962000-00
87-740907-00	08-740907-00	87-780611-10	08-780611-10	87-784607-00	08-784607-00	87-962000-40	08-962000-00
87-740907-10	08-740907-00	87-780611-20	08-780611-10	87-784611-00	08-784611-00	87-962000-50	08-962000-00
87-740907-20	08-740907-00	87-780614-00	08-780614-10	87-784800-00	08-784800-00	87-962000-60	08-962000-00
87-740907-30	08-740907-00	87-780614-10	08-780614-10	87-784811-00	08-784811-00	87-962000-70	08-962000-00
87-741200-10	08-741200-00	87-780614-20	08-780614-10	87-784821-00	08-784821-00	87-962000-80	08-962000-00
87-741207-10	08-741207-00	87-780617-00	08-780617-10	87-785000-00	08-785000-00	87-990100-10	08-990100-00
87-741600-00	08-741600-00	87-780617-10	08-780617-10	87-785000-10	08-785000-00	87-990100-40	08-990100-00
87-741800-00	08-741800-00	87-781000-00	08-781000-00	87-785007-00	08-785007-00	87-990105-10	08-990105-00
87-741800-20	08-741800-00	87-781800-00	08-781800-00	87-785007-10	08-785007-00	87-990105-40	08-990105-00
87-741807-00	08-741807-00	87-781900-10	08-781900-00	87-785011-00	08-785011-00	87-990107-10	08-990107-00
87-741807-20	08-741807-00	87-781900-30	08-781900-00	87-785011-10	08-785011-00	87-990107-40	08-990107-00
87-741811-00	08-741811-00	87-781908-10	08-781908-00	87-785107-00	08-785107-00	87-990111-10	08-990111-00
87-741811-20	08-741811-00	87-781908-30	08-781908-00	87-785200-00	08-785200-00	87-990111-40	08-990111-00
87-743100-00	08-743100-00	87-782000-00	08-782000-00	87-785207-00	08-785207-00	87-990500-00	08-990500-00
87-743100-10	08-743100-00	87-782000-10	08-782000-00	87-785300-00	08-785300-00	87-990700-00	08-990700-00
87-743100-30	08-743100-00	87-782008-00	08-782008-00	87-785300-10	08-785300-00	87-990705-00	08-990705-00
87-743100-40	08-743100-00	87-782100-00	08-782100-00	87-785400-00	08-785400-00	87-990707-00	08-990707-00
87-743107-00	08-743107-00	87-782100-10	08-782100-00	87-785408-00	08-785408-00	87-991400-10	08-991400-00
87-743107-10	08-743107-00	87-782100-30	08-782100-00	87-785500-00	08-785500-00	87-991407-10	08-991407-00
87-743107-30	08-743107-00	87-782100-40	08-782100-00	87-785506-00	08-785506-00		
87-743107-40	08-743107-00	87-782300-00	08-782300-00	87-785508-00	08-785508-00		
87-743107-50	08-743107-00	87-782308-00	08-782308-00	87-786300-00	08-786300-00		
87-743120-10	08-743120-00	87-782606-00	08-782606-00	87-786307-00	08-786307-00		
87-743120-20	08-743120-00	87-782608-00	08-782608-00	87-786400-00	08-786400-00		
87-743200-00	08-743200-00	87-782700-00	08-782700-00	87-786407-00	08-786407-00		
87-743200-10	08-743200-00	87-782900-00	08-782900-00	87-786500-00	08-786500-00		
87-743400-00	08-743400-00	87-782906-00	08-782906-00	87-786507-00	08-786507-00		
87-743400-10	08-743400-00	87-782910-00	08-782910-00	87-786800-00	08-786800-00		
87-743400-30	08-743400-00	87-783000-00	08-783000-00	87-786806-00	08-786806-00		
87-743400-40	08-743400-00	87-783000-10	08-783000-00	87-787000-00	08-787000-00		
87-743400-50	08-743400-00	87-783000-15	08-783000-00	87-787000-10	08-787000-00		
87-743600-00	08-743600-00	87-783000-30	08-783000-00	87-787000-30	08-787000-00		
87-743600-10	08-743600-00	87-783300-00	08-783300-00	87-787006-00	08-787006-00		
87-743607-00	08-743607-00	87-783308-00	08-783308-00	87-787006-10	08-787006-00		
87-743607-10	08-743607-00	87-783400-00	08-783400-00	87-787006-30	08-787006-00		
87-743607-20	08-743607-00	87-783500-10	08-783500-00	87-848300-02	08-848300-50		
87-744100-00	08-744100-00	87-783507-10	08-783507-00	87-848307-02	08-848307-50		
87-744107-00	08-744107-00	87-783511-10	08-783511-00	87-849000-02	08-849000-00		
87-744600-00	08-744600-00	87-783600-00	08-783600-00	87-849007-02	08-849007-00		
87-744607-00	08-744607-00	87-783606-00	08-783606-00	87-849200-02	08-849200-50		
87-744611-00	08-744611-00	87-783608-00	08-783608-00	87-849207-02	08-849207-50		
87-75004DP STD	08-429600-00	87-783700-00	08-783700-00	87-854700-00	08-854700-00		
87-780100-10	08-780100-00	87-783706-00	08-783706-00	87-854708-00	08-854708-00		
87-780121-10	08-780121-00	87-783708-00	08-783708-00	87-873400-02	08-873400-00		
87-780300-10	08-780300-00	87-783800-00	08-783800-00	87-873400-12	08-873400-00		
87-780300-30	08-780300-00	87-783800-10	08-783800-00	87-873407-02	08-873407-00		
87-780307-10	08-780307-00	87-783800-30	08-783800-00	87-873407-12	08-873407-00		
87-780307-30	08-780307-00	87-783808-00	08-783808-00	87-879200-02	08-879200-02		
87-780309-30	08-780309-00	87-783808-10	08-783808-00	87-879207-02	08-879207-02		
87-780311-10	08-780311-00	87-783808-30	08-783808-00	87-898400-02	08-898400-00		

Federal-Mogul Global Aftermarket EMEA bvba

Prins Boudewijnlaan 5 • B-2550 Kontich • Belgium

Central Distribution Centre

Prins Boudewijnlaan 7 • B-2550 Kontich • Belgium

Phone +32 (0) 3450 83 10 • Fax +32 (0) 3450 83 38

Federal-Mogul Italy Srl**Aftermarket Division**

Via Enrico Fermi 8 • 37135 Verona • Italy

Phone +39 045 828 13 11 • Fax +39 045 828 14 00

Federal-Mogul Germany GmbH

Albert-Ruprecht-Strasse 2 • 71636 Ludwigsburg • Germany

Phone +49 (0) 7141-64865-8230 • Fax +49 (0) 7141-64865-8390

Federal-Mogul Aftermarket UK Limited

Greyhound Drive • Bradford • BD7 1NQ • England

Phone +49 (0) 7141-64865-8230 • Fax: +49 (0) 7141-64865-8390

Federal-Mogul Ibérica, S.L.**Federal-Mogul Aftermarket España, S.A.**

Calle Alcarria, nº 2 • 28823 Coslada • Madrid • Spain

Phone: + 34 91 746 1900 • Fax: + 34 91 746 18 90

Federal-Mogul Aftermarket France

60-62, rue Danjou • 92517 Boulogne-Billancourt Cedex • France

Phone +33 (0) 1 46 94 27 00 • Fax +33 (0) 1 46 94 27 01

Service Commande de stock :

Phone +33 (0) 810 000 029 • Fax +32 34 50 80 26

Service Commande express :

Phone +33 (0) 810 000 029 • Fax +32 34 50 80 26

Federal-Mogul Aftermarket**Southern Africa (PTY) Ltd**

33 Western Boulevard • City West • Johannesburg • South Africa

Phone +27 11 630 3000 • Fax +27 11 630 3040

Federal-Mogul Aftermarket Turkey

Meclis-i Mebusan Cad. No: 53 Dereli İş Merkezi 34427 • Fındıklı / İstanbul • Türkiye

Phone +90 212 292 6313 • Fax +90 212 292 6260

Federal-Mogul Aftermarket Russia Ltd

Smolnaya street 24D, 13th floor • 125445 Moscow • Russia

Phone +7 495 221 50 60 • Fax +7 495 221 50 64



